

ML TDR 64-203

FOREWORD

This report provides a review of the technology for new types of devitrified ceramics. It was prepared by Mr. Barry R. Emrich, Materials Application Division, Air Force Materials Laboratory, Research and Technology Division, Air Force Systems Command, Wright-Patterson Air Force Base, Ohio. The work was performed under Project No. 7381, "Materials Application," Task No. 738105, "Ceramics and Graphite Information."

This report was prepared in partial fulfillment of the requirements for a Master of Science degree from The Ohio State University and is presented as a part of the Air Force Materials Laboratory information activities on ceramics and graphite.

The author gratefully acknowledges the support of D. L. Yuhas, Major, USAF, Deputy for Foreign Technology, Aeronautical Systems Division, Wright-Patterson Air Force Base, Ohio, in providing selected translations from the foreign literature. Appreciation is also extended to Dr. Ralston Russell, Jr., the author's adviser, and Dr. H. Blau of The Ohio State University for their support, encouragement and suggestions.

Contrails

ABSTRACT

A comprehensive review of the worldwide open literature was made to assist the research and development engineer in future work and inform the applications engineer of the present uses and capabilities of devitrified ceramics. The devitrified ceramics of primary concern are those materials which are predominantly crystalline bodies produced by induced and controlled nucleation and crystallization of preformed glass articles. This study presents information on compositional and processing factors; fundamental phenomena; properties; the effects of crystal size, heat treatment, and composition on properties; and applications. It also includes selected abstracts.

This documentary search concludes that devitrified ceramics are only in their infancy and that there is an urgent need for further development and understanding of fundamental characteristics in order to realize the full potential of these relatively new ceramic materials.

This technical documentary report has been reviewed and is approved.



D. A. SHINN
Chief, Materials Information Branch
Applications Division
AF Materials Laboratory

Contrails

TABLE OF CONTENTS

	<u>Page</u>
I. INTRODUCTION	1
II. HISTORICAL REVIEW	5
A. Crystallization Without Nucleus-Formers	5
B. Crystallization With Nonmetallic Materials as Nucleus-Formers	5
C. Crystallization With Metals as Nucleus-Formers	6
D. Crystallization With Titanium Dioxide as a Nucleus-Former	9
E. Metallurgical Slags as Catalysts for Crystallization	13
F. General Summary	13
III. NUCLEATION AND CRYSTAL GROWTH	15
A. Formation of Nuclei	19
B. Crystal Growth	21
IV. STATE OF THE ART	26
A. General Summary	26
1. Factors Affecting Properties	27
B. Fundamental Studies	28
1. Structure	28
2. Strength	30
a. Relating strength to crystal size	30
b. The effect of heat treatment on strength	35
c. The effect of composition on strength	42
d. Chemical resistance	45
C. Applied Programs	45
1. Magnesia-Alumina-Silica Compositions Nucleated by Titania	45
a. Radomes and windows	47
b. Electron Tubes	58
c. Substrate for Thin Films	63
2. Lithia-Alumina-Silica Compositions Nucleated by Titania	63
a. Friction and wear studies	63
b. Lightweight optical elements (sandwich construction)	75

Contents

	<u>Page</u>
3. Devitrified Ceramic Coatings	79
4. Adhesives	84
5. Cellular Devitrified Ceramics	87
6. Grinding	91
V. GENERAL SUMMARY	97
REFERENCES	104
APPENDIX I (SELECTED ARTICLE)	123
APPENDIX II (SELECTED ABSTRACTS)	128
APPENDIX III (HANDBOOK DATA ON STATE-OF-THE-ART MATERIALS)	134

Contrails

LIST OF FIGURES

<u>Figure</u>		<u>Page</u>
1	Uncontrollable Devitrification	16
2	Controllable Devitrification	16
3	A Schematic Representation of the Change of the Internal Structure of a Glass With Heat Treatment	31
4	Growth of the Glassy Microphase Versus Heat- Treating Time and Temperature	31
5	Modulus of Rupture as Function of Crystal Size and Surface Condition of a Fine-Grained Devitrified Ceramic	34
6	Schematic Graph of Postulated Relationship Between Strength, Crystal Size, and Surface Flaws in Ceramics	34
7	Effect of Grain Size on Strength of Polycrystalline Aluminum Oxide	35
8	Heat Treatment Schedule for Glass-Ceramic Cylinders	37
9	Strength of Glass-Ceramic Cylinders Versus Heat Treatment	38
10	Heat Treatment Schedule for Glass-Ceramic Specimens	41
11	Strength of Abraded and Unabraded Glass-Ceramic Versus Heat Treatment	41
12	Nucleation and Recrystallization of Eucryptite From Glass	44
13	Modulus of Rupture Comparison Data Between Pyroceram 9606 and BeO, Al ₂ O ₃ and Fused Silica	49
14	Maximum Temperature From Which Al ₂ O ₃ , Pyroceram and Slip-cast Fused Silica May Be Quenched as a Function of ah	50

Contents

<u>Figure</u>		<u>Page</u>
15	Effect of Temperature on Transverse Strength of Al_2O_3 , Pyroceram and Slip-cast Fused Silica	52
16	Frontside-Backside Temperature of Al_2O_3 , Pyroceram and Slip-cast Fused Silica as a Function of Time in Oxygen-Hydrogen Rocket Motor Exhaust	53
17	ΔT Between Frontside and Backside of Al_2O_3 , Pyroceram and Slip-cast Fused Silica as a Function of Average Wall Temperature in Oxygen-Hydrogen Rocket Motor Exhaust	54
18	Linear Expansion of Pyroceram 9606 and Various Materials	59
19	Permeability of Helium Through Corning No. 9606 Pyroceram and Various Other Glasses	61
20	Five-Ball Fatigue Tester	65
21	Friction and Wear of Pyroceram 9608 Sliding on Various Cobalt-Base Alloys at $1000^\circ F$	67
22	Friction and Wear of Pyroceram 9608 Sliding on Stellite Star J at Various Temperatures	68
23	Friction and Wear of Pyroceram 9608 Sliding on Various Nickel-Base Alloys at $1000^\circ F$	69
24	Friction and Wear of Pyroceram 9608 Sliding on Hastelloy R-235 at Various Temperatures	70
25	Wear of Pyroceram 9608 Rider Sliding on Hastelloy R-235 Disk at Various Temperatures and Sliding Velocities	71
26	Friction Coefficient of Pyroceram 9608 Rider Sliding on Hastelloy R-235 Disk at Various Temperatures and Sliding Velocities	72
27	Friction and Wear of Pyroceram 9608 Sliding on Hastelloy R-235 at Various Temperatures in Air . . .	73

Contents

<u>Figure</u>		<u>Page</u>
28	Friction and Wear of Pyroceram 9608 Sliding On Inconel X at Various Temperatures	74
29	Comparison of Coefficient of Expansion for Low Expansion Materials	78
30	Pyroceram No. 45 Cast Adhesive - Mean Coefficient of Thermal Expansion Versus Temperature (From RT, 80° F)	88
31	Shear Specimen Configuration	89
32	Shear Strength Versus Temperature - Ceramic Adhesive	90
33	Grinding Test Setup	93
34	Surface Grinding Pyroceram - Effect of Wheel Grade	94
35	Surface Grinding Pyroceram - Effect of Wheel Speed	95
36	Surface Grinding Pyroceram - Effect of Down Feed . . .	95
37	Surface Grinding Pyroceram - Effect of Cross Feed . .	96
38	Surface Grinding Pyroceram - Effect of Table Speed . .	96
39	Solubility of the Crystallized Glasses and Their Parent Glasses in Five Percent HCl Solution at 90° C	127
40	Compositions of Glasses Melted Shown in a Solidus Triangle of the $\text{Li}_2\text{O} \cdot \text{Al}_2\text{O}_3 \cdot \text{SiO}_2$	127
41	Thermal Expansion Curve of Crystallized Glasses	127
42	Dielectric Strength Under Oil, Pyroceram No. 9606 . .	135
43	Modulus of Rupture, Pyroceram No. 9606	136
44	Elastic Modulus, Pyroceram No. 9606	137
45	Shear Modulus, Pyroceram No. 9606	138

Contrails

<u>Figure</u>		<u>Page</u>
46	Poisson's Ratio, Pyroceram No. 9606	139
47	Expansivity, Pyroceram No. 9606	140
48	Heat Capacity of Pyroceram No. 9608	141
49	Thermal Conductivity of Pyroceram Nos. 9606 and 9608	142
50	Specific Heat of Pyroceram Nos. 9606 and 9608	143
51	Thermal Diffusivity of Pyroceram No. 9606	144
52	Normal Spectral Emittance of Pyroceram Nos. 9606 and 9608	145
53	Spectral Reflectance and Transmittance of Pyroceram Nos. 9606 and 9608	146
54	Normal Total Emittance of Pyroceram Nos. 9606 and 9608	147
55	Test Method, Pyroceram No. 9606 - ATC Report No. ARTC-4	148
56	Volume Resistivity of Pyroceram No. 9606	149
57	Dielectric Breakdown - One Minute Life for 2 mm Thickness at 60 CPS and DC for Pyroceram No. 9606	149

Contracts

LIST OF TABLES

<u>Table</u>		<u>Page</u>
I	Properties of Mineral Compounds Crystallizable in Devitrified Ceramics	11
II	Crystal Size, Modulus of Rupture and Young's Modulus as Functions of Heat Treatment After Nucleation for 46 Hours at 740° C	33
III	Corrosion Resistance of Minelbite With A Specific Heat Treatment	46
IV	General Data for Relative Comparison of Properties	48
V	Pyroceram Radomes Used in Current Missile Programs	55
VI	Permeability Factor K for Various Gases Through Corning No. 9606 Pyroceram	60
VII	Results of Replication Methods on Pyroceram	76
VIII	Relative Physical and Thermal Merit Ratios	77
IX	Glass Composition Range	80
X	Crystal Phases Formed During Heat Treatment	81
XI	Property Ranges for Glass and Crystallized Glass Coatings	81
XII	Average Dielectric Constant and Loss Tangent for Adhesive Pyroceram No. 45	87
XIII	Relations Between Chemical Composition and Properties of Devitrified Ceramics	126

I. INTRODUCTION

For many years the uncontrolled crystallization occurring during glass manufacturing has been a basic problem. Such crystallization is undesirable and is generally detrimental to transparency and other properties. Glassmakers have therefore focused attention on avoiding devitrification, and not until recently has the formation of a second phase been deliberately sought.

Semicrystalline ceramics such as some porcelains, china, and refractories have been made for years by mixing and shaping fine particles of compositions containing such crystalline compounds as corundum, mullite, and quartz or substances which, when heated sufficiently to cause interaction and sintering of the constituents produce these semicrystalline ceramics. These bodies are produced by a drying and firing process and are characterized by marked shrinkage and formation of microcracks. Such materials are usually heterogeneous and contain voids resulting from interstices between the particles.

Opal and alabaster glasses (used principally for light diffusing purposes) are made by controlled crystallization. However, these glasses normally have less than 10 percent crystalline material and relatively few compositions are adaptable to this purpose.

The photosensitive glasses, produced by controlled nucleation, have a very limited range of composition since the crystallizable compounds grow by shortwave radiation treatment. The discovery of these glasses as well as opal glasses provide the historical background used in the development of the highly crystallized devitrified ceramics of current interest and are therefore discussed in this report.

This investigation was primarily concerned with compiling literature information concerning recently developed devitrified ceramic materials obtained by induced and controlled crystallization of glass from preformed glass articles. These materials are frequently

Manuscript released by author 15 June 1964 for publication as an RTD Technical Documentary Report.

Contrails

referred to in the literature as glass-ceramics (USA), vitro-ceramics (Europe) and sitals (USSR). The author, however, prefers the less redundant term "devitrified ceramics" for this report.

The primary objectives of this study are to provide a unified reference source of the open literature and a review of the technology to assist the research and development engineer unfamiliar with this subject in future investigations, and to inform the applications engineer of the present uses and capabilities of devitrified ceramics. It is hoped that this report will be helpful to the user of materials by providing an awareness of these materials and their characteristics as compared with other competitive materials for specific applications. Background information used advantageously in the development of the original devitrified ceramics is reviewed; basic and applied research studies are either discussed or referenced. Factors affecting properties and those involved with development are thoroughly discussed. Specific properties and applications of the two most studied devitrified ceramics are thoroughly reviewed for state-of-the-art knowledge, and selected abstracts from the American Ceramic Society Symposium and other recent sources on nucleation and crystallization are included for additional information and convenience. The fundamental mechanisms of devitrification, that is, nucleation and crystallization, have been compiled and reviewed recently by others and are therefore not emphasized in this report.

These new devitrified ceramics are of special interest because, compared with the semicrystalline ceramics previously mentioned, they represent the most practical way for mass-producing products approaching the ideal polycrystalline ceramic structure. They are extremely fine-grained, free from voids (zero porosity), with crystals randomly oriented and uniformly distributed. These characteristics tend to yield maximum strength, chemical durability and reliability; it has been demonstrated that these devitrified ceramics usually

Contrails

possess greater mechanical strength than partially crystallized ceramics made from the same composition. They are relatively free from shrinkage problems; and the diversity of possible chemical composition is quite large (Ref. 1, 2). These new materials are more durable than commercial glasses and often have very low thermal expansion coefficients. The devitrified ceramic, although not machinable with conventional cutting tools is more capable of being machined than ordinary glass (Ref. 3, 4).

The problems of porosity, uniformity of product, dependence of the microstructure on the physical state of the batch and on early stages of processing, which exist in sintered ceramics, are eliminated by the melting and forming of glass. These devitrified ceramics are produced in the same manner as glass by blowing, rolling, pressing or even centrifugal casting which can be used to make almost any size or shape. This could be compared with the advanced techniques used in making ceramics, such as hot pressing, which produce nearly perfect polycrystalline ceramics. However, they are expensive and are limited greatly in rate of production and size of pieces that can be made.

Since devitrified ceramics are produced by a nucleation process, they provide a means for producing polycrystalline ceramic articles having grain size smaller than those obtainable by any other known method. Efficient nucleation can produce particles a few Angstroms in size, and Stookey (Ref. 1) states that essentially complete crystallization is possible with an average crystal size from 200 to 300 Angstroms.

Devitrified ceramics cannot, of course, be used for all of the ceramic compositions one might want to fabricate. The present available types have a softening temperature limitation of about 1350°C (2460°F) which may be increased to approximately 1500°C (2730°F) with further investigations. Although they are brittle like other ceramics and have new problems of their own, they have been

Contrails

proven useful as radome, a high temperature bearing material, as well as in other important applications, and they give promise of broadening the usefulness of ceramics.

II. HISTORICAL REVIEW

A brief history of those microcrystalline materials which are still essentially a glass is given to distinguish between them and the new devitrified ceramics, and to provide a clearer understanding of the work leading up to the development of devitrified ceramics. To arrange a suitable breakdown for this discussion, the subject matter is divided into types of nucleus formers.

A. Crystallization Without Nucleus-Formers

This category includes the almost completely crystalline body made by the French chemist M. Reaumur (Ref. 5), who in about 1727 knowingly transformed glass into a crystalline state. This "Reaumur Porcelain" was produced by packing glass bottles in a mixture of sand and gypsum and heating them in a kiln for several days. Reaumur stated that the crystals were like needles which extended inwardly from the surface and met in the center of the glass wall (Ref. 6). This glass porcelain was soon forgotten, probably because it was very weak and brittle.

Albrecht (Ref. 7) shows how the proper annealing of glass affects the crystallization and how the formation of many microscopic crystals can be achieved. These alumina-rich silicate glasses through crystallization at proper temperatures produced hard materials with agate-like structures.

The possibility of influencing the crystallization to obtain fineness and homogeneity was the next step in developing these materials.

B. Crystallization With Nonmetallic Materials as Nucleus-Formers

K. T. Bondarev (Ref. 8) and W. Hinz (Ref. 9) discuss glass materials having nonmetallic materials as nucleus-formers. Non-metallic materials such as fluorides, phosphates or stannous dioxide because of their low solubility serve as nucleus-formers for obtaining fine crystalline materials like the opal glasses. The primary

systems in which fluoride (with proper heat treatment) was used in making partially crystalline glasses were reported by Hinz (Ref. 9) as:

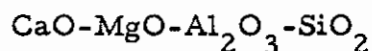
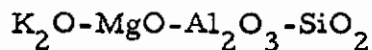
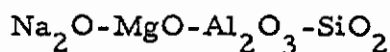
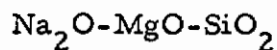

The case of fluoride additions is described in a 1958 report by St. N. Lungu and D. Popescu-Has (Ref. 10). The main difficulty with fluorine glasses was that the original glass had a softening temperature of 550° to 650° C; and the crystallization took place in a temperature interval of 750° to 900° C. Carefully controlled heating cycles (Ref. 8) are used to prevent deformation of the articles one uses. These materials demonstrated compressive mechanical strengths higher than for glass and porcelain.

C. Crystallization With Metals as Nucleus-Formers

The influence of platinum on the fineness of crystallization was reported by Rindone (Ref. 11). Platinum, in the form of platinum chloride, in amounts ranging from 0.001 to 0.01 percent was added to $\text{Li}_2\text{O} \cdot 4\text{SiO}_2$. Glass samples with and without the platinum addition were compared after heat-treating at 650° C for various lengths of time. Platinum-free glass of the very same composition crystallized slowly and in large individual crystals. The glass containing 0.001 percent platinum crystallized after 45 minutes of heat treating, and the glass with 0.01 percent platinum crystallized after 20 minutes. The glass having platinum as a nucleating agent contained large numbers of minute crystals, the largest being about 500A.

The metals, gold, silver, copper, were also introduced into the art of crystallization of glass, providing the breakthrough for

Contrails

photosensitive glass. According to Stookey (Ref. 12-14) research leading to the development of photosensitive glass was initiated by Dalton (Ref. 15, 16) in 1937, with his work on copper ruby glass. In 1941 work on glass compositions containing copper in which nucleation phenomenon (Ref. 17) could make photography feasible was accomplished. Further work showed that superior results were obtainable by the use of gold, together with sensitizing agents and color modifiers (Ref. 18). By 1947, two basic types of photosensitive glasses had been developed: (1) photosensitive metal-colored glasses, in which the image is a color transparency consisting of submicroscopic metal particles within the glass; and (2) photosensitive opal glasses, in which the image is translucent or opaque and consists of microscopic nonmetallic crystals. Armistead (Ref. 19), through his investigations on the coloration of glass by silver, was able to make photosensitive silver glasses.

In producing photosensitive glasses certain ratios of oxide components must be maintained. According to Stookey's patent (Ref. 2), the main components $\text{Li}_2\text{O} \cdot \text{Al}_2\text{O}_3 \cdot \text{SiO}_2$ should not be less than 90 percent, while the $\text{Al}_2\text{O}_3/\text{Li}_2\text{O}$ ratio should be less than 1.7/1. In order not to obtain too large an amount of glassy phase in the matrix the low melting components should not exceed 10 percent (Ref. 9). Alkali oxides (Li_2O excluded), added for the purpose of facilitating the melting should not exceed 4 percent, and the content of divalent oxides, such as ZnO , CdO , BaO and PbO , used to increase the chemical stability, must not exceed 5 percent. The photosensitive metals (Au , Ag , or Cu) are used in amounts ranging from 0.001 to 0.020 percent for best results. According to Mauer (Ref. 20), the minimum size of a gold particle capable of catalyzing the crystallization of lithium silicate in light sensitive glasses is 80A. Stookey (Ref. 21) states that 10^9 to 10^{15} crystals are formed for 1 cubic millimeter (1 mm^3) of glass. This simultaneous formation and growth of large

Contrails

numbers of crystals should provide full crystallization of the glass.

K. T. Bondarev (Ref. 8) in his explanation of induced crystallization in light-sensitive glasses states the following:

1. "Catalysts for crystallization should be well dissolved in the glass at boiling and processing temperatures, but not easily dissolved at lower temperatures;
2. "The catalyst should have high free energy of activation for the homogeneous formation of nuclei of crystals from the fused mass at low temperatures;
3. "The ions or atoms of the catalyst should diffuse in the glass at low temperatures more rapidly than the main components of the glass;
4. "For effective steeping the intersurface energy between the glass and the crystals of the catalyst should be small; and
5. "The crystal structure and parameters of the lattice of the catalyst crystals and of the nuclei of the crystalline phase should be as close to each other as possible."

Lillie (Ref. 22) explains in the development of photosensitive opal glasses (Fotolite, Fotoform, Fotoceram) that the ratio of the diameters of crystal and nucleus should be in the order of 20 to 1000.

The photosensitivity of Fotoceram glasses are increased by the presence of sensitizers such as CeO_2 , SnO_2 , Sb_2O_3 , or halogens. Some special photosensitive glass compositions, containing gold, silver or copper are listed in Stookey's patents (Ref. 23). Melting of such materials occurs at approximately 1350 to 1400° C for three hours, and the wavelengths for ultraviolet radiation are set at around 3000 to 3500 A for 5 to 10 minutes. The exposure periods vary greatly (one hour or longer possibly) depending upon the composition of the glass and the type and intensity of radiation. The melting atmosphere and process of preheating are also very important. The final heating occurs at a temperature of about 50° C lower than the softening point of the original glass. Heating at this temperature continues until a stable silicate structure is formed, thus allowing the temperature to be raised for obtaining complete crystallization without deformation;

the devitrification continues upon further heating until the desired degree is reached. In the case of photosensitive glasses, precipitation of the crystallizable compounds depends upon the presence of the metals in the colloidal state serving as nuclei; and the methods are applicable to only the very limited range of compositions capable of forming crystals which will form and grow on such nuclei. The photographic process includes the preliminary exposure of the glass to shortwave radiations, and is therefore limited to photosensitive glass compositions.

D. Crystallization With Titanium Dioxide as a Nucleus-Former

In principle, the final step in the development of the highly crystallized (glass-ceramics) devitrified ceramics was relatively simple: to find suitable nucleating agents to induce the same processes as in the photosensitive glasses, but without the necessity for ultraviolet or X-ray exposure. However, as simple as it may have appeared, it actually took long and painstaking research, not only because of the necessity for approximate registry between the nucleus and the crystallized phase, but because of the special solubility relations involved in the "ceramming" or heat treating process (Ref. 22). These particular materials were placed on the market around 1957. To aid those interested in developing these highly controlled devitrified ceramics the following ideas, obtained primarily from Stookey's (Ref. 2) patent, are provided.

A large number of glass compositions may be utilized in providing successful devitrified ceramics nucleated with TiO_2 . In summary the bodies consist essentially of four components, SiO_2 , Al_2O_3 , TiO_2 and one or more of the basic metal oxides, Li_2O , BeO , MgO , CaO , ZnO , SrO , CdO , BaO , PbO , MnO , FeO , CoO , and NiO . The four components total at least 90, preferably 95, weight percent of the composition of which the TiO_2 is 2 to 20 percent, but preferably 8 to 15 percent. Less than 2 percent TiO_2 is generally ineffective but more than 20 percent causes crystalline TiO_2 to affect the end

product properties and it may cause spontaneous crystallization when the glass is cooled from the molten state.

The final crystalline product may contain a low proportion of glassy matrix and possess substantially the properties of the crystalline compounds formed. Like the photosensitive glass composition, the total amount of metal oxides should not exceed 10 weight percent.

Glasses containing BeO, yield products containing beryl ($3\text{BeO} \cdot \text{Al}_2\text{O}_3 \cdot 6\text{SiO}_2$), which have low thermal expansion. These glasses are somewhat hazardous to make because of the extremely toxic character of BeO. Specific compositions with substantial amounts of MgO contain α -cordierite ($2\text{MgO} \cdot 2\text{Al}_2\text{O}_3 \cdot 5\text{SiO}_2$) (Ref. 24, 25); those with substantial amounts of CaO contain anorthite ($\text{CaO} \cdot \text{Al}_2\text{O}_3 \cdot 2\text{SiO}_2$); compositions with ZnO as a major metal oxide contain primarily zinc spinel or gahnite ($\text{ZnO} \cdot \text{Al}_2\text{O}_3$) and in some compositions willemite ($2\text{ZnO} \cdot \text{SiO}_2$). Specific examples of all types of compositions including the above minerals are provided in Stookey's patent (Ref. 2). Table I provides properties of some crystalline phases considered important in developing these materials. These compositions and other possibilities containing ternary oxide systems can be predicted from the phase diagrams compiled by Levin, McMurdie and Hall (Ref. 26).

A devitrified ceramic containing mixtures of two or more of the basic metal oxides usually possess intermediate properties compared to the two separate devitrified ceramics made from the individual metal oxides. The range of compositions capable of being melted and cooled to form glasses can be increased by the addition of fluxes such as Na_2O , K_2O and B_2O_3 . Germanium oxide, boric oxide and phosphoric oxide may also be employed as net-work formers. The deformation temperature can be increased by reducing the amount of metal oxides. Other nucleating agents which have been investigated are SnO_2 (Ref. 22) and ZrO_2 (Ref. 28, see also Appendix I).

The TiO_2 -nucleated devitrified ceramics are melted at about

TABLE I Properties of Mineral Compounds Crystallizable in Devitrified Ceramics

Mineral Hardness MOHS Ref. 150, 152	Mineral Sp. Gr. Ref. 150, 152	Nucleated Crystal	Crystal Composition	Crystal Structure Ref. 148, 149	Thermal Expansion 10 ⁶ °F* Ref. 151
6.5 to 7	3.17	B Spodumene	Li ₂ O · Al ₂ O ₃ · 4SiO ₂	Monoclinic	0.46 (500-2000)
-----	-----	B Eucryptite	Li ₂ O · Al ₂ O ₃ · 2SiO ₂	Hexagonal	-4.1 (500-2000)
7.5 to 8.0	2.6 to 2.8	Beryl	3BeO · Al ₂ O ₃ · 6SiO ₂	Hexagonal	0.5 (500-900)
7 to 7.5	2.6 to 2.75	Cordierite	2MgO · Al ₂ O ₃ · 5SiO ₂	Orthorhombic	1.0 (500-1500) Dense Cordierite
5 to 6	3.9 to 4.3	Willemite	2ZnO · SiO ₂	Trigonal	-----
6	2.7 to 2.8	Anorthite	CaO · Al ₂ O ₃ · 2SiO ₂	Triclinic	-----
7.5 to 8	3.5 to 4.5	Gahnite Zinc Spinel	ZnO · Al ₂ O ₃	Cubic	4.65 Reagent grade materials
6 to 6.5	4.2 to 4.3	Rutile	TiO ₂	Tetragonal	4.8 (500-2000)
7.5 to 8	3.5 to 4.5	Spinel	MgO · Al ₂ O ₃	Cubic	4.8 (500-2000)
6	2.6	Albite	NaAlSi ₃ O ₈	Triclinic	-----

*Calculated from graphs provided in WADC TR 58-476 Vol. III. In all cases these figures do not refer to the pure crystalline phase.

Contrails

1600° C (2910° F); nucleation temperature is about 800° C (1470° F) and crystal growth temperature is approximately 1200° C (2190° F) (Ref. 29). In general, to accomplish nucleation and crystallization the article should be cooled 100° to 300° C below the maximum nucleation temperature. The maximum nucleation temperature is that temperature to which the glass must be cooled so that visible crystals other than TiO₂ may be formed at a substantial rate when the glass is further reheated. The optimum temperature for nucleation is about 50° C above the annealing point of the glass, and the optimum time of holding the glass article at this temperature before reheating it to cause crystal growth is about 0.5 to 2 hours.

The glass crystallizes more rapidly during the reheating step, as the temperature is increased toward the liquidus of a predominant crystalline phase. When the amount of glass matrix is relatively large, the article may deform if the temperature is increased too rapidly. If the temperature is increased by not more than 5° C per minute after crystallization has set in, then deformation is avoided. The crystal growth temperature must remain below the liquidus of the predominant crystalline phase or dissolution of the phase will result. It has been observed by Stookey (Ref. 2) that if the crystallized compound has an inversion point, the normal breakage of the article through the inversion point is not usually encountered. This is explained by the extreme fineness of the crystals.

The optimum heating rate and/or holding temperature for crystal growth varies with composition. Currently, it may be estimated by the deformation of a test bar. The deformation temperature of the final crystalline product for devitrified ceramics may reach a higher degree than the present maximum of 1350° C.

The crystalline compounds can be identified by means of a conventional X-ray powder spectrometer or diffractometer, equipped with a Geiger counter and a trace-drawing device. The monochromatized X-ray beam is directed against a powdered or solid specimen at an

angle and the reflections from the various faces of the crystals are converted to amplified electrical impulses by the Geiger counter and are reproduced as a series of peaks on the trace. Each crystalline compound produces peaks which are characteristic of itself.

Bezborodov (Ref. 30) and Bonetti (Ref. 31) discuss methods used in determining crystalline structures found in glasses.

E. Metallurgical Slags as Catalysts for Crystallization

The Soviet technology for devitrified ceramics of high crystal content is termed sitallurgy. The term "sital" is known in the USSR, like the term "Pyroceram" is known in the USA. Professor I. I. Kitaygorodskiy (Ref. 32) and K. T. Bondarev (Ref. 8, 32) are credited with the development of these sitals. The open literature concerning Soviet technology (Ref. 3, 8, 32 - 44) does not provide many specifics in relation to these materials, but incorporation of up to 35 percent ordinary sand into blast-furnace slags was stated to provide materials suitable for production of sitals; addition of crystallization accelerators and oxides controlling the reduction processes improve the final product. The use of dump slags is also possible but requires additional operations and is, therefore, less advantageous. It was stated that these materials begin to soften between 1400° to 1500° C (Ref. 33, 37).

F. General Summary

At the present time production of microcrystalline materials from a glass base are being obtained in four basic ways. Based on catalyzing of the crystallization, the four major categories are: (1) fluorine; (2) light-sensitive materials (gold, silver, copper); (3) titanium dioxide; and (4) iron and manganese sulfide (metallurgical slags). Since this report is concerned primarily with those devitrified ceramics which are made from glass by controlled nucleation, and are principally crystalline in final analysis, the remainder of the discussion is restricted to the titanium dioxide catalyst materials and those produced

Contrails

from metallurgical slags. It is interesting to note that crystallization behavior is greatly dependent upon composition as demonstrated later in this report. An area suggested for future investigation is that of providing compositions which will not deform under increased heating rates ($>5^{\circ}$ C per minute) thus reducing production time and cost.

III. NUCLEATION AND CRYSTAL GROWTH

The fundamental phenomenon involved in producing these materials is devitrification generally considered as consisting of two processes - the formation of nuclei in the glass and growth of crystals from these nuclei. Controlling the devitrification or crystallization process from the glassy state is a necessary prerequisite to solve the practical problems arising during the production of devitrified ceramics. This particular subject area is extremely complex, controversial in many basic aspects, and has been reviewed in detail by others. Hence, the intention of this discussion is only to make one aware of important basic and practical factors and fundamental studies dealing with the nucleation and crystallization of glasses. The classical studies by Tamman (Ref. 45) and his associates, as well as later important studies and reviews by Kingery (Ref. 46), Friedberg (Ref. 47, 48), Van Hook (Ref. 49), Blau (Ref. 50, 51), Thakur (Ref. 216), Parmelee (Ref. 52), Stookey (Ref. 53, 54), Kleber (Ref. 55), Berezhnoy (Ref. 56), Robredo (Ref. 57), King (Ref. 58), and the Symposium on Nucleation and Crystallization in Glasses and Melts (Ref. 59) are of interest in these areas.

Tamman's (Ref. 45) classical studies on crystallization during cooling from the melt elucidated the basic principles applied to the making of opacified glazes, porcelain enamels, and later devitrified ceramics as explained by Parmelee (Ref. 52) and Shannon et al. (Ref. 47). Tamman pointed out that the formation of visible crystals depends upon three conditions: (1) the number of nuclei formed; (2) the rate of growth of the crystals; and (3) the viscosity of the melt. Blau's (Ref. 50) relationships of these conditions are shown in Figures 1 and 2.

Mellor (Ref. 60) and Norton (Ref. 61) applied these principles to glazes, while Zsigmondy (Ref. 62), Silverman (Ref. 63), and Wright (Ref. 64) used them for forming crystallites in glasses. However,

Contrails

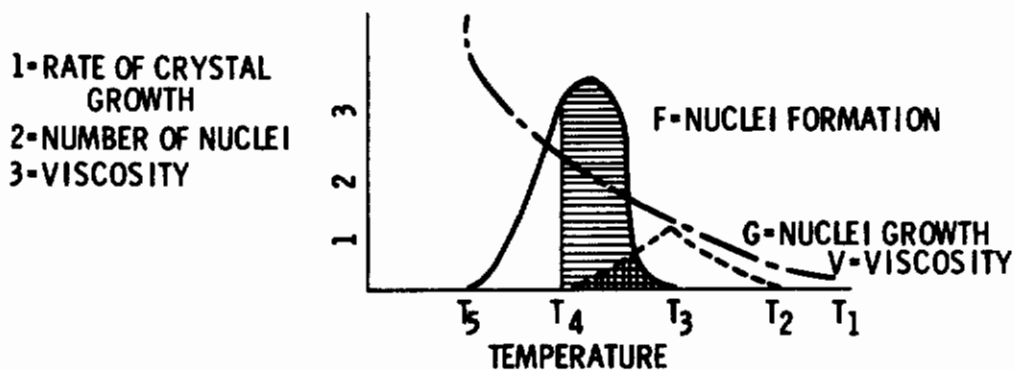

FIGURE 1 UNCONTROLLABLE DEVITRIFICATION (REF. 50)

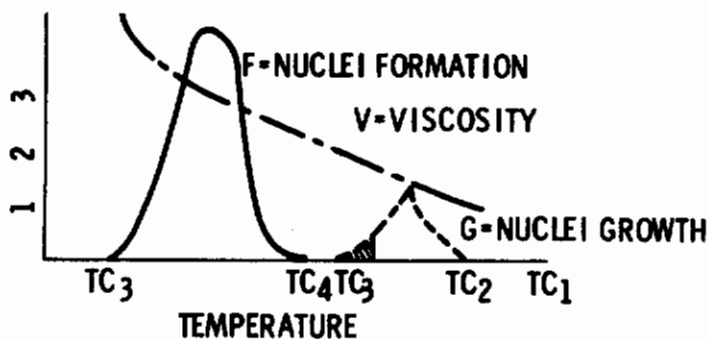

FIGURE 2 CONTROLLABLE DEVITRIFICATION (REF. 50)

the first application of the principles for controlled nucleation in glass is credited to Blau (Ref. 50). Blau discovered how to control the number and size of crystallites in the production of opal glasses possessing special diffusing properties.

Blau's invention is described with reference to Figures 1 and 2. Figure 1 represents a glass which devitrifies or opacifies spontaneously upon cooling. The glass is removed from the furnace at a relatively high temperature, such as T_1 . Nuclei grow within the temperature range T_2 to T_4 , and crystalline nuclei form only within

Contrails

the temperature range T_3 to T_5 . The article remains barren of nuclei necessary for the formation and growth of crystals until it reaches T_3 , even though nuclei may grow from T_2 to T_3 . During cooling from T_3 to T_4 , nuclei form, and because the crystal growth and nuclei formation ranges overlap, crystalline growth occurs simultaneously, thus causing the glass to opacify. Below T_4 no further crystallization occurs since the viscosity of the glass has become so great as to oppose any further changes. Due to the overlapping relationship of the two ranges, the conditions within which nuclei form and crystals grow are fixed so that there is no control of the properties of the resultant article. Because nuclei are continuously forming and growing simultaneously, the crystals are of random size, and it is not possible to control the results.

In order to have the ability to control the number and size of crystals and to have reproducible results, Blau (Ref. 50, 51) separated the two overlapping temperature ranges, as shown in Figure 2. The glass leaves the furnace at temperature TC_1 , and the article is formed. Crystal growth does not occur until cooling to TC_4 . The number of nuclei formed within the range TC_4 to TC_5 depends both upon the temperature and time the article is exposed. According to Figure 2, then, the nuclei would form in large numbers at a high rate at the peak of curve F.

After forming the specified number of nuclei, the article is reheated uniformly through the range TC_3 to TC_2 where crystal growth occurs, and again the extent of growth depends upon the temperature and time of exposure. The resultant crystals are of controlled size and number, and with proper scheduling can be reproduced. This principle is identical to that used for the new type devitrified ceramics.

Factors which influence the rate of nucleus formation and the velocity of crystalline growth as outlined by Blau (Ref. 51) for controlled formation of crystallites in opal glasses and applicable

Contrails

for devitrified ceramics are as follows:

1. Number of crystalline substituents (molecules, atoms, or ions) per space lattice element
2. Orientation of the crystalline substituents
3. Kinetic energy of the crystallizing substituents
4. Viscosity of the glass
5. Concentration of the crystallizing substituents
6. Magnitude of the energy changes involved (latent heats of crystallization or solution)
7. Thermal conductivity or rates of transfer of heat to or from the region of crystallization
8. Rate of diffusion to or from the region of crystallization
9. Interfacial concentrations adsorption
10. Influences of polar forces
11. Variations in the fugacities of crystallites with their radii of curvature, etc.

Blau states that the relative influences of these factors probably made it possible to obtain glasses yielding a single species of crystallites whose characteristic curves may be represented as in Figure 2. The exact effects of each of these factors on nucleation and crystal growth phenomenon has not been precisely determined.

The general principles and mechanisms of nucleation were compiled for a chemical engineering symposium at Northwestern University in 1951 (Ref. 65). A recent literature review by King (Ref. 58) in 1960 briefly summarizes from a theoretical point of view the principles and factors involved during the nucleation and crystal growth of normal type glass fibers. Since King's review summarizes the literature for the devitrification of normal type glasses, his study should be used only as a general basis for the formation of nuclei and crystal growth in devitrified ceramics. It should be realized that the theoretical viewpoint is only one of several means used in the literature for explaining these phenomena.

A. Formation of Nuclei

King states: "Nuclei may result from inhomogeneities initially present in the glass or from the spontaneous development of inhomogeneities during cooling. Inhomogeneities may result from (1) the incomplete fusion and diffusion of the raw materials of the glass batch, (2) the presence of minor constituents having a relatively low solubility in the glass, (3) a difference in surface composition due to volatilization, (4) the accidental contamination of the glass surface, and (5) the exposure of the glass to radiation," and in the case of devitrified ceramics we may add (6) controlled nucleation by induced nucleating agents.

"The theories of spontaneous nucleation have been reviewed by Brown (Ref. 66), and Stookey (Ref. 53), the original theory having been devised by Gibbs (Ref. 67), Thompson (Ref. 68), Volmer (Ref. 69), Becker and Doering (Ref. 70), Frankel (Ref. 71), and Turnbull Fisher (Ref. 72). Stookey summarizes as follows:

- '1. The growth of a new phase B at the cost of an initial phase A can proceed only if they are not in equilibrium with one another, so that during the change, phase A is in metastable equilibrium with respect to B.
- '2. Nuclei of phase B are very small particles of B. They differ from larger particles not only by being smaller but also by their abnormally large surface, and therefore surface energy and surface tension. For a drop that is not too small, its total surface free energy is $S\sigma$, or $4\pi r^2\sigma$, where σ is the surface tension, r is the drop radius, and S is the surface area.
- '3. If the surface energy of the nuclei of the B phase with respect to the metastable A phase is taken into account, the notion of thermodynamic equilibrium can be used to derive relations for critical size of nuclei.'

Contrails

"The work of formation W of a nucleus of phase B of critical size r_c is

$$W = \frac{4}{3} \pi r_c^2 \sigma \quad (1)$$

for the smallest nucleus that is stable and capable of spontaneous growth

$$r_c = \frac{2\sigma}{p'' - p'} \quad (2)$$

where σ is surface tension and p'' and p' are vapor pressures within the drop (nucleus) and in the mother phase."

An equation of the Arrhenius form has been reported (Ref. 53) to have been successfully applied to the calculation of the rate of nucleation in condensed systems:

$$R = A e^{-\frac{(W + \Delta E_{vis})}{kT}}$$

- where
- R = rate of nucleation (droplets/sec./cm³)
 - A = constant (collision number referred to as the frequency factor)
 - W = work of critical nucleus formation and is proportional to $\frac{1}{F_1} - F_c$ where F_1 and F_c are the free energy¹ per molecule of liquid and crystal phase, respectively, at the temperature considered.
 - ΔE_{vis} = activation energy for viscous flow
 - k = Boltzmann constant
 - T = Absolute temperature

The equations which were previously discussed illustrate the simplest cases of homogeneous nucleation phenomena. These equations must be modified for different forms and varieties of nuclei, and the

pre-exponential factor plus other factors must be evaluated for the various types of nucleation and transformation which occur. Such factors as strain contributions, nonequilibrium conditions, disregistry, energy of dislocations, absorption and desorption phenomena, must be considered for true evaluations of actual nucleation rates. Since the basic theories of nucleation do not include all the necessary parameters for heterogeneous nucleation they have not been very useful in practice. In general a variation of the interfacial tension of less than 15 percent between theory and experiment is considered good agreement. It must therefore be realized that this factor, which is an important part of every equation, is questionable for most cases. Satisfactory agreement generally occurs in cases of nucleation from vapors, but only qualitative comparisons result for condensed systems (Ref. 49). Separating nucleation rates from crystal growth rates is another major difficulty, since the growth of crystals requires the formation of a primary seed crystal or nucleus.

In concluding this oversimplified discussion on nucleation it should be emphasized that much scientific knowledge must be discovered before we clearly understand this phenomena. Caution must be applied when using this theory regarding nucleation for controlled forming of devitrified ceramics to provide any agreement between theory and experiment. According to Tiller (Ref. 213) there have been only two well established cases of homogeneous nucleation appear in the literature; one for the solidification of water and the other for the solidification of mercury droplets coated with mercuric laurate. However, it is the opinion of some experts in devitrified ceramics that homogeneous nucleation does occur in some systems.

B. Crystal Growth

King's (Ref. 58) review of crystal growth for uncontrolled devitrification provides one with important parameters to consider and is therefore included here. King states that:

Contrails

"The mechanism of crystal growth in glass has been approached both empirically and theoretically and often a combination of the two has been used. It has been observed that the rate of crystal growth is zero at the liquidus temperature and then as the temperature is lowered, first increases and then decreases. If additional crystalline phases appear below the liquidus temperature they too exhibit first an increase and then a decrease in the rate of growth. Brown and Kistler (Ref. 73, 74) reviewed the subject and reported a number of equations to have been developed for the rate of crystal growth. The equations listed by them along with additional equations from the literature are as follows:

'Richards (Ref. 75) and Leont'eva (Ref. 76) and others published equations of the form $g = K (T_L - T)/\eta$ (4)

where g = rate of crystal growth

K = constant

T_L = liquidus temperature in degrees K

T = temperature in degrees K

η = viscosity in poises

'Leont'eva (Ref. 76) is also credited with the expression for a fixed temperature

$$g = \frac{K_1}{\eta} + K_2 \log \eta \quad (5)$$

'Swift (Ref. 77) suggested the following:

$$g = K (T_L - T) / \eta^y \quad (6)$$

y = some power between 1 and 2

'Preston (Ref. 78) published the formula

$$g = \frac{K}{\eta^2} (T_L - T) \quad (7)$$

Contrails

Equations (4), (6) and (7) apply only at temperatures below that at which the rate of growth is a maximum.

'Frankel (Ref. 71), and Takayanagi and Yamashita (Ref. 79) published the following:

$$g = A_0 \exp \left\{ - \left[U + \frac{B_0}{(T_L - T)} \right] / k T \right\} \quad (8)$$

where A_0 and B_0 are constants

U = activation energy for diffusion of crystal-forming material to the crystal phase

k = Boltzmann constant

'Cox and Kirby (Ref. 80) published the equation

$$g = A_0 \left[1 - (p + 1) e^{\frac{(E_1 - E_2)/k T}{-E_1/k T}} \right] e^{-E_1/k T} \quad (9)$$

E_1 = energy necessary to enable a glass phase ion to become mobile

E_2 = energy necessary to enable a crystal phase ion to become mobile

p = ratio of the surface densities of crystal and glass.

'Turnbull (Ref. 81) published the equation

$$g = A_0 (k T / h) e^{-\Delta F_a / k T} \left\{ 1 - e^{-\lambda_0 (T - T_L) / k T} \right\} \quad (10)$$

where h = Planck constant

ΔF_a = free-energy difference between activated complexes and atoms in the glass

λ_0 = heat of fusion

'Brown and Kistler (Ref. 66, 74) found the following empirical equation to provide satisfactory agreement with the available data on the rate of growth of crystals in glass

$$g = A T e^{-B/T} \left\{ 1 - e^{-a(T_L/T) \left[(T_L/T)^\beta - 1 \right]} \right\} \quad (11)$$

Contrails

A, B, α and β are constants.

'According to Brown and Kistler (Ref. 74) the process of crystal growth consists of

- a. The diffusion of crystal forming species to the glass-crystal interface.
- b. The disintegration of the glass structure at the glass-crystal interface into mobile fragments of crystal-forming material.
- c. The adjoining of mobile crystal-forming fragments with the crystal phase.
- d. The orientation required for crystal building. ' "

The above review, although originally written for a normal type glass fiber, provides one with basic important parameters to consider in all types of crystal growth in glass. Caution should be taken in considering any of the above formulas for use in determining precise results in developing devitrified ceramics.

A recent important aspect for devitrified ceramics exploited by Vogel (Ref. 82) is the possibility of controlled crystallization being due primarily to "epitaxy" (controlled generation or oriented growth of some material in a crystalline-bearing surface). Vogel by special electron-optical studies made on beryllium fluoride glasses stimulated to spontaneous crystallization showed that epitaxy may be regarded as a decisive basic process in most phenomena of controlled crystallization. The field of epitaxial phenomena has also been touched upon by Neuhaus (Ref. 83), Bauer (Ref. 84) and Kleber (Ref. 85). Abbott and Kerrigan (Ref. 217) prepared an annotated bibliography on epitaxial growth.

To illustrate the mechanisms involved in the crystallization of special devitrified ceramic, the $\text{Li}_2\text{O} \cdot \text{MgO} \cdot \text{Al}_2\text{O}_3 \cdot \text{SiO}_2$ devitrified ceramic studied by Ownby (Ref. 6) is given. Ownby, by techniques of microscopy, showed that crystallization of devitrified ceramics is preceded by three definite mechanisms.

Contrails

- (1) Surface nucleation and consequent crystallization during the earliest stage of heat treatment;
- (2) Internally nucleated glass-in-glass droplets during preliminary heat treatments; and
- (3) Internally nucleated, well-developed crystals changing in crystal form during heat treatment.

Ownby states it is significant to note that apparently none of these mechanisms play a dominant role in the nucleation and crystallization processes, but they have definite effect on property behavior at each stage of development.

The very important recent contributions by Mauer (Ref. 86), Vogel and Gerth (Ref. 87), Anderson and Friedberg (Ref. 88), Roy (Ref. 89) Ohlborg et al. (Ref. 90), Westman and Murthy (Ref. 91), Rindone (Ref. 92) and Hillig (Ref. 93) on crystallization of devitrified ceramics have been compiled and placed into a unified source by the American Ceramic Society (Ref. 59). The abstracts of these significant investigations are placed in Appendix II of this report to assist the researcher in determining their general value for his work.

The general result of the American Ceramic Society symposium in Matson and Rindone's publication as stated by Hillig (Ref. 94) was that liquid unmixing was probably the significant factor leading to uniform crystallization. Hillig was also of the opinion that constituents that lead to nonideal solution behaviors, regardless of whether they result in unmixing or not, can become effective nucleation catalysts by lowering the interfacial free energy between the crystal and the melt.

IV. STATE OF THE ART

A. General Summary

In general the subject of devitrified ceramics produced by controlled and induced nucleation from a glass article and being principally crystalline in structure is relatively new and of increasing significance. There are two useful types of particular technical importance described in the open literature. One of them is a lithia-alumina-silica (trademarked Corning Pyroceram 9608) nucleated with titania which includes a relatively extensive field of compositions crystallizing to β -spodumene, β -eucryptite, or solid solutions containing one or both, for low-expansion devitrified ceramics. These can be formed by any of the conventional methods now employed in the glass industry: blowing, pressing and drawing. The second type is a magnesia-alumina-silica (trademarked Corning Pyroceram 9606) nucleated by titania, which includes glass compositions crystallizing to cordierite. These have been primarily used in constructing radomes for high speed guided missiles and in electrical insulation. This devitrified ceramic is produced from a more fluid condition than most glasses, permitting such forming methods as centrifugal and gravity casting to be used. General information concerning these two materials is found in many periodical references (Ref. 95-126).

Many other forms of these devitrified ceramics have been produced commercially for special uses. The following are presently available as families of materials: (1) "Cercor" is the name given to Corning's family of thin-walled cellular devitrified ceramics primarily used in heat exchangers; (2) "Nucerite" coatings produced by the Pfaudler Company consist of a devitrified ceramic bonded to a variety of base metals; and (3) some adhesive materials include "Astroceram" made by American Thermocatalytic Corporation, Emerson and Cumings "Eccoceram," and Corning's "Pyroceram" brands. Other specialty items include Fotoceram which is a photosensitive material

made by Corning and "Glaceram" a core drill bit material produced by Hoffman Brothers Drilling Company, Inc.

Extensive research on devitrified ceramics has been performed in the United States by Corning Glass Works, Owens-Illinois, Pittsburgh Plate Glass Company and many other US organizations such as Libbey-Owens-Ford, the University of Utah and Pennsylvania State University.

Foreign work according to the open literature has been principally performed in Japan (Glass-Ceramics), Germany (Vitreous Ceramics) and the Soviet Union (Sitalurgy). In general the literature indicates that the USA is the leader in the development of devitrified ceramics. The Japanese and Germans appear to be interested mainly in the scientific aspects or in developing quality and reliable products similar to the USA, as compared to the lower quality but useful structural products presently reported by the Soviet Union. The Soviets write reports principally concerning their slag sital product used for construction of buildings. This material is not a reproducible or quality type item, but a very useful building material made from abundant and cheap raw materials. Other sitals have been mentioned as showing promise for use in the manufacture of internal combustion engine parts, gas turbines, ball bearings, ball mills, chemical food machinery, electronics and pumps. The Soviets appear to be very interested in expanding their research activities in this field and at one time hoped to have items in mass production by 1962. The information available at this time does not indicate that any mass production is an actuality today. However, it does indicate that they not only possess the knowledge to perform such production but serious plans of expansion in the field of sitalurgy.

1. Factors Affecting Properties

The properties of fully crystallized devitrified ceramics are primarily controlled by the effects caused by change in composition, thermal history and surface treatment following forming of the glass

article. Composition and thermal treatment control many structure-related parameters such as the number, distribution, size, shape and growth rates of the crystals, and ultimately affect the glass/crystal ratio, which are basic characteristics involved in determining the final property values. The significance of each parameter as related to each property is not agreed upon by the various investigators and leaves a wide area open for future investigations.

The manufacturing process used in preparing these special devitrified ceramics also influences the properties. Given proper quantities of oxides and a batch formula, it is possible to make a glass, a devitrified ceramic or a sintered ceramic all having the same chemical composition but different microstructures and, consequently, different properties. Stookey (Ref. 1) compares the microstructure of these three types of ceramics and shows the significant differences. In general, studies of sintered ceramics with grain sizes over 20 microns have shown that the modulus of rupture is inversely proportional to the grain size (Ref. 53), and presumably independent of surface flaws. Glass, considered to be amorphous or of zero crystal size, has intrinsic interatomic bond strength above 10^6 psi, but surface flaws reduce the flexural strength to the order of 10^4 psi. The fully crystallized devitrified ceramics with respect to grain size are essentially between the glass and sintered ceramic. It should then be possible to determine the effective growth size leading to ceramics of maximum tensile strength. The strength of devitrified ceramics is generally higher than sintered ceramics of the same composition.

B. Fundamental Studies

1. Structure

In devitrified ceramics of the type being considered, glass is the intermediate material and the final material is principally crystalline. The number of precipitated particles ranges from approximately 10^9 to 10^{15} per cubic millimeter of glass. By having a large

Contrails

number of crystals growing simultaneously, complete crystallization is obtained with average crystal diameters from one micron down to 100A (Ref. 54).

The microstructure of nucleated devitrified ceramics was generalized by Stookey in his work on the $\text{MgO-Al}_2\text{O}_3\text{-SiO}_2$, TiO_2 -nucleated system (Ref. 1). Micrographs of the progressive nucleation and crystallization in this system are illustrated by Burke (Ref. 54). The following are Stookey's generalizations describing the structure.

(1) In the earliest stages of crystallization, and also in crystals grown at low temperatures where the glass viscosity is high, the crystals are spheroidal.

(2) Work by Maurer (Ref. 86) showed that crystal nucleation in some devitrified ceramics is preceded by an emulsion (two-liquid phase separation) consisting of droplets only a few Angstroms in size. These droplets form crystal nuclei, and undoubtedly the initial size and shape of the crystallite is determined in this way.

(3) Crystals of 5,000 to 10,000 Angstroms (0.50 to 1.0 micron) exhibit angular surfaces with rounded corners, and larger crystals are sharply angular. Some cases of spherulitic growth have been observed in poorly nucleated glass, in which isolated crystals grow to as large as 1 millimeter. The fine-structure of these spherulites are quite complex and resembles some of those observed in organic high polymers.

(4) Orientation of crystals in devitrified ceramics is completely random, because they precipitate from homogeneous solutions under conditions free from any directional stress. Some exceptions to random orientation are observed in the surface layers of certain devitrified ceramics in which the internal nucleating agent is less efficient than the surface. In such cases, a layer of surface-nucleated crystals is oriented perpendicular to the surface.

Ownby (Ref. 6) provides a review of glass structure and photographs of microstructure of a $\text{Li}_2\text{O} \cdot \text{MgO} \cdot \text{Al}_2\text{O}_3 \cdot \text{SiO}_2$

devitrified ceramic. The glassy microphase structure theory of Watanabe and Moriya (Ref. 127) appear to agree with the studies of a number of glass compositions related to devitrified ceramics (Ref. 128). Figures 3 and 4 schematically represent this relationship. More recent work in this area has been performed by Roy (Ref. 89).

Vogel and Gerth's (Ref. 87) work on cooling of a glass melt support the concept of "glassy-microphases" or sometimes referred to as "glass-in-glass separation." Grieg (Ref. 131) also shows this type of structural change during heat treatment. Vogel and Gerth concluded that on cooling a glass melt, clusters of homogeneous ions will aggregate in selected areas. These clusters form in a state which is intermediate between ideal disorder and ideal order. The intermediate state is explained by the melt cooling too rapidly to satisfy either ideal. These clusters come together to form droplets which separate from the matrix glass and form crystalline-like interfaces. The formation of these droplets can and must be controlled and is, according to these investigators, the basic consideration in the production of devitrified ceramics.

Ohlberg, et al. (Ref. 90, 132) studied the systems $\text{TiO}_2 \cdot \text{MgO} \cdot \text{Al}_2\text{O}_3 \cdot \text{SiO}_2$ and $\text{TiO}_2 \cdot \text{Li}_2\text{O} \cdot \text{CaO} \cdot \text{SiO}_2$ and presented evidence that the glasses were crystallized by virtue of a glass-in-glass droplet separation causing internal nucleation.

2. Strength

The strength of various devitrified ceramics vary with slight changes in composition. Anisotropy, which can be important in decreasing the strength of polycrystalline ceramics, does not create this weakening effect in the nucleated devitrified ceramics.

a. Relating strength to crystal size

Stokey (Ref. 1) reports the relationship of strength to crystal size for a fully devitrified ceramic having the following composition in weight percent: $15\text{MgO} \cdot 9\text{TiO}_2 \cdot 20\text{Al}_2\text{O}_3 \cdot 56\text{SiO}_2$. The test

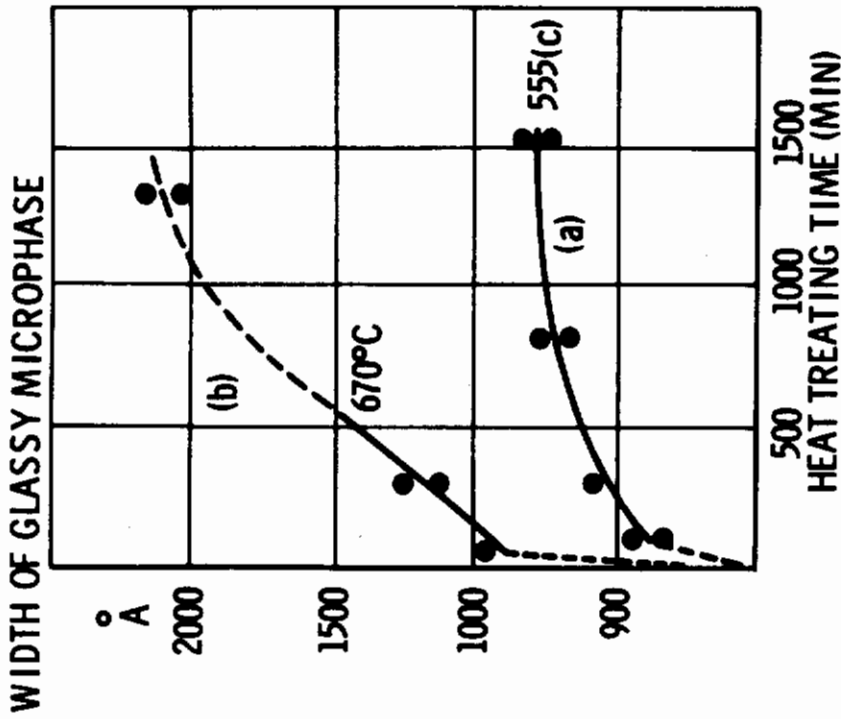

FIG. 4 GROWTH OF THE GLASSY MICROPHASE VERSUS HEAT-TREATING TIME AND TEMPERATURE (WATANABE REF. 130)

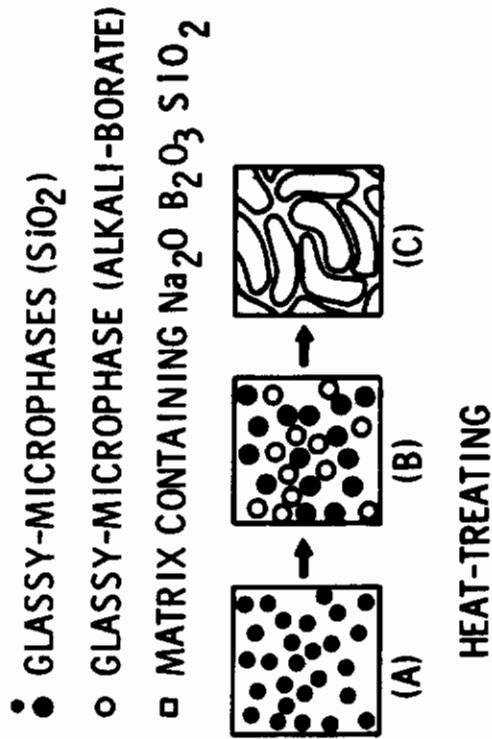

FIG. 3 A SCHEMATIC REPRESENTATION OF THE CHANGE OF THE INTERNAL STRUCTURE OF A GLASS WITH HEAT-TREATMENT. (REF. 129)

Conclusions

bars were heat treated 46 hours at 740° C, and then heated at 1000° C for various lengths of time before being cooled in air. The surface layers were ground off to a depth of one millimeter, and crystal size was determined by electron micrographs. Six crystal compositions as listed below were identified by X-ray diffraction.

Cordierite ($2\text{MgO} \cdot \text{Al}_2\text{O}_3 \cdot 5\text{SiO}_2$)

Spinel ($\text{MgO} \cdot \text{Al}_2\text{O}_3$)

Magnesium Metasilicate ($\text{MgO} \cdot \text{SiO}_2$)

Quartz (SiO_2)

Rutile (TiO_2)

Magnesium Aluminum Titanate ($\text{MgO} \cdot 2\text{TiO}_2 \cdot \text{Al}_2\text{O}_3$)

Young's modulus was determined by a dynamic method, and modulus of rupture (MOR) by a standard four-point loading method on both polished bars and bars abraded with 150-grit emery. All the tested specimens were essentially completely crystalline. Actual results as obtained by Stookey are shown in Table II and Figure 5. Figure 6 illustrates how strengths of devitrified ceramics are predicted varying the crystal size, using the Griffith flaw concept (Ref. 1).

This particular test showed some interesting generalizations, for example, the modulus of rupture was definitely dependent upon surface condition with grain sizes less than 0.5 micron. The modulus of rupture of abraded and of the polished fine-grained devitrified ceramics increases with crystal diameter up to at least 0.5 micron diameter.

If these ceramics are limited by the internal Griffith flaws, then by Figure 6 it can be shown that the inverse square root relationship with crystal size holds unless the crystals become so small that they do not cause internal flaws or the crystals become smaller than the surface flaws. The surface flaws become the limiting factor

TABLE II - Stookey (Ref. 1)

Crystal Size, Modulus of Rupture and Young's Modulus
As Functions of Heat Treatment
After Nucleation for 46 Hours at 740° C

Crystal Temp. °C	Growth Hours	Min. Crystal Size Microns	Max. Crystal Size Microns	MOR, psi x 10 ⁻³ Abraded	MOR, psi x 10 ⁻³ Polished	Young's Modulus psi x 10 ⁶
-----	-----	< 0.02	< 0.02	8 ± 2	19 ± 2	14.2
1000	1	0.03	*0.15	13 ± 1	21 ± 3	17.4
1000	3.5	0.03	*0.15	14 ± 1	22 ± 5	17.4
1000	6	0.035		14.5 ± 1	23 ± 5	18.2
1000	54	0.08	0.40	18 ± 1	28 ± 5	19.6
1000	220	0.10	0.50	20 ± 1	32.5 ± 5	18.1

*Possible aggregates of smaller crystals

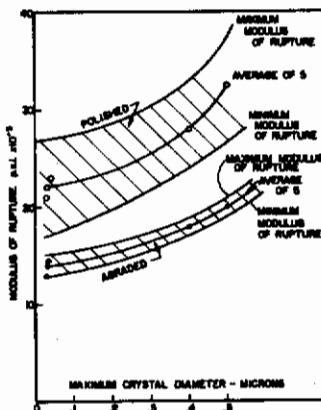

Figure 5 Modulus of Rupture as Function of Crystal Size and Surface Condition of a Fine-Grained Devitrified Ceramic (Ref. 1)

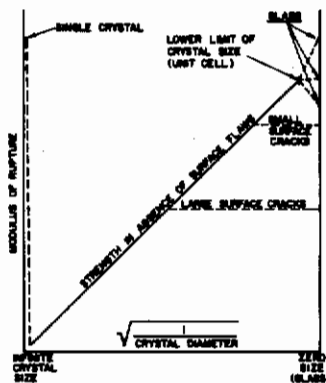

Figure 6 Schematic Graph of Postulated Relationship Between Strength, Crystal Size and Surface Flaws in Ceramics (Ref. 1)

when they are larger than the crystal diameter; this also holds true for glass. To illustrate the normal behavior for ceramics it is interesting to note that strengths of polycrystalline sintered aluminum oxide decrease with increases in grain size from 1 to 100 microns as shown in Figure 7.

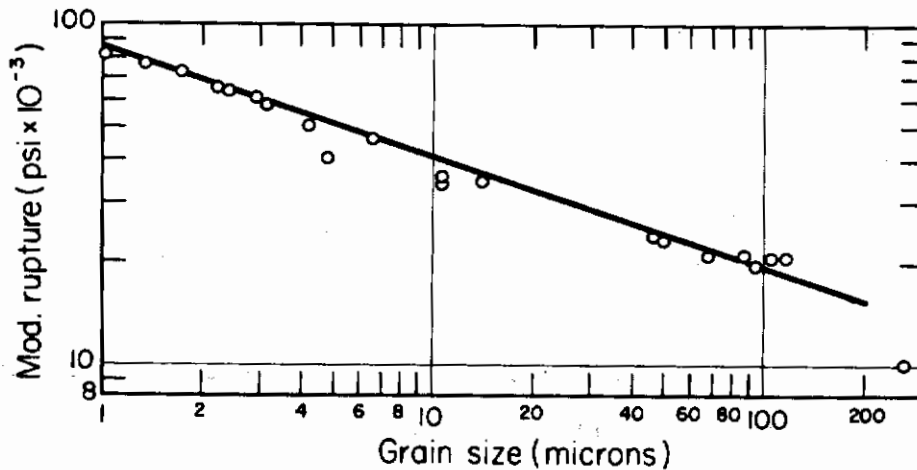

Figure 7 Effect of Grain Size on Strength of Polycrystalline Aluminum Oxide (Ref. 133)

Kingery and Coble (Ref. 134) also state that decreases in strength with increasing grain size has been observed for beryllium oxide (Ref. 135), thorium oxide (Ref. 136), uranium oxide (Ref. 137), magnesium oxide (Ref. 133) and chromium carbide (Ref. 136).

b. The Effect of Heat Treatment on Strength

Ownby (Ref. 6) studied the strength of a fully crystallized polished devitrified ceramic of the composition 15 percent MgO, 13 percent Li₂O, 10 percent Al₂O₃ and 53 percent SiO₂ after various heat treatments.

The experimental procedure included preparation of 400-gram batches melted at 1450° C in kyanite crucibles in an electric Globar furnace and stirred every 15 minutes until the glass appeared

to be thoroughly fined and homogeneous. The melted glass was then poured into carbon molds preheated to 450° C, and the filled molds were returned to the 450° C furnace. The furnace was then turned off and allowed to cool naturally.

After the rods were removed from the molds, they were cut into 5/8 inch cylinders using a diamond saw, and were then mounted on aluminum disc, polished and later etched in a solution of 40 percent H_2O , 40 percent HF and 20 percent H_2SO_4 (by volume) for 1 to 5 seconds. The polishing reduced the length of the cylinders to approximately 0.45 inch.

The cylindrical specimens were heat-treated to six different temperature levels as shown in Figure 8. The appearance varied greatly with heat treatment. The samples heat-treated to point 1.0 were slightly milky. The specimens with the 2.0 heat treatment had a greenish-white opaque appearance. As heat treatment went to higher temperatures the specimens changed from the greenish-white to an opaque solid-white crystalline appearance. In general, devitrified ceramics go from a transparent glass with no heat treatment to an opaque solid white. However, color additives may be used to create darkness or other shades if desired. When this is done uniformity of color is sometimes difficult to obtain.

The crystallization behavior at the higher temperatures was affected primarily by two things: (1) the degree of nucleation that took place prior to heating above 650° C and (2) the contact of the specimen with other materials.

The strengths were dependent upon the crystallization behavior pattern. Figure 9 shows that for those with less nucleation prior to 650° C the strength increased during soaking at 600° C, but subsequent increase in temperature, caused a great decrease in strength. This initial increase is not understood, but the decrease was thought to be due to a crack network wet up by the nucleation and growth of crystalline octahedra and glass droplets.

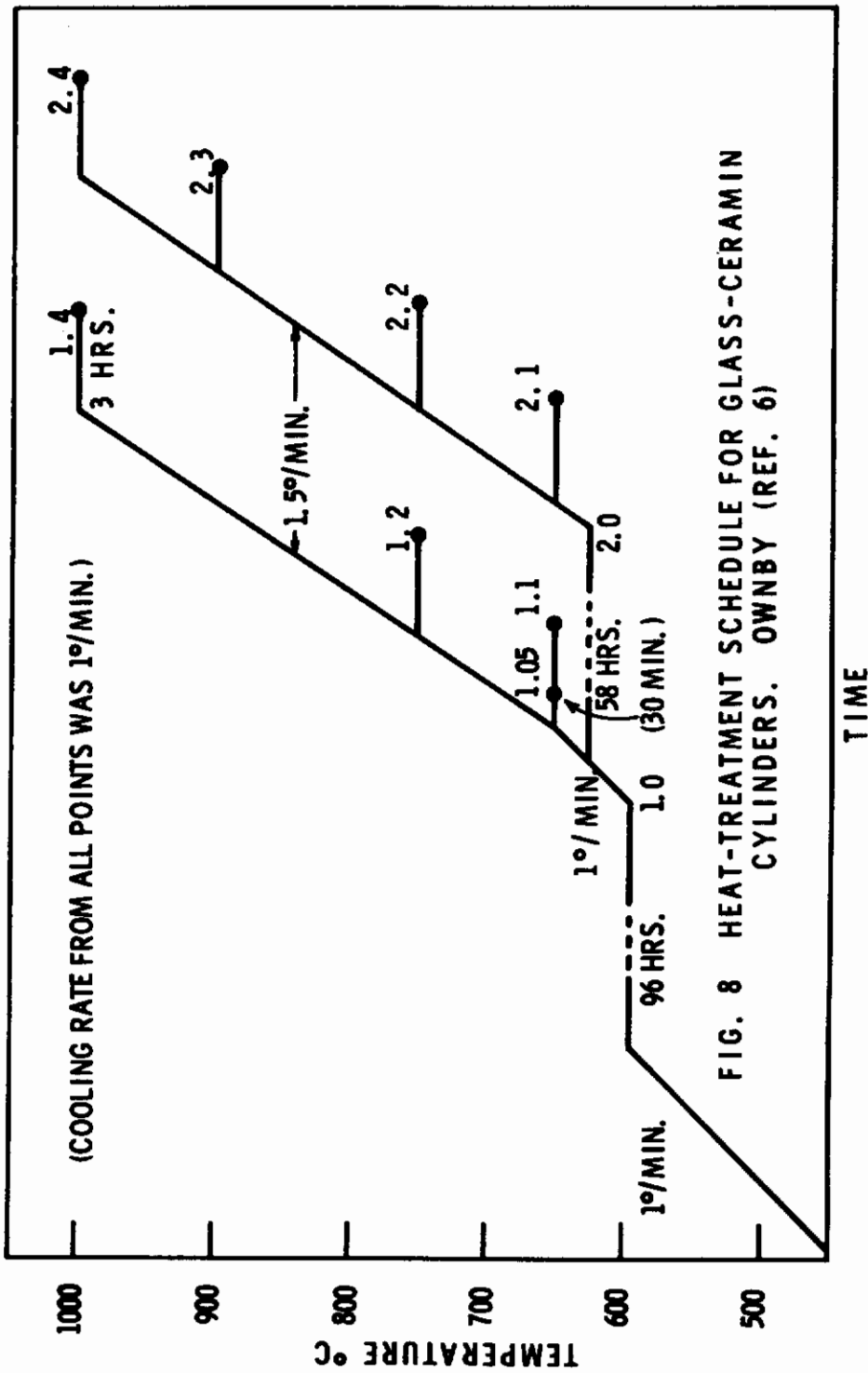

FIG. 8 HEAT-TREATMENT SCHEDULE FOR GLASS-CERAMIN CYLINDERS. OWNBY (REF. 6)

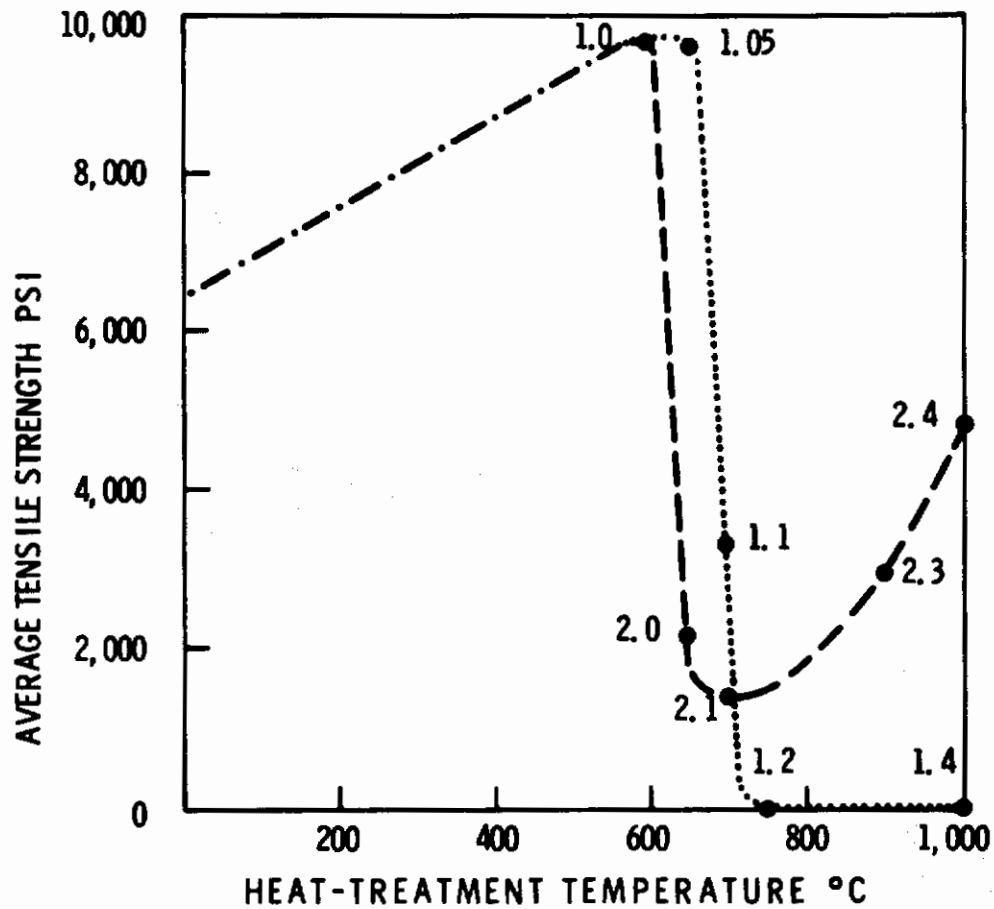

FIG. 9 STRENGTH OF GLASS-CERAMIC CYLINDERS VS. HEAT-TREATMENT OWNBY (REF. 6)

Contrails

The highly nucleated specimens tended to increase in strength at the higher heat-treatment temperatures. Ownby (Ref. 6) also showed that the maximum strength in the 1.0 heat-treatment series was more than double that of the maximum strength of an untreated specimen.

Dilatometer test results showed that for the 1.x heating cycles as shown in Figure 8 all samples softened at 650° C, whereas the 2.x heating cycle series softened at about 1075° C.

Sakka, et al. (Ref. 138) also studied the effect of heat-treatment on the strength of devitrified ceramic materials from the system $\text{Li}_2\text{O} \cdot \text{MgO} \cdot \text{Al}_2\text{O}_3 \cdot \text{SiO}_2$. Ownby (Ref. 6) reviewed this work and stated that the composition, 62 percent SiO_2 , 23 percent Al_2O_3 , 15 percent MgO and 4 percent Li_2O , produced the crystalline material with the highest modulus of rupture (22050 psi). For this composition B-eucryptite crystallized out first at about 850° C and B-spodumene at about 1000° C. It was determined that the strength increased with soaking temperature, which was illustrated earlier by Stookey (Ref. 1). There tends to be a maximum soaking period for obtaining highest strengths.

The strength of another nucleated devitrified ceramic in the system $\text{K}_2\text{O} \cdot \text{Li}_2\text{O} \cdot \text{Al}_2\text{O}_3 \cdot \text{SiO}_2$ was studied by Watanabe, et al. (Ref. 139). The equipment and technique used in this study of strength was that developed for testing the pristine strength of glass (Ref. 140 - 144).

The general experimental procedure consisted of the following:

- (1) A three-pound batch was prepared and mixed for 10 hours in a ball mill according to Stookey's Japanese Patent (Ref. 145). The chemical composition by weight was 80.8 percent SiO_2 , 4.0 percent Al_2O_3 , 12.4 percent Li_2O , 2.5 percent K_2O , 0.025 percent CeO_2 , 0.015 percent SnO_2 and 0.18 percent AgCl . The batch was

Contrails

melted in preheated fireclay crucibles in a Globar furnace at 1450° C for four hours.

(2) The specimens were formed by a drawing machine (Ref. 140) in which the glass was drawn into cane 0.050 to 0.075 inch in diameter and 1 to 3 inches long. Each cane was beaded at one end. These beads served to hold the specimens during heat treatment to avoid deformation.

(3) Heat treatment was accomplished by two heating schedules as shown in Figure 10. An example of interpretation of this chart is that N-6-5 means that the N-series heating schedule was followed up to 600° C, the temperature held constant for five hours, and the specimens quenched in air-to-room temperature.

(4) Following heat treatment some of the specimens were abraded with a grit blaster (Ref. 141), aged over H_2O for 20 hours, and tested in a universal tester (Ref. 141, 142) while immersed in distilled water. Figure 11 shows strength results of abraded and unabraded specimens.

The unabraded strengths which decreased with heat treatment to 800° C were similar to Ownby's results for specimens having insufficient nucleation prior to heat treatment above the nucleation point; however, since the compositions and testing procedures differed greatly this is not necessarily significant.

Watanabe's study reports that the strength of the completely crystallized devitrified ceramic in the abraded condition was approximately 27,000 psi, while the glass in the initially formed state was about 11,000 psi. In the glassy state the unabraded pristine strength (0.82 second load duration) was in excess of 80,000 psi, but for the fully heat-treated materials the strength decreased to 38,000 psi. The devitrified ceramic was therefore stronger than the glass after abrasion, but considerably weaker when both were unabraded. This work showed that the optimum mechanical properties were not solely

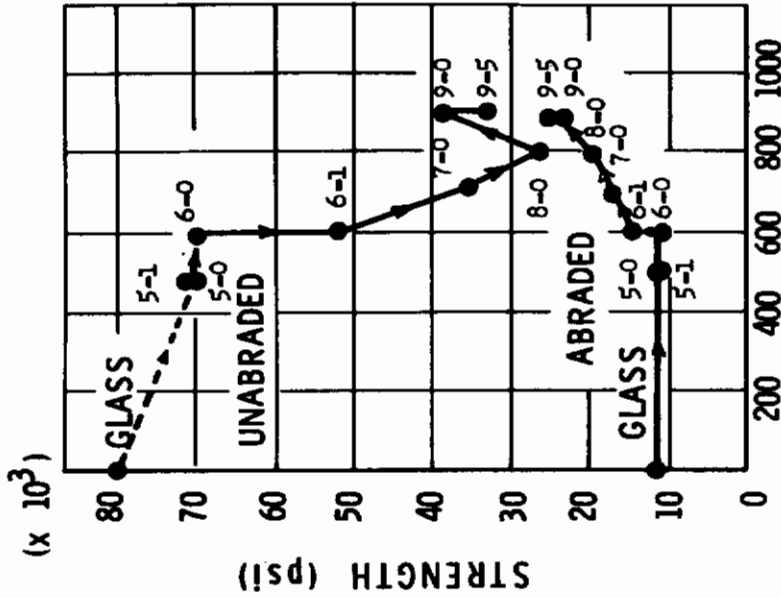

FIG. 11 STRENGTH OF ABRADED AND UN-ABRADED GLASS-CERAMIC VERSUS HEAT-TREATMENT. TESTED WET WITH LOAD DURATION OF 0.820 secs. (REF. 139)

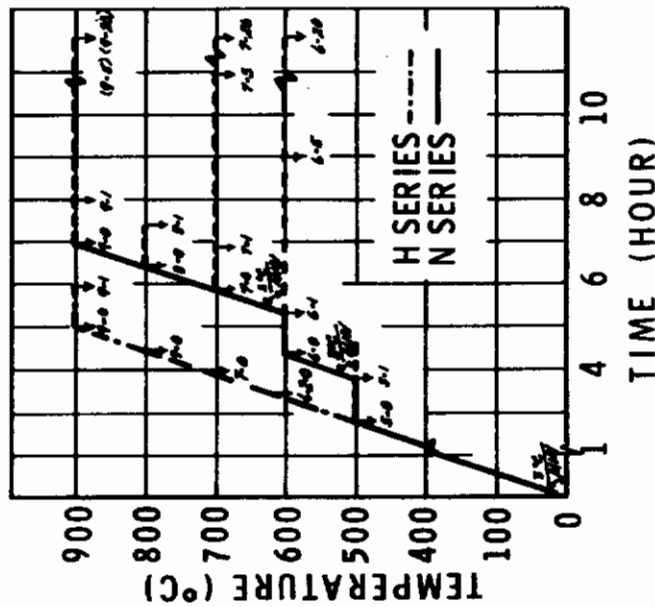

FIG. 10 HEAT-TREATMENT SCHEDULE FOR GLASS-CERAMIC SPECIMENS (REF. 139)

dependent on the detailed heating schedule above the nucleation temperature (600° C).

Watanabe (Ref. 139) concluded that his study did not provide a precise answer to what characteristics of the devitrified ceramic lead to hardness and abrasion resistance, but stated it seems plausible that micro-crystallinity is not necessarily the most important factor. He suggests that the mechanical properties may be partially determined by the glassy matrix which remains as crystallization proceeds, and that gradual changes in the chemical composition of this matrix may be important factors in determining the strength properties.

These strength studies illustrate that the behavior of devitrified ceramics depends upon the nucleation temperature and that caution must be realized by the designer in heating these materials beyond this limiting temperature.

c. The effect of composition on strength

Thousands of compositions have been investigated and a few devitrified ceramics have been developed for specific applications. Each investigator maintains specific property data for a particular composition on a proprietary or classified status and therefore very little information is available in the open literature. Properties vary greatly with composition and therefore compositions are extremely important in the development of devitrified ceramics having specific properties.

Tashiro, et al. (Ref 28, 146, 147) studied the effect of a platinum nucleating agent on bending strengths for the system $\text{Li}_2\text{O} \cdot \text{MgO} \cdot \text{Al}_2\text{O}_3 \cdot \text{SiO}_2$ (Ref. 146), and the effect of a zirconia nucleating agent on $\text{Li}_2\text{O} \cdot \text{Al}_2\text{O}_3 \cdot \text{SiO}_2$ (Ref. 28) glass system. Appendix I shows the complete summary of the zirconia-nucleated devitrified ceramics, giving viscosity, coefficient of expansion and bending strengths for the following range of compositions in weight percent: 60 - 75 SiO_2 , 20 - 35 Al_2O_3 , 1 - 5 P_2O_5 , Li_2O and ZrO_2

contents were held constant. The bending strengths ranged from 7400 to 11800 pounds per square inch.

Stookey's Patent (Ref. 2) illustrates 101 compositions with expansion coefficients, densities and heat treatment data for each. The properties of these devitrified ceramics tend to acquire those of the principal crystalline compound. Table I shows some properties of principal crystalline or mineral compounds known to exist in experimental and developed devitrified ceramics. Many polyphase systems such as $\text{BeO} \cdot \text{Al}_2\text{O}_3 \cdot \text{SiO}_2$, $\text{CaO} \cdot \text{Al}_2\text{O}_3 \cdot \text{SiO}_2$ and $\text{ZnO} \cdot \text{SiO}_2$ nucleated with TiO_2 require further investigation.

A particularly useful publication for selecting compositions to study is the book, Phase Diagrams for Ceramists (Ref. 26). Eucryptite ($\text{Li}_2\text{O} \cdot \text{Al}_2\text{O}_3 \cdot 2\text{SiO}_2$) and spodumene ($\text{Li}_2\text{O} \cdot \text{Al}_2\text{O}_3 \cdot 4\text{SiO}_2$) are two basic crystalline compounds found in the presently available materials. The Pennsylvania State University (Ref. 153 - 159) and others (Ref. 160, 161, 202 - 206) have investigated these two systems thoroughly. Roy and White (Ref. 153) stated the following concerning these minerals:

"Glasses with the compositions of eucryptite and spodumene can be crystallized under moderate pressures at 700°C . The importance of initial nucleation in controlling the final crystalline phase is strongly shown in this study (Ref. 162). The initial phase nucleated is controlled by the pressure during the up-heat period.

Depending on the up-heat pressure, either the low or high temperature eucryptites can be precipitated. If there is no pressure applied to the sample, only the high temperature B-eucryptite is obtained. The rate at which its crystallization takes place is a function of the load pressure applied after the up-heat is complete. If a pressure is applied during up-heat, the low temperature α -eucryptite nucleates in competition with the β form.

Contrails

The proportions of α and β as a function of up-heat pressure are shown in Figure 12. Spodumene behaves in an exactly analogous fashion. High temperature β -spodumene can be crystallized from the glass at 750°C at 20 k-bars if no pressure is applied during the initial heating. If the specimen is heated under pressure, the low temperature α -spodumene is obtained. We note in passing that this is the first reproducible synthesis of α -spodumene, a common mineral in nature, and the first synthesis of α -eucryptite without the use of a mineralizer. Thus it is found that pressures on the order of a few tens of kilobars cause a very marked increase in the rate of crystallization of these simple glasses."

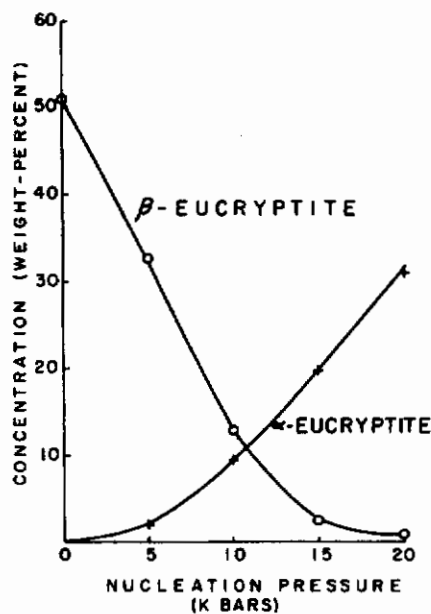

Figure 12 Nucleation and Recrystallization of Eucryptite From Glass. Correlation of Amount of α and β forms With Nucleation (Up-heat) Pressure. Crystallization Time, Temperature and Pressure Held Constant at 5 Min, 650°C and 20 k Bars. Roy and White (Ref. 35).

A recent review on lithium-aluminum silicates by Mehmel (Ref. 163) states that a comprehensive survey of the literature and patent specifications on materials have been prepared by the Hans-Heinrich-Hutte Company, Frankfurt, Germany (Ref. 164).

d. Chemical resistance

Locsei (Ref. 165) stated that the crystal size has considerable influence on chemical and abrasion resistance, thus proving the highly important role of nucleators in providing a high nucleation rate and a low crystal growth rate. The devitrified ceramic system $\text{Na}_2\text{O}-\text{CaO}-\text{MgO}-\text{Al}_2\text{O}_3-\text{SiO}_2$ nucleated by metal sulfides was studied. The acid resistance of this material gradually increased as the vitreous phase changed into the thermodynamically more stable crystalline phase. The chemical resistance was also stated to be a function of the amount of vitreous phase, and like mechanical strength it is also disadvantageous to corrosion resistance.

The chemical composition of one type of "Minelbite" material (56.1 SiO_2 , 7.9 Al_2O_3 , 21.9 CaO , 2.6 MgO , 1.5 BaO , 2.0 MnO , 5.0 Na_2O , 1.0 K_2O 1.5 Fe_2O_3 and 0.5 TiO_2) was preliminarily heat treated to 800°C for one hour and then heated through the following cycle: one hour at 800°C , two hours at 820°C , two hours at 840°C and finally two hours at 860°C . This composition produced the mineral minelbite as the primary crystalline phase. Table III shows the results of the chemical resistance test. These materials were boiled in the various acids, and showed outstanding chemical resistance.

C. Applied Programs

1. Magnesia - Alumina - Silica Compositions Nucleated by Titania

A devitrified ceramic under the trademark Pyroceram 9606 has been produced commercially by Corning Glass Works. This particular devitrified ceramic is the one on which a great deal of applied

TABLE III - Locsei (Ref. 165)
Corrosion Resistance of Minelbite
With a Specific Heat Treatment

Reagent	Concentration (%)	Average Quantity of Dissolved Material ($\text{g}/\text{m}^2/24 \text{ hr}$)	Dissolved Material in First 24 Hours (g/m^2)	Dissolved Material in Last 24 Hours (g/m^2)	Solution Rate (hr)	Solution Rate ($\text{g}/\text{m}^2/24 \text{ hr}$)
HCl	10	3.26	1.94	0.10	4	0.02
HCl	20	0.96	6.53	0.26	21.8	0.1
H ₂ SO ₄	10	3.55	7.47	1.58	16.8	0.5
H ₂ SO ₄	20	2.40	4.50	1.34	8.4	0.5
HNO ₃	10	6.62	12.34	4.58	19.7	2.2
HNO ₃	20	8.62	16.27	5.69	39.3	3.4
NaOH	10	7.99	13.97	3.22	36.7	0.2

study has been performed. It is a white, opaque material after crystallizing to α -Cordierite. This material has excellent thermal shock capabilities and was originally developed to provide uniform electrical properties at microwave frequencies (500 to 30,000 MC) throughout the elevated temperature range of radome application. Handbook properties of the 9606 material have been individually compiled (Ref. 166) and are compared with 9608 material in Appendix III. Some of the properties are compared with other competitive materials in Table IV and Figure 13. This material can sustain approximately twice the temperature gradient tolerated by high purity alumina bodies (Ref. 171).

a. Radomes and windows

Walton and Bowen's (Ref. 172) evaluation of three ceramic* materials including Pyroceram 9606 brand devitrified ceramic showed some interesting results for radome applications. From mechanical property data supplied by Melpar the maximum temperature, ΔT , was calculated and plotted as a function of ah as shown in Figure 14. This figure does not necessarily indicate actual temperature ranges over which each material can successfully withstand thermal shock, since the graphs were calculated from questionable data. This study showed that thermal shocking in the exhaust of an oxygen-hydrogen rocket motor at distances of 6 to 18 inches from the exit plane never produced a thermal shock failure in slip-cast fused silica, even when the surface was heated above 3000° F and quenched by a stream of water as soon as the rocket motor was stopped. Aluminum oxide failed after 140 seconds at 18 inches and

*Slip-cast fused silica samples were prepared from slip obtained from the Glasrock Corp., Atlanta, Georgia. Pyroceram 9606 samples were obtained from the Bureau of Naval Weapons, Dept of the Navy, Washington, D. C. Al_2O_3 samples were obtained from Raytheon Company, Missile Systems Division, Bedford, Massachusetts.

TABLE 4 GENERAL DATA FOR RELATIVE COMPARISON OF PROPERTIES

Properties	Pyroceram (Ref. 166)				Glass (Ref. 9, 166)				Ceramic (Ref. 9)			Metal (Ref. 167 - 170)		
	9606	9608	Fused Silica 7940	Vycor 96% Silica Glass 7900	Pyrex Boro-Silicate Glass 7740	Sintered Corundum Al ₂ O ₃	Steatite MgO-SiO ₂	Forsterite 2MgO-SiO ₂	Alumi-num 7075	Gray Iron Class 20	Stainless Steel 302	Titanium 99.9		
Density g/cm ³ (Room temperature 25° C)	2.61	2.50	2.20	2.18	2.23	3.61 - 3.67	2.65 - 2.92	2.8	2.80	6.95 - 7.35	7.83	4.50		
Waterabsorption, percent	0.00	0.00	0.00	0.00	0.00	0.00	0 - 0.02	0 - 0.02	-	-	-	-		
Porosity (permeability for gas)	gas tight	gas tight	gas tight	gas tight	gas tight	gas tight	-	gas tight	-	-	-	-		
Thermal properties	1350	1250	1585	1500	820	1700 - 1745	1349	1349	-	-	-	-		
Softening point ° C	0.185	0.190	0.176	0.178	0.186	0.181	-	-	0.23 (100° C)	0.131 (100° C)	0.118 (100° C)	0.13 (100° C)		
Specific heat (25° C) Cal/gm (° C)	0.230	0.235	0.223	0.224	0.233	0.241	-	-	0.29	0.110	0.052	-		
Mean specific heat (25 - 400° C)	0.0087	0.0047	0.0032	-	0.0038	0.046 - 0.058	0.0065 - 0.010	-	-	-	-	-		
Thermal conductivity CGS 25° C mean temperature	57	4 - 20	5.6	8	32	73 (20 to 500° C)	81.5 - 99 (20 to 500° C)	99 (20 to 500° C)	232	100 (25° C)	95 (-18 to 316° C)	82		
Linear thermal expansion coefficient 10 ⁻⁷ (25 - 300° C)	17.3	12.5	10.5	9.6	9.3	40	15	-	10.4	11.6	29	15.0		
Mechanical properties	0.245	0.25	0.176	0.18	0.20	0.32	-	-	0.33	0.17	-	-		
Modulus of elasticity psi 10 ³	-	-	-	-	-	25	13	10	40	20 - 60	80	34		
Poisson's ratio	37	16 - 23	10	10	10	48	20	19	-	-	-	-		
Tensile strength, psi 10 ³	13.5	6.4	4.55	4.59	4.48	13.1 - 13.3	6.85 - 7.96	6.75	14.3	2.67 - 8.0	10.1	8.0		
Modulus of rupture, psi 10 ³	-	-	-	-	-	-	-	-	30	160 - 200	135 - 185	76		
Strength/weight ratio Z ^{1/2}	-	-	-	-	-	-	-	-	-	180 - 300	147 - 201	100		
Hardness	619	588	644	630	550	1800	-	-	-	-	-	-		
1) Brinell 500 kg	-	-	-	-	-	-	-	-	-	-	-	-		
2) Knoop 50 g	-	-	-	-	-	-	-	-	-	-	-	-		
500 kg	-	-	-	-	-	-	-	-	-	-	-	-		
Electrical characteristics	5.58	6.78	3.85	3.8	4.5	8.81	5.9	6.3	-	-	-	-		
Dielectric constants	5.60	-	-	3.9	5.9	-	-	-	-	-	-	-		
1) Freq 10 ⁶ 25° C	8.80	-	-	-	-	9.03	-	-	-	-	-	-		
300° C	-	-	-	-	-	-	-	-	-	-	-	-		
500° C	-	-	-	-	-	-	-	-	-	-	-	-		

1/ Depending on heat treatment.

2/ For (a) Pyroceram ceramic and glass calculated with ultimate strength modulus/weight and (b) metals calculated with tensile strength which corresponds practically to the attached strength (Ref. 9).

FIG. 13 MODULUS OF RUPTURE
COMPARISON DATA BETWEEN PYROCERAM 9606 AND BeO, Al₂O₃ AND FUSED

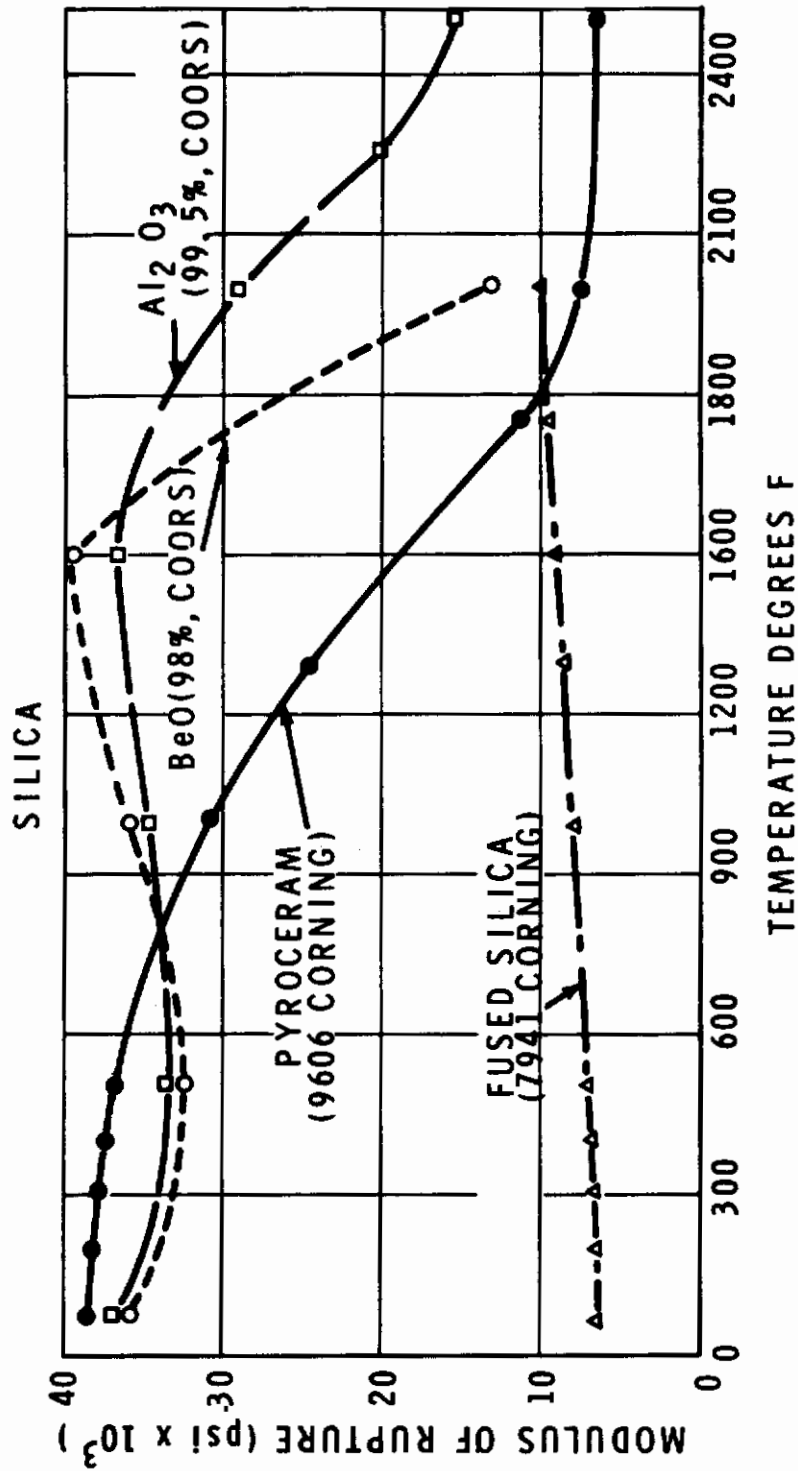

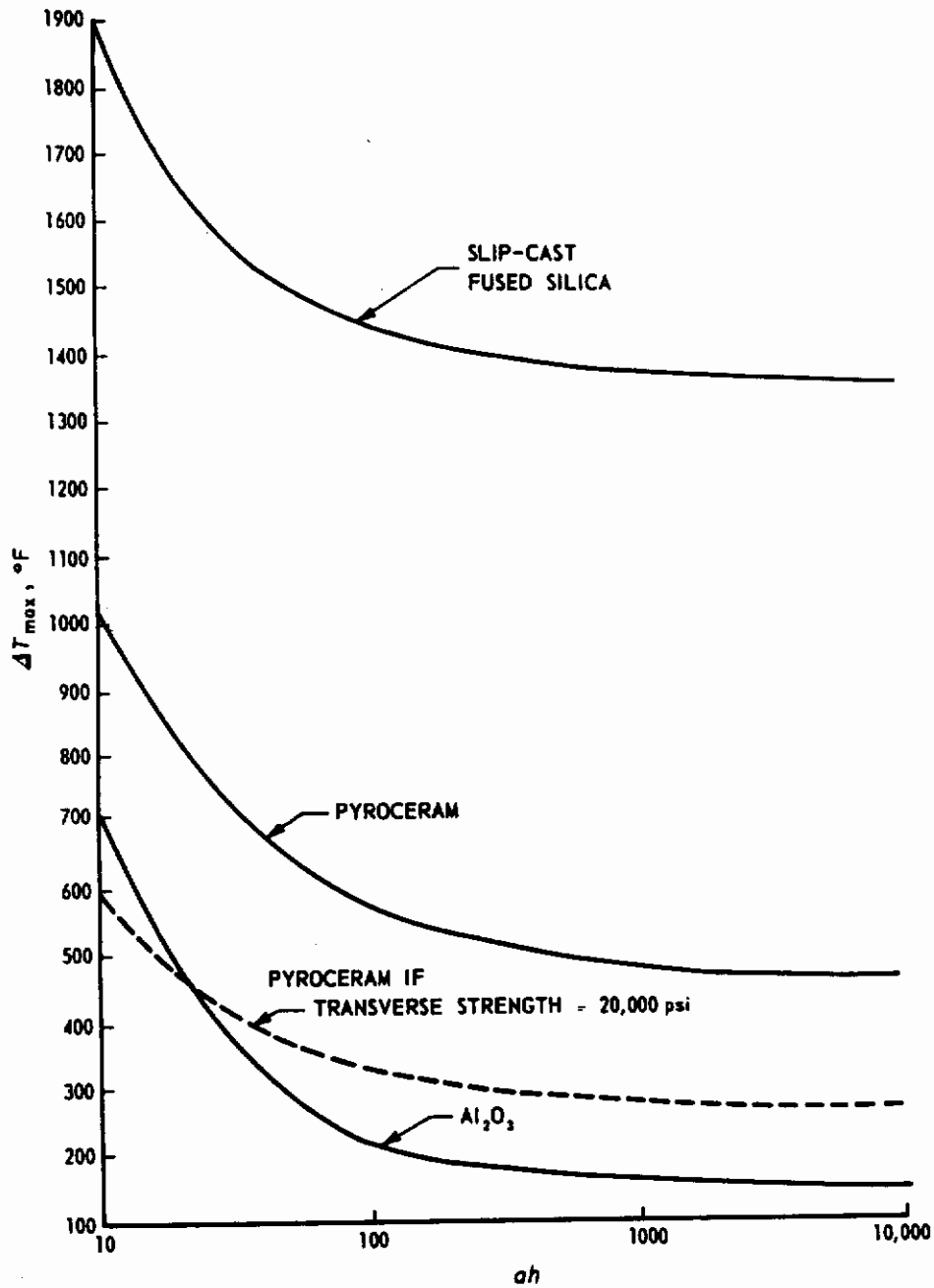

Figure 14 Maximum Temperature From Which Al_2O_3 , Pyroceram, and Slip-cast Fused Silica May Be Quenched as a Function of ah . Walton and Bowen (Ref. 172).

a = half the thickness
 h = heat transfer coefficient

45 seconds at 14 inches, whereas Pyroceram 9606 did not fail at distances greater than 12 inches.

Figure 15 shows the effect of temperature on transverse strength. It is of interest to note that the slip-cast fused SiO_2 increases in strength to 1800°F , while Al_2O_3 and Pyroceram 9606 decrease in strength after reaching 1000°F . It is also noteworthy that devitrified ceramic materials must be kept relatively thin ($\sim 1/2$ inch) in order that uniform properties across the thickness to be maintained.

Figures 16 and 17 show the results for sample (7" x 2" x 1/2") which were placed 14 inches from the exhaust of an oxygen-hydrogen rocket motor exhaust and inclined at an angle of 45 degrees. The heat flux as measured by a water-cooled copper calorimeter was $140\text{ Btu/ft}^2\text{ sec.}$, corresponding to the heat flux anticipated by a Mach 4 to 5 cruise vehicle or a boost glide vehicle.

The results of this study brought out that (1) the relative thermal shock resistance of Pyroceram and Al_2O_3 depends on the severity of thermal shock environment as well as the physical properties of each material; (2) Al_2O_3 could be superior to Pyroceram under mild conditions, but not under severe thermal shock conditions; and (3) that these materials obtained thermal shock resistance from their mechanical strength, whereas slip-cast fused silica was more dependent upon low coefficient of thermal expansion.

Several good reports on the use of Pyroceram materials in radome design have been published. These reports, however, are of a classified nature and therefore cannot be referenced or discussed here. A few comments are made concerning their radome application at elevated temperatures and data sources of information where further details may be obtained is provided.

Table V lists the Pyroceram radomes currently being used in missile programs (Ref. 173). Melpar has conducted a program

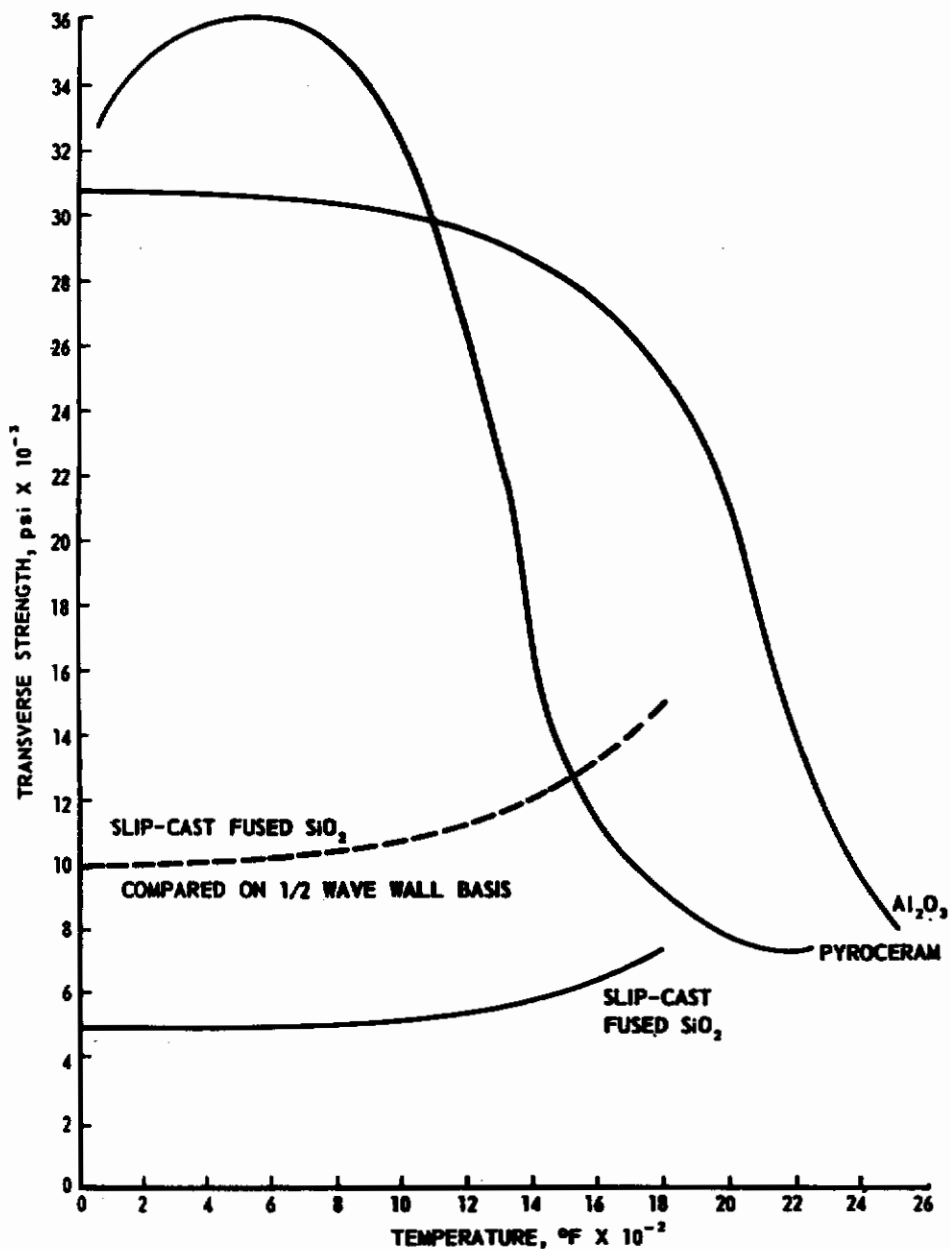

Figure 15 Effect of Temperature on Transverse Strength of Al₂O₃, Pyroceram, and Slip-cast Fused Silica. Walton and Bowen (Ref. 172).

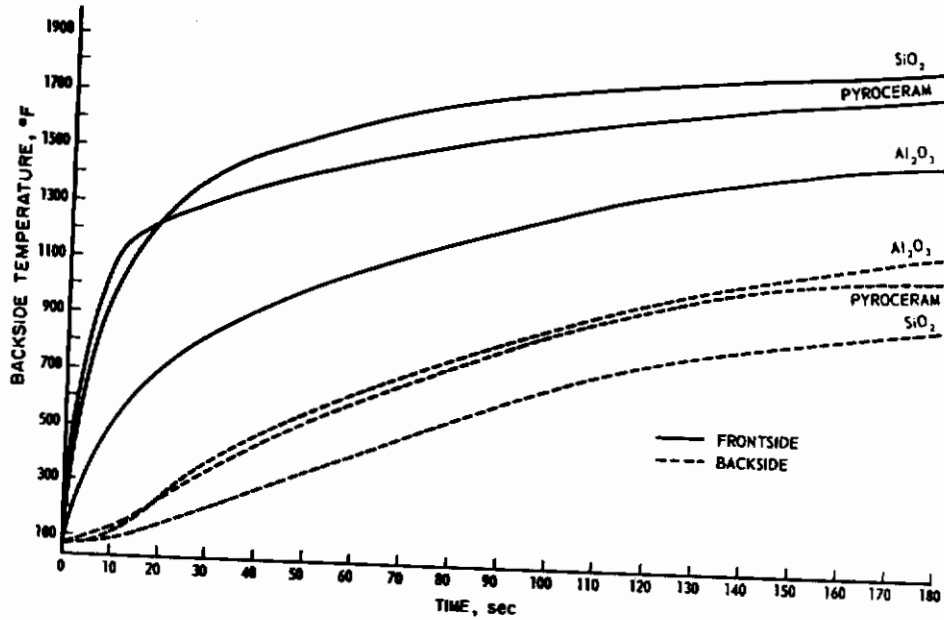

Figure 16 Frontside-backside Temperature of Al₂O₃, Pyroceram, and Slip-cast Fused Silica as a Function of Time in Oxygen-hydrogen Rocket Motor Exhaust. Samples 1/4-Inch Thick. Walton and Bowen (Ref. 172).

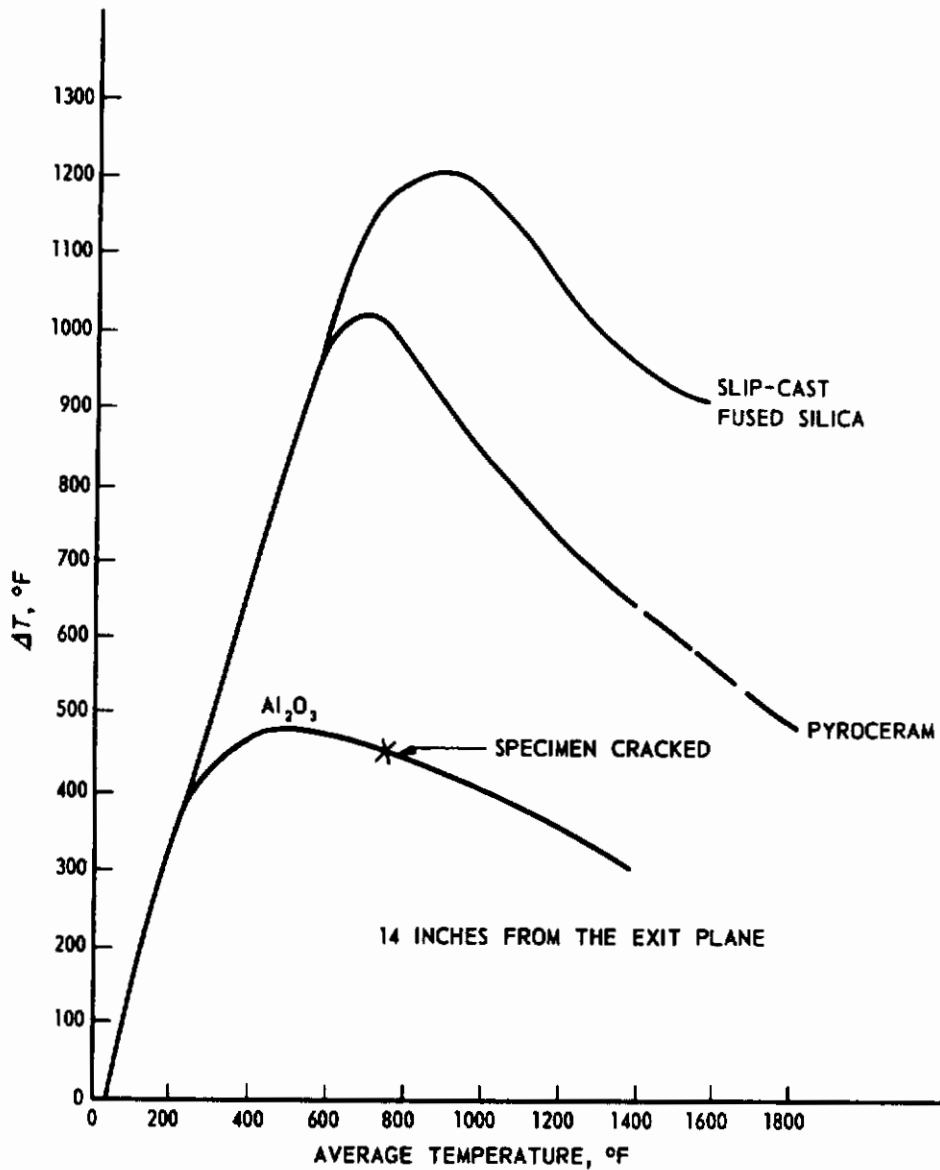

Figure 17 ΔT Between Frontside and Backside of Al_2O_3 , Pyroceram, and Slip-cast Fused Silica as a Function of Average Wall Temperature in Oxygen-hydrogen Rocket Motor Exhaust. Walton and Bowen (Ref. 172).

TABLE V
Pyroceram Radomes Used in Current Missile Program
(Ref. 173)

Dome Configuration	Dome Dimensions		Missile	Service	Contractor
	Length (inches)	Base Diameter (inches)			
Hemisphere		6	Gar XI	Air Force	Hughes
Ogive (mod)	42	14	Phoenix (TFX missile)	Navy	Hughes
Ogive	16	8	Shrike	Navy	*NOTS
Ogive	37	12	Tartar	Navy	General Dynamics
Ogive	37	12	Terrier	Navy	General Dynamics
Ogive (?)			Typhon	Navy	Johns Hopkins A. P. L.
Von Karmen	36	14	Gar IX	Air Force	Hughes
Ogive	37 (Approximate)	14	Genie (thin-walled)	Air Force	Douglas Aircraft Santa Monica, Calif
Hemisphere		6	Sera (elec. head otherwise same as Side-winder)	Navy	*NOTS

*NOTS - Naval Ordnance Test Station, China Lake, California.

NOTE: The manufacturer in all cases was Corning Glass Works.

for the Hughes Aircraft Company to evaluate the properties of Pyroceram. This program considered the mechanical and thermal properties of Pyroceram, in addition to its dielectric properties, as a function of temperature. A program concerning ceramic materials for radome application is currently in progress, which will supply detailed data comparisons of devitrified ceramics with other materials (Ref. 173).

General Dynamics uses Pyroceram radomes for the Tarter, Terrier and Mauler missiles. The radome is machined from a blank to final size. The method of attachment is such that the outside diameter of the base of the radome is necked down, then an aluminum ring with a shoulder matching the inside diameter and face matching the outside diameter is inserted in the base. This joint is then fitted with a fiberglass ring and is then cured to provide an attachment ring (Ref. 173).

Two in-flight failures of General Dynamics Pyroceram radomes were found to be related to a particular lot which had not been satisfactorily tested for thermal shock resistance. Ever since a program has been instituted to test each radome for in-flight condition no failures have occurred.

Mr. A. L. Robertson of Johns Hopkins University reports that the Tarter and Terrier missiles are using Pyroceram nose cones. To date no failures have occurred in the nose cone itself, but these are subjected to temperatures of only 1000^o F.

A feasibility study on alumina and Pyroceram for use in electromagnetic windows and ogival radomes on hypersonic vehicles was performed by Magnus and Eisen (Ref. 174). In both cases studies were made for an Intercontinental Ballistic Missile (ICBM) type trajectory. The exact trajectory data was not presented due to its classified nature.

The window analysis showed that neither of these materials could withstand the heating loads encountered at the stagnation

Contrails

point. For this reason Pyroceram was investigated only for the case of 1/60 the stagnation heat flux. Digital programs considered variations of window geometry, boundary conditions and flight conditions. Since the important type of loading on electromagnetic windows is thermal, it was necessary that investigations of thermal stresses be based upon temperature. Results of the test showed that the hot wall temperature of Pyroceram was higher than the wall temperature of alumina due to the higher heat capacity of alumina. The temperature change through the 0.2 inch windows was larger for Pyroceram than alumina due to the lower conductivity of Pyroceram. This agrees with previous results as shown in Figure 17. These particular tests showed alumina to be superior to the Pyroceram, with the Pyroceram reaching a much higher temperature (620° C versus 350° C) and having a greater temperature gradient than the Al_2O_3 .

Windows of alumina or Pyroceram would therefore in this case be feasible only if the heat flux across the material were reduced considerably. This study suggested locating the window on the cylindrical portion of a hemisphere, cone, cylinder, or having upstream cooling by mass injection of nitrogen or helium.

Since trajectory used for the ogival radome study was also classified, it was reported under a separate report. The unclassified investigation showed the influence of geometry on the stresses for the Pyroceram material. Two values of fineness ratio (the ratio of height to base diameter) were used. A fineness ratio of three showed the maximum stress to be approximately 4000 psi in tension, and the stress decreased to 1000 psi within the first 26 percent of the length. The maximum tensile stress for the 0.866 fineness ratio was smaller. The important point is that the stress decreased slowly with distance along the length of the radome, being approximately 1000 psi at about 50 percent of the length.

In general the radome study by Magnus and Eisen (Ref. 174) showed that the stress levels in both materials could be held

within the strength limitations of the materials; the maximum stagnation wall temperature of the mission is low (504° C); therefore, either of these materials could satisfactorily meet the requirements. The type of mission studied was best adapted to Pyroceram since alumina would have a higher manufacturing cost.

b. Electron tubes

Fink (Ref. 175) investigated the use of Pyroceram devitrified ceramics as a universal, high-temperature (500° C) tube envelope material and evaluated metal-to-devitrified ceramic seals in brazed structures. The sealing material was also a devitrified ceramic material, specifically known as Pyroceram Cement Code No. 45. A chart showing the matching of coefficients of expansion between Pyroceram 9606 and various metals is provided for use in designing tubes (Figure 18). The study showed some interesting effects on these materials as listed below:

- (1) The permeability of Pyroceram 9606 to some gases at elevated temperatures was found to be superior to that of most other glasses and about equal to 97 percent alumina. Table VI and Figure 19 provide specific values of the permeability factor determined by Miller (Ref. 176). The permeability factor designated as K is defined as the volume of gas in cubic centimeters at standard temperature and pressure that will flow through a wall one square centimeter in area and one millimeter thick in one second under a pressure difference of one centimeter of mercury. The permeability factor was calculated using the formula $K = 3.66 \times 10^{-7} q'd/Ap$ microns per hour where
 q = gas flow in cubic centimeter atmospheres/second
 d = wall thickness in millimeters
 A = wall area in square centimeters
 p = pressure difference in centimeters of mercury
when q is determined in liter-microns per hour (q').

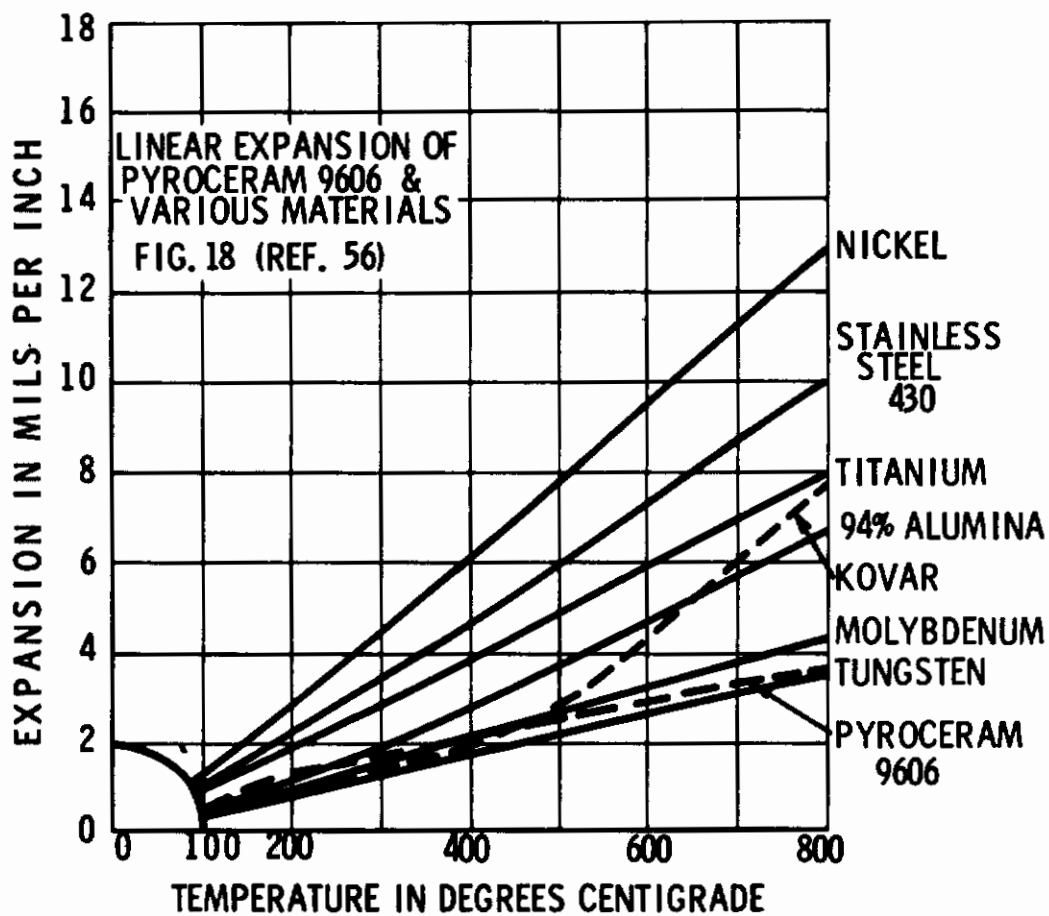
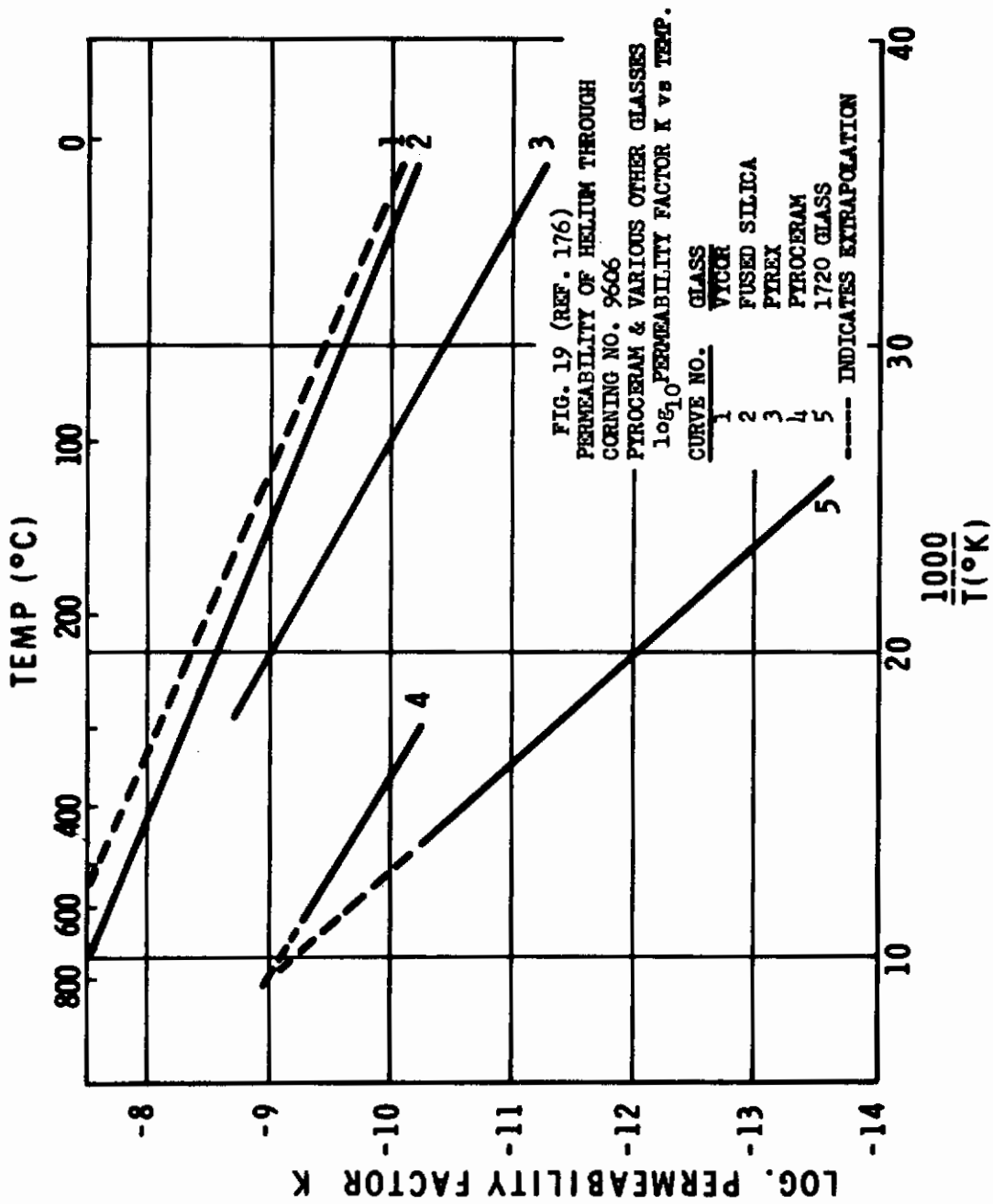

TABLE VI
Permeability Factor K For Various
Gases Through Corning No. 9606 Pyroceram
(Ref. 176)

Gas	K°	Temp. $^{\circ}C$
Helium	5.4×10^{-10}	617
"	3.3×10^{-10}	508
"	1.6×10^{-10}	410
"	$.62 \times 10^{-10}$	305
Argon	26×10^{-14}	945
"	7.2×10^{-14}	877
"	3.5×10^{-14}	725
"	1.7×10^{-14}	585
"	$.89 \times 10^{-14}$	480
"	$.21 \times 10^{-14}$	340
Air	100×10^{-15}	920
"	14×10^{-15}	805
"	8.3×10^{-15}	785
"	9.1×10^{-15}	772
"	3.2×10^{-15}	636
"	3.2×10^{-15}	615
"	2.2×10^{-15}	500
"	1.5×10^{-15}	475
"	$.44 \times 10^{-15}$	320



Conclusions

(2) Two assemblies exposed for 282.5 hours for a total radiation dosage of 7×10^{18} neutrons per square centimeter showed no sign of leaks.

(3) Fourteen assemblies when tested from $+23^{\circ}$ to -76° C and from 0° to 100° C showed no thermal shock failures.

(4) Thirteen assemblies were heated from 23° to 750° C and cooled back to room temperature without failure.

(5) No failures occurred to five assemblies held at 400° C for approximately 2000 hours. At 500° C for 1500 hours two failures occurred, but not due to the devitrified ceramic material.

(6) Pyroceram reacted with hydrogen at temperatures above 600° C, resulting in discoloring to a dark gray and lowering the resistivity. This necessitated sealing in an inert atmosphere. Recently developed new forms of Pyroceram are hydrogen inert.

(7) The Pyroceram solder material was subject to attack by heated organic acids.

(8) At elevated temperatures the gas released from Pyroceram was negligible.

In conclusion, the Pyroceram envelope tube seemed satisfactory and operating tubes could be made. The brazed stacked envelope had minor failure problems, but with further study and development these could be resolved. It was recommended that Pyroceram be investigated and fully evaluated as a substitute material in stacked type tubes, a major advantage being the potentially low cost when considering mass production.

A recent article by McMillan and B. P. Hodgson (Ref. 177) explains the use of these new devitrified ceramics for electrical insulator seals. They show how a special glass that is directly molded to the metal, and then heat treated to convert it into a devitrified ceramic can be used with copper and mild steel materials. After pretreatment of the base metal and forming the seals by press molding,

the devitrified ceramic is then produced by the usual heat treatment process.

c. Substrates for thin films

A continuing program performed under the direction of Professors E. Banks and H. W. Schleuning (Ref. 178) has included an investigation of various ferrimagnetic oxides for thin films on unpolished, polished, and glazed Pyroceram substrates. Some of the films studied include nickel ferrite (NiFe_2), iron-vanadium oxide (FeVO_3), yttrium iron garnet and iron-copper (CuFe_2O_4). The data, as reported in the various progress reports is sometimes inconclusive, and no final report has been announced as of March 1963.

2. Lithia - Alumina - Silica Compositions Nucleated by Titania

The material of interest and discussed in the literature for this system is Corning's Pyroceram 9608. This particular devitrified ceramic is commercially available and is therefore of considerable interest. It is a white, opaque material crystallizing to β -spodumene, β -eucryptite, or solid solutions containing one or both, for low-expansion devitrified ceramics. (See Table IV for comparison of properties.) Appendix III provides comparative properties for this material (Ref. 166). To date this material has been used for general purpose items such as dinnerware, tubing and pipe, and bearings for high temperature service.

a. Friction and wear studies

Since problems with mechanical strength, dimensional stability and corrosion resistance prohibit the use of metallic bearings at temperatures much above 1000°F a study was made by Carter and Zaretsky (Ref. 179) on Pyroceram 9608 with respect to rolling-contact fatigue life.

In this study groups of 1/2 inch bearing balls of Pyroceram 9608 were tested in a five-ball fatigue tester set up by Lewis Research Center. The test apparatus was essentially a modified bench-type drill

Contrails

press consisting of a test section, special drive spindle, lever loading system, and lower support housing for a heater to accomplish high temperature testing. The test section, shown in Figure 20, consists of a driven test ball pyramided upon four lower balls positioned by a separator, and is free to rotate. The rotative speed was 2430 revolutions per minute; the loading, contact angle, temperature and lubricant varied. The maximum loading stresses (theoretical compressive stress) were in the range of 265,000 to 330,000 psi and the test temperature was less than 700° F, which is below the range where devitrified ceramics would be considered as a replacement for steel. A group of AISI-1 steel balls was also tested for comparison. In general, these tests showed that devitrified ceramics may be useful in low-load, short duration (times up to two hours were used) applications where an operating temperature above the limits of steels is the primary design consideration. Briefly the tests showed the following general results.

- (1) The devitrified ceramic balls failed similarly to the steel specimens.
- (2) The room-temperature load carrying capacity of the devitrified ceramic was approximately one-fifteenth that of the steel balls.
- (3) The rolling-contact fatigue life of the devitrified ceramic showed greater sensitivity to load than that of steels.
- (4) The rate of failure spall development for Pyroceram was much slower than that for steel balls.
- (5) Finishing methods had an important effect on fatigue life of the devitrified ceramic.
- (6) The fatigue life of the devitrified ceramic at 700° F was approximately one-third that observed at room temperature. This may have been the result of the type of lubricant used and not the material itself.

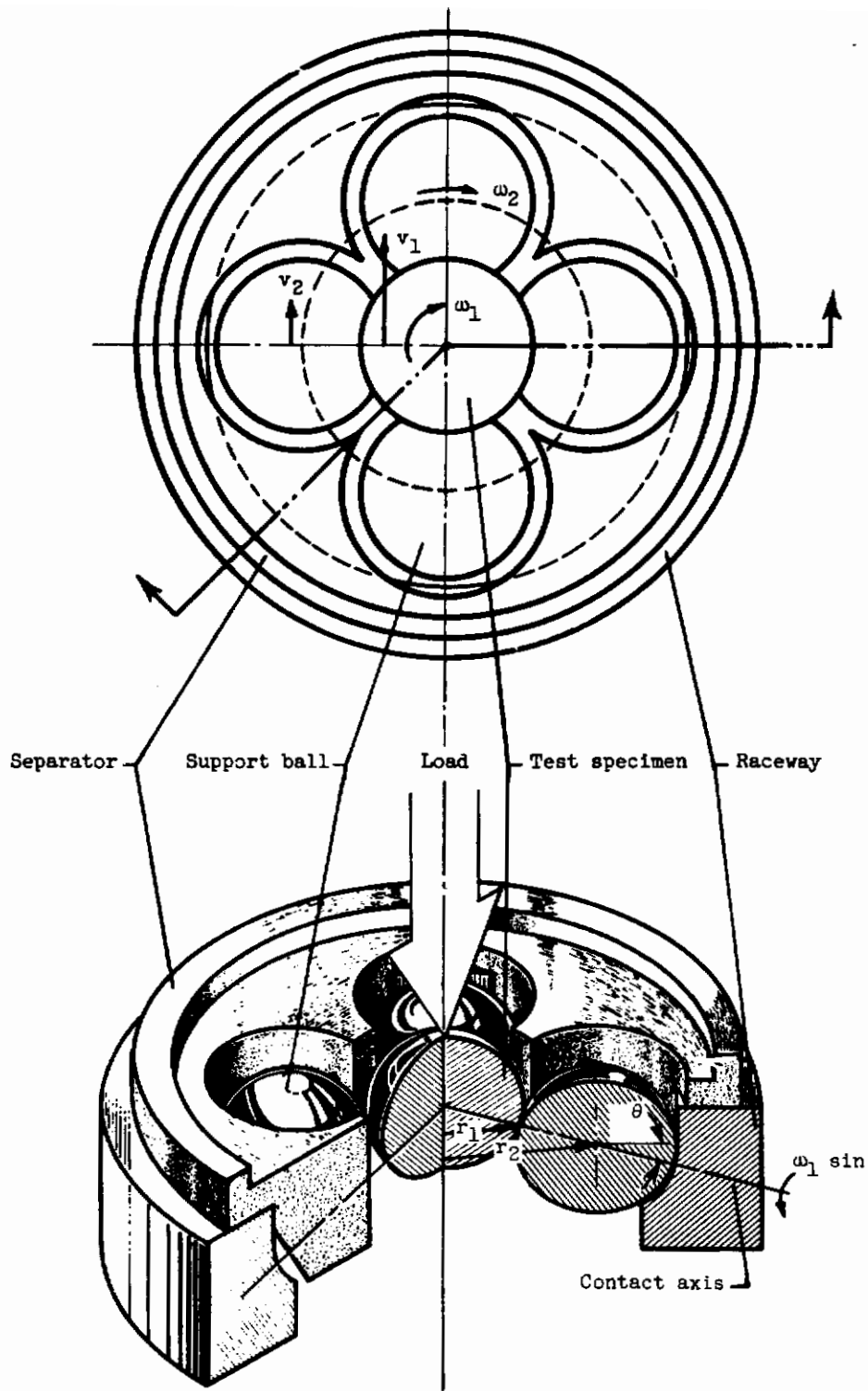

Figure 20 Five-ball Fatigue Tester. Carter and Zoretsky (Ref. 179).

Contrails

(7) Different lubricants affected the fatigue life. For example, a longer life resulted with a paraffinic mineral oil yielding better life than a sebacate diester.

The problem of adequate lubricants for temperatures in the range where the properties of devitrified ceramics are advantageous was investigated by Buckley and Johnson (Ref. 180). The object of this study was to investigate the lubricating properties of gases such as dibromotetrafluoroethane ($\text{CF}_2\text{Br}-\text{CF}_2\text{Br}$) and dichlorotetrafluoroethane ($\text{CF}_2\text{Cl}-\text{CF}_2\text{Cl}$) with Pyroceram 9608 sliding on various nickel- and cobalt-base alloys at temperatures from 75° to 1500° F.

These tests were made with a stationary hemispherical rider (3/16 inch radius, Pyroceram 9608) sliding on the flat surface of a rotating disk (2 1/2 inches diameter, nickel- or cobalt-base alloy). The load employed was 1200 grams and sliding velocities were from 75 to 8000 feet per minute. The results of the tests are shown in Figures 21 through 28. In conclusion the gas $\text{CF}_2\text{Br}-\text{CF}_2\text{Br}$ was found to be an effective lubricant for Pyroceram 9608 sliding on Hastelloy R-235 and Inconel X up to 1400° F. The other gas $\text{CF}_2\text{Cl}-\text{CF}_2\text{Cl}$ provided effective lubrication for Pyroceram 9608 sliding on various cobalt-base alloys at 1000° F.

To improve techniques for studying fatigue damage of devitrified ceramics (satisfactory for other materials) Harrell and Zaretsky (Ref. 181) investigated polishing, etching, replication, and especially area locating methods used to study Pyroceram by optical and electron microscopy. Since the method of locating, orienting, and identifying specific areas of a specimen requires explicit details as noted in the original report, such items are not discussed in this report.

A good method for polishing involved use of a vibratory polishing technique with chrome oxide as the abrasive and either water or kerosene as the lubricant.

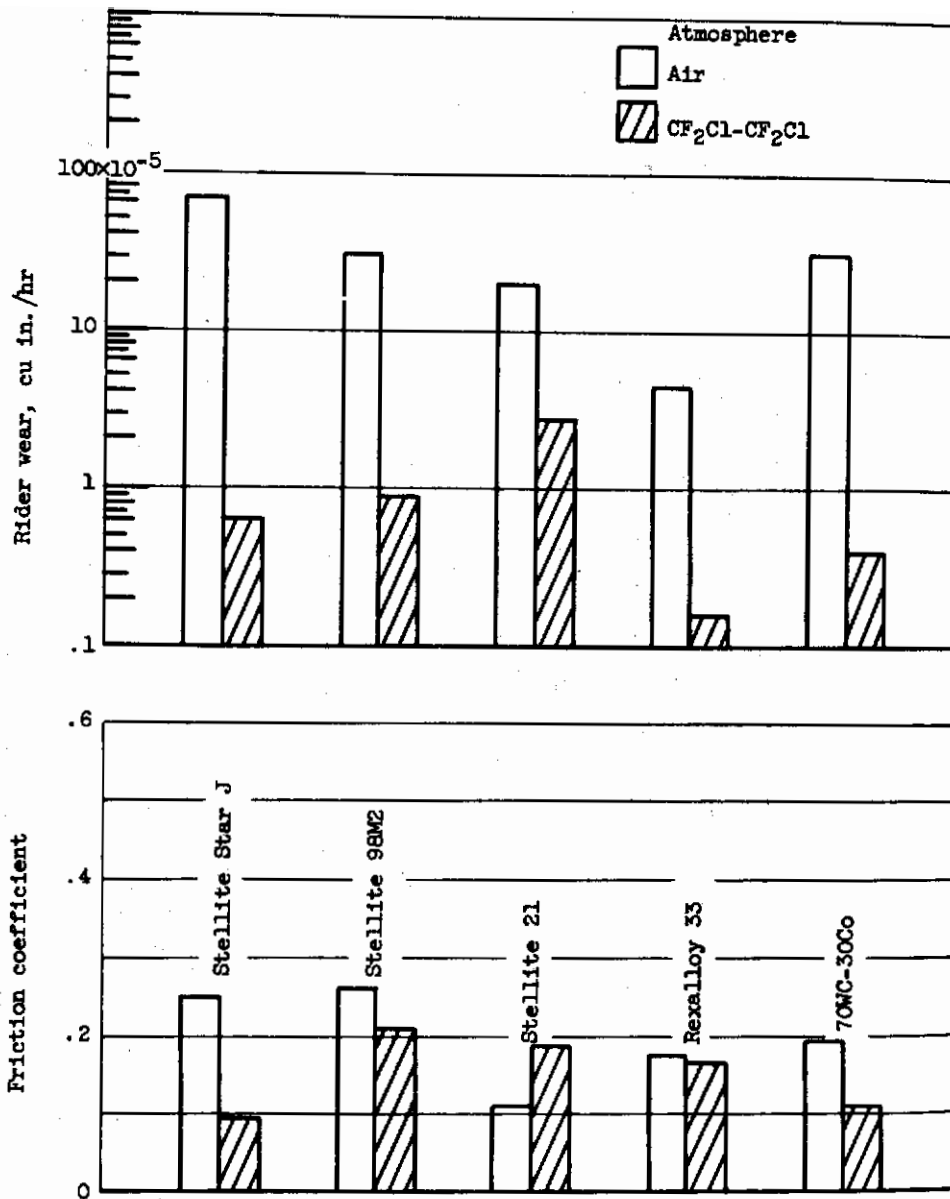

Figure 21 Friction and Wear of Pyroceram 9608 Sliding on Various Cobalt-base Alloys at 1000° F. Sliding Velocity, 3200 Feet per Minute; Load, 1200 Grams; Duration, 1 hour. Buckley and Johnson (Ref. 180).

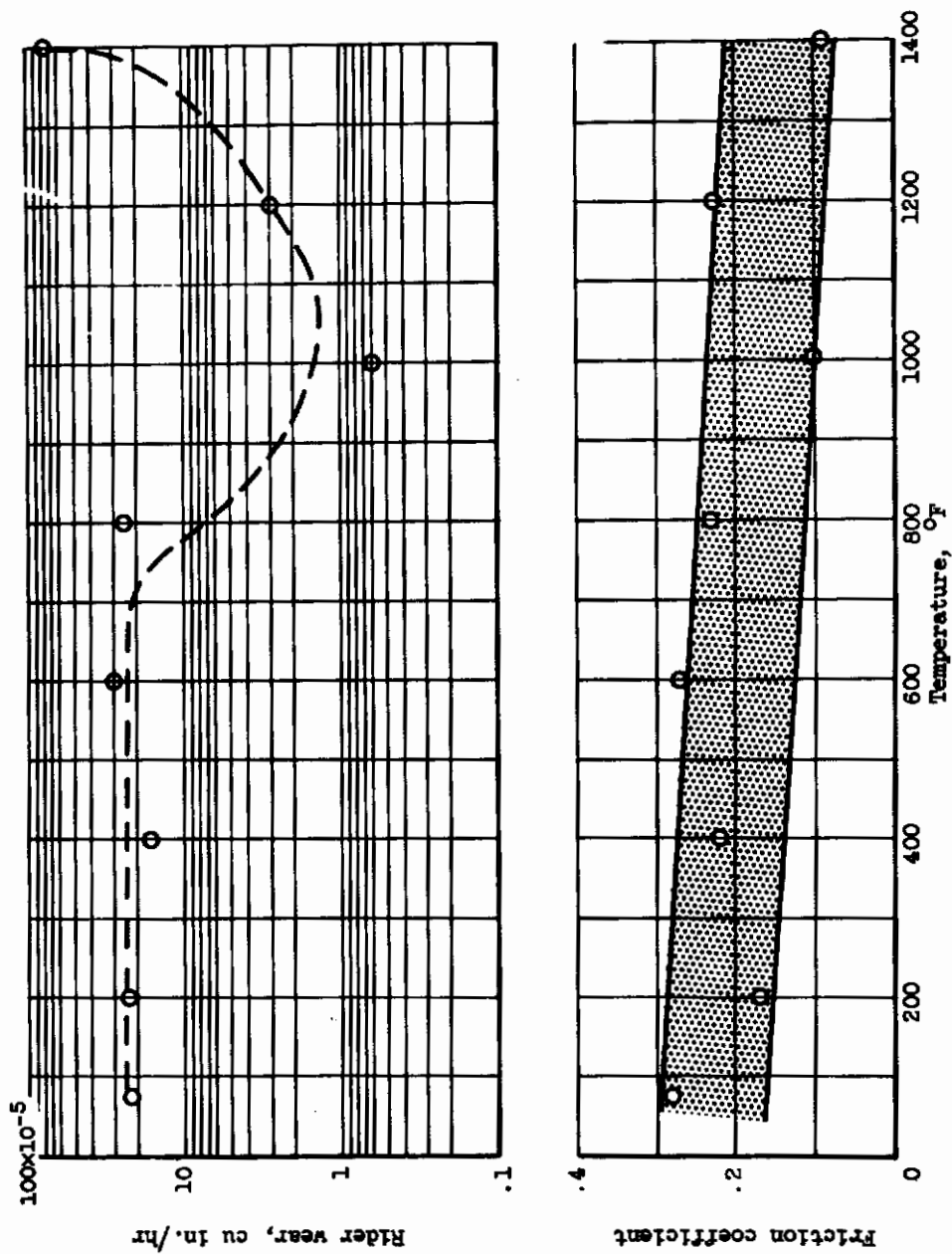

Figure 22 Friction and Wear of Pyroceram 9608 Sliding on Stellite Star J at Various Temperatures. Atmosphere, CF_2Cl-CF_2Cl ; Sliding Velocity, 3200 Feet per Minute; Load, 1200 Grams; Duration, 1 Hour. Buckley and Johnson (Ref. 180).

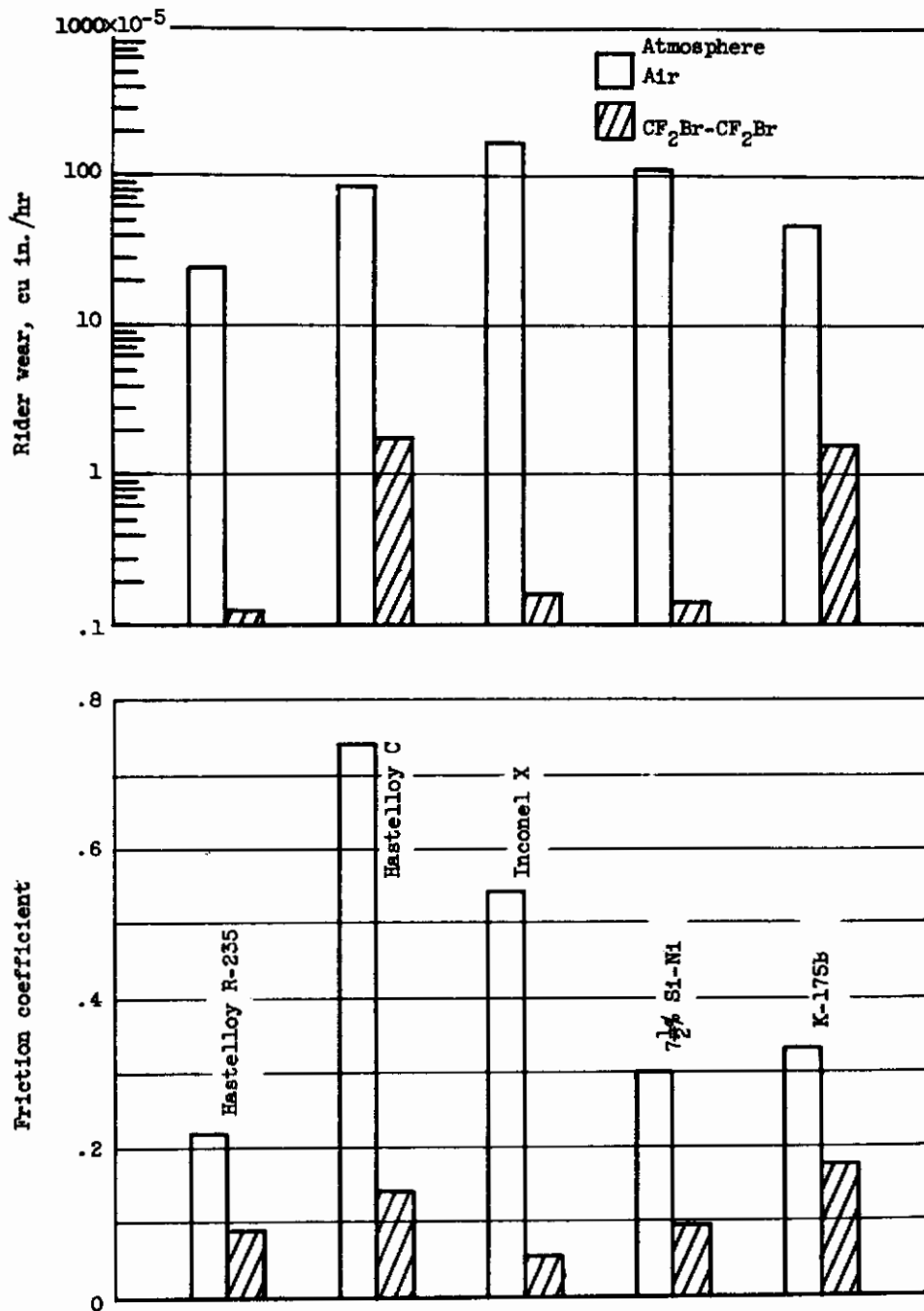

Figure 23 Friction and Wear of Pyroceram 9608 Sliding on Various Nickel-base Alloys at 1000° F. Sliding Velocity, 3200 Feet per Minute; Load, 1200 Grams; Duration, 1 Hour. Buckley and Johnson (Ref. 180).

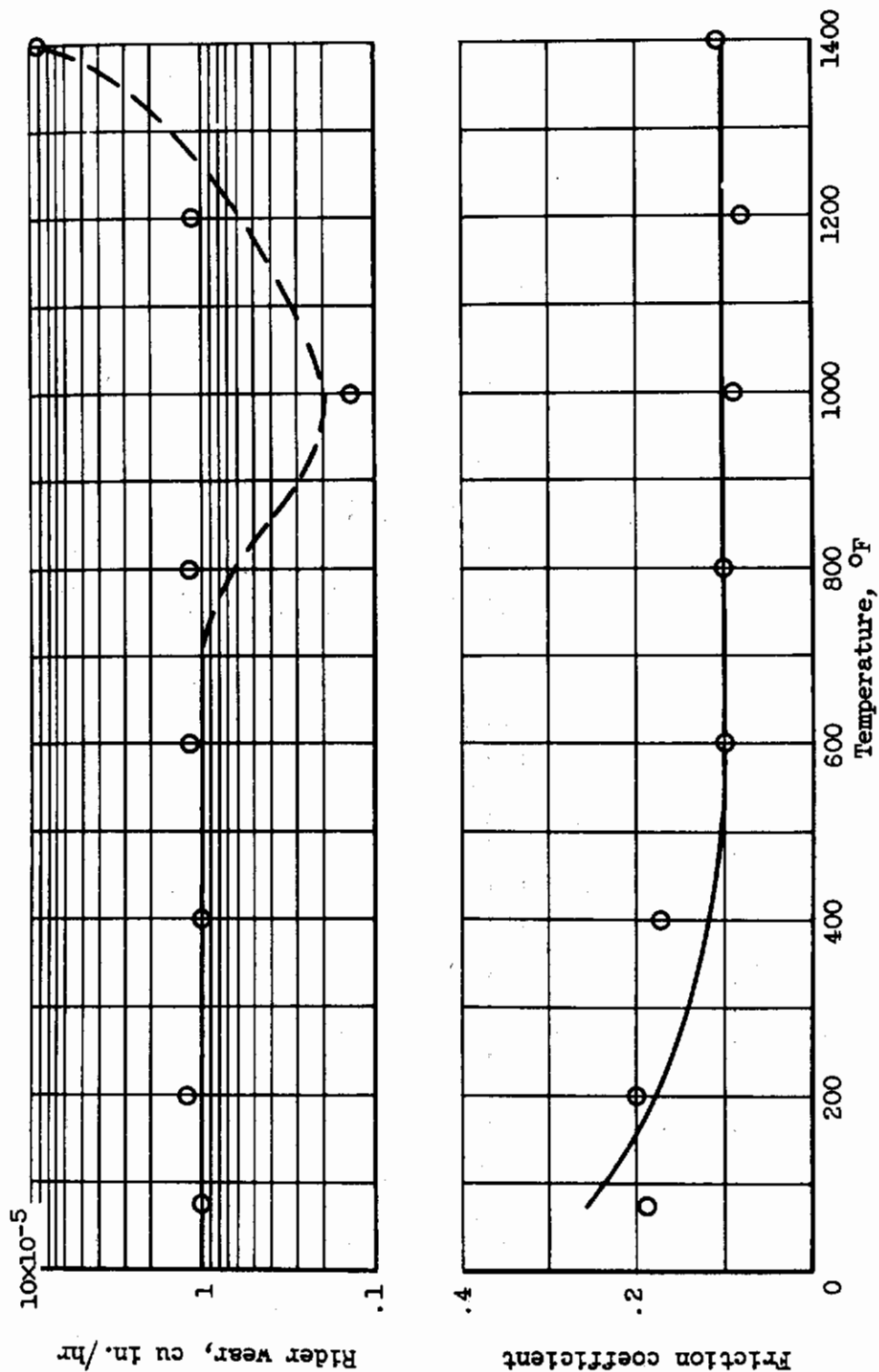

Figure 24 Friction and Wear of Pyroceram 9608 Sliding on Hastelloy R-235 at Various Temperatures. Atmosphere, $\text{CF}_2\text{Br}-\text{CF}_2\text{Br}$; Sliding Velocity, 3200 Feet per Minute; Load, 1200 Grams; Duration, 1 Hour. Buckley and Johnson (Ref. 180).

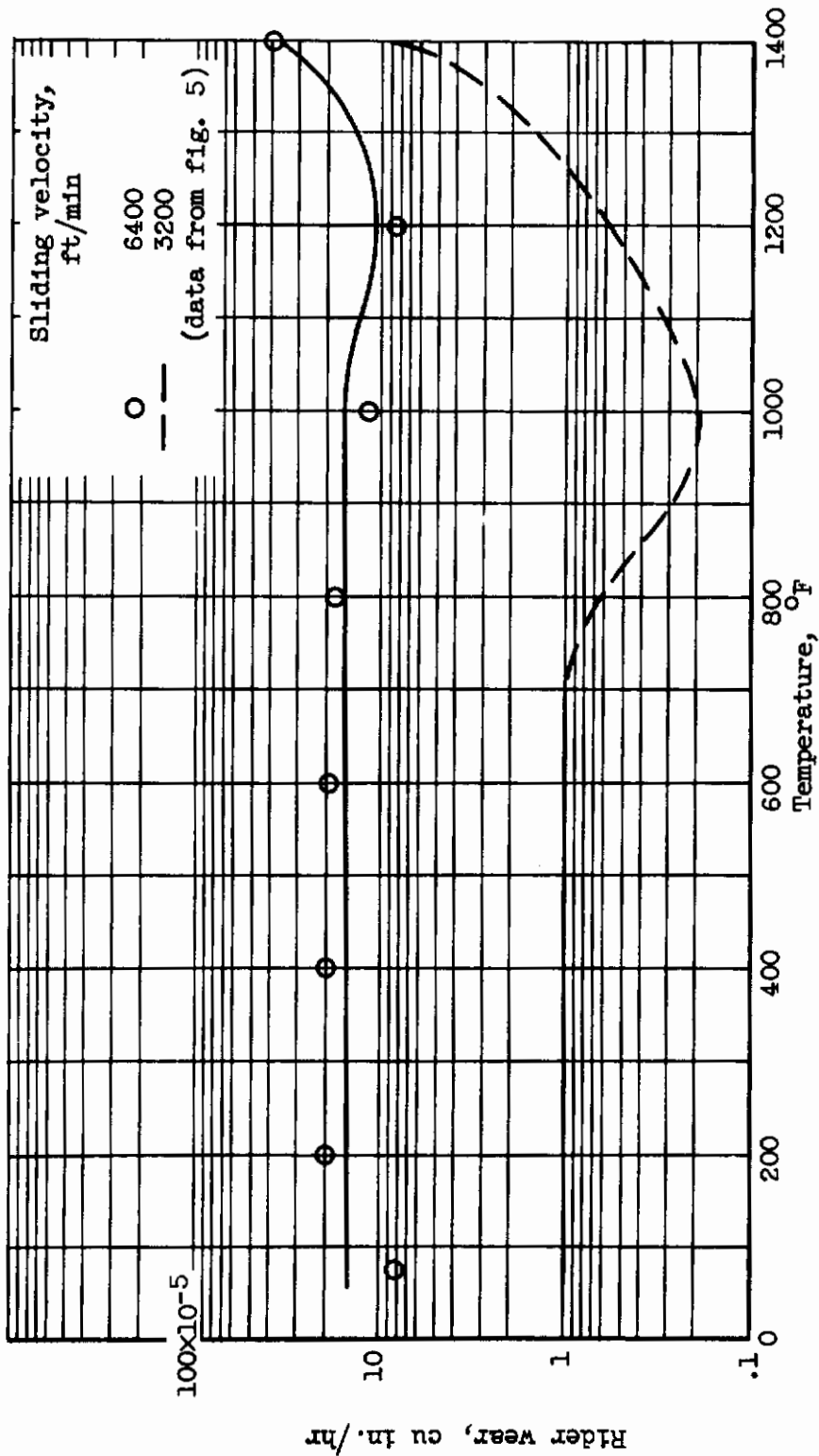

Figure 25 Wear of Pyroceram 9608 Rider Sliding on Hastelloy R-235 Disk at Various Temperatures and Sliding Velocities. Atmosphere, CF₂Br-CF₂Br; Load, 1200 Grams; Duration, 1 Hour. Buckley and Johnson (Ref. 180).

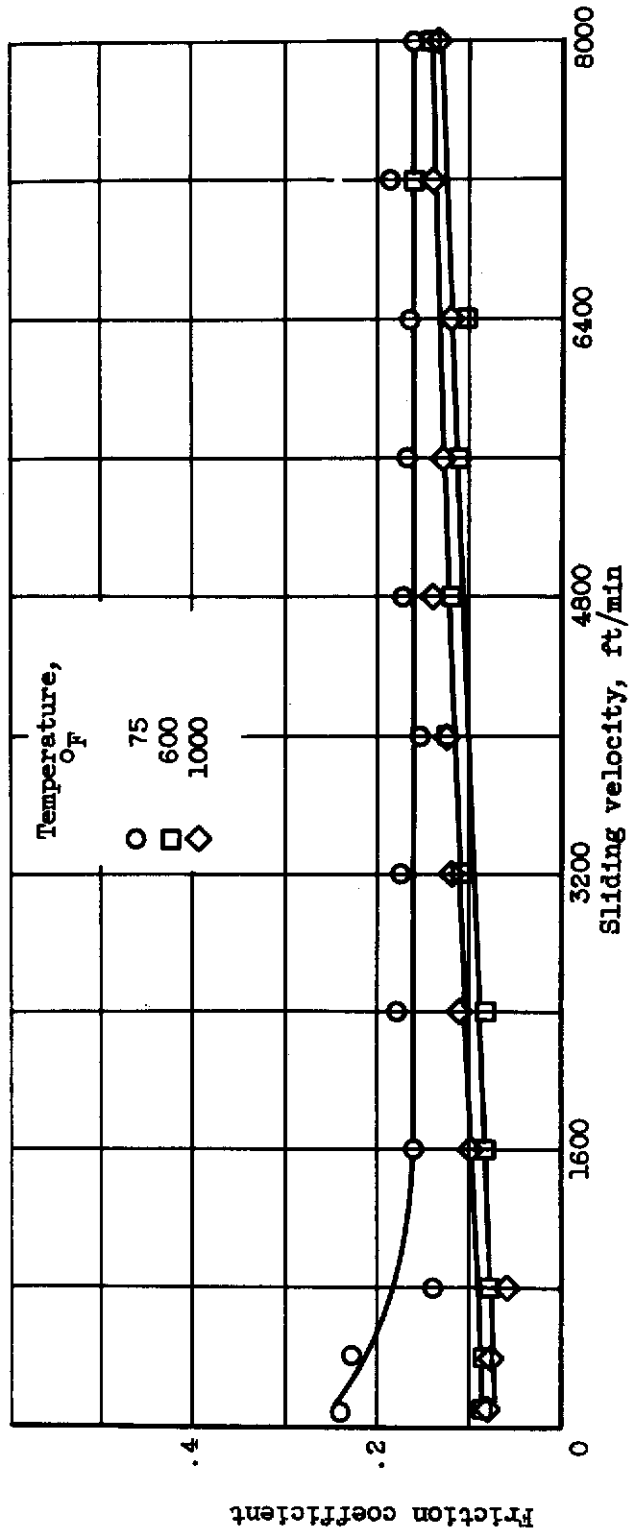

Figure 26 Friction Coefficient of Pyroceram 9608 Rider Sliding on Hastelloy R-235 Disk at Various Temperatures and Sliding Velocities. Atmosphere, CF_2Br-CF_2Br ; Load 1200 Grams; Duration, 1 Hour. Buckley and Johnson (Ref. 180).

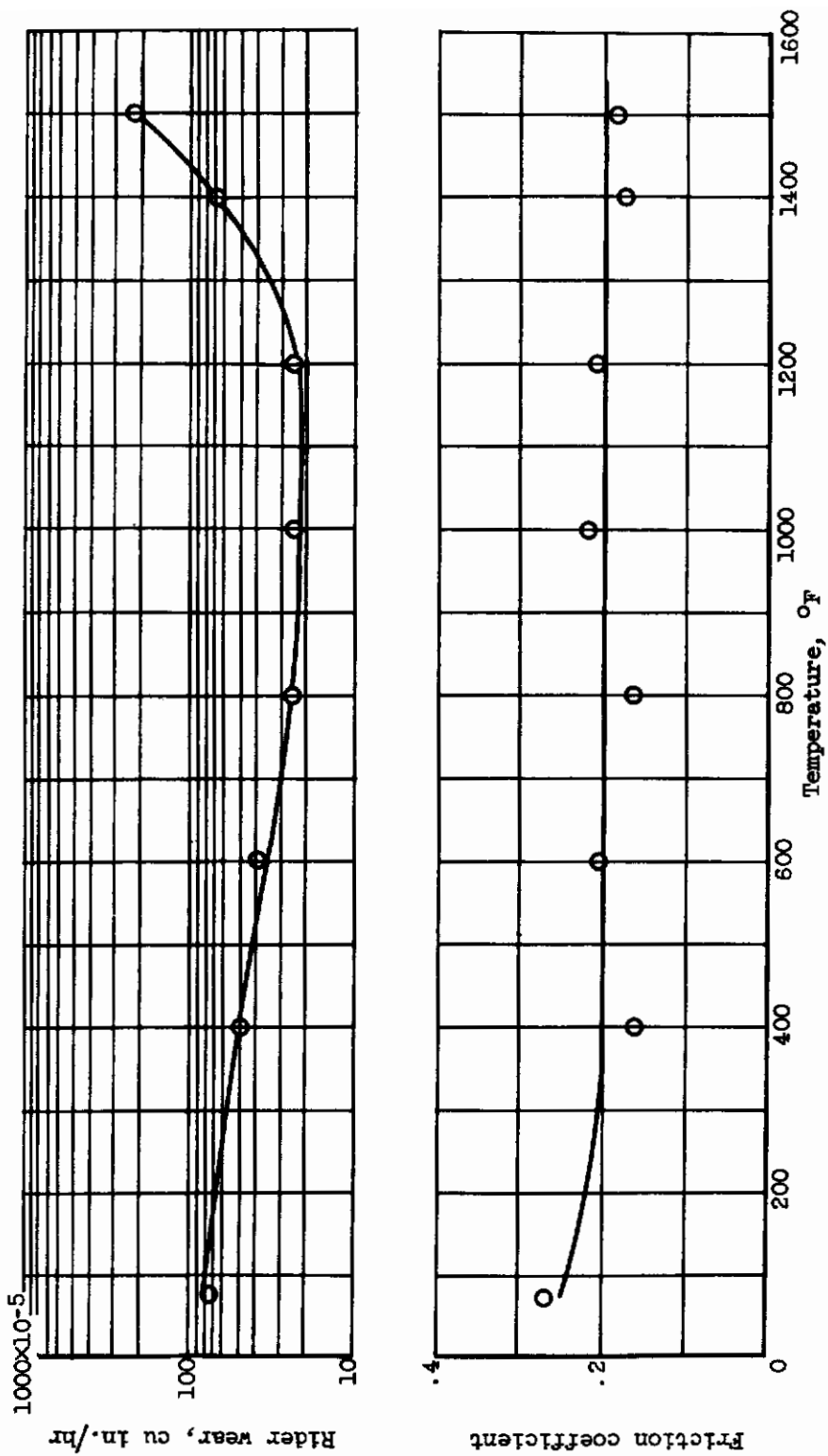

Figure 27 Friction and Wear of Pyroceram 9608 Sliding on Hastelloy R-235 at Various Temperatures in Air. Sliding Velocity, 3200 Feet per Minute; Load, 1200 Grams; Duration, 1 Hour. Buckley and Johnson (Ref. 180).

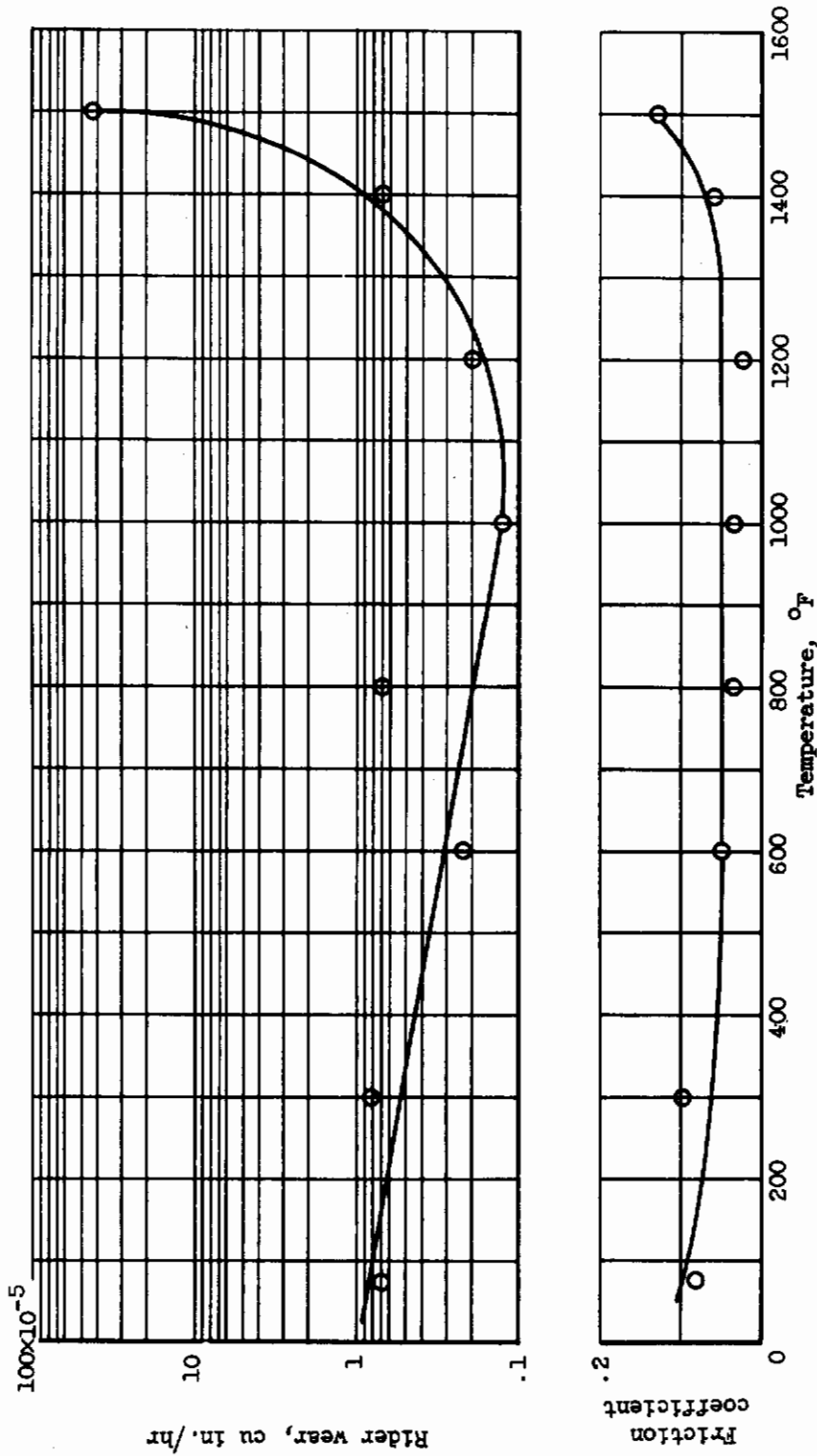

Figure 28 Friction and Wear of Pyroceram 9608 Sliding on Inconel X at Various Temperatures. Atmosphere, CF₂Br-CF₂Br; Sliding Velocity, 3200 Feet per Minute; Load, 1200 Grams; Duration, 1 Hour. Buckley and Johnson (Ref. 180).

A satisfactory etching process consisted of a primary etch of 5 milliliters of hydrochloric acid (concentrated), 5 milliliters of hydrogen fluoride (45 percent), and 45 milliliters of water, and a secondary etch with methyl alcohol replacing the water. Etching times from 25 to 30 seconds provided the best results.

Table VII provides the results of replication methods on Pyroceram. The releasing agent used on Faxfilm replicas was dehydrated Victowet. Plastic replicas ripped when being removed; pre-shadowed carbon or silicon monoxide replicas required etching.

b. Lightweight optical elements (Sandwich construction)

A study was made by Noble et al. (Ref. 182) on Pyroceram 9608 sandwich construction material for obtaining optimum weight reduction of reflecting optical elements. Some of the competitive materials included fused silica, beryllium, titanium and Super Invar. Table VIII shows the merits of several materials with respect to different parameters. The Pyroceram has strength greater than that of fused silica but its greater density at room temperature impairs weight reduction. Corning has shown that sandwich or even honeycomb-like structures can be made of devitrified ceramics. Pyroceram need not be as thick as glass or quartz to survive severe vibration. One solid Pyroceram mirror survived vibration and shock loads up to 100 G. Silicon monoxide coatings have been used to increase the smoothness of the surface. For special orders, such as mirror blanks, requiring less than 3000 pounds of material, Schott in Mainz, Germany would probably be the source.

Charles Eumarian (Ref. 183) prepared a graph (Figure 19) showing a comparison of coefficient of expansion for low expansion materials including Pyroceram 9608. This graph is intended as an aid in designing precision optical instruments where consideration of expansion between glass elements and their housings is of prime importance.

TABLE VII
Results of Replication Methods on Pyroceram
(Ref. 181)

Replication	Advantages	Difficulties or Disadvantages
(1) Silicon monoxide with releasing agent and pre-shadowing*	(a) Thickness of replica easy to control (b) Positive replica	Time-consuming
(2) Faxfilm*	Can be used for locating given spot on sample	(a) Demands two step process (b) Cannot be preshadowed
(3) Carbon with releasing agent and preshadowing*	(a) Positive replica (b) Holds up well	(a) Poor replication in poorly controlled vacuum (b) Time-consuming
(4) Silicon monoxide*	High resolution obtainable	Requires "etching through" for release, which damages sample and replica
(5) Carbon	High resolution	Requires "etching through" for release, which damages sample and replica
(6) Parlodion	-----	(a) Solvent attacks mount (b) Sticks too tenaciously, tends to tear
(7) Formvar	-----	(a) Solvent attacks mount (b) Sticks too tenaciously, tends to distort
(8) Polyvinyl	-----	(a) Must be removed at proper time or cannot be removed at all (b) Tends to produce excessive artifacts

* Suitable for Pyroceram

TABLE VIII
Relative Physical and Thermal Merit Ratios
Noble et al. (Ref. 182)

Material	$(E/\rho)'$	$(K/C\alpha)'$
Fused Quartz	1.00	1.00
Beryllium	4.84	1.86
Slip-cast Silica	1.15	.21
Pyroceram-9608	1.10	1.95
Vycor-7900	.97	.45
Pyrex-7740	.91	.11
Magnesium	.81	1.83
Aluminum	.80	3.14
Titanium	.80	1.22
Invar	.58	5.95
Foamglass	.26	.003

E = modulus of elasticity, psi
 ρ = density, lb/cu in.
 K = thermal conductivity, Btu/ft/hr, F
 C = specific heat, Btu/lb, F
 α = coefficient of expansion, F (10^{-6})

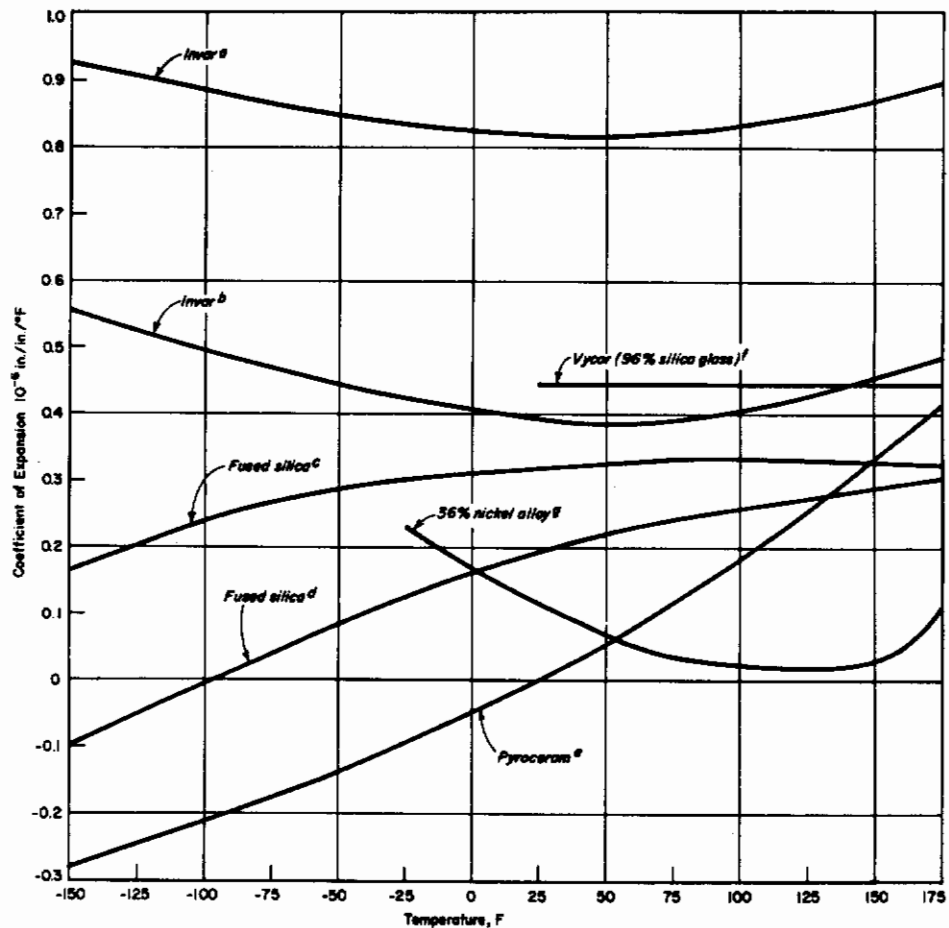

^a Annealed for 1 hr at 1550 F; air cooled. International Nickel Co.
^b Cold drawn 50%. Annealed for 2 hr at 650 F; Air cooled.

^c Code 7940, Corning Glass Works.
^d National Bureau of Standards.
^e Code 9608, Corning Glass Works.
^f Corning Glass Works.
^g Alloy LA-685, General Communications Co.

Figure 29 Comparison of Coefficient of Expansion for Low Expansion Materials (Ref. 183).

3. Devitrified Ceramic Coatings

The open literature is primarily concerned with a ceramic-metal composite trademarked Nucelite (Ref. 184 - 190). This devitrified ceramic coating is like Pyroceram in the fundamental processing techniques and also represents a family of compositions; therefore, properties range tremendously. Table IX represents the nonconfidential composition ranges and Table X shows some of the crystals which have been identified in these devitrified ceramic coatings after heat treatment. Hall and Sanford (Ref. 184) report development considerations and possible means for improvement of these coatings.

The properties representing many compositions of devitrified glass coatings as given by Hall and Sanford are included in Table XI. This table is provided to illustrate the improved properties over the standard glass coatings and not the limitations for the family of devitrified ceramic coatings.

A preprint copy of a paper written by McWilliams and Payne (Ref. 185) summarizes the substrate materials, problems and processing of these coatings, and was the basis for the following discussion.

The more commonly used base metals are low carbon steels, the 300 and 400 series stainless steels, Hastelloy and Inconel. In general, these alloys are advantageous in achieving the optimum properties of the composite. The refractory base metals such as tungsten, molybdenum and columbium have been tested, but their cost, fabrication problems, high oxidation rates and embrittlement features have limited their applicability.

A list of some specific factors which must be considered in the use and development of devitrified ceramic coatings are:

- a. The formulations are more complex than regular glass coatings as illustrated by the crystalline phases shown in Table X.
- b. The problem of fitting the coating to the substrate so as to place the coating in compression becomes more difficult in this

TABLE IX
Glass Composition Range
(Ref. 184)

Group	Oxides	Percent of Group
RO ₂ Group	SiO ₂	60 to 80
	TiO ₂	
	CeO ₂	
	ZrO ₂	
R ₂ O	K ₂ O	10 to 20
	Na ₂ O	
	Li ₂ O	
RO Group	MgO	3 to 8
	CaO	
	BaO	
	ZnO	
	SrO	
	MnO	
	CoO	
R ₂ O ₃	Fe ₂ O ₃	5 to 20
	B ₂ O ₃	
	Al ₂ O ₃	
	Cr ₂ O ₃	
	Sb ₂ O ₃	

TABLE X
Crystal Phases Formed During Heat Treatment
(Ref. 184)

β -Spodumene (Lithium Aluminum Silicate)	Sphene CaTiSiO_5
β -Eucryptite (Lithium Aluminum Silicate)	Diopside $\text{CaMg}(\text{SiO}_3)_2$
Albite $\text{NaAlSi}_3\text{O}_8$	Lithium titanium silicate
Amorphite $\text{CaAl}_2\text{Si}_2\text{O}_8$	Lithium silicate
Rutile TiO_2	Lithium disilicate
Cerium dioxide	

TABLE XI
Property Ranges for Glass and Crystallized Glass Coatings
(Ref. 184)

Test	Std Corrosion Resistant Glass Coatings		Crystallized Glass Coatings	
			Before Heat Treatment	After Heat Treatment
Abrasion resistance (Mg weight loss per 15 min cycle)	49-64		40-50	12-30
Thermal shock resistance (Δt in $^{\circ}\text{F}$ required to cause failure)	375-475		400-500	550-850
Impact resistance (in. -lb required to cause failure)	12-14		20-22	24-30
Estimated maximum service temp. ($^{\circ}\text{F}$)	700-800		750-1300	1200-1500
Corrosion Rates (mils per year)				
Boiling 20% HCl (vapor phase)	4-30		5-30	5-45
5% NaOH 150 $^{\circ}$ F (liquid phase)	9-25		10-35	12-65
Boiling distilled H_2O (liquid phase)	2-25		1-25	1-40

Contrails

case since the properties change during the final heat treating process.

c. The change in viscosity during processing due to crystal growth is another complication. Also, it is necessary to control the type, size, amount and dispersion of the crystalline phases.

d. The application and firing techniques are somewhat more complex than the normal glass coating.

Pfaunder discovered that generally the higher the percent of crystallinity the greater will be the mechanical and thermal resistance.

The process procedures for devitrified coatings after fabrication of the base metals as presented by Williams and Payne are as follows:

"Annealing The fabricated part is annealed to relieve welding stresses, out-gas the welds and parent metal, and to burn out any organic contaminants. The time-temperature cycle is governed by the particular base metal used.

"Cleaning The normal procedure for the majority of items coated is to grit blast with clean abrasive. Pickling has also been used successfully on base metals requiring this treatment.

"Application The normal techniques of spraying, slushing or dipping may be used. Closer control of the operation is necessary with respect to application weight.

"Firing The firing temperature is governed by the properties of the particular formulation used and ranges from 1600 - 2000° F. The rate of firing and the temperature uniformity during the firing cycle are more critical than with conventional glasses.

"Heat Treatment This is a distinct departure from normal glass lining or procelain enameling operations and is used to nucleate and effect proper crystallization within the glassy matrix. The time-temperature cycle varies with the formulation involved and must be closely controlled. It is possible to over age these materials in much the same way precipitation hardening metal

Contrails

alloys can be over aged. This results in loss in mechanical properties primarily but corrosion resistance can also suffer. In addition to the wet process methods of application used, dry process methods have been evaluated and found suitable for production use. In this technique, dry powder is applied to a hot substrate. As with the wet process methods, heat treatment is necessary to develop the proper crystalline phases."

To make one familiar with the capabilities of these coatings, Pfaudler has provided the following list of corrosive environments in which they are useful.

Molten zinc at 1110° F

Molten selenium at 1200° F

Molten gallium at 1290° F

Metal chlorides at 1200° F

95 - 98 Percent sulfuric acid at 450° F

Curing solid rocket fuels at 350° F

Electrical resistance at 750° F

Coal tar pitch at 750° F

Hydrochloric acid and chlorinated organics at 570° F

Molten salts at 1030° F

Aqua regia plus abrasives at 225° F (Tantalum is the only metal acceptable for this service)

Corning's Pyroceram No. 89, normally considered a cement material (Ref. 191), was studied by Rodney (Ref. 192) as a coating for use on a synthetic mica phosphate embedding material. This Pyroceram type coating is basically a lead borate modified with zinc oxide. The composition coated was essentially fluor-phlogopite synthetic mica mixed with an aluminum phosphate solution. These materials were being investigated for methods of application (hot dipping, brushing, cold dipping, fluidized bed) and firing schedules. Compositional studies were also conducted to obtain a glass which would not only wet the mica material better than the pure Pyroceram, but would also

devitrify. The objective for this study was to raise the dielectric strength of the overall composite, i. e., mica body and devitrified glass coating. The information available to the author at the time this report was written indicated that the coated samples showed significant improvement over the uncoated samples. This study as far as could be determined at the time is continuing and no final report was available.

4. Adhesives

The University of Illinois (Ref. 193) performed a rather elaborate fundamental compositional and crystallization development study on devitrified ceramics to be used for structural adhesives. This study included nucleating behaviors with precious metals and ceramic oxides like TiO_2 , and devitrification tendencies of various compositions. Some systems for which the devitrified crystalline phase was determined included the following:

- a. $\text{PbO-TiO}_2\text{-SiO}_2$
- b. $\text{PbO-TiO}_2\text{-BaO-SiO}_2$
- c. $\text{PbO-TiO}_2\text{-BaO-Na}_2\text{O-SiO}_2$
- d. $\text{PbO-TiO}_2\text{-Na}_2\text{O-SiO}_2$
- e. $\text{PbO-TiO}_2\text{-B}_2\text{O}_3\text{-SiO}_2$
- f. $\text{PbSiO}_5\text{-Na}_2\text{O-Al}_2\text{O}_3\text{-TiO}_2\text{-SiO}_2$

Many other compositions were investigated, but those listed above formed crystalline PbTiO_3 and BaTiO_3 during the heat treatment process. In these systems PbO , BaO and TiO_2 were used to obtain the crystalline compound. SiO_2 was present to form an initial glassy phase. Na_2O was present to vary the maturing temperature as well as the thermal expansion of the glassy composition. B_2O_3 was present to promote wetting of the metal by the adhesive. It was concluded that the crystallized bonds gave higher strengths than the

glassy adhesive at the higher temperatures ($> 1000^{\circ}$ F). The effect of composition and glass-crystal ratio on shear strength was of basic consideration in this study, but no data was available at time of reporting. The metal substrates of primary interest included type 17-7PH stainless steel and Rene' 41 alloy.

Three types of devitrified ceramic adhesives which are presently available on the market are listed below with a short description of their general characteristics. Previous literature reviews performed by Narmco Inc. and Battelle Institute (Ref. 194) provided similar information in Narmco's reports.

a. Astro-ceram (Ref. 194 - 196)

This family of new high-temperature adhesives or cements has been developed by American Thermocatalytic Corporation, Mineola, New York. The compositions of the cements are proprietary, but are based on oxides and silicates of the elements in Group IV of the Periodic Table. This cement offers maximum service temperature to 4400° F. Properties reported by the manufacturer indicate tensile strengths from 10,000 to 15,000 psi, modulus of rupture up to 23,000 psi and porosities of 0 to 0.2 percent with a mohs hardness between 8 and 9. The dielectric constant is between 7 and 9 at 10 cps. There are two basically different cements available: one can be air-dried and the other must be fired to form a bond. Low porosity compounds of each type are intended for vacuum sealers.

These adhesives have been used to coat thermocouples and resistance thermometers.

Thermodynamic data determined by the producer showed that only moist halogens attacked Astro-ceram. Calculations for reactions with respect to liquid metals showed that aluminum, platinum, rhodium, zirconium, magnesium, silicon, beryllium, nickel, molybdenum, titanium and niobium would not react up to 3270° F. At temperatures of 2730° F and higher the cements would react with

ammonia, the mechanism being most likely a hydrogen reduction.

b. Eccoceram QC

This is a product of Emerson and Cumings and is a highly siliceous cement. It maintains its physical strength and desirable electrical properties up to 2500° F. The tensile strength is 800 psi.

c. Pyroceram 45

These cements have a maximum service temperature of 700° C (1292° F) and are compatible with tungsten, molybdenum, several glasses and standard electrical ceramics.

These three adhesives plus other similar types were investigated for use in the fabrication of large ceramic radomes by bonding small segments (Ref. 194). The main segment materials were alumina, beryllia and zirconia. Preliminary compressive shear tests with alumina segment material eliminated the Astro-ceram and Eccoceram. Further study by Filippi (Ref. 194) on the Pyroceram 45 revealed the following properties:

a. No noticeable physical change was observed due to being placed in boiling water for 25 hours.

b. A range of weight loss from 1.6 percent to 7.3 percent occurred after being immersed in a 10 percent solution of sodium hydroxide for 24 hours.

c. After a 24-hour soak in a 10 percent solution of hydrofluoric acid, the percent weight loss was 24.6 percent and the surface became powdery.

d. Pyroceram No. 45 showed a range of 4.8 percent to 11.8 percent weight loss after soaking in aqua regia for 24 hours.

e. The electrical properties are summarized in Table XII.

f. The thermal expansion was measured using a fused quartz dilatometer. The results of this test are shown in Figure 30.

g. Pyroceram 45 wet the surface of alumina, beryllia and zirconia quite well.

TABLE XII
Average Dielectric Constant and Loss Tangent
For Adhesive Pyroceram No. 45 (Ref. 194)

Temperature °F	(Frequency 9.375 Gc) Loss Tangent	Dielectric Constant
RT	0.0039	5.23
500	0.0041	5.31
1000	0.0033	5.57
1200	0.0034	5.73

h. Shear tests, conducted on specimens as shown in Figure 31 exhibited high room temperature shear strengths (Figure 32), but a rapid drop in strength at 1000° F and 1200° F. This temperature effect could be a detriment to the design engineer who must utilize the lower stress figure.

Data was also obtained on a composite material, i. e., using a 97.6 percent Al_2O_3 material bonded with the adhesive. The data obtained in the composite tests were different than the adhesive alone. Some of the properties on the composite body using Pyroceram No. 45 were as follows:

a. The composite can withstand a maximum temperature differential of 300° F.

b. The dielectric constant (frequency 9.375 Gc) varies from 8.25 to 9.0 from room temperature to 1200° F, as compared to 5.23 to 5.73 for the plain adhesive.

c. The loss tangent (frequency 0.375 Gc) varies from 0.0006 to 0.0025 from room temperature to 1200° F as compared to 0.0039 to 0.0034 for the plain adhesive.

5. Cellular Devitrified Ceramics

To date the open literature on cellular devitrified ceramics is

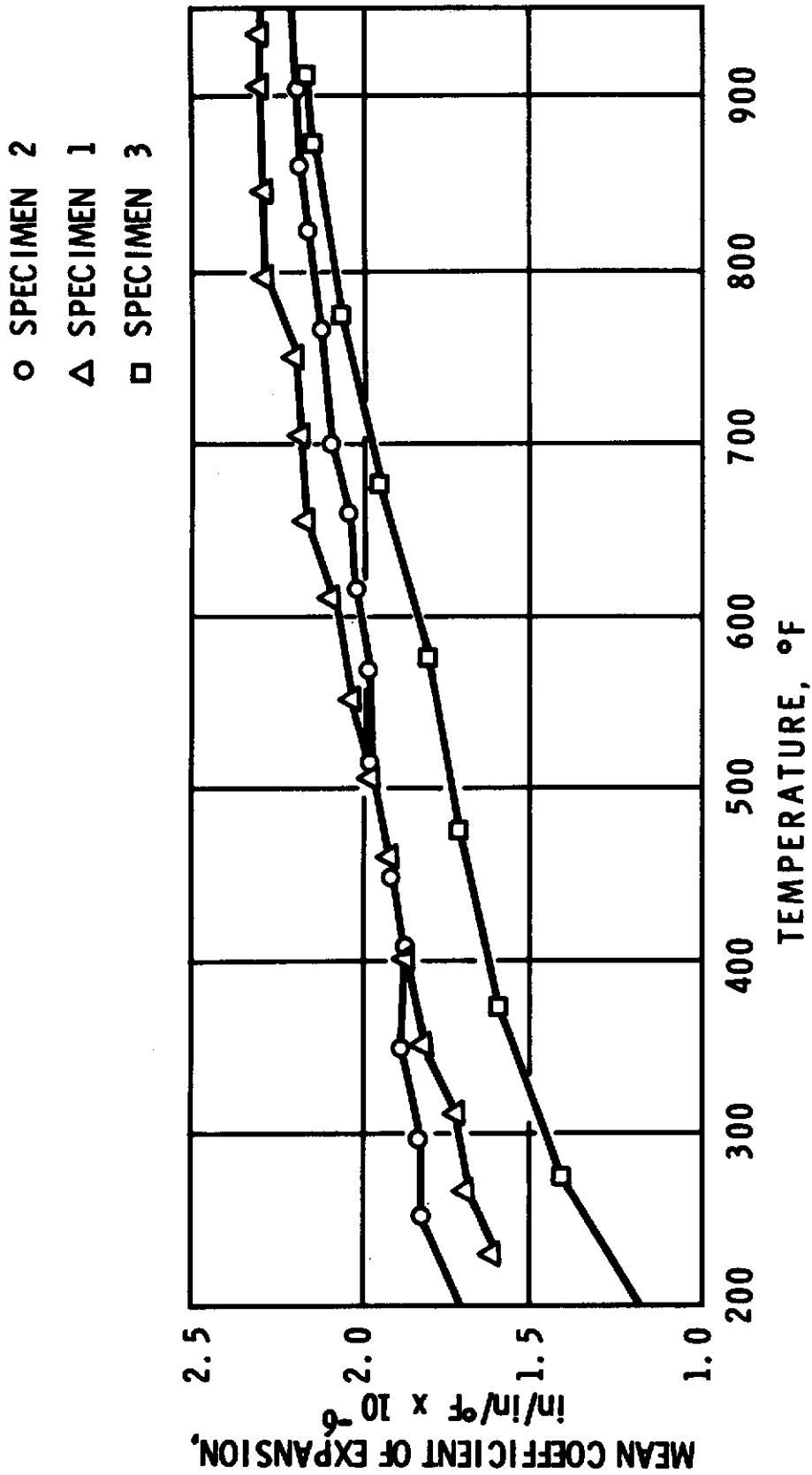
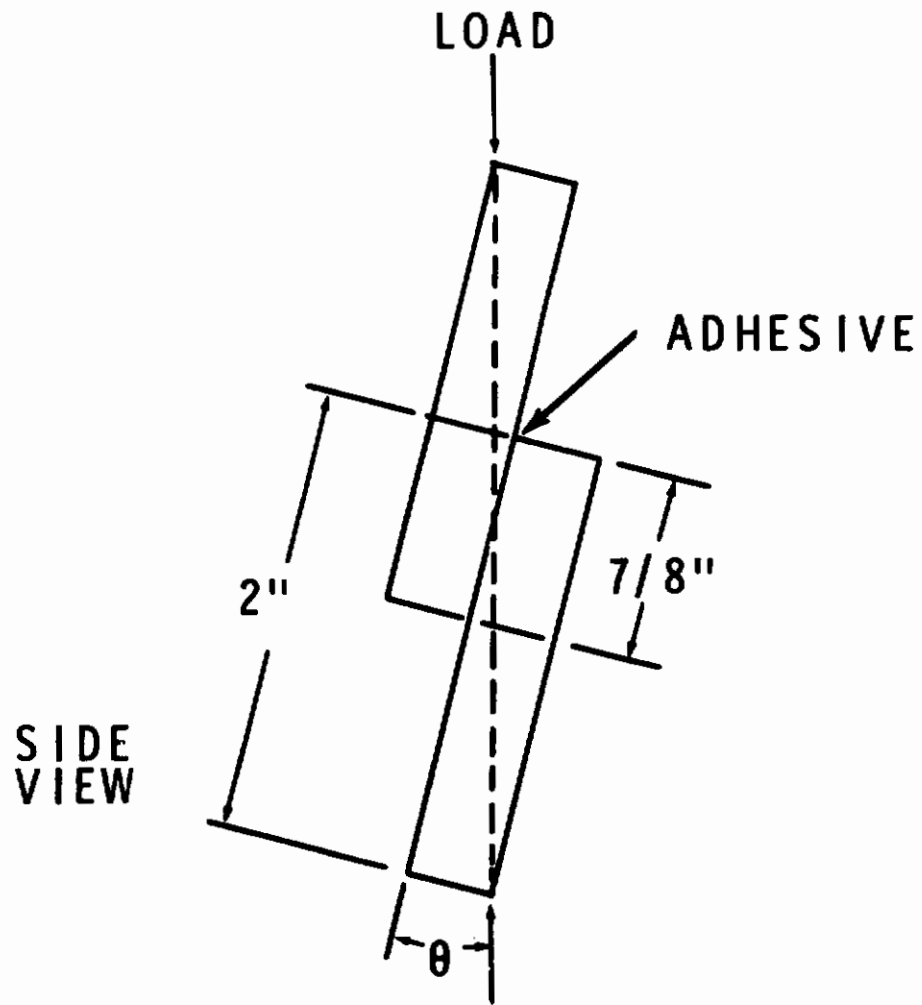
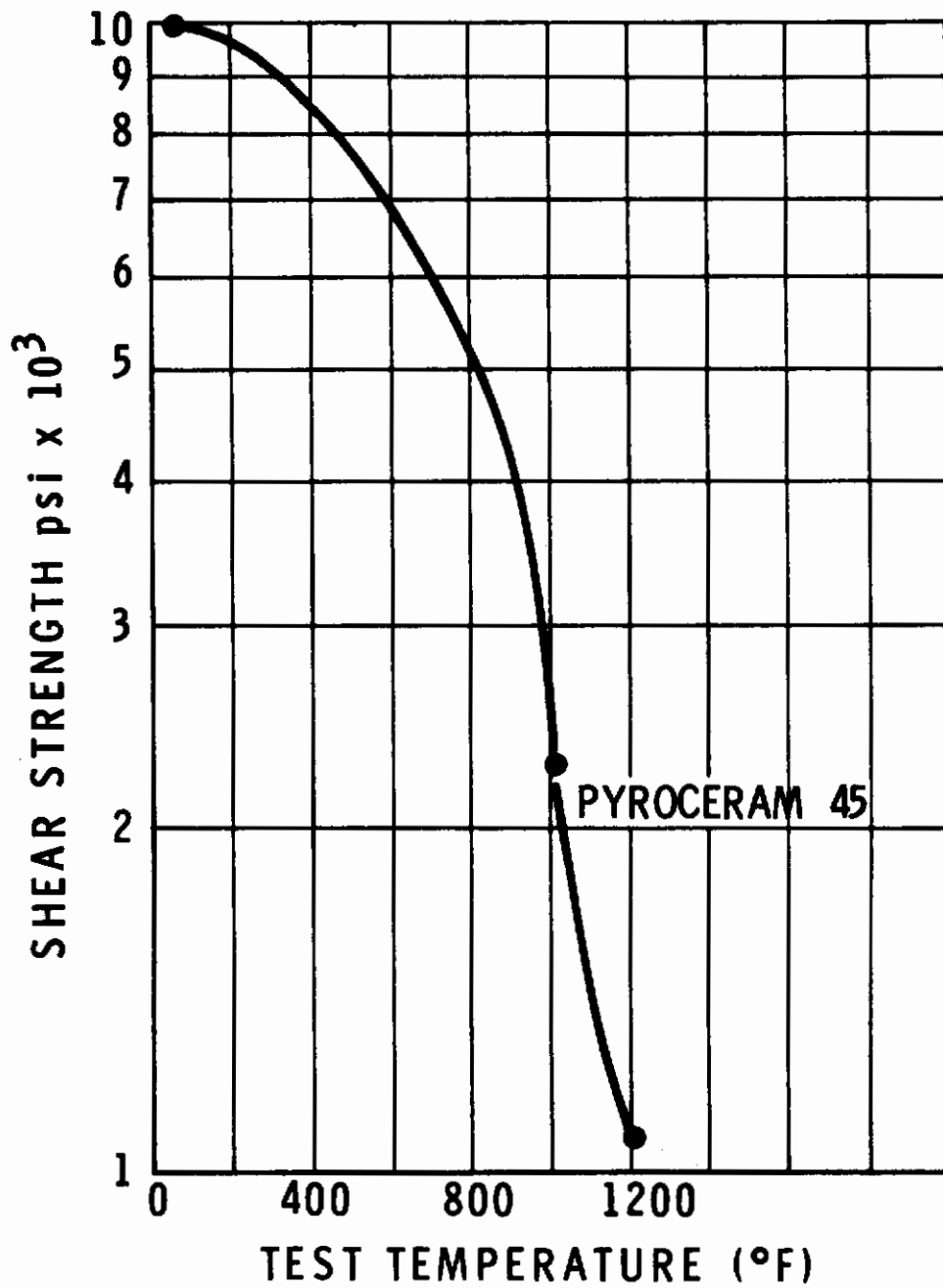

FIG. 30 PYROCERAM 45 CAST ADHESIVE - MEAN COEFFICIENT OF THERMAL EXPANSION VS. TEMPERATURE (FROM RT, 80°F) FILIPPI (REF. 194)



**FIG. 31 SHEAR SPECIMEN CONFIGURATION
FILIPPI (REF. 194)**



**FIG. 32 SHEAR STRENGTH vs. TEMPERATURE -
CERAMIC ADHESIVE
(REF. 194)**

limited primarily to the general discussion of Corning's new family of thin-walled cellular materials trademarked "Cercor" (Ref. 166, 197, 198). This is basically like Pyroceram materials, being made from nonstrategic and ready available raw materials such as glass sand, limestone, soda ash and borax. While a specific composition code 9690 has been found to be good for heat exchanger applications, the composition may be changed to provide a wide range of properties. Specific properties of code 9690 are readily available in Corning trade bulletins.

Howard (Ref. 199) made an experimental investigation to determine the convective heat transfer and flow friction characteristics of four devitrified ceramic (Cercor) heat exchanger surfaces. This study is of practical use, particularly in the design of gas turbine regenerators. Due to the nature of this program, specific information gained as a result of this study is not permitted for publication in the open literature and is therefore only referenced in this report.

Kitaygorodskiy (Ref. 200) of the Soviet Union reported on foam sitalls which can be made in the form of panels with dimensions of width up to 2 meters and length up to 3 or 4 meters, with a thickness of 60 to 200 millimeters. From these foam sitalls it is possible to make sheaths for the insulation of pipes. These foam sitalls can also be reinforced by metallic wire or iron rods. The Soviets do not claim there are any significant applications of sitall materials nor do they provide specific data relating to them.

6. Grinding

A program on the machining of refractory materials was performed by Zlatin, et al. (Ref. 4). Grinding tests only were conducted on the devitrified ceramic (Pyroceram) material since it is not machinable with conventional cutting tools.

A Norton 8 in. by 24 in. Hydraulic Surface Grinder equipped with a 2 hp variable speed spindle drive was used for the grinding

Contrails

tests. The test setup is shown in Figure 33. The effects of grinding conditions on grinding ratio (G) were evaluated. The grinding ratio (G) is a measure of grinding wheel life and is defined as:

$$G = \frac{\text{Volume test material removed}}{\text{Volume wheel removed}}$$

The indicator readings were taken after every 0.025 to 0.050 inch of test material removed up to a total of 0.100 inch. The difference between the initial indicator reading and successive readings was the amount of wheel removed from the wheel radius. The initial outside diameter of the wheel was accurately measured before each test with a vernier caliper. The volume of wheel removed was calculated from initial and final wheel diameter measurements. Grinding ratios were calculated at each 0.025 inch test material removed, and an average taken to arrive at a final G ratio value.

The results of the tests are shown in Figures 34 to 38. The silicon carbide grinding wheels produced better G ratios than aluminum oxide wheels. The best wheel for grinding Pyrocera was found to be GC60JVK (S. C.) (Cincinnati Milling Machine Company grades were tested; other suppliers could provide equivalent wheels) (Ref. 207).

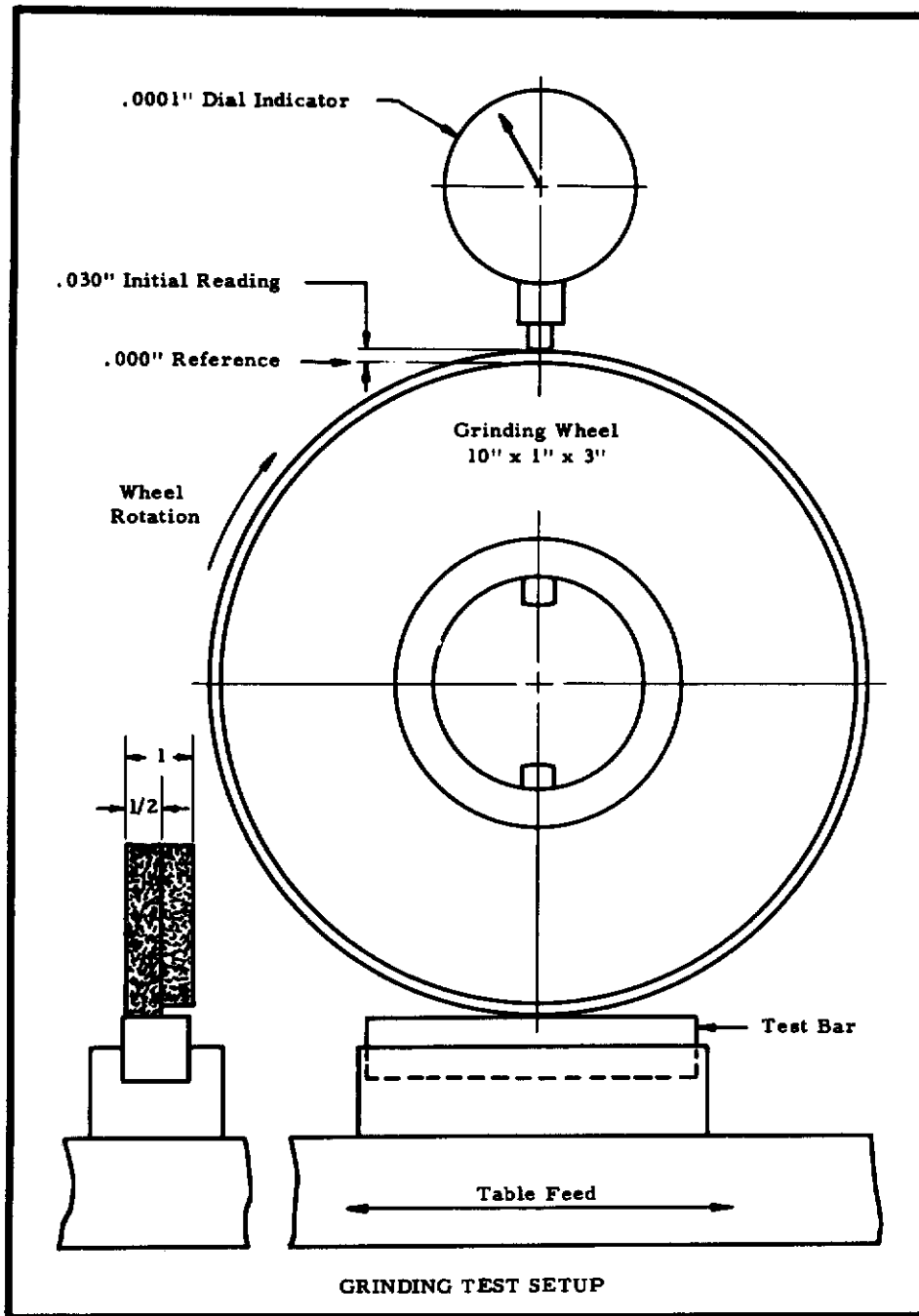

Figure 33 (Ref. 201)

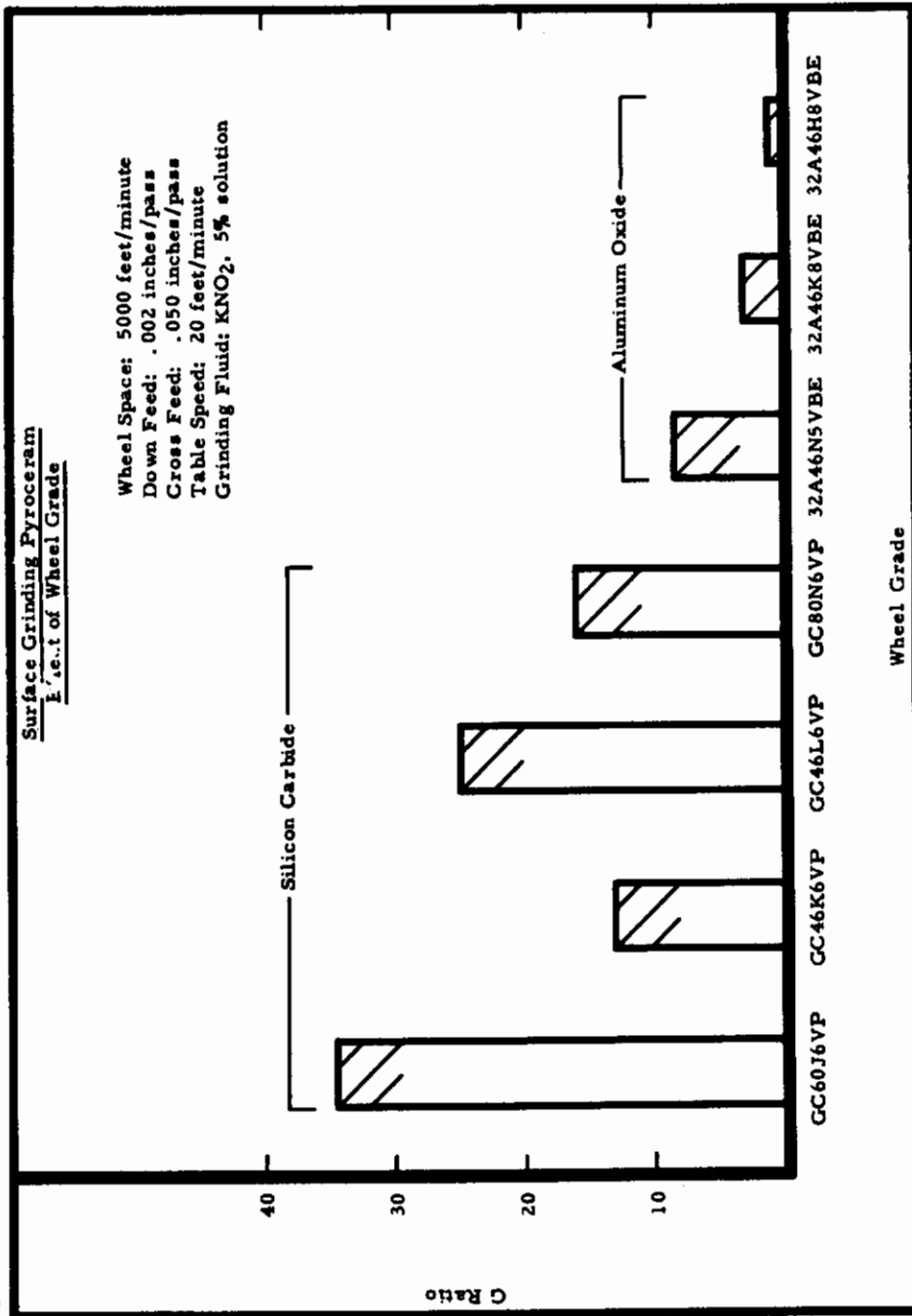

Figure 34 (Ref. 201)

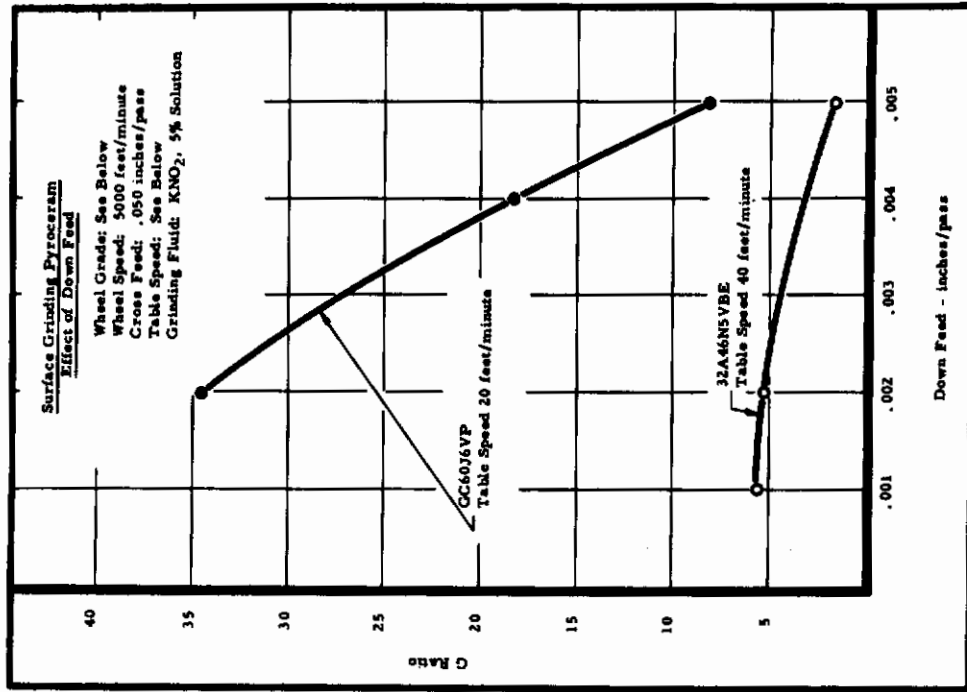

Figure 36 Surface Grinding Pyroceram
Effect of Down Feed (Ref. 201)

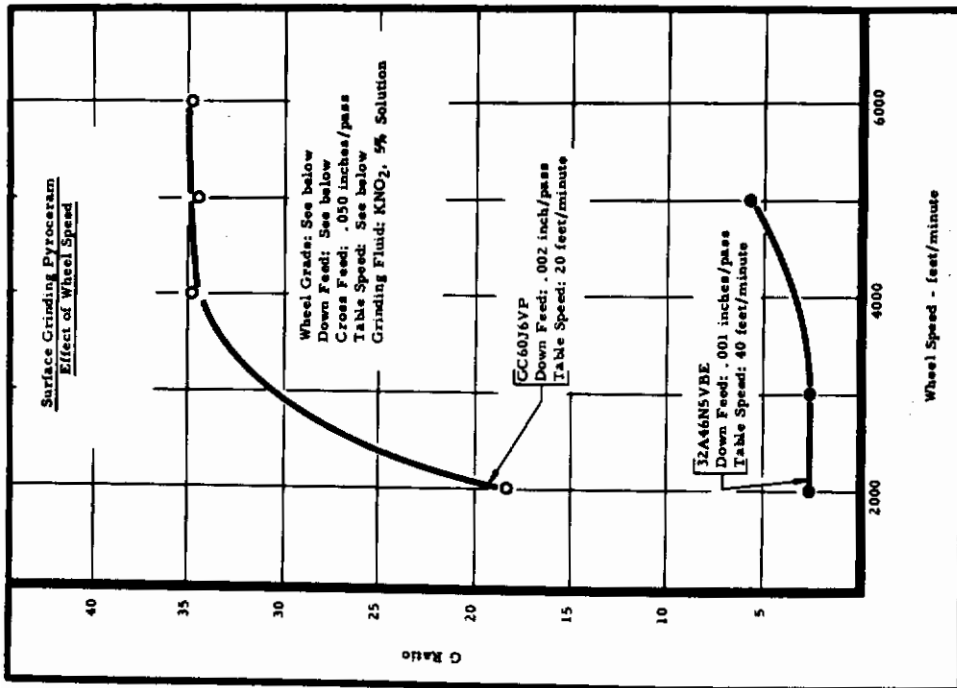

Figure 35 Surface Grinding Pyroceram
Effect of Wheel Speed (Ref. 201)

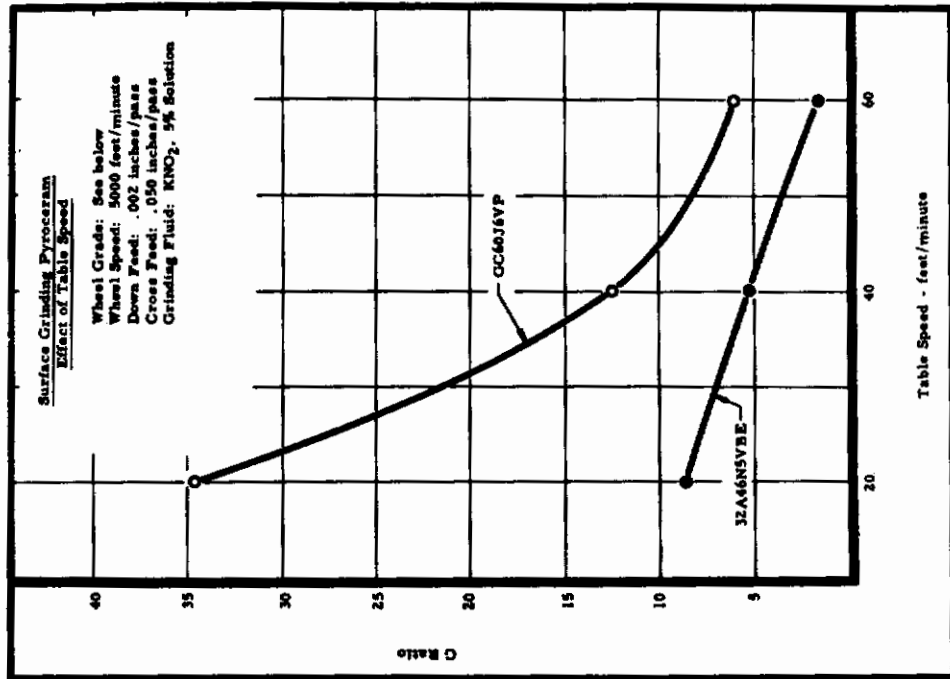

Figure 37 Surface Grinding Pyroceram
Effect of Cross Feed (Ref. 201)

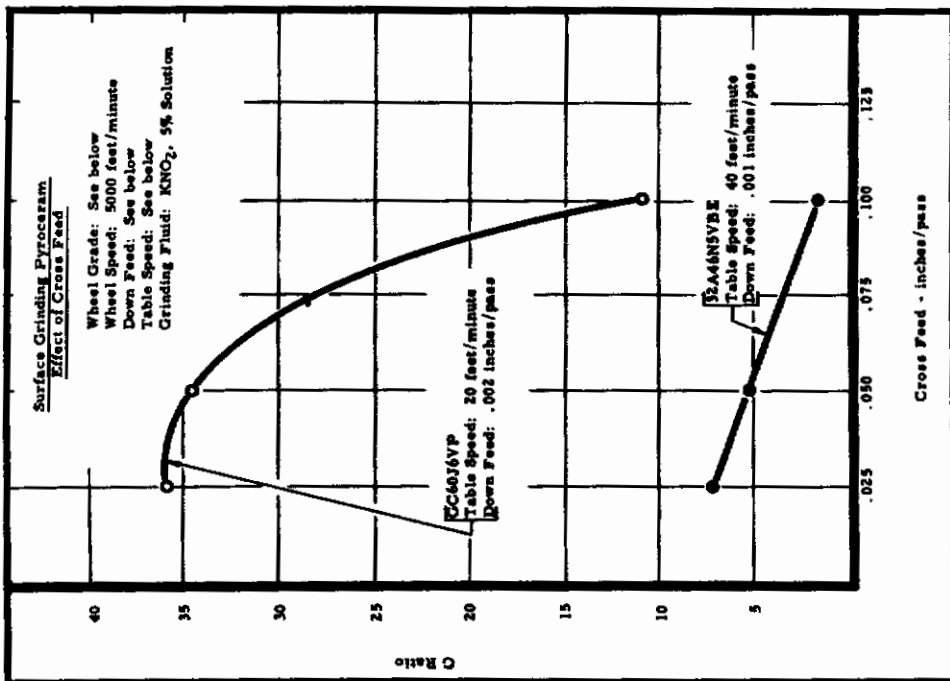

Figure 38 Surface Grinding Pyroceram
Effect of Table Speed (Ref. 201)

V. GENERAL SUMMARY

This literature survey was concerned with the new devitrified ceramics which have become increasingly important to researchers and engineers throughout the world. To distinguish the new devitrified ceramics (glass-ceramics, sitals, vitro-ceramics) from similar processed materials (opal, alabaster and photosensitive glasses) one defines them as predominantly crystalline bodies produced by induced and controlled nucleation and crystallization of preformed glass articles. Today these materials generally contain greater than 80 percent crystals with crystal sizes ranging from 100 A to 1 micron. Devitrified ceramics possess several advantages in that they provide for: ideal polycrystalline structure, diversity of allowable compositions and therefore varied properties, reproducibility and relatively low cost, and ease of production. These devitrified ceramics are produced in the same manner as glass by blowing, rolling, pressing or centrifugal casting which can be used to make almost any size or shape. Hot pressing techniques used in making ceramics also produces ideal polycrystalline structures, but are expensive and limited greatly in rate of production and size.

Devitrified ceramics are limited today by their softening temperature of about 1350°C (2460°F), but the Soviets have reported softening temperatures up to 1500°C (2732°F). Caution should be taken when heating above the nucleation temperature (800°C , 1470°F) since change in crystal structure and therefore properties will occur. Devitrified ceramics are brittle and must be considered as such for design purposes.

A historical review presenting the developments leading to the discovery of devitrified ceramics is provided in this report to further define the materials of importance. This discussion shows that opal glasses, nucleated with gold, silver, copper or platinum have less than 0.1 percent by weight of the nucleating agent present in the initial

Contrails

composition. The new devitrified ceramics, principally those nucleated with TiO_2 or containing metallurgical slags, have the nucleating agent as a major constituent. Also because of the wide range of compositions permitted due to the processing technique these devitrified ceramics show great potential for future use. In comparison to the new devitrified ceramics, photosensitive glasses are limited to composition which can be nucleated by exposure to ultra-violet or X-ray treatment.

Since these materials are produced fundamentally by nucleation and crystal growth phenomenon, a brief discussion on this subject has been provided. A main objective of this discussion was to compile important references on this subject for ready reference use. Nucleation phenomenon is extremely complex, controversial in many aspects, and has been reviewed by other investigators. Such basic problems as determining if a nucleating agent is necessary in new devitrified ceramics is still in question. It appears that nucleators play an important role in providing a high nucleation rate and a low crystal growth rate which is advantageous for these materials. Caution must be taken by the researcher in any case when applying the theory to a practical situation. The principal of controlled nucleation is to separate the crystal growth process from the nucleation process when the glass is at a desired viscosity. If nucleation and crystallization occur simultaneously then the size, shape and number of crystals cannot be controlled and therefore reproduced. In general, the theoretical theories of nucleation are explained by various forms of the Arrhenius equation which relates reaction rate to temperature by the following formula:

$$\text{Reaction Rate} = Ae^{-E/RT}$$

where A is the molecule collision number, generally referred to as the frequency factor, E the activation energy, R the gas constant, and T the absolute temperature.

Contrails

Fundamental studies on devitrified ceramics have shown that properties are primarily dependent on the composition and the heat treatment process occurring after the glass is formed. The basic structure of these materials are generally fine-grained, free from voids (zero porosity), and crystals are randomly oriented, and uniformly distributed. The crystal shape varies with size, going from a spheroidal shape at the earliest stage to sharp angular shapes at sizes greater than 1.0 micron. These research studies clearly show that a serious gap in experimental information exists in relating the effects of structural characteristics (size, shape and number of crystals, principal crystalline phases, changes in glass matrix composition, etc.) to property values. One special area for future work should be to determine what happens to strength and other properties as crystal size decreases from 20 microns to so small that crystal structure is lost. Another area of concern should be to decrease the firing cycle time by increasing the allowable heating and cooling rates to less than 5°C per minute and producing nondeformable bodies with less than 10 hours of total firing time.

A review of the world wide open literature indicates that the USA is the leader in the development of new devitrified ceramics. Like the USA, Japan and Germany are developing quality and reproducible devitrified ceramics. The Soviet Union, however, reports only on their rather crude, but useful construction material called sital. Sitals are a lower quality devitrified ceramic made basically from metallurgical slags. The Soviets are extremely interested in the field of sitallurgy, but no specific data exist on their materials and no mention of mass produced articles is reported.

The state-of-the-art of devitrified ceramics as described in the literature is based on two compositions nucleated with TiO_2 . One of them is a lithium-aluminum-silicate crystallizing out β -spodumene (Pyroceram 9608); the other is a magnesium-aluminum-silicate

crystallizing out α -cordierite (Pyroceram 9606). These materials are composed of four components, TiO_2 , Al_2O_3 , SiO_2 and one or more of the basic metal oxides, Li_2O , BeO , MgO , CaO , ZnO , SrO , CdO , BaO , PbO , MnO , FeO , CoO and NiO , the four components totally preferably 95 weight percent of the composition of which TiO_2 is 2 to 20 percent. It is easily deduced that many different materials could possibly be derived from combinations of these oxides, leaving a wide area of potential properties. It is important to realize that in the development of these materials the crystal growth range should remain below the liquidus of the predominant crystalline phase or else dissolution of the phase will result. Other nucleating agents such as SnO_2 , ZrO_2 and metallic phosphates have been used successfully on experimental materials.

In general, devitrified ceramics are processed by first forming as a glass then cooling rapidly below the nucleation temperature and reheating by time-temperature schedules through the nucleation and crystal growth ranges. The TiO_2 -nucleated devitrified ceramics are melted at about 1600°C (2910°F); nucleation temperature is about 800°C (1470°F) and crystal growth temperature is about 1200°C (2190°F).

Information concerning specific tests or applications of devitrified ceramics is limited primarily to periodicals or government reports. The periodical references are rather general and are therefore usually only referenced in this report. The government reports generally provide some detail and are discussed briefly. The two materials Pyroceram 9606 and 9608 are somewhat diversified in their applications in that Pyroceram 9606 has been used successfully as a radome material for the Gar XI, Phoenix, Shrike, Tartar, Terrier, Typhon, Gar IX, Genie and Sera missiles. A recent report by Melpar (Ref. 173) compares the properties of Pyroceram 9606 with various other ceramic materials for use as a radome material. A

Contrails

oxygen-hydrogen rocket motor exhaust test simulating a heat flux (140 Btu/ft² sec) of a Mach 4 to 5 cruise vehicle showed that the temperature gradient of a 1/2 inch thick sample of Pyroceram 9606 was 1000° F at a 600° F rocket motor wall temperature and 675° F at 1400° F wall temperature. The value for Pyroceram was midway between the higher values for slip-cast fused silica and the lower values for Al₂O₃. This same devitrified ceramic was studied for use as an electromagnetic window material on hypersonic vehicles having intercontinental ballistic missile trajectory and was found to be feasible only if the heat flux across the surface was reduced considerably. Pyroceram 9606 has also been recommended for future study as an electron tube envelop material. This was based on its permeability to helium at elevated temperatures (800° C) being superior to Vycor glass, fused silica or Pyrex glass, and also because it closely matches the coefficient of expansion of tungsten, molybdenum, kovar, titanium, stainless steel 430 and nickel.

Pyroceram 9608 is mass produced today in the form of various cooking ware items. Its opaque glossy white appearance makes it attractive and its low expansion (β -spodumene) allows for thermal shock resistance for everyday cooking purposes. The limiting factor for temperature difference allowed when rapidly cooling these materials is the nucleation temperature. Therefore Pyrocerams can be thermal shocked from about 1400° F to cold water without failure. Pyroceram 9608 was found to be useful in low load, short duration (up to two hours) ball bearing applications with operating temperatures of 1000° F to 1400° F. Effective lubricants for Pyroceram bearings remain a problem, but the gas, dibromotetrafluoroethane (CF₂Br-CF₂Br), is an effective lubricant for Pyroceram 9608 sliding on Hastelloy R-235 and Inconel X up to 1400° F. The gas dichlorotetrafluoroethane (CF₂Cl-CF₂Cl) is an effective lubricant for Pyroceram 9608 sliding on various cobalt-base alloys at 1000° F. Because the strength to

weight ratio of Pyroceram 9608 (1.15) is about the same as fused quartz (1.00) and slip-cast silica (1.15), and better than the metals, magnesium (0.81), aluminum (0.80), or titanium (0.80), it has been made into sandwich construction material for use as a light weight reflecting optical element.

Handbook properties of Pyroceram 9606 and 9608 are provided in Appendix III of this report.

Devitrified ceramics are also available in the form of coatings (Nucerite), adhesives and cellular (Cercor) materials. Relatively speaking, little effort has been directed to these types of devitrified ceramics and therefore wide areas for future development remains. The coatings to date have been applied primarily to nonrefractory base metals such as low carbon steels, stainless steels, Hastelloy and Inconel. Their maximum service temperature is 1500° F. They show improved abrasion, impact and thermal shock resistance over standard glass type coatings. Devitrified ceramics coatings are more complex than standard glass coatings in that they require control of crystallization, and therefore processing techniques are necessarily more precise.

Extensive studies have been made concerning devitrified ceramic adhesives, but reported data is extremely limited. In general, they appear to provide higher bonding strengths than glassy adhesives at the higher temperatures (1000° F). It was determined that Pyroceram No. 45 adhesive was the most satisfactory available adhesive for bonding segments of alumina, and it wets the surface of beryllia and zirconia. This particular adhesive showed a decrease in shear strength from 10,000 psi at room temperature to about 1000 psi at 1200° F.

The open literature information on cellular devitrified ceramics is limited to brochure data on Corning "Cercor" material and general discussion of the Soviet's work on foam sitals.

Contrails

Grinding experiments on Pyroceram showed that silicon carbide wheels have a better grinding wheel life than aluminum oxide wheels.

Satisfactory methods for polishing, etching and making replicas are presented in this report.

It is important to realize that the new devitrified ceramics are a large family of materials and can be developed to possess specific properties. Large gaps of unexplored compositions and processing techniques exist in the new technology. Important information concerning these materials is presently of a proprietary or security classification and therefore the open literature provides one with limited coverage.

REFERENCES

1. Stookey, S. D. "Ceramics Made by Nucleation of Glass - Comparison of Microstructure and Properties with Sintered Ceramics." Proceedings of American Ceramic Society Symposium on Nucleation and Crystallization in Glasses and Melts. 1962. pp. 1-4.
2. Stookey, S. D. "Method of Making Ceramics and Product Thereof." U. S. Patent 2,920,971. January 12, 1960.
3. Dikhtyar, A. "Sital, A Rival for Metal." FTD-TT-63-54. Foreign Technology Division, Wright-Patterson Air Force Base, Ohio. February 4, 1963.
4. Zlatin, N., Field, M., and Gould, J. V. Machining of Refractory Materials. ASD-TDR-63-581. Aeronautical Systems Division, Wright-Patterson Air Force Base, Ohio. July 1963. Metcut Research Associates, Inc. Contract AF 33(600)-42349.
5. Reaumur, M. Memoires de L'Academie des Sciences. Paris, France. 1939. pp. 370-88.
6. Ownby, D. P. "A Preliminary Study of the Effect of Heat Treatment on the Strength and Microstructure of A Glass-Ceramic Material." Master of Science Thesis. School of Mines and Metallurgy, University of Missouri, Rolla, Missouri. 1962.
7. Albrecht, F. New Hard Materials (Refractories) Made of Glass. Examples of Applied Research Published by the Fraunhofer Society for the Furthering of Science Muenchen, 1955. (Neuartige Hartstoffe Aus Glass).
8. Bondarev, K. T. Microcrystalline Materials on a Glass Basis, Their Properties and Fields of Application. FTD-TT-63-269. Foreign Technology Division, Wright-Patterson Air Force Base, Ohio. May 1963.
9. Hinz, W. Glass Ceramics (Vitrokeram) Technology of Silicates. No. 3. German Academy of Sciences. German Translation. 1959. pp. 119-122.
10. Lungue N. St., and Popescu-Has. Manufacture of Ceramics From Finely Crystallized Glass, Industria Usoara 2. 1958.

Contrails

11. Rindone, G. E. "Influence of Platinum Nucleation on Crystallization of a Lithium Silicate Glass." Journal of American Ceramic Society. 41. 1958.
12. Stookey, S. D. "Photosensitive Glass-A New Photographic Medium." Industrial and Engineering Chemistry. Vol 41. No. 4. April 1949.
13. Stookey, S. D. "Chemical Machining of Photosensitive Glass." Industrial and Engineering Chemistry. Vol 45. January 1953. 1. 115.
14. Stookey, S. D. "Recent Developments in Radiation-Sensitive Glasses." Industrial and Engineering Chemistry. Vol 46. No. 1. January 1954.
15. Dalton, R. H. (To Corning Glass Works). U. S. Patent 2,326,012. August 27, 1945.
16. Dalton, R. H. U. S. Patent 2,422,472. June 17, 1947.
17. Stookey, S. D. (To Corning Glass Works). Can. Patent 442,273. June 17, 1947.
18. Stookey, S. D. Patent 444,616. October 21, 1947.
19. Armistead, W. H. (To Corning Glass Works). Can. Patent 442,272. June 17, 1947.
20. Mauer, R. D. "Nucleus Formation and Growth of Crystals in Light-Sensitive Glass." J. Applied Physics. 29, 1. 1958.
21. Stookey, S. D. "Theory and Practice of Catalytically Excited Crystallization in Glass." Glass Technology Reports. 32. 1959.
22. Lillie, H. R. "Ceramic Materials Produced from Glass." Glass Technology. Vol 1. No. 3. June 1960. pp. 115-120.
23. Stookey, S. D. U. S. Patents 2,515,940 and 2,515,941.
24. Hinz, W. and Wihsmann, F. "On 'Cordierite' Products from Glass." Silikat Technik. 1959. Vol 10. No. 8. p. 408.
25. Hinz, W. and Baiburt, L. "Glass-Ceramic Products From the $MgO \cdot Al_2O_3 \cdot SiO_2$ System with TiO_2 Additions." Silikat Technik. 1960. No. 10. pp. 455-459.

Contrails

26. Levin, E. McMurdie, H., and Hall, F. Phase Diagrams for Ceramists. Part I, 1956. Part II, 1959. Published by American Ceramic Society, Columbus, Ohio.
27. Tanigawa, H. and Tanaka, H. "Crystallization of Some Glasses in the System $\text{SiO}_2 \cdot \text{Al}_2\text{O}_3 \cdot \text{MnO} \cdot \text{Li}_2\text{O}$ by Addition of SnO_2 ." Osaka Kogyo Gijutsy Shikensho Kihō. 13(7), 183. 1962.
28. Tashiro, M. and Wada, Masamich. "Glass-Ceramics Catalyzed with Zirconia." Institute for Chemical Research, Kyoto University, Japan. Advances in Glass Technology, Part 2. Edited by F. R. Matson and G. E. Rindone. (Appendix 1) Plenum Press, New York. 1963.
29. Stookey, S. D. "Glass Ceramics." Chemical and Engineering News. June 19, 1961. pp. 116-125.
30. Bezborodov, M. A. and Kripsky, A. M. "Methods for Investigating the Glass Crystalline Structure." Sb. mauchn. tr. Belorussk. politekhn. in-t. 1960. No. 82. pp. 3-15.
31. Bonetti, G. "Application of DTA for Studying Devitrification." Staz. Sperimentale del Vetro, Murand. Sprechsaal. 96, 97 (1963).
32. Kitaygorodsky, I. I. and Bondarev, K. T. "New Glass Crystal Materials Made from Slag." Priroda. (Nature). Moscow. 1962. No. 9.
33. "USSR Crystalline Glass Held Stronger Than Glass." Metal Working News. July 16, 1962.
34. "Soviet Produces Tough Glass." The New York Times. October 11, 1959. p. 5.
35. "Glass Material Has Versatility." The Washington Post. October 11, 1959.
36. "Pyroceram." Promyshlennost Armenii. (Poland). December 1962. p. 68.
37. Promyshlenno. "Harder Than Steel Lighter Than Aluminum." Ekonomicheskaya Gazeta. March 6, 1959. FTD-TT-62-1910. Foreign Technology Division, Wright-Patterson Air Force Base, Ohio. March 4, 1963.

Contrails

38. Zhavoronkov, N. M. "Chemistry and the Establishment of Material and Technical Bases for Communism." Khimiches Kayo Promyshlennost. No. 10. 1961. pp. 1-7.
39. Toropoy, N. A. "Tasks of Soviet Inorganic Chemistry in the Light of the Resolutions of the XXII Party Congress of the CPSU. Current Problems of Modern Theoretical and Experimental Silicate Chemistry." Zhurual neorganicheskoy Khimii. V. 7. No. 3. 1962. pp. 452-453.
40. Vavilov, V. "Green Light to Sitalls Made from Slags." Ekonomicheskaya Gazeta. December 11, 1961, p. 19. FTD-TT-63-60, Foreign Technology Division, Wright-Patterson Air Force Base, Ohio. "Sital From Slags-A Path into Life." April 25, 1963.
41. Locsei, B. P. "Acid Resistance of Vitroceramic Materials on a Feldspar-Diopside Base." Proceedings of American Ceramic Society Symposium on Nucleation and Crystallization in Glasses and Melts. 1962. pp. 71-74.
42. Sorkin, Y. S. and Vaysfel'd, N. M. "Structural Changes in Certain Glasses on Sitalization." AN SSR. Doklady. Vol 151. No. 3. 1963. pp. 628-630.
43. Mashkovich, M. D. "Dielectric Losses and the Dielectric Constant of Sitals." Fizika tverdogo tela. Vol 5. No. 3. March 1963. pp. 843-849.
44. "Stronger Than Steel." Thud. October 13, 1962. p. 4, columns 1-3.
45. Tammann, G. "Glasses as Supercooled Liquids." Journal Society Glass Technology. 9:166. 1925.
46. Kingery, W. D. Introduction to Ceramics. John Wiley and Sons, Inc., New York. 1960.
47. Shannon, R. D. and Friedberg, A. L. "Titania Opacified Porcelain Enamels." University of Illinois Engineering Experiment Station, Bulletin No. 456. 1960.
48. Friedberg, Arthur L. "Crystallization in Ceramics." Thesis Ph.D, in Ceramic Engineering. University of Illinois. 1952.
49. Van Hook, A. Crystallization-Theory and Practice. Reinhold Publishing Corp., New York. 1961.

Contrails

50. Blau, H. H. "Diffusing Glasses." U. S. Patent 2,132,390. 1938; "Trouble Shooting and Glass Research." Ceramic Bulletin. Vol 41, No. 5. 1962.
51. Blau, H. H. "Diffusing Glasses for Illumination." Industrial and Engineering Chemistry. Vol 25. August 1933.
52. Parmelee, C. W. Ceramic Glazes. Industrial Publications, Inc., Chicago, Illinois. 1951. pp. 114-122.
53. Stookey, S. D. and Kingery, W. D. Ceramic Fabrication Processes. John Wiley and Sons, Inc. New York. 1960.
54. Stookey, S. D. and Maurer, R. D. "Catalyzed Crystallization of Glass-Theory and Practice." Progress in Ceramic Science. Edited by J. E. Burke. Pergamon Press, New York. Vol 2. 1962. p. 77.
55. Kleber, W. "Nucleation and Crystal Growth in Glass." Silikat Technik. Vol 13. No. 1. January 1962. pp. 5-10.
56. Berezhnoy, A. I. Light-Sensitive Glass and Crystalline Glass Materials of the "Pyroceram" Type. Edited by Professor I. I. Kitoygurodskiy. Moscow Publishing House of the All-Union Institute of Scientific and Technical Information of the Academy of Sciences U.S.S.R. 1960.
57. Robredo, J. "Glass-Ceramic Materials." Verres et. Refract. 16. (4). 225, 1962.
58. Lambertson, Aiken, and Girard. Continuous Filament Ceramic Fibers. "Appendix II" by King, B. W. WADD TR 60-244. Wright Air Development Division, Wright-Patterson Air Force Base, Ohio. 1960. pp. 65-76.
59. Proceedings of Symposium on Nucleation and Crystallization in Glasses and Melts. Edited by Margie K. Reser, Geraldine Smith and Herman Insley. American Ceramic Society, Columbus 14, Ohio. 1962. pp. 123.
60. Mellor, J. W. Clay and Pottery Ind. Griffin and Co. London. 1914. p. 49.
61. Norton, F. D. "The Control of Crystalline Glazes." Journal American Ceramic Society. 20:217. 1937.

Contrails

62. Zsigmondy, R. Colloids and the Ultramicroscope Trans. Edited by J. Alexander. John Wiley and Sons, Inc., New York. 1914.
63. Silverman, A. "Colloids in Glass." Colloid Chemistry. Vol III. Edited by J. Alexander. Chemical Catalog Co., New York. 1931.
64. Wright, F. E. The Manufacture of Optical Glass and Optical Systems. U. S. Printing Office, Washington, D. C. 1921. p. 85.
65. "Nucleation Phenomena." Proceedings of Symposium on Theory and Practice of Nucleation from Gases, Liquids, and Solids. Includes 17 papers with bibliographies. Published in J. Ind. Eng. Chem. 44. June 1952. pp. 1269-1338.
66. Brown, S. D. "The Devitrification of High-Temperature Glass." Thesis, Department of Chemical Engineering, University of Utah. August 1957. p. 61-75.
67. Gibbs, J. W. Collected Works. Vol I. Longmans, Green and Co., New York. 1948. p. 94.
68. Thompson, J. J. Applications of Dynamics to Physics and Chemistry. MacMillan Co., London. 1888. p. 162-175.
69. Volmer, Max. Kinetik der Phasenbildung. T. Stein, Dresden, Germany. 1934.
70. Becker, R. and Doering, W. "The Kinetic Treatment of Nuclear Formation in Supersaturated Vapors." Ann. Physik 24 (5) 719-52. 1935.
71. Frankel, J. Kinetic Theory of Liquids. Clarendon Press, Oxford. 1946.
72. Turnbull, D. and Fisher, J. C. "Rate of Nucleation in Condensed Systems." J. Chem. Phys. 17. 1949. pp. 71-73.
73. Brown, S. D. loc. cit. pp. 75-138.
74. Brown, S. D. and Kistler, S. S. "The Devitrification of High SiO_2 Glasses of the System $\text{Al}_2\text{O}_3 \cdot \text{SiO}_2$." External publication No. 459. Jet Propulsion Laboratory, California Institute of Technology. March 21, 1958.
75. Richards, W. T. "Formation and Crystallization of Vitreous Media." Journal Chem. Physics 4. 1936. pp. 449-57.

76. Leont'eva, A. A. "Relation Between Linear Spread of Crystallization and Viscosity of $\text{Na}_2\text{O} \cdot \text{SiO}_2$ Glasses." Acto Physiochim Union Soviet Socialist Republic 14. 245-6. 1941. Chem Abs. 25 1 (5). 1946.
77. Swift, H. R. Private Communication with B. W. King, Battelle Memorial Institute.
78. Preston, Eric. "Crystallization in Silicate Slags and Glasses." Trans. Faraday Soc. 37 (4). 1941. pp. 209-20.
79. Takayanagi, M. and Yamashita, T. "Growth Rate and Structure of Spheculite in Fractionated Poly (Ethylene Aclipate)." Journal Polymer Sci. 22. 1956. pp. 552.
80. Cox, S. M. and Kirby, P. L. "Rate of Crystal Growth in Glass." Nature 159. 1947. pp. 162-3.
81. Turnbull, D. "Thermodynamics in Physical Metallurgy." American Society for Metals. Cleveland, Ohio. 1950.
82. Vogel, W. "Directed Crystallization of Glasses." Presented at VI Conference of the Silicate Industry, Budapest, 1961. Abstract in Physics and Chemistry of Glasses. Vol 4, No. 3. June 1963.
83. Neuhaus, A. "Orientierte Substanzabscheidung (Epitaxie)." Fortschr d. Mineral. 29/30. 1950/51. pp. 136-296.
84. Bauer, E. "Phanomenologische Theorie der Kristallabscheidung an Oberflacher I u II." Ztschr. f. Kristallogr 110. 1958. pp. 372-394.
85. Fleber, W. "Problems der orientierten Kristallisation." Forschen und Wirken "Band II" VEB Deutscher Verbg der Wissenschaften, Berlin. 1960. pp. 271-289.
86. Mauer, R. D. "Crystallization of a Titania-Nucleated Glass." Proceedings of American Ceramic Society Symposium on Nucleation and Crystallization in Glasses and Melts. 1962. p. 5.
87. Vogel, W. and Gerth, K. "Catalyzed Crystallization in Glass." loc. cit. p. 11.
88. Anderson, R. C. and Friedberg, A. L. "Crystallization of Lead Metaniobate from a Glass." loc. cit. p. 29.

Contrails

89. Roy, R. "Phase Equilibria and the Crystallization of Glass." loc. cit. p. 39.
90. Ohlberg, S. M., Golob, H. R. and Strickler, D. W. "Crystal Nucleation by Glass in Glass Separation." loc. cit. p. 55.
91. Westman, A. E. R. and Murty, M. K. "Kinetics of Reorganization, Nucleation, and Crystallization in Sodium Phosphate Glasses: I, Sodium Metaphosphate Glass." loc. cit. p. 91.
92. Rindone, G. E. "Crystal Orientation as Influenced by Platinum Nucleation." loc. cit. p. 91.
93. Hillig, W. B. "A Theoretical and Experimental Investigation of Nucleation Leading to Uniform Crystallization of Glass." loc. cit. p. 77.
94. Matson, F. and Rindone, G. Advances in Glass Technology Part 2. Plenum Press, New York. 1963. p. 147.
95. Stookey, S. D. "Catalyzed Crystallization of Glass in Theory and Practice." Industry and Engineering Chemistry. Vol 51. July 1959. pp. 805-8.
96. "Progress in Pyroceram; New Material for High Temperature Bearings." Machine Design. Vol 31. August 20, 1959. pp. 29-32.
97. Munier, J. H. "Ceramics From Glass Co. Commercial." Product Engineer. March 17, 1958. pp. 87-89.
98. "Pyroceram-A New Family of Glass Ceramics." SAE Journal. July 1958. pp. 34-36.
99. Materials In Design Engineering. 48 (1). July 1958. pp. 126-128.
100. American Ceramic Society Bulletin. Vol 36, No. 7. 1957.
101. McLellan, George W. "Glass-Ceramics Promises Varied Uses." SAE Journal. June 1959. p. 99.
102. Stookey, S. D. "Glass Ceramics." Mechanical Engineering. Vol 82. October 1960. pp. 65-8.
103. "Pyroceram Mirrors in Airborne Telescopes." Materials in Design Engineering. Vol 50. December 1959. p. 196.

Contrails

104. "High Strength in Crystalline Material." Electrical Engineering. Vol 77. June 1958. pp. 566-7.
105. "New Material Combines Virtues of Metals and Ceramics." Iron Age. Vol 181. March 6, 1958. pp. 126-7.
106. Stookey, S. D. "Pyroceram: A Family of Crystalline Materials Made From Glass." Abstract. Glass Industry. Vol 38. December 1957. pp. 685-6.
107. "Pyroceram Nose Cones." Aircraft and Missiles Manufacturing. August 1958. pp. 12-15.
108. "Pyroceram: Claim Unique Properties for Family of Basic Materials." Ceramic Industry. Vol 69. No. 1. July 1957. pp. 72-73.
109. Stookey, S. D. International Science and Technology. July 1962. pp. 40-46.
110. "Pyroceram: A Strong New Ceramic." Materials in Design Engineering. Vol 46. July 1957. p. 142.
111. "New Material Combines Virtue of Metals and Ceramics." Iron Age. Vol 179. (58). June 1957. pp. 126-127.
112. Electronics. Vol 30-39. June 10, 1957.
113. "Glass With a Plus." Business Week. June 8, 1957. p. 202.
114. "Glass Gets a New Look." Chemical and Engineering News. Vol 35. June 3, 1957. p. 94.
115. "Glass Takes a Tough New Personality." Chemical Week. Vol 80. June 8, 1957. pp. 64-66.
116. "New Glass Material May Offer Competition in Some Metal Uses." Iron and Steel Engineer. Vol 34. June 1957. p. 191.
117. "Develops New Glass." Steel. Vol 140. June 3, 1957. p. 55.
118. Diagrams Arch Forum. Vol 107. July 1957. pp. 160-2.
119. "New Basic Material For High Temperature." Electronic Industry and Tele-Tech. Vol 16. July 1957. p. 5.

Contrails

120. "Pyroceram-The Corning Giant." Chemical Engineering Progress. Vol 53. Sup. 80. July 1957.
121. "Pyroceram." Mechanical Engineering. Vol 79. July 1957. pp. 662-3.
122. "Glass Sires Richly Endowed Hybrid." Chemical Engineering. Vol 64. August 1957. p. 64.
123. "Crystalline Material Harder Than Ceramics or Metals." Electrical Engineering. Vol 76. August 1957. p. 755.
124. "Nonporous Crystalline Materials Made From Glass." Machinery. Vol 63. August 1957. p. 171.
125. "A New Super Glass." Petroleum Engineer. Vol 29. August 1957. p. 78.
126. "Ceramics Made From Glass Promise Dry Bearings and High Strength." Engineering. August 14, 1959. p. 41.
127. Watanabe, W. and Moriya, T. "A Consideration on Relation Between Mechanical Behavior of Glasses and Their Internal Structure." Rev. Elect. Common Lab. 9(1 and 2). 1961. pp. 50-71.
128. Phillips, C. H. Glass-Its Industrial Applications. Reinhold Publishing Corp., New York. 1960. pp. 252.
129. Moriya, T. "The Constitution of Glass." J. Japanese Ceramic Association. 55 and 56. (1947 and 1948). pp. 4, 60, 87 and 134.
130. Watanabe, M., Hoake, H. and Aiba, T. "Electron Micrographs of Some Borosilicate Glasses and Their Internal Structure." Journal American Ceramic Society. 42 (12). 1959. pp. 593-599.
131. Greig, J. W. "Immiscibility in Silicate Melts, I-II." Ceramic Abstracts. 6 (4). 1927. p. 157.
132. Ohlberg, S. M., Golob, H. R. and Hollabaugh, C. M. "Fractography of Glasses Evidencing Liquid-in-Liquid Colloidal Immiscibility." Journal American Ceramic Society. 45 (1). 1962. pp. 1-4.

Contrails

133. Spriggs, R. M. and Vasilos, T. American Ceramic Society Bulletin 40. 1961. p. 187.
134. Kingery, W. D. and Coble, R. L. "Mechanical Behavior of Crystalline Solids." Proceedings of American Ceramic Society Symposium. New York City. April 1962. U. S. Department of Commerce, National Bureau of Standards NBS Monograph No. 59. pp. 103-113.
135. Duckworth, W. H. and Rudnick, A. Symposium Design with Brittle Materials. Materials Advisory Board Report No. 175-M, Washington, D. C. 1961.
136. Knudsen, F. P. Journal American Ceramic Society 45. 1962. p. 94.
137. Knudsen, F. P., Parker, H. S. and Burdick, D. Journal American Ceramic Society. 43. 1960. p. 641.
138. Sakka, S., Wada, M., and Tashiro, M. "Effects of Heat Treatment on the Strength of Polycrystalline Material Produced from Glass of the System $\text{Li}_2\text{O} \cdot \text{MgO} \cdot \text{Al}_2\text{O}_3 \cdot \text{SiO}_2$." Yogyo Kyokai Shi. 69 (782) 35-43 (1961); Abstract, Journal American Ceramic Society. 45 (5) 137, June 1962.
139. Watanabe, M., Caporali, R. V., and Mould, R. E. "The Effect of Heat Treatment on the Strength and Abrasion Resistance of a Glass-Ceramic Material." Proceedings of American Ceramic Society Symposium on Nucleation and Crystallization in Glasses and Melts. 1962.
140. Watanabe, W., Caporali, R. V., and Mould, R. E. "The Effect of Chemical Composition on the Strength and Static Fatigue of Soda-Lime Glass." Physics and Chemistry of Glasses. 2 (1) 1961. pp. 12-23.
141. Mould, R. E. and Southwick, R. D. "Strength and Static Fatigue of Abraded Glass Under Controlled Ambient Conditions, I. General Concepts and Apparatus." Journal American Ceramic Society 42. (11). 1959. pp. 542-47.
142. Mould, R. E. and Southwick, R. D. "Strength and Static Fatigue of Abraded Glass Under Controlled Ambient Conditions, II. Effect of Various Abrasions and the Universal Fatigue Curve." Journal American Ceramic Society. 42. (12). 1959. pp. 582-592.

Contrails

143. Mould, R. E. "Strength and Static Fatigue of Abraded Glass Under Controlled Ambient Conditions, III. Aging of Fresh Abrasions." Journal American Ceramic Society. 43. (3). 1960. pp. 160-167.
144. Mould, R. E. "Strength and Static Fatigue of Abraded Glass Under Controlled Ambient Conditions, IV. Effect of Surrounding Medium." Journal American Ceramic Society. 44. (10). 1961. pp. 481-491.
145. Stookey, S. D. "Method of Making Ceramics and Product Thereof." Japanese Patent SHOWA 32-5080. 1957.
146. Tashiro, M., Sakka, S., and Wada, M. "Mechanical Strength of Polycrystalline Materials Produced from Platinum Containing Glasses." Journal Ceramic Society Japan. 68. (778). 1960. Abstract, Physics and Chemistry of Glasses. Society of Glass Technology. April 3, 1962.
147. Tashiro, M. and Maki, T. "Effects of Addition of Lithia Containing Glasses on the Properties of Lithia Ceramics. Studies on the Thermal Shock Resisting Ceramics of $\text{Li}_2\text{O} \cdot \text{Al}_2\text{O}_3 \cdot \text{SiO}_2$ System." Yogyo Kyokai Shi. 70. 8. 1962.
148. X-Ray Powder Data File. American Society for Testing Materials. Philadelphia 3, Pennsylvania. 1960.
149. Donnay, J. D. H. and Nowack, W. "Crystal Data." Geological Society of America. New York, New York. April 1954.
150. Kraus, E., Hunt, W., and Ramsdell, L. Mineralogy. Fourth Edition. McGraw-Hill Book Co., Inc., New York. 1951.
151. Goldsmith, A., Hirschhorn, H., and Waterman, T. Thermophysical Properties of Solid Materials. Volume III Ceramics. WADC Wright Air Development Center, Wright-Patterson Air Force Base, Ohio. November 1960.
152. "Raw Materials Issue." Ceramic Industry. January 1964.
153. Roy, R. and White, W. B., "Recent Data on High Temperature High Pressure Phase Transformations." (In Advance Papers) Proceedings of Symposium on High Temperature Technology. (Asiolmar Conference) September 1963. pp. 212, 227.
154. Isaacs, T. and Roy, R. "The α - β Inversions in Eucryptite and Spodumene." College of Mineral Industries, The

Contrails

Pennsylvania State University. Geochimica et Cosmochimica Acta. Pergamon Press Ltd. Printed in Northern Ireland. 1958. Vol 15. pp. 213-217.

155. Bush, E. A. and Hummel, F. A. "High-Temperature Mechanical Properties of Ceramic Materials: II, Beta-Eucryptite." Journal American Ceramic Society. August 1959. pp. 388-391.
156. Buessem, W. R. and McKinstry. "Anisotropy and Strength of Ceramic Bodies." AD289560 and AD288273 Contract Number Nonr-656(27). Department of Defense Documentation Center, Cameron Station, Bldg. 5, 5010 Duke Street, Alexandria, Virginia, 22314.
157. Roy, R., Roy, D., and Osborn, E. F. "Compositional and Stability Relationships Among the Lithium Aluminosilicates, Eucryptite, Spodumene and Petalite." Journal American Ceramic Society. 33. pp. 152-160.
158. Gillery, Fitti and Bush, E. A. "Thermal Contraction of β -Eucryptite by X-Ray and Dilatometer Methods." Journal American Ceramic Society. 42. 1959. pp. 175-177.
159. Hummel, F. A. "Thermal Expansion Properties of Some Synthetic Minerals." Journal American Ceramic Society. 34. 1951. pp. 235-239.
160. Winkler, H. G. F. "Synthese and Kristallstruktur des Eukryptits, LiAlSiO_4 ." Acta Cryst, Camb. 1. 27-34. 1948.
161. Baum, Wilhelm. "Development of Eucryptite Glass Ceramics of Great Mechanical and Thermal Strength. Investigation of Mechanical, Thermal, and Electric Properties as Functions of Devitrification Time and Devitrification Temperature. I. Investigation of Thermal Expansion of Heterogenously Devitrified, Modified Eucryptite Glasses and Their Devitrification Behavior. II. Influence of Devitrification Time and Temperature on Mechanical, Thermal, and Electric Properties of Eucryptite Glass Ceramics." Glass Technology. Berlin 36 (11), 1963. pp. 444-453. Abstract - Chemical Abstracts. Section 21. February 17. Gal. 4, 8 on 8. 16E-25d. Wolbach-12. January 17, 1964.
162. Mackenzie, J. D. and Laforce, R. P. Nature. 197. 1963. p. 480.
163. Mehmel, M. "Lithium-Aluminum Silicates as Ceramic Materials." Glass-Email-Keramo-Technik. 10 (No. 9).

- pp. 337-340. Translated from German. A.C.S.I.L. Translation No. 1396. AD406341, June 9, 1963. Department of Defense Documentation Center, Cameron Station, Bldg. 5, 5010 Duke Street, Alexandria, Virginia, 22314.
164. Hans-Heinrich Hutte GmbH. "Literatur und Patent Literatursammlung aber lithium." Silikattechnik. Frankfurt/Main Reuterweg 14.
165. Locsei, B. P. "Acid Resistance of Vitroceramic Materials on a Feldspar-Diopside Base." Symposium on Nucleation and Crystallization in Glasses and Melts. The American Ceramic Society, Inc. 1962. pp. 71-74.
166. Materials Handbook. Radome Department Technical Products Division. Sixth Edition. April 1963. Corning Glass Works.
167. "Properties and Selection of Metals." Metals Handbook. Vol 1. 8th Edition, 1961. Published by American Society for Metals. Novelty, Ohio.
168. "Allegheny Ludlum Steel Corporation." Stainless Steel Handbook. Pittsburgh, Pennsylvania. 1956.
169. "Strength of Metal Aircraft Elements." ML-HDBK-5. Armed Forces Supply Support Center. Washington 25, D. C., FSC 1500. March 1959.
170. Air Weapons Materials Application Handbook on Metals and Alloys. ARDC TR No. 59-66. Editor G. Sachs. Syracuse University Research Institute. First Edition December 1959. Air Research and Development Command, Andrews Air Force Base, Washington 25, D. C.
171. "New Ceramic Materials." Glass Technology. Vol 1. No. 1 February 1960. Society of Glass Technology. Sheffield 10, England.
172. Walton, J. D. and Bowen, M. D. Georgia Institute of Technology. Mechanical Properties of Engineering Ceramic. Edited by W. Kriegel and H. Palmour III. Interscience Publishers, New York. 1961. pp. 149-173.
173. Eliason, M. R. and Zellner, G. D. "A Compilation of Current Available Data on Nonmetallic Inorganic Refractory Materials Used for Radome Applications at Elevated Temperatures."

Contracts

Second Quarterly Report July - November 1963. Contract No. AF 33(657)-10519. Air Force Materials Laboratory, Wright-Patterson Air Force Base, Ohio.

174. Magnus, D. E. and Eisen, D. Research on Advanced Physical Approaches to Electromagnetic Window Design; Part I - Structural Investigation of Electromagnetic Windows. ASD-TDR-62-40. Aeronautical Systems Division, Wright-Patterson Air Force Base, Ohio. Contract No. AF 33(616)-7020. General Applied Science Laboratories, Inc., Westbury, L. I., New York. October 1962.
175. Fink, J. H. "High Temperature Match-Box Electron Tubes, Phase II." Final Progress Report. U. S. Army. Electronics Research and Development Contract DA36-039-SC-87404. (Continuation of Contract DA36-039-SC-75076) By Westinghouse Electric Corp. Electronic Tube Division, Elmira, New York. February 1961 - August 1962.
176. Miller, C. F. "High Temperature Match Box Receiving Tubes." First Quarterly Report. U. S. Army Signal Research and Development Laboratory, Fort Monmouth, New Jersey. Contract No. DA-36-039-SC-75076. Electronic Tube Division, Westinghouse Electric Corp., Elmira, New York. June 1 - September 1, 1958.
177. McMillan, P. W. and Hodgson, B. P. "New Glass-Ceramics for Insulator Seals." Materials in Design Engineering. January 1964. pp. 85-86.
178. Banks, E. and Schleuning, H. W. "Thin Films of Ferrimagnetic Oxides." First Progress Report, June 1958; Nineteenth Progress Report, March 1963. Polytechnic Institute of Brooklyn. Contract No. DA36-039-SC-78107. U. S. Army, Signal Corps Engineering Laboratories, Fort Monmouth, New Jersey.
179. Carter, T. L. and Zaretsky, E. V. Rolling-Contact Fatigue Life of a Crystallized Glass Ceramic. NASA Technical Note D-259, Lewis Research Center. AD234391, March 1960. Department of Defense Documentation Center, Cameron Station, Bldg. 5, 5010 Duke Street, Alexandria, Virginia, 22314.
180. Buckley, D. H. and Johnson, R. L. Halogen-Containing Gases as Lubricants for Crystallized-Glass-Ceramic-Metal Combinations at Temperatures to 1500 degrees F. NASA Technical Note D-295, Lewis Research Center, AD244506 October 1960.

Contrails

Department of Defense Documentation Center, Cameron Station, Bldg. 5, 5010 Duke Street, Alexandria, Virginia, 22314.

181. Harrell, S. and Zaretsky, E. V. Electron and Light Microscopy Techniques Suitable for Studying Fatigue Damage in a Crystallized Glass Ceramic. NASA Technical Note D-1161 Lewis Research Center. November 1961.
182. Noble, R., Opperman, K., Augustyn, Jr., W., Kokot, W., and Voigtlander, W. Study and Analysis of Lightweight Optical Elements. Perkin-Elmer Corporation, ASD-61-452. Aeronautical Systems Division, Wright-Patterson Air Force Base, Ohio. Contract No. AF 33(616)-6877, October 1961. AD271408. Department of Defense Documentation Center, Cameron Station, Bldg. 5, 5010 Duke Street, Alexandria, Virginia, 22314.
183. Eumarian, C., Materials in Design Engineering. June 1961. p. 151.
184. Hall, D. H. and Sanford, E. "Development and Properties of Some Polycrystalline Glass Coatings on Metal Substrates." Pfaudler Report PF61-13. Rochester 3, New York.
185. McWilliams, R. J. and Payne, Jr., B. "Nucleated Glass Coatings on Metals." Preprint of paper to be delivered at the Golden Gate Conference in San Francisco for American Society of Metals. February 13-15, 1964.
186. Carlson, W., Sanford, E., and Crandall, W. "Study of Crystallization of Glass Coatings on Metal by Electron Microscopy." Journal of the American Ceramic Society. June 21, 1963. Vol 46, No. 6. pp. 249-253.
187. Smith, R. E. "Ceramic-Coated Metals Resist Heat, Corrosion." Materials Engineering and Design. November 1963. pp. 85-87.
188. "Nucerite: A New Metal-Ceramic Composite." Ceramic Age. 1961. 77(4). pp. 68-69.
189. "Nucerite is Now in Production." Ceramic Age. 1961. 77(6). p. 46.
190. Pfaudler Bulletins Nos. 999 and 1014.
191. Corning's Glass Works Product Information Bulletin IC-20, August 1, 1960.

Contrails

192. Rodney, S. "Ultra High Temperature Dielectric Embedding Materials." Synthetic Mica Company. Contract by Bureau of Ships Nobs-86219. First Progress Report. January 27, 1962. (AD272038). Third Progress Report. July 27, 1962. (AD284989). Department of Defense Documentation Center, Cameron Station, Bldg. 5, 5010 Duke Street, Alexandria, Virginia, 22314.
193. Forlano, R. J., Krumwiede, D. M., Thornton, H. R., Bennett, D. W., Benzel, J. F., Nelson, J. H., Lauchuer, J., Lefort, H., Parikh, K., and Haertling, G. "Research on Elevated Temperature Resistant Ceramic Structural Adhesives." WADC Technical Report 55-491 Parts I-VII. Part VII dated October 1962. Part VI June 1962, Part V June 1960. Wright Air Development Center, Wright-Patterson Air Force Base, Ohio. Prepared under Contract No. AF 33(616)-6192, by University of Illinois.
194. Filippi, F. "Composite Ceramic Radome Manufacture by Mosaic Techniques." By Marmco Research and Development Contract AF 33(657)-10111. Part I - January 1963, Part II - April 1963, Part III - July 31, 1963.
195. Cornely, K. W. "New Cements Prove Suitable for Applications Above 4000 degrees F." Ceramic Age. January 1962. pp. 52-53.
196. "Adhesive Takes High Heat and Shock." Missiles and Rockets. April 24, 1961. p. 40.
197. "Cercor." Corning's Bulletin NPC-2.
198. "Ceramic Structures." Chemical and Engineering News. October 6, 1958. p. 104.
199. Howard, C. P. "Heat Transfer and Flow Friction Characteristics of Skewed Passage and Glass-Ceramic Heat Transfer Surfaces." Department of Mechanical Engineering, Stanford University. Prepared under Contract Nonr 225(23) (NR-090-342) for Office of Naval Research.
200. Kitaygorodskiy, I. I. "Theoretical Basis of the Synthesis of Sitall from Slag." Russian Periodical, Zhurnal Vsesoyuznogo Khimicheskogo Obshchestvo. Vol 8. No. 2. 1963. pp. 192-7. Foreign Technology Division, Wright-Patterson Air Force Base, Ohio. TT-63-753 Translation August 22, 1963.

Contrails

201. Partridge, G. and McMillan, P. W. "The Preparation and Properties of Glass-Ceramics Using Metallic Phosphates as Nucleation Catalysts." Glass Technology. Vol 4. No. 6 December 1963. pp. 173-182.
202. Winkler, H. G. F. "Struktur und Polymorphie des Eukryptits." (Tief-LiAlSiO₄). Heidel Beitr. 4, 233-242. 1954.
203. Shropshire, J., Keat, P. P., and Vaughan, P. A. "The Crystal Structure of Keatite, A New Form of Silica." Zeit. Krist. 112, 1959. pp. 409-413.
204. Skinner, J., and Evans, H. T., Jr. "Crystal Chemistry of β -Spodumene Solid Solutions on the Join LiO₂·Al₂O₃·SiO₂." American Journal of Science. 258A. 1960. pp. 312-324.
205. Eppler, R. A., Giardini, A. A., and Tydings, J. E. "Some Studies of Effect of High Pressure on a Lithia-Alumina-Silica Glass." Journal American Ceramic Society. Vol 45. No. 5. May 1962. pp. 218-220.
206. Eppler, R. A. "Glass Formation and Recrystallization in the Lithium Metasilicate Region of the System Li₂O·Al₂O₃·SiO₂." Journal American Ceramic Society. February 1963.
207. Field, Michael, President - Correspondence with Metcut Research Associates, Inc., Cincinnati, Ohio. January 1964.
208. Rudkin, R. L. "Thermal Diffusivity Measurements on Metals and Ceramics at High Temperatures." ASD-TDR-62-24 Part II. Aeronautical Systems Division, Wright-Patterson Air Force Base, Ohio. Contract No. MIPR 33 (657)-2-RD-155 by U. S. Naval Radiological Defense Laboratory. June 1963.
209. Flynn, D. R. and Robinson, H. E. "Thermal Conductivity of Semi-Conductive Solids; Method for Steady-State Measurements on Small Disc Reference Samples." Interim Technical Report. February 1959 to March 1961. National Bureau of Standards Report AD 277034. Department of Defense Documentation Center, Cameron Station, Bldg. 5, 5010 Duke Street, Alexandria, Virginia, 22314.
210. Plummer, W. A., Campbell, D. E., and Comstick, A. A. "Method of Measurement of Thermal Diffusivity to 1000 degrees C." Journal of the American Ceramic Society. July 1962. pp. 310-316.

Contrails

211. Defense Metals Information Center Memorandum 148, March 28, 1962.
212. Olson, O. H. and Morris, J. C. "Determination of Emissivity and Reflectivity Data on Aircraft Structural Materials." Part III. Techniques for Measurement WADC Wright Air Development Center, Wright-Patterson Air Force Base, Ohio. TR 56-222 DDC AD239302. Department of Defense Documentation Center, Cameron Station, Bldg. 5, 5010 Duke Street, Alexandria, Virginia, 22314. April 1960.
213. Tiller, W. A. "Solidification." AF Office Scientific Research Contract AF 49(638)-1029. AD No. 286428. Department of Defense Documentation Center, Cameron Station, Bldg. 5, 5010 Duke Street, Alexandria, Virginia, 22314. June 1962.
214. Herezog, A. "Microcrystalline BaTiO₃ by Crystallization from Glass." Journal of the American Ceramic Society. Vol 47. No. 3. March 21, 1964. p. 107.
215. Klingsberg, C. "Bubble-Induced Nucleation and Crystal Growth in Glass." Journal of the American Ceramic Society. Vol 47. No. 2. February 1964. pp. 97-100.
216. Thakur, R. L. "Nucleation and Controlled Crystallization of Glass." Central Glass Ceramic Research Institute Bulletin (India). Vol 10. No. 2. 1963. pp. 51-66.
217. Abbott, H. M. and Kerrigan, J. V. "Epitaxial Growth: An Annotated Bibliography." Lockheed Aircraft Corp., Sunnyvale, California. SB63-32; Report No. 6-90-63-42 AD-419558. Department of Defense Documentation Center, Cameron Station, Bldg. 5, 5010 Duke Street, Alexandria, Virginia, 22314.

APPENDIX I

(Selected Article)

Glass-Ceramics Catalysed with Zirconia

by

Megumi Tashiro and Masamichi Wada

(Institute for Chemical Research, Kyoto University, Japan)

(Ref. 28)

The crystallized glasses nucleated by zirconia have an excellent pure white appearance. One serious drawback of zirconia as a nucleating agent is, however, its sparing solubility in the glasses, especially of low lithia content, at melting temperatures. It was found that the zirconia added as zircon can be easily brought into solution at melting temperature if a small addition of P_2O_5 be present in the glass composition.

The present study was undertaken to locate the composition of the glass in the system, $Li_2O \cdot Al_2O_3 \cdot SiO_2$, especially in a region near spodumene composition, which by the aid of small additions of ZrO_2 and P_2O_5 , can be converted, by heat treatment, into the polycrystalline materials with good thermal shock resistance. The following series of glass were melted:

Series A: $65 SiO_2, (35-x) Al_2O_3, xLi_2O, y K_2O, 3 P_2O_5, z ZrO_2$
($x=5, 6, 7, 8; y=0, 1; z=1, 2, 3, 4$)

Series B: $65 SiO_2, 30 Al_2O_3, 5 Li_2O, 1 P_2O_5, z ZrO_2$
($p=1, 3, 5; z=1, 2, 3, 4$)

Series C: $(95-q) SiO_2, q Al_2O_3, 1 K_2O, p P_2O_5, 4 ZrO_2$
($q=20, 25, 30, 35; p=1, 3, 5$)

Figure 40 is a graphical representation of the main components of glasses of the above series, in which additional components, ZrO_2 , P_2O_5 and K_2O are omitted. The point, a, from which the series A starts corresponds to the spodumene composition. The glasses were

Conclusions

melted at the temperatures 1500 to 1600° C, formed into a specimen of the size, 3 x 5 x 50 mm, and then reheated from room temperature to 1200° C at a constant rate of 5° C, each for 30 minutes with intermissions at 650, 750 and 850° C, each for 30 minutes. At the maximum temperature (1200° C) the specimens were also held for 30 minutes. The crystallized glasses thus obtained were subjected to the measurements of thermal expansion and bending strength.

The best result with respect to the thermal shock resistance was obtained for the crystallized glass of the composition: 65 SiO₂, 30 Al₂O₃, 5 Li₂O, 1 K₂O, 3 P₂O₅, 4 ZrO₂ by mole ratio. This composition corresponds to the point d in Figure 40. Its coefficient of thermal expansion and bending strength were 13.6×10^{-7} (20 to 500° C) and 9100 psi (unabraded), respectively. Figure 39 shows the result of chemical durability test (in 5% HCL at 90° C) for the glass of this composition before and after the heat treatment. In the figure, the results for the glasses represented by the points g and f (in Figure 40) and also for the commercial products nucleated with titanium oxide are also shown for comparison.

Effects of the compositional variations on the properties of glass before and after the heat treatment are summarized as follows: (1) with increasing the amount of addition of P₂O₅, the solubility of ZrO₂ in glass at melting temperatures increases, and accordingly the bending strength of the crystallized glass increases. This can be seen, for example, from Table XIII. Addition of P₂O₅ in excess of 5 (= p in the series B), however, causes the increase in viscosity of glass, thus making the melting of the glass difficult; (2) too much addition of Li₂O in replacement of Al₂O₃ (in excess of x-6 in the series A) injures the uniform crystallization of glass in the process of heat treatment, resulting in deformation, cracking, or swelling of the specimens; and (3) replacement of SiO₂ with Al₂O₃ decreases the viscosity of glass, and increases the solubility of ZrO₂ at melting temperatures

(see Table XIII). However, in order to control the coefficient of thermal expansion for the crystallized glass within 15×10^{-7} (20 to 500° C), the content of Al_2O_3 should be kept less than 30 (= q in the series C); the coefficient of thermal expansion for the crystallized glasses of the series C increased with increasing the Al_2O_3 content (see Figure 40 and Figure 41).

TABLE XIII
Relations Between Chemical Composition and Properties of Devitrified Ceramics

Points in Fig. 1	Chemical Composition (Weight ratio)					Scum*	Viscosity	Coefficient of Expansion (20-500°C)	Bending Strength** (psi)
	SiO ₂	Al ₂ O ₃	Li ₂ O	P ₂ O ₅	ZrO ₂ K ₂ O				
e	75	20	5	5	4	1	3		7400
	75	20	5	3	4	1	4	-3.8 x 10 ⁻⁷	7960
	75	20	5	1	4	1	5		7800
f	70	25	5	5	4	1	2		8675
	70	25	5	3	4	1	2	10.8 x 10 ⁻⁷	9100
	70	25	5	1	4	1	4		8250
d	65	30	5	5	4	1	0		8675
	65	30	5	3	4	1	1	13.6 x 10 ⁻⁷	9100
	65	30	5	1	4	1	3		9950
g	60	35	5	5	4	1	0		10950
	60	35	5	3	4	1	0	17.4 x 10 ⁻⁷	11800
	60	35	5	1	4	1	1		11650

*Number denotes the degree of scum (monoclinic ZrO₂) in molten glass; zero for no scum.

**Measured with the unabraded samples reheated up to 1200°C (2 hrs).

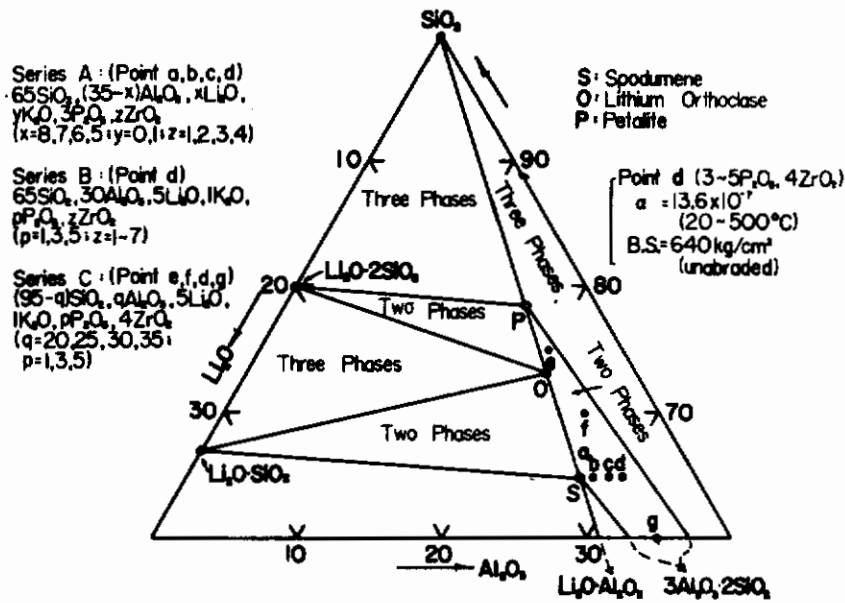

Fig. 4.0 Compositions of glasses melted shown in a within triangle of the $\text{Li}_2\text{O}-\text{Al}_2\text{O}_3-\text{SiO}_2$

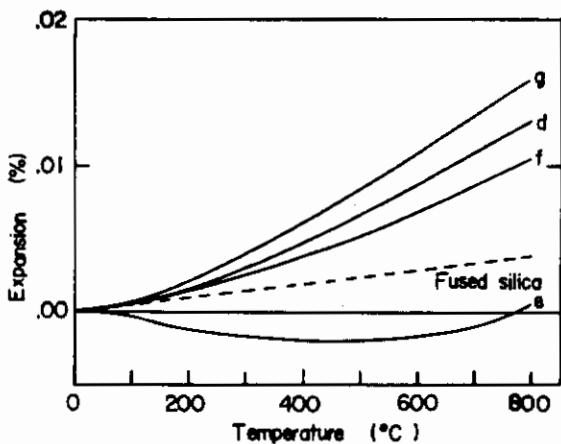

Fig. 4.1 Thermal expansion curves of crystallized glasses

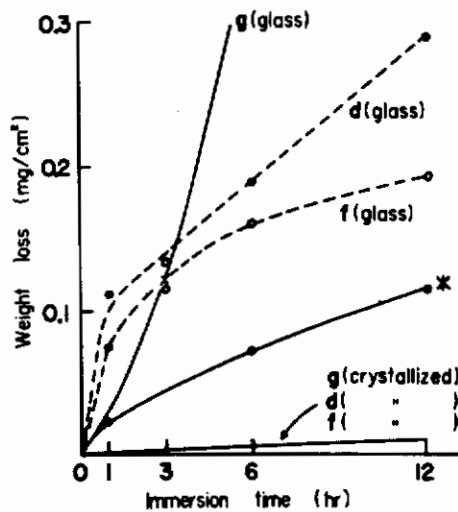

Fig. 4.2 Solubility of the crystallized glasses and their parent glasses in 5% HCl solution at 90°C .
 X Commercial product substituted with TiO_2 .

APPENDIX II

SELECTED ABSTRACTS ON NUCLEATION
AND CRYSTALLIZATION STUDIES

1. Crystallization of a Titania-Nucleated Glass by R. D. Maurer, Corning Glass Works, Corning, New York (Ref. 59).

Light scattering has been used to study crystal formation and growth in a magnesia-alumina-silica glass nucleated by titania. A theory for analyzing the scattering is outlined. It involves a model in which a crystal is surrounded by a region of varying refractive index. Using the theory, the average number and size of crystals are obtained. The scattering inhomogeneities initially present are shown to be predominantly isotropic and to become anisotropic during heat treatment. The isotropic-anisotropic transformation is correlated with nucleation and is interpreted as the crystallization of an "emulsion." Stookey's discussion of crystallization catalysis by emulsion formation is elaborated and the significance for theories of glass formation is discussed.

2. Catalyzed Crystallization in Glass by Werner Vogel and Klaus Gerth, VEB Jenaer Glaswerk Schott and Genossen Laboratories, Jena, Germany (Ref. 59).

The basic processes of catalyzed crystallization in glass have been investigated. The investigation has shown that catalyzed crystallization in glass depends in the main on two processes: (1) the control of phase separation in glass, and (2) the directed deposition of substance (epitaxy) on produced crystal nuclei. Using electron-microscopic photographs it has been possible to follow and prove the history of the two processes in glass-ceramics and in model glasses (beryllium fluoride glass). The experimental results show that model glasses lend themselves especially well to the study of the processes described.

3. Crystallization of Lead Metaniobate From A Glass by R. C. Anderson and A. L. Friedberg, University of Illinois, Urbana, Illinois (Ref. 59).

It is possible to achieve high dielectric constant materials by crystallizing ferroelectric-type crystals from a glass. This work examines the crystallization of PbNb_2O_6 from a glass containing PbO , Nb_2O_5 , SiO_2 and Al_2O_3 . Crystal forms were identified optically and by X-ray diffraction. Several glass-crystal composites were prepared for which dielectric constants and dissipation factors were measured as a function of temperature.

4. Phase Equilibria and the Crystallization of Glass by Rustum Roy, College of Mineral Industries, The Pennsylvania State University, University Park, Pennsylvania (Ref. 59).

This paper describes two aspects of the various phase equilibrium considerations which must be considered in describing the crystallization of a glass. First, it treats the relationships of the various glass phases to each other and to the crystalline phases which may precipitate from them. On the basis of experimental evidence, the second aspect deals with the nucleation of a second liquid or SRO (short-range order) phase as the first step in the crystallization of certain useful glasses. Structural reasons are given why this step, the most probable one in the phase separation, is "homogeneous" and on a very fine scale. It is shown that the conditions which are responsible for such homogeneous nucleation also manifest themselves in specific anomalies in the phase equilibrium diagram.

5. Crystal Nucleation by Glass in Glass Separation by S. M. Ohlberg, H. R. Strickler, Glass Research Center, Pittsburgh Plate Glass Company, Pittsburgh, Pennsylvania (Ref. 59).

Three crystallizable glasses from the systems $\text{MgO} \cdot \text{Al}_2\text{O}_3 \cdot \text{SiO}_2 \cdot \text{TiO}_2$, $\text{Li}_2\text{O} \cdot \text{CaO} \cdot \text{SiO}_2 \cdot \text{TiO}_2$, and $\text{LiO}_2 \cdot \text{MgO} \cdot \text{Al}_2\text{O}_3 \cdot \text{SiO}_2$ were studied by X-ray diffraction, electron microscopy, and light microscopy. The three glasses had in common the fact that on heat treatment they could be uniformly devitrified by an internal nucleation process as opposed

to the more common surface nucleation and devitrification. For each glass evidence is presented which demonstrates that the internal nucleation is the result of a glass in glass separation, i. e., one glass phase dispersed in a second. The first crystalline species thereby nucleated serves to heterogeneously nucleate crystallization of the bulk of the glass. In the case of the $\text{MgO} \cdot \text{Al}_2\text{O}_3 \cdot \text{SiO}_2 \cdot \text{TiO}_2$ glass, the formation of the initial crystalline phase is preceded by a growth in the size of the glass droplets. In the system $\text{Li}_2\text{O} \cdot \text{CaO} \cdot \text{Al}_2\text{O}_3 \cdot \text{SiO}_2$, nucleation starts at the glass-glass interface and initially propagates into the dispersing glass phase. In the system $\text{Li}_2\text{O} \cdot \text{MgO} \cdot \text{Al}_2\text{O}_3 \cdot \text{SiO}_2$, nucleation also starts at the glass-glass interface, but in this case crystallization proceeds first into the dispersed glass phase. Examination of the last system indicates a new mechanism for spherulite growth.

6. Crystal Orientation as Influenced by Platinum Nucleation by Guy E. Rindone, Department of Ceramic Technology, The Pennsylvania State University, University Park, Pennsylvania (Ref. 59).

Crystallization of lithium disilicate crystals from lithium silicate glasses normally occurs with the crystals forming in a preferred orientation with respect to the glass surface. This orientation can be prevented in varying degrees by crystallization on platinum nuclei. Experiments have been performed which show the depth beneath the surface to which orientation occurs in platinum-nucleated glasses as compared to the platinum-free glass under varying conditions of heat treatment.

7. A Theoretical and Experimental Investigation of Nucleation Leading to Uniform Crystallization of Glass by W. B. Hillig, General Electric Research Laboratory, Schenectady, New York (Ref. 59).

The term "nucleation catalysis" is examined to determine whether such a factor is essential to the uniform precipitation processes leading to the formation of glass-ceramics. Classical nucleation theory is briefly reviewed to provide the background for this discussion, with

special emphasis upon heterogeneous nucleation catalysis and the transient time for attaining steady-state nucleation. From this a new quantitative criterion for the kinetic stability of glass is developed. The experimentally observed nucleation kinetics in a limited series of glasses containing BaO, SiO₂, TiO₂, and in some cases Al₂O₃ reveal no anomalous behavior that cannot be interpreted in terms of a simple nucleation process. The surface free energy, which in turn controls the nucleation kinetics, is considered to be a function of the degree of diffuseness, absorption, configurational relaxation, and electronic relaxation at the interface. It is concluded that heterogeneous nucleation catalysis is not necessarily essential for uniform devitrification. Although various substances, for example those which cause departure of the system from ideality, can be correlated with the relative barrier to homogeneous nucleation, to identify these also as nucleation catalysts is interpreting the term too broadly.

8. Kinetics of Reorganization, Nucleation, and Crystallization in Sodium Phosphate Glasses: I, Sodium Metaphosphate Glass by A. E. R. Westman and M. Krishna Murthy, Ontario Research Foundation, Toronto, Ontario, Canada (Ref. 59).

The kinetics of reorganization, nucleation, and crystallization of sodium metaphosphate glass in the temperature range 300° to 350° C, has been studied using two-dimensional paper chromatographic methods. It is found that the reorganization equilibrium is the same as that found by quenching from above the liquidus. The nucleation process is slow but the crystallization process and, consequently, the reorganization process are rapid. The activation energies of nucleation and crystallization in the above temperature range are, respectively, approximately 50 and 20 kcal per mole of sodium trimetaphosphate crystals produced.

9. Bubble-Induced Nucleation and Crystal Growth in Glass by Cyrus Klingsberg, Corning Glass Works, Corning, New York (Ref. 215).

Evidence that bubbles can cause annular nucleation and subsequent

crystal growth on the surface of $\text{BaO} \cdot \text{Al}_2\text{O}_3 \cdot \text{TiO}_2 \cdot \text{SiO}_2$ glasses is presented. The crystalline rings were identified as hexacelsian, $\text{BaAl}_2\text{Si}_2\text{O}_8$ (the hexagonal or high-temperature polymorph of celsian). Size, character, and suggestions are to the genesis of these rings are given.

10. Microcrystalline BaTiO_3 by Crystallization From Glass by Andrew Herczog, Corning Glass Works, Corning, New York (Ref. 214).

The properties and composition of glasses suitable for crystallization of BaTiO_3 are described. The crystallization of certain glasses results in a nearly complete recovery of BaTiO_3 , besides the feldspar $\text{BaAl}_2\text{Si}_2\text{O}_8$ as a minor phase. The mechanism of crystallization was investigated by thermal analysis, viscosity, and grain-size measurements as a function of the temperature whereas density data were used for evaluation of the BaTiO_3 content. Within the range 30 to 60 percent by volume of BaTiO_3 at about 1 μ grain size, the measured dielectric constant increased from 100 to 1200. The calculated partial dielectric constant of the titanate phase at this grain size was about 3500. As the grain size approached 0.1 μ , the dielectric constant decreased and became nearly independent of the temperature because of the predominance of surface states. Other effects were attributed to special structural characteristics, such as absence of porosity and clamping of the titanate particles within the microcrystalline matrix. Data are also presented on dielectric constant and loss tangent at different frequencies, dc breakdown strength, dc resistivity, and ferroelectric properties as a function of the grain size of the crystallized material.

11. The Preparation and Properties of Glass-Ceramics Using Metallic Phosphates as Nucleation Catalysts by G. Partridge and P. W. McMillan, Nelson Research Laboratories, English Electric Company Ltd., Stafford (Ref. 201).

Metallic phosphates have been found to act as satisfactory

Contrails

nucleation catalysts for the conversion of a wide range of glass compositions into glass-ceramics. The types of glass compositions are given together with a description of the preparation of this type of glass-ceramic.

A general description is given of the mechanical, electrical, and thermal properties of phosphate-catalysed glass-ceramics and the properties of five materials are given in detail. The physical properties of the glass-ceramics are compared with those of conventional ceramics and glasses. Wherever possible, the properties of the phosphate-catalysed glass-ceramics are related to their mineralogical content and to their microcrystalline structure. The mineralogical content has a marked influence on the physical properties of the glass-ceramics, particularly on their linear thermal expansion characteristics, and materials covering a wide range of thermal expansion characteristics have been prepared.

APPENDIX III

HANDBOOK PROPERTY DATA
ON
MAGNESIA-ALUMINA-SILICA-TITANIA
AND
LITHIA-ALUMINA-SILICA-TITANIA
DEVITRIFIED CERAMICS

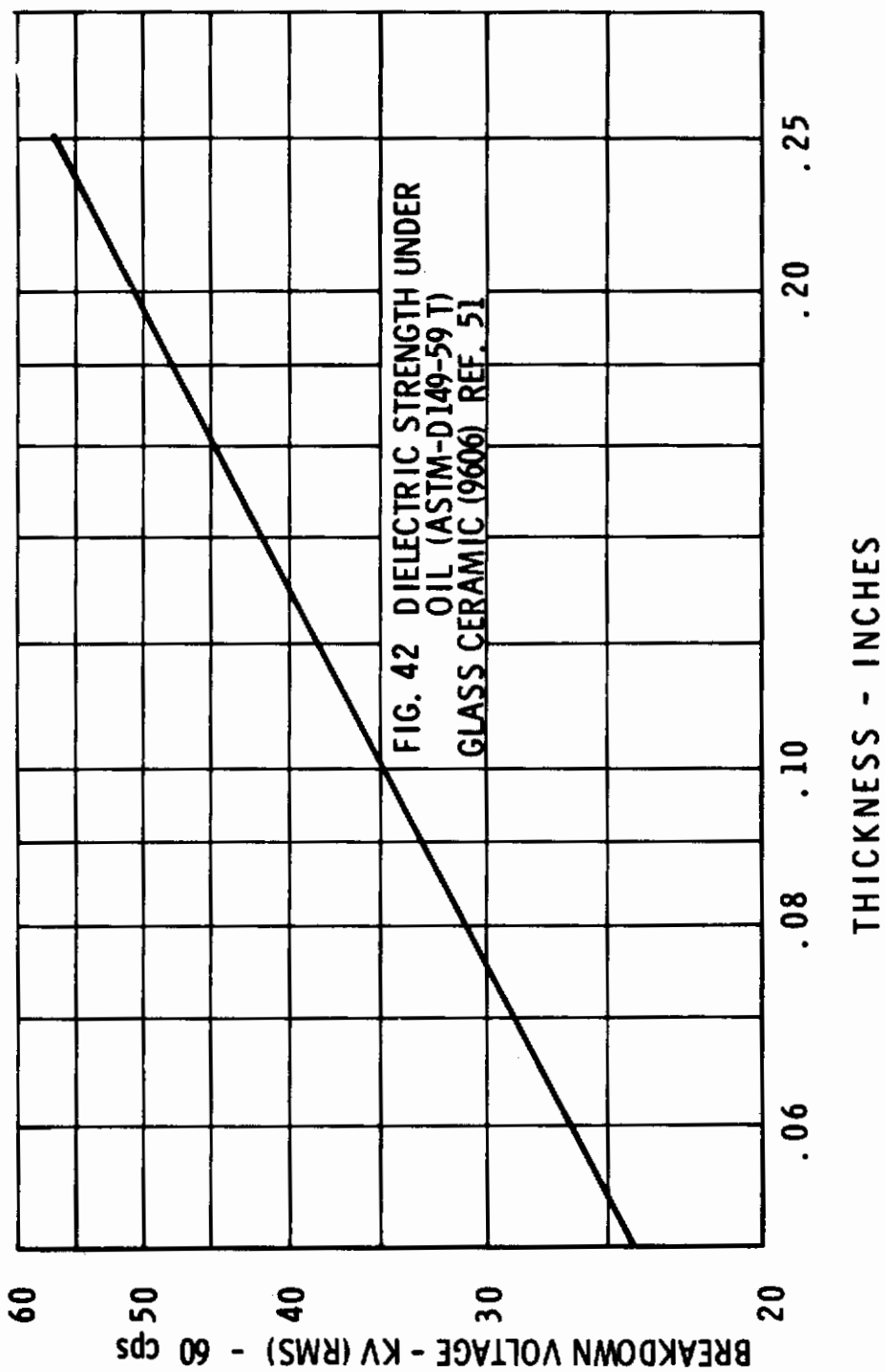

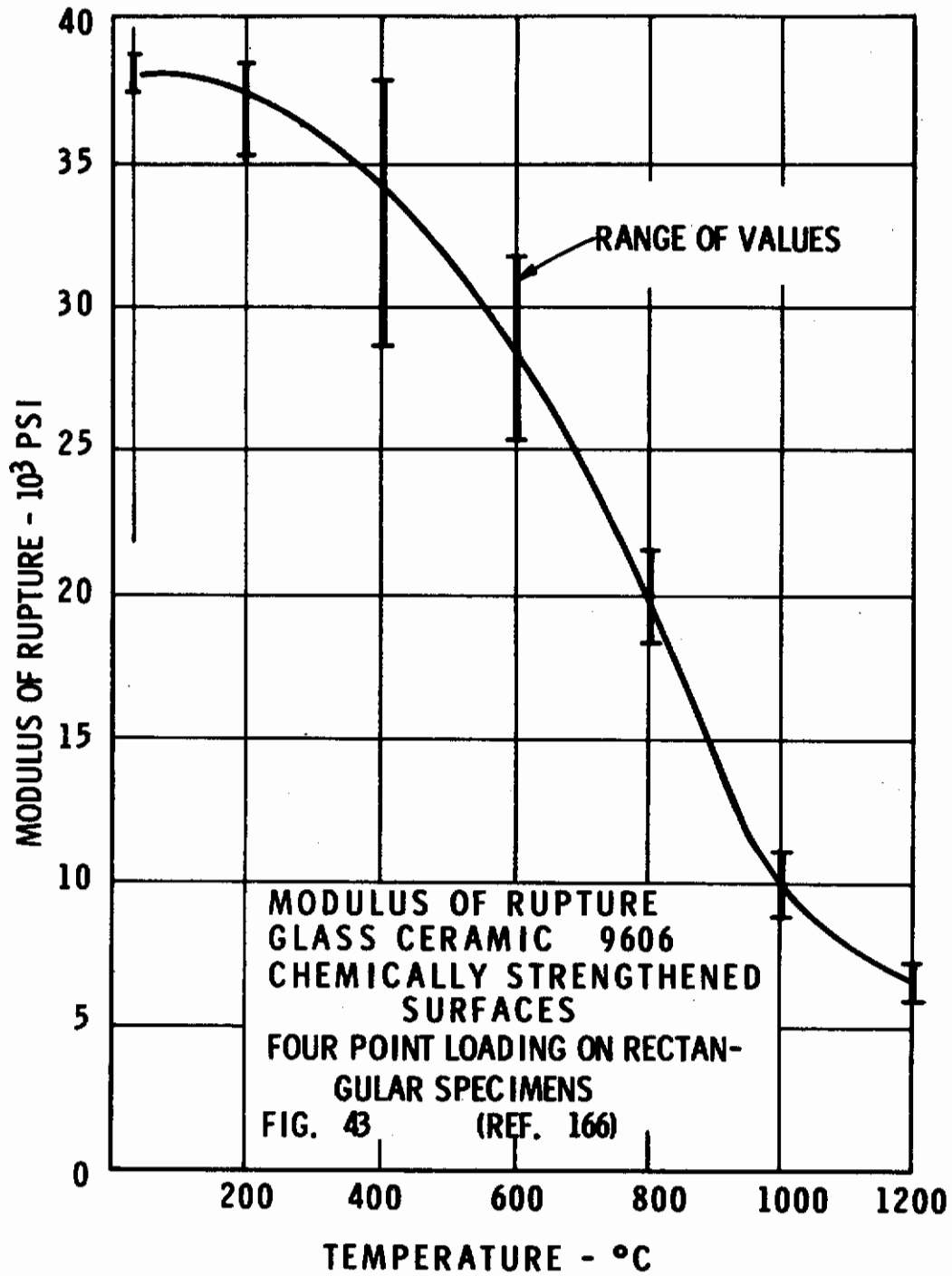

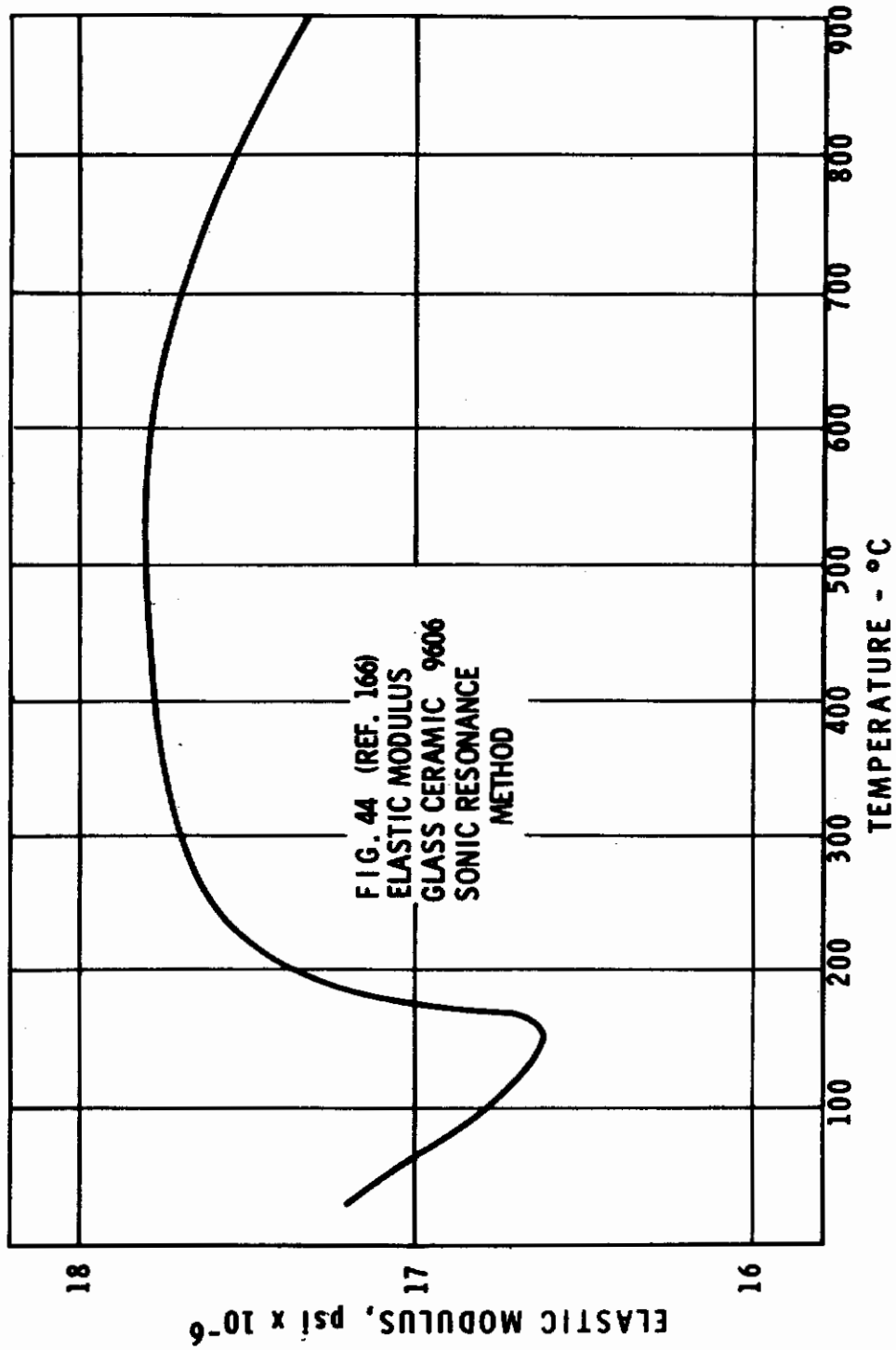

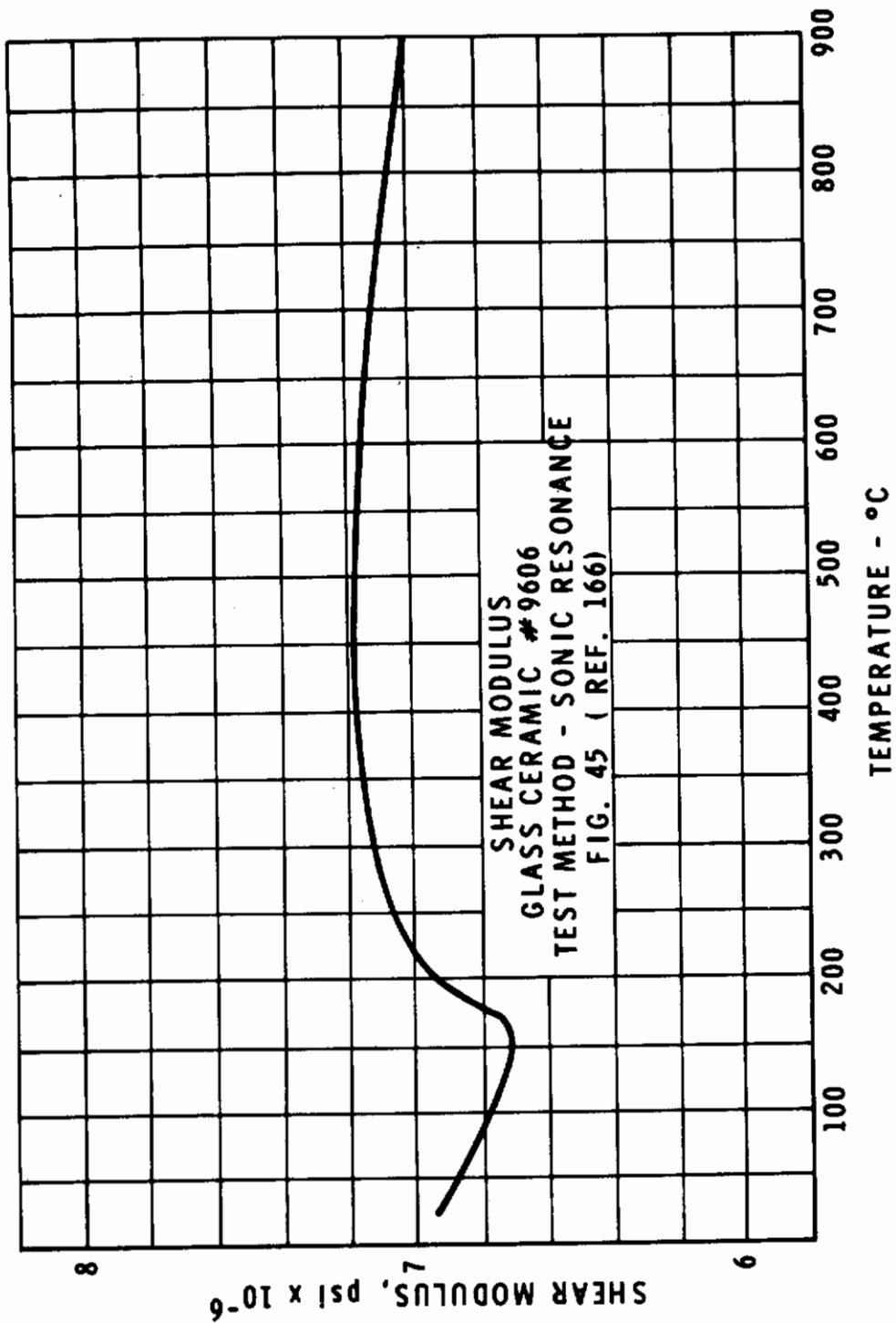

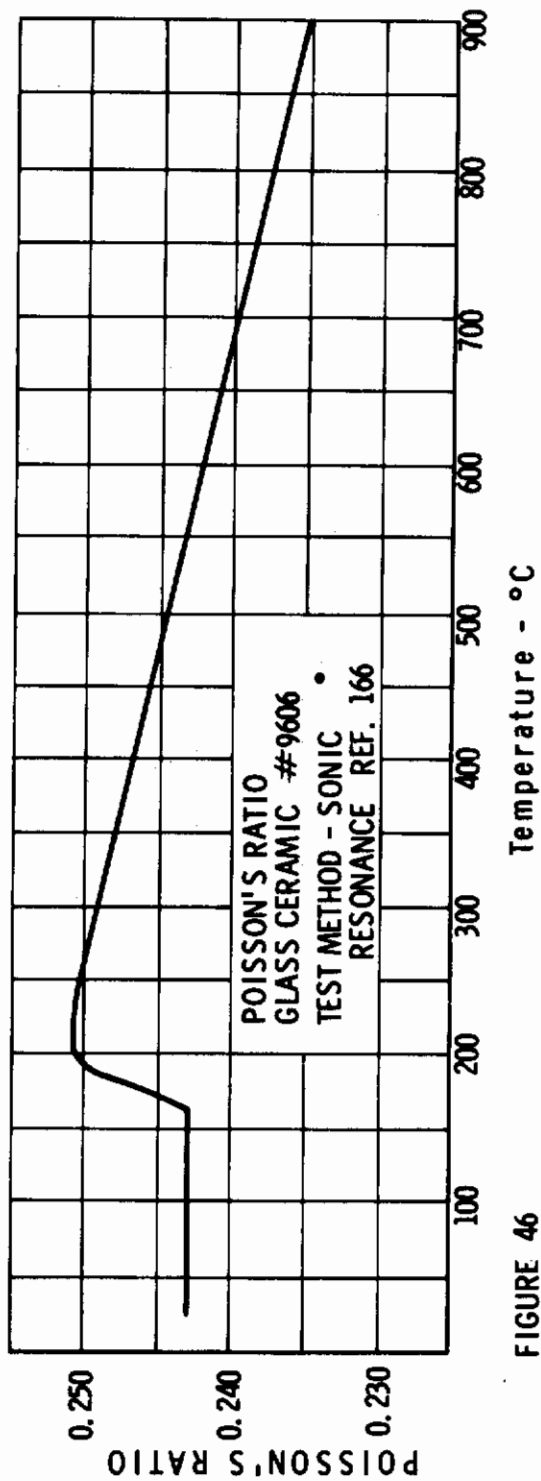
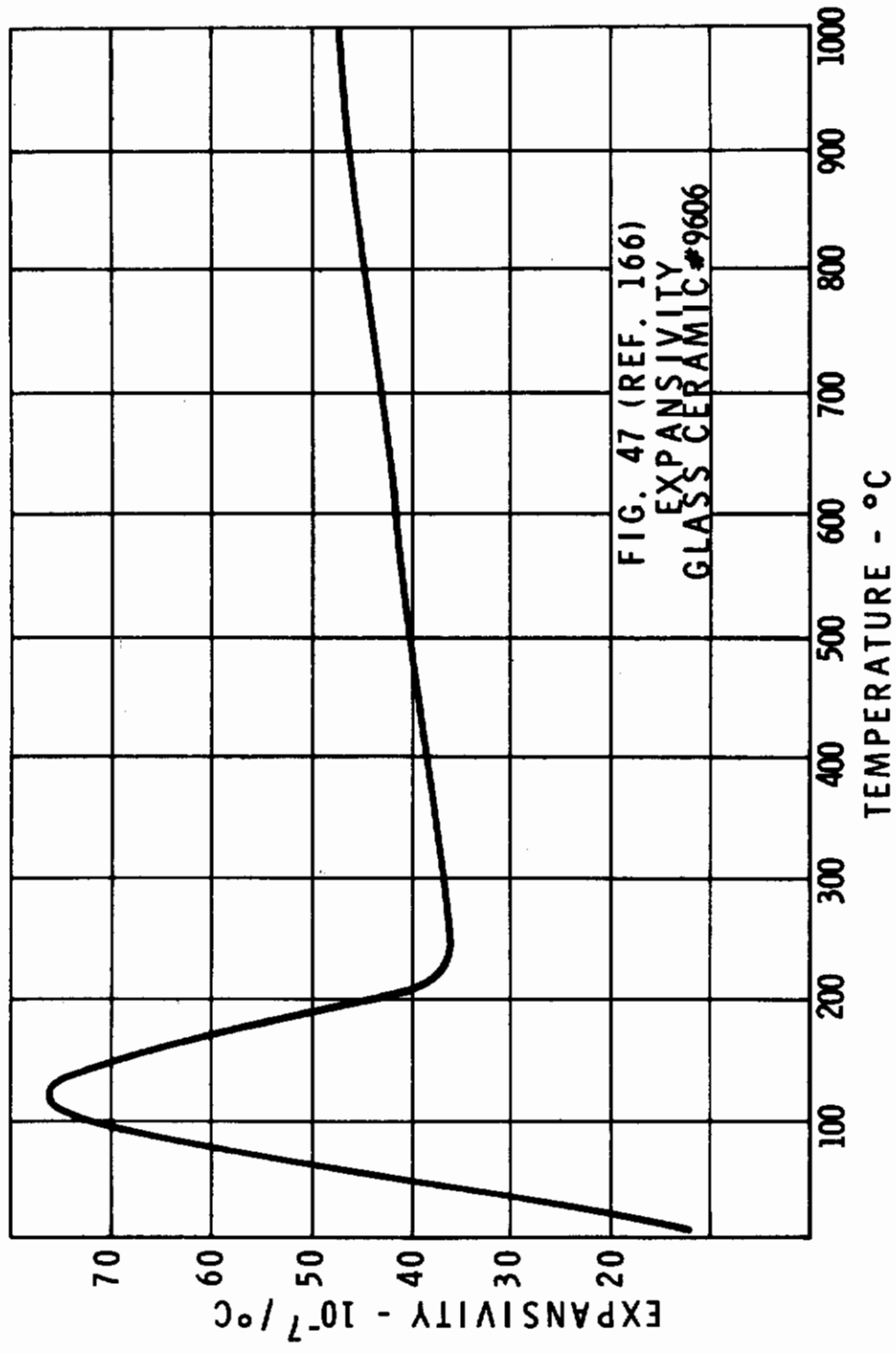

FIGURE 46



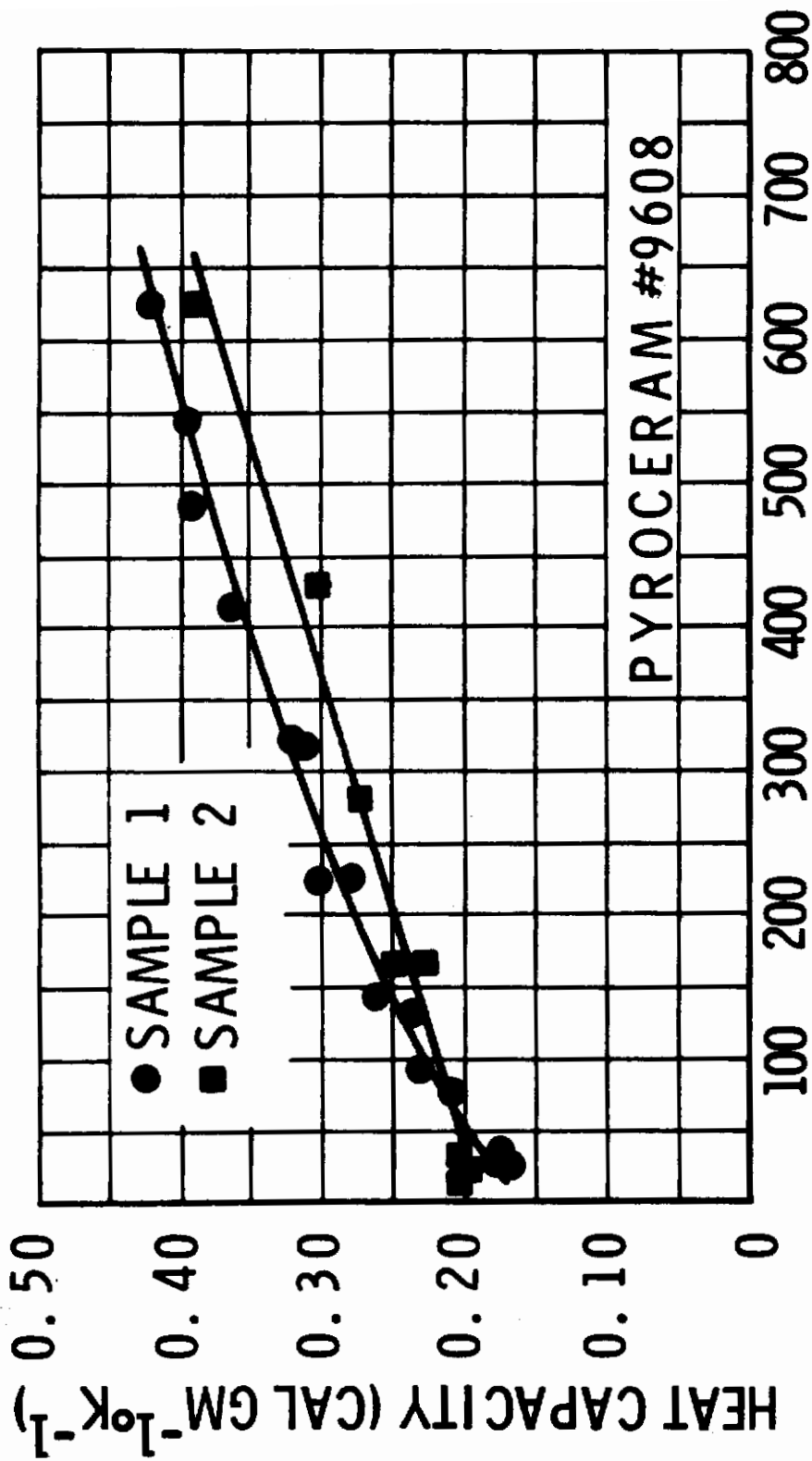

FIG. 48 HEAT CAPACITY OF PYROCERAM 9608
(RUDKIN REF. 208)

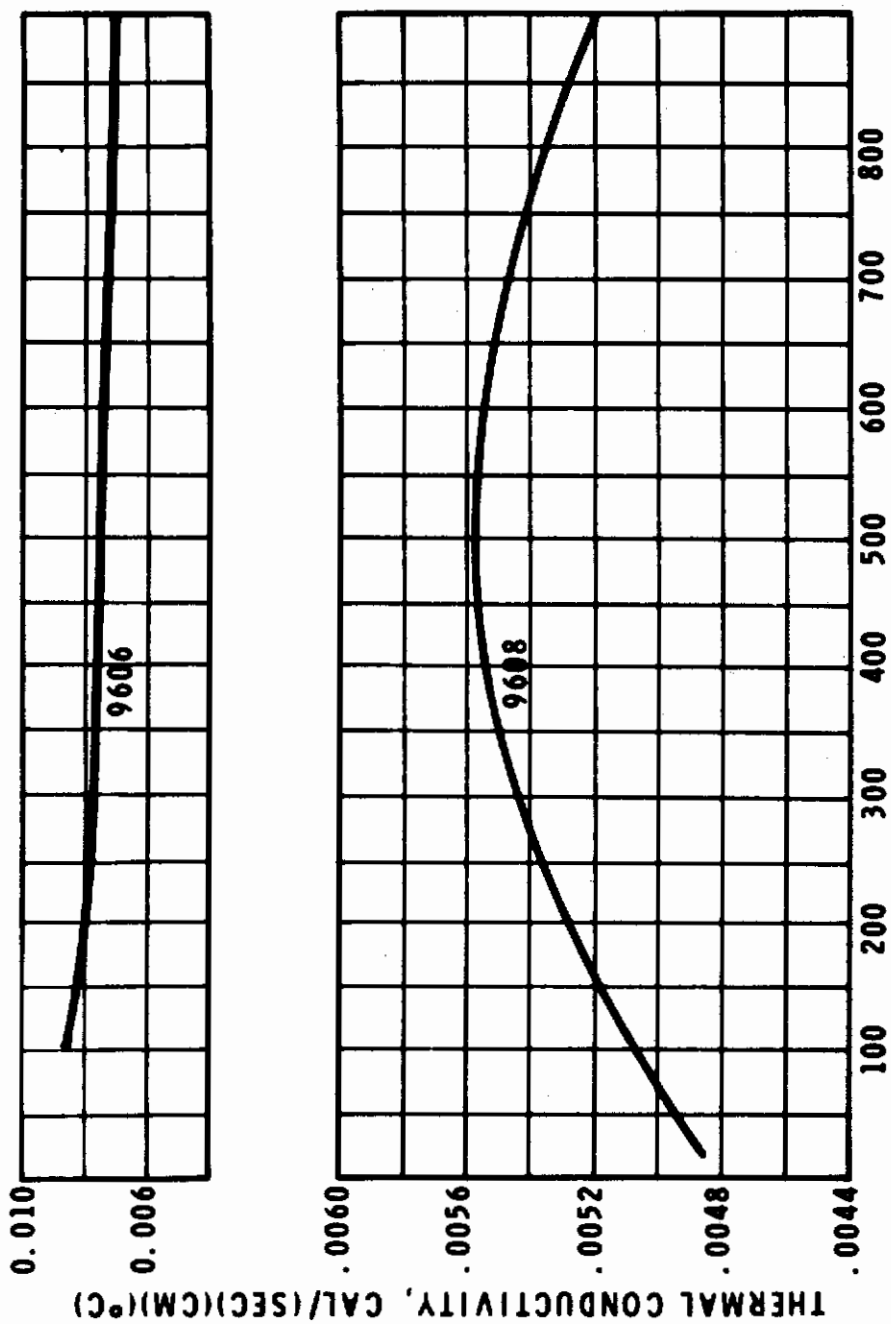

FIG. 49 THERMAL CONDUCTIVITY OF PYROCERAM 9606 and 9608
(REF. 166 and 209)

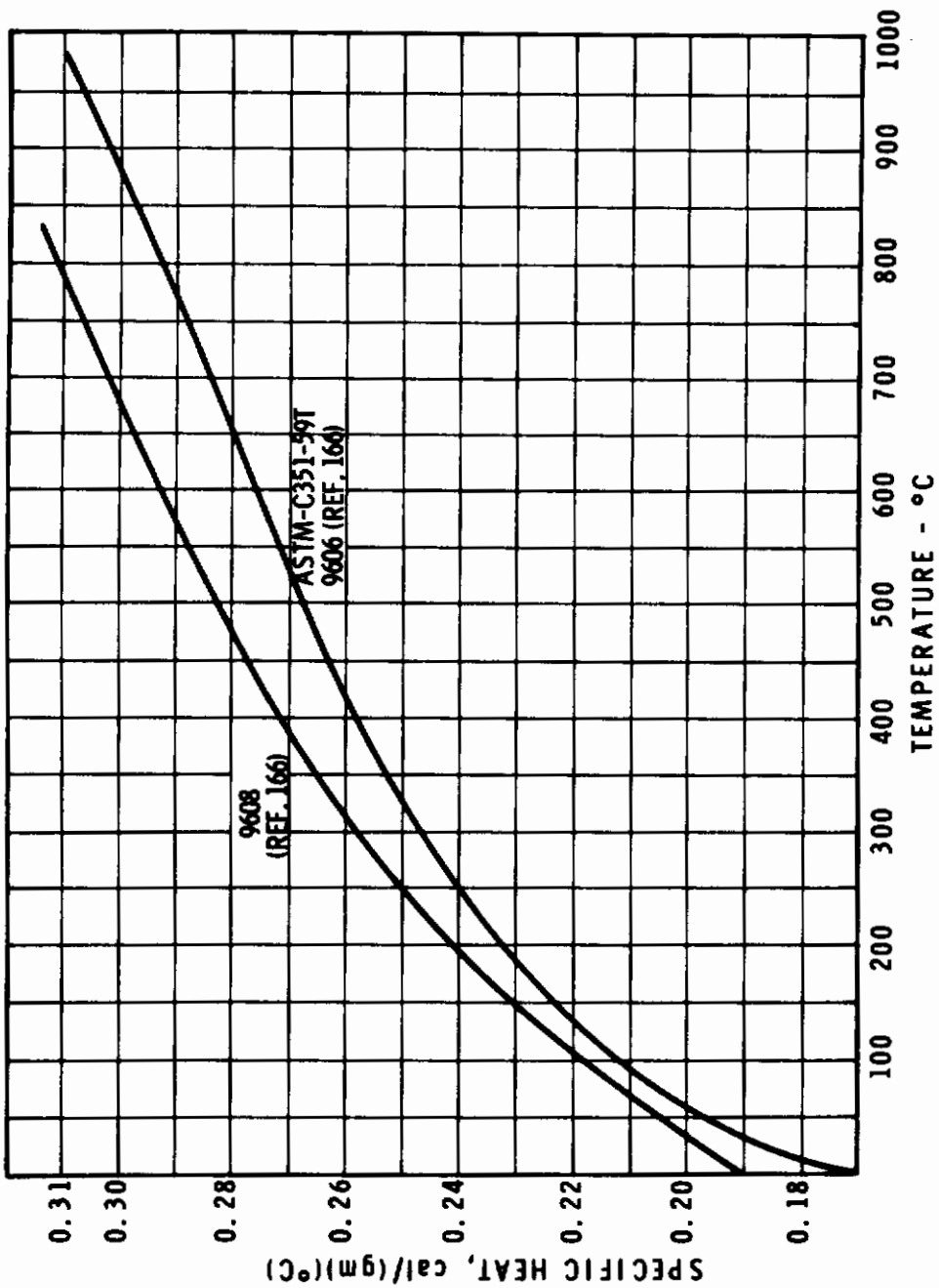

FIG. 50 SPECIFIC HEAT OF PYROCERAM 9606 and 9608 (REF. 166)

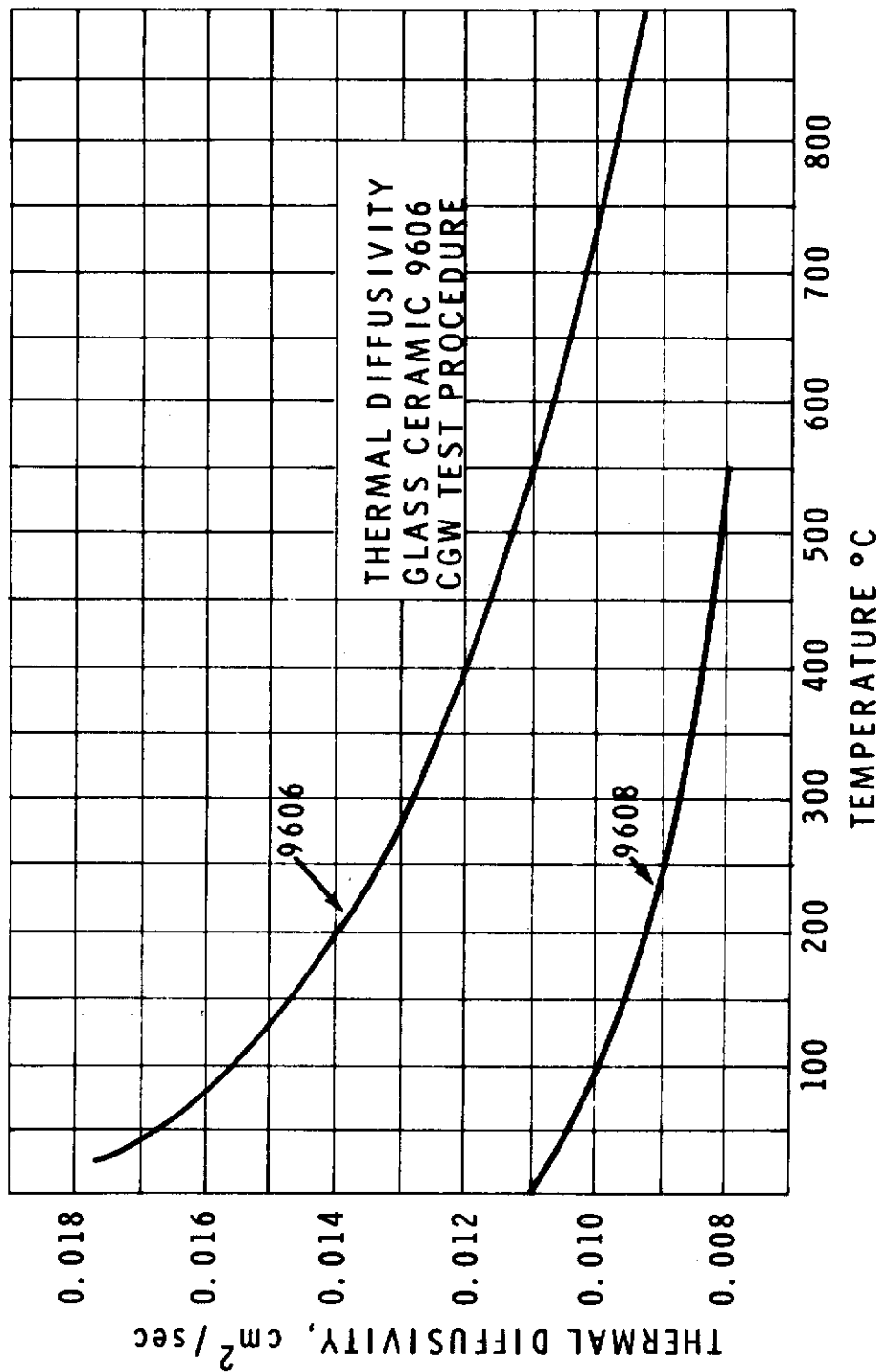

FIG.51 THERMAL DIFFUSIVITY OF PYROCERAM 9606
(REF. 166, 208, 210)

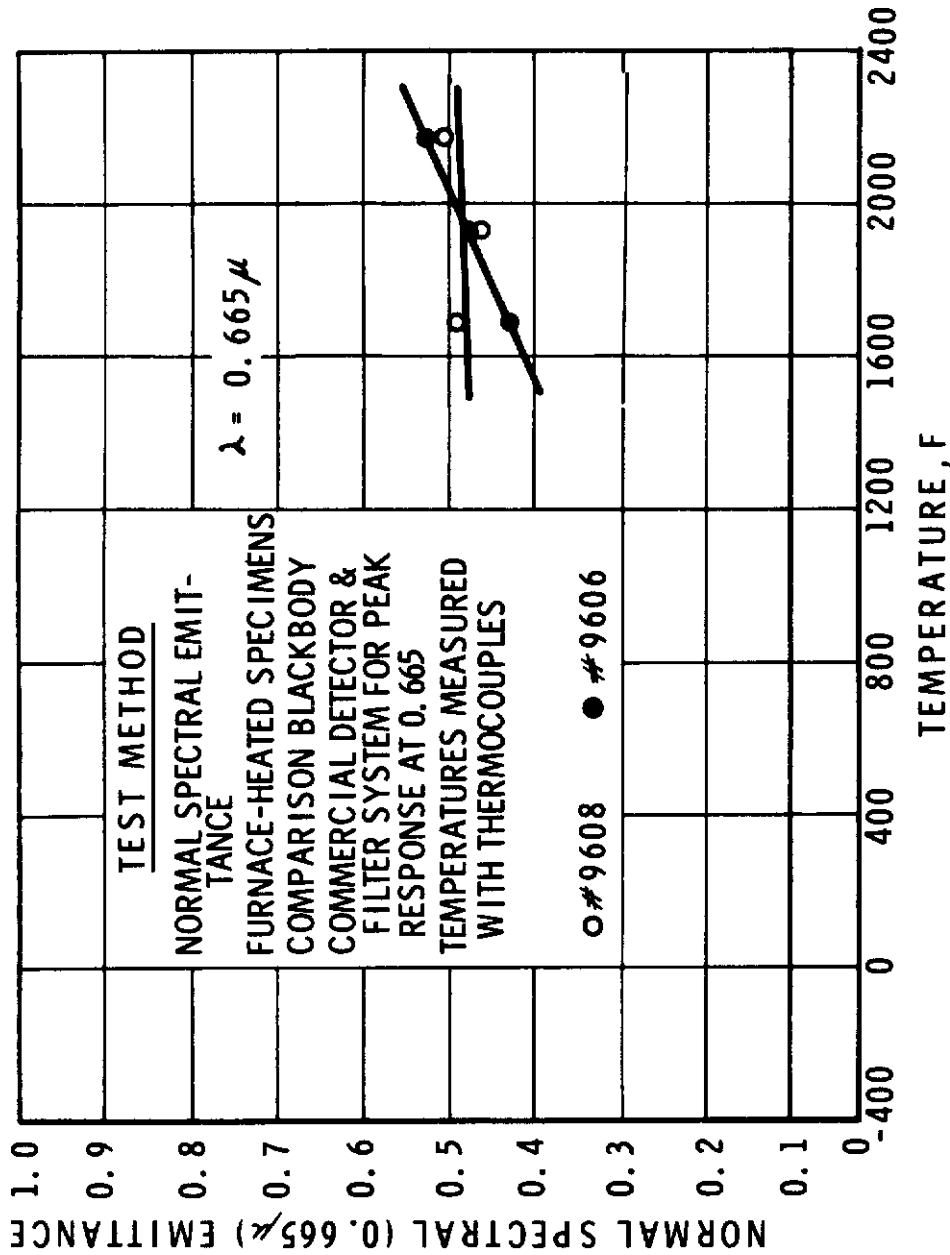

FIG. 52 NORMAL SPECTRAL EMITTANCE OF PYROCERAM
 #9606 AND #9608 (REF. 211)

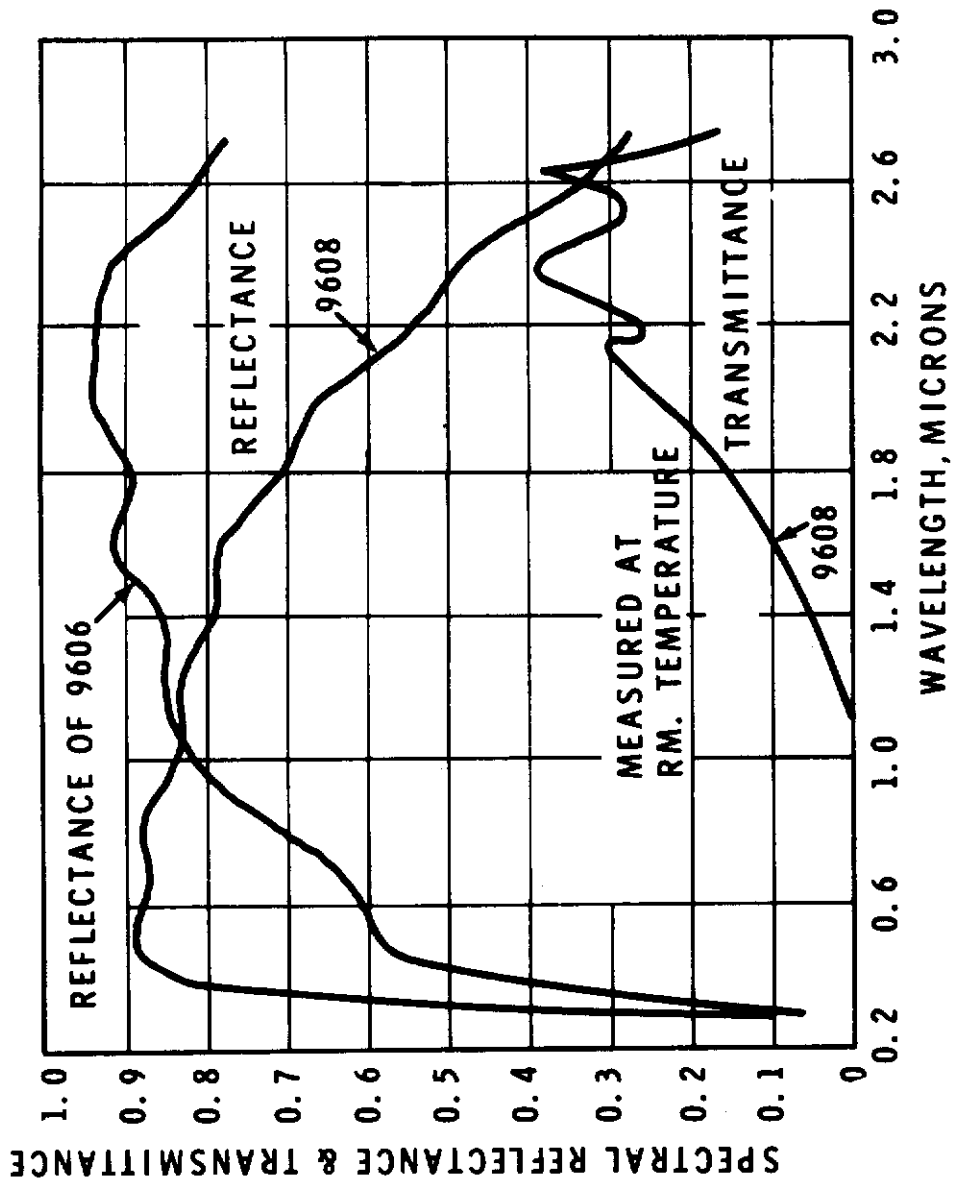

FIG. 53 SPECTRAL REFLECTANCE AND TRANSMITTANCE OF PYROCERAM 9606 and 9608, (REF. 166, 211, 212)

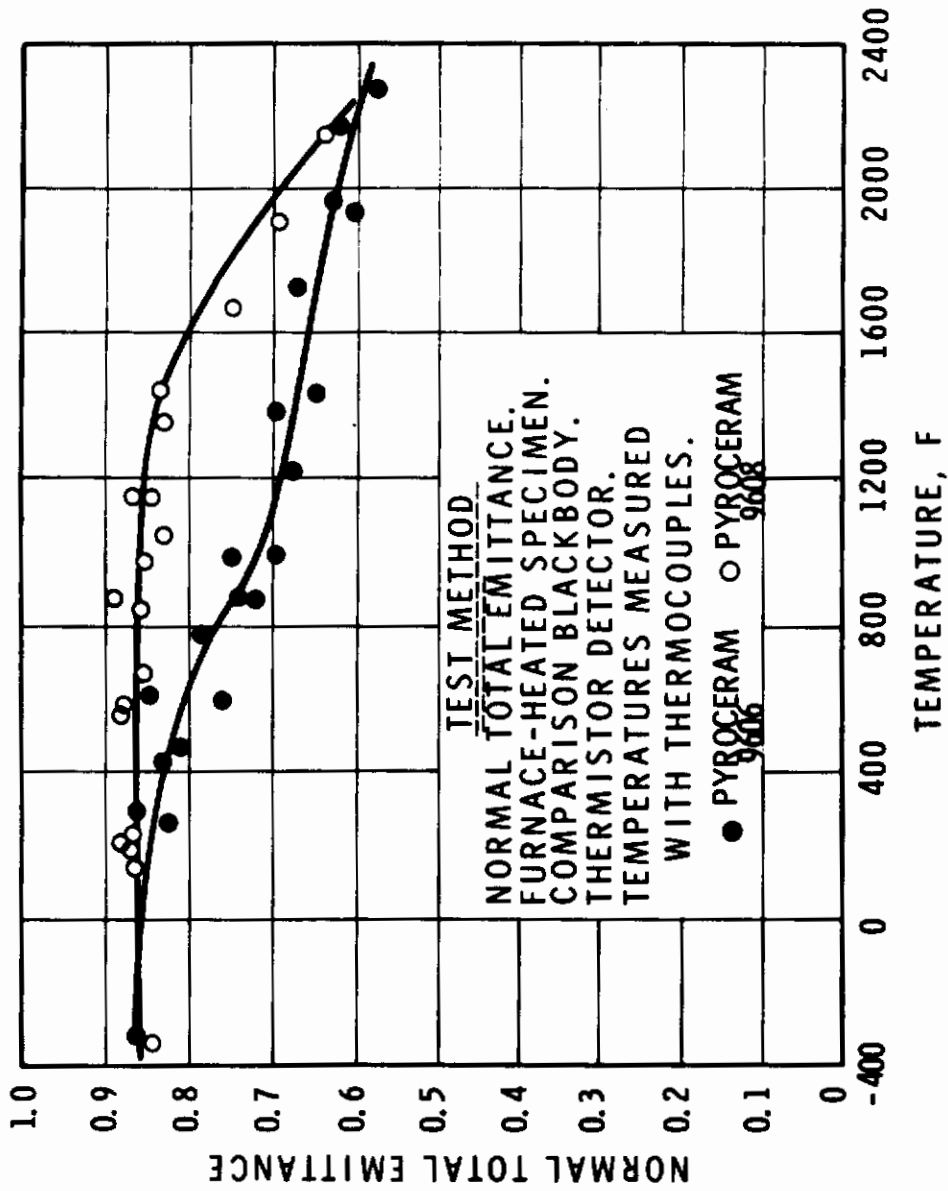

FIG. 54 NORMAL TOTAL EMITTANCE OF PYROCERAM 9608 & 9606 (REF. 24) (REF. 211,212)

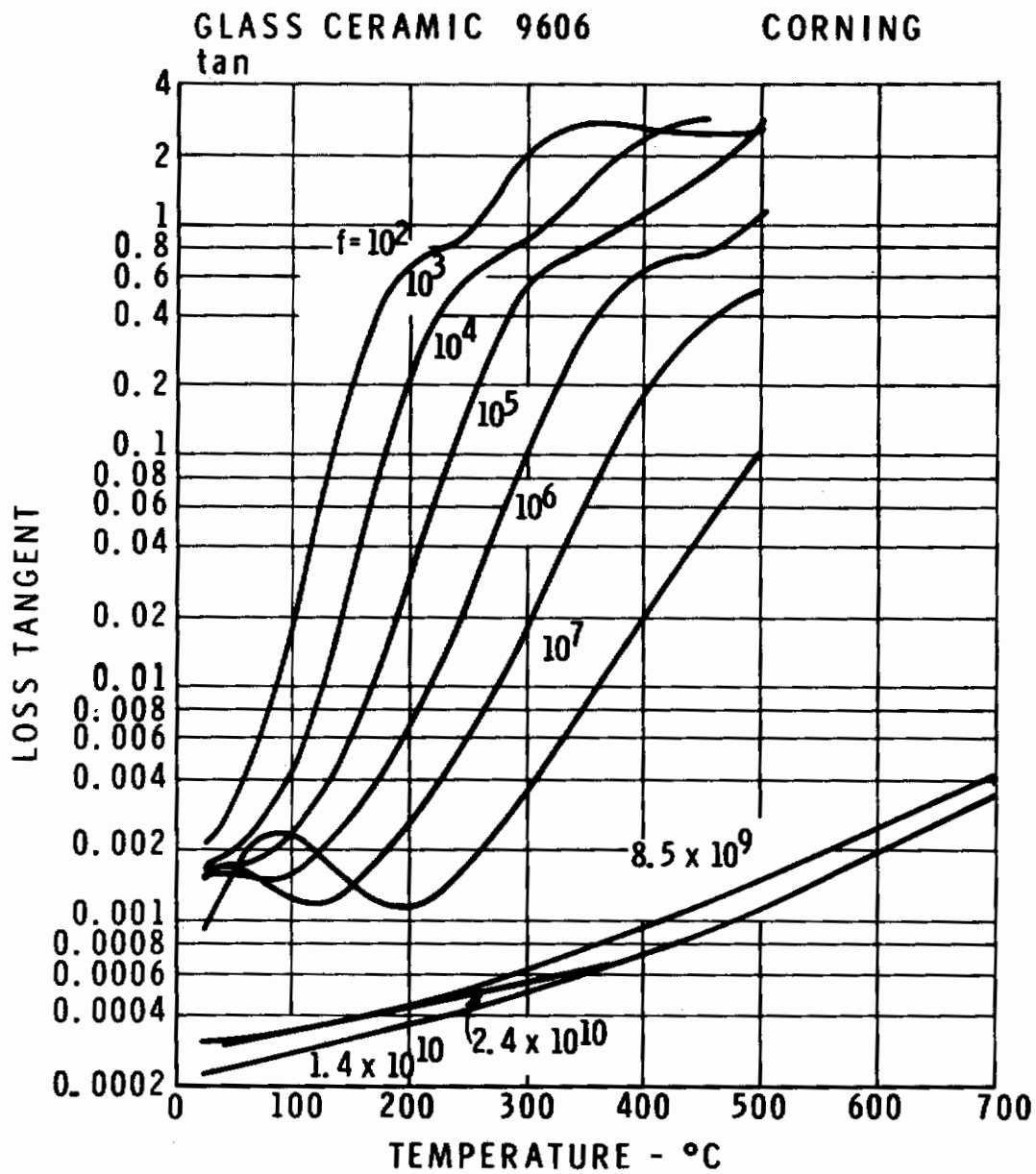
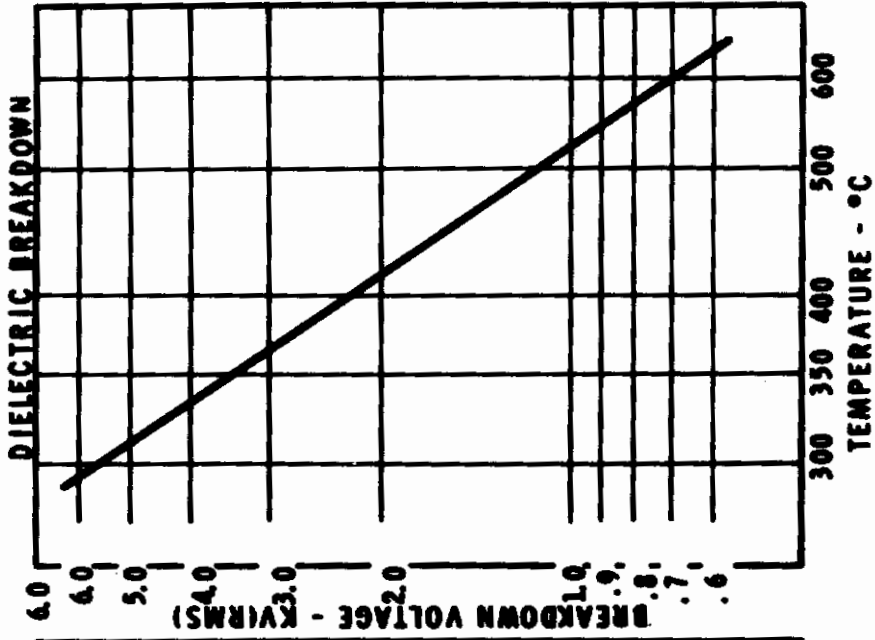
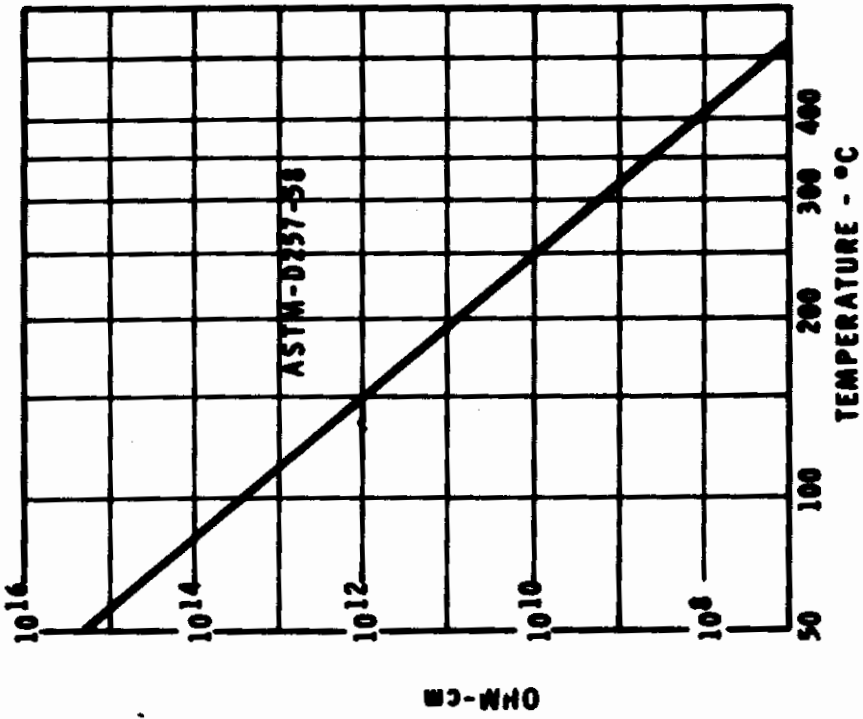

FIG. 55 TEST METHOD ATC REPORT NO. ARTC-4
REF. 166



DIELECTRIC BREAKDOWN
 BREAKDOWN VOLTAGE - KV(RMS)
 TEMPERATURE - °C
 1 MINUTE LIFE FOR 2MM THICKNESS AT
 60 cps & DC GLASS CERAMIC 9606
 FIG. 57
 (REF. 166)



VOLUME RESISTIVITY OF PYROCERAM
 9606
 FIG. 56 - (Ref. 166)