

AFFDL-TR-68-60

**A MULTIPLE TIME SCALES APPROACH TO
THE ANALYSIS OF LINEAR SYSTEMS**

RUDRAPATNA V. RAMNATH

*Princeton University
Princeton, New Jersey*

This document has been approved for public
release and sale; its distribution is unlimited.

FOREWORD

This investigation was in part supported by the Air Force Flight Dynamics Laboratory under Contract AF33(615)-3657, Project 8219, Task 821904. The contract monitor for the Flight Control Division, FDCC, was Mr. Paul E. Pietrzak. This report was submitted as a dissertation to the faculty of Princeton University in candidacy for the degree of Doctor of Philosophy. The dissertation was copyrighted by the author in 1967. The Government has unlimited rights in publication by contractual agreement.

It is with pleasure that the author wishes to acknowledge the assistance of several persons during the course of this investigation. The author is grateful to: his faculty advisor, Professor Dunstan Graham, for his advice and support throughout; to Dr. Guido Sandri for his keen interest and guidance through many stimulating discussions; and to Professor Wallace D. Hayes for several penetrating suggestions. Discussions with Dr. G. V. Ramanathan are also appreciated. Further thanks for interest in this work are due to Professors S. H. Lam, M. D. Kruskal, H. C. Curtiss, Jr., and P. M. Lion. The author appreciates the help of Mr. T. Williams for work done on the computer, and the work of Mr. T. J. Poli in drafting the figures. Finally the author is indebted to Claudi for painstakingly typing the final manuscript.

The dissertation was dedicated by the author to the memory of his father, Sri. R. Venkataramaiya.

Publication of this report does not constitute Air Force approval of the report's findings or conclusions. It is published only for the exchange and stimulation of ideas.

C. B. WESTBROOK

Chief, Control Criteria Branch
Air Force Flight Dynamics Laboratory

ABSTRACT

In this work an investigation is made of uniform approximations to the solutions of linear differential equations with variable coefficients. The ordinary differential equations are replaced by an appropriate set of partial differential equations that determine the unknown function in terms of a set of independent "time scales." The time scales are determined so as to obtain uniformly valid approximations. The partial differential equations, in conjunction with the requirement of uniformity of the approximation in a given interval, determine the time scales through a set of "clock functions" k_i , which may depend on the interval of interest. It is essential for the success of the approximation that the clock functions be nonlinear functions of time, in addition to being complex quantities. The constant coefficient case arises as a natural limit. Thus the present approach generalizes earlier time scale analyses. With this generalization we recover for second order systems the Liouville-Green (or WKBJ) approximation. The difference between the present approach and the PLK method is emphasized with examples.

Bounds on the errors committed are established for the second and third order equations. The use of two time scales (with nonlinear clocks) enables us to obtain approximations to the amplitude and phase of each of the modes of n^{th} order equations.

The prototypes that are of interest are the linearized equations governing the motion of VTOL aircraft. These equations constitute a system of rather high order in the time derivative (third or fourth order for motion in the plane of symmetry). The approximation method obtains the aircraft variables in terms of simply calculable functions of the stability derivatives. The frozen analysis of the aircraft equations suggests solutions of the simple form

$$\sum_i A_i e^{\lambda_i t}$$

with A_i and λ_i slowly varying in time. We introduce new independent

Contrails

variables (time scales) τ_{oi} and τ_{ii} to represent the amplitude and phase of the modes and express the aircraft motion in the form

$$\sum_i \alpha_i(\tau_{oi}) e^{i\tau_{ii}}$$

τ_{oi} and τ_{ii} being determined appropriately. The results of the approximation are compared with numerical integrals of the aircraft equations for the third order hovering system and the complete fourth order equations which allow for the transition from hover to forward flight. The approximation is found to be very accurate (to within 10% error) for the third order system. For the fourth order system comparable accuracy is obtained except near the transition point. However, qualitative features of the exact solution are not lost. A uniform description of the aircraft motion is thus obtained.

Contrails

· TABLE OF CONTENTS

	<u>Page</u>
CHAPTER I. INTRODUCTION	1
1.1 Origin of the Problem	1
1.2 Historical Sketch and Review of Existing Work	2
1.3 The Liouville-Green (or WKBJ) Approximation	5
1.4 Objectives of the Investigation	9
1.5 Arrangement of the Dissertation	11
CHAPTER II. ASYMPTOTIC REPRESENTATION AND UNIFORM VALIDITY	13
2.1 Nonuniformity in Approximations	13
2.2 The Concept of Extension	20
2.3 Application to Simple Examples	24
(a) Equations with Constant Coefficients	24
(b) Equations with Variable Coefficients	31
2.4 Asymptotology	37
2.5 Summary of the Chapter	40
CHAPTER III. DEVELOPMENT OF THE APPROXIMATION SCHEME	41
3.1 First Order Equation	41
3.2 Second Order Equation	43
(a) Canonical Form	43
(b) Noncanonical Form	54
3.3 Third Order Equation	58
3.4 The Linear Equation of Order n	65
3.5 Summary of the Chapter	71
CHAPTER IV. ERROR ANALYSIS	73
4.1 Some Basic Definitions and Useful Lemmas	74
4.2 Approximation Theorems for Second Order Equations	77
4.3 Derivation of Error Bounds: Second Order Equation	83
4.4 Third Order Equation	95

Contrails

	<u>Page</u>
4.5 Third Order Equation (Oscillatory Case)	103
4.6 Summary of Chapter and Conclusions	106
CHAPTER V. EXAMPLES AND APPLICATION	108
5.1 Examples with Known Solutions	108
5.2 Preliminary Remarks on the Transition Dynamics of VTOL Aircraft	115
5.3 The System	116
5.4 Two Degree-of-Freedom Case	119
5.5 Three Degree-of-Freedom Case	122
5.6 Summary of the Chapter	124
CHAPTER VI. CRITIQUE AND EXTENSION	126
6.1 Extension of the Method	126
6.2 Transition Point Analysis	128
6.3 Shifting of the Transition Point	130
6.4 Choice of the p Function	135
SUMMARY AND CONCLUSIONS	137
LIST OF TABLES	
TABLE 1 Nonuniformity in Perturbation Theory	139
TABLE 2 Extended Derivatives	140
TABLE 3 Stability Derivative Variation for Typical VTOL Aircraft	141
TABLE 4 Examples of Some Classical Equations	142
APPENDIX I Extension of the n^{th} Order Derivative	143
APPENDIX II Condition for the Invariance of the Amplitude Function w. r. t. the Characteristic Roots	146
APPENDIX III Condition for the Constancy of Sign of f_y	148
APPENDIX IV PLK Method Applied to a Secular Perturbation Problem	149
APPENDIX V Uniform Validity	152
REFERENCES	154

LIST OF ILLUSTRATIONS

Figure	Page
1. Approximations to Function f	159
2. Singular Perturbation	160
3. Boundary Layer Model	160
4. Slowly Decaying Exponential	160
5. Embedding in a "Space of Times"	161
6. Extension of the Domain	161
7. Function Surface in Extended Space	162
8. Trajectories for Restriction	162
9. Root Configuration; Stationary System	163
10. Simple Dynamic Model	164
11. Balancing of Terms	165
12. Maximal Balance for Roots as $\epsilon \rightarrow 0$	167
13. Root Locus: $y^{(n)} + \left(\frac{\epsilon}{t}\right)^n y = 0$	168
14. Axis System and Notation	169
15. VTOL Control for Trim vs. Speed	169
16. Decoupling Schematic for VTOL Equations	170
17. Trim Velocity Profile; $V(t)$	171
18. Characteristic Roots; Third Order u Equation	172
19. Solutions; $u(t)$, $\tilde{u}(\tau_0, \tau_1) _t$ for $(0, 0, 1)$ I. C.	173
20. Solutions; $u(t)$, $u_{\text{frozen}}(t)$, $\tilde{u}(\tau_1) _t$, $u(\tau_0, \tau_1) _t$ for $(0, 1, 0)$ I. C.	174
21. Solutions; $u(t)$, $u_{\text{frozen}}(t)$, $u(\tau_0, \tau_1) _t$ for $(1, 0, 0)$ I. C.	175
22. Variable Impulse Response; $u(t - 6)$, $\tilde{u}(\tau_0, \tau_1) _{(t - 6)}$	176
23. Variable Impulse Response; $u(t - 9)$, $\tilde{u}(\tau_0, \tau_1) _{(t - 9)}$	177
24. Characteristic Roots; Third Order θ Equation	178
25. Solutions; $\theta(t)$, $\tilde{\theta}(\tau_1) _t$, $\tilde{\theta}(\tau_0, \tau_1) _t$ for $(0, 0, 1)$ I. C.	179
26. Solutions; $\theta(t)$, $\tilde{\theta}(\tau_0, \tau_1) _t$ for $(0, 1, 0)$ I. C.	180
27. Solutions; $\theta(t)$, $\tilde{\theta}(\tau_0, \tau_1) _t$ for $(1, 0, 0)$ I. C.	181
28. Characteristic Roots; Fourth Order u Equation; Case (1)	182
29. Solutions; $u(t)$, $\tilde{u}(\tau_0, \tau_1) _t$; Case (1); $(0, 0, 0, 1)$ I. C.	183

Continuity
LIST OF ILLUSTRATIONS (CONT)

Figure	Page
30. Characteristic Roots; Fourth Order u Equation; Case (2)	184
31. Solutions; $u(t), \tilde{u}(\tau_0, \tau_1) _t$; Case (2), $(0, 0, 0, 1)$ I. C.	185
32. Characteristic Roots; Fourth Order u Equation; Case (3)	186
33. Solutions; Case (3); $u(t), \tilde{u}(\tau_0, \tau_1) _t$ I. C. corr. to 3 rd order	187
34. Solutions; $u(t), \tilde{u}(\tau_0, \tau_1) _t$; Case (3); $(0, 0, 1, 0)$ I. C. at 1	188
35. Characteristic Roots; Fourth Order u Equation; Case (4)	189
36. Solutions: $u(t), u_{\text{frozen}}(t), \tilde{u}(\tau_0, \tau_1) _t, \tilde{u}(\tau_1) _t$; Case (4) $(0, 1, 0, 0)$ I. C.	190
37. Solutions; $u(t), u_{\text{frozen}}(t), \tilde{u}(\tau_0, \tau_1) _t$; Case (4) $(1, 0, 0, 0)$ I. C.	191
38. Transition Point Shifting	192

CHAPTER I

INTRODUCTION

1.1 Origin of the Problem

This dissertation concerns the analysis of systems described by linear differential equations with variable coefficients. This is a classical problem, one that has attracted and occupied the interest of mathematicians and physicists since about the middle of the seventeenth century. The range of interest is vast, from esoteric fields of study such as topology and the qualitative theory of differential equations to the very practical task of analyzing actual systems arising in modern physics and engineering. The fields of applied mathematics and physics are replete with examples of linear differential equations with variable coefficients embracing such diverse disciplines as celestial, quantum and classical mechanics, wave motion in inhomogeneous media, rocket flight through the atmosphere, and so on.

The importance of the study of such systems has increased in recent years mainly because of three factors--the attempt to comprehend the more subtle phenomena in nature, and the advent of sophisticated dynamical systems of modern engineering, and the need to stabilize and control such systems. In the aerospace sciences, such problems arise for example in the analysis of the dynamics of motion of a vertical take off and landing (VTOL) type of aircraft from hover to forward flight. The aerodynamic parameters, since they depend on the flight condition, change continuously during the transition and the differential equations describing the motion have nonconstant coefficients. Another example is the motion of a space vehicle negotiating a flight from or reentry into the earth's atmosphere. The variation of density with altitude gives rise to variable coefficients in the differential equations.

Another way in which such equations arise is in the theory of partial differential equations. In problems which admit of the separation

of variables, the ordinary differential equations thus obtained will often contain variable coefficients. A well-known example is that of wave motion in inhomogeneous media. The wave equation yields, after separating the variables, a function periodic in time and a space dependent function which satisfies an ordinary differential equation with variable coefficients.

A similar problem also arises in dealing with nonlinear differential equations. The variational equations corresponding to a particular known solution of a nonlinear differential equation often turn out to be linear equations with variable coefficients. The variational equations may be useful in deducing stability information.

1.2 Historical Sketch and Review of Existing Work

In attempting to solve linear time-varying equations, the analyst is beset with considerable difficulty. The history of formal methods of integration practically ends in the latter half of the eighteenth century. The first order linear differential equation (l. d. e.) can be solved exactly by means of a quadrature. The second order l. d. e. with arbitrary coefficients, however, is quite another story. It can be shown (Ref. 1), though not without difficulty, that it cannot be solved in general by a finite number of quadratures and elementary operations. For particular variations of the coefficients, however, the various standard transcendental differential equations are obtained. For example, in the l. d. e.

$$y'' + \omega_1(t) y' + \omega_0(t) y = 0 \quad (1.2.1)$$

(The primes denote differentiation with respect to the independent variable t)
if $\omega_1 = \frac{1}{t}$ and $\omega_0 = 1 - \frac{n^2}{t^2}$, we obtain Bessel's equation of order n ;
if $\omega_1 \equiv 0$, $\omega_0 = -t$, the Airy equation; if $\omega_1 \equiv 0$, $\omega_0 = (a - 2q\cos 2t)$
(a, q constant) we have the familiar Mathieu equation, and so on. These are well known equations and exact solutions are available.

In all but the standard cases exact solutions are not known and the explicit forms of the asymptotic solutions cannot easily be written down.

Contrails

One has to resort to approximations under these circumstances, and the literature on this subject is very rich indeed. Many authors have contributed to the state of the art and the theory is quite extensive.

The idea basic to most of the schemes for approximation is to show that under certain conditions the given equation may be represented by another simpler equation which can be solved, such that the difference or the error between the two solutions is small. The most direct approach is that of perturbation theory introduced by Poincaré (Ref. 2) and this can be applied when there is a small parameter which exists in the physical system. Then direct perturbation theory yields approximations of better and better accuracy. There are many cases where such a representation becomes unsatisfactory over part of the domain of interest. This phenomenon is termed nonuniformity and will be examined in detail later. More sophisticated perturbation methods have been devised so as to overcome this difficulty (but sometimes only partially).

The available methods of analysis and their application to time-varying control systems have been examined in Ref. 3. There the methods are categorized into classical theory of differential equations, matrix methods, methods of integral transforms, etc. Approximations such as the method of collocation, Schellkunoff's wave perturbation method, etc., have been discussed in detail and examples given.

Among the many approximations existing in the literature, one which has enjoyed considerable fame is the so-called Liouville-Green (or WKBJ) approximation, sometimes named with other permutations of the letters. This name refers to the representation of the solution of the differential equation

$$y'' + h^2 \omega(t)y = 0; \quad \omega > 0 \quad (1.2.2)$$

in the form

$$y = A\omega^{-1/4} \exp(ih \int \omega^{1/2} dt) + B\omega^{-1/4} \exp(-ih \int \omega^{1/2} dt) \quad (1.2.3)$$

where A and B are arbitrary constants. The usefulness of such an approximation will be examined later and the conditions of validity established.

Contrails

The naming of this scheme of approximation has had a diverse history. Apparently the use of such approximate solutions may be traced to Carlini (1817) (Ref. 4) who considered a specific equation of the Bessel type. Liouville (Ref. 5) and Green (Ref. 6) (1837) derived the approximation for more general equations, although their derivations lacked rigor and were only valid in restricted regions of the complex plane. More recently the method has been referred to by physicists as the WKB method, after Wentzel (1926) (Ref. 7), Kramers (1926) (Ref. 8), and Brillouin (1926) (Ref. 9), though the letter J is often added to acknowledge the contribution of H. Jeffreys (1923)(Ref.10) in connecting the approximate solutions valid on either side of a transition point--a point on either side of which $\omega(t)$ has opposite signs; and H. Jeffreys (Ref. 11) has recently pointed out that he himself had been anticipated by Gans (Ref. 12). Just to complete the overwhelming list of the different names, Bailey (Ref. 13) has chosen to call it the "L. R. approximation", after Liouville (Ref. 5)(1837) and Rayleigh (Ref. 14) (1912). In a recent review article by B.S. Jeffreys (Ref. 15), the name asymptotic approximation method is suggested. Perhaps among all these various names, that of "phase-integral method" as used by Heading (Ref. 16) seems to be most appropriate as it does not refer either to its discoverer or to its method of derivation. Though the name WKBJ seems to be widely prevalent, we shall follow Olver (Ref. 28) and use the name "L-G approximation" after Liouville and Green who derived the approximation first.

It must be noted in passing that it is possible to raise some criticisms about the point of view adopted in the above method of approximation. However, approximations quite often serve a useful purpose in mathematical physics and engineering and have led to illuminating results in many cases. When valid the above approximation scheme shows, for example, the connection between classical and quantum mechanics by providing approximate solutions to Schrödinger's equation. In response to such criticisms the author cannot do better than to fall back on Heading (Ref. 17), who says, "For example, with no just foundation for such remarks, Smyth has criticized a paper making use of the method by writing: 'It should be

observed that the authors have used a solution which is a very poor approximation to the given problem as an approximate solution to another problem. It is certainly not to be expected that the results obtained in this manner will have any connection with the original problem.'

Introducing a new approach that leads to a difference in applicability, Hines has observed that his new method yields an approximate evaluation of the exact solution, rather than an exact evaluation of an approximate solution as is found in the WKBJ method!" Perhaps the wise remarks of Schellkunoff (Ref. 18) concerning the approximations should be recalled: "There is something in human nature that makes one yearn for the exact answer to a given problem. In particular it makes little difference whether a given problem is solved approximately or replaced by an approximating problem which is then solved exactly."

1.3 The Liouville-Green (or WKBJ) Approximation

This approximation can be derived by first converting (1.2.2) into the Ricatti equation

$$\frac{dz}{dt} + z^2 = \frac{-w}{\lambda^2} \quad (1.3.1)$$

by the transformation

$$\frac{y'}{y} = z; \quad y' \equiv \frac{dy}{dt}; \quad \lambda = \frac{1}{h}$$

where a small parameter λ has been introduced in (1.3.1). The equation (1.3.1) can be formally solved by expanding z as follows

$$z = \frac{1}{\lambda} \int_{t_0}^t dt \sum_{k=0}^{\infty} x_k \lambda^k \quad (1.3.2)$$

where t_0 is a constant. Substituting this into (1.3.1) and equating like powers of λ , we get a set of equations

Contrails

$$x_0 = \pm i\sqrt{\omega}$$

(1.3.3)

$$\frac{dx_{k-1}}{dt} = - \sum_{j=0}^k x_j x_{k-j} \quad k = 1, 2, 3, \dots$$

from which the series $\sum_{k=0}^{\infty} x_k \lambda^k$ can be determined. This is, for example, the method used by H. Jeffreys (Ref. 10).

It is known that this series is, in general, not convergent, but is only asymptotic. From the above we can get the LG approximation.

$$y(t) = \left(\frac{\omega}{\lambda^2}\right)^{-1/4} \exp\left[\pm i \int_{t_0}^t \frac{\omega^{1/2}}{\lambda} dt\right] \quad (1.3.4)$$

if we neglect the other terms. Similar derivations of this approximation are given in many books on quantum mechanics, but few give the precise conditions of validity.

The parameter λ was introduced only as a formal mathematical tool for obtaining the desired expansion for y . It is seen that both in the l.d.e. (1.2.2) and the LG solution (1.3.4), the parameter λ and the function $\omega(t)$ appear only in the combination $\frac{\omega}{\lambda^2}$, and so one can simply write ω instead of $\frac{\omega}{\lambda^2}$. The definiteness of the sign of $\omega^{1/2}$ must be ensured by branch cuts in the complex t plane radiating outwards from the zeros of ω , and the integration must take place along paths not crossing these cuts.

The above treatment is inadequate since neither estimates of the errors of the approximation nor the regions of validity in the complex plane are given. The solutions of equation (1.2.2) are single-valued in a domain containing no singularities of $\omega(t)$; but because of the fractional powers of $\omega(t)$ the LG solutions are not single-valued and so it is clear that the solutions (1.3.4) are valid only in restricted regions of the complex t plane.

One of the purposes of this work is to demonstrate a more general method of approximation which yields the LG solution as a special case

Contrails

as well as approximate solutions valid where the LG solution is not.

The study of asymptotic approximations to the solutions of l. d. e. would be incomplete without at least a brief discussion of the Stokes phenomenon. This name is given to the discontinuous changes in the arbitrary constants that occur in the asymptotic solutions of certain differential equations.

It is rather interesting to follow the beginnings of the observation of this phenomenon. In a letter to a certain young lady, Sir George Gabriel Stokes wrote in 1857 (Ref. 19) (and the present author wishes to beg the indulgence of the reader), "When the cat's away the mice are at play. I have been doing what I guess you won't let me do when we are married; sitting up till 3 o'clock in the morning fighting hard against a mathematical difficulty. Some years ago I attacked an integral of Airy's, and after a severe trial reduced it to a readily calculable form. But there was one difficulty about it which, though I tried till I almost made myself ill, I could not get over, and at last I had to give it up and profess myself unable to master it. I took it up again a few days ago, and after two or three days hard fight, I at last mastered it."

The phenomenon was first observed in connection with the Airy equation:

$$y'' - zy = 0$$

For small $|z|$, the general solution comprising of two independent power series solutions, would involve two fixed arbitrary constants. It was observed that if for a certain range of $\arg z$, the general solution was represented by a certain linear combination of the two asymptotic solutions, then in a neighboring range of $\arg z$ it was by no means necessary for the same linear combination to represent the same general solution. Stokes (Ref. 20) in fact showed that the arbitrary constants must be changed discontinuously on crossing certain lines in order to provide an asymptotic representation of a continuous function for both ranges of $\arg z$. These lines are called anti-Stokes lines.

The Stokes phenomenon occurs because an asymptotic series is not unique. For example, the two functions

$$\psi_1(z) = \frac{f(z)}{\omega(z)}$$

and

$$\psi_2(z) = \frac{f(z)}{\varphi(z)} + e^{-z}$$

have the same asymptotic expansion for $|z| \rightarrow \infty$ when $\text{Re}[z] > 0$. Besides, the asymptotic expansion for $\psi_2(z)$ will change drastically from $\text{Re}[z] > 0$ to $\text{Re}[z] < 0$. The asymptotic form of $\psi_2(z)$ as $\arg z$ changes would reveal a discontinuity at $\arg z = \frac{\pi}{2}, \frac{3\pi}{2}$, etc. These discontinuities are only apparent, however, and are essentially a result of the nonuniqueness of asymptotic expansions (Ref. 21).

One may also consider that the Stokes phenomenon occurs because the operations of analytic continuation and taking the asymptotic expansion do not commute. In other words, let $f(t)$ have the asymptotic expansion:

$$f(t) = f_0(t) + \epsilon f_1(t) + \dots$$

Let $f_1(t)$ be now analytically continued into $f_1(z)$. On the other hand, let the function $f(t)$ be analytically continued into $f(z)$. If we now obtain the asymptotic expansion

$$f(z) = f^{(0)}(z) + \epsilon f^{(1)}(z) + \dots$$

we will find that in general:

$$f_1(z) \neq f^{(1)}(z)$$

This is the Stokes phenomenon.

The Stokes phenomenon in LG theory arises as follows (Ref. 22).

The approximations to the solutions of

$$y'' + \omega(t)y = 0 \tag{1.3.5}$$

are given by

$$y_+(t; \gamma, \delta) = \delta \omega^{-1/4}(t) \cos\left(\int_a^t \omega^{1/2} dt + \gamma\right) \tag{1.3.6}$$

when ω is positive and

$$y_-(t; \alpha, \beta) = (-\omega(t))^{-1/4} \left\{ \alpha \exp\left(\int_a^t (-\omega)^{1/2} dt\right) + \beta \exp\left(-\int_a^t (-\omega)^{1/2} dt\right) \right\} \tag{1.3.7}$$

when $\omega(t)$ is negative. $\alpha, \beta, \gamma, \delta$ are arbitrary constants.

Contrails

When $\omega > 0$ (1.3.6) represents one solution of (1.3.5) with specific constants; and when $\omega < 0$ (1.3.7) also needs specific constants. If $\omega(t)$ changes sign in the interval of interest, then the requirement that (1.3.6) and (1.3.7) must represent the same solution in the entire interval thus correlates the forms (1.3.6) and (1.3.7) and the correlation is determined by the association of the respective constants. As $\omega(t)$ changes sign it is seen that both the forms (1.3.6) and (1.3.7) break down for two reasons:

(i) both become infinite when $\omega(t)$ vanishes

(ii) the equation for which (1.3.6) or (1.3.7) are exact solutions has singularities at the zeros of $\omega(t)$ and the functions (1.3.6) and (1.3.7) are multivalued in general in the vicinity of these singularities, i. e. transition points. These points are also called "turning points."

The representation of single-valued functions by multiple-valued functions can be expected to be valid only in a restricted region.

In fact, as Langer says (Ref. 22), merely because the pair of solutions

$$y(t) \sim y_+(t; \gamma, \delta)$$

(1.3.8)

$$y(t) \sim y_-(t; \alpha, \beta)$$

valid respectively on either side of a transition point exist, it is a non sequitur that the r.h. members of (1.3.8) represent one and the same solution of (1.3.5). The contrary is the case. For every specified γ, δ there correspond specific α, β . In order to deduce one form of asymptotic representation from the other, one depends on the so-called "Connection Formulae." These can be derived in two ways. One is by representing the solution near the transition point by the Airy function and connecting this to the asymptotic solutions on either side. The other is by a study of the Stokes phenomenon and thus connecting the asymptotic solutions on either side of a transition point. This will be discussed in a later section.

1.4 Objectives of the Investigation

From what has been said hitherto, it is evident that for the general l. d. e. of order greater than two, the best general result that can be

obtained is to get a good approximation with a knowledge of the errors committed in the use of such an approximation. Unless the coefficients have certain special forms, it is, in general, impossible to solve the equations exactly in terms of elementary functions and operations. Once this is realized, the aim is to get approximations and error estimates. Mathematicians, however, have been for the most part interested in areas which afford general conclusions regarding the mathematical properties. There is an extensive mathematical literature on the many aspects of linear differential equations and one may refer to the works of Hartman (Ref. 23), Feschenko et al (Ref. 24) etc. which contain extensive bibliographies. The engineer and the physicist, on the other hand, have been interested in approximations, insofar as they describe the physical system adequately, in order to glean some quantitative insight about the system.

The LG approximation seems to fill this gap satisfactorily for a number of applications. Physicists have used the method to great advantage particularly in the fields of quantum mechanics and radio wave propagation in the ionosphere (Ref. 25). However, the control systems engineers have generally stayed clear of this rather powerful method, except for some researchers such as Pipes (Ref. 26), who applied it to analyze time-varying networks. More recently Curtiss (Ref 27) has applied these ideas to the analysis of VTOL transition dynamics where he has developed a modified root-locus method to determine the "unsteady" roots, as deviations from the "quasi-steady" or the variable "characteristic" roots of the system. Using this technique one is able to draw sketches fairly quickly at a number of points and obtain information about the instantaneous "damping" and "frequency" of the modes of motion. These applications have broken the ice in regard to engineering dynamics analysis of variable systems and pointed the way to a more complete treatment of the problem. However, with reference to the VTOL transition dynamics, it is desirable to have a uniformly valid approximation throughout the transition from hover to forward flight. This naturally leads to the study of transition points or

Contrails

turning points. Error bounds, of course, make the theory more complete. In contrast to the LG approximation for the l.d.e. of second order, for which there is a substantial body of work covering these areas, no such complete theory exists for the third or higher order l.d.e. Since dynamic systems of the vehicular type are generally of higher order than the second, it is felt that the present work might fill in part this need.

In this thesis a scheme for approximations for l.d.e. with variable coefficients is developed. Explicit formulae for the approximate solutions are derived and this is done by appropriate extension of the independent variable, employing multiple time scales and proper "clock" functions (which are complex and nonlinear). The "frequency" and "amplitude" variation of the solution are extracted separately and are then combined to form a composite solution. The advantage is that one is able to retain, to some extent, the familiar ideas of stationary linear systems analysis.

Further, absolute error bounds are derived. It is clear that these are more useful than the usual O symbols of asymptotic analysis, which are necessarily somewhat vague. The question of transition points is then examined and a technique is proposed to circumvent the accompanying difficulties.

1.5 Arrangement of the Dissertation

The results presented in the dissertation are presented in the following manner. Chapter II presents the theory of the method of extension and multiple time scales which will form the basis of the results obtained in the dissertation. The method is applied to simple examples, and asymptotological principles are presented.

Chapter III contains the principal ideas of the thesis. Here the explicit formulae for the approximate solutions of l.d.e. with variable coefficients are derived using the method of extension. It is seen that for the second order l.d.e. the Liouville-Green (or WKBJ) solution is one of the approximations derived. The formulae for third and fourth order l.d.e. are derived and then the theory is generalized to the n^{th} order equation.

Contrails

In Chapter IV absolute bounds on the errors of the approximations are derived. For the second order equation, the error bounds for the WKBJ approximation are derived in a new and direct way different from that of Olver (Ref. 28) and asymptoticity of the approximations is demonstrated.

Chapter V contains the application of the above approximation to some analytical examples and the analysis of the dynamics of VTOL aircraft during transition from hover to forward flight. First the hover or two degree-of-freedom case is studied, and then the full three degree-of-freedom system is studied.

A brief sketch of the failure of the LG approximation near transition points is discussed in Chapter VI. An outline of some open problems is presented, together with a method of shifting the transition point out of the physical domain of interest.

In this work the word "canonical" is used to denote an equation of the n^{th} order in which the term containing the $(n-1)^{\text{th}}$ derivative does not appear.

CHAPTER II

ASYMPTOTIC REPRESENTATION AND UNIFORM VALIDITY

2.1 Nonuniformity in Approximations

In this chapter, the failure of the conventional perturbation approach in certain regions of interest and some well-known methods of dealing with it are presented briefly. The purpose is to provide a basis for the present work within the general framework of the theory of such approximations. Formal proofs are not presented.

We shall begin by illustrating what we mean by a uniformly valid approximation. Given a function $f(t)$ of quite an arbitrary shape (Fig. 1), $f_0(t)$ is said to be a uniformly valid approximation of $f(t)$ to order ϵ (where ϵ is a "small" parameter, i. e., $\epsilon \ll 1$) if and only if for all t :

$$f = f_0 + O(\epsilon); \text{ (or } f = f_0 + o(1) \text{)} \quad (2.1.1)$$

That is, the error between the function and its approximation is uniformly small within the domain of interest. A further discussion is given in Appendix V.

Contributions to the theory of uniformization of asymptotic expansions have come from many sources and it is difficult to do justice to all of them. The work of some authors, however, has been highlighted for purposes of orientation. In problems exhibiting the presence of a small parameter ϵ , approximations based on a direct perturbation expansion in powers of ϵ were first introduced by Poincaré (Ref. 2) in his researches on celestial mechanics. Often such a scheme leads to a serious misrepresentation of the true function and this phenomenon is called nonuniformity in the expansion. For example, direct expansion about hover, of the solution to the transition equations of motion of a VTOL aircraft fails to yield the correct long time behavior. Also the expansion of the solution of the Liouville equation of statistical mechanics, in powers of the strength of the

two-body interaction, breaks down for times of the order of the relaxation time to equilibrium; and so fails to give the crucial information on how a gas approaches equilibrium (Ref. 29).

The precise nature of the nonuniformity enables one to classify in the fashion of Sandri (Ref. 30) as follows.

(1) Singular type

Nonuniformity occurs for finite values of the independent variable.

(2) Matching type

Nonuniformity is manifest in that it is not possible to satisfy the initial or boundary conditions. This is usually because the inherent simplification of perturbation theory results in lowering the order of the original equation.

(3) Secular type

Nonuniformity occurs for large values of the independent variable.

The classification is only pragmatic and it must be noted that sometimes one type of problem can be transformed into the other.

The manner in which the nonuniformities arise is illustrated as follows with simple examples without plunging into lengthy calculations.

1. Singular Perturbation

Since only linear systems are of concern here, the linear analog of Lighthill's well-known example (Ref. 31, 32) (Linear Lighthill Model) suffices to illustrate the essential features of the phenomenon.

Consider the equation

$$(t + \epsilon) \frac{df}{dt} + f = 0 \quad (2.1.2)$$

with the condition: $f(1) = 1$ (2.1.3)

Direct perturbation theory yields:

$$f = f_0 + \epsilon f_1 + \dots$$

Contrails

$$t \frac{df_0}{dt} + f_0 = 0 \quad (2.1.4)$$

$$t \frac{df_1}{dt} + f_1 = - \frac{df_0}{dt}$$

Solving (2.1.4) we have:

$$f_0 = \frac{c_0}{t}, \quad f_1 = - \frac{c_0}{t^2} + \frac{c_1}{t}, \quad \text{etc.} \quad (2.1.5)$$

Imposing the condition (2.1.3):

$$f_0 = \frac{1}{t}, \quad f_1 = \frac{1}{t} - \frac{1}{t^2}, \quad \text{etc.} \quad (2.1.6)$$

Thus the approximation

$$f \approx \frac{1}{t} + \epsilon \left(\frac{1}{t} - \frac{1}{t^2} \right) + \dots \quad (2.1.7)$$

breaks down severely as t approaches zero.

Further it is observed from (2.1.5) that it is impossible to impose any arbitrary conditions at $t = 0$; Fig. 2 illustrates this. The exact solution is given by

$$f = \frac{c}{t + \epsilon}$$

where c is a constant.

2. Matching Type

Consider the constant coefficient equation

$$\epsilon \frac{d^2 f}{dt^2} + a \frac{df}{dt} + bf = 0 \quad (2.1.8)$$

with:

$$f(0) = 0, \quad \dot{f}(0) = c \quad (2.1.9)$$

Perturbation theory yields

$$a f_0' + b f_0 = 0$$

$$f_0'' + a f_1' + b f_1 = 0$$

having the solutions

$$f_0 = k_0 \exp(- (b/a)t), \quad (a) \quad (2.1.10)$$

$$f_1 = k_1 \exp(- (b/a)t) - k_0 t \exp(- (b/a)t) \quad (b)$$

where k_0, k_1 are arbitrary constants. Clearly conditions (2.1.9) cannot be met. Furthermore, the "correction" ϵf_1 eventually becomes larger than the lowest order term f_0 and therefore the expansion is not uniform for large t .

Equation (2.1.8) can, however, be solved exactly as

$$f(t) = c_0 e^{m_0 t} + c_1 e^{m_1 t} \quad (2.1.11)$$

where m_0, m_1 are the roots of:

$$m^2 + \frac{a}{\epsilon} m + \frac{b}{\epsilon} = 0$$

$$m_0 = -\frac{a}{2\epsilon} + \frac{1}{2} \left(\left(\frac{a}{\epsilon}\right)^2 - \frac{4b}{\epsilon} \right)^{\frac{1}{2}}$$

$$m_1 = -\frac{a}{\epsilon} - \frac{1}{2} \left(\left(\frac{a}{\epsilon}\right)^2 - \frac{4b}{\epsilon} \right)^{\frac{1}{2}}$$

c_0, c_1 can be chosen suitably; the solution is depicted in Fig. 3.

3. Secular type

Given the equation

$$\frac{df}{dt} + \epsilon f = 0 \quad (2.1.12)$$

with $f(0) = 1$, a direct perturbation expansion yields:

$$f_0 = 1, \quad f_1 = -t, \quad f_2 = \frac{t^2}{2} \dots \quad (2.1.13)$$

The approximation $f \approx f_0 + \epsilon f_1$ fails for $t \sim \frac{1}{\epsilon}$; the exact solution

$$f = \exp(-\epsilon t)$$

reveals the slow decay (Fig. 4).

Some techniques have been developed in order to render the approximate solutions uniformly valid. These methods of uniformization can be broadly classified as follows.

- (1) The Poincaré-Lighthill-Kuo or PLK Method
- (2) Method of Matched Asymptotic Expansions (Inner and Outer Expansions)
- (3) Method of Extension and Multiple Time Scales

The PLK Method (Ref. 32) is typically applied to singular perturbation problems. The method consists of suitably stretching the independent variable and moving the singularity out of the physical domain of interest. This is done in equation (2.1.2), for example, by expanding the independent variable t also in a series:

$$t = s + \epsilon t_1(s) + \epsilon^2 t_2(s) + \dots \quad (2.1.2 a)$$

The functions $t_1(s)$, $t_2(s)$, etc. are to be chosen so as to eliminate the nonuniform terms. This technique yields the exact solution for the above example. It is worth noting that even though in principle the PLK method and the time scales approach are similar, they in fact differ considerably in the mechanical details of the analysis. In Appendix IV we emphasize

this point with a simple example. One can, however, obtain connection between the stretching and clock functions, as was done, for example, by Sandri (Ref. 30). Conceptually, while the multiple time scales approach obtains the description of a phenomenon by following the gross features on one scale and fine ones on another, the main purpose of the PLK method is to move the singularities outside the domain of interest.

The method of "inner" and "outer" expansions consists in developing separate expansions (Ref. 33), each valid within a region, and matching them at the boundaries of these regions. This method has been typically applied to problems of the boundary layer type. The boundary layer approach and that of multiple scales have as a common feature the existence of separate scales, on each of which the unknown function exhibits different behaviors. However, in the former, the "inner" and "outer" solutions have to be matched at the common boundary or in a region of overlap. This usually calls for criteria based on intuition and seems to involve a certain amount of art in the process. The method of multiple scales, on the other hand, while it recovers the different behaviors, does not involve any matching, but consists in an extension of the independent variable into a space of more than one dimension. Further, it is a formal method and may lead to a systematic method of studying problems of the boundary layer type also.

In regard to (2.1.8) it can be shown that the fast variation of the solution for small values of t can be obtained in lowest order, by a suitable extension of the variables, given by:

$$t \Rightarrow \{ \tau_{-1}, \tau_0, \tau_1, \dots, \tau_n \} \quad (2.1.14)$$

$$f = f_0 + \epsilon f_1 + \dots$$

$\tau_i(t)$ are defined by:

$$\tau_{-1} = \frac{t}{\epsilon}, \quad \tau_0 = t, \quad \tau_1 = \epsilon t, \quad \dots, \quad \tau_n = \epsilon^n t$$

Contrails

The lowest order equation describes the "inner" solution. To obtain the behavior for values of t of order unity or greater, we do not have to consider an additional, "outer", expansion of the original equation. The term of the next order in the expansion already made obtains the "outer" solution. The time derivatives are now extended as:

$$\frac{d}{dt} \Rightarrow \frac{1}{\epsilon} \frac{\partial}{\partial \tau_{-1}} + \frac{\partial}{\partial \tau_0} + \epsilon \frac{\partial}{\partial \tau_1} + \dots \quad (2.1.15)$$

$$\frac{d^2}{dt^2} \Rightarrow \frac{1}{\epsilon^2} \frac{\partial^2}{\partial \tau_{-1}^2} + \frac{1}{\epsilon} \left(2 \frac{\partial^2}{\partial \tau_{-1} \partial \tau_0} \right) + \left(\frac{\partial^2}{\partial \tau_0^2} + 2 \frac{\partial^2}{\partial \tau_{-1} \partial \tau_1} \right) + \dots$$

In lowest order we have

$$\frac{\partial^2 f}{\partial \tau_{-1}^2} + a \frac{\partial f}{\partial \tau_{-1}} = 0 \quad (2.1.16)$$

with the solution:

$$f(\tau_{-1}, \tau_0, \dots) = -\frac{k_0}{a} (\tau_0, \tau_1, \dots) \exp(-a\tau_{-1}) + k_1 (\tau_0, \tau_1, \dots) \quad (2.1.17)$$

The equation in the next order is:

$$2 \frac{\partial^2 f}{\partial \tau_{-1} \partial \tau_0} + a \frac{\partial f}{\partial \tau_0} + b f = 0 \quad (2.1.18)$$

Substituting from (2.1.17) above:

$$2 \dot{k}_0 \exp(-a\tau_{-1}) - \dot{k}_0 \exp(-a\tau_{-1}) + a \dot{k}_1 \\ + b \left[-\frac{k_0}{a} \exp(-a\tau_{-1}) + k_1 \right] = 0$$

Regrouping terms:

$$\left(\dot{k}_0 - \frac{b}{a} k_0 \right) \exp(-a\tau_1) + (a\dot{k}_1 + bk_1) = 0 \quad (2.1.19)$$

We now equate the terms in each parenthesis to zero, which gives:

$$k_0 = L_1(\tau_1, \dots) \exp\left(+\frac{b}{a}\tau_0\right) \quad (a) \quad (2.1.20)$$

$$k_1 = L_2(\tau_1, \dots) \exp\left(-\frac{b}{a}\tau_0\right) \quad (b)$$

Upon restricting along $\tau_1 = \frac{t}{\epsilon}$, $\tau_0 = t$ we have:

$$f = c_1 \exp\left(-\frac{at}{\epsilon}\right) \exp\left(+\frac{b}{a}t\right) + c_2 \exp\left(-\frac{b}{a}t\right) \quad (2.1.21)$$

This process can go on to obtain higher approximations. It can be seen that (2.1.21) describes the correct behavior of the exact solution (2.1.11) to leading order.

For purposes of the present study, the method of extension and multiple scales is more pertinent; the primary interest here will be as it applies to multiple time scales, though in its general concept (Ref. 29) the method includes the other schemes also. A further discussion is given in the next section. An example of singular perturbation will, however, be considered and it will be solved by the time scales treatment.

The main aim is to show that the failure of the direct perturbation expansion has as its raison d'être an inappropriate scale on which the unknown function is observed. The natural scales or "clocks" which afford a uniform description of the phenomenon are determined by knowing the precise nature of the breakdown of the direct expansion.

2.2 The Concept of Extension

The method of extension was recently introduced as a mathematical technique designed to exploit as much as possible the presence of a small parameter if one is available in a problem. The aim is to render approximations of the perturbation type uniformly valid. The origin of the concept can be traced to the works of Bogoliubov, Krylov, and Mitropolsky, who allowed all the constants of the lowest order perturbation

theory to be slowly varying functions. The original ideas of Bogoliubov and Krylov (Ref. 34) were extended and modified in the recent work (translated into English) of Bogoliubov and Mitropolsky (Ref. 35), which provides a broad theoretical framework for the method of averaging. The method of time scales in its early form was applied to certain nonlinear differential equations by Cole and Kevorkian (Ref. 36); Frieman (Ref. 37) and Sandri (Ref. 29) used it in the theory of irreversible processes. Sandri (Ref. 38) has also discussed a general technique of uniformization of asymptotic expansions and has shown some of the well-known uniformization procedures to emerge as special cases of such a general technique, by introducing a complete reparametrization of the lowest order term of the perturbation expansion. The development of the theory given in Ref. 38 is rather abstract and relies on the composition of mappings. Precise conditions of validity of any special form of the method are not established and it is here that the present work seeks to fill a gap.

The fundamental idea is to extend the domain of the independent variable using suitable "clocks" determined by knowing the precise nature of the nonuniformities arising in direct perturbation theory. It should be noted that the variables in general are not restricted to be real. The "clocks" are so chosen that the new terms that arise due to extension, called "counterterms", eliminate the nonuniformities of direct perturbation theory so that in the extended domain uniform approximations to the unknown function can be obtained.

The concept becomes more transparent by a re-examination of (2.1.12). The solution f is represented as

$$f = 1 - \epsilon t + \frac{\epsilon^2 t^2}{2!} - \frac{\epsilon^3 t^3}{3!} \tag{2.2.1}$$

which is a convergent series and can be summed to the exact solution $f = \exp(-\epsilon t)$. In general the perturbation series is not summable and one has to resort to the k^{th} order approximation:

$$f \approx 1 - \epsilon t + \frac{\epsilon^2 t^2}{2!} - \dots + (-1)^k \frac{\epsilon^k t^k}{k!} \tag{2.2.2}$$

Clearly this fails for $t \sim \frac{1}{\epsilon}$, since all terms will attain the same order of magnitude. The fact is that in representing a function by a series, we want the leading term to give maximum information and hence we look for an asymptotic expansion rather than a convergent one. These have the property that successive terms decrease in magnitude up to a point, beyond which they may start

growing. The series is terminated at this point and provides a useful means of computing the function (Ref. 39, 40). With this in mind we see that the first few terms of the series (2.2.2) do not represent the true solution adequately for long times.

A clearer physical picture comes into view when we consider the function

$$f(t) = \exp\left(-\frac{\epsilon t}{t_*}\right) \quad (2.2.3)$$

from a different standpoint. t_* is a fixed constant with dimensions of time, and f represents a physically observable quantity such as displacement from a reference position, or temperature difference between two insulated bodies. An observer who measures f and records it using a clock whose unit of time is t_* will have to wait a long time (the longer for smaller ϵ) before he can observe a perceptible change in f . Instead, if our observer were to use the slow variable $\tau_1 = \epsilon t$, or a "super" clock which measures t in giant units of $\frac{t_*}{\epsilon}$, the phenomenon is seen much better, for then (2.2.3) is

$$f(t) = \exp\left(-\frac{\tau_1}{t_*}\right)$$

which is indeed the exact representation of f . Thus the method of extension enables us to perform readings on appropriate scales by employing a sufficient number of independent observers.

Consider a three-dimensional space (Fig. 5) with orthogonal axes τ_0 , τ_1 , and \underline{f} . Readings on "fast" and "slow" clocks are represented respectively by points along τ_0 and τ_1 coordinates and \underline{f} is defined to be the function

$$\underline{f}(\tau_0, \tau_1) = c \exp(-\tau_1) \quad (2.2.4)$$

where c is a constant. Graphically, $\underline{f}(\tau_0, \tau_1)$ is represented by a cylindrical surface in Fig. 5 which is constant in τ_0 , but decays exponentially in τ_1 .

To relate $\underline{f}(\tau_0, \tau_1)$ to $f(t)$, let $\tau = \frac{t}{t_*}$,

From (2.2.3):

$$f[\tau] = \exp[-\epsilon\tau]$$

Choosing $c=1$, (2.2.4) gives

$$\underline{f}(\tau, \epsilon\tau) = \exp(-\epsilon\tau)$$

(2.2.5)

i.e.,
$$\underline{f}(\tau, \epsilon\tau) = f[\tau]$$

and $\underline{f}(\tau_0, \tau_1)$ is said to be an extension of $f(t)$.

Based on these considerations, Sandri (Ref. 29) defines extension formally in the following manner.

Definition. Given a function $f(t)$ where t is in general an n dimensional vector, and a function $\underline{f}(\tau_1, \tau_2, \dots, \tau_N)$ of the N independent variables $\tau_1, \tau_2, \dots, \tau_N$ (each of which is an n dimensional vector), \underline{f} is said to be an extension of f if and only if there exists a set of $N \times n$ equations

$$\tau_n = \tau_n(t), \quad n = 1, 2, \dots, N$$

which when inserted into \underline{f} give:

$$\underline{f}(\tau_1(t), \tau_2(t), \dots, \tau_N(t)) = f[t]$$

The space of N -tuplets $\underline{\tau} = \{ \tau_1, \tau_2, \dots, \tau_N \}$ is called the extension of the domain $\{\tau\}$ and the equations $\tau_n = \tau_n(t)$ are called the "trajectories" in the extended domain. In dealing with differential equations, the derivatives and indeed the entire differential expression itself can be treated as a function and can be suitably extended. Thus, given

$$\varphi \equiv \frac{df}{dt} + \epsilon f = 0$$

one extension of φ can be written as

$$\underline{\varphi} \equiv \frac{\partial f}{\partial \tau_0} + \epsilon \frac{\partial f}{\partial \tau_1} + \epsilon \underline{f} = 0$$

where $\varphi \Rightarrow \underline{\varphi}; \quad f \Rightarrow \underline{f}; \quad t \Rightarrow \{ \tau_0, \tau_1 \}$

with: $\tau_0 = t, \quad \tau_1 = \epsilon t$

In general $\tau_n = \tau_n(\epsilon, t)$.

It is evident that there are infinitely many extensions which correspond to a given function. Two degrees of freedom are available: choice of the trajectories and choice of the extension itself. This freedom is utilized in obtaining an \underline{f} with simpler and smoother dependence on the parameter than that offered by f , and requiring the approximate solutions to be uniformly valid in the domain of interest. Figures 6, 7, and 8 illustrate the concept of extension.

2.3 Application to Simple Examples

(a) Equations with Constant Coefficients

The theory discussed in the last section will now be applied to simple examples. First l.d.e. with constant coefficients are discussed, beginning with the first order equation; and the method is then shown to work for two special types of equations with variable coefficients. The aim is to extract the leading behavior of the solutions and this is done by an extension of the domain of the independent variable alone. Throughout the rest of this work primes denote differentiation with respect to (w.r.t) the independent variable.

(1) Slow Exponential Decay. Consider the first order l.d.e. (2.1.12) which is:

$$\frac{dy}{dt} + \epsilon y = 0 ; y(0) = 1 ; 0 < \epsilon \ll 1 \quad (2.1.12)$$

The variable y and t are extended as follows

$$\begin{aligned} y &\implies \underline{y} \\ t &\implies \{\tau_0, \tau_1, \tau_2, \dots, \tau_n\} \end{aligned}$$

with $\tau_0 = t$, $\tau_1 = \epsilon t$, $\tau_2 \equiv \tau_3 \dots \equiv \tau_n \equiv 0$. Then:

Contrails

$$\frac{d}{dt} \Rightarrow \frac{\partial}{\partial \tau_0} + \frac{\partial}{\partial \tau_1} \frac{d\tau_1}{dt} + \frac{\partial}{\partial \tau_2} \frac{d\tau_2}{dt} + \dots + \frac{\partial}{\partial \tau_n} \frac{d\tau_n}{dt} = \frac{\partial}{\partial \tau_0} + \epsilon \frac{\partial}{\partial \tau_1} \quad (2.3.1)$$

On applying (2.3.1) to (2.1.12) and equating like powers of ϵ , we have:

$$\frac{\partial y}{\partial \tau_0} = 0 \quad (2.3.2)$$

$$\frac{\partial y}{\partial \tau_1} + \Sigma = 0 \quad (2.3.3)$$

From (2.3.2) and (2.3.3)

$$\Sigma(\tau_0, \tau_1) = A(\tau_1) = \exp(-\tau_1)$$

which is the exact solution of (2.1.12) when y is restricted along $\tau_0 = t$; $\tau_1 = \epsilon t$. Fig. 9 a shows a schematic of the root configuration.

(2) Second Order Equation. Consider the equation (Fig. 9 b)

$$y'' + (a + \epsilon)y' + \epsilon ay = 0 \quad (2.3.4)$$

where a is a constant of order unity. Direct perturbation theory results in secular nonuniformity as follows

$$y = y_0 + \epsilon y_1 + \dots$$

$$y_0'' + ay_0' = 0$$

$$y_1'' + ay_1' = -(y_0' + ay_0)$$

etc., giving

$$y_0 = -\frac{c_0}{a} \exp(-at) + c_1$$

$$y_1 = -c_2 t - \frac{c_2}{a} \exp(-at) + c_3, \text{ etc.}$$

where c_0, c_1, c_2, c_3 are constants.

On the other hand, extension yields:

$$y(t) \implies y(\tau_0, \tau_1)$$

$$t \implies \{\tau_0, \tau_1\}; \tau_0 = t, \tau_1 = et$$

$$\frac{\partial^2 y}{\partial \tau_0^2} + a \frac{\partial y}{\partial \tau_0} = 0 \tag{a}$$

$$2 \frac{\partial^2 y}{\partial \tau_0 \partial \tau_1} + a \frac{\partial y}{\partial \tau_1} + \frac{\partial y}{\partial \tau_0} + ay = 0 \tag{b} \text{ (2.3.5)}$$

$$\frac{\partial^2 y}{\partial \tau_1^2} + \frac{\partial y}{\partial \tau_1} = 0 \tag{c}$$

Integration gives:

$$y(\tau_0, \tau_1) = -A \frac{(\tau_1)}{a} \exp(-a\tau_0) + B(\tau_1) \tag{2.3.6}$$

Substituting in (2.3.5 b):

$$A' \exp(-a\tau_0) + a(B' + B) = 0$$

Since τ_0 and τ_1 are independent, $A'=0$ and $B' + B=0$. This gives

$$A = \text{pure constant} \tag{2.3.7}$$

$$B = C \exp(-\tau_1)$$

From (2.3.6) and (2.3.7) restricting $y(\tau_0, \tau_1)$ along the trajectories $\tau_0 = t, \tau_1 = et$, we have the general solution of equation (2.3.4) as

$$y(t) = c_0 \exp(-at) + c_1 \exp(-\epsilon t) \quad (2.3.8)$$

c_0, c_1 are constants, which is the exact solution.

Similarly in the second order oscillatory case of (i) low frequency, large damping; and (ii) high frequency, low damping, the choice of simple time scales separates the damped from the oscillatory motions. One can then extract these separately and combine them to give the exact answer.

(3) Third and Fourth Order Equations. Using the same approach as above, third and fourth order l.d.e. with constant coefficients can be solved exactly by a judicious choice of time scales. For example, the following two cases of the third order equation can be considered.

- (i) oscillatory mode with low frequency and low damping;
heavily damped non-oscillatory mode (Fig. 9 c(i))
- (ii) oscillatory mode with high frequency and large damping;
lightly damped non-oscillatory mode (Fig. 9 c(ii))

As an example of (i) consider the l.d.e.

$$y''' + (a + 2\epsilon)y'' + 2\epsilon(a + \epsilon)y' + 2a\epsilon^2 y = 0 \quad (2.3.9)$$

where a, ϵ are constants; $a \sim 1, 0 < \epsilon \ll 1$.

Direct perturbation theory fails because of the appearance of secular terms as shown below.

$$y_0''' + ay_0'' = 0$$

$$y_1''' + ay_1'' = -2(y_0'' + ay_0')$$

giving
$$y_0(t) = \frac{c_0}{a^2} \exp(-at) + c_1 t + c_2$$

$$y_1''' + ay_1'' = -2ac_1$$

Integration leads to secular terms.

Contrails

The choice of simple time scales as in (2.3.1) yields, in a straightforward manner

$$y = \frac{A(\tau_1)}{a^2} \exp(-a\tau_0) + B(\tau_1) \tau_0 + \tau(\tau_1) \quad (2.3.10)$$

$$A' \exp(-a\tau_0) + 2a(B' + B) = 0$$

giving

$$A = \text{pure constant}$$

$$B = D_1 \exp(-\tau_1)$$

$$C = D_2 \exp((-1+i)\tau_1) + D_3 \exp((-1-i)\tau_1)$$

Upon restriction along $\tau_0 = t$, $\tau_1 = \epsilon t$, we can write

$$y(t) = C_1 \exp(-at) + C_2 \exp((-1+i)\epsilon t) + C_3 \exp((-1-i)\epsilon t)$$

which is the exact general solution of (2.3.9).

The procedure is the same for fourth and higher order systems. When the motion has well-separated modes a proper choice of time scales yields the correct answer in a straightforward way. A typical fourth order example is that of the airplane longitudinal equations of motion which exhibit two oscillatory modes, one of high frequency, heavy damping, and the other of low frequency, low damping, being recognized respectively as the short period and phugoid modes.

Independent work in this connection has been recently reported by H. Ashley (Ref. 52). He considers the constant coefficient l.d.e. describing the aircraft motion, and obtains approximate solutions, order by order. He also achieves a rough separation of the performance and dynamic response problems. For both these questions, he employs linear time scales, in the fashion of Kevorkian (Ref. 36). Our approach differs from Ashley's in that we are able to recover exact solutions of linear equations with constant coefficients. This is done by choosing a proper power of the small parameter ϵ as the expansion parameter. Further remarks

on the comparison of Ashley's work and ours are made in Chapter V, Section 5.3.

The method is illustrated by the following example of the fourth order system:

$$y'''' + 2(a+\epsilon)y'''' + (b + 4a\epsilon + 2\epsilon^2)y'' + 2\epsilon(b + 2a\epsilon)y' + 2b\epsilon^2y = 0 \quad (2.3.11)$$

where a, b are constants of order unity and $0 < \epsilon \ll 1$. Direct perturbation theory obtains

$$y_0'''' + 2ay_0'''' + by_0'' = 0 \quad (2.3.12)$$

$$y_1'''' + 2ay_1'''' + by_1'' = -2(y_0'''' + 2ay_0'' + by_0') \quad (2.3.13)$$

etc. Integrating

$$y_0(t) = \frac{C_0}{m_1^2} \exp(m_1 t) + \frac{C_1}{m_2^2} \exp(m_2 t) = C_2 t + C_3 \quad (2.3.14)$$

where C_0, C_1, C_2, C_3 are constants and m_1, m_2 are the roots of

$$m^2 + 2am + b = 0 \quad (2.3.15)$$

Substituting in (2.3.13):

$$y_1'''' + 2ay_1'''' + by_1'' = \text{constant}$$

Integration clearly leads to secular terms.

Extending t as in (2.3.1) yields:

$$y(\tau_0, \tau_1) = A(\tau_1) e^{m_1 \tau_0} + B(\tau_1) e^{m_2 \tau_0} + C(\tau_1) \tau_0 + D(\tau_1) \quad (2.3.16)$$

$$2 \frac{\partial^4 y}{\partial \tau_0^2 \partial \tau_1} + 3a \frac{\partial^3 y}{\partial \tau_0^2 \partial \tau_1} + \frac{\partial^3 y}{\partial \tau_0^3} + b \frac{\partial^2 y}{\partial \tau_0 \partial \tau_1} + 2a \frac{\partial^2 y}{\partial \tau_0^2} + b \frac{\partial y}{\partial \tau_0} = 0 \quad (2.3.17)$$

$$6 \frac{\partial^4 y}{\partial \tau_0^2 \partial \tau_1^2} + 6a \frac{\partial^3 y}{\partial \tau_0 \partial \tau_1^2} + 6 \frac{\partial^3 y}{\partial \tau_0^2 \partial \tau_1} + b \frac{\partial^2 y}{\partial \tau_1^2} + 8a \frac{\partial^2 y}{\partial \tau_0 \partial \tau_1}$$

Contrails

$$+ 2 \frac{\partial^2 y}{\partial \tau_0^2} + 2b \frac{\partial y}{\partial \tau_1} + 4a \frac{\partial y}{\partial \tau_0} + 2by = 0 \quad (2.3.18)$$

Substituting (2.3.16) in (2.3.17) and observing the linear independence of the exponentials, A and B are deduced to be pure constants and $C = E \exp(-\tau_1)$. Substituting this in (2.3.18) and simplifying,

$$E \equiv 0 \text{ and } \mathcal{D} = \rho_1 e^{n_1 \tau_1} + \rho_2 e^{n_2 \tau_1} \quad (2.3.20)$$

where n_1, n_2 are the roots of $n^2 + 2n + 2 = 0$. The solution therefore is:

$$y(\tau_0, \tau_1) = c_1 e^{m_1 \tau_0} + c_2 e^{m_2 \tau_0} + c_3 e^{n_1 \tau_1} + c_4 e^{n_2 \tau_1} \quad (2.3.21)$$

where m_1, m_2 and n_1, n_2 satisfy

$$m^2 + 2am + b = 0 \quad (a) \quad (2.3.22)$$

and

$$n^2 + 2n + 2 = 0 \quad (b)$$

respectively (Fig. 9 d). The restriction $\tau_0 = t, \tau_1 = \epsilon t$ obtains the exact solution.

A similar approach can be used for higher order equations also. The important point to note is the existence of separate time scales as evidenced by the presence of a small parameter ϵ . The precise power of ϵ that appears in a time scale can be obtained by applying Kruskal's principle of maximal balance discussed in the last section of this chapter. Though l. d. e. with constant coefficients are not difficult to solve, the examples above were presented mainly for purposes of preserving some order in the development of the method, rather than for pedantry. Furthermore, in high order systems the extraction of the different behaviors individually is useful in providing a different point of view and may obviate to some extent the labor of factoring high order characteristic polynomials.

(b) Equations with Variable Coefficients

(1) Singular Perturbation. The method will now be applied to a problem of the singular perturbation type. The linear Lighthill model is reconsidered in light of the theory of multiple time scales. The governing equation is:

$$(t + \epsilon) \frac{df}{dt} + f = 0; \quad f(1) = 1 \quad (2.1.2)$$

We have already seen that direct perturbation is singularly nonuniform. The independent variable is extended as

$$t \Rightarrow \{ \tau_0, \tau_1 \} \quad \text{with } \tau_0 = c + t \text{ or } \dot{\tau}_0 = 1$$

$$\tau_1 = \epsilon k(t)$$

where c is a constant and $k(t)$ is as yet an undetermined clock function.

Case (i) $c = O(1)$

The extended equations are, to order ϵ :

$$(\tau_0 - c) \frac{\partial f_0}{\partial \tau_0} + f_0 = 0 \quad (2.3.23)$$

$$(\tau_0 - c) \frac{\partial f_1}{\partial \tau_0} + f_1 = - \frac{\partial f_0}{\partial \tau_0} + \dot{k} (\tau_0 - c) \frac{\partial f_0}{\partial \tau_1} \quad (2.3.24)$$

Integrating (2.3.23) :

$$\frac{f_0}{\tau_0 - c} = \frac{A(\tau_1)}{\tau_0 - c}$$

If $f_0 + \epsilon f_1$ is to be an approximation to f uniformly then the ratio $\frac{f_1}{f_0}$ must be uniformly bounded. On integrating (2.3.24) this ratio can be written as:

$$\frac{f_1}{f_0} = \int \left(\frac{A'}{A} \dot{k} - \frac{1}{(\tau_0 - c)^2} \right) d\tau_0 + \frac{B}{A} (\tau_1) \quad (2.3.25)$$

The counterterm k must be chosen so as to cancel the nonuniformity arising in direct perturbation theory. Setting the integrand to zero is sufficient to

Contrails

ensure the boundedness of $\frac{f_1}{f_0}$ uniformly in τ_0 . This proves to be convenient as it enables us to determine $A(\tau_1)$ and $k(\tau_0)$. However, it must be noted that this is only a particular choice and the freedom in the choice of the clock function can be exploited in other ways also. We require uniformity of the extended function along the trajectories $\tau_0(t)$ and $\tau_1(\epsilon, t)$. But one may for example demand uniformity in the τ_0, τ_1 plane. In this case $A(\tau_1)$ should not vanish at $\tau_1 = 0$. The behavior of $B(\tau_1)$ must be determined by going to the next order.

Further, we may note that if only the independent variable in (2.1.2) had been extended, the above condition would, of necessity, have to be satisfied.

Thus we can write

$$\frac{A(\tau_1)}{(\tau_0 - c)^2} = k A' \quad (2.3.26)$$

i. e.:

$$\frac{A'}{A}(\tau_1) = \frac{1}{k(\tau_0 - c)^2} = c_1 = \text{constant} \quad (2.3.27)$$

Hence:

$$A = D \exp(c_1 \tau_1)$$

$$k = \frac{1}{c_1} \frac{1}{(\tau_0 - c)}$$

After restricting $\tau_0 = t+c$, $\tau_1 = \epsilon k(t)$ we can write:

$$\left. \frac{f_0}{f_0}(\tau_0, \tau_1) \right|_t = \frac{D}{t} e^{-\epsilon/t} \quad (2.3.28)$$

This is an improvement on direct perturbation theory in that $f_0(t)$ is finite at the origin; however, it is not very useful as $f_0(t)$ is forced to go to zero at $t=0$.

We shall, therefore, consider the next case.

Case (ii) $c = O(\epsilon)$; $c = \epsilon a$, $a = O(1)$

The extended equations now are:

$$\tau_0 \frac{\partial f_0}{\partial \tau_0} + f_0 = 0 \quad (2.3.29)$$

$$\tau_0 \frac{\partial f_1}{\partial \tau_0} + f_1 = -(1-a) \frac{\partial f_0}{\partial \tau_0} + \tau_0 \dot{k} \frac{\partial f_0}{\partial \tau_1} \quad (2.3.30)$$

As before:

$$f_0(\tau_0, \tau_1) = \frac{A(\tau_1)}{\tau_0}$$

The uniformity ratio is given by:

$$\frac{f_1}{f_0} = \int \left(\frac{A'}{A} \dot{k} - \frac{a-1}{\tau_0^a} \right) d\tau_0 + \frac{B}{A}(\tau_1) \quad (2.3.31)$$

The second term in the integrand gives rise to singular nonuniformity in straight perturbation theory. In order to eliminate this we may put $a=1$ and $\dot{k}=0$. Exact solution is now obtained and is given by:

$$f_0(t) = \frac{D}{t+c} ; \quad D = \text{constant} \quad (2.3.32)$$

On the other hand, we may equate the integrand in (2.3.31) to zero and solve for k .

Then,

$$\frac{(1-a) A(\tau_1)}{\tau_0^a} = \dot{k} A'(\tau_1)$$

and
$$\frac{A'}{A}(\tau_1) = \frac{(1-a)}{k\tau_0^a}(\tau_0) = c_1 = \text{constant} \quad (2.3.33)$$

giving
$$A = D \exp(c_1 \tau_1)$$

$$k = \frac{a-1}{c_1 \tau_0}$$

After restriction along $\tau_0 = t+c, \tau_1 = \epsilon k(t)$:

$$f_0(\tau_0, \tau_1) \Big|_t = \left(\frac{D}{t+c} \right) \exp\left(\frac{\epsilon(a-1)}{t+c} \right) = \left(\frac{D}{t+\epsilon a} \right) \exp\left(\frac{\epsilon(a-1)}{t+\epsilon a} \right) \quad (2.3.34)$$

Contrails

On substituting (2.3.34) into (2.1.2) the value of a is fixed to be equal to 1 and the exact solution (2.3.32) is obtained (Fig. 2).

It seems desirable to develop a criterion of uniformity in terms of conditions on the time scales that would enable one to proceed systematically. One may therefore consider the following criterion:

Clock Uniformity Criterion (CUC). The time scales $\tau_0(t)$ and $\tau_1(t)$ must be chosen such that

$$\left| \frac{\tau_1'(t)}{\tau_0'(t)} \right| \xrightarrow{\epsilon \downarrow} 0$$

i. e., the slope of the $\tau_1(\tau_0)$ curve must be $O(\epsilon)$ uniformly in t when the parameter ϵ is used to separate the time scales.

In the light of this criterion, we may note that the clock uniformity ratio (CUR) for case (i) of this example is given by

$$\left| \frac{\tau_1'(t)}{\tau_0'(t)} \right| = \frac{\epsilon}{c_1 t^2}$$

and therefore the CUC cannot be satisfied for all t . However, for case (ii) the CUR is given by

$$\left| \frac{\tau_1'(t)}{\tau_0'(t)} \right| = \frac{\epsilon(a-1)}{(t + \epsilon a)^2}$$

If we now demand that CUC be satisfied for all t we must have $a = 1$. This leads to the exact solution (2.3.32) without having to substitute (2.3.34) back into (2.1.2).

It has thus been demonstrated that a singular perturbation problem can sometimes be solved by a proper choice of time scales.

(2) Simple Dynamic Model. The following example is given here because it is the forerunner of a phenomenon of deep significance in the approximation of solutions of higher order equations. For instance, in second order l.d.e. the change of sign of the coefficient is associated with the failure of the approximation and the related analysis of the Stokes phenomenon. The present example exhibits the breakdown of the "frozen" and the perturbation approximations. The example may be considered as the simplest model of a flight vehicle of the VTOL type, being characterized by initial apparent instability; the system is stable, however, for long times. Again the equation is solved by the method of extension.

Consider the equation:

$$\frac{df}{dt} - \left(\frac{1 - \epsilon t}{1 + \epsilon t} \right) f = 0 \quad (2.3.35)$$

$$f(0) = 1; \quad 0 < \epsilon \ll 1$$

Fig. 10 illustrates the variation of the characteristic root and the solution. The simple "frozen" approximation is a growing exponential and does not match the true solution anywhere except near $t = 0$ and gives incorrect stability information. Another approximation, which is a slightly more refined scheme of "freezing" the system, is to treat the coefficient essentially as a constant as far as the solution is concerned, but to vary on a slower ϵt time scale, and can be viewed as a simple application of the time scales method. The approximation

$$\bar{f}(t) = \exp \left\{ \left(\frac{1 - \epsilon t}{1 + \epsilon t} \right) t \right\}$$

thus obtained gives the correct initial behavior and stability information, but is

Contrails

quite wrong in representing the true solution in other respects. For example, the correct asymptotic behavior for large t is not described; besides, the maximum value which occurs at $t \approx 0.4/\epsilon$ for the approximation $\bar{f}(t)$, is given as $\exp(0.17/\epsilon)$ whereas the true maximum is $\exp(0.4/\epsilon)$ and occurs at $t = 1/\epsilon$; further, $f_{\max}/\bar{f}_{\max} \approx \exp(0.2/\epsilon)$. Direct perturbation expansion on the other hand is secular and yields

$$f(t) = e^t (1 - \epsilon t + \dots)$$

and fails for $t \sim \frac{1}{\epsilon}$.

We shall now see that a proper choice of time scales results in a uniformly valid solution.

The variables are extended as follows:

$$t \implies \{ \tau_0, \tau_1 \}$$

with

$$\dot{\tau}_0 = 1; \tau_0 = t + \text{constant}$$

$$\tau_1 = \frac{1}{\epsilon} k(t) \tag{2.3.36}$$

Now:

$$\frac{d}{dt} \implies \frac{\partial}{\partial \tau_0} + \frac{1}{\epsilon} k \frac{\partial}{\partial \tau_1}$$

Equation (2.3.35) can be written as:

$$\left(\frac{1}{\epsilon} + t\right) \frac{df}{dt} - \left(\frac{1}{\epsilon} - t\right) f = 0 \tag{2.3.37}$$

This suggests that the constant in τ_0 in (2.3.36) is $O\left(\frac{1}{\epsilon}\right)$. Therefore, let $\tau_0 = t + \frac{c}{\epsilon}$; $c = O(1)$. The extended equations are:

Contrails

$$(1-c) k \frac{\partial f}{\partial \tau_1} = 0 \quad (a)$$

$$(1-c) \frac{\partial f}{\partial \tau_0} - (1+c)f + \tau_0 k \frac{\partial f}{\partial \tau_1} = 0 \quad (b) \quad (2.3.38)$$

$$\tau_0 \left(\frac{\partial f}{\partial \tau_0} + f \right) = 0 \quad (c)$$

The choice of $c = 1$ from (a) and $f = A(\tau_1) \exp(-\tau_0)$ from (c) yields in equation (b)

$$\frac{A'}{A}(\tau_1) = \frac{2}{\tau_0 k}(\tau_0) = c_1 = \text{constant}$$

whence: $A = D \exp(c_1 \tau_1); k(\tau_0) = \frac{2}{c_1} \ln \tau_0$

Restricting $f(\tau_0, \tau_1)$ along $\tau_0 = t + \frac{1}{\epsilon}$, $\tau_1 = \frac{1}{\epsilon} k$ and $f(0) = 1$, we obtain

$$f(t) = \exp\left\{-t + \frac{2}{\epsilon} \ln(1+\epsilon t)\right\} = e^{-t} (1+\epsilon t)^{2/\epsilon}$$

which is the exact solution. The asymptotic behavior of the function can be written as:

$$f(t) \begin{array}{l} \xrightarrow{t \uparrow} \\ \xrightarrow{t \downarrow} \end{array} \begin{array}{l} f(t) \\ f(t) \end{array} \begin{array}{l} \sim \\ \sim \end{array} \left\{ \begin{array}{l} e^{-t} t^{2/\epsilon} \exp\left\{\frac{2}{\epsilon} \left(\frac{1}{\epsilon t} - \frac{1}{2\epsilon^2 t^2} + \frac{1}{3\epsilon^3 t^3} - \dots\right)\right\} \\ \exp\left(t - \epsilon t^2 + \frac{2}{3} \epsilon^2 t^3 - \frac{\epsilon^3 t^4}{2} + \dots\right) \end{array} \right.$$

It has thus been demonstrated that in dealing with equations having variable coefficients, the generality of a nonlinear clock function is mandatory. The clock itself can be a highly nonlinear function even in simple problems.

2.4 Asymptotology

This chapter concludes with a brief look at one aspect of asymptotic analysis which has hitherto been known as an art, at best as a quasi-science. Most people who have worked with asymptotic phenomena have acquired implicit knowledge useful with different problems but not general enough to be

explicitly formulated.

In a highly instructive lecture M. Kruskal enunciated seven principles governing the philosophy of approach in asymptotic analysis (Ref. 41). This section (beginning with the title which was first used by him) is a brief review of these principles motivated by their usefulness in later sections.

Kruskal defines asymptotology as the art of dealing with applied mathematical systems in limiting cases; alternatively it is the art of describing the behavior of a specified solution (or family of solutions) of a system in a limiting case. The principles are enumerated below; however, the one most important for the present work is the sixth--the principle of maximal balance (or minimal simplification).

1. Principle of Simplification.

Asymptotological analysis tends to simplify the system considered, thus facilitating the generation of approximate solutions. Simplification occurs for example in perturbation theory; another way this can occur is in the separation of autonomous subsystems. The system $f(x, y) = 0$; $g(x) = 0$ has the autonomous subsystem $g(x) = 0$.

2. Principle of Recursion.

The dominant terms only are retained and solved for and the other terms are treated as known. Iteration enables one to obtain an asymptotic representation of the unknown function irrespective of the forms of the terms appearing. This principle is also useful in deducing general properties through mathematical induction.

3. Principle of Interpretation.

This advises us to suitably formulate the problem so that the limiting case is meaningful. Overdeterminism as occurring in matching problems of the boundary layer type, results in simplification at the cost of losing important information.

4. Principle of Wild Behavior.

This states that apparent overdeterminism occurs if in the limit (at least)

Contrails

some solutions have peculiar (e.g. singular) behavior. For instance, if $f(t) = \exp(-\frac{t}{\epsilon})$, $f' \rightarrow -\infty$ when t vanishes faster than ϵ . More general forms must be used in the asymptotic representation (e.g. inverse powers or logarithmic terms). Underdeterminism on the other hand results in nonuniqueness of solutions.

5. Principle of Annihilation.

An annihilator is an operator which results in zero when applied to a mathematical entity. It is used to eliminate such terms as may lead to underdeterminism in the limit.

6. Principle of Maximal Balance.

This dictates the choice of the terms to be neglected (leading to simplification) from among the competing terms when a comparison of the relative asymptotic magnitudes is made. This is based on sound sense because neglecting the minimum number of terms retains maximum information. When there is more than one maximal set of terms, each set describes one asymptotic behavior. Simply stated, the principle requires that the ordering be so chosen that the maximum number of terms is retained. For example, in the asymptotic analysis of the roots of the cubic equation

$$3\epsilon^2 x^3 + x^2 - \epsilon x - 4 = 0 \quad (2.4.1)$$

in the limit $\epsilon \rightarrow 0$, one may choose a general representation $x = a\epsilon^\nu$ and determine ν . The terms can be ordered as:

$$\epsilon^{3\nu+2} : \epsilon^{2\nu} : \epsilon^{\nu+1} : \epsilon^0 \quad (2.4.2)$$

ν is chosen such that the maximum number of terms (which are dominant) is retained after neglecting the terms which are small. Among the different choices of ν , it is found that the maximal ordering is given by $\nu=0$ or -2 . A graphical technique, which can be traced to Newton but used in this context by Kruskal, can be exploited to determine the value of ν for maximal ordering (Fig. 11 a). Each term of (2.4.1) is represented as a point on a

graph with the power of x as the abscissa and the power of ϵ as the ordinate. The relation between the exponents of x and ϵ is given by a line and for small ϵ the values of ν for minimal simplification are given by the lower convex support lines of the set of graphed points; i. e. lines passing through at least two points such that there are no graphed points below them. The present example, shown in Fig. 11 a, is discussed in detail by Kruskal in Ref. 41. For large ϵ , on the other hand, the upper convex support describes maximal balance. These ideas are further discussed in the next chapter.

7. Principle of Mathematical Nonsense

This is the simple idea that if during an asymptotological analysis an absurd conclusion is reached, the analysis has not been done correctly or carried far enough.

During the ensuing chapters, more than one of the above principles will be invoked and this is the reason for their inclusion here. To be sure, it is more desirable to arrive at conclusions in a systematic and logical manner after proper asymptotological analysis--as Kruskal says--"like remarkable coincidences in a well-constructed mystery story," (Ref. 41).

2.5 Summary of the Chapter

Nonuniformities of perturbation theory and some well-known uniformizing methods are discussed. The difference between the PLK method and the multiple time scales approach is emphasized.

The method of time scales is applied to simple examples. Constant coefficient l. d. e. are solved exactly by this method, the fourth order equation being representative of aircraft motion. A singular perturbation problem and a simple dynamic model are also studied.

Asymptotological principles are enumerated.

DEVELOPMENT OF THE APPROXIMATION SCHEME

This chapter seeks to obtain approximations to linear differential equations with variable coefficients in various limiting cases. The coefficients are assumed to be slowly varying and the precise definition of slowness is discussed in the next chapter. The equations are parameterized by introducing an ϵ and the system is studied in the limits of small and large ϵ . In each case the choice of suitable "clocks" results in the extraction of the leading behavior of the solutions; composite solutions are obtained by combining the behaviors on different time scales. One of the major tasks of asymptotic analysis is the determination of the "natural" variables in which the given problem can be treated as a perturbation problem. The present approach is intended to relax the requirements on knowledge given in advance and ad hoc assumptions and to provide a systematic way to deal with equations as they are given. Throughout this chapter the domain of the independent variable alone is extended into several dimensions and nonlinear clock functions are employed. The coefficients of the differential equations can in general depend on ϵ and t ; however, in this analysis they are assumed to depend only on t . The discussion begins with the first order equation and is continued to higher order equations.

3.1 First Order Equation

Consider the equation:

$$y' + \epsilon \omega_0(t)y = 0 ; \quad y(0) = 1 \quad (3.1.1)$$

Direct perturbation expansion $y = y_0 + \epsilon y_1 + \dots$ exhibits both secular and singular nonuniformity depending on $\omega_0(t)$. The nonuniformity ratio $\frac{y_1}{y_0}$ often indicates the nature of the breakdown. It is seen that

$$\frac{y_1}{y_0} = - \int_0^t \omega_0 dt \quad (3.1.2)$$

Contrails

Clearly, for example, when

$\omega_0 = t^n$; $n > -1$	perturbation theory is secular		
$\equiv 0$	"	"	exact
$= t^n$; $n < -1$	"	"	singular
$= e^{int}$; n real	"	"	neither secular nor singular

In order to uniformize the perturbation expansion, the following extension of the independent variable is made:

$$t \Rightarrow \{ \tau_0, \tau_1 \} \quad \tau_0 = t; \quad \tau_1 = \epsilon k(t) \quad (3.1.3)$$

The coefficient is taken to vary on the τ_0 scale (to pick up the varying nature of the coefficient). Thus

$$\frac{d}{dt} \Rightarrow \frac{\partial}{\partial \tau_0} + \epsilon \dot{k}(\tau_0) \frac{\partial}{\partial \tau_1}$$

$$\frac{\partial y}{\partial \tau_0} = 0$$

$$\dot{k}(\tau_0) \frac{\partial y}{\partial \tau_1} + \omega_0(\tau_0) y = 0$$

giving

$$y(\tau_0, \tau_1) = A(\tau_1)$$

and

$$\dot{k}(\tau_0) A'(\tau_1) + \omega_0(\tau_0) A(\tau_1) = 0$$

i.e.

$$\frac{A'}{A}(\tau_1) = - \frac{\omega_0}{k}(\tau_0) = s = \text{constant}$$

the l.h.s. and r.h.s. being respectively functions of τ_1 and τ_0 only. Hence:

$$y(\tau_0, \tau_1) = A(\tau_1) = c \exp(s\tau_1)$$

$$k(\tau_0) = - \frac{1}{s} \int \omega_0(\tau_0) d\tau_0 \quad (3.1.4)$$

Now restricting the solution along the trajectories $\tau_0 = t$ and $\tau_1 = \epsilon k(t)$ the exact solution $y(t) = c \exp(-\epsilon \int \omega_0(t) dt)$ is recovered. Henceforth s can be set equal to unity without loss of generality.

We may observe that in this extension the CUR is given as:

$$\left| \begin{array}{c} \tau_1'(t) \\ \tau_0'(t) \end{array} \right| = \left| \epsilon \omega(t) \right|$$

Clearly the CUC cannot be met as $\omega(t)$ may have singularities in the domain of interest. This, however, does not really matter as this difficulty can be removed by making $\tau_0(t)$ also a nonlinear function. For example,

if $\omega \xrightarrow[t \downarrow]{\frac{1}{t}}$ and ω is bounded for large t , we may choose $\tau_0(t) = t + \epsilon \ln t$ and

$$\left| \frac{\tau_1}{\tau_0} \right| = \left| \frac{\epsilon \omega}{1 + 1/t} \right| \xrightarrow[\epsilon \downarrow]{} 0$$

The choice of a nonlinear $\tau_0(t)$ thus enables us to enforce the clock uniformity criterion.

It is interesting to consider a pictorial representation of the function (Fig. 7,8). For small ϵ , τ_0 represents the fast time scale and τ_1 the slow time scale. The extended function surface is essentially a constant along τ_0 , but decays exponentially on the τ_1 axis and can therefore be described naturally (and uniformly) as dependent on τ_1 . The natural clocks are depicted as trajectories along which the extended function is restricted and are solely determined by the coefficient. For instance, when ω_0 is unity the trajectory is a straight line through the origin at an angle whose tangent is ϵ ; a linear $\omega_0(t)$ leads to a parabola for the trajectory. In general the magnitude of the parameter governs the proximity of the trajectories to the τ_0 or τ_1 axis.

3.2 Second Order Equation

In the previous case it was evident that whatever the nature of the coefficient $\omega_0(t)$ and the magnitude of the parameter ϵ , one could always determine a natural clock to describe the function uniformly. For the second and higher order equations this is no longer possible, and one has to be content with approximations valid in different regions of the domain of interest. First the canonical form of the equation and then the noncanonical form are discussed.

(a) Canonical Form

Consider the equation:

$$y'' + \epsilon \omega(t) y = 0 \tag{3.2.1}$$

Contrails

Again direct perturbation can be shown to fail for various $\omega(t)$, the nature of nonuniformity depending on $\omega(t)$ (Table I). We wish to make use of the simplification afforded by perturbation theory and improve upon it. The extension sought is:

$$t \implies \{ \tau_0, \tau_1 \} ; \tau_0 = t; \tau_1 = \epsilon^m k_1(t) \quad (3.2.2)$$

The extended derivatives are given in Table II. Equation (3.2.1) can be written as:

$$\frac{\partial^2 y}{\partial \tau_0^2} + \epsilon^m \left(\ddot{k}_1 \frac{\partial y}{\partial \tau_1} + 2\dot{k}_1 \frac{\partial^2 y}{\partial \tau_0 \partial \tau_1} \right) + \epsilon^{2m} \left(k_1^{\ddot{}} \frac{\partial^2 y}{\partial \tau_1^2} \right) + \epsilon \omega(\tau_0) y = 0 \quad (3.2.3)$$

The terms containing k_1 are the counterterms introduced by extension; we shall determine the clock functions in various limiting cases in the following way.

The various terms can be written as:

$$\epsilon^0 () + \epsilon^m () + \epsilon^{2m} () + \epsilon^n () = 0 \quad (3.2.4)$$

n is a given constant and m is to be determined.

The quantities not containing ϵ are implied to be of order unity. The failure of the approximation is indicated when the above ordering breaks down.

In order to use the graphical technique the coefficient of m in the exponent of ϵ in (3.2.4) is plotted along the abscissa and the constant term in the exponent of ϵ along the ordinate. Thus each term in (3.2.4) denotes a graphed point. In the fashion of Kruskal, for small ϵ , the lower convex support line of the set of graphed points gives m for maximal balance. On the other hand the upper convex support line yields maximal balance for large ϵ . In the present context we consider ϵ to be small and thus $m=0$ for maximal balance. But this choice is rejected as it is not useful and corresponds to straight perturbation theory; i. e. no extension has been made. What is desired is a compromise between completeness and simplicity-- a system as complete as possible and still simple enough to solve. With this in

Contrails

mind we pick $m=1$, which corresponds to "submaximal balance," i. e. maximal balance in second rank of terms.

We may therefore venture to state below the principle of submaximal balance. If the maximal balance of terms results in an equation that is either too difficult to solve or yields too little information then submaximal balance obtains maximum information consistent with simplification. Again this is mere prudence; short of solving the complete system (which may be impossible) we take the next best course of action and solve a system which is not the most complete but one next to it in the order of importance. That is, the system chosen contains more information than all the others except the maximally complicated one, i. e. a system maximal in second rank of terms.

It appears that it is precisely the method of extension which permits uniformly valid approximations which would otherwise not be possible. In the above example $\tau_0 = t$ must be a time scale since ω is a general function of t . But since the parameter is present it is likely that there is another time scale. Unless $\omega(t)$ is a known function of t we cannot, in general, transform ϵ out of the equation. Maximal balance is therefore not possible without extension and hence submaximal balance is resorted to after a suitable extension of the variables.

In terms of the graphical technique, submaximal balance for small ϵ would correspond to the lower convex support line of the set of graphed points except for one point which may be beneath the support line (Fig. 11 b). For large ϵ this corresponds to the upper convex support line except for one point which may lie above the support line.

With reference to (3.2.3) we see that:

ϵ small

$m = 0$ obtains maximal balance
 $m = 1$ obtains submaximal balance

ϵ large

$m = \frac{1}{2}$ obtains maximal balance
 $m = 0$ or 1 obtains submaximal balance

Contrails

(i) Short Time-Analysis. From the above, for small ϵ the choice $m = 1$ leads to the following set of partial differential equations replacing equation (3.2.1):

$$\epsilon^0 : \frac{\partial^2 y}{\partial \tau_0^2} = 0 \quad (a)$$

$$\epsilon : \ddot{k}_1 \frac{\partial y}{\partial \tau_1} + 2\dot{k}_1 \frac{\partial^2 y}{\partial \tau_0 \partial \tau_1} + \omega(\tau_0)y = 0 \quad (b) \quad (3.2.5)$$

$$\epsilon^2 : \dot{k}_1^2 \frac{\partial^2 y}{\partial \tau_1^2} = 0 \quad (c)$$

Integrating (3.2.5 a) we have:

$$y(\tau_0, \tau_1) = A(\tau_1)\tau_0 + B(\tau_1) \quad (3.2.6 a)$$

Now $A(\tau_1)\tau_0$ and $B(\tau_1)$ are linearly independent w.r.t τ_0 and can be used to generate separately the corrections to the lowest order result, giving rise to two clock functions. Substitution of (3.2.6 a) in (3.2.5 b) leads to:

$$\ddot{k}_{11} A' \tau_0 + 2\dot{k}_{11} A' = -\omega(\tau_0) A \tau_0 \quad (3.2.6 b)$$

The choice of $A = e^{s\tau_1}$ solves this equation as:

$$s\dot{k}_{11} = -\frac{1}{\tau_0^2} \int \tau_0^2 \omega d\tau_0 \quad (a)$$

(3.2.7)

$$s k_{11} = \frac{1}{\tau_0} \int \tau_0^2 \omega d\tau_0 - \int \tau_0 \omega d\tau_0 \quad (b)$$

and similarly:

$$s k_{12} = -\iint \omega(\tau_0) d\tau_0 d\tau_0 = -\tau_0 \int \omega d\tau_0 + \int \omega \tau_0 d\tau_0 \quad (c)$$

The parameter s can again be set equal to unity without loss of generality.

Contrails

On restriction the two independent approximations are obtained as

$$\tilde{y}_1 \approx c_1 t \exp \left\{ \epsilon \left(\frac{1}{t} \int t^2 \omega dt - \int t \omega dt \right) \right\} \quad (a)$$

$$\tilde{y}_2 \approx c_2 \exp \left(-\epsilon \int \int \omega dt dt \right) \quad (b)$$

In each case the equation (3.2.5 c) which is left unsatisfied, defines the error. The approximation breaks down when the neglected term $k_1^2 \frac{\partial^2 y}{\partial \tau_1^2}$ becomes of order $\frac{1}{\epsilon}$.

Higher order corrections are obtained by introducing more time scales. These are obtained as multiplicative corrections instead of additive ones as in direct perturbation theory, and will therefore reflect improvement in some types of problems. Thus if t is extended as

$$t \Rightarrow \{ \tau_0, \tau_1, \tau_2, \dots, \tau_n \}$$

with $\tau_0 = t; \tau_1 = \epsilon k_1(t); \tau_2 = \epsilon^2 k_2(t); \dots; \tau_n = \epsilon^n k_n(t)$

$$\frac{d}{dt} \Rightarrow \frac{\partial}{\partial \tau_0} + \epsilon \dot{k}_1 \frac{\partial}{\partial \tau_1} + \epsilon^2 \dot{k}_2 \frac{\partial}{\partial \tau_2} + \dots + \epsilon^n \dot{k}_n \frac{\partial}{\partial \tau_n}$$

$$\begin{aligned} \frac{d^2}{dt^2} \Rightarrow & \frac{\partial^2}{\partial \tau_0^2} + \epsilon \left(\ddot{k}_1 \frac{\partial}{\partial \tau_1} + 2\dot{k}_1 \frac{\partial^2}{\partial \tau_0 \partial \tau_1} \right) + \epsilon^2 \left(\ddot{k}_2 \frac{\partial}{\partial \tau_2} + 2\dot{k}_2 \frac{\partial^2}{\partial \tau_0 \partial \tau_2} + \dot{k}_1 \frac{\partial^2}{\partial \tau_1^2} \right) \\ & + \dots + \epsilon^n \left(\ddot{k}_n \frac{\partial}{\partial \tau_n} + \dot{k}_{n/2}^2 \frac{\partial^2}{\partial \tau_{n/2}^2} + 2 \sum_{i=0}^n \dot{k}_i \dot{k}_{n-i} \frac{\partial^2}{\partial \tau_i \partial \tau_{n-i}} \right) + \epsilon^{n+1} (\quad) + \dots \end{aligned}$$

The term $\dot{k}_{n/2}^2 \frac{\partial^2}{\partial \tau_{n/2}^2} \equiv 0$ when n is odd.

The extended equations can be solved order by order as follows:

Contrails

$$\frac{\partial^2 y}{\partial \tau_0^2} = 0; \quad y(\tau_0, \dots, \tau_n) = A(\tau_1, \tau_2, \dots, \tau_n) \tau_0 + B(\tau_1, \tau_2, \dots, \tau_n) \quad (3.2.9)$$

$$\ddot{k}_1 \frac{\partial y}{\partial \tau_1} + 2\dot{k}_1 \frac{\partial^2 y}{\partial \tau_0 \partial \tau_1} + \omega(\tau_0)y = 0$$

Again using $A\tau_0$ and B to generate two independent approximations:

$$\ddot{k}_{11} \tau_0 \frac{\partial A}{\partial \tau_1} + 2\dot{k}_{11} \frac{\partial A}{\partial \tau_1} = -\omega \tau_0 A(\tau_1, \dots, \tau_n)$$

Now choose

$$A(\tau_1, \tau_2, \dots, \tau_n) = A_1(\tau_2, \tau_3, \dots, \tau_n) e^{\tau_1} \quad (3.2.10)$$

Therefore:

$$\ddot{k}_{11} \tau_0 + 2\dot{k}_{11} = -\omega \tau_0$$

Integration gives the clock function obtained earlier (3.2.7 b).

The slower clock k_2 is obtained from the equation of next order:

$$\ddot{k}_{21} \frac{\partial y}{\partial \tau_2} + 2\dot{k}_{21} \frac{\partial^2 y}{\partial \tau_0 \partial \tau_2} = -\dot{k}_{11}^2 \frac{\partial^2 y}{\partial \tau_1^2}$$

Substituting from (3.2.10) and (3.2.7 a) one obtains

$$\dot{k}_{21} = -\frac{1}{\tau_0^2} \int \tau_0^2 (\dot{k}_{11})^2 d\tau_0 \quad (a)$$

i. e.:

$$k_{21} = \frac{1}{\tau_0} \int \tau_0^2 (\dot{k}_{11})^2 d\tau_0 - \int \tau_0 (\dot{k}_{11})^2 d\tau_0 \quad (b) \quad (3.2.11)$$

with:

$$A(\tau_1, \dots, \tau_n) = A_1(\tau_2, \dots, \tau_n) e^{\tau_1} = A_2(\tau_3, \dots, \tau_n) e^{\tau_1} e^{\tau_2} \quad (c)$$

The general result for $n > 1$ can be written recursively as follows.

Contrails

$$\ddot{k}_n \frac{\partial y}{\partial \tau_n} + 2\dot{k}_n \frac{\partial^2 y}{\partial \tau_0 \partial \tau_n} = \Psi y \quad (3.2.12)$$

where Ψ is the operator defined by

$$\Psi = -2 \sum_{i=1}^N \dot{k}_i \dot{k}_{n-i} \frac{\partial^2}{\partial \tau_i \partial \tau_{n-i}} - \delta(n) \frac{\dot{k}_n^2}{2} \frac{\partial^2}{\partial \tau_{\frac{n}{2}}^2}$$

subject to the following conditions: (3.2.13)

n odd

$$N = \frac{n-1}{2}; \quad \delta(n) \equiv 0$$

n even

$$N = \frac{n-2}{2}; \quad \delta(n) \equiv 1 \text{ and } i \neq \frac{n}{2}$$

For $n = 1$, $\dot{k}_1 = -\omega(\tau_0)$.

When $y(\tau_0, \tau_1, \dots, \tau_n)$ is chosen to be either of the linearly independent functions (w.r.t. τ_0) $A(\tau_1, \dots, \tau_n) \tau_0$, and $B(\tau_1, \dots, \tau_n)$, the clock functions are obtained respectively as

$$k_{n1} = \frac{1}{\tau_0} \int \tau_0^2 F d\tau_0 - \int \tau_0 F d\tau_0$$

and

$$k_{n2} = - \iiint F d\tau_0^2$$

where:

$$F \equiv 2 \sum_{i=1}^N (\dot{k}_i)(\dot{k}_{n-i}) + \delta(n) \left(\frac{\dot{k}_n}{2} \right)^2$$

and is subject to the conditions (3.2.13). Thus clock functions can be determined to define slower time scales and improve the accuracy of the approximations.

Contrails

The domain of t for which the short time approximation is valid can be determined as follows. In obtaining Equation (3.2.8) the third term of Equation (3.2.3) was neglected in favor of the second and fourth terms. Clearly failure of the approximation occurs when this condition is violated; i. e. when:

$$(\dot{k})^2 \left(\frac{\partial^2 y}{\partial \tau_1^2} \right) \left(\frac{1}{\omega y} \right) \sim \frac{1}{\epsilon}$$

The condition for failure is given by

$$(\dot{k})^2 = \frac{\omega}{\epsilon}$$

substituting from (3.2.7) and simplifying, we obtain:

$$\sqrt{\epsilon} \left(\int t^2 \omega dt \right) = \omega^{\frac{1}{2}} t^2$$

Differentiating

$$\sqrt{\epsilon} t^2 \omega = \frac{1}{2} \omega^{-\frac{1}{2}} \dot{\omega} t^2 + 2t \omega^{\frac{1}{2}}$$

i. e.

$$\frac{1}{2} \omega^{-3/2} \dot{\omega} + \frac{2}{t} \omega^{-\frac{1}{2}} = \sqrt{\epsilon}$$

i. e.

$$\frac{d}{dt} \left(\omega^{-\frac{1}{2}} \right) - \frac{2}{t} \left(\omega^{-\frac{1}{2}} \right) = -\sqrt{\epsilon}$$

Using t^{-2} as an integrating factor, the above condition becomes:

$$\frac{d}{dt} \left(\frac{\omega^{-\frac{1}{2}}}{t^2} \right) = -\frac{\sqrt{\epsilon}}{t^2}$$

Integrating

$$\frac{1}{\sqrt{\omega t^2}} = \frac{\sqrt{\epsilon}}{t}$$

i. e. $\omega t^2 \cong \frac{1}{\epsilon}$.

The approximation will fail when

$$\omega t^2 \sim \frac{1}{\epsilon} \tag{3.2.14}$$

The criterion can be derived in a different way also. The approximating functions $A(\tau_1) \tau_0$ and $B(\tau_1)$ are linearly independent w. r. t. τ_0 . Upon restriction along $\tau_0 = t$, $\tau_1 = \epsilon k(t)$, this property may not be satisfied throughout the domain. The approximations can therefore be expected to fail in a region where the constancy of the Wronskian (Ref. 59) is destroyed. From (3.2.8) the Wronskian can be written as

$$W(\tilde{y}_1, \tilde{y}_2) = [-1 + \epsilon (\frac{1}{t} \int t^2 \omega dt - t \int \omega dt)] \exp \{ \epsilon (\frac{1}{t} \int t^2 \omega dt - \int t \omega dt - \iint \omega dt^2) \}$$

i. e. to lowest order in ϵ , $W(\tilde{y}_1, \tilde{y}_2)$ is a constant. Hence failure is indicated when either the exponent is of order unity or

$$\frac{1}{t} \int t^2 \omega dt - t \int \omega dt \sim \frac{1}{\epsilon}$$

i. e.:

$$-2\epsilon \int t \int \omega dt dt \sim t$$

Differentiating:

$$-2\epsilon t \int \omega dt \sim 1 \text{ or } -2\epsilon \int \omega dt \sim \frac{1}{t}$$

Differentiating again:

$$2\epsilon \omega \sim \frac{1}{t^2}$$

Thus the approximation (3.2.8) fails near a value of t for which $\omega t^2 \sim \frac{1}{\epsilon}$ as obtained earlier. Substituting this shows that the exponent in the exponential function of $W(\tilde{y}_1, \tilde{y}_2)$ is of order unity.

Contrails

For the Airy equation, for example, $\omega = t$, and the approximations $t \exp(-\frac{\epsilon t^3}{12})$ and $\exp(-\frac{\epsilon t^3}{6})$ obtained from (3.2.8) break down according to the above criterion, when $t \sim \epsilon^{-1/3}$. Any attempt to improve upon the approximation by going to higher order in ϵ is foiled as the ϵ^2 approximation also fails when $t \sim \epsilon^{-1/3}$. The reason for this is clear. The method then tells us that it is not possible to effect any improvement by using slower clocks. On considering the Airy equation

$$y'' + \epsilon ty = 0$$

it is seen that when $t \sim \epsilon^{-1/3}$ the parameter ϵ is completely removed from the equation thus indicating a region in which the equation must be solved exactly.

However, for a different $\omega(t)$ the criterion can be utilized to advantage. For instance, if $\omega(t) = \frac{1}{t^2}$, the above criterion says that the approximation will fail when $\epsilon \sim 1$. For small ϵ breakdown is not indicated and improvements can be effected by going to higher order terms in ϵ . This is indeed the case, for the exact solution for $\epsilon > \frac{1}{4}$ is oscillatory but it is not so for $\epsilon \leq \frac{1}{4}$.

(ii) Long Time Analysis. The interest is now shifted to the long time behavior of the solutions of Equation (3.2.1). It is shown that the LG approximation can be derived easily by a proper choice of time scales. The reason for deriving this well-known approximation is not merely pedagogical but to provide a systematic method for higher order equations and to emphasize a clear physical picture of the phenomenon. In reference to Equation (3.2.1) the analysis is carried out in the limit of large ϵ . If $\omega(t)$ is an unbounded monotonic function for large t , the correspondance between ϵ and t is clear. In any case, the growth of the magnitude of $\omega(t)$ must be properly associated with the limit of large ϵ . It is seen that in this limit, the choice $m = \frac{1}{2}$ obtains maximal ordering for the terms in Equation (3.2.3).

The extension evolves as follows, with $2m = 1$ and denoting $\epsilon^{\frac{1}{2}}$ by λ , and leads to the following partial differential equations, which replace (3.2.1).

Contrails

$$\lambda^2 : \dot{k}^2 \frac{\partial^2 y}{\partial \tau_1^2} + \omega(\tau_0) y = 0 \quad (a)$$

$$\lambda^1 : \dot{k} \frac{\partial y}{\partial \tau_1} + 2\dot{k} \frac{\partial^2 y}{\partial \tau_0 \partial \tau_1} = 0 \quad (b) \quad (3.2.15)$$

$$\lambda^0 : \frac{\partial^2 y}{\partial \tau_0^2} = 0 \quad (c)$$

Equation (a) above can be treated as a constant coefficient one w. r. t. τ_1 and the solution is given as

$$y(\tau_0, \tau_1) = \alpha(\tau_0) \exp(\tau_1) \quad (3.2.16 a)$$

whence, the clock k satisfies the equation

$$(\dot{k})^2 + \omega(\tau_0) = 0 \quad (3.2.16 b)$$

obtained by substituting (3.2.16 a) in (3.2.15 b). Substitution into (3.2.15 c) yields

$$\frac{d}{d\tau_0} (\ln \alpha) = -\frac{1}{4} \frac{d}{d\tau_0} (\ln \omega)$$

or

$$\alpha(\tau_0) = \omega^{-1/4}(\tau_0)$$

Restriction along $\tau_0 = t$, $\tau_1 = \lambda k(t)$ yields the composite solution

$$\tilde{y}(t) = c_1 \omega^{-1/4} \exp(i\lambda \int \omega^{1/2} dt) + c_2 \omega^{-1/4} \exp(-i\lambda \int \omega^{1/2} dt) \quad (3.2.17)$$

which may be recognized as the Liouville-Green solution.

This approximation will, however, break down when the neglected term, viz. $\frac{\partial^2 y}{\partial \tau_0^2}$ becomes of order λ . Substituting (3.2.16 a) in (3.2.15 c):

$$\frac{\partial^2 y}{\partial \tau_0^2} = \ddot{\alpha} e^{\tau_1} = (\omega^{-1/4}(\tau_0))'' e^{\tau_1}$$

Contrails

corresponds to the intersection of the maximum number of curves at a point.

(i) Short Time Approximation : (ϵ small). Let $m = n = 1$. The equation is:

$$y'' + \epsilon \omega_1 y' + \epsilon \omega_0 y = 0$$

The extended equations are:

$$\epsilon^0 : \frac{\partial^2 y}{\partial \tau_0^2} = 0 \tag{a}$$

$$\epsilon^1 : \ddot{k} \frac{\partial y}{\partial \tau_1} + 2\dot{k} \frac{\partial^2 y}{\partial \tau_0 \partial \tau_1} = -(\omega_1 \frac{\partial y}{\partial \tau_0} + \omega_0 y) \tag{b} \quad (3.2.19)$$

$$\epsilon^2 : \dot{k}^2 \frac{\partial^2 y}{\partial \tau_1^2} + \omega_1 \dot{k} \frac{\partial y}{\partial \tau_1} = 0 \tag{c}$$

As before, integration gives $y(\tau_0, \tau_1) = A(\tau_1)\tau_0 + B(\tau_1)$. Further, choice of $A = e^{\tau_1}$ and $y_1 = A\tau_0$ yields

$$\dot{k}_1 = -\frac{1}{\tau_0^2} \int \tau_0 (\omega_1 + \tau_0 \omega_0) d\tau_0 \tag{a}$$

and:

$$k_1 = \frac{1}{\tau_0} \int \tau_0 (\omega_1 + \tau_0 \omega_0) d\tau_0 - \int (\omega_1 + \tau_0 \omega_0) d\tau_0 \tag{b} \quad (3.2.20)$$

$$k_2 = - \iint \omega_0 d\tau_0 d\tau_0 \tag{c}$$

Thus :

$$y_1(t) = t \exp \left[\epsilon \left\{ \frac{1}{t} \int t(\omega_1 + t\omega_0) dt - \int (\omega_1 + t\omega_0) dt \right\} \right] \tag{a} \quad (3.2.21)$$

$$y_2(t) = \exp(-\epsilon \iint \omega_0 dt dt) \tag{b}$$

Failure of the approximation is indicated when:

$$\left(\dot{k}^2 \frac{\partial^2 y}{\partial \tau_1^2} \right) \left(\frac{1}{\omega_0 y} \right) \sim \frac{1}{\epsilon}$$

It may be noted that by means of the transformation

$$y(t) = z(t) \exp \left(-\frac{1}{2} \int \Omega_1 dt \right) \quad (3.2.22)$$

the noncanonical equation

$$y'' + \Omega_1(t)y' + \Omega_0(t)y = 0 \quad (3.2.23)$$

can be transformed into the canonical form

$$z'' + \left(\Omega_0 - \frac{\Omega_1^2}{4} - \frac{\dot{\Omega}_1}{2} \right) z = 0 \quad (3.2.24)$$

We may therefore choose to study approximations for the noncanonical equation directly or the canonical form after the above transformation. The clock functions given by (3.2.7) and (3.2.20) are different in the two cases. However, the approximations (3.2.8) and (3.2.21) are unaffected to leading order after taking into account the transformation (3.2.22). The difference in the clock functions (3.2.7) and (3.2.20) in the case when $\Omega_1 = \epsilon \omega_1$ and $\Omega_0 = \epsilon \omega_0$ exactly corresponds to the noncanonical-canonical transformation (3.2.22).

(ii) Long Time Approximation: (ϵ large). The alternative balancing of $m + 1 = n$; $m = 1$, $n = 2$ leads to a different approximation for large values of ϵ . The equation now is:

$$y'' + \epsilon \omega_1 y' + \epsilon^2 \omega_0 y = 0 \quad (3.2.25)$$

This ordering can be obtained in the following way also. Consider the equation:

$$\frac{d^2 y}{d\tau^2} + \omega_1(\lambda\tau) \frac{dy}{d\tau} + \omega_0(\lambda\tau)y = 0 \quad (3.2.26)$$

Contrails

The coefficients are slowly varying, if $\lambda \ll 1$. With the transformation $\lambda \tau = t$, the equation can be written as:

$$\frac{d^2 y}{d\tau^2} + \epsilon \omega_1(t) \frac{dy}{d\tau} + \epsilon^2 \omega_0(t) y = 0 ; \epsilon = \frac{1}{\lambda} \gg 1$$

The extension $\tau_0 = t$; $\tau_1 = \epsilon k(t)$ leads to:

$$\epsilon^2 : \dot{k}^2 \frac{\partial^2 y}{\partial \tau_1^2} + \omega_1 \dot{k} \frac{\partial y}{\partial \tau_1} + \omega_0 y = 0 \quad (a)$$

$$\epsilon^1 : \ddot{k} \frac{\partial y}{\partial \tau_1} + 2\dot{k} \frac{\partial^2 y}{\partial \tau_0 \partial \tau_1} + \omega_1 \frac{\partial y}{\partial \tau_0} = 0 \quad (b) \quad (3.2.27)$$

$$\epsilon^0 : \frac{\partial^2 y}{\partial \tau_0^2} = 0 \quad (c)$$

The coefficients of (a) can be treated as constants w. r. t. τ_1 and the solution can be written as

$$y(\tau_0, \tau_1) = \alpha(\tau_0) e^{\tau_1}$$

where:

$$\dot{k}^2 + \omega_1(\dot{k}) + \omega_0 = 0 \quad (3.2.28)$$

The amplitude variation is obtained from (b) by substituting and integrating as:

$$\alpha(\tau_0) = \frac{\gamma(\tau_0)}{(2\dot{k} + \omega_1)^{1/2}} \quad \text{where} \quad \frac{d}{d\tau_0} (\ln \gamma) = \frac{\dot{\omega}_1}{(4\dot{k} + 2\omega_1)} \quad (3.2.27)$$

When ω_1 is a constant, $\alpha(\tau_0) = (2\dot{k} + \omega_1)^{-1/2}$. However, even when ω_1 is not a constant, consider the function $\tilde{\alpha}(\tau_0) = (2\dot{k} + \omega_1)^{-1/2}$ and the approximation:

$$\tilde{y}(\tau_0, \tau_1) = \tilde{\alpha}(\tau_0) \exp(\tau_1) \quad (3.2.30)$$

This depends on whether $\gamma(\tau_0)$ is a slowly varying function. In any case, (3.2.22) can be used as an approximation if the error estimates are known. Such an analysis is made in the next chapter. This approximation affords a method of shifting the point at which the standard LG approximation breaks down, and will be discussed in later chapters.

3.3 Third Order Equation

Consider the equation:

$$y''' + \omega_2 y'' + \omega_1 y' + \omega_0 y = 0 \quad (3.3.1)$$

The transformation $y = z \exp(-\frac{1}{3} \int \omega_2 dt)$ converts the above equation into the canonical form:

$$z''' + \Omega_1 z' + \Omega_0 z = 0 \quad (3.3.2 a)$$

Let us therefore consider the canonical equation

$$y''' + \epsilon^m \omega_1 y' + \epsilon^n \omega_0 y = 0 \quad (3.3.2 b)$$

and the extension $\tau_0 = t; \tau_1 = \epsilon k(t)$. We determine a class of equations for which this extension obtains maximal or submaximal balance of terms, in the light of the discussion preceding (3.2.19). The choices are found to be (i) $m = n$ or (ii) $m + 1 = n$. Let (i) $m = n = 1$ and (ii) $m = 2, n = 3$.

(i) Short Time Approximation: ($\epsilon \ll 1$)

The equation is now ordered as:

$$y''' + \epsilon \omega_1 y' + \epsilon \omega_0 y = 0 \quad (3.3.2 c)$$

Using the extension (3.1.3):

$$\epsilon^0: \frac{\partial^3 y}{\partial \tau_0^3} = 0 \quad (a)$$

$$\epsilon^1: \ddot{k} \frac{\partial y}{\partial \tau_1} + 3\dot{k} \frac{\partial^2 y}{\partial \tau_0 \partial \tau_1} + 3k \frac{\partial^3 y}{\partial \tau_0^2 \partial \tau_1} + \omega_1 \frac{\partial y}{\partial \tau_0} + \omega_0 y = 0 \quad (b)$$

(3.3.3)

$$\epsilon^2: 3\dot{k}\dot{k} \frac{\partial^2 y}{\partial \tau_1^2} + 3\dot{k}^2 \frac{\partial^3 y}{\partial \tau_0 \partial \tau_1^2} + \omega_1 \dot{k} \frac{\partial y}{\partial \tau_1} = 0 \quad (c)$$

$$\epsilon^3: \dot{k}^3 \frac{\partial^3 y}{\partial \tau_1^3} = 0 \quad (d)$$

For small ϵ the pertinent equations are (a) and (b) above. Solving them in this order:

$$y(\tau_0, \tau_1) = A(\tau_1) \tau_0^3 + B(\tau_1) \tau_0 + C(\tau_1)$$

Contrails

Since terms on the r.h.s. are linearly independent w.r.t. τ_0 (Wronskian $\neq 0$), each can be used to generate a clock function. Substituting $y=A(\tau_1) \tau_0^2$ in equation (3.3.3b):

$$\ddot{k}_1 A' \tau_0^2 + 6\dot{k}_1 A' \tau_0 + 6\dot{k}_1 A' = -A(2\omega_1 \tau_0 + \omega_0 \tau_0^2)$$

Choosing $A = \exp(\tau_1)$ leads to the second order equation for the clock:

$$\tau_0^2 \frac{d^2(\dot{k}_1)}{d\tau_0^2} + 6\tau_0 \frac{d(\dot{k}_1)}{d\tau_0} + 6(\dot{k}_1) = -(2\omega_1 \tau_0 + \omega_0 \tau_0^2). \quad (3.3.4)$$

Though this is a variable-coefficient equation, it can be readily solved being recognized as the inhomogeneous equidimensional or Euler-Cauchy equation. The transformation $\tau_0 = e^z$ reduces Equation (3.3.4) to a constant coefficient equation in z . Alternatively it can be written as

$$\frac{d^2 \Phi}{d\tau_0^2} + \frac{6}{\tau_0} \frac{d\Phi}{d\tau_0} + \frac{6}{\tau_0^2} \Phi = f \quad (3.3.5)$$

where $\Phi = \dot{k}_1$ and $f = -\left(\frac{2\omega_1}{\tau_0} + \omega_0\right)$.

The solutions of the corresponding homogeneous equation are obtained as

$$\tilde{\Phi} = \tau_0^m \text{ where}$$

$$m(m-1) + 6m + 6 = 0$$

i.e. $m_1 = -3$; $m_2 = -2$

and: $\tilde{\Phi}_1 = \tau_0^{-3}$; $\tilde{\Phi}_2 = \tau_0^{-2}$

Contrails

The particular solution is given by:

$$\Phi = \tilde{\Phi}_1(\tau_0) \int_{\tau_0}^{\tau_0} \frac{\tilde{\Phi}_2(s)f(s)}{W(\tilde{\Phi}_1, \tilde{\Phi}_2)} ds + \tilde{\Phi}_2(\tau_0) \int_{\tau_0}^{\tau_0} \frac{\tilde{\Phi}_1(s)f(s)}{W(\tilde{\Phi}_1, \tilde{\Phi}_2)} ds$$

$$W(\tilde{\Phi}_1, \tilde{\Phi}_2) = \begin{vmatrix} \tau_0^{-3} & \tau_0^{-2} \\ -3\tau_0^{-4} & -2\tau_0^{-3} \end{vmatrix} = \tau_0^{-6}$$

$$\Phi = k_1 = \tau_0^{-3} \int \tau_0^3 (2\omega_1 + \omega_0 \tau_0) d\tau_0 - \tau_0^{-2} \int \tau_0^3 (2\omega_1 + \omega_0 \tau_0) d\tau_0$$

Integrating by parts and noting that $\tau_0 = t$

$$k_1 = \frac{1}{t} \int t^3 g_2 dt - \frac{1}{2t^2} \int t^3 g_2 dt - \frac{1}{2} \int t g_2 dt \quad (3.3.6 a)$$

where:

$$g_2(t) = 2\omega_1 + \omega_0 t$$

For example, when $\omega_1 = 0$; $\omega_0 = t^{-3}$, $g_2 = t^{-2}$ and $k_1 = \text{constant} - \frac{1}{2} \ln t$.

The approximate solution is given as:

$$\tilde{y}(t) = ct^a \exp\left(-\frac{\epsilon}{2} \ln t\right) = c t^{(a - \epsilon/2)} \quad (3.3.6 b)$$

The exact solution for this example can be obtained as $y = t^m$ where m satisfies the equation

$$m(m-1)(m-2) + \epsilon = 0$$

i. e. : $m^3 - 3m^2 + 2m + \epsilon = 0$

Contrails

For small ϵ , expanding $m = m_0 + \epsilon m_1 + \dots$ and taking $m_0 = 2$ the correction to order ϵ is obtained as:

$$3m_0^2 m_1 - 6m_0 m_1 + 2m_1 + 1 = 0 \quad \text{or} \quad m_1 = -\frac{1}{2}$$

Hence, for small ϵ , the approximate solution to order ϵ is

$$y = c_2 t^{(2 - \epsilon/2)} \tag{3.3.6 c}$$

which is indeed predicted by the approximation via time scales (3.3.6 b).

The clock functions corresponding to the other two solutions of (3.3.2 c) are similarly obtained.

$$k_2 = -\frac{1}{2t} \int (\omega_1 + \omega_0 t)^2 dt + \frac{1}{2} \int (\omega_1 + \omega_0 t) t dt - \frac{1}{2} \iint (\omega_1 + \omega_0 t) dt dt$$

and $k_3 = -\iiint \omega_0 dt^3$

Using these clocks, the approximations to order ϵ can be written as

$$\tilde{y}_2(t) = c_2 t^2 \exp\left(\epsilon \left\{ \frac{1}{t} \int t^2 g_2 dt - \frac{1}{2t^2} \int t^3 g_2 dt - \frac{1}{2} \int t g_2 dt \right\} \right) \tag{a}$$

$$\tilde{y}_1(t) = c_1 t \exp\left(\frac{\epsilon}{2} \left\{ -\frac{1}{t} \int t^2 g_1 dt + \int t g_1 dt - \iint g_1 dt^2 \right\} \right) \tag{3.3.7 (b)}$$

$$\tilde{y}_0(t) = c_0 \exp\left(-\epsilon \iiint \omega_0 dt^3 \right) \tag{c}$$

where $g_2 = 2\omega_1 + \omega_0 t$; $g_1 = \omega_1 + \omega_0 t$.

For the case when $\omega_1 \equiv 0$, $\omega_0 = t^{-3}$,

$$y_2 = c_2 t^{(2 - \epsilon/2)}; y_1 = c_1 t^{(1+\epsilon)}; y_0 = c_0 t^{(-\epsilon/6)}$$

That these are indeed the correct approximations to order ϵ can be seen by making the expansion $m = m_0 + \epsilon m_1 + \dots$ and evaluating m_1 from the

Contrails

relation $3m_0^2 m_1 - 6m_0 m_1 + 2m_1 + 1 = 0$ and then successively taking $m_0 = 2, 1$ and 0 .

The failure of the approximation can be studied as before by comparing terms from (c) and (b) in the Equation (3.3.3); failure occurs when:

$$(\omega_0 y) \left(\frac{1}{\omega_1 k \frac{\partial y}{\partial \tau_1}} \right) \sim \frac{1}{\epsilon}$$

Taking $\dot{k}_3 = -\omega_0 dt^2$, condition for breakdown is

$$\epsilon \frac{\omega_0}{\omega_1} \sim \iint \omega_0 dt^2 \tag{3.3.8 a}$$

When $\omega_1 \equiv 0$, it is better to obtain the criterion differently as

$$(3\epsilon \dot{k} \ddot{k} \frac{\partial^2 y}{\partial \tau_1^2}) \sim \omega_0 y$$

taking the terms from (3.3.3 b) and (3.3.3 c) respectively;

i. e.:

$$3\epsilon \left(\iint \omega_0 dt^2 \right) \left(\int \omega_0 dt \right) \sim \omega_0 \tag{3.3.8 b}$$

The approximation breaks down near the value of t for which it is satisfied.

When $\omega_0 = \frac{1}{t^3}$, we see from (3.3.8 b) that the approximation fails when:

$$3\epsilon \left(\frac{1}{2t} \right) \left(\frac{1}{2t^2} \right) \sim \frac{1}{t^3}; \text{ i.e. when } |\epsilon| \sim 1$$

For small ϵ the time scales approach gives, in this case, the correct approximation to the leading order in ϵ , and fails as ϵ increases in magnitude towards unity. The value $\epsilon = \frac{2}{3\sqrt{3}}$ may be verified to exactly correspond to the occurrence of multiple roots for m in looking for a solution of the type $y = t^m$. The solution is therefore oscillatory when $\epsilon > \frac{2}{3\sqrt{3}}$ and

nonoscillatory when $\epsilon \leq \frac{2}{3\sqrt{3}}$. Thus for small ϵ , the method yields useful approximations.

Higher order corrections can be obtained by employing slower clocks as in the second order equation and the validity of the approximation scheme can be studied as before.

(ii) Long Time Approximation (ϵ large)

The alternative balancing in Equation (3.3.2 b) with $m = 2$, $n = 3$, leads to the equation

$$y''' + \epsilon^2 \omega_1(t)y' + \epsilon^3 \omega_0(t)y = 0 \quad (3.3.9 a)$$

which will be studied for large values of ϵ . Using the extension

$$t \implies \{\tau_0, \tau_1\}; \tau_0 = t; \tau_1 = \epsilon k(t) \quad (3.3.9 b)$$

the extended equations for large ϵ , are in the order

$$\epsilon^3 : \dot{k}^3 \frac{\partial^3 y}{\partial \tau_1^3} + \omega_1 \dot{k} \frac{\partial y}{\partial \tau_1} + \omega_0 y = 0 \quad (a)$$

$$\epsilon^2 : 3\dot{k}\ddot{k} \frac{\partial^2 y}{\partial \tau_1^2} + 3\dot{k}^2 \frac{\partial^3 y}{\partial \tau_0 \partial \tau_1^2} + \omega_1 \frac{\partial y}{\partial \tau_0} = 0 \quad (b)$$

(3.3.10)

$$\epsilon^1 : \ddot{k} \frac{\partial y}{\partial \tau_1} + 3\ddot{k} \frac{\partial^2 y}{\partial \tau_0 \partial \tau_1} + 3\dot{k} \frac{\partial^3 y}{\partial \tau_0^2 \partial \tau_1} = 0 \quad (c)$$

$$\epsilon^0 : \frac{\partial^3 y}{\partial \tau_0^3} = 0 \quad (d)$$

As before these can be solved as

$$y(\tau_0, \tau_1) = \alpha(\tau_0) e^{\tau_1} \quad (3.3.11)$$

where:

$$\dot{k}^3 + \omega_1(\dot{k}) + \omega_0 = 0 \quad (3.3.12)$$

Substitution of this into (3.3.10 b) results in

$$\alpha(\tau_0) = \frac{\gamma(\tau_0)}{(3\dot{k}^2 + \omega_1)^{\frac{1}{2}}}$$

where:

$$\frac{d}{d\tau_0} (\ln \gamma) = \frac{\dot{\omega}_1}{2(3\dot{k}^2 + \omega_1)} = \frac{1}{2} \frac{\partial}{\partial \tau_0} (\ln (3\dot{k}^2 + \omega_1)) \quad (3.3.13)$$

restriction along $\tau_0 = t$; $\tau_1 = \epsilon k(t)$ leads to the approximation for y .

The noncanonical third order equation can be similarly studied, yielding

$$\alpha_{nc}^3(\tau_0) = \frac{\gamma_{nc}^3(\tau_0)}{[3\dot{k}^2 + 2\omega_2(\dot{k}) + \omega_1]^{\frac{1}{2}}}$$

where

$$\begin{aligned} \frac{d}{d\tau_0} (\ln \gamma_{nc}^3) &= \frac{1}{2} \frac{\partial}{\partial \tau_0} (\ln (3\dot{k}^2 + 2\omega_2(\dot{k}) + \omega_1)) \\ &= \frac{2\dot{\omega}_2(\dot{k}) + \dot{\omega}_1}{2(3\dot{k}^2 + 2\omega_2(\dot{k}) + \omega_1)} \end{aligned}$$

Again the extended function $y(\tau_0, \tau_1)$, must be restricted along $\tau_0 = t$; $\tau_1 = \epsilon k(t)$ to obtain the approximation.

The third order noncanonical equation is equivalent to the canonical equation of the form

$$y''' + (\epsilon^2 \omega_1 + O(\epsilon)) y' + (\epsilon^2 \omega_0 + O(\epsilon^2)) y = 0$$

for large ϵ . It can be seen that to leading order, the frequency of the solution is determined by ω_1, ω_0 ; however, the amplitude is affected by ω_1, ω_0 and also by the terms $O(\epsilon)$ with y' and $O(\epsilon^2)$ with y .

3.4 The Linear Equation of Order n

The l. d. e. of fourth and higher orders can be analyzed in a similar manner. In each case, after choosing the two time scale extension, the proper balance of terms for short or long time (or alternatively for small or large values of the parameter ϵ) can be determined by the principle of maximal or submaximal balance. In the fourth order case (for short times) for example, the clock functions are found to satisfy an inhomogeneous third order l. d. e. with variable coefficients, but again of a particular type, namely the Euler-Cauchy equation. Without going into the details of this, however, in this section the method of time scales will be applied to the general n^{th} order l. d. e. and some general results obtained. The extension of the n^{th} order derivative operator is derived in Appendix I. Consider the equation

$$\frac{d^n z}{dt^n} + \Omega_{n-1} \frac{d^{n-1} z}{dt^{n-1}} + \dots + \Omega_0 z = 0 \quad (3.4.1)$$

This can be transformed into the canonical form

$$\frac{d^n y}{dt^n} + \omega_{n-2} \frac{d^{n-2} y}{dt^{n-2}} + \dots + \omega_0 y = 0 \quad (3.4.2)$$

$$\text{where: } z = y \exp\left(-\frac{1}{n} \int \Omega_{n-1} dt\right) \quad (3.4.3)$$

(i) Short Time Approximation: (small ϵ)

Consider the parameterized equation

$$\frac{d^n y}{dt^n} + \epsilon \left(\omega_{n-2} \frac{d^{n-2} y}{dt^{n-2}} + \dots + \omega_0 y \right) = 0 \quad (3.4.4)$$

in the limit as $\epsilon \rightarrow 0$. Direct perturbation theory can be shown to be nonuniform, depending on the forms of the $\omega_i(t)$; $i=0, 1, \dots, n-2$. The extension $t \Rightarrow \{\tau_0, \tau_1\}$, $\tau_0 = t$; $\tau_1 = \epsilon k(t)$ leads to a set of $(n+1)$ partial differential equations. For small ϵ only the lowest and first order equations are retained in this analysis. Using the result derived in Appendix I the extended equations can be written order by order as:

$$\epsilon^0 : \frac{\partial^n y}{\partial \tau_0^n} = 0 \quad (a)$$

$$\epsilon^1 : k^{(n)} \frac{\partial y}{\partial \tau_1} + \sum_{r=1}^{n-1} \binom{n}{r} k^{(n-r)} \frac{\partial^{r+1} y}{\partial \tau_0^r \partial \tau_1} = -\omega_{n-2} \frac{\partial^{n-2} y}{\partial \tau_0^{n-2}} + \dots + \omega_0 y \quad (b)$$

plus higher order terms.

Integration gives :

$$y(\tau_0, \tau_1) = A_{n-1}(\tau_1) \tau_0^{n-1} + A_{n-2}(\tau_1) \tau_0^{n-2} + \dots + A_1(\tau_1) \tau_0 + A_0(\tau_1) \quad (3.4.6)$$

At this point we make use of the linear independence of $A_i(\tau_1) \tau_0^i$, $i=0, 1, \dots, n-1$ and generate n clock functions, each corresponding to one solution of (3.4.4) starting with each $A_i(\tau_1) \tau_0^i$. Considering $A_{n-1}(\tau_1) \tau_0^{n-1}$, substitution into (3.4.5 b) gives:

$$\begin{aligned} \frac{d^n k_{n-1}}{d\tau_0^n} A'_{n-1}(\tau_1) \tau_0^{n-1} + \sum_{r=1}^{n-1} \binom{n}{r} \frac{d^{(n-r)} k_{n-1}}{d\tau_0^{(n-r)}} A'_{n-1}(\tau_1) \frac{\partial^r}{\partial \tau_0^r} (\tau_0^{n-1}) \\ = -(\omega_{n-2} \frac{\partial^{n-2} y}{\partial \tau_0^{n-2}} + \dots + \omega_0 y) \end{aligned} \quad (3.4.7)$$

Choice of an exponential τ_1 dependence of A_{n-1} will result in the following equation for the clock:

$$\begin{aligned} \tau_0^{n-1} \frac{d^{n-1} (\dot{k}_{n-1})}{d\tau_0^{n-1}} + \binom{n}{1} (n-1) \tau_0^{n-2} \frac{d^{n-2} (\dot{k}_{n-1})}{d\tau_0^{n-2}} \\ + \binom{n}{2} (n-1)(n-2) \tau_0^{n-3} \frac{d^{n-3} (\dot{k}_{n-1})}{d\tau_0^{n-3}} + \dots + (n!) (\dot{k}_{n-1}) \\ = -(\omega_{n-2} \tau_0 + \omega_{n-3} \tau_0^2 + \dots + \omega_0 \tau_0^{n-1}) \end{aligned}$$

This can be written as

$$\tau_0^{n-1} \frac{d^{n-1} \varphi_{n-1}}{d\tau_0^{n-1}} + a_{n-2} \tau_0^{n-2} \frac{d^{n-2} \varphi_{n-1}}{d\tau_0^{n-2}} + \dots + a_0 \varphi_{n-1} = f(\tau_0) \quad (3.4.8)$$

where $\omega_i = \dot{k}_i$. This is recognized as the inhomogeneous Euler-Cauchy or equidimensional equation. The solution of the corresponding homogeneous

Contrails

equation can be expressed as $\varphi_{n-1} \tau_0^m$ where m satisfies the algebraic equation

$$m(m-1)(m-2) \dots (m-n+2) + m(m-1)(m-2) \dots (m-n+3) \binom{n}{1} (n-1) + \dots + n! = 0 \quad (3.4.9)$$

which can be written as

$$m^{n-1} + a_{n-2} m^{n-2} + \dots + a_1 m + a_0 = 0 \quad (3.4.10)$$

having $(n-1)$ roots which will be assumed to be distinct. The homogeneous solution is given by

$$(\varphi_{n-1})_{\text{hom}} \equiv (k_{n-1})_{\text{hom}} = c_1 \tau_0^{m_1} + \dots + c_{n-1} \tau_0^{m_{n-1}} \quad (3.4.11)$$

which will be denoted respectively by $\tilde{\varphi}_1, \tilde{\varphi}_2, \dots, \tilde{\varphi}_{n-1}$. The particular solution can be written as (Ref. 60)

$$\begin{aligned} \tilde{\varphi}_{n-1} \equiv -k_{n-1} &= \tilde{\varphi}_1 \int \frac{V_1 f}{W(\tau_0)} d\tau_0 - \tilde{\varphi}_2 \int \frac{V_2 f}{W(\tau_0)} d\tau_0 \\ &+ \dots + (-1)^n \tilde{\varphi}_{n-1} \int \frac{V_{n-1} f}{W(\tau_0)} d\tau_0 \end{aligned}$$

where $W \equiv W(\tilde{\varphi}_1, \tilde{\varphi}_2, \dots, \tilde{\varphi}_{n-1})$ is the Wronskian and V_i is the determinant of the matrix obtained by replacing the i^{th} column of the $(n-1)$ square matrix

$$\begin{bmatrix} \tilde{\varphi}_1 & \tilde{\varphi}_2 & \tilde{\varphi}_{n-1} \\ \tilde{\varphi}'_1 & \tilde{\varphi}'_2 & \tilde{\varphi}'_{n-1} \\ \tilde{\varphi}''_1 & & \\ \dots & & \\ \tilde{\varphi}_1^{(n-2)} & \tilde{\varphi}_2^{(n-2)} & \tilde{\varphi}_{n-1}^{(n-2)} \end{bmatrix}$$

by the column:

$$\begin{bmatrix} 0 \\ 0 \\ \vdots \\ f \end{bmatrix}$$

One more integration of φ_{n-1} gives k_{n-1} . Thus obtaining the proper time scales and after restriction along $\tau_0 = t$, $\tau_1 = \epsilon k_{n-1}(t)$, one approximate solution of (3.4.4) to order ϵ can be written as:

$$y(t) = c_{n-1} t^{n-1} \exp(\epsilon \int \varphi_{n-1} dt)$$

The other independent approximations are similarly obtained by determining the clock functions $\varphi_{n-2}, \dots, \varphi_1, \varphi_0$, and combining each with $t^{n-2}, t^{n-3}, \dots, t, t^0$ as in (3.4.6). Therefore, the approximate general solution of (3.4.4) to order ϵ (for small ϵ) can be written as

$$\begin{aligned} y(t) = & c_{n-1} t^{n-1} \exp(\epsilon \int \varphi_{n-1} dt) + c_{n-2} t^{n-2} \exp(\epsilon \int \varphi_{n-2} dt) \\ & + \dots + c_1 t \exp(\epsilon \int \varphi_1 dt) + c_0 \exp(\epsilon \int \varphi_0 dt) \end{aligned} \quad (3.4.13)$$

where c_i are constants and φ_i ($i=0, 1, \dots, n-1$) are clock functions.

For any given n , the breakdown of this approximation may be investigated as shown in the last section by studying when the terms which are neglected, viz. of order ϵ^2 , become of the same order as terms of order ϵ .

Higher order corrections can again be obtained by employing slower clocks, of order ϵ^2, ϵ^3 , etc.

(ii) Long Time Approximation: (ϵ large).

The ordering of the parameterized l.d.e. of order n can be obtained by requiring all the coefficients to be slowly varying. For example, the equation

Contrails

$$\frac{d^n y}{d\tau^n} + \omega_{n-1}(\lambda \tau) \frac{d^{n-1} y}{d\tau^{n-1}} + \dots + \omega_1(\lambda \tau) \frac{dy}{d\tau} + \omega_0(\lambda \tau) y = 0 \quad (3.4.14)$$

$$(\lambda \ll 1)$$

can be transformed into

$$\frac{d^n y}{dt^n} + \epsilon \omega_{n-1}(t) \frac{d^{n-1} y}{dt^{n-1}} + \dots + \epsilon^{n-1} \omega_1(t) \frac{dy}{dt} + \epsilon^n \omega_0(t) y = 0 \quad (3.4.15)$$

where $t = \lambda \tau$ and $\epsilon = \frac{1}{\lambda} \gg 1$. This equation can now be studied in the limit of large ϵ . To use time scales, the domain of the independent variable is extended as before:

$$t \Rightarrow \{ \tau_0, \tau_1 \} ; \tau_0 = t, \tau_1 = \epsilon k(t) \quad (3.1.3)$$

Equating powers of ϵ will lead to a set of $(n+1)$ partial differential equations. For the limit of large ϵ only equations retaining terms of order ϵ^n and ϵ^{n-1} need be considered. Using the results derived in Appendix I these equations can be written as:

$$(\dot{k})^n \frac{\partial^n y}{\partial \tau_1^n} + \omega_{n-1}(\dot{k})^{n-1} \frac{\partial^{n-1} y}{\partial \tau_1^{n-1}} + \dots + \omega_1(\dot{k}) \frac{\partial y}{\partial \tau_1} + \omega_0 y = 0 \quad (3.4.16)$$

$$\begin{aligned} & n(\dot{k})^{n-1} \frac{\partial^n y}{\partial \tau_0 \partial \tau_1^{n-1}} + (n-1)\omega_{n-1}(\dot{k})^{n-2} \frac{\partial^{n-1} y}{\partial \tau_0 \partial \tau_1^{n-2}} + (n-2)\omega_{n-2}(\dot{k})^{n-3} \frac{\partial^{n-2} y}{\partial \tau_0 \partial \tau_1^{n-3}} \\ & + \dots + 2\omega_2 \dot{k} \frac{\partial^2 y}{\partial \tau_0 \partial \tau_1} + \omega_1 \frac{\partial y}{\partial \tau_0} \\ & + \frac{n(n-1)}{2} (\dot{k})^{n-2} \ddot{k} \frac{\partial^{n-1} y}{\partial \tau_1^{n-1}} + \frac{(n-1)(n-2)}{2} \omega_{n-1}(\dot{k})^{n-3} \ddot{k} \frac{\partial^{n-2} y}{\partial \tau_1^{n-2}} \\ & + \dots + \omega_2 \ddot{k} \frac{\partial y}{\partial \tau_1} = 0 \end{aligned} \quad (3.4.17)$$

Equation (3.4.16) has coefficients independent of τ_1 and we seek solutions

of the form $y(\tau_0, \tau_1) = \alpha(\tau_0) \beta(\tau_1) = \alpha(\tau_0) \exp(\tau_1)$. The clock function satisfies the equation

$$(\dot{k})^n + \omega_{n-1} (\dot{k})^{n-1} + \dots + \omega_1 (\dot{k}) + \omega_0 = 0 \quad (3.4.18)$$

the roots of which are taken to be distinct for this analysis. When any of the roots coalesce, the approximation (3.4.21) fails because the amplitude factor becomes unbounded. In this case a nonelementary function such as the Airy function is necessary in order to represent the true solution. To relate the approximations via elementary functions on either side of a point where the roots coalesce, one is faced with a nontrivial connection problem. For distinct roots, the explicit amplitude variation is obtained from (3.4.17) as:

$$\begin{aligned} \frac{d}{d\tau_0} (\ln \alpha) &= - \frac{(\frac{n(n-1)}{2}) (\dot{k})^{n-2} + \frac{(n-1)(n-2)}{2} \omega_{n-1} (\dot{k})^{n-3} + \dots + \omega_2 (\dot{k})}{(n (\dot{k})^{n-1} + (n-1) \omega_{n-1} (\dot{k})^{n-2} + \dots + 2\omega_2 (\dot{k}) + \omega_1)} \\ &= - \frac{1}{2} \frac{\partial}{\partial (\dot{k})} \{ \ln (n (\dot{k})^{n-1} + (n-1) \omega_{n-1} (\dot{k})^{n-2} + \dots + \omega_1) \} \dot{k} \end{aligned} \quad (3.4.19)$$

This can be written in compact form as follows. Given the l.d.e. (3.4.15), consider the corresponding "characteristic expression":

$$F(x, t) \equiv x^n + \omega_{n-1} x^{n-1} + \dots + \omega_1 x + \omega_0 \quad (3.4.20)$$

$F = 0$ is defined to be the "characteristic equation." The explicit amplitude variation can be determined from the relation:

$$\frac{d}{d\tau_0} (\ln \alpha) = - \frac{1}{2} \frac{\partial}{\partial x} \ln \left(\frac{\partial F}{\partial x} \right) \frac{dx}{d\tau_0}$$

Integration gives

$$\alpha(\tau_0) = \frac{\gamma(\tau_0)}{\left(\frac{\partial F}{\partial x} \right)^{\frac{1}{2}}}$$

where $\gamma(\tau_0)$ satisfies the equation:

$$\frac{d}{d\tau_0} (\ln \gamma) = \frac{\partial}{\partial \tau_0} \ln \left(\frac{\partial F}{\partial x} \right)^{\frac{1}{2}}$$

Combining the τ_0 and τ_1 behaviors and imposing the restrictions $\tau_0 = t$ and $\tau_1 = \epsilon k(t)$ the result may be stated as follows.

Given an l. d. e. (3.4.15) the approximation via time scales for large ϵ is obtained as

$$\tilde{y}(t) = \sum_{i=1}^n \left[\frac{\gamma_i(t)}{\left(\frac{\partial F(t)}{\partial x_i} \right)^{\frac{1}{2}}} \right] \cdot \exp(\epsilon \int x_i dt) \quad (a)$$

where γ_i is given by

$$\frac{d}{dt} (\ln \gamma_i) = \frac{\partial}{\partial t} \left(\ln \left(\frac{\partial F}{\partial x_i} \right)^{\frac{1}{2}} \right) \quad (b) \quad (3.4.21)$$

where F is given by (3.4.20) and x_i are the roots of $F = 0$.

Clearly when the ω_i , ($i=1, 2, \dots, n-1$) approach constants as $t \rightarrow \infty$, γ approaches a constant. Also if ω_0 is the only varying coefficient γ is a pure constant. In this case the approximation is given by

$$\tilde{y}(t) = \sum_{i=1}^n c_i \left(\frac{\partial F}{\partial x_i} \right)^{-\frac{1}{2}} \exp(\epsilon \int x_i dt) \quad (c)$$

where c_i are arbitrary constants. This can also be interpreted to mean that we impose the condition that $\omega_1, \omega_2, \dots, \omega_{n-1}$ vary more slowly than ω_0 .

It can easily be verified that the formula (3.4.21) recovers, for second order equations the results of the standard Liouville-Green (WKBJ) theory as well as those obtained by Curtiss (Ref. 27).

3.5 Summary of the Chapter

The main theme in this chapter has been the demonstration that when the direct perturbation theory breaks down, a natural time scale can be found on which the solution can be described uniformly. The method of time scales

is shown to systematically lead to the determination of the natural "clocks" of the problem.

Linear differential equations are studied in the light of multiple time scales, beginning with the first order equation. Reparameterizing the equations enables separation of the different behaviors and a clear physical picture is shown to emerge. In each case failure of the classical perturbation approach is examined and the time scales method is shown to improve on the approximations.

After deriving the exact solution of the first order equation, the second and higher order equations are studied in the two limits as a parameter ϵ becomes small or large. The ordering in each case is justified by maximal or submaximal balance of the terms. Higher order corrections are derived for the second order equation and a criterion of validity of the approximation is derived. In the large ϵ limit the standard Liouville-Green (WKBJ) approximation is derived via time scales. The noncanonical formulation is shown to lead to a different approximation; the significance of this new approximation becomes apparent in later chapters where it is shown to be useful in the transition point analysis.

The theory is then generalized to the n^{th} order equation. For the small ϵ behavior the clock functions are shown to satisfy the Euler-Cauchy equation and hence can be determined exactly. For the large ϵ limit, a compact formula is derived which enables one to write down the approximation by inspection. It is observed that the time scales are, in general, nonlinear functions in addition to being complex quantities.

CHAPTER IV
ERROR ANALYSIS

The aim of this chapter is to examine the validity of the approximations derived in the last chapter and to obtain bounds on the errors incurred. The first order equation presents no problem, since the solution obtained from the proper choice of time scales is exact. For higher order equations one has necessarily to resort to approximations and an estimate of the errors is sine qua non for the analysis. Though there is an extensive literature establishing precise conditions for the existence of asymptotic solutions, strict upper bounds for the errors have not in general been formulated. Blumenthal (given in Ref. 28) did obtain such bounds for the second order equation as early as 1912, but his results have not been generally known. More recently Olver (Ref. 28) showed that it is possible to deduce from the existence proofs sharp upper bounds for the errors instead of the O-symbols. He derived these error bounds for the Liouville-Green approximations (or WKBJ functions) and their derivatives, and showed that these are indeed both realistic and easy to evaluate. But it must be remembered that these bounds are valid only in certain regions of the complex plane which are free from transition points and hence allow the use of one and the same form of asymptotic expansion.

In this section a few preliminary results are quoted and these are used in subsequent sections. For the second order equation a new approximation theorem is proved based on Olver's results, and this is seen to deal with the noncanonical equation directly. This will be further exploited in the next chapter for transition point analysis. Since the derivation of Olver's results is quite involved, the extension of his technique to higher order equations is not readily apparent. Error bounds of a similar type are derived in this chapter using a direct approach starting with the exact solution and this is extended to higher order equations. The discussion is made considerably simpler than Olver's, at the cost of imposing restrictions on

the coefficients of the differential equations.

4.1 Some Basic Definitions and Useful Lemmas

Some useful results will now be stated in order that they may be used later.

Nonoscillatory equations and oscillation criteria (Ref. 23).

A homogeneous second order l.d.e., with real coefficients defined on an interval J is said to be oscillatory on J if one (and/or every) real solution ($\neq 0$) has infinitely many zeros on J . Conversely, when every solution ($\neq 0$) has at most a finite number of zeros on J , it is said to be nonoscillatory on J . Further, if in addition every solution ($\neq 0$) has at most one zero on J , the equation is said to be disconjugate on J .

The oscillation theorems of Sturm can be stated in many ways. For the present purpose the comparison theorem can be stated as follows (Ref. 42).

Sturm's Comparison Theorem. Let $f(x)$ and $g(x)$ be nontrivial solutions of the l.d.e.

$$u'' + p(x)u = 0 \quad \text{and} \quad v'' + q(x)v = 0$$

respectively, where $p(x) > q(x)$. Then $f(x)$ vanishes at least once between any two zeros of $g(x)$, unless $p(x) \equiv q(x)$ and f is a constant multiple of g .

Corollary: If $q(x) \leq 0$, then no nontrivial solution of the l.d.e. $u'' + q(x)u = 0$ can have more than one zero, i.e. " $q(x) \leq 0$ on J " is sufficient for the l.d.e. to be disconjugate on J .

The proof is by contradiction. By the Sturm comparison theorem, the solution $v \equiv 1$ of the l.d.e. $v'' = 0$ would have to vanish at least once between any two zeros of any nontrivial solution of the l.d.e.

$$u'' + q(x)u = 0.$$

One of the very useful results is a lemma essentially due to Gronwall (Ref. 46).

Gronwall's Lemma. Let $\lambda(t)$ be a real continuous function and $\mu(t)$ a non-negative continuous function on the interval (a, b) . If a continuous function $y(t)$ has the property that

$$y(t) \leq \lambda(t) + \int_a^t \mu(s) y(s) ds$$

for $a \leq t \leq b$ then on the same interval:

$$y(t) \leq \lambda(t) + \int_a^t \lambda(s) \mu(s) \exp\left(\int_s^t \mu(\tau) d\tau\right) ds$$

In particular if $\lambda(t) \equiv \lambda$, a constant:

$$y(t) \leq \lambda \exp\left(\int_a^t \mu(s) ds\right)$$

Next we state two results of F.W.J. Olver (Ref. 28) in connection with second order l. d. e.

Theorem 1 (Olver). Let u be a positive parameter, and $f(u, x)$ be a continuous real or complex function of x in the interval $a \leq x \leq b$. Then in this interval the differential equation

$$\frac{d^2 w}{dx^2} = \{ u^2 + f(u, x) \} w$$

has solutions $w_1(u, x)$, $w_2(u, x)$, such that

$$w_1(u, x) = e^{ux} (1 + \epsilon_1(u, x)), \quad w_2(u, x) = e^{-ux} (1 + \epsilon_2(u, x))$$

$$\frac{d}{dx} w_1(u, x) = u e^{ux} (1 + 2\eta_1(u, x)), \quad \frac{d}{dx} w_2(u, x) = -u e^{-ux} (1 + 2\eta_2(u, x))$$

where $\left| \epsilon_1(u, x) \right|, \left| \eta_1(u, x) \right| \leq \exp\left\{ \frac{F_1(u, x)}{2u} \right\} - 1$

$$\left| \epsilon_2(u, x) \right|, \left| \eta_2(u, x) \right| \leq \exp\left\{ \frac{F_2(u, x)}{2u} \right\} - 1$$

and $F_1(u, x) = \int_a^x |f(u, t)| dt, \quad F_2(u, x) = \int_x^b |f(u, t)| dt$

The interval (a, b) may be infinite provided that the integrals converge.

Contrails

Theorem 2 (Olver). With the conditions of Theorem 2 the differential equation

$$\frac{d^2 w}{dx^2} = \{ -u^2 + f(u, x) \} w$$

has solutions $w_1(u, x)$, $w_2(u, x)$ such that $w_1(u, x) = e^{iux} + \epsilon_1(u, x)$,
 $w_2(u, x) = e^{-iux} + \epsilon_2(u, x)$, $\frac{d}{dx} w_1(u, x) = iue^{iux} + u\eta_1(u, x)$,
 $\frac{d}{dx} w_2(u, x) = -iue^{-iux} + u\eta_2(u, x)$ where

$$\left| \epsilon_1(u, x) \right|, \left| \eta_1(u, x) \right|, \left| \epsilon_2(u, x) \right|, \left| \eta_2(u, x) \right| \leq \exp\left\{ \frac{F(u, x)}{u} \right\} - 1$$

and

$$F(u, x) = \left| \int_c^x |f(u, t)| dt \right|$$

c being an arbitrary point such that $a \leq c \leq b$. The interval (a, b) and the value of c may be infinite provided that the integral converges.

The following lemma on integral equations also proves useful (Ref. 43).

The Fredholm integral equation is written as

$$\varphi(x) - \lambda \int_a^b k(x, s) \varphi(s) ds = f(x)$$

If the kernel $k(x, s)$ is identically zero when $s > x$ (which is true of causal dynamic systems), the integrand is zero when $x < s \leq b$ and the integral becomes $\int_a^x k(x, s) \varphi(s) ds$. This leads to the Volterra equation

$$\varphi(x) - \lambda \int_a^x k(x, s) \varphi(s) ds = f(x)$$

Lemma. (Ref. 43). If the "free term" $f(x)$ in the Volterra equation is absolutely integrable and the kernel is bounded, then successive approximations for this equation converge for all values of λ .

The sequence of successive approximations is given by

$$\varphi(x) = f(x) + \lambda \int_a^x k(x, s) \varphi(s) ds$$

$$+ \sum_{m=2}^{\infty} \lambda^m \int_a^x k(x, s_1) \int_a^{s_1} k(s_1, s_2) \dots \int_a^{s_{m-1}} k(s_{m-1}, s_m) f(s_m) ds_m \dots ds_1$$

If $|k(x, s)| \leq M_1$ and $|f(x)| \leq M_2$, then it can be proved (Ref. 39) by induction that the modulus of the general term in the series for $\varphi(x)$ does not exceed

$$|\lambda|^m M_1^m M_2 (x-a)^m / (m!) \leq |\lambda|^m M_1^m M_2 (b-a)^m / (m!)$$

The series converges uniformly for all values of λ .

4.2 Approximation Theorems for Second Order Equations

We will now prove approximation theorems for the second order non-canonical l.d.e. using the results obtained by Olver.

Consider the equation

$$y'' + \epsilon \omega_1 y' + \epsilon^2 \omega_0 y = 0 \tag{4.2.1}$$

valid in an interval $(a \leq t \leq b)$. In the light of the time scales treatment for large ϵ , the characteristic equation is:

$$x^2 + \omega_1(t)x + \omega_0(t) = 0 \tag{4.2.2}$$

The time scales approximation fails when the independent variable, t , has a value for which the roots coalesce, i. e. when the discriminant vanishes. Excluding this we have two cases for distinct roots, viz. when the roots are real or complex conjugates. Each case will be discussed separately.

(1) Case of Real and Distinct Roots; $D(\epsilon, t) \equiv \omega_1^2 - 4\omega_0 > 0$

In this case the approximation via time scales is given as

$$\tilde{y}_1^*(t) = c_1 \left\{ \frac{\exp\left(\int \frac{\dot{\omega}_1 dt}{2D^{\frac{1}{2}}}\right)}{D^{1/4}} \right\} \exp\left(-\frac{\epsilon}{2} \int \omega_1 dt\right) \exp\left(\frac{\epsilon}{2} \int D^{\frac{1}{2}} dt\right) \quad (a)$$

(4.2.3)

and

$$\tilde{y}_2^*(t) = c_2 \left\{ \frac{\exp\left(\frac{1}{2} \int \frac{\dot{\omega}_1 dt}{D^{\frac{1}{2}}}\right)}{D^{1/4}} \right\} \exp\left(-\frac{\epsilon}{2} \int \omega_1 dt\right) \exp\left(-\frac{\epsilon}{2} \int D^{\frac{1}{2}} dt\right) \quad (b)$$

where c_1, c_2 are arbitrary constants. Let us, however, consider the following approximations which are valid when $\dot{\omega}_1 \approx 0$ (Ref. Eq. (3.4.21 c)).

$$\tilde{y}_1(t) = \frac{c_1}{D^{1/4}} \exp\left(-\frac{\epsilon}{2} \int \omega_1 dt\right) \exp\left(+\frac{\epsilon}{2} \int D^{\frac{1}{2}} dt\right) \quad (a)$$

(4.2.4)

$$\tilde{y}_2(t) = \frac{c_2}{D^{1/4}} \exp\left(-\frac{\epsilon}{2} \int \omega_1 dt\right) \exp\left(-\frac{\epsilon}{2} \int D^{\frac{1}{2}} dt\right) \quad (b)$$

New variables ξ and W are introduced and defined by the relation:

$$\xi = \int n dt; \quad y = mW$$

where m and n are as yet undetermined functions of t and ϵ . We choose them such that ξ has a one-to-one correspondance with t . Let α and β be the values of ξ corresponding respectively to a, b . The differential equation (4.2.1) is now transformed into

$$mn^2 \frac{d^2 W(\epsilon, \xi)}{d\xi^2} + (\epsilon \omega_1 mn + m'n + (mn)') \frac{d}{d\xi} W(\epsilon, \xi) + (\epsilon^2 \omega_0 m + \epsilon \omega_1 m' + m'') W(\epsilon, \xi) = 0 \quad (4.2.5)$$

The primes denote differentiation w. r. t. t . We now seek mapping functions m and n such that in (4.2.5)

- (i) the coefficient of the first derivative w. r. t. ξ vanishes
- (ii) the coefficient of the second derivative and that of the ϵ^2 term multiplying $W(\epsilon, \xi)$ are the same.

The first condition above gives us the differential equation:

$$(mn)' + m'n + \epsilon \omega_1 mn = 0 \quad (4.2.6)$$

This can be readily integrated, using the integrating factor m . Thus,

$$\frac{d}{dt} \{ m^2 n \} = -\epsilon \omega_1$$

and hence

$$m^2 n = c \exp(-\epsilon \int \omega_1 dt) \quad (4.2.7)$$

The second condition gives

$$m^2 n = \omega_0 m + \text{coefft of } \epsilon \text{ in } (\omega_1 m') + \text{coefft of } \epsilon^2 \text{ in } (m'') \quad (4.2.8)$$

(a) If m is independent of ϵ , (4.2.8) gives $n = \omega_0^{-1/2}$. But from (4.2.7) $m^2 = \omega_0^{-1/2} \exp(-\epsilon \int \omega_1 dt)$, which results in a contradiction unless $\omega_1 = 0$. In this case $m = \omega_0^{-1/4}$, $n = \omega_0^{1/2}$, and this leads to the standard LG result.

(b) If m is also allowed to depend on ϵ , the choice of

$$m = \frac{\exp(-\frac{\epsilon}{2} \int \omega_1 dt)}{D^{1/4}}$$

leads to

$$n = \frac{D^{1/2}}{2}$$

which satisfy both the conditions (4.2.7) and (4.2.8). The transformed equation for W now is:

$$\frac{d^2 W}{d\xi^2} = \left\{ \epsilon^2 + 2\epsilon \frac{\dot{\omega}_1}{D} - 4D^{-3/4} (D^{-1/4})'' \right\} W$$

This can be written in the form

$$\frac{d^2 W}{d\xi^2} = \left\{ \epsilon^2 + f(\epsilon, t) \right\} W$$

where:

$$f(\epsilon, t) = \frac{2\epsilon \dot{\omega}_1}{D} - 4D^{-3/4} (D^{-1/4})'' \quad (4.2.10)$$

We now suppose that f is a continuous function of ξ . This is true if D is twice differentiable and does not vanish within the interval. Applying Olver's first theorem a solution $W_1(\epsilon, \xi)$ exists such that

$$W_1(\epsilon, \xi) = e^{\epsilon \xi} (1 + E_1), \quad \frac{d}{d\xi} W_1(\epsilon, \xi) = \epsilon e^{\epsilon \xi} (1 + 2\eta_1)$$

where

$$|E_1|, |\eta_1| \leq \exp\left(\frac{F_1}{2\epsilon}\right) - 1; \quad F_1 = \int_{\alpha}^{\xi} |f(\epsilon, \lambda)| d\lambda$$

In the original variables, $y_1 = D^{-1/4} W_1$ and $d\xi = \frac{D^{1/2}}{2} dt$, and similarly for the second solution y_2 .

The case when the characteristic roots are complex conjugates (discriminant $\omega_1^2 - 4\omega_0 < 0$) can be similarly treated using Olver's second theorem. Therefore, the following two approximation theorems have been established as extensions of Olver's results for the standard LG approximation.

Theorem 3. The differential equation

$$y'' + \epsilon \omega_1(\epsilon, t)y' + \epsilon^2 \omega_0(\epsilon, t)y = 0 \quad (4.2.1)$$

has solutions y_1 and y_2 such that

$$y_1(\epsilon, t) \leq \tilde{y}_1(\epsilon, t) \exp\left(\frac{1}{2\epsilon} \int_a^t |f(\epsilon, t)| dt\right) \quad (a)$$

$$y_2(\epsilon, t) \leq \tilde{y}_2(\epsilon, t) \exp\left(+\frac{1}{2\epsilon} \int_t^b |f(\epsilon, t)| dt\right) \quad (b)$$

where: ϵ is a positive parameter; $\tilde{y}_i = \left(\frac{\partial F}{\partial x}\right)^{-1/2} \exp\left(\epsilon \int x_i dt\right)$; $i=1, 2$

and x_i are the distinct real roots of the characteristic equation $F = 0$, with

$$F \equiv x^2 + \omega_1(\epsilon, t)x + \omega_0(\epsilon, t) \quad 80$$

Corollaries

and
$$f(\epsilon, t) = \left[\frac{2\epsilon \dot{\omega}_1}{D} - 4D^{-3/4} (D^{-1/4})'' \right] \frac{D^{1/2}}{2} = \left[\frac{\epsilon \dot{\omega}_1}{D^{3/2}} - 2D^{-1/4} (D^{-1/4})'' \right]$$

D being the discriminant of F, is positive and is assumed to be twice differentiable in the interval. The interval (a, b) may be infinite provided that the integrals converge.

When the characteristic roots are complex, the following theorem expresses the error of the time scales approximation.

Theorem 4. The differential equation (4.2.1) has conjugate solutions y and y* such that

$$y = \tilde{y} + E \tag{4.2.13}$$

where :

$$\tilde{y} = \left(\frac{\partial F}{\partial x} \right)^{-1/2} \exp(\epsilon \int x dt) \tag{4.2.14}$$

$$|E| \leq \frac{\exp(-\frac{\epsilon}{2} \int \omega_1 dt)}{D^{-1/4}} \left\{ \exp\left(\frac{1}{\epsilon} \left| \int_c^t |f(\epsilon, t)| dt \right| \right) - 1 \right\} \tag{4.2.15}$$

$$a < c < b$$

D, F and f are as given in Theorem 1, D being understood to be the absolute value of the discriminant; and x is the complex root of the equation F = 0.

We see from theorems 3 and 4 that the error of the approximations as stated is O(1) as $\epsilon \rightarrow \infty$. However, if we impose the condition that ω_1 varies more slowly than ω_0 , then the error is o(1) as ϵ becomes increasingly large. Thus as $\epsilon \rightarrow \infty$,

$$\omega_1 = \omega_1 \left(\frac{t}{\epsilon} \right)$$

and
$$\dot{\omega}_1 = \frac{1}{\epsilon} \omega_1'$$

In this case, for any fixed t, the error of the approximation becomes vanishingly small as $\epsilon \rightarrow \infty$.

Each of these theorems is valid on one side of a transition point (where D = 0) since they are corollaries of Olver's results. Nevertheless the difference in the form of the approximate solutions can be used to

advantage when dealing with the case of multiple characteristic roots.

A brief look at the two approximations may be in order here.

In regard to (4.2.1) the usual LG approximation is given as:

$$\bar{y}_1(t) = \frac{\exp(-\frac{\epsilon}{2} \int \omega_1 dt)}{(\omega_0 - \frac{\omega_1^2}{4} - \frac{\dot{\omega}_1}{2\epsilon})^{1/4}} \left\{ c_1 \exp(i\epsilon \int (\omega_0 - \frac{\omega_1^2}{4} - \frac{\dot{\omega}_1}{2\epsilon})^{1/2} dt) \right. \\ \left. + c_2 \exp(-i\epsilon \int (\omega_0 - \frac{\omega_1^2}{4} - \frac{\dot{\omega}_1}{2\epsilon})^{1/2} dt) \right\}$$

However, by treating the noncanonical form of the equation directly by time scales, one obtains, under certain restrictions, the approximation:

$$\tilde{y}_2(t) = \frac{\exp(-\frac{\epsilon}{2} \int \omega_1 dt)}{(\omega_0 - \frac{\omega_1^2}{4})^{1/4}} \left\{ c_1 \exp(i\epsilon \int (\omega_0 - \frac{\omega_1^2}{4})^{1/2} dt) + c_2 \exp(-i\epsilon \int (\omega_0 - \frac{\omega_1^2}{4})^{1/2} dt) \right\}$$

The errors of the approximation have been given in each case. Yet another approximation can be written as:

$$\tilde{y}_3^*(t) = \frac{\exp[\frac{1}{2} \int \frac{\dot{\omega}_1 dt}{(\omega_0 - \frac{\omega_1^2}{4})^{3/2}} - \frac{\epsilon}{2} \int \omega_1 dt]}{(\omega_0 - \frac{\omega_1^2}{4})^{1/4}} \left\{ c_1 \exp(i\epsilon \int (\omega_0 - \frac{\omega_1^2}{4})^{1/2} dt) \right. \\ \left. + c_2 \exp(-i\epsilon \int (\omega_0 - \frac{\omega_1^2}{4})^{1/2} dt) \right\}$$

The error of this approximation cannot be readily written by application of the Olver theorems. It can, however, be estimated by a different method, which will be the subject of the next discussion.

4.3 Derivation of Error Bounds

In order to assess the merits of the time scales approximation the estimates of the errors will be examined using a well-known method of successive approximations. This consists in treating an initial value problem and writing an integral equation which is satisfied by the unknown function. Iteration then gives a sequence of successive approximations. Bounds of the Olver type will be rederived, though they are not as sharp and the conditions are more restrictive. The emphasis, however, is on the directness and simplicity of the method and applicability to equations of second and higher order.

Second Order Equation

(i) Self-Adjoint Form. Consider again the equation

$$y'' + \epsilon^2 \omega y = 0 \tag{4.3.1}$$

in an interval (a, b). The approximation via extension is

$$\tilde{y}(t) = \omega^{-1/4} \exp(\pm i\epsilon \int \omega^{1/2} dt) \tag{4.3.2}$$

and is found to satisfy exactly the equation

$$\tilde{y}'' + (\epsilon^2 \omega + f(t)) \tilde{y} = 0 \tag{a}$$

$$\tag{4.3.3}$$

where:

$$f(t) = -\omega^{1/4} \frac{d^2}{dt^2} (\omega^{-1/4}) \tag{b}$$

Equation (4.3.1) is therefore written as

$$y'' + (\epsilon^2 \omega + f) y = fy \tag{4.3.4}$$

with f as given by (4.3.3 b).

Contrails

If f is small when compared to $\epsilon^2 \omega$, then (4.3.1) and (4.3.3 a) will be nearly the same and \tilde{y} can be expected to be a good approximation to y . In order to estimate the difference $y - \tilde{y}$, (4.3.4) is regarded as an inhomogeneous equation with the r. h. s. as a known forcing function. The method of variation of parameters enables one to write

$$y(t) = \tilde{y}(t) + \int_{\xi}^t h(t, s) f(s) y(s) ds \quad (4.3.5)$$

where ξ is some fixed point in the interval; $\tilde{y}(t)$ is the inhomogeneous solution and $h(t, s)$ is the Green's function (or the time-varying impulse response) respectively of (4.3.4). For a fixed s in (a, b) , $h(t, s)$ is a function of t , and satisfies (4.3.3 a) together with the initial conditions $h(s, s) = 0$; $\frac{\partial h}{\partial t}(s, s) = W(\tilde{y}_2, \tilde{y}_1) = 1$. In order to find approximations to y characterized by conditions at an interior point of (a, b) , or by its behavior as $t \rightarrow a$ or $t \rightarrow b$, we shall follow the argument presented by Erdelyi (Ref. 44) and thus ξ is chosen to be the point in question and $\tilde{y}(t)$ to be that solution of (4.3.3) which is characterized by the same conditions as $y(t)$.

(4.3.5) can be written as a Volterra integral equation

$$y(t) = \tilde{y}(t) + \int_c^t k(t, s) y(s) ds$$

where $k(t, s) = h(t, s) f(s)$.

From the theory of integral equations, the sequence of successive approximations converges uniformly when \tilde{y} and $k(t, s)$ are bounded (Ref. 39, 43). Let the equation (4.3.5) be rewritten as

$$y(t) = A\tilde{y}_1(t) + B\tilde{y}_2(t) + \tilde{y}_1(t) \int_{\xi}^t \frac{\tilde{y}_2(s) f(s) y(s)}{W(\tilde{y}_2, \tilde{y}_1)} ds - \tilde{y}_2(t) \int_{\xi}^t \frac{\tilde{y}_1(s) f(s) y(s)}{W(\tilde{y}_2, \tilde{y}_1)} ds \quad (4.3.6)$$

Contrails

where \tilde{y}_1, \tilde{y}_2 are the two independent solutions of (4.3.3) and $W(\tilde{y}_2, \tilde{y}_1)$ is the Wronskian defined by:

$$\begin{vmatrix} \tilde{y}_2 & \tilde{y}_1 \\ \tilde{y}_2' & \tilde{y}_1' \end{vmatrix}$$

(and is equal to 1); A, B are constants. Let $y_1(t)$ and $y_2(t)$ be defined respectively by the pair of conditions $A=1, B=0$ and $A=0, B=1$. Also let the subscripts 1, 2 respectively correspond to the + and - signs in the exponent in (4.3.2). The definiteness of the fractional powers of $\omega(t)$ is assured by agreeing to consider positive quantities only.

Case (1) Nonoscillatory Case. $\omega(t) \leq 0$ by Sturm's comparison theorem and the characteristic roots are real. For distinct roots we require $\omega(t) < 0$ in (a, b) . The conditions under which f is of constant sign in (a, b) can be determined by using Sturm's theorems (See Appendix III for a particular case).

The equation for y_1 can be written as:

$$y_1(t) = \tilde{y}_1(t) \left[1 + \int_{\xi}^t \tilde{y}_2(s) f(s) y_1(s) ds \right] - \tilde{y}_2(t) \int_{\xi}^t \tilde{y}_1(s) f(s) y_1(s) ds$$

From the above discussion and observing that \tilde{y}_1 and \tilde{y}_2 are positive functions, we can write the inequality

$$y_1(t) \leq \tilde{y}_1(t) \left[1 + \int_{\xi}^t \tilde{y}_2(s) f(s) y_1(s) ds \right]$$

and

$$\frac{y_1}{1 + \int_{\xi}^t \tilde{y}_2(s) f(s) y_1(s) ds} \leq \tilde{y}_1(t)$$

since the integral is positive. Multiplying both sides by $\tilde{y}_2 f$ and integrating between ξ and t :

Contrails

$$\frac{y_1(t)}{\tilde{y}_1(t)} \leq 1 + \int_{\xi}^t \tilde{y}_2(s) f(s) y_1(s) ds \leq \exp\left(\int_{\xi}^t \tilde{y}_1(s) \tilde{y}_2(s) f(s) ds\right)$$

Thus we have proved the following lemma.

Lemma. If in the interval (a, b)

$$y \leq \tilde{y} + \tilde{y} \int_a^t \mu(s) y(s) ds \tag{4.3.8}$$

then on (a, b),

$$y(t) \leq \tilde{y}(t) \exp\left(\int_a^t \mu \tilde{y} ds\right)$$

where y , μ , and \tilde{y} are positive.

Substituting for \tilde{y}_1 , \tilde{y}_2 , and f we get the final result:

$$y_1(t) \leq \tilde{y}_1(t) \exp\left\{\int_{\xi}^t \left[\omega^{-1/4} \left| (\omega^{-1/4})'' \right| \right] ds\right\} \tag{4.3.9 a}$$

The equation for $y_2(t)$ can be written as:

$$y_2(t) = \tilde{y}_2(t) + \tilde{y}_1(t) \int_{\xi}^t \tilde{y}_2(s) f(s) y_2(s) ds - \tilde{y}_2(t) \int_{\xi}^t \tilde{y}_1(s) f(s) y_2(s) ds$$

Considering \tilde{y}_1 , \tilde{y}_2 and $f y_2$ as positive, we can then write the inequality:

$$y_2(t) \leq \tilde{y}_2(t) \left[1 + \int_t^{\xi} \tilde{y}_1(s) f(s) y_2(s) ds \right]$$

By an analysis similar to the case of y_1 we arrive at the result:

$$y_2(t) \leq \tilde{y}_2(t) \exp\left(\int_t^{\xi} \left[\omega^{-1/4} \left| (\omega^{-1/4})'' \right| \right] ds\right) \tag{4.3.9 b}$$

Equation (4.3.9) (a, b) with $\xi = a, b$ respectively are precisely those obtained by Olver for $\epsilon=1$. Sharper bounds are derived later. The various cases can be discussed as follows.

Contrails

$$y(t) = A\tilde{y}_1 + B\tilde{y}_2 + \tilde{y}_1(t) \int_{\xi}^t \tilde{y}_2 f y ds - \tilde{y}_2(t) \int_{\xi}^t \tilde{y}_1 f y ds \quad (4.3.6 a)$$

when $fy > 0$.

(i) $f > 0, y > 0$

$$y_1(t) \leq \tilde{y}_1(t) \exp\left(\int_{\xi}^t \tilde{y}_1 \tilde{y}_2 f ds\right) \quad B=0; A=1$$

$$y_2(t) \leq \tilde{y}_2(t) \exp\left(\int_t^{\xi} \tilde{y}_1 \tilde{y}_2 f ds\right) \quad A=0; B=1$$

(ii) $f < 0, y < 0$

$$y_1 \leq \tilde{y}_1 \left[A + \int_{\xi}^t \tilde{y}_2 f y_1 ds \right]$$

$$|y_1| \leq |\tilde{y}_1| \left[A + \int_{\xi}^t |\tilde{y}_2| |f| |y_1| ds \right]$$

$$\frac{|\tilde{y}_1| |\tilde{y}_2| |f|}{A + \int_{\xi}^t |\tilde{y}_2| |f| |y_1| ds} \leq |\tilde{y}_1| |\tilde{y}_2| |f|$$

Hence $|y_1(t)| \leq |\tilde{y}_1(t)| \exp\left(\int_{\xi}^t |\tilde{y}_1| |\tilde{y}_2| |f| ds\right)$

and $|y_2(t)| \leq |\tilde{y}_2(t)| \exp\left(\int_t^{\xi} |\tilde{y}_1 \tilde{y}_2| |f| ds\right)$

when $fy < 0$.

(iii) $f > 0, y < 0$. If $w(t)$ is such that $y_1 < 0, \tilde{y}_1 < 0, \tilde{y}_2 < 0$, the conclusions on errors of case (ii) hold.

(iv) $f < 0, y > 0; f = -g$ and $g > 0$

$$y = A\tilde{y}_1 + B\tilde{y}_2 - \tilde{y}_1 \int_{\xi}^t \tilde{y}_2 g y ds + \tilde{y}_2 \int_{\xi}^t \tilde{y}_1 g y ds$$

Contrails

$$y_1 = \tilde{y}_1 \left[1 + \int_t^{\xi} \tilde{y}_2 g y_1 ds \right] - \tilde{y}_2 \int_t^{\xi} \tilde{y}_1 g y_1 ds$$

Thus $y_1 \leq \tilde{y}_1 \exp \left(\int_t^{\xi} \tilde{y}_1 \tilde{y}_2 g ds \right)$

Similarly $y_2 \leq \tilde{y}_2 \exp \left(\int_{\xi}^t \tilde{y}_1 \tilde{y}_2 g ds \right)$

Hence we can write, under the restrictions given above, when $f > 0$:

$$|y_1(t)| \leq |\tilde{y}_1(t)| \exp \left(\int_a^t |\tilde{y}_1 \tilde{y}_2| f ds \right) \quad (a)$$

$$|y_2(t)| \leq |\tilde{y}_2(t)| \exp \left(\int_t^b |\tilde{y}_1 \tilde{y}_2| f ds \right) \quad (b)$$

(4.3.10)

when $f < 0$

$$|y_1(t)| \leq |\tilde{y}_1(t)| \exp \left(\int_t^b |\tilde{y}_1 \tilde{y}_2| f ds \right) \quad (c)$$

$$|y_2(t)| \leq |\tilde{y}_2(t)| \exp \left(\int_a^t |\tilde{y}_1 \tilde{y}_2| f ds \right) \quad (d)$$

Uniform bounds can be obtained as:

$$|y_{1,2}(t)| \leq |\tilde{y}_{1,2}(t)| \exp \left(\int_a^b |\tilde{y}_1 \tilde{y}_2| f ds \right) \quad (4.3.11)$$

Denoting $F_1 = \int_a^t |\tilde{y}_1 \tilde{y}_2| f ds$; $F_2 = \int_t^b |\tilde{y}_1 \tilde{y}_2| f ds$; $F = \int_a^b |\tilde{y}_1 \tilde{y}_2| f dt$

and using the inequality $(n+1)! > 2^n$, we can obtain bounds which are less sharp: if $F_i < 2$,

$$|y_1| \leq |\tilde{y}_1| \frac{2-F_i}{2-F_i} \quad i = 1, 2$$

or $|y_{1,a}| \leq |\tilde{y}_{1,a}| \frac{2F}{2-F} \quad \text{if } F < 2 \quad (4.3.12)$

Case (2) Oscillatory Case. $\omega > 0$ and characteristic roots are imaginary. As before:

$$y(t) = A\tilde{y}_1 + B\tilde{y}_2 + \int_{\xi}^t [\tilde{y}_1(t)\tilde{y}_2(s) - \tilde{y}_2(t)\tilde{y}_1(s)] f(s) y(s) ds$$

Let us write \tilde{y}_1 and \tilde{y}_2 as $\tilde{y}_1 = \omega^{-1/4} \sin \alpha(t)$ and $\tilde{y}_2 = \omega^{-1/4} \cos \alpha(t)$ where $\alpha(t) = \epsilon \int_{\xi}^t \omega^{1/2} dt$. And therefore:

$$\begin{aligned} y_1(t) &= \tilde{y}_1(t) + \int_{\xi}^t [\sin \alpha(t) \cos \alpha(s) - \cos \alpha(t) \sin \alpha(s)] \omega^{-1/4}(t) \omega^{-1/4}(s) f(s) y(s) ds \\ &= \tilde{y}_1(t) + \int_{\xi}^t \sin(\alpha(t) - \alpha(s)) \omega^{-1/4}(t) \omega^{-1/4}(s) f(s) y_1(s) ds \end{aligned}$$

$$y_1 \leq \tilde{y}_1 + \int_{\xi}^t |\omega^{-1/4}(t)| |\omega^{-1/4}(s)| |f(s)| |y_1(s)| ds$$

Let $\omega^{-1/4}$ be bounded in (a, b) by M . Hence $|\tilde{y}_1| \leq M$

$$|y_1| \leq |\tilde{y}_1| + M^2 \int_{\xi}^t |f| |y_1| ds$$

By Gronwall's lemma

$$|y_1(t)| \leq |\tilde{y}_1(t)| + M^2 \int_{\xi}^t |\tilde{y}_1(s) f| \exp\left(\int_{\xi}^t M^2 |f| d\tau\right) ds$$

$$|y_1(t)| \leq |\tilde{y}_1(t)| - M^2 \int_{\xi}^t \frac{\partial}{\partial s} \left[\exp\left(\int_s^t M^2 |f| d\tau\right) \right] ds$$

i. e.:

$$|y_1(t)| \leq |\tilde{y}_1(t)| - M^2 \left[\exp\left(\int_{\xi}^t M^2 |f| d\tau\right) - 1 \right] \quad \begin{matrix} s=t \\ s=\xi \end{matrix}$$

$$|y_1(t)| \leq |\tilde{y}_1(t)| + M^2 \left[\exp\left(\int_{\xi}^t M^2 |f| d\tau\right) - 1 \right] \quad \begin{matrix} \text{(a)} \\ \text{(4.3.13)} \end{matrix}$$

Similarly:

$$|y_2(t)| \leq |\tilde{y}_2(t)| + M^2 \left[\exp\left(\int_{\xi}^t M^2 |f| d\tau\right) - 1 \right] \quad \text{(b)}$$

Sharpening of Bounds: Oscillatory Case. These bounds can be sharpened as follows. Applying the Liouville transformation $y = \omega^{-1/4} z$, $\xi = \int \omega^{1/2} dt$, transforms (4.3.1) into

$$z'' + (\epsilon^2 + f_1)z = 0 \quad \text{(4.3.14)}$$

where:

$$f_1 = \omega^{-3/4} \frac{d^2}{dt^2} (\omega^{-1/4}) \quad \text{(4.3.15)}$$

Solution of (4.3.14) can be written as

$$z(\xi) = A\tilde{z}_1(\xi) + B\tilde{z}_2(\xi) + \int_{\alpha}^{\xi} \left(\tilde{z}_1(\xi)\tilde{z}_2(s) - \tilde{z}_2(\xi)\tilde{z}_1(s) \right) f_1(s)z(s) ds$$

where \tilde{z}_1, \tilde{z}_2 are the solutions of:

$$z'' + \epsilon^2 z = 0$$

With the same restrictions on initial conditions as before, and choosing

$$\tilde{z}_1 = \frac{1}{\epsilon} \cos \epsilon \xi, \quad \tilde{z}_2 = \sin \epsilon \xi$$

so that the Wronskian $W(\tilde{z}_1, \tilde{z}_2) = 1$, we can write

Contrails

$$\begin{aligned}
 z_2(\xi) &= \tilde{z}_2(\xi) + \frac{1}{\epsilon} \int_{\alpha}^{\xi} (\cos \epsilon \xi \sin \epsilon s - \sin \epsilon \xi \cos \epsilon s) f_1(s) z_2(s) ds \\
 &= \tilde{z}_2(\xi) + \frac{1}{\epsilon} \int_{\alpha}^{\xi} (-\sin(\epsilon s - \epsilon \xi)) f_1(s) z_2(s) ds
 \end{aligned}$$

i. e.:

$$z_2(\xi) \leq \tilde{z}_2(\xi) + \frac{1}{\epsilon} \int_{\alpha}^{\xi} |f_1(s)| |z_2(s)| ds$$

Further:

$$|z_2(\xi)| \leq |\tilde{z}_2(\xi)| + \frac{1}{\epsilon} \int_{\alpha}^{\xi} |f_1(s)| |z_2(s)| ds$$

By Gronwall's lemma

$$|z_2(\xi)| \leq |\tilde{z}_2(\xi)| + \frac{1}{\epsilon} \int_{\alpha}^{\xi} |\tilde{z}_2(s)| |f_1(s)| \exp\left(\int_s^{\xi} \left|\frac{f_1(\tau)}{\epsilon}\right| d\tau\right) ds$$

i. e.:

$$|z_2(\xi)| \leq |\tilde{z}_2(\xi)| + \int_{\alpha}^{\xi} -\frac{\partial}{\partial s} \exp\left(\frac{1}{\epsilon} \int_s^{\xi} |f_1(\tau)| d\tau\right) ds$$

since $\tilde{z}_2(s)$ is bounded and this property is used only in the integral.

Thus:

$$|z_2(\xi)| \leq |\tilde{z}_2(\xi)| - \left[\exp\left(\frac{1}{\epsilon} \int_s^{\xi} |f_1(\tau)| d\tau\right) \right]_{s=\alpha}^{s=\xi}$$

$$\text{i. e. : } |z_2(\xi)| \leq |\tilde{z}_2(\xi)| + \exp\left(\frac{1}{\epsilon} \int_{\alpha}^{\xi} |f_1(\tau)| d\tau\right) - 1$$

Now transforming back to the original variables, and noting that:

$$d\xi = \omega^{\frac{1}{2}} dt$$

$$|y_2(t)| \leq \omega^{-1/4} \left\{ \sin\left(\epsilon \int \omega^{\frac{1}{2}} dt\right) + \exp\left(\frac{1}{\epsilon} \int_a^t \left|\omega^{-1/4} (\omega^{-1/4})''\right| dt\right) - 1 \right\}$$

This can be written in the form

$$y_2(t) = \omega^{-1/4}(t) \left\{ \sin \left(\epsilon \int \omega^{1/2} dt \right) + E \right\} \quad (4.3.16)$$

where

$$|E| \leq \exp \left(\frac{1}{\epsilon} \left| \int_c^t \left| \omega^{-1/4} (x^{-1/4})'' \right| dt \right| \right) - 1$$

and c is in (a, b) . This is Olver's result for the envelope of the solutions. The other solution can be studied in the same manner and similar bounds can be obtained. This also embraces a theorem of Wintner (Ref. 45) which is derived for the case in which $\epsilon = 1$ and the interval is infinite. Asymptoticity of the solution for $\epsilon \rightarrow \infty$ is thus demonstrated.

Sharpening of the Bounds: Nonoscillatory Case. We will now consider the equation:

$$y'' - \epsilon^2 \omega y = 0 \quad (4.3.17)$$

As before the Liouville transformation leads to the equation

$$z'' - (\epsilon^2 - f_1)z = 0 \quad (4.3.18)$$

with f_1 being given by (4.3.15). Again treating (4.3.18) as an inhomogeneous equation, the solution is written as

$$z = A\tilde{z}_1 + B\tilde{z}_2 + \tilde{z}_1(\xi) \int \tilde{z}_2 f_1 z ds - \tilde{z}_2(\xi) \int \tilde{z}_1(s) f_1 z ds \quad (4.3.19)$$

where \tilde{z}_1 and \tilde{z}_2 are the solutions of the equation

$$z'' - \epsilon^2 z = 0$$

chosen such that the Wronskian:

$$W(\tilde{z}_1, \tilde{z}_2) = 1$$

Thus $\tilde{z}_1 = e^{-\epsilon \xi}$, $\tilde{z}_2 = \frac{e^{\epsilon \xi}}{2\epsilon}$ (4.3.20)

From (4.3.19) we can write:

$$z_1 = \tilde{z}_1 + \tilde{z}_1 \int_{\alpha}^{\xi} \tilde{z}_2 f_1 z_1 ds - \tilde{z}_2 \int_{\alpha}^{\xi} \tilde{z}_1 f_1 z_1 ds$$
 (4.3.20)

For the conditions under which

$$f_1 z_1 \geq 0$$

we can write the inequality:

$$z_1 \leq \tilde{z}_1 + \tilde{z}_1 \int_{\alpha}^{\xi} \tilde{z}_2 f z_1 ds$$
 (4.3.21)

Now lemma (4.3.8) leads to the result

$$z_1 \leq \tilde{z}_1 \exp\left(\int_{\alpha}^{\xi} \tilde{z}_1 \tilde{z}_2 f ds\right)$$

for $f > 0$. On substituting from (4.3.20) and transforming back to the original variables, the following result is obtained.

$$y_1(t) = \omega^{-1/4} \exp\left(-\epsilon \int \omega^{1/2} dt\right) \{1 + E_1\}$$
 (a)
(4.3.21)

where $|E_1| \leq \exp\left(\frac{1}{2\epsilon} \int_a^t \omega^{-1/4} (\omega^{-1/4})'' ds\right) - 1$ (b)

Similarly the following result is obtained for the other solution.

$$y_2(t) = \omega^{-1/4} \exp\left(\epsilon \int \omega^{1/2} dt\right) \{1 + E_2\}$$
 (a)
(4.3.22)

where $|E_2| \leq \exp\left(\frac{1}{2\epsilon} \int_t^b \omega^{-1/4} (\omega^{-1/4})'' ds\right) - 1$ (b)

These bounds are precisely those obtained by Olver (Ref. 28); here they have been obtained by a direct procedure, but under the conditions $f > 0$ and $z > 0$. For any given $\omega(t)$ the sign of $f(t)$ can be checked. The sign of the solution must be determined using Sturmian theory.

(ii) Second Order Equation: Noncanonical Form. The equation

$$y'' + \epsilon \omega_1 y' + \epsilon^2 \omega_0 y = 0 \quad (3.2.19)$$

can be treated in a similar manner. The time scales approximations

$$\tilde{y}_{1,2} = D^{-1/4} \exp \left(\epsilon \int \left(-\frac{\omega_1}{2} \pm \frac{D^{1/4}}{2} \right) dt \right)$$

are the exact solutions of the equations

$$\tilde{y}'' + \epsilon \omega_1 \tilde{y}' + (\epsilon^2 \omega_0 + f) \tilde{y} = 0$$

where $f(\epsilon, t) = \frac{\epsilon \dot{\omega}_1}{2} - D^{1/4} (D^{-1/4})''$

and D is the discriminant $= \omega_1^2 - 4\omega_0$. The original equation is therefore written in the form:

$$y'' + \epsilon \omega_1 y' + (\epsilon^2 \omega_0 + f)y = fy$$

The general solution of this is given by:

$$y(t) = A\tilde{y}_1 + B\tilde{y}_2 + \tilde{y}_1 \int \frac{\tilde{y}_2 fy ds}{W(\tilde{y}_2, \tilde{y}_1)} - \tilde{y}_2 \int \frac{\tilde{y}_1 fy ds}{W(\tilde{y}_2, \tilde{y}_1)}$$

The equation (3.2.19) is not in self-adjoint form and hence the Wronskian $W(\tilde{y}_2, \tilde{y}_1)$ is not a constant. By Abel's formula (Ref. 60)

$$W(\tilde{y}_2, \tilde{y}_1) = \exp(-\epsilon \int \omega_1 dt);$$

and therefore

$$y(t) = A\tilde{y}_1 + B\tilde{y}_2 + \tilde{y}_1 \int \tilde{y}_2 g y ds - \tilde{y}_2 \int \tilde{y}_1 g y ds$$

where $g(\epsilon, t) = \frac{f(\epsilon, t)}{W(\tilde{y}_2, \tilde{y}_1)}$ (4.3.23)

By a similar line of reasoning as in the self-adjoint case we arrive at the bounds (4.3.10) provided f is replaced by $g(\epsilon, t)$. It can be verified that this leads to the results obtained by application of Olver's lemma and stated in Theorems 1 and 2 (4.2.11; a, b).

4.4 Third Order Equation:

We now apply the ideas used in the last section to higher order equations and derive error bounds for the approximation obtained by the use of multiple time scales. The analysis is more difficult since oscillation criteria such as the elegant theorems of Sturm are not readily available for higher order equations. As Hartman says, "The difficulty arises from the fact that the theorems of Sturm do not have complete analogues" in higher order systems (Ref. 23, p. 384). Nevertheless the asymptotic solutions are oscillatory if the characteristic roots are complex and monotonic (in the sense of having at most one zero) if the roots are real (Ref. 46). Conditions on the coefficients can be determined such that the solutions are disconjugate (Ref. 23, p. 384).

We shall start with the third order equation (3.3.9 a). i. e.:

$$y''' + \epsilon^2 \omega_1 y' + \epsilon^3 \omega_0 y = 0 \tag{3.3.9 a}$$

in the interval (a, b).

The approximation via the time scales method is obtained from (3.4.21 c) as

$$\tilde{y}(t) = D(t) \exp(\epsilon \int_{\xi}^t x dt) \tag{a}$$

where $\xi = a$

where $D(t) = (3x^2 + \omega_1)^{-\frac{1}{2}}$ (b)

and x is a characteristic root. Now \tilde{y} satisfies exactly the equation (4.4.1)

$$y''' + \epsilon^2 \omega_1 y' + (\epsilon^3 \omega_0 + f(\epsilon, t)) y = 0 \quad (c)$$

where $f(\epsilon, t) = \epsilon^2 \frac{\dot{\omega}_1}{2} - \epsilon (x'' + \frac{3x'D'}{D} + \frac{3xD''}{D}) - \frac{D'''}{D}$ (d)

Equation (3.3.9 a) is written as

$$y''' + \epsilon^2 \omega_1 y' + (\epsilon^3 \omega_0 + f)y = fy \quad (4.4.2)$$

with f as given by (4.4.1 b). Again when $f(\epsilon, t)$ is small in comparison with $\epsilon^3 \omega_0$, solutions of (3.3.9 a) and (4.4.1 c) will nearly be the same. The integral equation corresponding to (4.4.2) is given as

$$y(t) = A\tilde{y}_1 + B\tilde{y}_2 + C\tilde{y}_3 + \tilde{y}_1 \int_{\xi}^t (\tilde{y}'_2 \tilde{y}_3 - \tilde{y}'_3 \tilde{y}_2) fy ds - \tilde{y}_2 \int_{\xi}^t (\tilde{y}'_1 \tilde{y}_3 - \tilde{y}'_3 \tilde{y}_1) fy ds - \tilde{y}_3 \int_{\xi}^t (\tilde{y}'_2 \tilde{y}_1 - \tilde{y}'_1 \tilde{y}_2) fy ds \quad (4.4.3)$$

with $-W(\tilde{y}_1, \tilde{y}_2, \tilde{y}_3) = 1$. The discussion follows the one for second order equations and $\tilde{y}(t)$ is chosen to be that solution of (4.4.1 c) which is characterized by the same conditions as $y(t)$ at any point ξ in (a, b). As before let the conditions $A=1, B=C=0; B=1, A=C=0$ and $C=1, A=B=0$ correspond respectively to the subscripts 1, 2, 3. Further, we notice that for the canonical equation the sum of the characteristic roots will be zero.

Nonoscillatory Solutions. In this case the characteristic roots are real,

Case (1) $fy > 0$. Let the roots be ordered such that:

$$x_2 > x_1 > x_3 \quad (4.4.4)$$

Contrails

Hence:

$$y_1(t) = \tilde{y}_1 \left[1 + \int_{\xi}^t (\tilde{y}'_2 \tilde{y}_3 - \tilde{y}'_3 \tilde{y}_2) f y_1 ds \right] \\ - \tilde{y}_2 \int_{\xi}^t (\tilde{y}'_1 \tilde{y}_3 - \tilde{y}'_3 \tilde{y}_1) f y_1 ds - \tilde{y}_3 \int_{\xi}^t (\tilde{y}'_2 \tilde{y}_1 - \tilde{y}'_1 \tilde{y}_2) f y_1 ds$$

Let us consider now that the conditions are such that $y_1 > 0$ in the interval (a, b) . Also in \tilde{y} which is the approximation for y the explicit amplitude variation expressed by D is understood to be positive.

Since $\tilde{y}(t) = D(t) \exp\left(\epsilon \int_{\xi}^t x dt\right)$ where $D(t) = (3x^2 + \omega_1)^{-\frac{1}{2}}$,

$$\tilde{y}'(t) = \left(\frac{D'}{D} + \epsilon x \right) \tilde{y}$$

and:
$$\tilde{y}'_2 \tilde{y}_3 - \tilde{y}'_3 \tilde{y}_2 = \left\{ \left(\frac{D'_2}{D_2} - \frac{D'_3}{D_3} \right) + \epsilon (x_2 - x_3) \right\} \tilde{y}_2 \tilde{y}_3$$

Now
$$\left(\frac{D'_2}{D_2} - \frac{D'_3}{D_3} \right) = \frac{d}{dt} \ln D_2 - \frac{d}{dt} \ln D_3 \\ = -\frac{1}{2} \left[\frac{d}{dt} \ln (3x_2^2 + \omega_1) - \frac{d}{dt} \ln (3x_3^2 + \omega_1) \right] \\ = -\frac{1}{2} \left[\frac{(3x_2^2 + \omega_1)'}{(3x_2^2 + \omega_1)} - \frac{(3x_3^2 + \omega_1)'}{(3x_3^2 + \omega_1)} \right]$$

Now if $x_2 > x_1 > x_3$ and the roots do not coalesce the root variations may be assumed to be of the same order of magnitude. Thus $\left(\frac{D'_2}{D_2} - \frac{D'_3}{D_3}\right) \geq 0$; and in any case, for large ϵ , $\tilde{y}'_2 \tilde{y}_3 - \tilde{y}'_3 \tilde{y}_2 > 0$.

In the special case when

$$\frac{\omega_1^3(t)}{\omega_0^2(t)} = \text{constant},$$

$D(t)$ has a particularly simple form given by $D(t) = \omega_1^{-\frac{1}{2}}(t) = \omega_0^{-1/3}(t)$ (a)

and $\tilde{y}'_2 \tilde{y}_3 - \tilde{y}'_3 \tilde{y}_2 = \epsilon (x_2 - x_3) \tilde{y}_2 \tilde{y}_3 = \epsilon (x_2 - x_3) \omega_1^{-1}(t) \exp\left(\epsilon \int_{\xi}^t (x_2 + x_3) ds\right)$ (b)

Contrails

Similarly $\tilde{y}'_1 \tilde{y}_3 - \tilde{y}'_3 \tilde{y}_1 = \epsilon (x_1 - x_3) \tilde{y}_1 \tilde{y}_3$ (c) (4.4.5)

$$\tilde{y}'_2 \tilde{y}_1 - \tilde{y}'_1 \tilde{y}_2 = \epsilon (x_2 - x_1) \tilde{y}_1 \tilde{y}_2 \quad (d)$$

The exponentials in \tilde{y} have real argument and the following inequalities can therefore be written, for large ϵ .

$$\tilde{y}'_2 \tilde{y}_3 - \tilde{y}'_3 \tilde{y}_2 > 0$$

$$\tilde{y}'_1 \tilde{y}_3 - \tilde{y}'_3 \tilde{y}_1 > 0 \quad (4.4.6)$$

$$\tilde{y}'_2 \tilde{y}_1 - \tilde{y}'_1 \tilde{y}_2 > 0$$

Hence: $y_1(t) \leq \tilde{y}_1(t) \left[1 + \int_{\xi}^t (\tilde{y}'_2 \tilde{y}_3 - \tilde{y}'_3 \tilde{y}_2) f y_1 ds \right]$

By applying the lemma (4.3.8) this immediately leads to:

$$y_1(t) \leq \tilde{y}_1(t) \exp\left(\int_{\xi}^t \tilde{y}_1 (\tilde{y}'_2 \tilde{y}_3 - \tilde{y}'_3 \tilde{y}_2) f ds \right) \quad (4.4.7 a)$$

But when $\frac{\omega_1^3}{\omega_0^2} = k = \text{constant}$

$$\begin{aligned} \tilde{y}_1 (\tilde{y}'_2 \tilde{y}_3 - \tilde{y}'_3 \tilde{y}_2) &= \epsilon (x_2 - x_3) \tilde{y}_1 \tilde{y}_2 \tilde{y}_3 \\ &= \epsilon (x_2 - x_3) D^3(t) \end{aligned}$$

since $x_1 + x_2 + x_3 = 0$. Therefore

$$\tilde{y}_1 (\tilde{y}'_2 \tilde{y}_3 - \tilde{y}'_3 \tilde{y}_2) = \epsilon \omega_1^{-3/2}(t) (x_2 - x_3)$$

since : $D = \omega_1^{-1/2}(t)$

The approximation can be written as

$$y_1 = \tilde{y}_1 (1 + \tilde{E}_1) \quad (4.4.7 b)$$

where:

$$|\tilde{E}_1| \leq \exp \left\{ \epsilon \int_{\xi}^t \omega_1^{-3/2}(s)(x_2 - x_3) |f(\epsilon, s)| ds \right\} - 1$$

Now for $A=C \neq 0$, $B=1$, from (4.4.3) we can write the inequality:

$$y_2(t) \leq \tilde{y}_2(t) + \tilde{y}_1(t) \int_{\xi}^t (\tilde{y}_2' \tilde{y}_3 - \tilde{y}_3' \tilde{y}_2) f y_2 ds$$

Applying Gronwall's lemma to the ratio $y_2(t)/\tilde{y}_1(t)$, we obtain:

$$y_2(t) \leq \tilde{y}_2(t) + \tilde{y}_1 \int_{\xi}^t ds \tilde{y}_2 (\tilde{y}_2' \tilde{y}_3 - \tilde{y}_3' \tilde{y}_2) f \exp \left[\int_s^t \tilde{y}_1 (\tilde{y}_2' \tilde{y}_3 - \tilde{y}_3' \tilde{y}_2) f d\tau \right] \quad (4.4.8 a)$$

When $\tilde{y}_1, \tilde{y}_2, \tilde{y}_3$ are bounded by L_1, M_1, N , respectively, a simplified bound can be obtained as

$$y_2(t) \leq \tilde{y}_2(t) + \tilde{y}_1 \frac{M_1}{L_1} \left\{ \exp \left(\int_{\xi}^t \tilde{y}_1 (\tilde{y}_2' \tilde{y}_3 - \tilde{y}_3' \tilde{y}_2) f ds \right) - 1 \right\} \quad (4.4.8 b)$$

which, when $\omega_1^3 \sim \omega_0^3$, can be written in the form

$$y_2(t) = \tilde{y}_2(t) + \tilde{E}_2$$

where:

$$|\tilde{E}_2| \leq \frac{M_1}{L_1} \tilde{y}_1(t) \left\{ \exp \left(\epsilon \int_{\xi}^t \omega_1^{-3/2}(x_2 - x_3) |f(\epsilon, s)| ds \right) - 1 \right\} \quad (4.4.8 c)$$

Similarly, choice of $A=B=0$, $C=1$ leads to the bound on $y_3(t)$:

$$y_3(t) \leq \tilde{y}_3(t) + \tilde{y}_1 \int_{\xi}^t (\tilde{y}_2' \tilde{y}_3 - \tilde{y}_3' \tilde{y}_2) f y_3 ds$$

$$y_3(t) \leq \tilde{y}_3(t) + \tilde{y}_1(t) \int_{\xi}^t (\tilde{y}_2' \tilde{y}_3 - \tilde{y}_3' \tilde{y}_2) \tilde{y}_3 f \exp \left(\int_s^t \tilde{y}_1 (\tilde{y}_2' \tilde{y}_3 - \tilde{y}_3' \tilde{y}_2) f d\tau \right) ds \quad (a)$$

A simplified bound is obtained as

$$y_3(t) \leq \tilde{y}_3(t) + \frac{N_1}{L_1} \tilde{y}_1(t) \left\{ \exp\left(\int_{\xi}^t y_1 (\tilde{y}_2' y_3 - y_3' \tilde{y}_2) f ds \right) - 1 \right\} \quad (b) \quad (4.4.9)$$

or alternatively, when $\omega_1^3 = k \omega_0^2$, k being a constant

$$y_3(t) = \tilde{y}_3(t) + \tilde{E}_3$$

where:

$$|\tilde{E}_3| \leq \frac{N_1}{L_1} \tilde{y}_1(t) \left[\exp\left(\epsilon \int_{\xi}^t \omega_1^{-3/2} (x_2 - x_3) |f(\epsilon, s)| ds \right) - 1 \right] \quad (c)$$

Case (2) $fy < 0$. With reference to (4.4.3) let the integrals be denoted by I_1, I_2, I_3 in that order. When fy is negative the signs of all the integral terms are changed. Therefore, if these terms are to have the same signs as in the previous case the ordering of the roots has to be changed. In place of (4.4.5) the following inequalities are needed.

$$\tilde{y}_2' \tilde{y}_3 - \tilde{y}_3' \tilde{y}_2 < 0; \quad \tilde{y}_1' \tilde{y}_3 - \tilde{y}_3' \tilde{y}_1 < 0 \quad (4.4.10)$$

The roots are therefore ordered such that $x_3 > x_1 > x_2$; i. e. the roots x_2, x_3 are interchanged w. r. t. case (1).

The analysis is carried out in the same manner as for case (1) and the results (4.4.7), (4.4.8), (4.4.9) and (4.4.10) the following approximation theorem has been obtained.

Theorem 5. In a given interval (a, b) the differential equation

$$y''' + \epsilon^3 \omega_1(\epsilon, t) y' + \epsilon^3 \omega_0(\epsilon, t) y = 0 \quad (4.4.11)$$

possesses the solutions y_1, y_2, y_3 such that

$$y_1 = \tilde{y}_1 (1 + \tilde{E}_1); \quad y_2 = \tilde{y}_2 + \tilde{E}_2; \quad y_3 = \tilde{y}_3 + \tilde{E}_3 \quad (4.4.12)$$

Contrails

where
$$\tilde{y}_i(t) = D_i^{-1} e^t (\epsilon x_i) ; i=1,2,3 \quad (4.4.13)$$

$$D_i(t) = (3x_i^2 + \omega_1)^{-\frac{1}{2}} \quad (4.4.14)$$

and $x_i(\epsilon, t)$ are the roots of the characteristic equation

$$x^3 + \omega_1(\epsilon, t)x + \omega_0(\epsilon, t) = 0 \quad (4.4.15)$$

$$|\tilde{E}_1| \leq e_a^t (F_1) - 1$$

$$|\tilde{E}_2| \leq \tilde{y}_1 \int_a^t ds \tilde{y}_1^{-1} \tilde{y}_2 F_1(\epsilon, s) e_s^t (F_1) \quad (4.4.16 a)$$

$$|\tilde{E}_3| \leq \tilde{y}_1 \int_a^t ds \tilde{y}_1^{-1} \tilde{y}_3 F_1(\epsilon, s) e_s^t (F_1)$$

$$F_1(\epsilon, t) = \tilde{y}_1(t) (\tilde{y}_2' \tilde{y}_3 - \tilde{y}_3' \tilde{y}_2) f(\epsilon, t) \quad (4.4.17)$$

$$f(\epsilon, t) = \frac{e^a \omega_1}{2} - \epsilon (x'' + \frac{3x'D'}{D} + \frac{3xD''}{D}) - \frac{D'''}{D} \quad (4.4.18)$$

and $e_\alpha^\beta(\gamma)$ is an operator defined by
$$e_\alpha^\beta(\gamma) = \exp\left(\int_\alpha^\beta \gamma(\lambda) d\lambda\right) \quad (4.4.19)$$

provided that the following conditions are met:

(i) the roots x_i are real and distinct (4.4.20)

(ii) f_y is of constant sign in (a, b) (4.4.21)

and further the roots are ordered such that $x_2 > x_1 > x_3$ if $f_y > 0$ and $x_3 > x_1 > x_2$ when $f_y < 0$.

The derivatives in $f(\epsilon, t)$ are assumed to exist and the interval may be infinite if the integrals in (4.4.16) converge.

The condition (4.4.20) is satisfied if the discriminant
$$q^3 + r^2 < 0 \text{ where } q = \frac{\omega_1}{3}, r = -\frac{\omega_0}{2} \quad (4.4.22)$$

The validity of (4.4.21) must be ensured by examination of initial conditions and oscillation criteria.

Uniform bounds can be obtained by replacing the upper limit of integration by b in (4.4.16 a).

Simplified bounds can be obtained by noting that $(n+1)! \geq 2^n$. Thus:

$$\begin{aligned} \exp(\alpha) - 1 &= \sum_0^{\infty} \frac{\alpha^{n+1}}{(n+1)!} \\ &\leq \sum_0^{\infty} \frac{\alpha^{n+1}}{2^n} = \alpha \sum_0^{\infty} \left(\frac{\alpha}{2}\right)^n = \frac{\alpha}{1 - \frac{\alpha}{2}} \end{aligned}$$

Hence $\left| \tilde{E}_1 \right| \leq \frac{\alpha}{1 - \frac{\alpha}{2}}$ if $\alpha < 2$ (4.4.23)

where:

$$\alpha = \int_a^t F_1 d\lambda$$

Similar bounds can be determined for the other two relations in (4.5.6).

If $\tilde{y}_1, \tilde{y}_2, \tilde{y}_3$ are bounded by L_1, M_1, N_1 respectively, the following relations can be used in Theorem 3.

$$\left. \begin{aligned} \left| \tilde{E}_2 \right| &\leq \frac{M_1}{L_1} \tilde{y}_1 \left[e_a^t (F_1) - 1 \right] \\ \left| \tilde{E}_3 \right| &\leq \frac{N_1}{L_1} \tilde{y}_1(t) \left[e_a^t (F_1) - 1 \right] \end{aligned} \right\} \quad (4.4.16 b)$$

Further, in the case when $\frac{\omega_1^3}{\omega_0^3} = \text{constant}$ the bounds turn out to be simple.

$$D(t) = \omega_1^{-\frac{1}{b}}(\epsilon, t) \quad (4.4.16 c)$$

$$F_1 = \epsilon \omega^{-\frac{3}{a}}(x_2 - x_3) f(\epsilon, t) \quad (4.4.17 c)$$

4.5 Oscillatory Case

In this case the characteristic roots consist of one real root and a pair of complex conjugate roots, symmetrically placed about the origin of the complex root plane. Let x_1 be the real root. Equation (4.4.3) can now be written as

$$y(t) = A\tilde{y}_1 + B\tilde{y}_2 + C\tilde{y}_3 + \int_{\xi}^t h(t,s) f y ds \quad (4.5.1)$$

where

$$h(t,s) = \tilde{y}_2(t) (\tilde{y}_1 \tilde{y}_3' - \tilde{y}_3 \tilde{y}_1')(s) + \tilde{y}_3(t) (\tilde{y}_2 \tilde{y}_1' - \tilde{y}_1 \tilde{y}_2')(s) + \tilde{y}_1(t) (\tilde{y}_2 \tilde{y}_3' - \tilde{y}_3 \tilde{y}_2')(s)$$

Now if $\tilde{y}_1(t)$ and $\tilde{y}_2(t)$, $\tilde{y}_3(t)$ (\tilde{y}_2 and \tilde{y}_3 are complex conjugates) are bounded from above by L_2 and M_2 respectively, then

$$\int_{\xi}^t h(t,s) f y ds \leq \int_{\xi}^t |h(t,s) f y| ds \leq \int_{\xi}^t |P_1| |f| |y| ds \quad (4.5.2)$$

where:

$$P_1 = M_2 \left\{ \left| \tilde{y}_1 \tilde{y}_3' - \tilde{y}_3 \tilde{y}_1' \right| + \left| \tilde{y}_2 \tilde{y}_1' - \tilde{y}_1 \tilde{y}_2' \right| + \frac{L_2}{M_2} \left| \tilde{y}_2 \tilde{y}_3' - \tilde{y}_3 \tilde{y}_2' \right| \right\} \quad (4.5.3)$$

Now choosing $A=1, B=C=0; A=C=0, B=1$ and $A=B=0, C=1$ in that order, the following result is obtained by applying Gronwall's lemma:

$$|y_i| \leq |\tilde{y}_i(t)| + \int_{\xi}^t |\tilde{y}_i(s) P_1 f| \exp\left(\int_s^t |P_1| |f| d\tau\right) ds \quad (4.5.4)$$

$i = 1, 2, 3$, where P_1 is given by (4.5.3).

Some simplification can be achieved as follows. Let an operator $e_{\xi}^t(x)$ be defined such that:

$$e_{\xi}^t(x) = \exp\left(\epsilon \int_{\xi}^t x d\lambda\right) \quad (a)$$

Hence

$$e_{\xi}^t(-x) = e_{\xi}^t(x) \quad (b) \quad (4.5.5)$$

and:

$$e_{\xi}^t(x) e_{\xi}^{\xi}(x) = e_{\xi}^t(x) \quad (c)$$

Contrails

The approximation

$$y(t) = D(t) \exp\left(\epsilon \int_{\xi}^t x \, d\lambda\right) = D(t) e_{\xi}^t(x) \quad (a)$$

(4.5.6)

and

$$y'(t) = \left(\frac{D'}{D} + \epsilon x\right)y \quad (b)$$

Let us write $h(t, s)$ in the form:

$$\begin{aligned} h(t, s) = & \tilde{y}_2(t) (\tilde{y}_1 \tilde{y}_3'(s) - \tilde{y}_3 \tilde{y}_1'(s)) + \tilde{y}_3(t) (\tilde{y}_2 \tilde{y}_1'(s) - \tilde{y}_1 \tilde{y}_2'(s)) \\ & + \tilde{y}_1(t) (\tilde{y}_2 \tilde{y}_3'(s) - \tilde{y}_3 \tilde{y}_2'(s)) \end{aligned} \quad (4.5.7)$$

We use the above and recall that $D(t)$ is understood to be the magnitude of $(3x^2 + \omega_1)^{-\frac{1}{2}}$ and under certain conditions (derived in Appendix II), is invariant w. r. t. the roots. In particular if

$$\frac{\omega_1^3(t)}{\omega_0^2(t)} = \text{constant}$$

then

$$D(t) = \omega_1^{-\frac{1}{2}}(t) \quad (a)$$

and:

$$\tilde{y}_i(t) = D(t) e_{\xi}^t(x_i) = \omega_1^{-\frac{1}{2}}(t) e_{\xi}^t(x_i) \quad (b)$$

(4.5.8)

Using (4.4.5), (4.5.7) can now be written as:

$$\begin{aligned} h(t, s) = & \epsilon D(t) e_{\xi}^t(x_2) (x_3(s) - x_1(s)) D^2(s) e_{\xi}^s(x_1 + x_3) \\ & + \epsilon D(t) e_{\xi}^t(x_3) (x_1(s) - x_2(s)) D^2(s) e_{\xi}^s(x_1 + x_2) \\ & + \epsilon D(t) e_{\xi}^t(x_1) (x_3(s) - x_2(s)) D^2(s) e_{\xi}^s(x_2 + x_3) \end{aligned}$$

Noting that $x_1(t) + x_2(t) + x_3(t) = 0$ and (4.5.5; b, c) leads to the simplification:

$$h(t, s) = e^{-D(t)} \left[D_2(s) e^{\int_s^t (x_1)} (x_3(s) - x_2(s)) + e^{\int_s^t (x_2)} (x_3(s) - x_1(s)) + e^{\int_s^t (x_3)} (x_1(s) - x_2(s)) \right] \quad (4.5.9)$$

Now $y(t) = \tilde{y}(t) + \int_{\xi}^t h(t, s) f y ds$. If $e^{\int_{\xi}^t (x_i)}$, $i = 1, 2, 3$ and $D(t)$ are bounded respectively by, say, L_2, M_3 , and R , and defining

$$P_2(s) = e^{-R} \left\{ \left| \omega_1^{-1}(s) L_3 e^{\int_{\xi}^s (-x_1)} (x_3(s) - x_2(s)) \right| + \left| M_3 \omega_1^{-1}(s) e^{\int_{\xi}^s (-x_2)} (x_3 - x_1) \right| + \left| M_3 \omega_1^{-1}(s) e^{\int_{\xi}^s (-x_3)} (x_1 - x_2) \right| \right\} \quad (a)$$

(4.5.10)

we get the relation:

$$|y(t)| \leq |\tilde{y}(t)| + \int_{\xi}^t |P_2| |f| |y| ds \quad (b)$$

Gronwall's lemma leads to (4.5.4) with P_1 replaced by P_2 .

The following theorem can therefore be stated.

Theorem 6. With the following modifications theorem 3 will hold.

$$|y_i| = |\tilde{y}_i(t)| + E_i \quad i=1, 2, 3 \quad (4.5.11)$$

where

$$|E_i| \leq \left| \int_{\xi}^t |\tilde{y}_i(s) P_2 f| e^{\int_s^t (P_2 f)} ds \right| \quad (4.5.12)$$

$$P_2 = M_2 \left\{ \left| \tilde{y}_1 \tilde{y}_3' - \tilde{y}_3 \tilde{y}_1' \right| + \left| \tilde{y}_2 \tilde{y}_1' - \tilde{y}_1 \tilde{y}_2' \right| + \frac{L_2}{M_2} \left| \tilde{y}_2 \tilde{y}_3' - \tilde{y}_3 \tilde{y}_2' \right| \right\} \quad (4.5.13)$$

provided that roots are distinct, a pair being complex conjugates. With the above modifications, the relations (4.4.11) to (4.4.19) hold.

ξ is any point in the interior of (a, b) . L_2, M_2 are the upper bounds of \tilde{y}_1 and \tilde{y}_2, \tilde{y}_3 respectively.

(a) The characteristic roots are complex and distinct if the discriminant

$$q^3 + r^2 > 0; \quad q = \frac{\omega_1}{3}, \quad r = -\frac{\omega_0}{2} \quad (4.4.22 \text{ b})$$

If $q^3 + r^2 = 0$ then the roots are all real and at least two of them are equal.

(b) Uniform bounds are obtained by having a, b as the limits of integration in (4.5.12).

(c) Simplified bounds can again be determined similar to the case of theorem 3; i.e. similar to (4.4.23).

When

$$\frac{\omega_1^3}{\omega_0^2} = \text{constant}$$

in (4.5.12) P_1 can be replaced by P_2 , which is given by (4.5.10 a).

4.6 Summary of Chapter and Conclusions

Error bounds for the second order equation are derived, first for the noncanonical form and this is done using Olver's fundamental approximation theorems. This reveals a difference in errors in comparison with the standard LG error bounds. Next, Olver's approximation theorems for the self-adjoint equation are rederived, though more restrictively, in a direct way that is believed to be new. Further, bounds for the noncanonical equation are also derived using this method and are shown to be equivalent to the earlier result using Olver's theorems. Simplified bounds are obtained and the conditions for these are stated.

The third order l. d. e. is studied next and two approximation theorems are proved, using the familiar notions of variable characteristic roots. For one class of equations for which

$$\frac{\omega_1^3}{\omega_0^2} = \text{constant}$$

the error bounds have a simple form. Simplified bounds of the type obtained by Blumenthal for second order equations are also derived under appropriate conditions.

Though the approximations obtained in Chapter III require that $\omega_i(t)$ be independent of ϵ , in the error analysis this limitation may be overlooked and the more general $\omega_i(\epsilon, t)$ can be considered. The assumed condition that $f(\epsilon, t)$ is a continuous function of t is not essential. The same proof applies if, for example, $f(\epsilon, t)$ has a finite number of discontinuities in (a, b) . But then higher derivatives of $y(t)$ may be discontinuous at the points of discontinuities of $f(\epsilon, t)$.

The conditions under which y is of constant sign for theorem 3 must, however, be determined from other considerations such as stability theory and oscillation criteria (Ref. 61, 46, 23). The bounds for the oscillatory case are not as simple in form as for the second order equation. Besides, it may not always be possible to evaluate the bounds in a closed form; but the theorems are still useful, as they essentially reduce the problem of estimating the error in an approximate solution of a differential equation to the much easier problem of evaluating a definite integral.

It is felt that a similar approach may lead to useful results in the case of third order noncanonical form, as well as for higher order equations.

CHAPTER V

EXAMPLES AND APPLICATION

The scheme of approximation developed in Chapter III will now be applied to examples. The arrangement is as follows. The first part of this chapter consists of examples with analytically known behaviors; the examples are so chosen as to highlight the application of the method and to afford an analytical treatment. Notice that even though the coefficients do not always completely conform to the ordering assumed in our approximation, considerable information is obtained. We also consider a special equation of n^{th} order. The equations are studied in the noncanonical form directly without the necessity of transforming them into the canonical form which would be amenable to the L G treatment.

The latter half of this chapter is devoted to an actual physical problem, viz. the analysis of the dynamics of VTOL aircraft through the transition from hover to forward flight. The problem of aircraft dynamics in unsteady flight has been treated in detail by Curtiss (Ref. 27) in a recent work. Therefore, at present we will not go into the many aspects of VTOL dynamics, but will emphasize the use of time scales to provide a uniform description of the transition dynamics.

5.1 Examples with Known Solutions

1. The asymptotic behavior of the zeroth order Bessel function can be recovered directly from the governing equation:

$$y'' + \frac{1}{t}y' + y = 0 \quad (5.1.1)$$

The characteristic roots are:

$$x = -\frac{1}{2t} \pm i \left(1 - \frac{1}{4t^2}\right)^{\frac{1}{2}}$$

From (3.4.21 c) the approximation is written as

$$\tilde{y}(t) = \left(1 - \frac{1}{4t^2}\right)^{-1/4} \exp\left(-\frac{1}{2} \ln t \pm i \int \left(1 - \frac{1}{4t^2}\right)^{\frac{1}{2}} dt\right)$$

i.e.
$$\tilde{y}(t) \sim t^{-\frac{1}{2}} \exp(\pm it) \quad (5.1.2)$$

which is the correct asymptotic behavior as $t \rightarrow \infty$ (Ref. 50). The first and third coefficients are the same, while the second coefficient steadily decreases as $t \rightarrow \infty$.

Consider the transformation $t = \epsilon s$. Now if $s = O(1)$, as $t \rightarrow \infty$, $\epsilon \rightarrow \infty$. Equation (5.1.1) is transformed into

$$s y'' + y' + \epsilon^2 s y = 0$$

with $\epsilon \gg 1$. The time scales formula describes the correct behavior of the solutions.

2. We may now consider the confluent hypergeometric (or Kummer's) equation, which has a number of engineering applications (Ref. 64). The equation is given by

$$t y'' + (b-t)y' - ay = 0$$

where a, b are constants. The characteristic equation is:

$$x^2 + \left(\frac{b}{t} - 1\right)x - \frac{a}{t} = 0$$

For $t \rightarrow \infty$, the characteristic roots are asymptotically given by:

$$x_1 \sim 1 + \frac{a-b}{t}$$

$$x_2 \sim -\frac{a}{t}$$

From (4.3.21) the approximations are given by:

$$\tilde{y}_1 = \alpha_1(\tau_0) \exp\left(\int x_1 dt\right) \sim c_1 e^t t^{(a-b)}$$

$$\tilde{y}_2 = \alpha_2(\tau_0) \exp\left(\int x_2 dt\right) \sim c_2 t^{-a}$$

These describe the correct asymptotic behavior of the solutions as $t \rightarrow \infty$, as can be verified from Ref. 50, 63. It is seen from the characteristic equation that the second coefficient approaches a constant, while the third approaches zero as $t \rightarrow \infty$. Notwithstanding this, the correct behavior is obtained from the approximation.

Kummer's equation can be transformed into the canonical form and is known as Whittaker's normal form (Ref. 63). This allows the application of the L G approximation.

3. We will now consider a simple third order equation containing a large parameter ϵ , viz.:

$$y''' + \frac{\epsilon^3}{t^3} y = 0 \tag{5.1.3}$$

This is of a type which is fully amenable to our approximation. The characteristic roots are:

$$x = -\frac{1}{t} ; \quad \left(\frac{1}{2} \pm i \frac{\sqrt{3}}{2} \right) \frac{1}{t}$$

From (3.4.21 c):

$$\tilde{y}_i(t) = \frac{c_i}{x_i} \exp \left(\epsilon \int x_i dt \right)$$

i. e.:

$$\tilde{y}(t) = t \left(c_1 t^{-\epsilon} + c_2 t^{\epsilon \left(\frac{1+i\sqrt{3}}{2} \right)} + c_3 t^{\epsilon \left(\frac{1-i\sqrt{3}}{2} \right)} \right) \tag{5.1.4}$$

The exact solution of (5.1.3) can be obtained in the form $y(t) = t^m$. It can be easily verified that (5.1.4) gives the correct asymptotic behavior for large ϵ .

The special n^{th} order equation of this type can be studied similarly and it is discussed at the end of this section.

4. "Double Airy" equation

This is a third order equation which is satisfied by products of Airy functions and is given by:

$$y''' - 4ty' - 2y = 0 \quad (5.1.5)$$

The characteristic equation is:

$$x^3 - 4tx - 2 = 0$$

In order to determine the asymptotic behavior of the roots as $t \rightarrow \infty$, the equation is written as

$$\delta x^3 - 4tx - 2\delta = 0$$

and is studied in the limit $\delta \rightarrow 0$.

In this case the principle of maximal balance says that the term x^3 must be balanced against $-4tx$ for large t (Fig. 12 ii); i. e. :

$$x^3 - 4tx = 0 \quad \text{or} \quad x(x^2 - 4t) = 0$$

The three roots are:

$$x_{1,2} = \pm 2t^{\frac{1}{2}}$$

$$x_3 = 0$$

This can also be seen starting with the equation:

$$x^3 - 4tx - 2 = 0$$

For real coefficients the sum of the roots = 0. Hence if one pair of roots goes as $\pm 2\sqrt{t}$, the third root must remain at the origin, as shown in the sketch below.

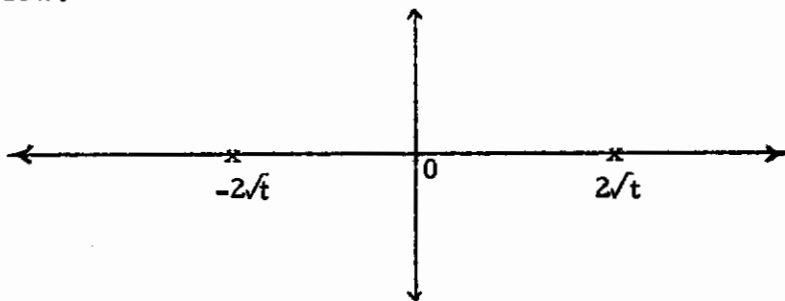

Hence the approximations are

$$\tilde{y}_i = (3x_i^2 - 4t)^{-\frac{1}{2}} \exp\left(\int x_i dt\right)$$

i. e.:

$$\tilde{y}_{1,2} \sim t^{-\frac{1}{2}} \exp\left(\pm \frac{4}{3} t^{3/2}\right); \quad \tilde{y}_3 \sim t^{-\frac{1}{2}} \quad (5.1.6)$$

Now (5.1.5) has the exact solutions $Ai^2(t)$, $Bi^2(t)$ and $Ai(t)Bi(t)$ where $Ai(t)$ and $Bi(t)$ are Airy functions (Ref. 50). The coefficients of (5.1.5) do not fully conform to the conditions of the approximation; the second coefficient increases as $t \rightarrow \infty$, but the third remains finite. Nevertheless, (5.1.6) describes the correct asymptotic behavior of the solutions as $t \rightarrow \infty$.

5. Consider the equation

$$ty''' + 3y'' + ty = 0 \tag{5.1.7}$$

The characteristic equation is given by

$$x^3 + \frac{3}{t}x^2 + 1 = 0 \tag{5.1.8}$$

The roots of this equation as $t \rightarrow \infty$ can be studied using the exact formula for the cubic (Ref. 50, p. 17). However, let us write (5.1.2) in the form

$$x^3 + \delta \frac{3}{t} x^2 + 1 = 0 \tag{5.1.9}$$

and study the roots as $\delta \rightarrow 0$. Using the principle of maximal balance (Fig. 12 i) we find that the equation

$$x_0^3 + 1 = 0 \tag{5.1.10}$$

determines the leading behavior of the roots as $t \rightarrow \infty$. Hence we can treat (5.1.9) as a perturbation problem and determine the correction by going to the next order. Thus:

$$x = x_0 + \delta x_1 + \dots \tag{5.1.11}$$

$$3x_0^2 x_1 + \frac{3x_0^2}{t} = 0 \tag{5.1.12}$$

giving:

$$x_1 = -\frac{1}{t} \tag{5.1.13}$$

This correction to the roots can be verified from the exact formula also. The time scales approximation is therefore written as

Contrails

$$\tilde{y}_i(t) = c_i \left(x_i^2 + \frac{2x_i}{t} \right)^{-\frac{1}{2}} \exp \left(\int x_i dt \right) \quad (5.1.14)$$

where c_i are adjustable constants. On substituting from (5.1.11) the solutions are found to be

$$\tilde{y}_i(t) = \frac{D_i}{t} \exp \left(\int x_{oi} dt \right) \quad (5.1.15)$$

where x_{oi} are roots of the equation (5.1.10); i. e. the solutions are:

$$\tilde{y}(t) = \frac{D_1}{t} \exp(-t) + \frac{D_2}{t} \exp\left(\frac{1+i\sqrt{3}}{2}t\right) + \frac{D_3}{t} \exp\left(\frac{1-i\sqrt{3}}{2}t\right) \quad (5.1.16)$$

The transformation $u = ty$ leads to the constant coefficient equation

$$u''' + u = 0$$

which can be solved exactly. The expression (5.1.16) given by the time scales theory is the exact solution for this example.

6. Special equation of order n .

The equation chosen, again, conforms to the conditions of the approximation. Consider the equation

$$\frac{d^n y}{dt^n} + \left(\frac{\epsilon}{t}\right)^n y = 0 \quad (5.1.17)$$

in the limit of $\epsilon \rightarrow \infty$. The characteristic equation is:

$$F_n \equiv x^n + \frac{1}{t^n} = 0 \quad (5.1.18)$$

$$\text{The roots are given by: } x = \exp\left(\frac{\pi i}{n}\right) \left(\frac{1}{t}\right) \quad (5.1.19)$$

The time scales approximation is:

$$\begin{aligned} \tilde{y}_i(t) &= c_i (x^{n-1})^{-\frac{1}{2}} \exp(\epsilon \int x_i dt) \\ &= \exp\left(-\frac{\pi i}{n} \frac{(n-1)}{2} \right) \left(\frac{1}{t}\right)^{-\frac{n-1}{2}} \exp\left(\epsilon \int e^{\frac{\pi i}{n}} \left(\frac{1}{t}\right) dt\right) \end{aligned}$$

Simplifying:

$$\tilde{y}_i(t) = c_i t^{\frac{n-1}{2}} t (\epsilon e^{\pi i/n}) \tag{5.1.20}$$

The exact solution can be determined as follows. We look for a solution $y = t^m$. On substitution, m is found to satisfy the equation

$$m(m-1)(m-2) \dots (m-n+1) + \epsilon^n = 0 \tag{5.1.21}$$

which can be written in the root locus form:

$$1 + G(m) = 0 \quad \text{where} \quad G(m) = \frac{\epsilon^n}{m(m-1) \dots (m-n+1)} \tag{5.1.22}$$

The locus of the roots of (5.1.21) on the complex m plane is plotted in Fig. 13. For large ϵ the roots asymptotically approach the lines which are at angles $180^\circ/n$; i.e. $m \sim \epsilon^{\pi i/n}$. Thus the exact solution has the asymptotic behavior for $\epsilon \rightarrow \infty$ as predicted by the approximation (5.1.20)

We will now go on to the study of the transition of VTOL aircraft from hover to forward flight.

Transition Dynamics of VTOL Aircraft

5.2. Preliminary Remarks

The problem considered in this section is the longitudinal dynamics of a VTOL aircraft through its transition from hover to forward flight. The method of multiple time scales and the formulae derived in Chapter III are employed to obtain approximations to the solutions of the equations of motion of a typical VTOL aircraft. The point of view adopted is to linearize the nonlinear equations of motion, and treat the coefficients as variable during the transition. This is, for example, the approach used by Curtiss (Ref. 27).

The assumptions and rationale of the physical problem are based on Ref. 27 and 47. The main contribution of the present effort is intended to be a difference in approach and a more uniform description of the phenomenon.

An independent effort in the application of multiple time scales aircraft dynamics was reported by Ashley in a very recent paper (Ref. 52). This deals with the linearized aircraft equations of motion with constant coefficients. Approximations were obtained with simple time scales using linear clocks, the objective being "a heightened rationality" in the study of the subject.

The present approach differs from that of Ashley in the following respects:

- (i) in regard to constant coefficient equations; using linear clocks exact solutions are obtained instead of approximations (Ref. Chapter II)
- (ii) since linear clocks are inadequate for a large class of problems, nonlinear clocks are introduced, particularly in the case of l. d. e. with variable coefficients. The nature of the clock functions is determined from the equations themselves and depends on the domain of interest.

It is felt that this dissertation demonstrates the usefulness and flexibility of a general nonlinear clock function.

5.3. The System

The development of the aircraft equations of motion as related to VTOL dynamics will be briefly traced, for the sake of completeness. The motion of the aircraft is considered with reference to a system of body axes fixed in the vehicle. Fig. 14 describes the axis system for a tilt-wing VTOL vehicle.

The equations of motion are obtained by considering the equilibrium of forces and moments in the various degrees of freedom. The earth is assumed to be an inertial frame and the atmosphere is assumed to be fixed w.r.t. the earth. The aircraft is assumed to have a constant mass. Only rectilinear motion at relatively low speed in the vehicle's plane of symmetry is considered and the effects of unsteady flow and elastic deformation are assumed to be negligible. Under these assumptions the longitudinal equations of motion can be written in conventional notation (Ref. 47) as:

$$\begin{aligned}u + wq + g \sin \theta &= X(u, w, q, \delta_T, \delta_E, i_w) \\w' - uq - g \cos \theta &= Z(u, w, q, \delta_T, \delta_E, i_w) \\ \dot{q} &= M(u, w, q, \delta_T, \delta_E, i_w) \\ \dot{\theta} &= q\end{aligned} \tag{5.3.1}$$

These equations are nonlinear and nonautonomous in general. The primary interest here will be on the dynamics of VTOL aircraft during transition from hover to forward flight. In a tilt-wing vehicle, δ_T , δ_E , and i_w represent the control parameters, denoting respectively propeller blade pitch, pitching moment control and wing tilt angle. Instead of dealing with the complete nonlinear nonautonomous equations, they are simplified in order to allow an analytical treatment and enable qualitative conclusions to be drawn. The equations of motion are linearized in the usual way by making the following assumptions. The motion is considered about a steady level flight and the vehicle is fully trimmed, i. e. in a state of equilibrium, with all forces and moments balanced out. If the vehicle now encounters a

Contrails

disturbance such that the resultant motion is small in magnitude, the motion is described by a set of l. d. e. with constant coefficients. This is done by expanding the aerodynamic forces and moments in a Taylor's series about the prescribed flight conditions and retaining only the first order terms. This is consistent with the assumption that the disturbed motion is small in magnitude.

Thus:

$$X + \Delta X = X + \frac{\partial X}{\partial u} \Delta u + \frac{\partial X}{\partial w} \Delta w + \frac{\partial X}{\partial T} \delta_T + \frac{\partial X}{\partial i_w} \Delta i_w$$

$$Z + \Delta Z = Z + \frac{\partial Z}{\partial u} \Delta u + \frac{\partial Z}{\partial w} \Delta w + \frac{\partial Z}{\partial \delta_T} \delta_T + \frac{\partial Z}{\partial i_w} \Delta i_w \quad (5.3.2)$$

$$M + \Delta M = M + \frac{\partial M}{\partial u} \Delta u + \frac{\partial M}{\partial w} \Delta w + \frac{\partial M}{\partial \dot{\theta}} \Delta \dot{\theta} + \frac{\partial M}{\partial \delta_T} \Delta \delta_T + \frac{\partial M}{\partial \delta_E} \Delta \delta_E + \frac{\partial M}{\partial i_w} \Delta i_w$$

For steady level flight the flight path angle is nearly horizontal and this permits further simplification. The lowest order terms are balanced out, leaving the equations satisfied by the perturbed variables. Let these be denoted by u , w , and θ . The linearized homogeneous equations are therefore given by:

$$u' - X_u u - X_w w + g \theta = 0$$

$$w' - Z_w w - Z_u u - V \dot{\theta} = 0 \quad (5.3.3)$$

$$\theta'' - M_{\dot{\theta}} \dot{\theta} - M_u u - M_w \dot{w} + M_w w = 0$$

For a conventional airplane at cruising flight the stability derivatives are constants. The perturbed transient motion can be determined by solving the coupled linear equations with constant coefficients. For a VTOL vehicle executing a transition, the flight condition varies from instant to instant; hence the aerodynamic parameters of the vehicle, since they depend on the flight condition, also vary through the transition. The

Contrails

vehicle is still assumed to be continuously trimmed throughout. Control required to trim is not considered in this analysis and we shall only consider transitions at level flight. The coefficients of the linearized equations are therefore treated as variable if the time history of the trim conditions can be predicted. Further, this change in the coefficients is assumed to arise primarily from the change in flight velocity, although in general they depend on the wing-tilt angle i_w and power setting δ_T .

Qualitatively the following observations can be made. At forward flight a VTOL vehicle behaves essentially like an airplane and at hover like a helicopter in regard to dynamic motion. The forces and moments produced by the propellers and the wing-slipstream interaction largely influence the low speed characteristics of a VTOL vehicle. Near cruising speeds these effects become less important. The stability derivatives have constant values corresponding to hover and forward flight, but change continuously from one to the other as the vehicle accelerates until it attains cruising velocity. At hover the characteristic roots consist of a complex conjugate pair with positive real part, and a pair of negative real roots. The motion therefore exhibits oscillatory instability. In cruising flight the motion is characterized by two pairs of complex conjugate roots, usually with negative real parts. One of the modes is of high frequency (the short period motion), and the other is of low frequency (the phugoid motion). The transition is, therefore, from a helicopter-like vehicle to an airplane-like one, with accompanying difficulties in the analysis and control of the vehicle. For example, at hover the vehicle needs forward stick for forward velocity (stable trim gradient); but for cruising flight the trim curve is as shown in Fig. 15, necessitating an adverse control position gradient at some time during the transition making it somewhat difficult to fly.

We shall now consider a specific example, a tilt-wing vehicle. Ref. 49 contains a comparative study of the longitudinal stability derivatives of three tilt-wing VTOL aircraft. The vehicles considered are:

- (1) The VZ 2 Research Aircraft
- (2) Two Propeller Transport
- (3) Four Propeller Transport

Based on experimental data and taking into account the scatter of data, typical stability derivative variations through the transition are proposed. Variation of the stability derivatives with velocity for a vehicle of this type used in the present analysis were based on Ref. 49. Now the equations of motion can be written as

$$\begin{aligned}u' + a_1 u + a_2 w + g\theta &= 0 \\w' + b_1 w + b_2 u - V\dot{\theta} &= 0 \\ \theta'' + c_1 \theta' + c_2 u + c_3 \dot{w} + c_4 w &= 0\end{aligned}\tag{5.3.4}$$

where the coefficients correspond to those in (5.3.3). The functional dependence of the coefficients on velocity is given in Table III. Different values for the coefficients of the equations of motion are possible due to a different choice of the stability derivative variation. The values used in this analysis are not meant to be representative of an optimal flight vehicle, but are, rather, typical values based on existing aircraft.

The wing-tilt angle i_w is in control of the pilot so that any variation of $i_w(t)$ through the transition can be programmed. The dependence of trim velocity V on wing angle is assumed to be linear and hence $V(t)$ (Fig. 17) can be chosen conveniently. The stability derivatives are now expressed as functions of t and this leads to a set of time-variable coupled linear differential equations. In the analysis that follows the stability derivatives X_w and M_w , being respectively denoted by $-a_2$ and $-c_3$, are neglected since the contribution of these terms to the dynamics of the vehicle is considered to be small.

5.4 Two Degree of Freedom Case

Near hover, the two degree-of-freedom approximation is employed, in which the vertical or plunging motion is suppressed. At hover (in which state the vehicle can remain indefinitely), the damped vertical or plunging mode is completely decoupled and has little effect on the other two modes.

The system (5.3.4) can be represented by the following set of

Contrails

equations at hover and low velocities, since the terms a_2 , b_2 , c_4 are very small. (Ref. 27):

$$u' + a_1 u + g\theta = 0 \quad (a)$$

$$w' + b_1 w = 0 \quad (b) \quad (5.4.1)$$

$$\theta'' + c_1 \theta' + c_2 u = 0 \quad (c)$$

The w mode is completely decoupled leaving the u and θ equations still coupled. On decoupling these by cross-differentiation we arrive at the following equations for u and θ .

$$u''' + (a_1 + c_1)u'' + (a_1 c_1 + 2a_1')u' + (a_1'' + a_1' c_1 - gc_2)u = 0 \quad (5.4.2)$$

$$\theta''' + (a_1 + c_1 - \frac{c_2'}{c_2})\theta'' + (a_1 c_1 + c_1' - c_1 \frac{c_2'}{c_2})\theta' - gc_2 \theta = 0 \quad (5.4.3)$$

On substituting the quantities from Table III the equations become

$$(1 + 0.1t)u''' + (0.3 + 0.081t)u'' + (0.02 + 0.0122t)u' + 0.48u = 0 \quad (5.4.4)$$

$$(10 + t)^2 \theta''' + (4 + 0.81t)(10 + t)\theta'' + (8.1 + 1.83t + 0.122t^2)\theta' + 4.8(10 + t)\theta = 0 \quad (5.4.5)$$

$$w' + \left(\frac{0.1 + 0.07t}{1 + 0.1t} \right) w = 0 \quad (5.4.6)$$

Equation (5.4.6) can be readily solved to give

$$w(t) = c \exp \left(- \int \left(\frac{0.1 + 0.07t}{1 + 0.1t} \right) dt \right) \quad (5.4.7)$$

The equations for u and θ , viz. (5.4.4) and (5.4.5) are solved approximately using the formula (3.4.21 c). In order to have a comparison with the exact

Contrails

solution, the equations were integrated using the digital computer for the conditions given below.

Initial Condition	$u(0)$ $\theta(0)$	$u'(0)$ $\theta'(0)$	$u''(0)$ $\theta''(0)$
1	0	0	1
2	0	1	0
3	1	0	0

The linear combination of the linearly independent approximate solutions was plotted in each case corresponding to the above conditions. The locus of the roots and the approximations were plotted in each case, together with the exact solution,

This enables one to retain to some extent the familiar ideas of the analysis of constant coefficient l.d.e. It is noticed that the root loci corresponding to the variables u and θ are different. This is because, as a result of decoupling, the coefficients of the equations for u and θ contain additional terms involving the time derivatives of the stability derivatives. A constant coefficient analysis of these decoupled equations obtains the "frozen" approximations to the solutions of the variable equations. Further, in the light of multiple time scales, the fast time scale shows up as a quadrature over the root variation and describes the frequency of the rapidly varying motion. The results are shown in Fig. 18-27.

The frozen amplitude approximation $\tilde{u}(\tau_1)|_t$, which varies on the fast time scale, seems to represent the frequency of the exact solution quite well, but the amplitude suffers from errors. The present approximation seems to represent the true function well in both amplitude and frequency. The agreement is seen even with the other set of initial conditions. From the above figures it is seen that the approximation is insensitive to initial conditions.

5.5 The Three Degree-of-Freedom Case

The complete linearized equations of motion coupling three variables u , w and θ are given by (5.3.4). Again treating a_2 and c_3 as being unimportant, the equations are written as:

$$\begin{aligned} u' + a_1 u + g\theta &= 0 \\ w' + b_1 w + b_2 u + V\theta' &= 0 \\ \theta'' + c_1 \theta' + c_2 u + c_4 w &= 0 \end{aligned} \tag{5.5.1}$$

In order that the time scales approximation be applied, equations describing each dependent variable must be obtained. Unlike the constant coefficient case, the equations will not all be the same, as emphasized by Curtiss, so that the time histories of u , w and θ will be different. But decoupling the equations is itself an involved task; a schematic of the procedure can be seen in Fig. 16. The equation for u is given by

$$\begin{aligned} u'''' + (a_1 + b_1 + c_1 - \frac{c_4'}{c_4})u'''' & \\ + (a_1 b_1 + b_1 c_1 + c_1 a_1 + Vc_4 + c_1' + 3a_1' - \frac{c_4'}{c_4} (a_1 + c_1))u'' & \\ + (a_1 b_1 c_1 + Vc_4 a_1 - gc_2 - \frac{c_4'}{c_4} a_1 c_1 + a_1 c_1' + 2a_1' (b_1 + c_1 - \frac{c_4'}{c_4}) + 3a_1'')u' & \\ + (g(b_2 c_4 - b_1 c_2 + \frac{c_4'}{c_4} c_2 - c_2') + a_1' (b_1 c_1 + Vc_4 + c_1' - \frac{c_4'}{c_4} c_1)) & \\ + a_1'' (b_1 + c_1 - \frac{c_4'}{c_4}) u = 0 & \end{aligned} \tag{5.5.2}$$

When $c_4 = 0$ it is seen that this reduced to (5.2.2)(with $a_1 = \text{constant}$;) and when all the coefficients are constant the equation becomes

Contrails

$$u'''' + (a_1 + b_1 + c_1) u'''' + (a_1 b_1 + b_1 c_1 + c_1 a_1 + Vc_4) u'' + (a_1 b_1 c_1 + Vc_4 a_1 - gc_2) u' + g(b_2 c_4 - b_1 c_2) u = 0 \quad (5.5.3)$$

as can be verified directly from (5.5.1).

Now substitution of the assumed stability derivative variation from Table III leads, after a considerable amount of algebra, to the following equation for u .

$$p_4 u^{(4)} + p_3 u^{(3)} + p_2 u^{(2)} + p_1 u' + p_0 u = 0 \quad (a)$$

where

$$p_4 = (10 + 16t)(10 + t)^3 (-0.2 + 0.0175t) \quad (b)$$

$$p_3 = (2 - 1.35t - 0.232t^2 + 0.02643t^3)(10 + 16t)(10 + t)^2 \quad (c)$$

$$p_2 = (60 + 13.7t - 10.4875t^2 + 4.19t^3 - 0.9988t^4 + 0.058t^5)(10 + 16t) \quad (d)$$

$$p_1 = (4 - 100.78t - 12.523t^2 + 1.6994t^3 - 0.123t^4 + 0.0107t^5)(10 + 16t) \quad (e)$$

$$p_0 = 3.22(10 + t)(30.3 + 23.07t - 15.7t^2 - 1.4573t^3 + 0.0034t^4 + 0.0095t^5) \quad (f)$$

This equation has regular singular points at $t=0$ and $t \approx 11.42$. Near $t=0$, therefore, the fourth order equation is approximated by the third order system which has only two degrees of freedom, as is usual in engineering analysis.

The other singular point occurs in a region in which two of the characteristic roots coalesce and hence the approximation via time scales fails in such a region. We may recall that this corresponds to a transition point, in the vicinity of which the short period mode changes from monotonic solutions to oscillatory ones. Some problems associated with this are discussed in the next chapter.

Contrails

We now examine the solution to the fourth order equation characterized by various initial conditions. Figures are drawn to show the comparison of the time scales approximations with the exact solution obtained by numerical integration. Different variations of the stability derivative M_w with flight velocity were studied in relation to vehicle dynamics. Figures 18-37 show the difference in the root loci and the corresponding responses. It is seen that the nature of the aircraft motion is qualitatively the same, though the root loci are quite different. A slight resonance seems to occur near the transition point on the real axis. The agreement of the approximation with the exact solution is seen to be good in each case, near both hover and forward flight, and thus provides a uniform description of the motion of the aircraft. The approximation suffers from errors in the vicinity of the transition point as may be expected, but the qualitative nature of the solution is preserved. In general the ability of the approximation to progress through the transition point depends upon the choice of the initial conditions; use of the digital computer on the other hand, for the approximation, is likely to preclude any difficulty with the transition point.

Also appended are the figures depicting the approximations obtained by "freezing" the coefficients. A comparison of these with exact solutions is made for the third and fourth order systems (Fig. 20, 21, 36, 37). It is seen that the "frozen" scheme of approximation is good only for short times, and the error becomes large in less than a cycle of the oscillation. The approximating function grows without bound and does not represent the true nature of the solution anywhere after the first cycle.

5.6 Summary of the Chapter

Examples with analytically known solutions are discussed first. They consist of several second and third order equations and a special n^{th} order equation. Correct asymptotic behavior of the solutions is obtained using the theory developed in this thesis.

Transition dynamics of VTOL aircraft are studied in the longitudinal mode. The two degree-of-freedom (hover) approximation and the three degree-of-freedom case are studied. The time scales approximations are compared

Contrails

with numerically obtained solutions for various initial conditions. Errors are found to be less than 10% for the hover approximation. For the three degree-of-freedom case, a uniform qualitative description of the vehicle motion is obtained, with good accuracy except at the transition point.

Different variations of $M_w(V)$ were studied.

CHAPTER VI

CRITIQUE AND EXTENSION

6.1 Extension of the Method

We shall first outline the advantages of the method over earlier methods and then discuss possible extensions regarding open problems.

At the outset one may consider the novel point of view adopted in the approximation. The method of extension as related to multiple time scales has been used to obtain the approximations, both for short and long times. This is done systematically, generating suitable clocks on which the phenomenon is observed for both short and long times. Criteria of validity are presented for each case. For the short time approximation this shows the breakdown of the approximation and for the long time analysis, upper bounds for the error are obtained. The formula (3.4.21) for the general case enables one to write the approximation for a given equation by inspection, and for each mode separately. Furthermore this affords a uniform description of the phenomenon, in a region free of transition points. Also since the result is obtained analytically, it is useful for further study and investigation of related problems. In this connection, one may mention the problem of obtaining approximations to the solutions of a system of coupled equations without recourse to decoupling first. Simple "extensions" of coupled equations seem to recover the "frequency" of the solution but not the slow amplitude modulation. However, different schemes of "extension" may lead to better results, and thus help to simplify the analysis.

Further work, for example, may lead to the study of forced responses of time-variable systems. Consider the equation:

$$\mathcal{L}(y) \equiv y^{(n)} + \omega_{n-1}(t) y^{(n-1)} + \dots + \omega_0(t) = f(t) \quad (6.1.1)$$

The particular solution can be written as

$$y(t) = \int_0^t h(t, s) f(s) ds \quad (6.1.2)$$

Conclusions

where $h(t, s)$ is the Green's function or the time-variable impulse response. $h(t, s)$ is expressed in terms of the independent solutions of the homogeneous equation $\mathcal{L}(y) = 0$. Approximations to $h(t, s)$ can be obtained using the theory developed in this thesis and this can be used to study approximations to forced response. The choice of forcing functions is dictated by "resonant" and "non-resonant" cases; in this connection one may refer to the recent work by Feshchenko et al (Ref. 24) for an asymptotic theory of forced linear systems.

Another aspect of the approximation scheme becomes apparent as follows. In order to apply the formula (3.4.21) one needs to know the roots of the characteristic equations as functions of t . For systems up to fourth order, a closed form of expression is available for the roots, though it is not simple for the third and fourth order equations. For higher order equations in general, no such results exist. One may, however, consider the approximation for the roots developed by the author (Ref. 53) as a Taylor's series starting at the instant $t = 0$. This technique is of necessity limited to the region of validity of the root approximation, which has to be precisely formulated. Nevertheless for smooth variation of the roots the result can be used for small t . With regard to the VTOL example, the characteristic equation is given by:

$$F(x, t) \equiv x^4 + \omega_3(t)x^3 + \omega_2(t)x^2 + \omega_1(t)x + \omega_0(t) = 0 \quad (6.1.3)$$

If $t=0$ represents hover

$$x(t) = x(0) + \dot{x}(0)t + \frac{x}{2!}(0)t^2 + \dots \quad (6.1.4)$$

where:

$$\dot{x}(t) = - \frac{\left(\frac{\partial F}{\partial t}\right)}{\left(\frac{\partial F}{\partial x}\right)}$$

Higher derivatives can be similarly calculated. For example with reference to the VTOL transition problems, two expansions for the root can be made, one near hover and the other near forward flight condition. Substitution in the

formula yields the approximations valid near the two flight conditions respectively.

Parameter sensitivity can be studied in the manner discussed in Ref. 53. The change in a characteristic root caused by changing a particular parameter can be computed as a function of t . This change in the root is reflected as a change in the dynamics of the system.

6.2 Transition Point Analysis

The next question to consider is the breakdown of the approximation (3.4.21) in a region containing multiple characteristic roots. These points are known as turning points or transition points. The problem of obtaining suitable approximations valid near such points has been ab initio difficult to handle. There is an extensive mathematical literature on this subject, which has been studied by, among others, Langer (Ref. 54), Wasow (Ref. 55), Erdelyi (Ref. 44), etc. This section presents a brief sketch of the basic ideas and some preliminary new results. The present objective is mainly to identify and outline the problem areas and emphasize the need for further work leading to a more complete theory.

The simplest equation exhibiting a transition point is the Airy equation:

$$y'' + ty = 0 \tag{6.2.1}$$

For positive and negative values of t the nature of the solutions is quite different, being oscillatory or monotonic (as used by Erdelyi, in the sense of having at most one zero) according as t is positive or negative. Thus $t=0$ is called a transition point, to describe the transition in the nature of the solution on either side of $t=0$. This can also be seen by observing the characteristic roots as t goes through zero. For $t < 0$, the roots are $x = \pm\sqrt{t}$ and for $t > 0$, they are $x = \pm i\sqrt{t}$, and the two roots coalesce for $t = 0$.

For a more general equation

$$y'' + \epsilon^2 \omega(t)y = 0 \tag{6.2.2}$$

the asymptotic approximations for large ϵ (LG solutions) are given by

Contrails

$$c_1 \omega^{-1/4} \cos \left(\epsilon \int \omega^{1/2} dt \right) + c_2 \omega^{-1/4} \sin \left(\epsilon \int \omega^{1/2} dt \right) \quad (6.2.3)$$

for $\omega(t) > 0$, and by

$$c_3 [-\omega(t)]^{-1/4} \exp\left(\epsilon \int [-\omega(t)]^{1/2} dt\right) + c_4 [-\omega(t)]^{-1/4} \exp\left(-\epsilon \int [-\omega(t)]^{1/2} dt\right) \quad (6.2.4)$$

for $\omega(t) < 0$. c_1, c_2, c_3, c_4 are constants.

These approximations are valid when $\omega(t)$ does not vanish. Clearly when $\omega(t) = 0$ neither of these forms is valid and transition occurs from one type of behavior to the other. Two problems are seen to emerge. One to find the connection between the constants c_1, c_2 , and c_3, c_4 to represent asymptotically the same solution of (6.2.2) for both positive and negative values of t ; and the other to determine the asymptotic form of the solution of (6.2.2) near the transition point. It must be noted that a transition point can occur also if the coefficient $\omega(t)$ is singular at a point t_0 , on either side of which $\omega(t)$ has opposite signs. Coalescing of the characteristic roots therefore generally determines the transition point. The approximations each valid on either side of the transition point break down near the point in question and a different form of approximation is required. As Langer points out (Ref. 56) this can be observed even in the case of an l. d. e. with constant coefficients; for the case of multiple characteristic roots a different form of the solution must be used.

Two methods have been used to obtain the connection formulae. The one used by Jeffreys replaces $\omega(t)$ by a linear function $(t-t_0)$ sufficiently near t_0 and integrates the resulting Airy equation in terms of Bessel functions of order $\pm 1/3$, with known asymptotic behaviors. Comparing these with (6.2.3) and (6.2.4) above one obtains the connection formulae. The other method used by Zwaan (Ref. 57) consists in integrating (6.2.2) on a complex plane along the real axis up to the point t_0 on either side, but making an excursion into the complex plane along a semicircle to connect the two sides. This avoids the transition point altogether and obtains the same connection formulae as before. As discussed by Erdelyi (Ref. 40) both methods can be extended to cases where $\omega(t)$ has a zero of an arbitrary order.

The second problem is one of more mathematical interest and it is the determination of the asymptotic forms of the solution near the transition point.

The works of Langer, Olver, Cherry, and Erdelyi, referenced in Ref. 55, are prominent in this respect. No simple elementary function seems adequate in representing the transition from oscillatory to monotonic behavior and higher transcendental functions seem to be needed. The works of the above authors deal with the uniform asymptotic representations in terms of Bessel and Airy functions, etc. These are not limited to the vicinity of the transition points alone but are valid uniformly in the domain of interest.

With reference to the hover, forward-flight transition of a VTOL aircraft, the characteristic equation is seen to have a double root at one instant during such a transition. Equation (5.5.4) shows that this occurs for a value of t near 11.4. This shows that the roots which eventually correspond to the short period mode change from real ones to a pair of complex conjugates for a t in the neighborhood of $t = 11.4$. The solution, therefore, changes from monotonic subsidence to oscillatory subsidence, with the accompanying breakdown of the approximate solution. In order to use an approximation from hover to forward flight, the Stokes phenomenon (see Chapter I) must be investigated. For the aircraft problem, the precise phase of the solution is relatively unimportant. Great precision in the knowledge of the frequency and damping of the motion is seldom required.

The amplitude variation as given by the approximation grows without bound as the transition point is approached. Hence proper connection may be necessary in order to obtain usable solutions, as the amplitude information may be required for feedback control purposes.

6.3 Shifting of the Transition Point

We shall first consider the second order l.d.e. and show that the approximations derived in this thesis can be used to advantage in dealing with the transition point problem.

In approximating the solutions to the noncanonical equation

$$y'' + \epsilon \omega_1 y' + \epsilon^2 \omega_0 y = 0 \quad (6.3.1)$$

there are two methods of approach. One is to transform the noncanonical

equation into the canonical form and then obtain the LG approximation. The other is to treat the noncanonical equation directly. It is seen that under certain conditions, the two approximations fail at different points. Considering the first case, we convert (6.3.1) into the canonical form by means of the transformation

$$y(t) = Z(t) \exp\left(-\frac{\epsilon}{2} \int \omega_1 dt\right) \quad (6.3.2)$$

giving

$$Z'' + \epsilon^2 \left(\omega_0^2 - \frac{\omega_1^2}{4} - \frac{\dot{\omega}_1}{2\epsilon}\right) Z = 0 \quad (6.3.3)$$

i. e.:

$$Z'' - \epsilon^2 \left(\frac{\omega_1^2}{4} - 4\omega_0^2 + \frac{\dot{\omega}_1}{2\epsilon}\right) Z = 0$$

For $\frac{\omega_1^2}{4} - 4\omega_0^2 + \frac{\dot{\omega}_1}{2\epsilon} > 0$, the LG approximation yields:

$$\begin{aligned} \bar{y}(t) = & A_1 (\omega_1^2 - 4\omega_0^2 + \frac{2\dot{\omega}_1}{\epsilon})^{-1/4} \exp\left(-\frac{\epsilon}{2} \int \omega_1 dt + \frac{\epsilon}{2} \int (\omega_1^2 - 4\omega_0^2 + \frac{2\dot{\omega}_1}{\epsilon})^{1/2} dt\right) \\ & + A_2 (\omega_1^2 - 4\omega_0^2 + \frac{2\dot{\omega}_1}{\epsilon})^{-1/4} \exp\left(-\frac{\epsilon}{2} \int \omega_1 dt - \frac{\epsilon}{2} \int (\omega_1^2 - 4\omega_0^2 + \frac{2\dot{\omega}_1}{\epsilon})^{1/2} dt\right) \end{aligned} \quad (6.3.4)$$

On the other hand, applying the time scales formula (3.4.21) to equation (6.3.1) directly, another approximation is obtained as

$$\begin{aligned} \tilde{y}(t) = & B_1 (\omega_1^2 - 4\omega_0^2)^{-1/4} \gamma(t) \exp\left(-\frac{\epsilon}{2} \int \omega_1 dt + \frac{\epsilon}{2} \int (\omega_1^2 - 4\omega_0^2)^{1/2} dt\right) \\ & + B_2 (\omega_1^2 - 4\omega_0^2)^{-1/4} \gamma(t) \exp\left(-\frac{\epsilon}{2} \int \omega_1 dt - \frac{\epsilon}{2} \int (\omega_1^2 - 4\omega_0^2)^{1/2} dt\right) \end{aligned} \quad (a) \quad (6.3.5)$$

$$\text{where } \gamma(t) = \exp\left(\frac{\dot{\omega}_1 dt}{2(\omega_1^2 - 4\omega_0^2)^{1/2}}\right) \quad (b)$$

Now \bar{y} is unbounded when

$$\omega_1^2 - 4\omega_0^2 + \frac{2\dot{\omega}_1}{\epsilon} = 0$$

and \tilde{y} is unbounded when:

$$\omega_1^2 - 4\omega_0 = 0$$

Therefore if $\dot{\omega}_1 \neq 0$ and $(\omega_1^2 - 4\omega_0)$ and $\dot{\omega}_1(t)$ do not vanish simultaneously, we have two approximations, each bounded when the other is not. The transition points for (6.3.1) and (6.3.3) are given by a value of t for which

$$\omega_1^2 - 4\omega_0 = 0$$

and

$$\omega_1^2 - 4\omega_0 + \frac{2\dot{\omega}_1}{\epsilon} = 0$$

respectively. The occurrence of the singularity at the transition point is caused only by the use of the approximation and is not intrinsic to the original differential equation which may have solutions well behaved throughout the domain of interest. Thus we have obtained two approximations which have different transition points. Therefore, in effect, the transition point has been shifted from t_0 to t'_0 where

$$\omega_1^2(t_0) - 4\omega_0(t_0) = 0$$

and:

$$\omega_1^2(t'_0) - 4\omega_0(t'_0) + \frac{2\dot{\omega}_1(t'_0)}{\epsilon} = 0$$

If ϵ is very large the shift is small.

Since the bounds on the error are known in each case, the idea can be used to shift the transition point by a desired amount.

An alternative view is as follows. Consider the canonical second order l.d.e.:

$$Z'' - \epsilon^2 \Omega(t)Z = 0 \tag{6.3.6}$$

Contrails

L G theory yields, for $\Omega(t) > 0$ (nonoscillatory case):

$$\bar{Z}(t) = A_1 \Omega^{-1/4} \exp\left(\frac{\epsilon}{2} \int \Omega^{1/2} dt\right) + A_2 \Omega^{-1/4} \exp\left(-\frac{\epsilon}{2} \int \Omega^{1/2} dt\right) \quad (6.3.7)$$

Now consider the transformation (6.3.2). The equation (6.3.6) is transformed into (6.3.1) with:

$$\Omega = \frac{1}{4} \left(\omega_1^2 - 4\omega_0 + \frac{2\dot{\omega}_1}{\epsilon} \right); \quad (6.3.8)$$

$$D \equiv \omega_1^2 - 4\omega_0 = 4(\Omega - p) \quad (6.3.9)$$

$$p = \frac{\dot{\omega}_1}{2\epsilon}$$

Using (6.3.5) $\tilde{y}(t)$ can be written as:

$$\begin{aligned} \tilde{y}(t) = & B_1 (\Omega - p)^{-1/4} \gamma(t) \exp\left(-\frac{\epsilon}{2} \int \omega_1 dt + \frac{\epsilon}{2} \int [4(\Omega - p)]^{1/2} dt\right) \\ & + B_2 (\Omega - p)^{-1/4} \gamma(t) \exp\left(-\frac{\epsilon}{2} \int \omega_1 dt - \frac{\epsilon}{2} \int [4(\Omega - p)]^{1/2} dt\right) \end{aligned} \quad (a) \quad (6.3.10)$$

$$\text{where now } \gamma(t) = \exp\left(\frac{p dt}{2(\Omega - p)^{1/2}}\right) \quad (b)$$

Using (6.3.2):

$$\bar{Z}(t) = B_1 (\Omega - p)^{-1/4} \gamma(t) \exp\left(\epsilon \int (\Omega - p)^{1/2} dt\right) + B_2 (\Omega - p)^{-1/4} \gamma(t) \exp\left(-\epsilon \int (\Omega - p)^{1/2} dt\right) \quad (6.3.11)$$

By Olver's theorem and its extension (Chapter IV) the errors can be computed as follows (standard L G theory):

$$Z_i(t) = \bar{Z}_i(t) (1 + \bar{E}_i) \quad i = 1, 2 \quad \text{where}$$

$$|\bar{E}_1| \leq \exp\left(\frac{1}{2\epsilon} \int_a^t \frac{1}{\Omega^{1/4}} \left| \frac{d^2}{dt^2} (\Omega^{-1/4}) \right| dt\right) - 1, \quad (6.3.12)$$

$$|\bar{E}_2| \leq \exp\left(\frac{1}{2\epsilon} \int_t^b \frac{1}{\Omega^{1/4}} \left| \frac{d^2}{dt^2} (\Omega^{-1/4}) \right| dt\right) - 1$$

Also (for the alternative approximation, when $\gamma = \text{constant}$):

$$Z_i(t) = \tilde{Z}_i(t) (1 + \tilde{E}_i) \quad i = 1, 2 \quad \text{where}$$

$$|\tilde{E}_1| \leq \exp\left(\frac{1}{2\epsilon} \int_a^t \left| \frac{\epsilon \dot{\omega}_1}{D^{1/2}} - 2D^{-1/4} \frac{d^2}{dt^2} (D^{-1/4}) \right| dt\right) - 1$$

$$|\tilde{E}_2| \leq \exp\left(\frac{1}{2\epsilon} \int_t^b \left| \frac{\epsilon \dot{\omega}_1}{D^{1/2}} - 2D^{-1/4} \frac{d^2}{dt^2} (D^{-1/4}) \right| dt\right) - 1$$

We recall that the condition for γ to be a constant to this order is that $\dot{\omega}_1 = O(\frac{1}{\epsilon})$. In this case the shift in transition point is $O(\frac{1}{\epsilon^2})$.

On substituting from (6.3.9) and simplifying, we obtain (for constant γ):

$$Z_i(t) = \tilde{Z}_i(t) (1 + \tilde{E}_i)$$

$$|\tilde{E}_1| \leq \exp\left(\frac{1}{2\epsilon} \int_a^t \left| \frac{\epsilon^2 p}{(\Omega-p)^{1/2}} - (\Omega-p)^{-1/4} \frac{d^2}{dt^2} ((\Omega-p)^{-1/4}) \right| dt\right) - 1$$

$$|\tilde{E}_2| \leq \exp\left(\frac{1}{2\epsilon} \int_t^b \left| \frac{\epsilon^2 p}{(\Omega-p)^{1/2}} - (\Omega-p)^{-1/4} \frac{d^2}{dt^2} ((\Omega-p)^{-1/4}) \right| dt\right) - 1 \tag{6.3.14}$$

Similarly for the oscillatory case consider the equation:

$$Z'' + \epsilon^2 \Omega Z = 0; \quad \Omega(t) > 0 \text{ in } (a, b) \tag{6.3.15}$$

Using (6.3.8), $4\Omega = -(\omega_1^2 - 4\omega_0 + \frac{2\dot{\omega}_1}{\epsilon})$

i. e.: $4(\Omega + p) \doteq D_1$ where $D_1 = -(\omega_1^2 - 4\omega_0)$ (6.3.16)

As before, denoting the L.G and the time scales approximations by \bar{Z} and \check{Z} respectively, we can write

$$Z_i = \bar{Z}_i + \bar{E}_i \Omega^{-1/4} \tag{a}$$

where $|\bar{E}_{1,2}| \leq \exp\left(\pm \frac{1}{\epsilon} \left| \int_c^t \frac{1}{\Omega^{1/4}} \left| \frac{d^2}{dt^2} (\Omega^{-1/4}) \right| dt \right| \right) - 1$ (b) (6.3.17)

and $Z_i = \check{Z}_i + \check{E}_i (\Omega+p)^{-1/4}$ (a) (6.3.18)

where, for constant γ :

$$\left| \tilde{E}_{1,2} \right| \leq \exp\left(\frac{1}{\epsilon}\right) \left| \int_c^t \left| \frac{\epsilon^2 p}{(\Omega+p)^{3/2}} - (\Omega+p)^{-1/4} \frac{d^2}{dt^2} \left((\Omega+p)^{-1/4} \right) \right| dt \right|^{-1} \quad (b)$$

Thus in a given equation

$$y'' - \epsilon^2 \Omega y = 0$$

suppose that $\Omega(t)$ has a zero at t_0 and $\Omega(t) > 0$ for $a \leq t < 0$. In order to use (6.3.14) a function p is chosen such that $\Omega - p > 0$ for $a \leq t < t_0'$ and $\Omega(t_0') - p(t_0') = 0$. We require that $t_0' > t_0$. Hence $p(t_0) < 0$.

Similarly, given the equation

$$y'' + \epsilon^2 \Omega y = 0,$$

let $\Omega(t) \geq 0$ for $t \geq t_0$; also let $t_0 \leq t \leq b$ be the region of interest.

As t_0 is a transition point we choose a p such that $p(t_0) > 0$ and we can use (6.3.18) to estimate the errors of approximation. A schematic is illustrated in Fig. 39 for $\Omega(t) = t$.

6.4 Choice of the p function.

The choice of the shifting function p is governed by the following considerations. In a finite domain problem a proper p function must ensure that a transition point does not occur in the domain of interest. Thus if

$\Omega(t_0) = 0$ and $a < t_0 < b$ then $\Omega + p$ must not vanish in $a \leq t \leq b$. If time is the independent variable as is usually the case in dynamical systems, the range of t is the semi-infinite domain $0 \leq t \leq \infty$. The transition point is then moved to the negative t axis. The function p must be chosen such that $\Omega + p$ is essentially the same as Ω everywhere except near the transition point t_0 where $\Omega + p$ is non zero. p is therefore a peaked function near t_0 and sharply decays to zero on either side of it. p need not be symmetrical about the transition point; in fact an asymmetrical p may prove more useful, for, on one side it must shift the turning point while on the other it must decay sharply to have $\Omega + p \approx \Omega$.

Even in cases free of transition points the p function can be used to advantage in reducing the error of approximation. For example, considering a finite domain problem, the error of the LG approximation may be more than a specified value. Since the errors of approximation are known

through Olver's results, a p function may be chosen to keep the errors within specified limits. This might be approached as a variational problem.

Consider the equation

$$y'' + \epsilon^2 \Omega(t)y = 0 \quad (6.4.1)$$

in the interval:

$$a \leq t \leq b$$

We wish to choose a $p(\epsilon, t)$ such that the error of approximation is minimum.

The approximation itself is in terms of elementary operations and functions and reduces to the exact solutions only in special cases. From (6.3.18) it is seen that the error is minimum when

$$I \equiv \left| \int_c^t \left| \frac{\epsilon^2 p}{(\Omega + p)^{1/2}} - (\Omega + p)^{-1/4} \frac{d^2}{dt^2} ((\Omega + p)^{-1/4}) \right| dt \right| \quad (6.4.2)$$

is minimum. Thus

$$I_{\max} = \int_a^b f(p, \dot{p}, \ddot{p}, t) dt \quad (6.4.3)$$

where

$$f(p, \dot{p}, \ddot{p}, t) = \left| \frac{\epsilon^2 p}{(\Omega + p)^{1/2}} - \frac{5}{16} \frac{(\dot{\Omega} + \dot{p})^2}{(\Omega + p)^{5/2}} + \frac{1}{4} \frac{(\ddot{\Omega} + \ddot{p})}{(\Omega + p)^{3/2}} \right| \quad (6.4.4)$$

Application of the Euler-Poisson theory (Ref. 58) to the above leads to an equation, the solution of which would yield the p function for minimum error of approximation in the interval (a, b) .

It is felt that a similar approach may prove useful for higher order equations also.

SUMMARY AND CONCLUSIONS

The main results of this dissertation are summarized below.

Approximations are obtained to the solutions of linear differential equations by suitably extending the domain of the independent variable using multiple time scales. For a large class of problems, linear time scales are found to be inadequate and, therefore, nonlinear clocks are employed, on which the solutions are observed. The clocks depend on the coefficients of the original equations and are determined by a rational procedure. The Liouville-Green (or WKBJ) approximation is obtained using this method. For the noncanonical second order equation another approximation is proposed, and under certain conditions, this remains bounded where the WKBJ functions become unbounded.

In obtaining the approximations, only the domain of the independent variable is extended, so that this would correspond to the lowest order, in an expansion of the dependent variable. Specific criteria of the uniformity of the asymptotic expansion are not applied per se; however, they are implicit in that the "counterterms", --i.e. clocks--are so chosen as to cancel the nonuniform parts of direct perturbation theory. The extended perturbation equations, therefore, are forced to be homogeneous equations. A brief discussion of the criteria of uniformity is presented in Appendix V. The method can be extended to obtain higher order approximations in a straightforward way.

The validity of the approximation scheme in different intervals is examined and criteria of the failure of the approximation are proposed. Error bounds of the Olver type are derived for the second order equation in a direct way, although under restrictive conditions. Similar approximation theorems are proved for third order equations.

Applications of the approximation to the dynamics of VTOL aircraft through the hover-forward flight transition shows good accuracy in comparison with solutions obtained by numerical integration. For the decoupled equations which are of fourth order, one may expect the approximations

Contrails

to fail at a time which corresponds to multiple characteristic roots. The phugoid mode itself is not subject to this difficulty and may be isolated by proper choice of initial conditions. If the functions are computed using a digital computer, again, the difficulty at the transition point may be avoided. Further, different variations of $M_w(V)$ were investigated; however, no appreciable difference in the nature of the responses was found to occur.

TABLE I

NONUNIFORMITY IN PERTURBATION THEORY

$$y'' + \epsilon \omega y = 0$$

ω	$\left(\frac{y_1}{y_0}\right)_1$ $\sim -\frac{1}{t} \iint \omega t \, dt^2$	$\left(\frac{y_1}{y_0}\right)_2$ $\sim -\iint \omega \, dt^2$	Type of Nonuniformity
1	$\frac{t^2}{3!}$	$\frac{t^3}{3!}$	secular
t^n	$\frac{t^{n+2}}{(n+2)(n+3)}$	$\frac{t^{n+3}}{(n+2)(n+3)}$	secular, $n > -2$
$\frac{1}{t^2}$	$\ln t - 1$	$\ln t$	secular, $t \rightarrow \infty$ singular, $t \rightarrow 0$
$\frac{1}{t^3}$	$\frac{\ln t}{t}$	$\frac{1}{t^2}$	singular

TABLE II

EXTENDED DERIVATIVES

$$t \Rightarrow \{ \tau_0, \tau_1 \}; \tau_0 = t; \tau_1 = \epsilon k(t)$$

$$\frac{d}{dt} \Rightarrow \frac{\partial}{\partial \tau_0} + \epsilon \dot{k} \frac{\partial}{\partial \tau_1}$$

$$\frac{d^2}{dt^2} \Rightarrow \frac{\partial^2}{\partial \tau_0^2} + \epsilon (\ddot{k} \frac{\partial}{\partial \tau_1} + 2\dot{k} \frac{\partial^2}{\partial \tau_0 \partial \tau_1}) + \epsilon^2 (\dot{k}^2 \frac{\partial^2}{\partial \tau_1^2})$$

$$\begin{aligned} \frac{d^3}{dt^3} \Rightarrow & \frac{\partial^3}{\partial \tau_0^3} + \epsilon (\dddot{k} \frac{\partial}{\partial \tau_1} + 3\ddot{k} \frac{\partial^2}{\partial \tau_0 \partial \tau_1} + 3\dot{k} \frac{\partial^3}{\partial \tau_0^2 \partial \tau_1}) \\ & + \epsilon^2 (3\dot{k} \ddot{k} \frac{\partial^2}{\partial \tau_1^2} + 3\dot{k}^2 \frac{\partial^3}{\partial \tau_0 \partial \tau_1^2}) + \epsilon^3 (\dot{k}^3 \frac{\partial^3}{\partial \tau_1^3}) \end{aligned}$$

$$\begin{aligned} \frac{d^4}{dt^4} \Rightarrow & \frac{\partial^4}{\partial \tau_0^4} + \epsilon (\ddddot{k} \frac{\partial}{\partial \tau_1} + 4\dddot{k} \frac{\partial^2}{\partial \tau_0 \partial \tau_1} + 6\ddot{k} \frac{\partial^3}{\partial \tau_0^2 \partial \tau_1} + 4\dot{k} \frac{\partial^4}{\partial \tau_0^3 \partial \tau_1}) \\ & + \epsilon^2 (3\ddot{k}^2 \frac{\partial^2}{\partial \tau_1^2} + 4\dot{k} \ddot{k} \frac{\partial^3}{\partial \tau_1^2} + 12\dot{k} \ddot{k} \frac{\partial^3}{\partial \tau_0 \partial \tau_1^2} + 6\dot{k}^2 \frac{\partial^4}{\partial \tau_0^2 \partial \tau_1^2}) \\ & + \epsilon^3 (6\dot{k}^2 \ddot{k} \frac{\partial^3}{\partial \tau_1^3} + 4\dot{k}^3 \frac{\partial^4}{\partial \tau_0 \partial \tau_1^3}) + \epsilon^4 (\dot{k}^4 \frac{\partial^4}{\partial \tau_1^4}) \end{aligned}$$

$$\begin{aligned} \frac{d^n}{dt^n} \Rightarrow & \frac{\partial^n}{\partial \tau_0^n} + \epsilon () + \dots + \epsilon^{n-1} (n\dot{k}^{n-1} \frac{\partial^n}{\partial \tau_0 \partial \tau_1^{n-1}} + \frac{n(n-1)}{2} \dot{k}^{n-2} \ddot{k} \frac{\partial^{n-1}}{\partial \tau_1^{n-1}}) \\ & + \epsilon^n (\dot{k} \frac{\partial^n}{\partial \tau_1^n}) \end{aligned}$$

TABLE III

STABILITY DERIVATIVE VARIATION FOR TYPICAL VTOL AIRCRAFT

$$a_1 = -X_u = 0.2$$

$$b_1 = -Z_w = 0.1 + 0.004 V$$

$$b_2 = -Z_u = \frac{0.25 V}{10 + V}$$

$$c_1 = -M_q = 0.1 + 0.0034 V$$

$$c_2 = -M_u = 0.015 \left(-1 + \frac{V}{150} \right)$$

$$c_4 = -M_w$$

Case	$c_4 (V)$	$V(t)$
1	$(-0.02 + 0.00025 V) \frac{V}{150}$	$\frac{150 t}{10 + t}$
2	$0.02 \left(\frac{V}{150} \right)^2$	"
3	$0.005 + 0.015 \left(\frac{V}{150} \right)^3$	"
4	$0.005 + 0.015 \left(\frac{V}{150} \right)^2$	$\frac{150 t}{20 + t}$

Contrails

TABLE IV

EXAMPLES OF SOME CLASSICAL EQUATIONS

Name	Equation	Asymptotic Behavior
1. Bessel's Eq. of Zeroth Order	$y'' + \frac{1}{t}y' + y = 0$	$t^{-\frac{1}{2}} \exp(\pm it); t \rightarrow \infty$
2. Confluent Hypergeometric	$ty'' + (b-t)y' - ay = 0$	$\left. \begin{array}{l} e^{-t} t^{a-b} \\ t^{-a} \end{array} \right\}; t \rightarrow \infty$
3. Euler's Equation	$y''' + \frac{\epsilon^3}{t^3}y = 0$	$\left. \begin{array}{l} t^{1-\epsilon} \\ \left\{ 1 + \epsilon \left(\frac{1 \pm i\sqrt{3}}{2} \right) \right\} \\ t \end{array} \right\}; \epsilon \rightarrow \infty$
4. "Double Airy"	$y''' - 4ty' - 2y = 0$	$\left. \begin{array}{l} t^{-\frac{1}{2}} \\ t^{-1/2} e^{\pm 4/3 t^{3/2}} \end{array} \right\}; t \rightarrow \infty$
5. Euler's Equation	$y^{(n)} + \left(\frac{\epsilon}{t}\right)^n y = 0$	$t^{\frac{n-1}{2}} t^{\epsilon} (e^{\pi i/n}) \quad \epsilon \rightarrow \infty$

Contrails

APPENDIX I EXTENSION OF THE n^{th} ORDER DERIVATIVE

With the two time scale extension

$$t \Rightarrow \{ \tau_0, \tau_1 \} ; \tau_0 = t, \tau_1 = \epsilon k(t) \quad (1)$$

The derivative operator is extended as

$$\frac{d}{dt} \Rightarrow \frac{\partial}{\partial \tau_0} + \frac{d\tau_1}{dt} \frac{\partial}{\partial \tau_1} = \frac{\partial}{\partial \tau_0} + \epsilon \dot{k} \frac{\partial}{\partial \tau_1} \quad (2)$$

$$\begin{aligned} \frac{d^2}{dt^2} &\Rightarrow \left(\frac{\partial}{\partial \tau_0} + \epsilon \dot{k} \frac{\partial}{\partial \tau_1} \right) \left(\frac{\partial}{\partial \tau_0} + \epsilon \dot{k} \frac{\partial}{\partial \tau_1} \right) \\ &= \frac{\partial^2}{\partial \tau_0^2} + \epsilon \left(\ddot{k} \frac{\partial}{\partial \tau_1} + 2\dot{k} \frac{\partial^2}{\partial \tau_0 \partial \tau_1} \right) + \epsilon^2 \left(\dot{k}^2 \frac{\partial^2}{\partial \tau_1^2} \right) \quad (3) \end{aligned}$$

Similarly

$$\frac{d^n}{dt^n} \Rightarrow \left(\frac{\partial}{\partial \tau_0} + \epsilon \dot{k} \frac{\partial}{\partial \tau_1} \right)^n \quad (4)$$

$$\begin{aligned} &= \frac{\partial^n}{\partial \tau_0^n} + \epsilon () + \epsilon^2 () + \dots + \epsilon^{n-1} () \\ &+ \epsilon^n \dot{k}^n \frac{\partial^n}{\partial \tau_1^n} \quad (5) \end{aligned}$$

Clearly the r.h.s. contains terms due to the binomial expansion of the operator and those due to successive derivatives of the clock function.

For purposes of the present approximation scheme, only terms of order ϵ^n and ϵ^{n-1} are needed in addition to the lowest order terms. The terms are

Contrails

$$\epsilon^0 : \frac{\partial^n}{\partial \tau_0^n} \tag{a}$$

$$\epsilon : k^{(n)} \frac{\partial}{\partial \tau_1} + \sum_{r=1}^{n-1} \binom{n}{r} k^{(n-r)} \frac{\partial^{r+1}}{\partial \tau_0^r \partial \tau_1} \tag{b}$$

$$\epsilon^{n-1} : n \dot{k}^{n-1} \frac{\partial^n}{\partial \tau_0 \partial \tau_1^{n-1}} + \frac{n(n-1)}{2} (\dot{k})^{n-2} k'' \frac{\partial^{n-1}}{\partial \tau_1^{n-1}} \tag{c}$$

$$\epsilon^n : (\dot{k})^n \frac{\partial^n}{\partial \tau_1^n} \tag{d}$$

That these are indeed the terms is proven by the principle of mathematical induction as follows. We shall prove that if (6) is true for n then it is true for $n+1$ and show that it is indeed true for one n . Letting the derivative operator (2) act again on (6),:

$$\begin{aligned} & \left(\frac{\partial}{\partial \tau_0} + \epsilon \dot{k} \frac{\partial}{\partial \tau_1} \right) \left\{ \frac{\partial^n}{\partial \tau_0^n} + \epsilon k^{(n)} \frac{\partial}{\partial \tau_1} + \sum_{r=1}^{n-1} \binom{n}{r} k^{(n-r)} \frac{\partial^{r+1}}{\partial \tau_0^r \partial \tau_1} \right. \\ & + \dots + \epsilon^{n-1} \left(n \dot{k}^{n-1} \frac{\partial^n}{\partial \tau_0 \partial \tau_1^{n-1}} + \frac{n(n-1)}{2} (\dot{k})^{n-2} k'' \frac{\partial^{n-1}}{\partial \tau_1^{n-1}} \right) \\ & \left. + \epsilon^n \left((\dot{k})^n \frac{\partial^n}{\partial \tau_1^n} \right) \right\} \tag{7} \end{aligned}$$

The various terms can be written as:

$$\epsilon^0 : \frac{\partial^{n-1}}{\partial \tau_0^{n+1}} \tag{a}$$

$$\epsilon : k^{(n+1)} \frac{\partial}{\partial \tau_1} + k^{(n)} \frac{\partial^2}{\partial \tau_0 \partial \tau_1} + \dot{k} \frac{\partial^{n+1}}{\partial \tau_0^n \partial \tau_1} \tag{8}$$

$$+ \sum_{r=1}^{n-1} \binom{n}{r} \left[k^{(n-r+1)} \frac{\partial^{r+1}}{\partial \tau_0^r \partial \tau_1} + k^{(n-r)} \frac{\partial^{r+2}}{\partial \tau_0^{r+1} \partial \tau_1} \right]$$

Contrails

$$= k^{(n+1)} \frac{\partial}{\partial \tau_1} + \sum_{r=1}^n \binom{n+1}{r} k^{(n-r+1)} \frac{\partial^{r+1}}{\partial \tau_0^r \partial \tau_1} \quad (b)$$

$$\begin{aligned} e^n & : \quad n(k)^{n-1} k'' \frac{\partial^n}{\partial \tau_1^n} + k^n \frac{\partial^{n+1}}{\partial \tau_0 \partial \tau_1^n} + n(k)^n \frac{\partial^{n+1}}{\partial \tau_0 \partial \tau_1^n} \\ & + \frac{n(n-1)}{2} (k)^{n-1} k'' \frac{\partial^n}{\partial \tau_1^n} \\ & = (n+1) (k)^n \frac{\partial^{n+1}}{\partial \tau_0 \partial \tau_1^n} + \frac{(n+1)n}{2} (k)^{n-1} k'' \frac{\partial^n}{\partial \tau_1^n} \quad (c) \end{aligned}$$

$$e^{n+1} : \quad (k)^{n+1} \frac{\partial^{n+1}}{\partial \tau_1^{n+1}} \quad (d)$$

On examining (6) and (8) it is seen that (8) is obtained from (6) by replacing n by $(n+1)$. Hence, if (6) is true for n then it is true for $(n+1)$. It is easily verified from (6) and (3) that it is true for $n = 2$; thus it is true for any n .

APPENDIX II

CONDITION FOR THE INVARIANCE OF THE AMPLITUDE FUNCTION

W. R. T. THE CHARACTERISTIC ROOTS

Let the differential equation be written as :

$$y''' + \epsilon^2 3\omega_1(t)y' - \epsilon^3 2\omega_0(t)y = 0 \quad (1)$$

The characteristic equation is given by:

$$F \equiv x^3 + 3\omega_1(t)x - 2\omega_0(t) = 0 \quad (2)$$

Let the functions s_1 and s_2 be defined as follows

$$s_1^3 = \omega_0 + (\omega_1^3 + \omega_0^2)^{1/3} ; \quad s_2^3 = \omega_0 - (\omega_1^3 + \omega_0^2)^{1/3} \quad (3)$$

and, therefore

$$s_1 s_2 = -\omega_1$$

taking the real quantity. The roots of (2) are given by (Ref. 50, p. 17):

$$x_1 = (s_1 + s_2) ; \quad x_{2,3} = -\left(\frac{s_1 + s_2}{2}\right) \pm i \frac{\sqrt{3}}{2} (s_1 - s_2) \quad (4)$$

The approximation to the solutions of (1) for large ϵ is given as

$$\tilde{y}(t) = C D(t) \exp\left(\epsilon \int_{\xi}^t x_i ds\right) \quad (5)$$

where

$$D(t) = \left(\frac{\partial F}{\partial x}\right)^{-1/2} = (x^2 + \omega_1)^{-1/2} \quad (6)$$

where x_i are the three roots of (2) given in (4).

We wish to show that under certain conditions the dependence of D on t is invariant w.r.t. the roots.

Since ω_1 is a given function, it is sufficient to show that

$$\left| \frac{x^2}{\omega_1} \right| \rightarrow \text{a constant in some limit.}$$

Taking $x_1 = s_1 + s_2$:

$$\left| \frac{x^2}{\omega_1} \right| = \frac{(s_1 + s_2)^2}{s_1 s_2} = \frac{s_1}{s_2} + 2 + \frac{s_2}{s_1}$$

Thus $\left| \frac{x^2}{\omega_1} \right| \rightarrow \text{constant}$ if $\left| \frac{s_1}{s_2} \right| \rightarrow \text{constant}$

i. e.

$$\left| \frac{\omega_0 + (\omega_1^3 + \omega_0^2)^{\frac{1}{2}}}{\omega_0 - (\omega_1^3 + \omega_0^2)^{\frac{1}{2}}} \right| \rightarrow \text{constant}$$

i. e.

$$\left| \frac{2\omega_0^2 + \omega_1^3 + 2\omega_0 (\omega_1^3 + \omega_0^2)^{\frac{1}{2}}}{\omega_1^3} \right| \rightarrow \text{constant}$$

Thus it is sufficient that $\left| \frac{\omega_1^3}{\omega_0^2} \right| \rightarrow \text{constant}$ for $\left| \frac{x^2}{\omega_1} \right|$ to approach a constant. (7)

Similarly for the other two roots. In this case the function:

$$D(t) = \frac{1}{(x^2 + \omega_1)^{1/2}} = \frac{1}{\omega_1^{1/2} \left(\frac{x^2}{\omega_1} + 1 \right)^{1/2}} = (\text{constant}) \omega_1^{-1/2} (t)$$

Thus when $\frac{\omega_1^3(t)}{\omega_0^2(t)} = \text{constant}$, $D(t) = \omega_1^{-1/2} (t)$ (8)

APPENDIX III

CONDITION FOR CONSTANCY OF SIGN OF f_y

In equation

$$y'' + \epsilon^2 \omega y = 0 \tag{1}$$

if $\omega(t) \leq 0$, the characteristic roots are real.

Now if (i) $y_1(t) \xrightarrow{t \uparrow} 0$, $a \leq \xi \leq b$ (2)

or (ii) $y_1(\xi) \geq \tilde{y}_1(\xi) \xrightarrow{\xi \uparrow} 0$ (3)

and $y_1(\xi) \xrightarrow{\xi \uparrow} > 0$

then by corollary to Sturm's theorem y_1 does not change sign in (a, b) and is positive.

The condition for constancy of sign of $f(t)$ is examined as follows.

$$f(t) = -\omega^{1/4} (\omega^{-1/4})'' = 1/4 \left[\frac{\omega''}{\omega} - \frac{5}{4} \left(\frac{\dot{\omega}}{\omega} \right)^2 \right] \tag{4}$$

$$f(t) \geq 0 \text{ if } \frac{\omega''}{\omega} - \frac{5}{4} \left(\frac{\dot{\omega}}{\omega} \right)^2 \geq 0 \tag{5}$$

i.e. $4(\dot{z} + z^2) \geq 5z^2$; where $z \equiv \frac{\dot{\omega}}{\omega}$. (6)

i.e. $4z \geq z^2$. Thus $\dot{z} > 0$.

For example, if $\omega(t) = t^n$, we see that $f \geq 0$ if $-4 \leq n < 0$. For a more general $\omega(t)$, conditions must be similarly established.

APPENDIX IV

PLK METHOD APPLIED TO A SECULAR PERTURBATION PROBLEM

Consider the equation :

$$y' + \epsilon y = 0 \tag{1}$$

The variables are extended à la Lighthill as follows.

$$y(t) \Rightarrow y_0(s) + \epsilon y_1(s) + \dots \tag{2}$$

$$t = s + \epsilon t_1(s) + \dots$$

Therefore: $\frac{dy}{ds} + \epsilon y (1 + \epsilon t_1' + \dots) = 0 \tag{3}$

Order by order the equations are

$$\frac{dy_0}{ds} = 0 \tag{a}$$

$$\frac{dy_1}{ds} = -y_0 \tag{b} \tag{4}$$

$$\frac{dy_2}{ds} = -(y_1 + y_0 t_1') \tag{c}$$

and so on, giving :

$$y_0 = C_0 = \text{constant}$$

$$y_1 = -C_0 s + C_1$$

Using the uniformity condition:

$$\frac{dt_1}{ds} = -\frac{y_1}{y_0} = s \quad \text{or} \quad t_1 = \frac{s^2}{2} + C_2$$

From (2), $t = s + \epsilon \left(\frac{s^2}{2} + C_2 \right)$ to order ϵ .

Solving for s , we have $s = -1 \pm (1 - \epsilon (C_2 \epsilon - t))^{1/2} \tag{a} \tag{5}$

Contrails

When the constant $C_2 = 0$, $s = -1 \pm (1 + \epsilon t)^{1/2}$ (b) (5)

The exact solution of (1) is obtained as:

$$y = A \exp(-\epsilon t) \quad (6)$$

We see from (5) that the relation between s and t is an algebraic one and cannot be expected to capture the exponential variation of $y(t)$.

Alternatively, since the PLK method has been usually applied to singular perturbation problems, one may be prompted to convert (1) to this form and then apply the method.

Defining $t = \frac{1}{x}$, (1) becomes

$$x^2 \frac{dy}{dx} - \epsilon y = 0 \quad (7)$$

This is a singular perturbation problem as can be seen by expanding $y = y_0 + \epsilon y_1 + \dots$; whence:

$$y_0 = A = \text{Constant}$$

$$y_1 = -\frac{A}{x} \text{ etc.}$$

Now applying the PLK method, we expand:

$$y \implies y_0(z) + \epsilon y_1(z) + \dots \quad (8)$$

$$x = z + \epsilon x_1(z) + \dots$$

Substituting (8) into (7), the resulting equations are written as follows:

$$z^2 \frac{dy_0}{dz} = 0 \quad (a)$$

$$z^2 \frac{dy_1}{dz} = -\left(2x_1 z \frac{dy_0}{dz} - y_0\right) \quad (b) \quad (9)$$

$$z^2 \frac{dy_2}{dz} = -\left[2x_1 z \frac{dy_1}{dz} + (x_1^2 + 2x_2 z) \frac{dy_0}{dz} - y_1 - y_0 \frac{dx_1}{dz}\right] \quad (c)$$

Therefore, $y_0 = C_0 = \text{constant}$

$$y_1 = -\frac{C_0}{z} + C_1$$

Setting the r. h. s. of (9c) for uniformity:

$$y_0 \frac{dx_1}{dz} - 2 x_1 z \frac{dy_1}{dz} + y_1 = 0$$

$$\frac{dx_1}{dz} - \frac{2}{z} x_1 = \left(\frac{1}{z} - C_0 \right)$$

Integrating:

$$x_1 = -\frac{1}{2} + (C_2 + 1)z + C_3 z^2 \tag{10}$$

Now from (8): $x = z + \epsilon x_1$; again, this being an algebraic relation, it cannot be expected to describe the exponential behavior of the exact solution;

$$y(x) = C \exp\left(-\frac{\epsilon}{x}\right)$$

It is felt that this simple example demonstrates the difference between the PLK and the multiple time scales approaches.

APPENDIX V

UNIFORM VALIDITY

The criterion for uniform validity of the approximation can be stated in many ways. The following two ways are usually considered.

1. Ratio Criterion.

Suppose that the function $f(t)$ has an expansion

$$f = f_0 + \epsilon f_1 + \epsilon^2 f_2 + \dots$$

$$\text{i.e.: } \frac{f}{f_0} = 1 + \epsilon \frac{f_1}{f_0} + \dots, \quad f_0 \neq 0$$

Therefore,

$$\frac{f}{f_0} \rightarrow 1 \text{ if } \epsilon \frac{f_1}{f_0} \rightarrow 0$$

$$\text{i.e.: } \frac{f}{f_0} = 1 + O(\epsilon)$$

$f_0(t)$ is therefore a uniformly valid approximation to $f(t)$ in a region J if and only if

$$\frac{f}{f_0} = 1 + O(\epsilon)$$

for all t in J . The ratio of f to f_0 approaches unity as $\epsilon \rightarrow 0$. This form of the criterion is used, for example, by Erdelyi (Ref. 40).

2. Difference Criterion.

From the above expansion for f :

$$f - f_0 = \epsilon f_1 + \dots$$

This requires that the difference between f and f_0 approach zero as $\epsilon \rightarrow 0$.

The difference criterion can be misleading when dealing with very small or very large quantities, as can be seen by the following example.

Consider the equation

$$y' = (1 + \epsilon)y = 0$$

Contrails

with the condition: $y(0) = 1$

The exact solution is written as $y = \exp(- (1+\epsilon) t)$. A perturbation expansion yields, in lowest order:

$$y_0' + y_0 = 0 \quad \text{or} \quad y_0 = C \exp(-t)$$

The difference

$$y - y_0 = \exp(- (1+\epsilon) t) - \exp(-t)$$

approaches zero for large t and hence according to the difference criterion one would conclude y_0 to be a uniformly valid approximation of $y(t)$ for large t , to order ϵ . This is severely in error because, although the difference approaches zero, the functions themselves are vanishingly small.

However, the ratio test shows that $\frac{y}{y_0} = \exp(-\epsilon t) \xrightarrow{t \uparrow} 0$ and does not tend to 1.

For the equation $y' - (1+\epsilon)y = 0$; $y(0) = 1$, a similar analysis shows:

$$y = \exp((1+\epsilon) t); \quad y_0 = \exp(t)$$

and

$$R \equiv \frac{y}{y_0} = \exp(\epsilon t); \quad D \equiv y - y_0 = \exp((1+\epsilon) t) - \exp(t)$$

We require $R \rightarrow 1$ and $D \rightarrow 0$ as $t \rightarrow \infty$. The actual values are given below.

t	R	D
0	1	0
$\frac{1}{\epsilon}$	e	$e^{1/\epsilon} (e-1) \approx 1.7 e^{1/\epsilon}$
$\frac{1}{\epsilon^2}$	$e^{1/\epsilon}$	$e^{1/\epsilon^2} (e^{1/\epsilon} - 1) \approx e^{1/\epsilon^2}$

Thus for large t the difference error is much larger than the ratio error.

REFERENCES

1. Bellman, R. Perturbation Techniques in Mathematics, Physics, and Engineering. Holt, Rinehart and Winston, Inc.: New York, (1964) p. 10.
2. Poincaré, H. Méthodes Nouvelles de la Mécanique Céleste, Vol. I. Dover Press: New York, (1957).
3. Graham, D., E.J. Brunelle, Jr., W. Johnson, H. Passmore, III, Engineering Analysis Methods for Linear Time Varying Systems, Tech. Doc. Rep. ASD-TDR-62-362, (January 1963).
4. Watson, G.N. Bessel Functions, Cambridge University Press (1944), p.6.
5. Liouville, J. J. Math. Pures Appl., (1837), 2, pp. 16-35.
6. Green, G. Cambr. Phil. Trans. (1837), 6, pp. 457-62.
7. Wentzel, G. Zeit f. Phys. (1926), 38, p. 518.
8. Kramers, H.A. Zeit f. Phys. (1926), 39, pp. 828-40.
9. Brillouin, L. C.R. Acad. Sci. Paris (1926), 183, pp. 24-26.
10. Jeffreys, H. Proc. Lond. Math. Soc. (1923), 23 (2), pp. 428-36.
11. Jeffreys, H. "On Approximate Solutions to Linear Differential Equations," Proc. Cambr. Phil. Soc. (1953), 49, pp. 601-611.
12. Gans, R. "Fortpflanzung des Lichts durch ein inhomogenes Medium," Ann. Phys., Lpz (1915), 47, pp. 709-36.
13. Bailey, V.A. (1954) Scientific Report No. 67, Ionospheric Research Lab., Pennsylvania State University; Pennsylvania.
14. Rayleigh, Lord. Proc. Roy. Soc. (1912), A, 86, pp. 207-26.
15. Jeffreys, B.S. "The Asymptotic Approximation Method," Quantum Theory, I, edited by D.R. Bates, Academic Press: New York (1961).
16. Heading, J. An Introduction to Phase-Integral Methods. Methuen: London (1962).
17. Ibid., p. 2.
18. Schelkunoff, S.A. Comm. Pure and Appl. Math., (1951), 4, pp. 117-28.
19. Stokes, G.G. Sir George Gabriel Stokes, Memoirs and Scientific Correspondance. Cambridge University Press, Vol., I, (1907), p. 62.

20. Stokes, G. G. "On the Discontinuity of Arbitrary Constants that Appear as Multipliers of Semi-Convergent Series", Acta Math. Vol. 26 (Abel Centenary Volume) (1902), pp. 393-97. Reprinted in Math. and Phys. Papers, Vol. 5 , pp. 283-87.
21. Morse, P. and H. Feshbach. Methods of Theoretical Physics, Part I, McGraw-Hill: New York (1953).
22. Langer, R.E. "On the Connection Formulas and the Solutions of the Wave Equation", Phys. Review (April, 1937), vol. 51, pp. 669-76.
23. Hartman, P. Ordinary Differential Equations, Wiley: New York, (1964); extensive bibliography is given in this work.
24. Feshchenko, S.F., N.I. Shk'l, L.D. Nikolenko. Asymptotic Methods in the Theory of Linear Differential Equations, N.A.S.A. TT F-458. An extensive bibliography is given in this work.
25. Budden, K. G. Radio Waves in the Ionosphere. Cambridge University Press (1961).
26. Pipes, L.A. "Four Methods for the Analysis of Time Variable Circuits," Trans. IRE ct-2, 1, (March 1955).
27. Curtiss, H.C. Jr. An Analytical Study of the Dynamics of Aircraft in Unsteady Flight. Ph.D. Thesis, Dept. of Aerospace and Mechanical Sciences, Princeton University, Princeton, N.J. (1965). Also published as USAA VLABS Technical Report 65-48.
28. Olver, F.W.J. "Error Bounds for the Liouville-Green (or WKB) Approximation," Proc. Cambr. Phil. Soc. (1961), 57, pp. 790-810.
29. Sandri, G. "The New Foundations of Nonequilibrium Statistical Mechanics," Ann. Phys. N.Y. (1963), 24, pp. 332-82.
30. Sandri, G. "Uniformization of Asymptotic Expansions," ARAP Rep. No. 89, to appear in Nonlinear Partial Differential Equations, W. Ames, ed., Academic Press: New York, 1967.
31. Lighthill, M.J. "A Technique for Rendering Approximate Solutions to Physical Problems Uniformly Valid," Phil. Mag. (1949), 40, p. 1179.
32. Tsien, H. "The PLK Method," Advances in Applied Mechanics, Vol. IV, (1956), Academic Press, Inc., pp. 281-349.
33. Van Dyke, Perturbation Methods in Fluid Mechanics. Academic Press: New York, (1964).
34. Kryloff, N. and N. Bogoliuboff. An Introduction to Nonlinear Mechanics. (English Translation by S. Lefschetz), Princeton University Press: Princeton, N.J. (1947).

Contrails

35. Bogoliuboff, N. and Y.A. Mitropolsky. Asymptotic Methods in the Theory of Nonlinear Oscillations, Gordon and Breach : New York (1961).
36. Cole, J.D. and J. Kevorkian. "Uniformly Valid Asymptotic Approximation for Certain Nonlinear Differential Equations," Proc. Internat. Symp. Nonlinear Differential Equations and Nonlinear Mechanics, Academic Press: New York, (1963), pp. 113-20.
37. Frieman, E.A. "On a New Method in the Theory of Irreversible Processes," J. Math. Phys., Vol. 4, no. 3 (1963), pp. 410-18.
38. See Ref. 29, Section 3.
39. Whittaker, E. T. and G.N. Watson. A Course of Modern Analysis. Cambridge University Press (Reprinted 1965). Also, Dover: New York, (1965).
40. Erdelyi, A. Asymptotic Expansions. Dover: New York (1956).
41. Kruskal, M. D. Asymptotology. MATT-160, Princeton University Plasma Physics Lab., Princeton, N. J. (1962).
42. Birkhoff, G. and G.C. Rota. Ordinary Differential Equations. Ginn and Company: Boston (1962).
43. Mikhlin, S. G. Integral Equations. (Translated from Russian by A.H. Armstrong), Pergamon Press: New York (1957), pp. 15, 16.
44. Erdelyi, A. "Asymptotic Solutions of Differential Equations with Transition Points or Singularities," J. Math. Phys., Vol. 1, no. 1 (1960), pp. 16-26.
45. Wintner, A. "The Schwartzian Derivative and the Approximation Method of Brillouin," Quart. Appl. Math. (1958), 16, pp. 82-86.
46. Coppel, W.A. Stability and Asymptotic Behavior of Differential Equations, D. C. Heath Co.: Boston (1965).
47. Seckel, E. Stability and Control of Airplanes and Helicopters. Academic Press; New York (1964).
48. Beppu, Goro. An Analytical Study of Various Factors Influencing the Longitudinal Stability Derivatives of a Typical Tilt-Wing VTOL Aircraft, Rep. No. 756, Dept. of Aerospace and Mechanical Sciences, Princeton University, Princeton, N.J. (1965).
49. Curtiss, H.C. Jr., and Curnutt, R.A. A Comparison of the Longitudinal Stability Characteristics of Three Tilt-Wing VTOL Aircraft Designs,

Contrails

- Rep. 749, Dept. of Aerospace and Mech. Sciences, Princeton University, Princeton, N.J. Also published as USAAVLABS Technical Report 66-44.
50. Abramowitz, M. and I. A. Stegun. Handbook of Mathematical Functions. National Bureau of Standards (1964), pp. 506, 508.
 51. Ibid., p. 448.
 52. Ashley, H. Multiple Scaling in Flight Dynamic Analysis--A Preliminary Look. Paper presented at the AIAA Guidance, Control and Flight Dynamics Conference, Huntsville, Alabama, August, 1967.
 53. Ramnath, R. V. Approximate Analysis of Linear Systems with Very Slowly Varying Coefficients. Rep. No. 748, Dept. of Aerospace and Mech. Sciences, Princeton University, Princeton, N. J. (1965).
 54. Langer, R. E. "The Asymptotic Solutions of Ordinary Linear Differential Equations of the Second Order, with Special Reference to the Stokes Phenomenon," Bull. Am. Math. Soc. (1934), 40, pp. 545-82. An extensive bibliography on this subject is given in Ref. 55.
 55. Wasow, W. W. Asymptotic Expansions for Ordinary Differential Equations, Interscience (1965).
 56. Langer, R. E., "On the Asymptotic Expansion of Ordinary Linear Differential Equations of the Third Order in a Region Containing a Turning Point," Trans. Am. Math. Soc. (1955), 80, pp. 93-123.
 57. Zwaan, A. "Intensitäten im Ca-Funkenspektrum," Academisch Proefschrift (1929), (John Enschedé en Zonen, Haarlem).
 58. Elsgolc, L. E. Calculus of Variations. Pergamon Press: New York (1961).
 59. Friedrichs, K. O. "Asymptotic Phenomena in Mathematical Physics," Bull. Am. Math. Soc. (1955), 61, pp. 485-504.
 60. Ince, E. L. Ordinary Differential Equations. Dover: New York (1944).
 61. Bellman, R. Stability Theory of Differential Equations, McGraw-Hill: New York (1953).
 62. Clemmow, P. C. and J. Heading. "Coupled Forms of Differential Equations Governing Radio Propagation in the Ionosphere," Proc. Cambr. Phil. Soc. (1954), 50, pp. 319-33.
 63. Slater, L. J. Confluent Hypergeometric Functions, Cambridge University Press (1960).

Contrails

64. Webb, H.A. and J.R. Airey. "The Practical Importance of the Confluent Hypergeometric Function," Phil. Mag. (1918), 36, pp. 129-41.
65. Uspensky, J.V. Theory of Equations. McGraw-Hill: New York (1948), pp. 56-58.
66. Sandri, G. "A New Method of Expansion in Mathematical Physics," I, Il Nuovo Cimento, Serie X, Vol. 36 (1965), pp. 67-93.
67. Sandri, G. and R. Sullivan. "A Constructive Approach in the Method of Extension," Il Nuovo Cimento, Serie X, Vol. 37 (1965), pp. 1799-1800.
68. Copson, E.T. Asymptotic Expansions. Cambridge University Press (1965).
69. Jeffreys, H. Asymptotic Approximations. Oxford University Press (1962).
70. Kritz, A., R.V. Ramnath, G. Sandri. Electromagnetic Wave Propagation in a Turbulent Plasma. Paper presented at the Am. Phy. Soc. meeting, Austin, Texas, November, 1967.

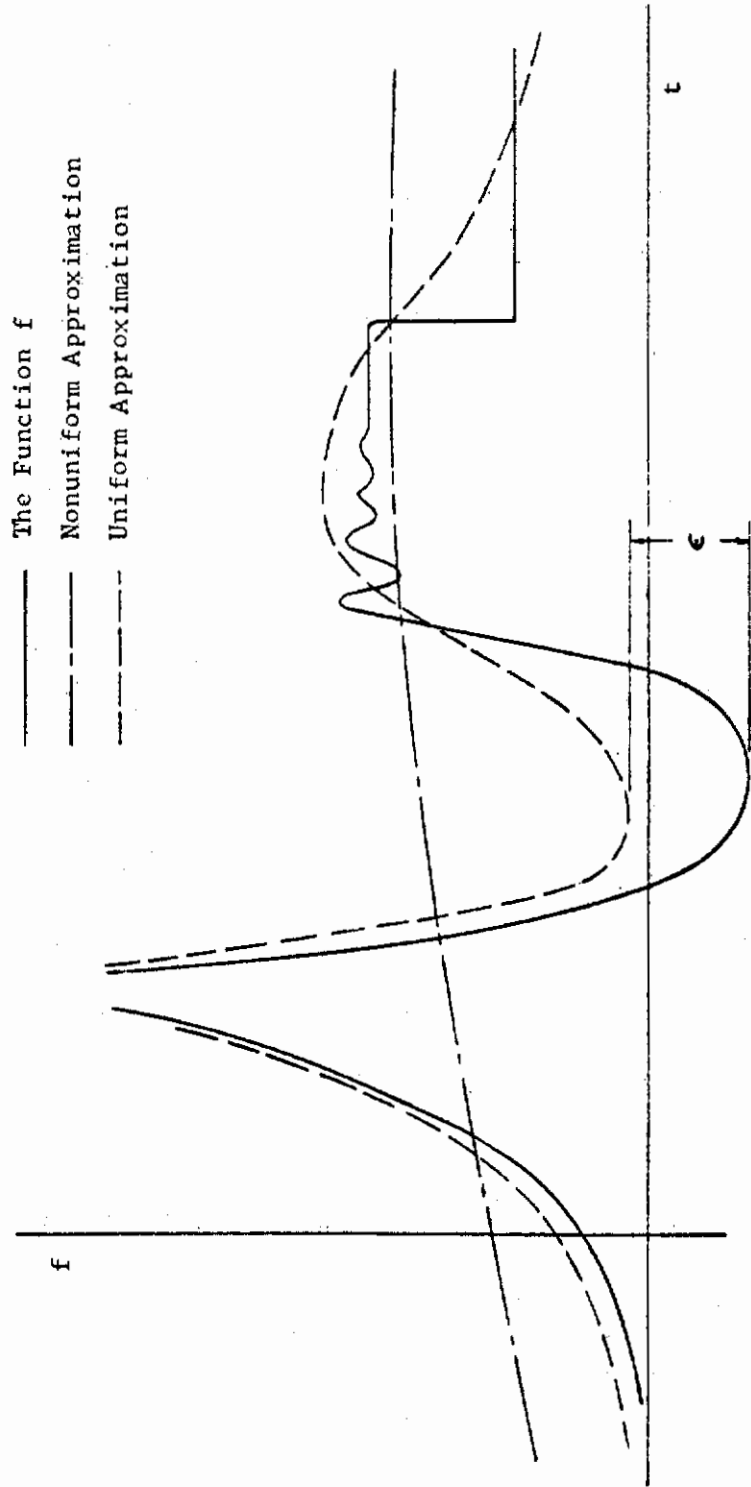

Figure 1. Approximations to f

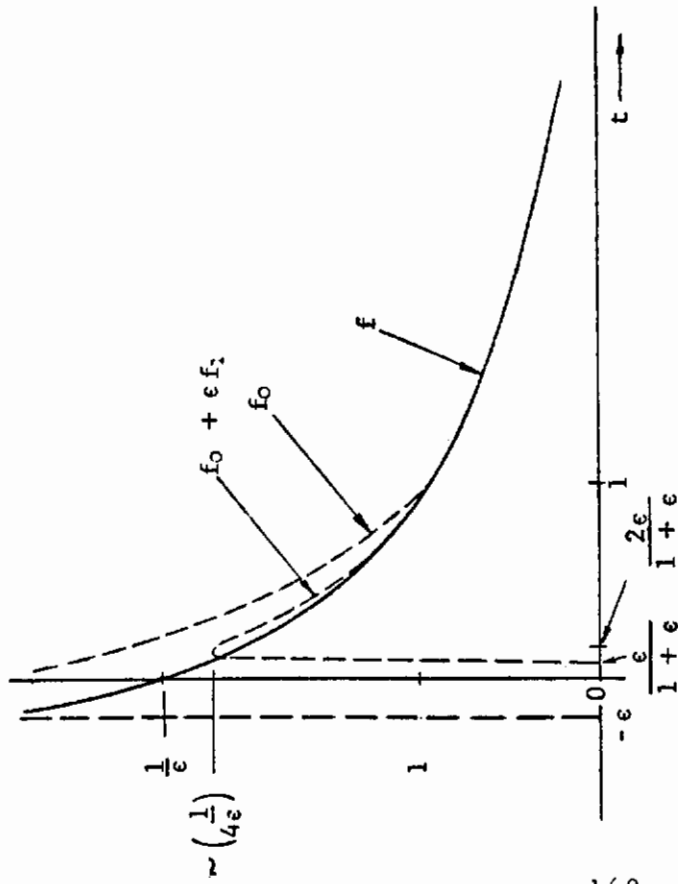

Figure 2. Singular Perturbation Linear Lighthill Model (Not to Scale)

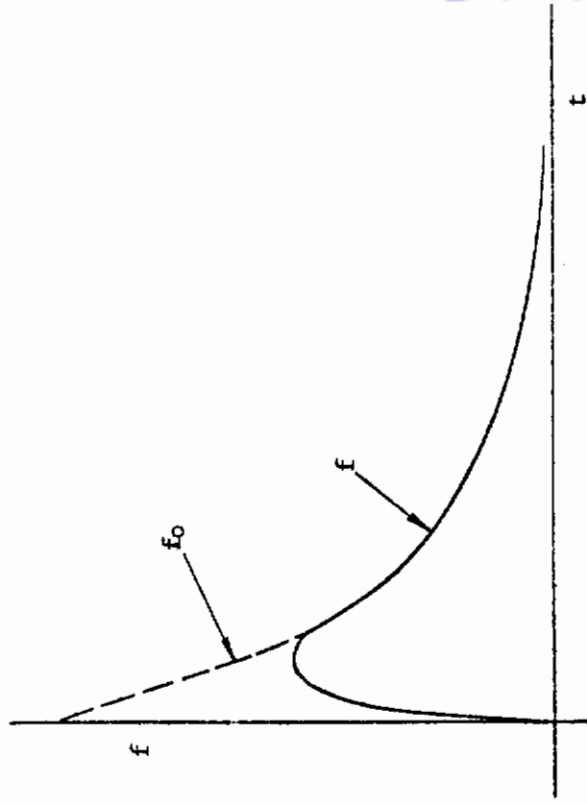

Figure 3. Boundary Layer Model (Schematic)

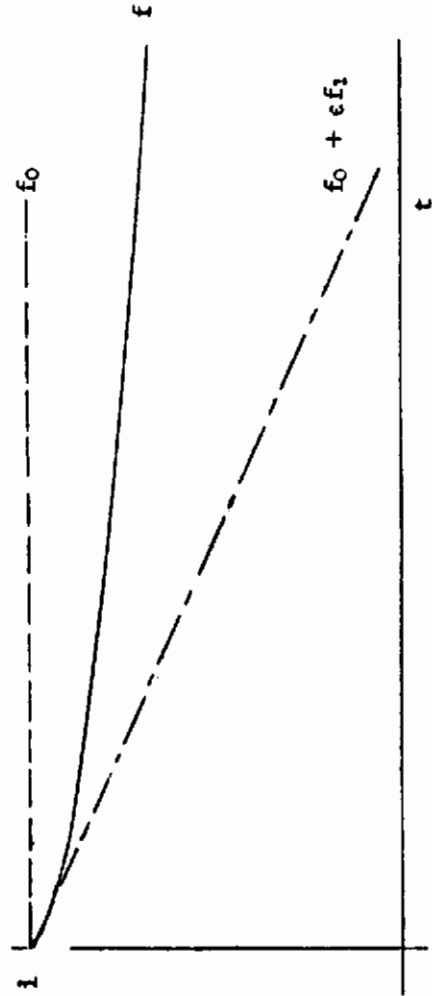

Figure 4. Slowly Decaying Exponential (Schematic)

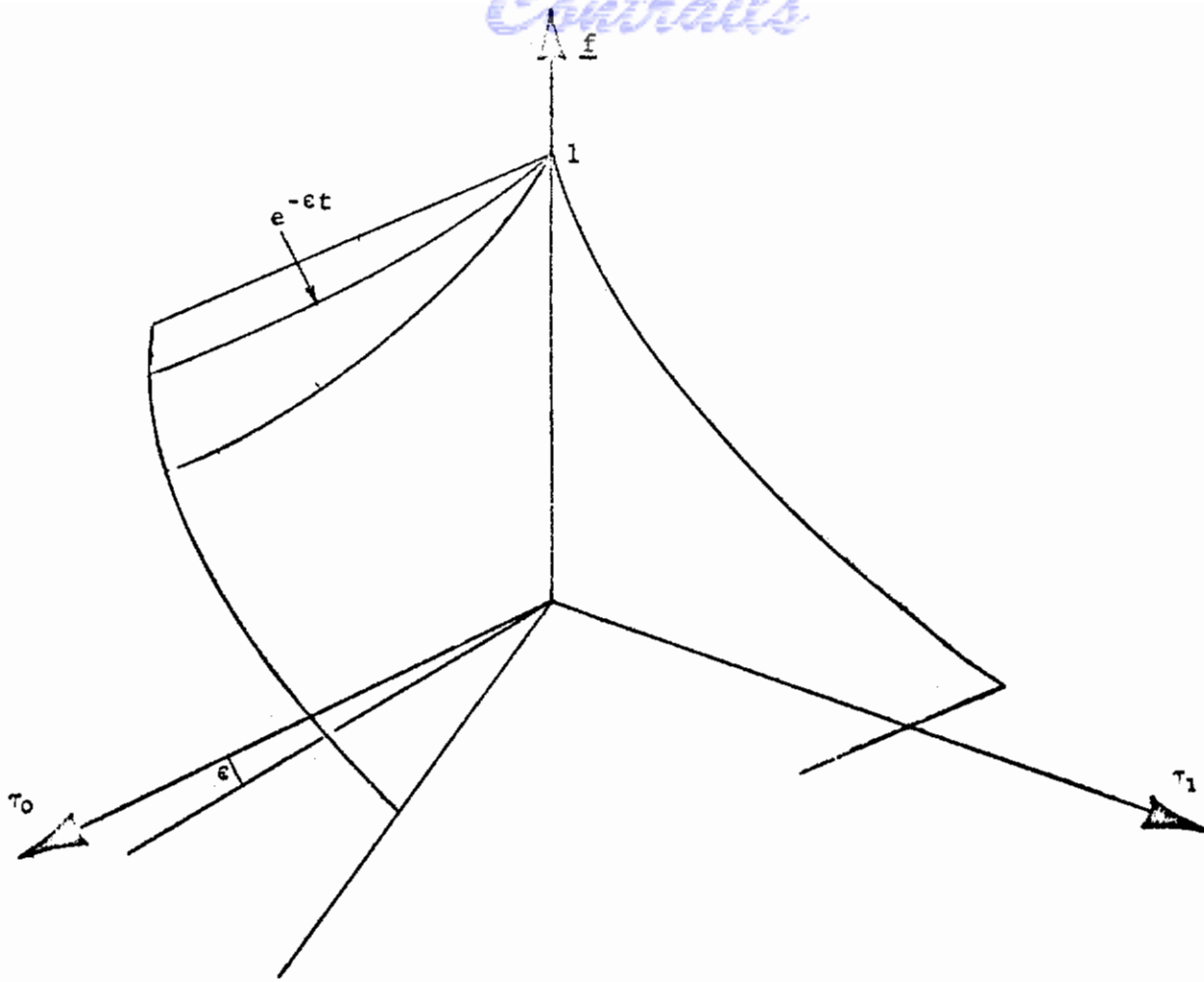

Figure 5. Embedding in a "Space of Times"

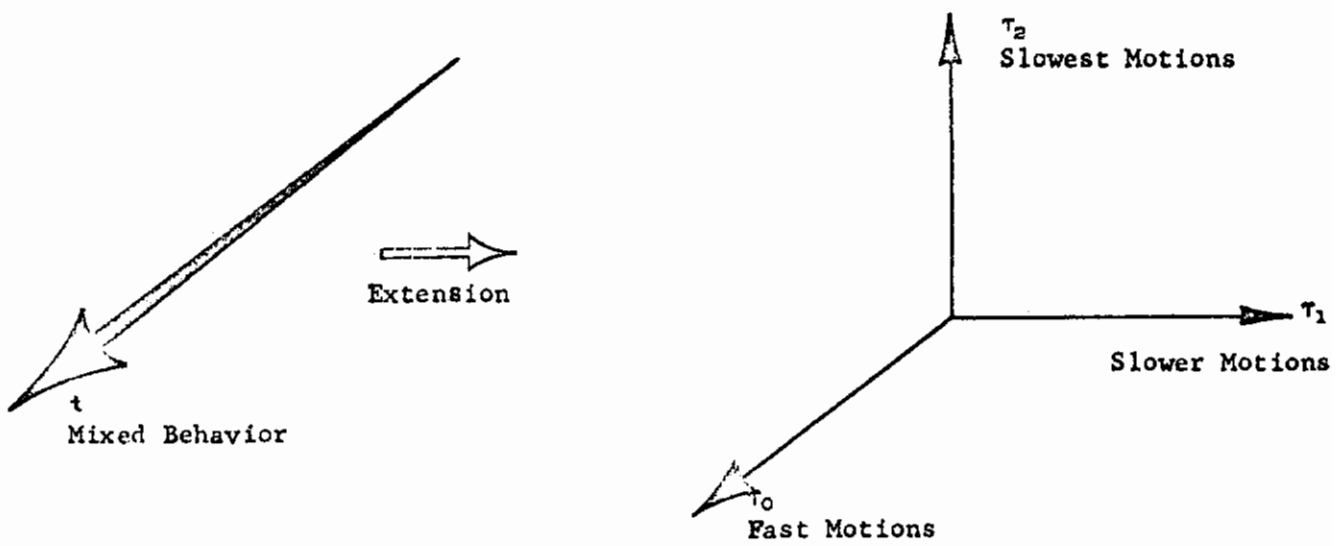

Figure 6. Extension of the Domain

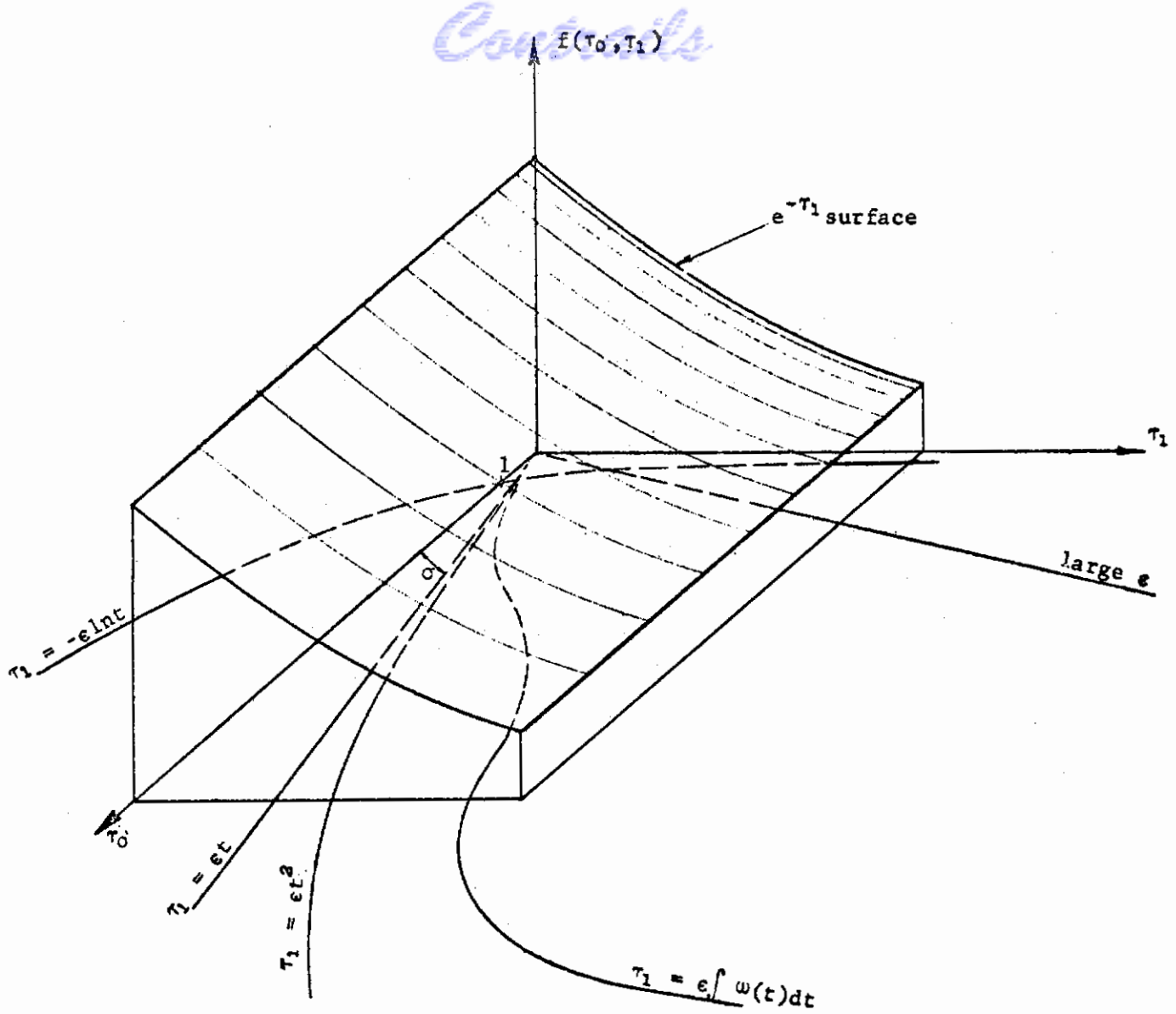

Figure 7. Function Surface in Extended Space

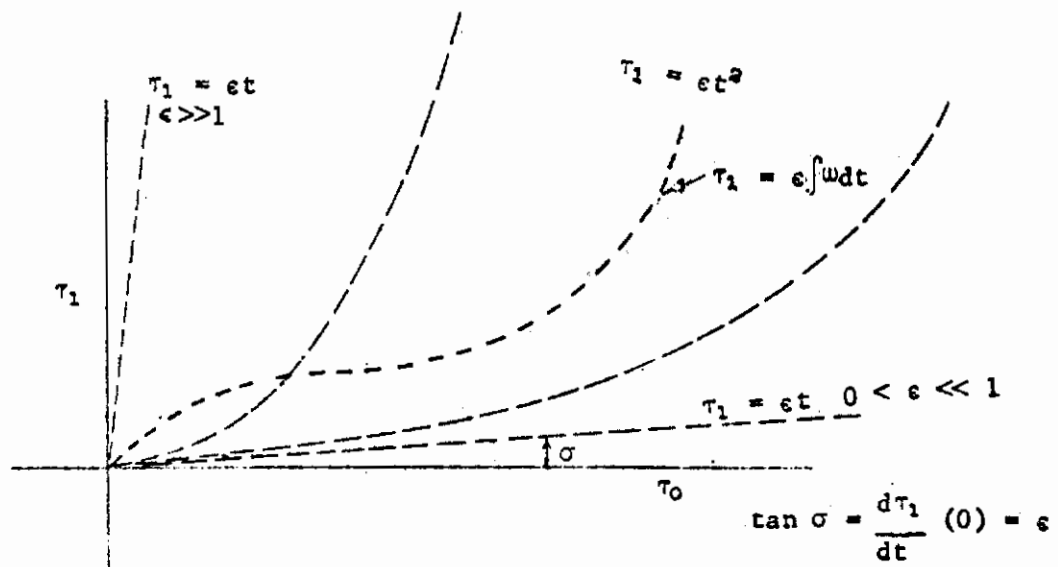
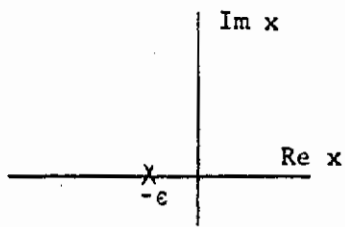
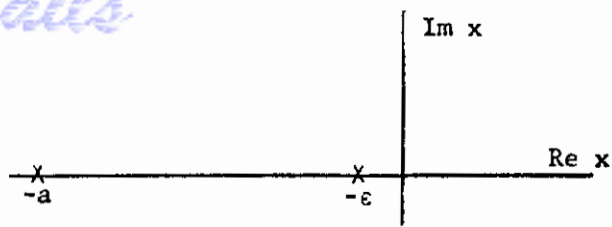

Figure 8. Trajectories for Restriction

Contrails



(a) First Order



(b) Second Order

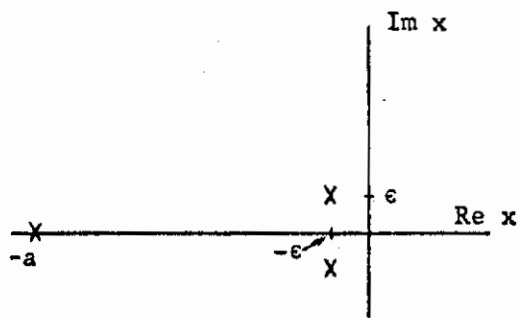

(i)

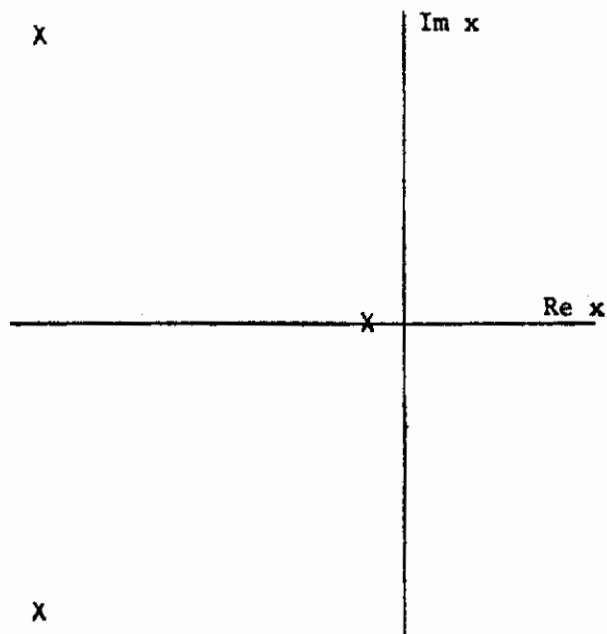

(ii)

(c) Third Order

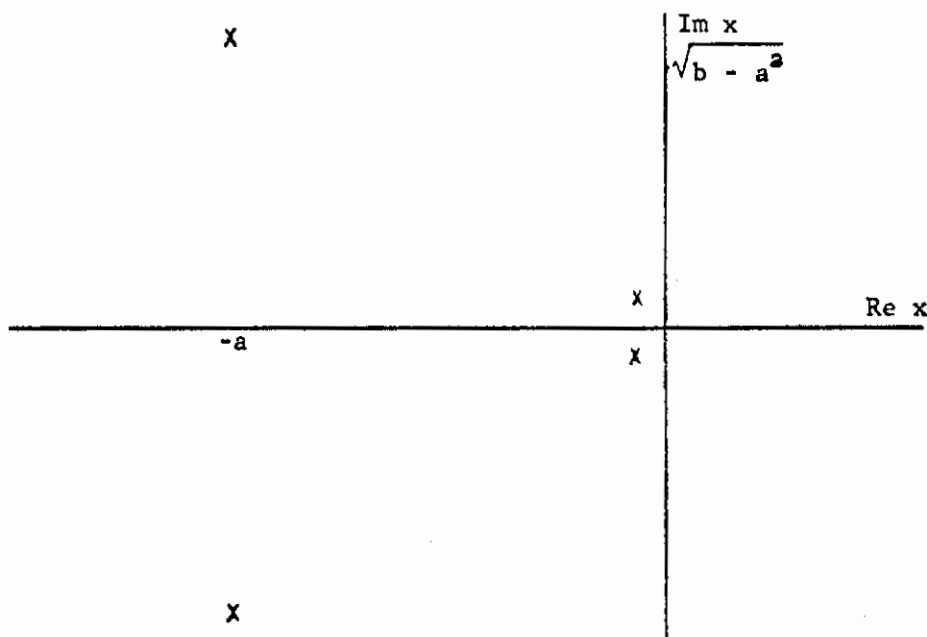

(d) Fourth Order

Figure 9. Root Configuration; Stationary System

Contrails

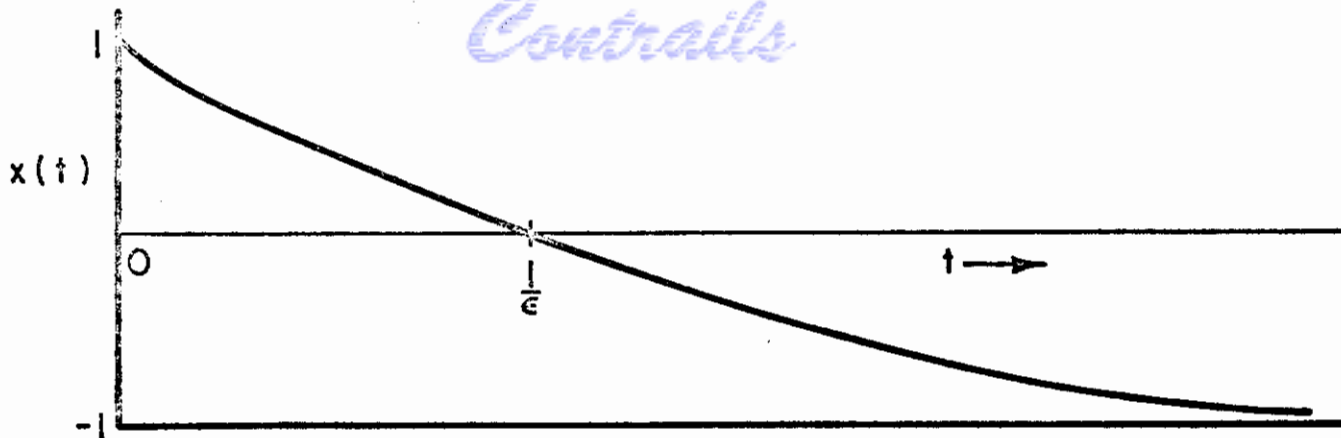

(a) ROOT VARIATION WITH TIME ; $x = \frac{1 - \epsilon t}{1 + \epsilon t}$

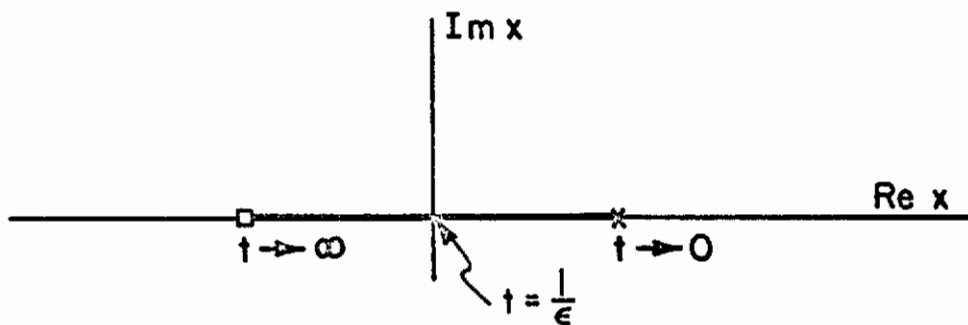

(b) ROOT VARIATION ON COMPLEX PLANE

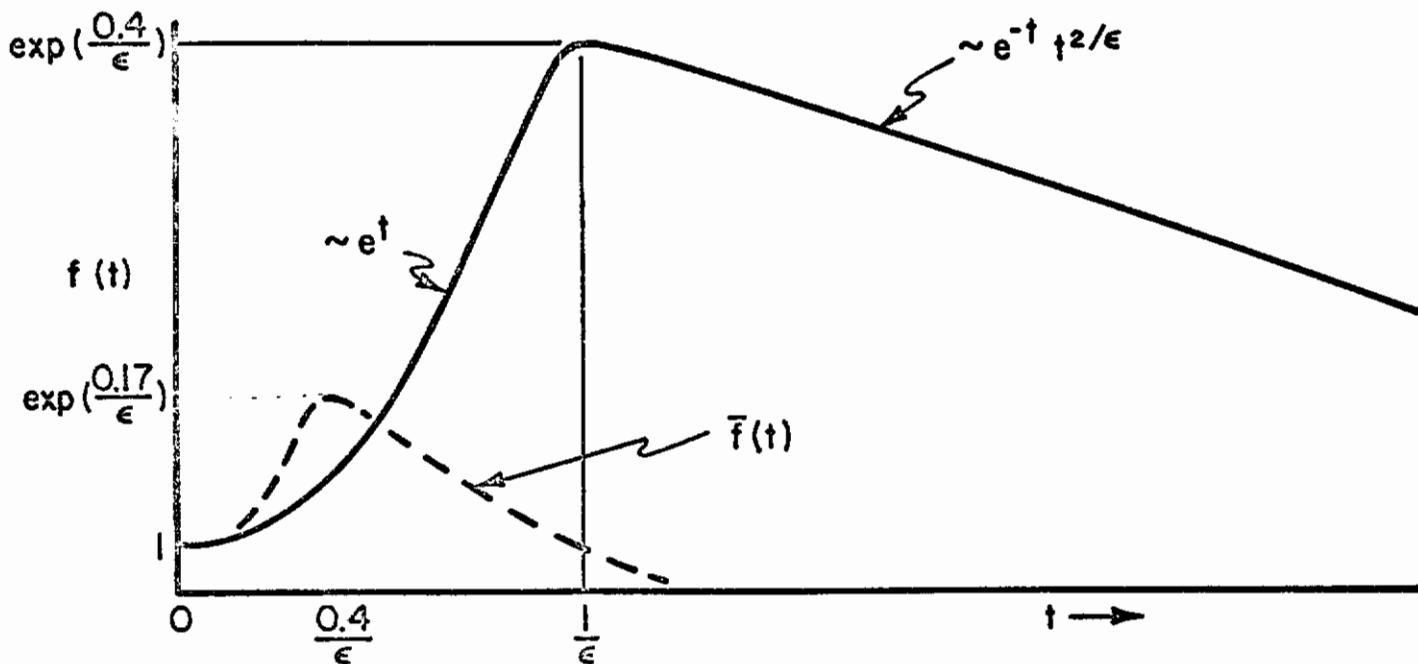

(c) — THE SOLUTION $f(t) = e^{-t} (1 + \epsilon t)^{2/\epsilon}$
 ---- APPROXIMATION $\bar{f}(t) = \exp\left(\left(\frac{1 - \epsilon t}{1 + \epsilon t}\right)t\right)$

FIGURE 10. SIMPLE DYNAMIC MODEL (NOT TO SCALE)

Contrails

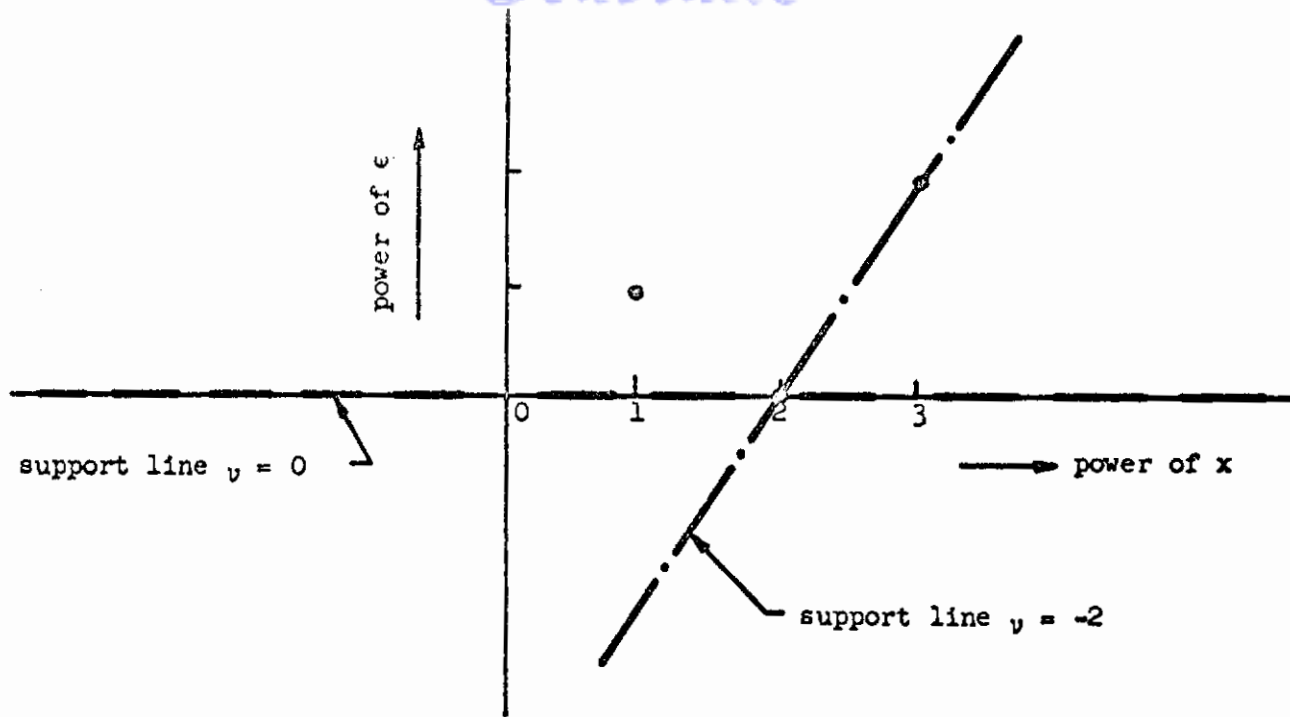

(a) Maximal Balance: $3\epsilon^2 x^3 + x^2 - 8x - 4 = 0; \epsilon \rightarrow 0$

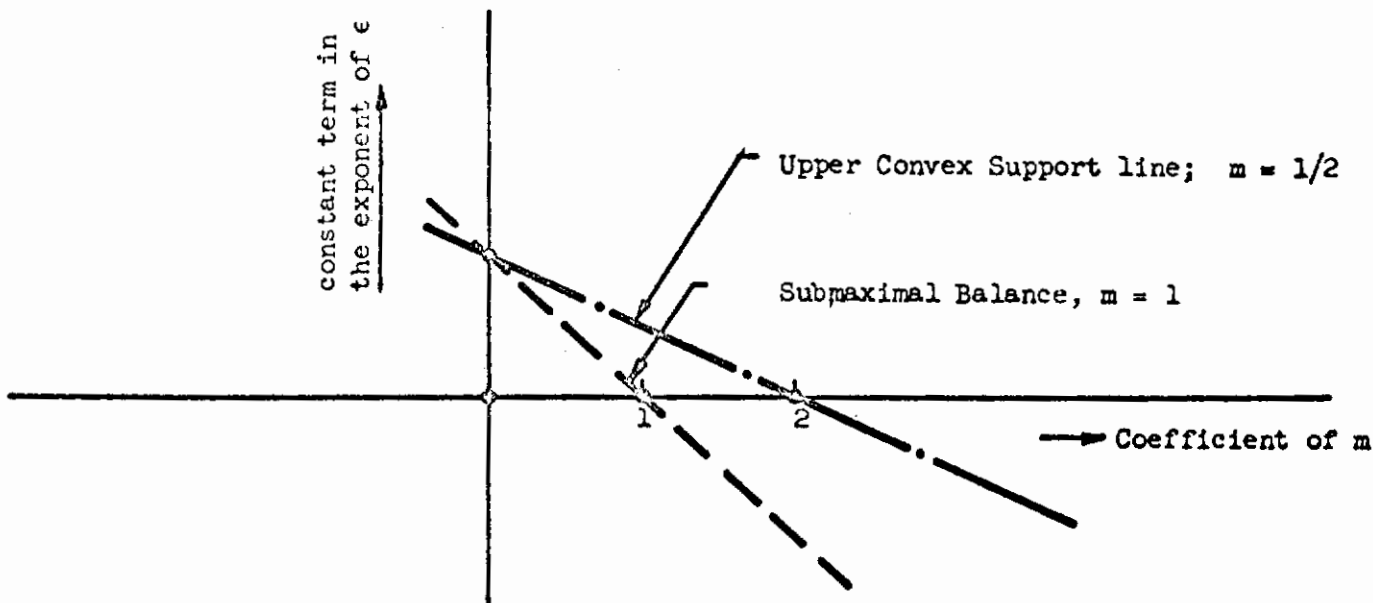

(b) Submaximal Balance: $\gamma'' + \epsilon\omega\gamma = 0$
 $\epsilon^0 () + \epsilon^m () + \epsilon^{2m} () + \epsilon^1 () = 0; \epsilon \rightarrow 0$

Figure 11 Balancing of Terms.

Contrails

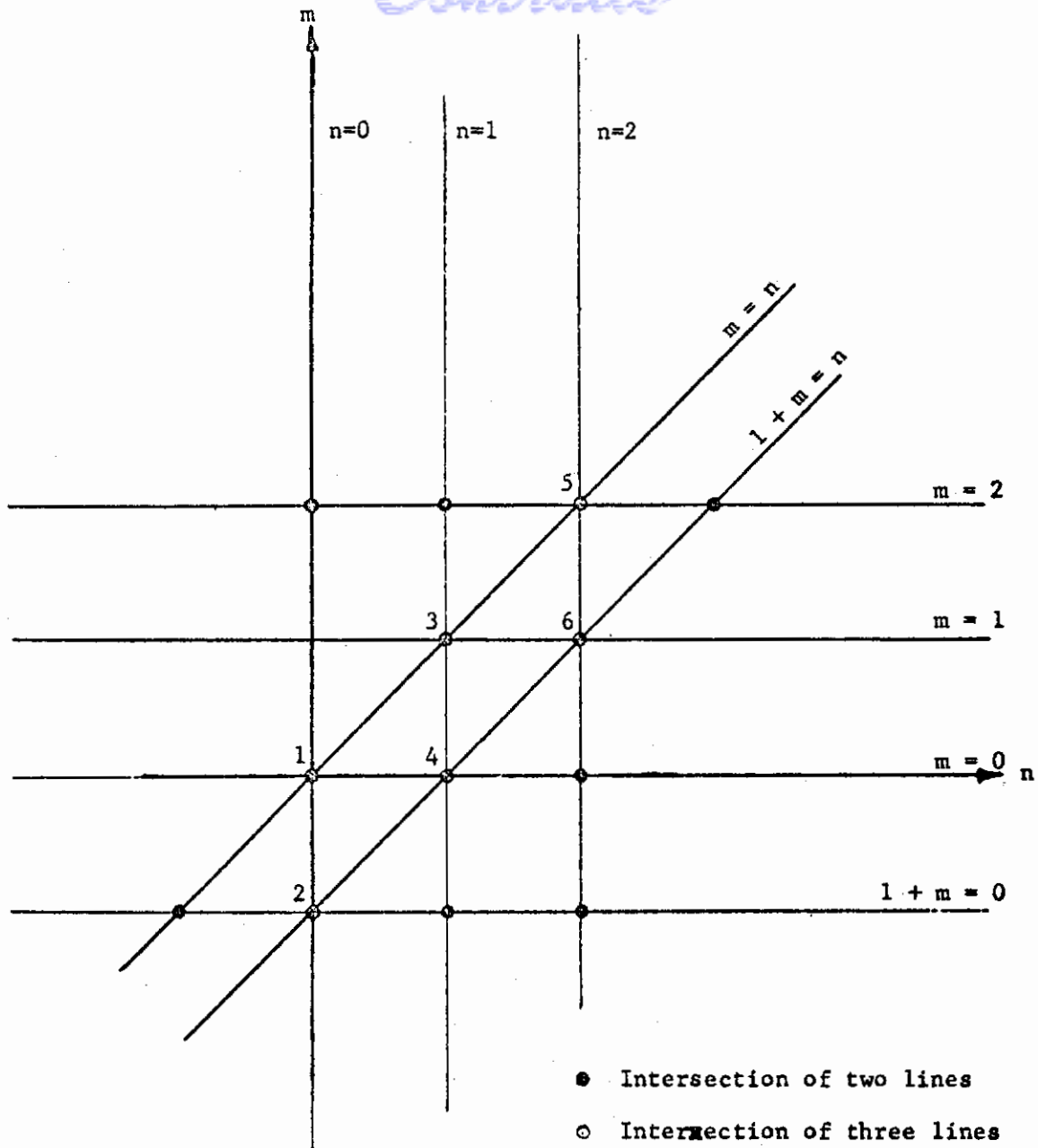

$$(c) \quad y'' + \epsilon^m \omega_1 y' + \epsilon^{11} \omega_0 y = 0$$

FIG. IIc BALANCING OF TERMS

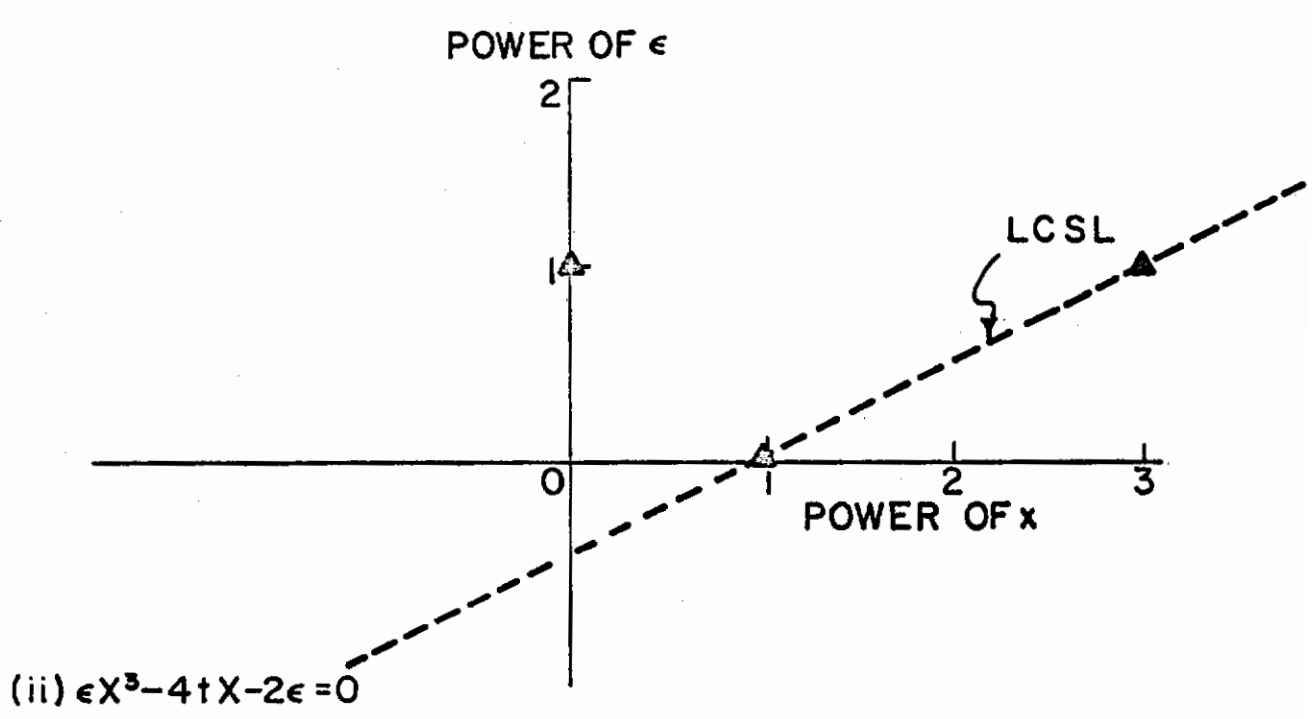
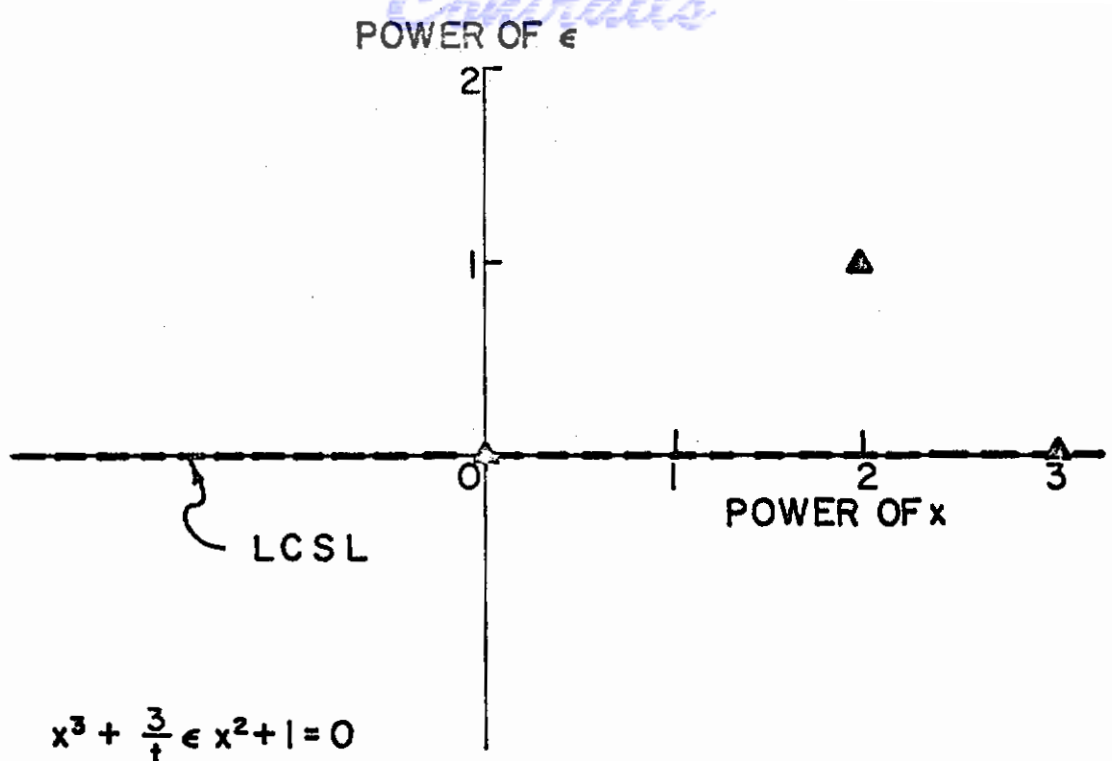

LCSL = LOWER CONVEX SUPPORT LINE

FIG. 12 MAX. BALANCE FOR ROOTS AS $\epsilon \rightarrow 0$

Contrails

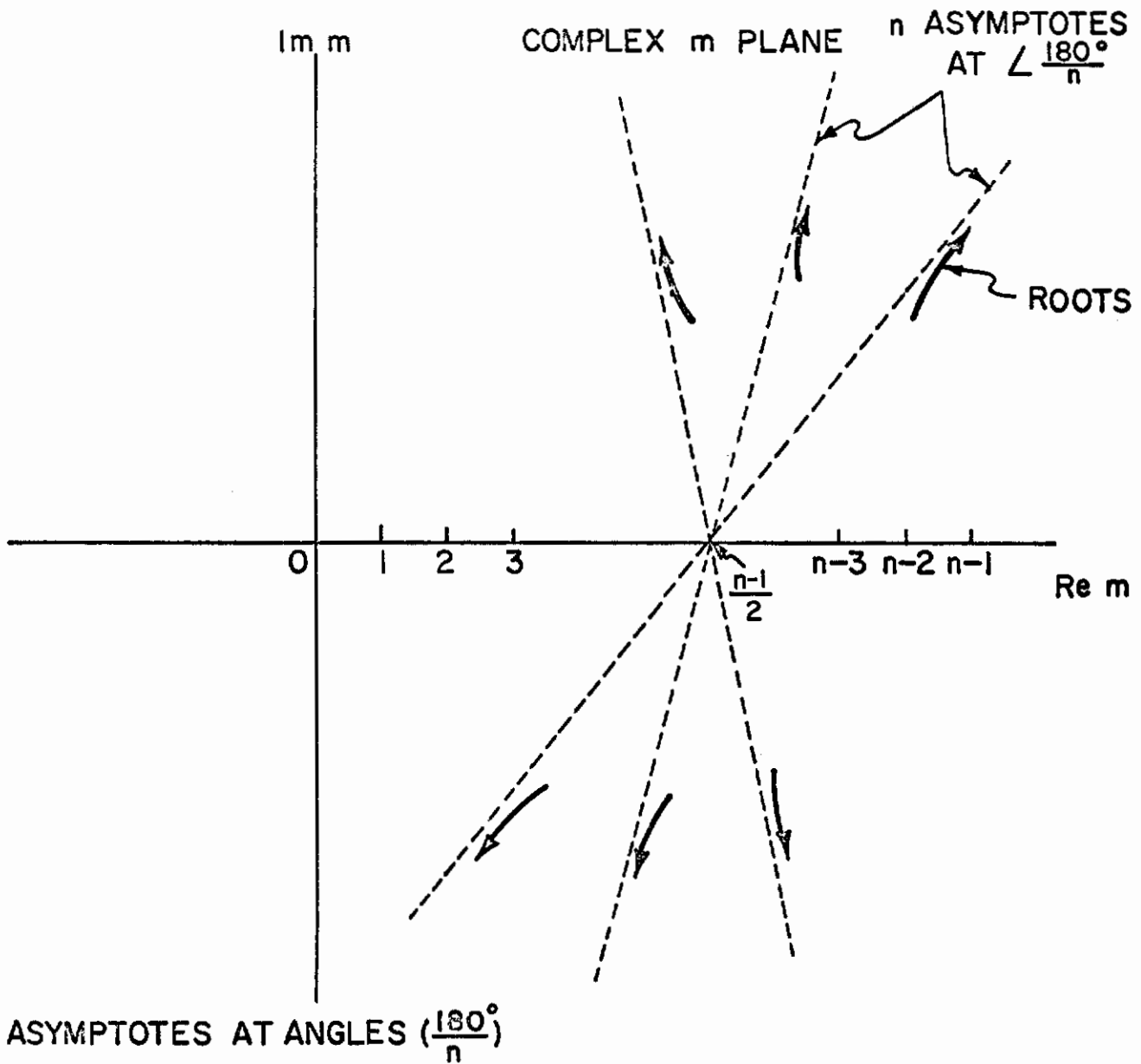

$$\text{C. G. OF ASYMPTOTES} = \frac{\sum \text{poles}}{\# \text{poles}} = \left(\frac{1+2+3+\dots+n-1}{n} \right) = \frac{(n-1)(n-1+1)}{2n} = \left(\frac{n-1}{2} \right)$$

FIGURE 13 ROOT LOCUS $Y^{(n)} + \left(\frac{\epsilon}{T}\right)^n Y = 0$

Contrails

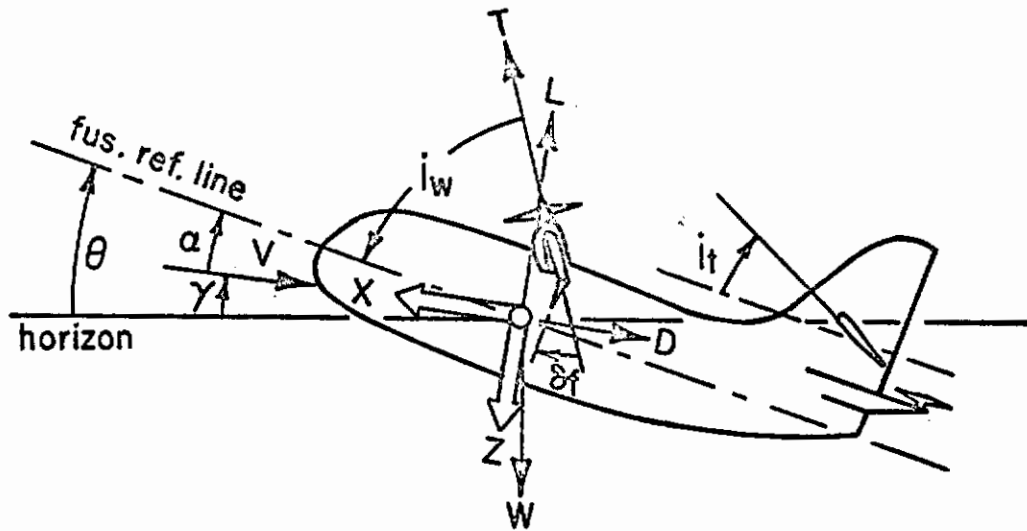

FIG. 14 AXIS SYSTEM AND NOTATION

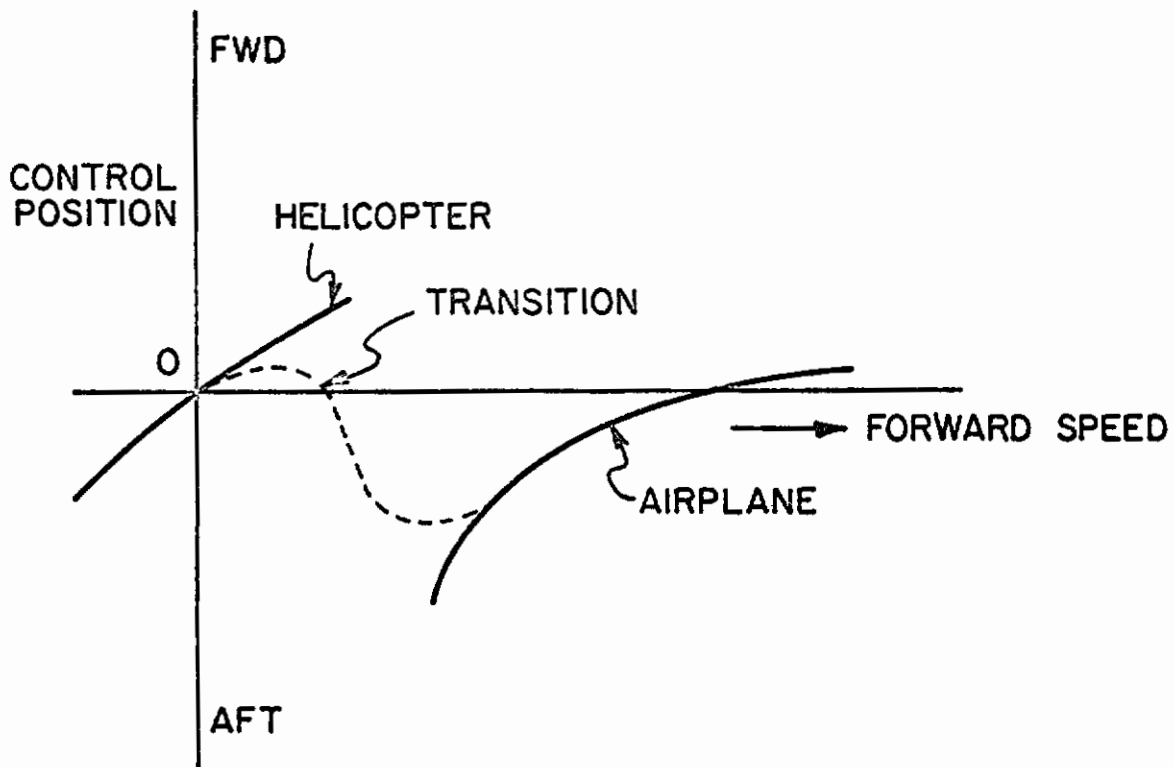

FIG. 15 VTOL CONTROL FOR TRIM vs. SPEED

EQUATIONS

$$\begin{aligned}
 u' + a_1 u + g\theta &= 0 & 1(u', \theta) \\
 w' + b_1 w + b_2 u - v\theta' &= 0 & 2(w', u, \theta') \\
 \theta'' + c_1 \theta' + c_2 u + c_4 w &= 0 & 3(\theta'', u, w)
 \end{aligned}$$

FLOW CHART : $D \equiv \frac{d}{dt}$; SUBSCRIPT INDICATES SUBSTITUTION

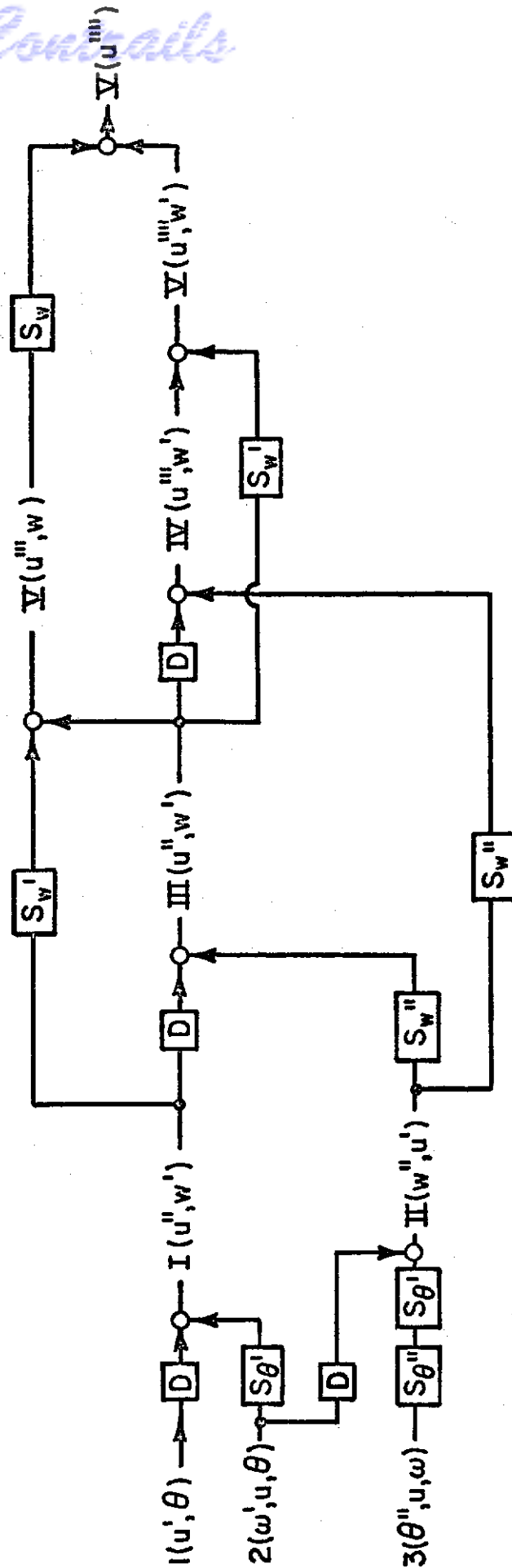

FIG. 16 DECOUPLING SCHEMATIC FOR VTOL EQUATIONS

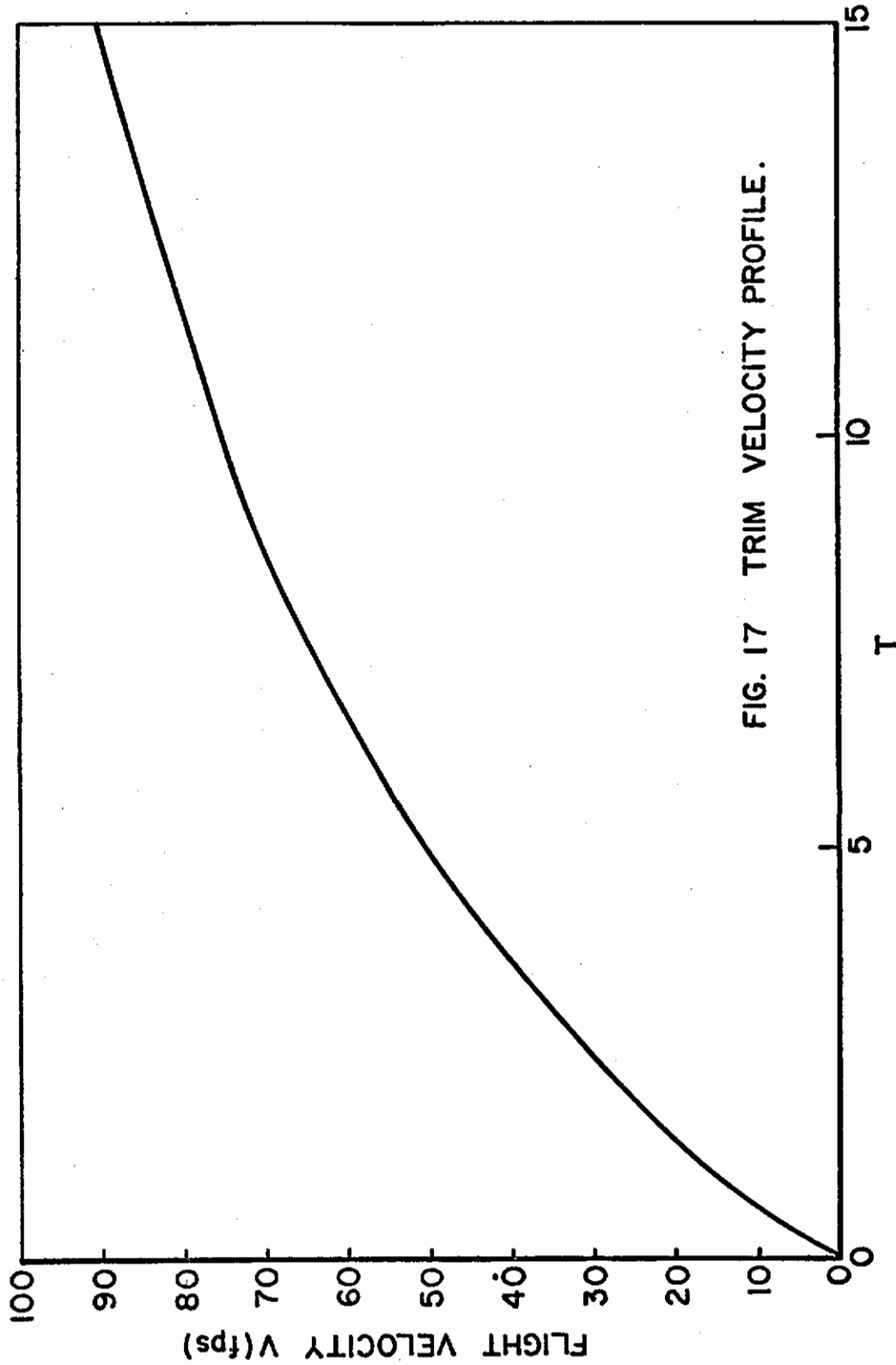

FIG. 17 TRIM VELOCITY PROFILE.

Controls

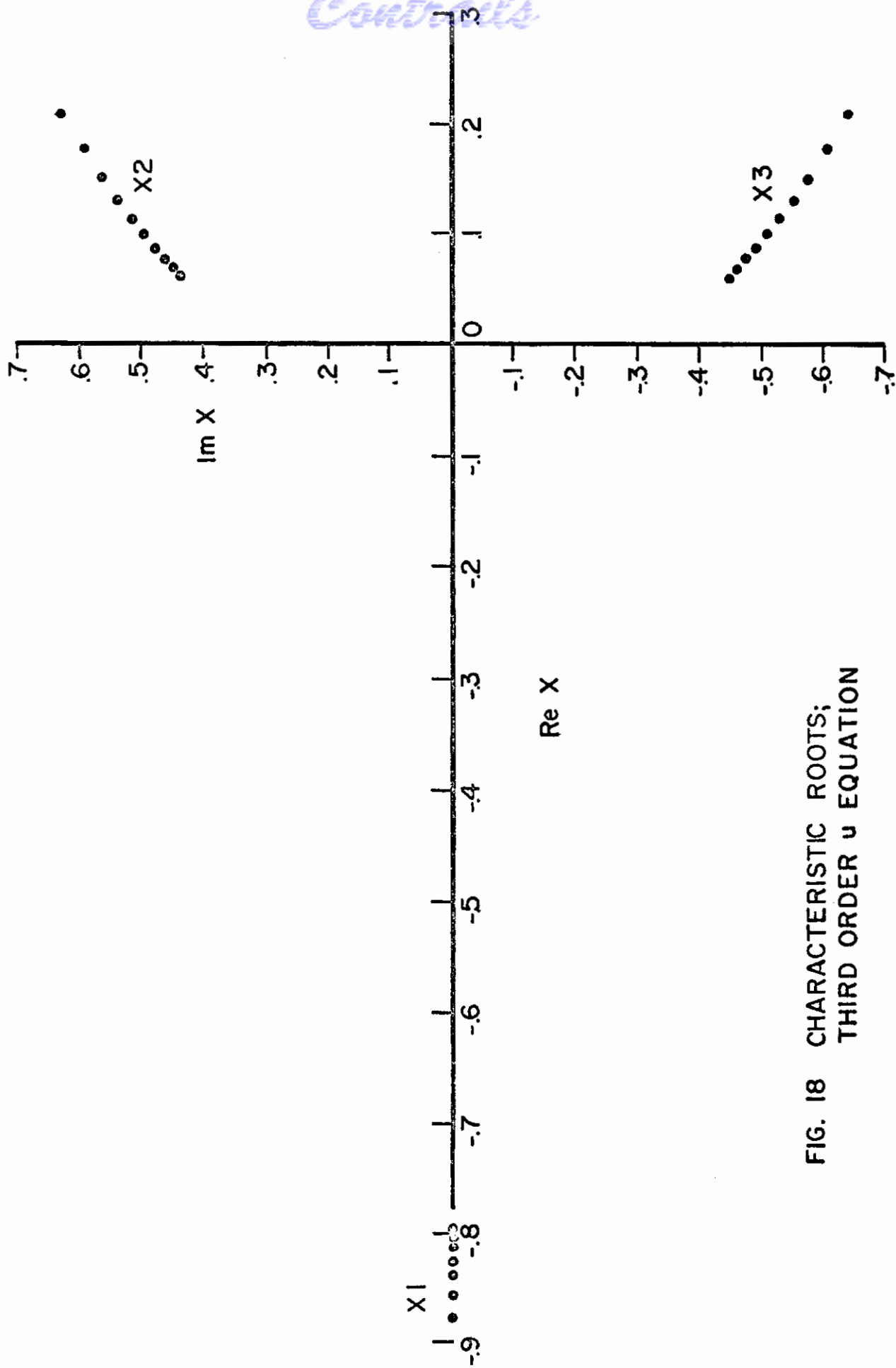

FIG. 18 CHARACTERISTIC ROOTS;
THIRD ORDER u EQUATION

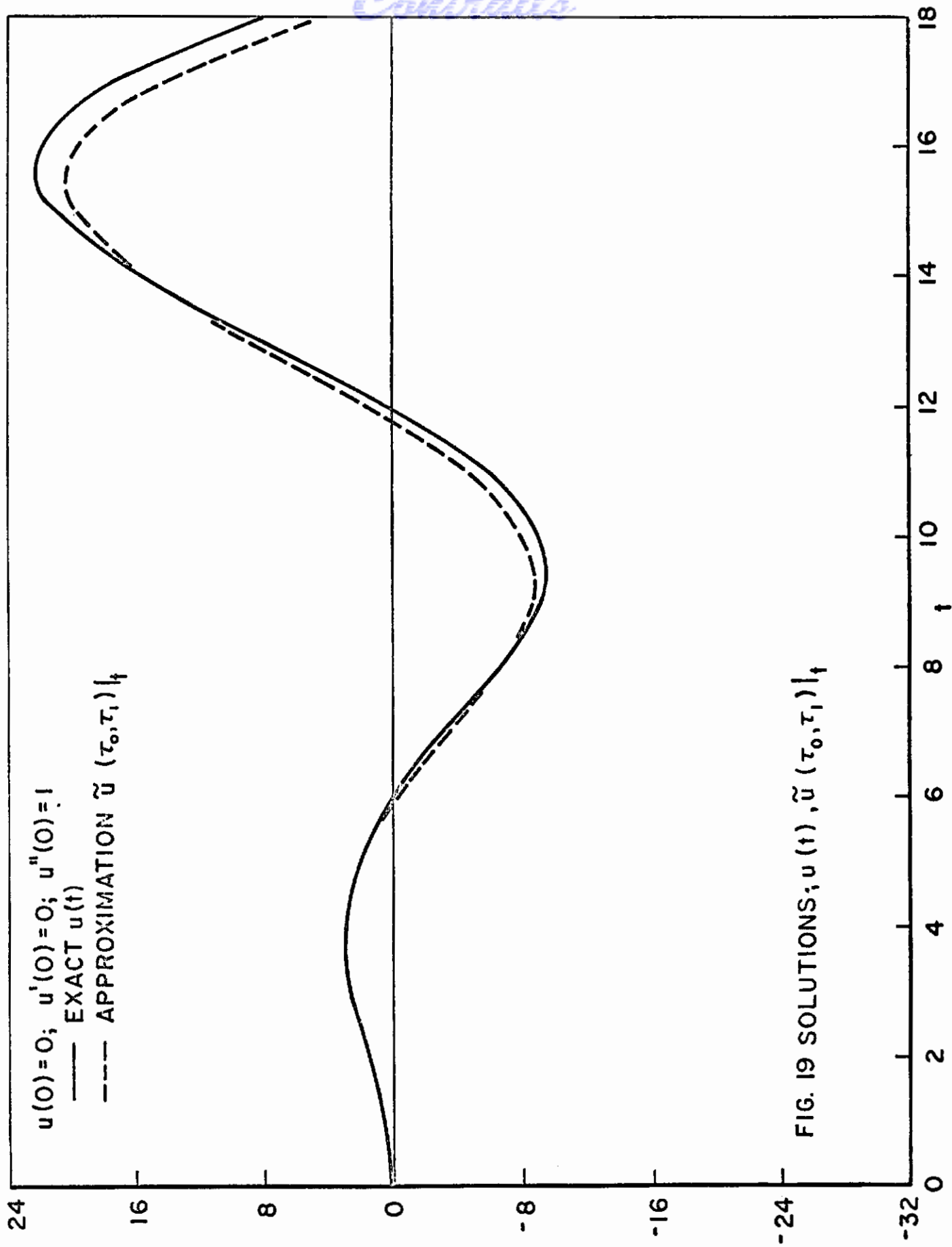

FIG. 19 SOLUTIONS; $u(t), \tilde{u}(\tau_0, \tau_1)|_t$

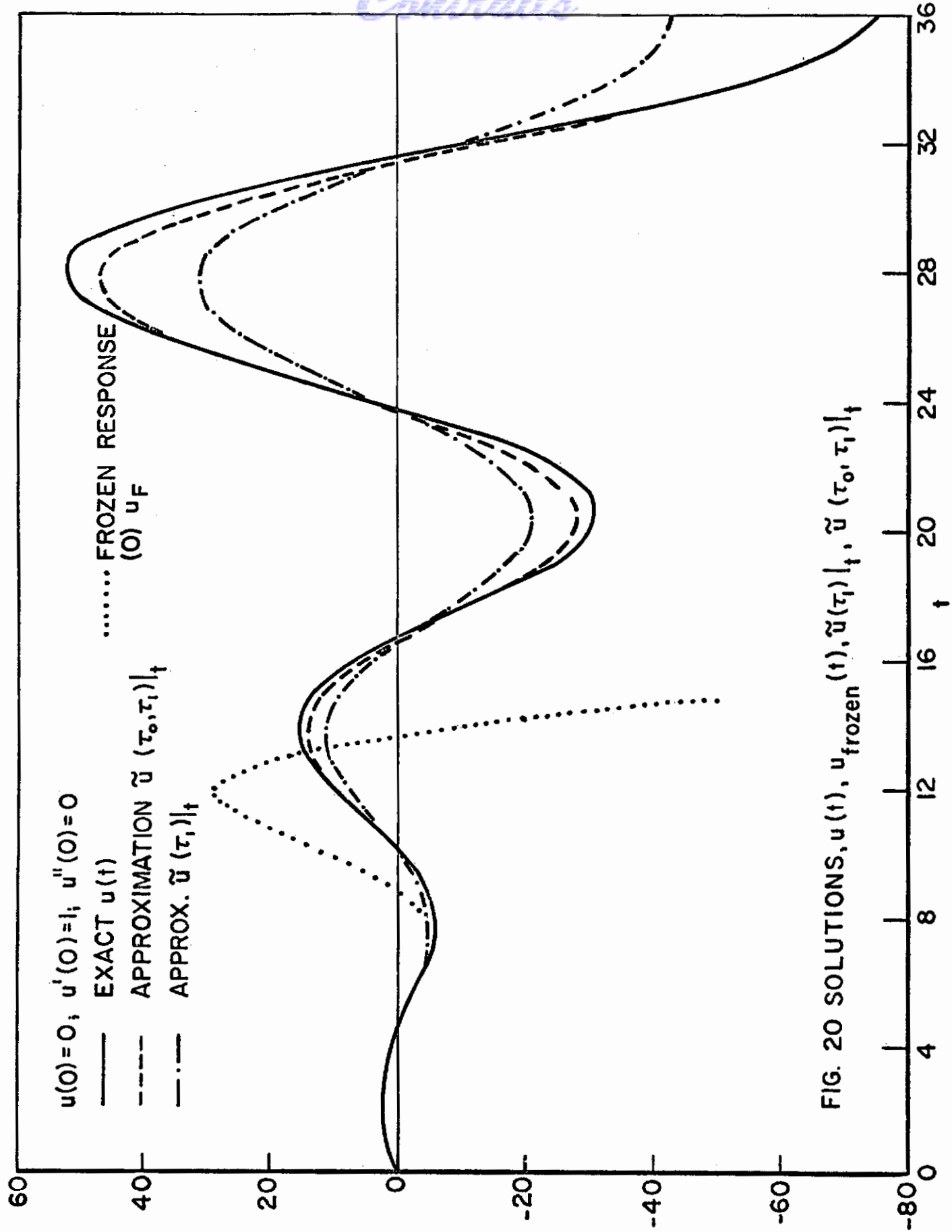

FIG. 20 SOLUTIONS, $u(t), u_{frozen}(t), \tilde{u}(\tau_1)|_t, \tilde{u}(\tau_0, \tau_1)|_t$

Contrails

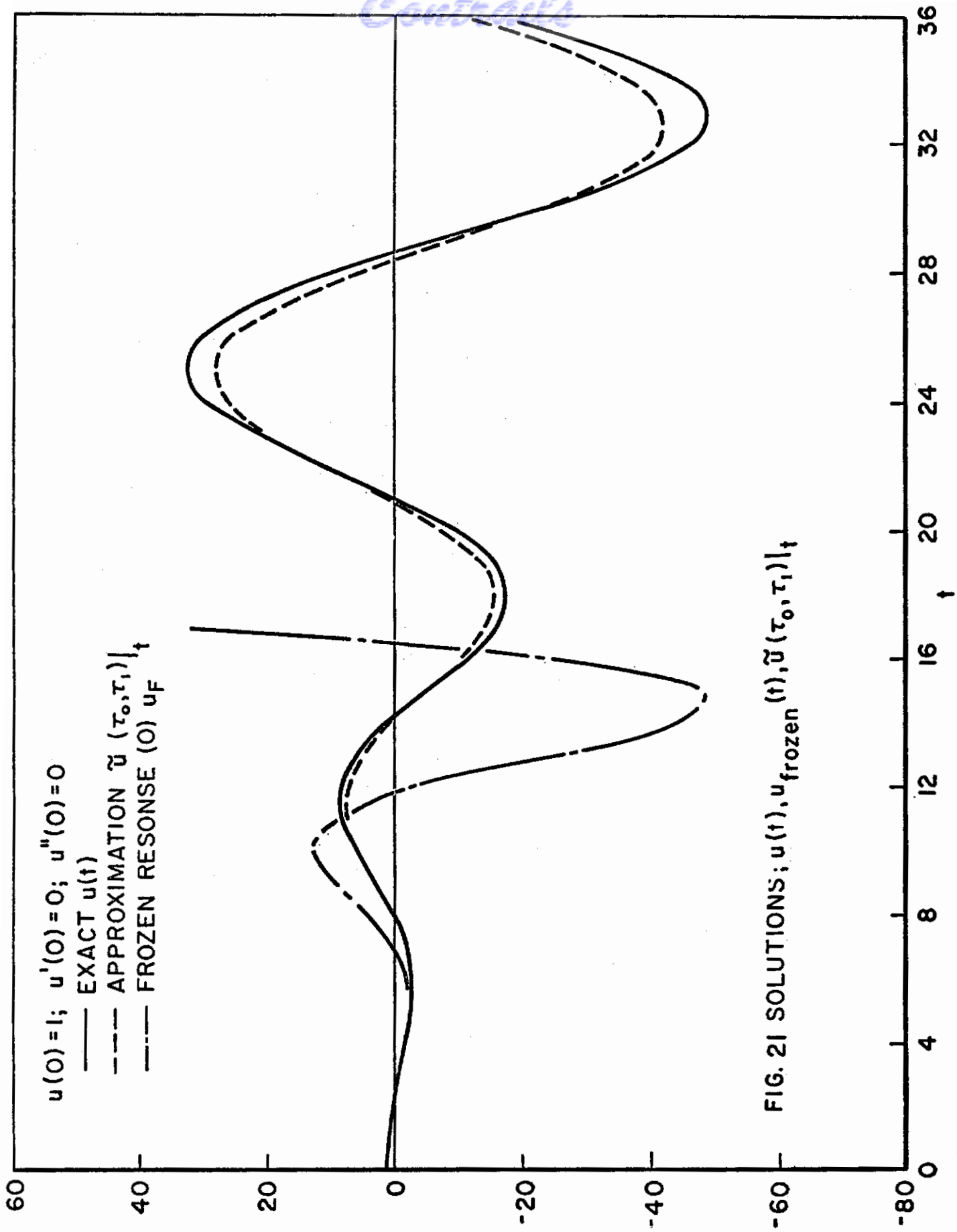

FIG. 21 SOLUTIONS; $u(t), u_{\text{frozen}}(t), \tilde{u}(t, \tau_0, \tau_1)$

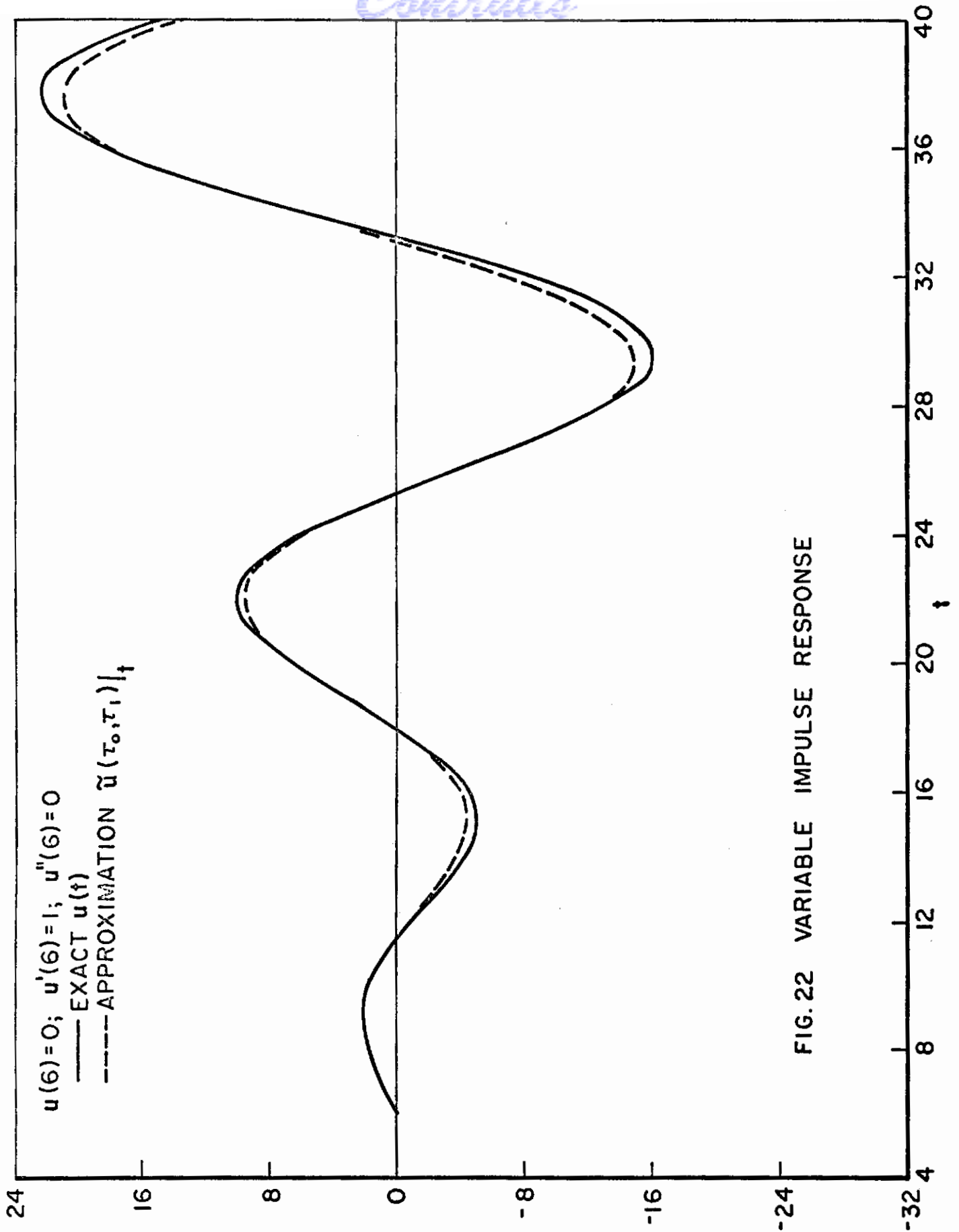

FIG. 22 VARIABLE IMPULSE RESPONSE

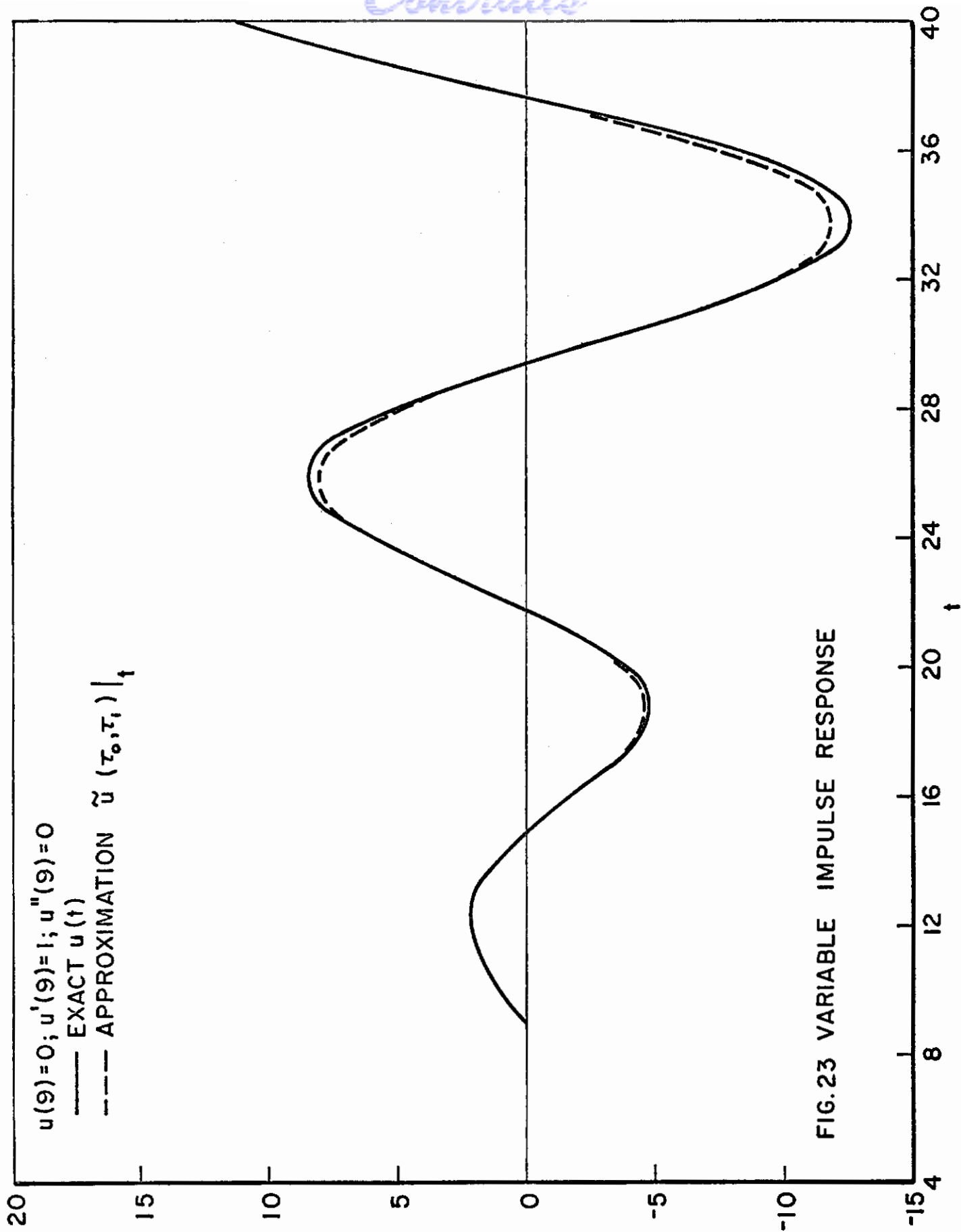

FIG.23 VARIABLE IMPULSE RESPONSE

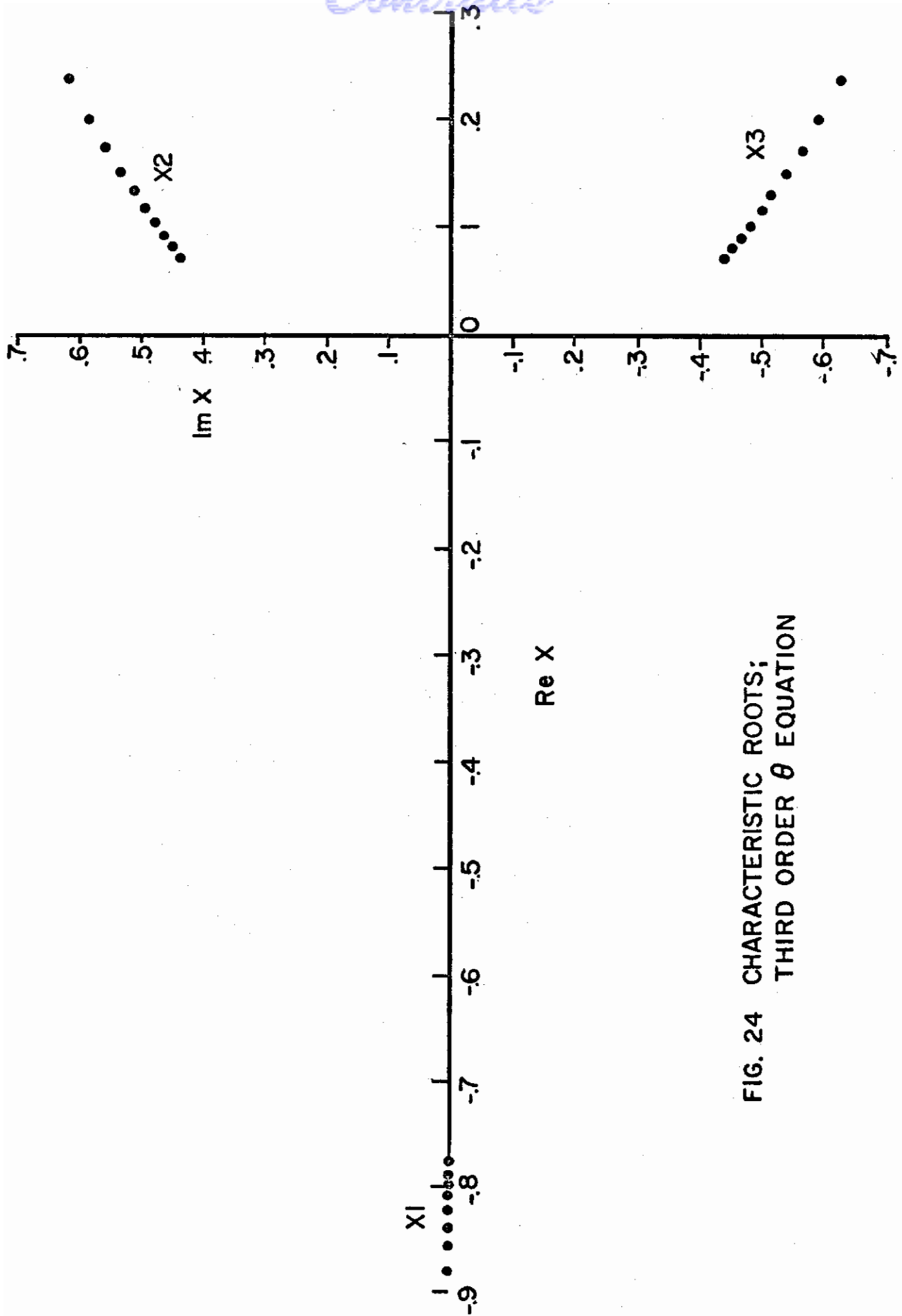
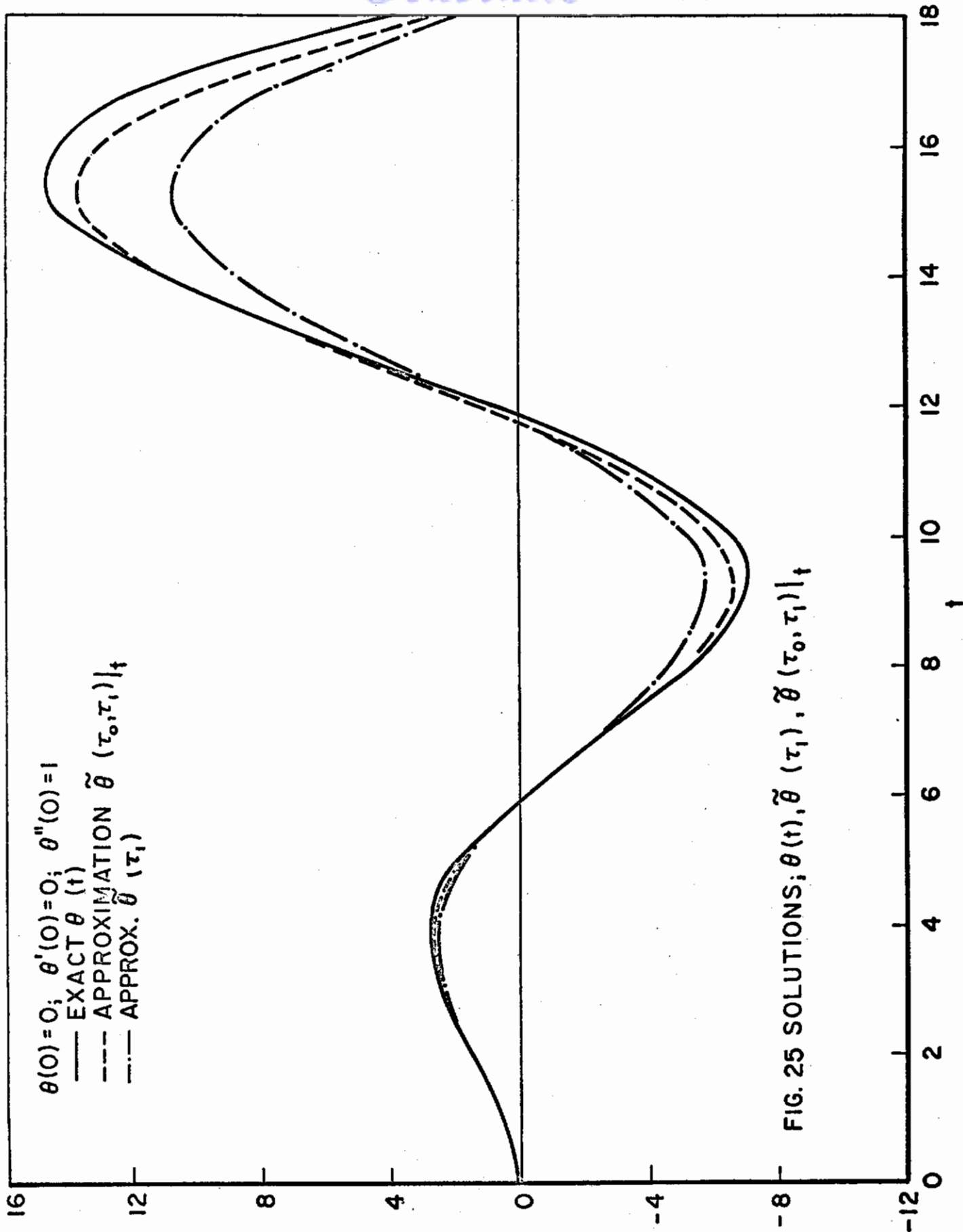

FIG. 24 CHARACTERISTIC ROOTS;
THIRD ORDER θ EQUATION



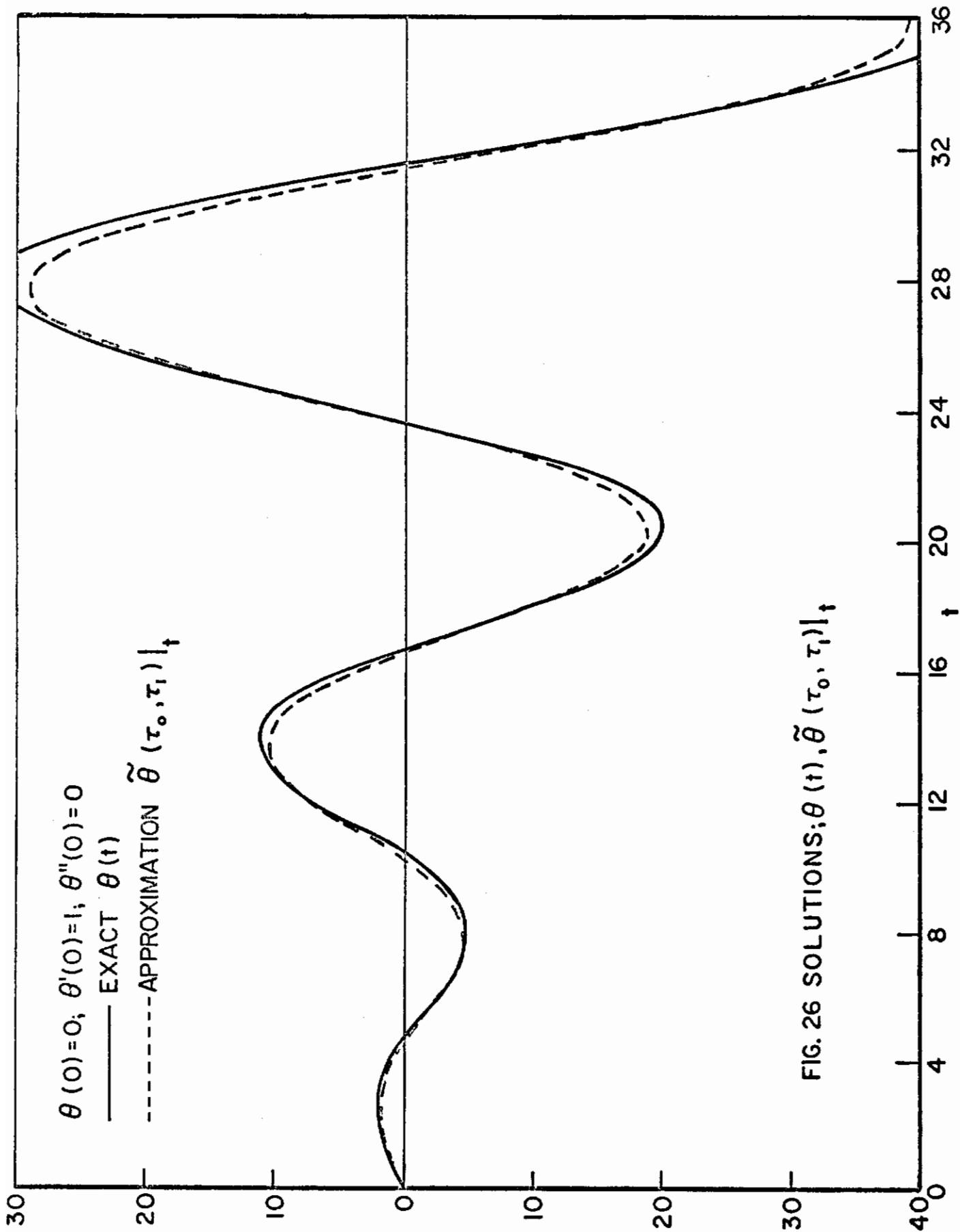

FIG. 26 SOLUTIONS; $\theta(t), \tilde{\theta}(\tau_0, \tau_1)|_t$

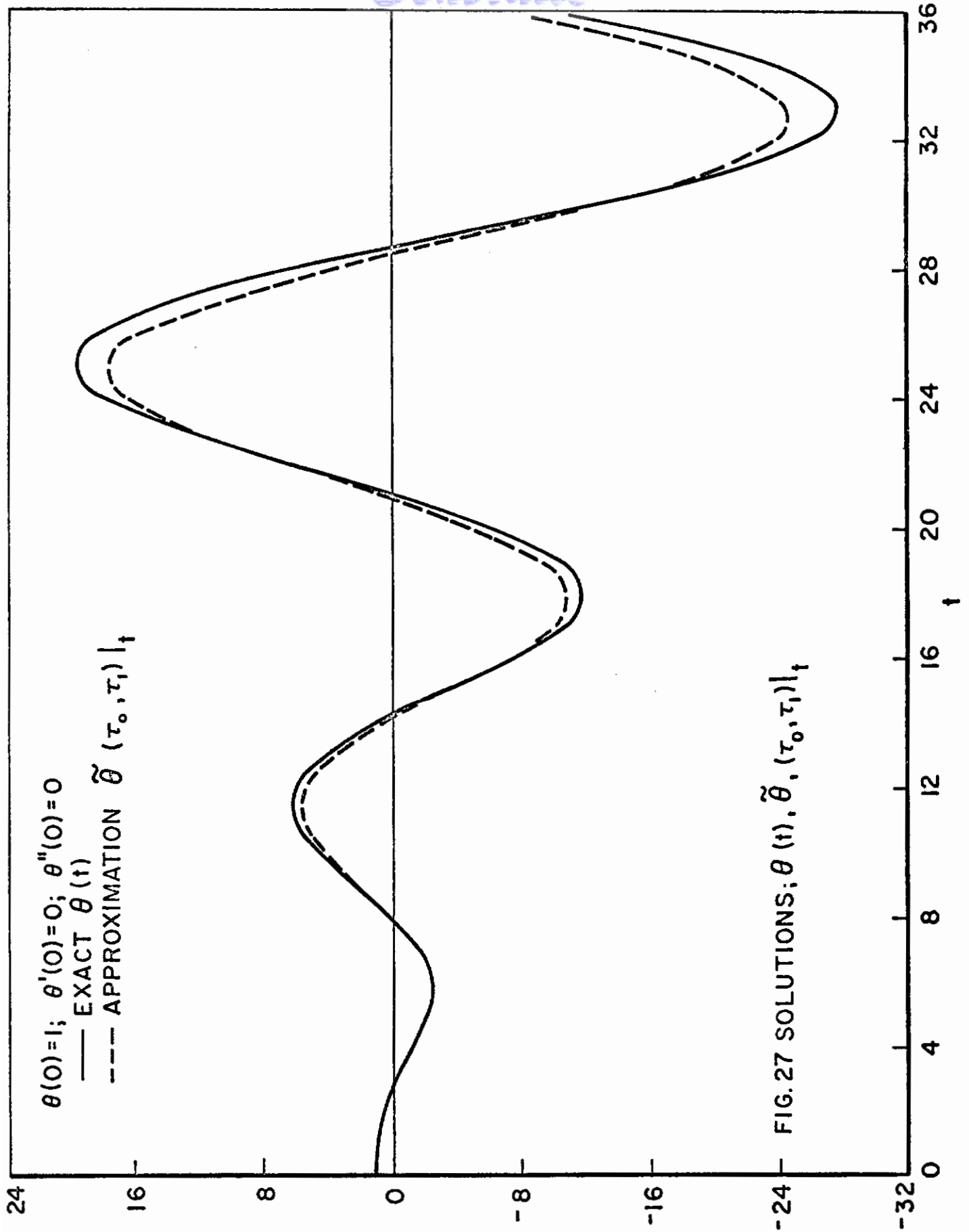
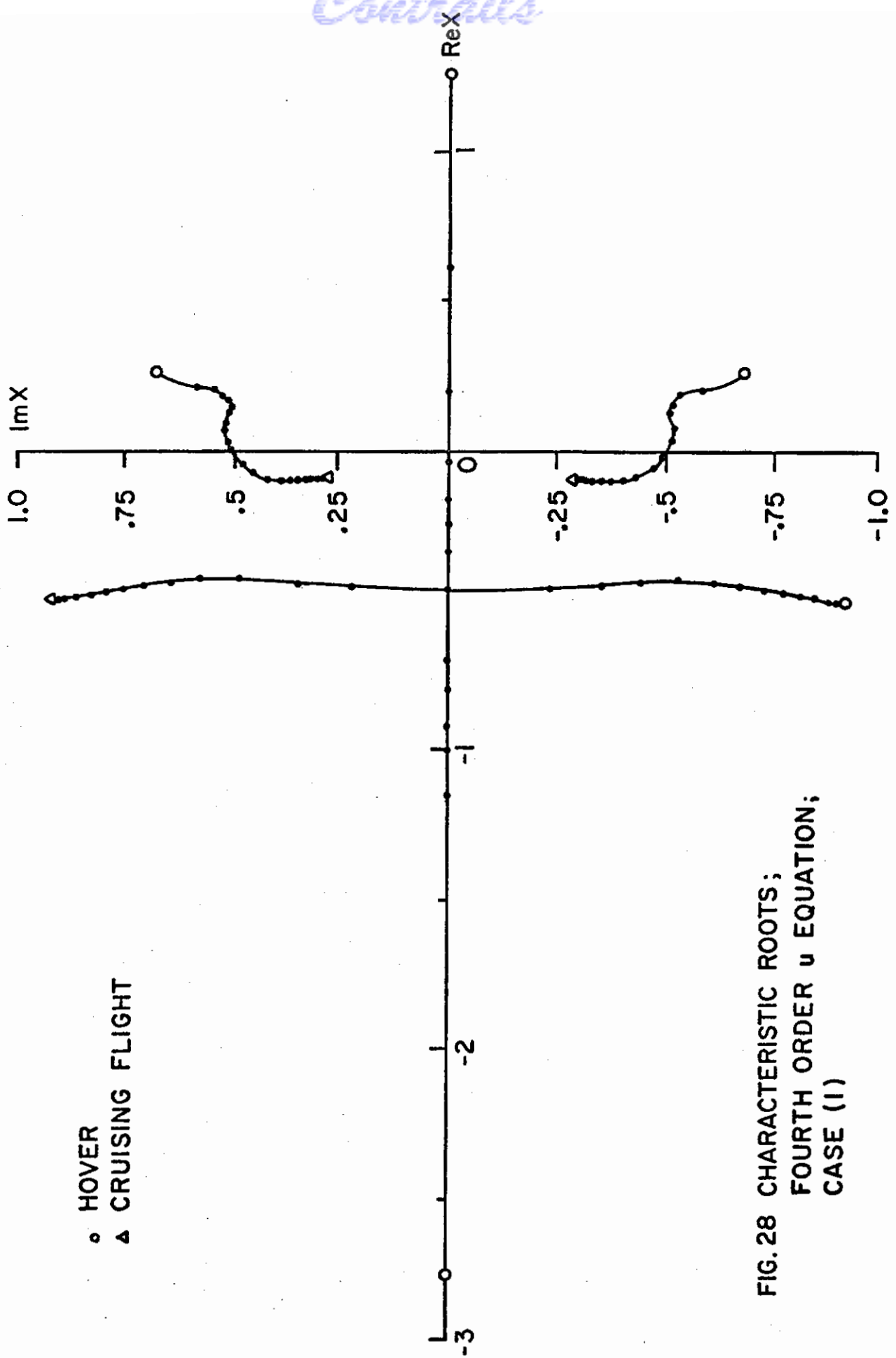
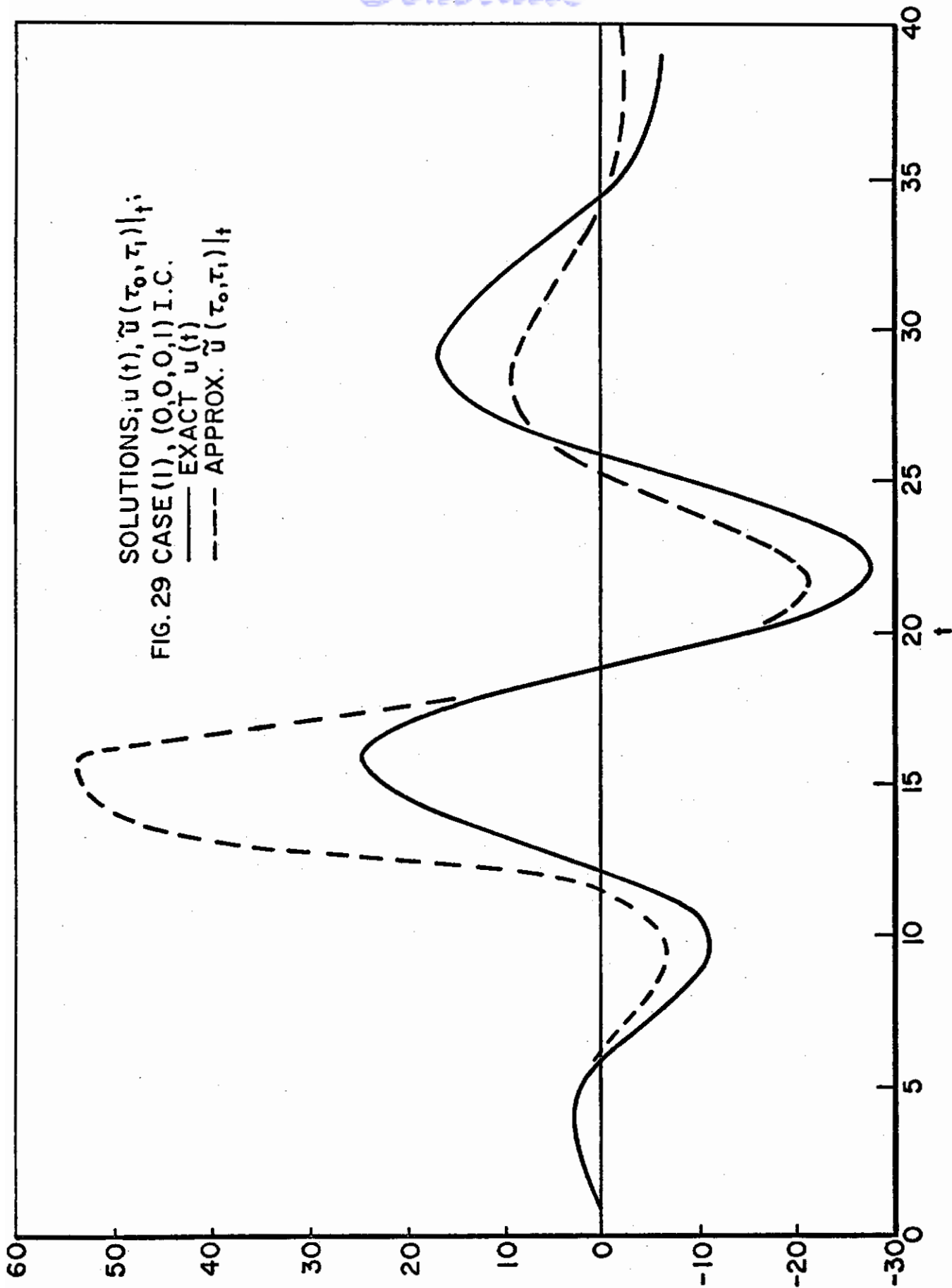

FIG.27 SOLUTIONS; $\theta(t), \tilde{\theta}(t, \tau_0, \tau_1)$



○ HOVER
△ CRUISING FLIGHT

FIG. 28 CHARACTERISTIC ROOTS;
FOURTH ORDER u EQUATION;
CASE (I)



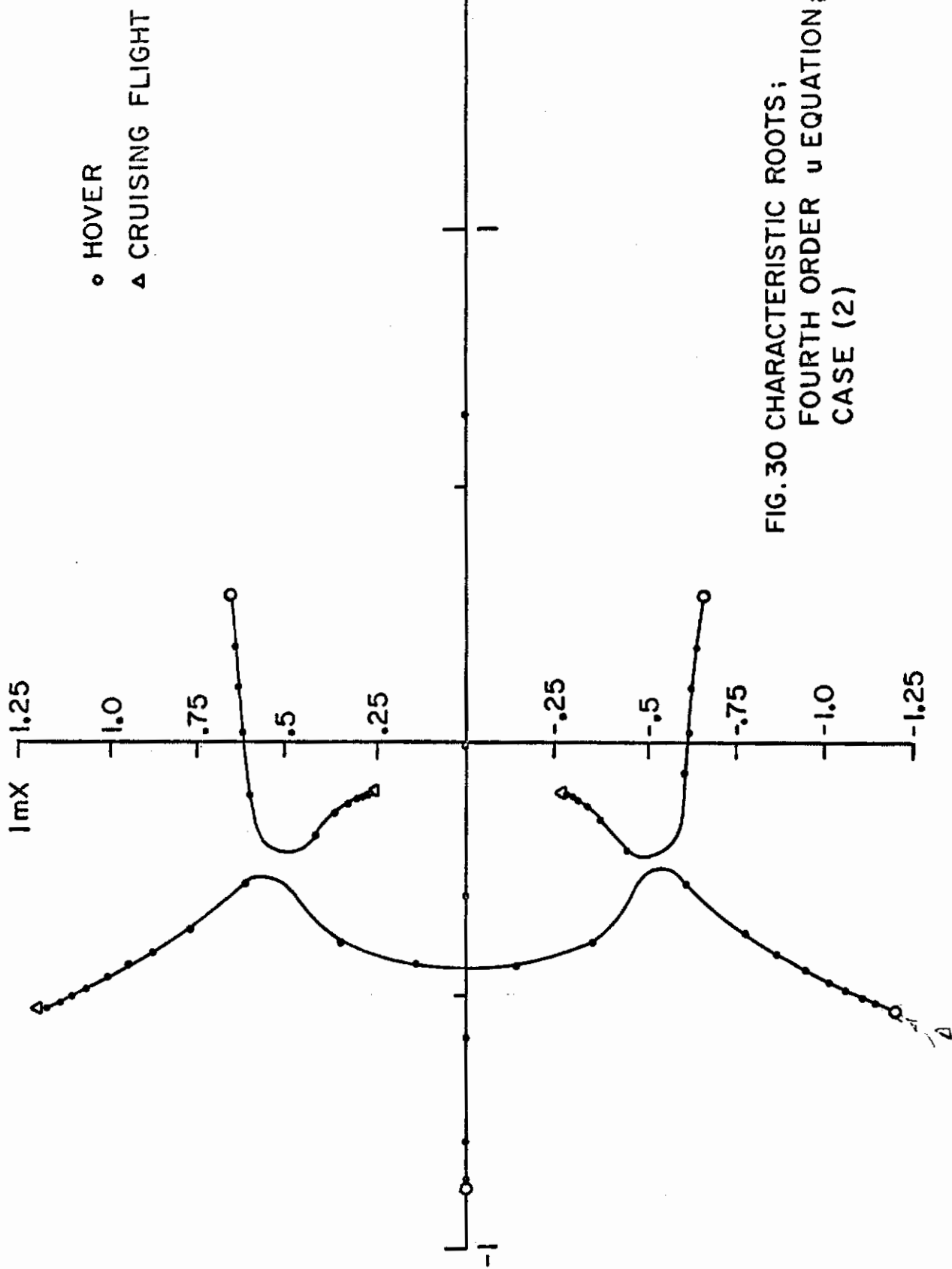
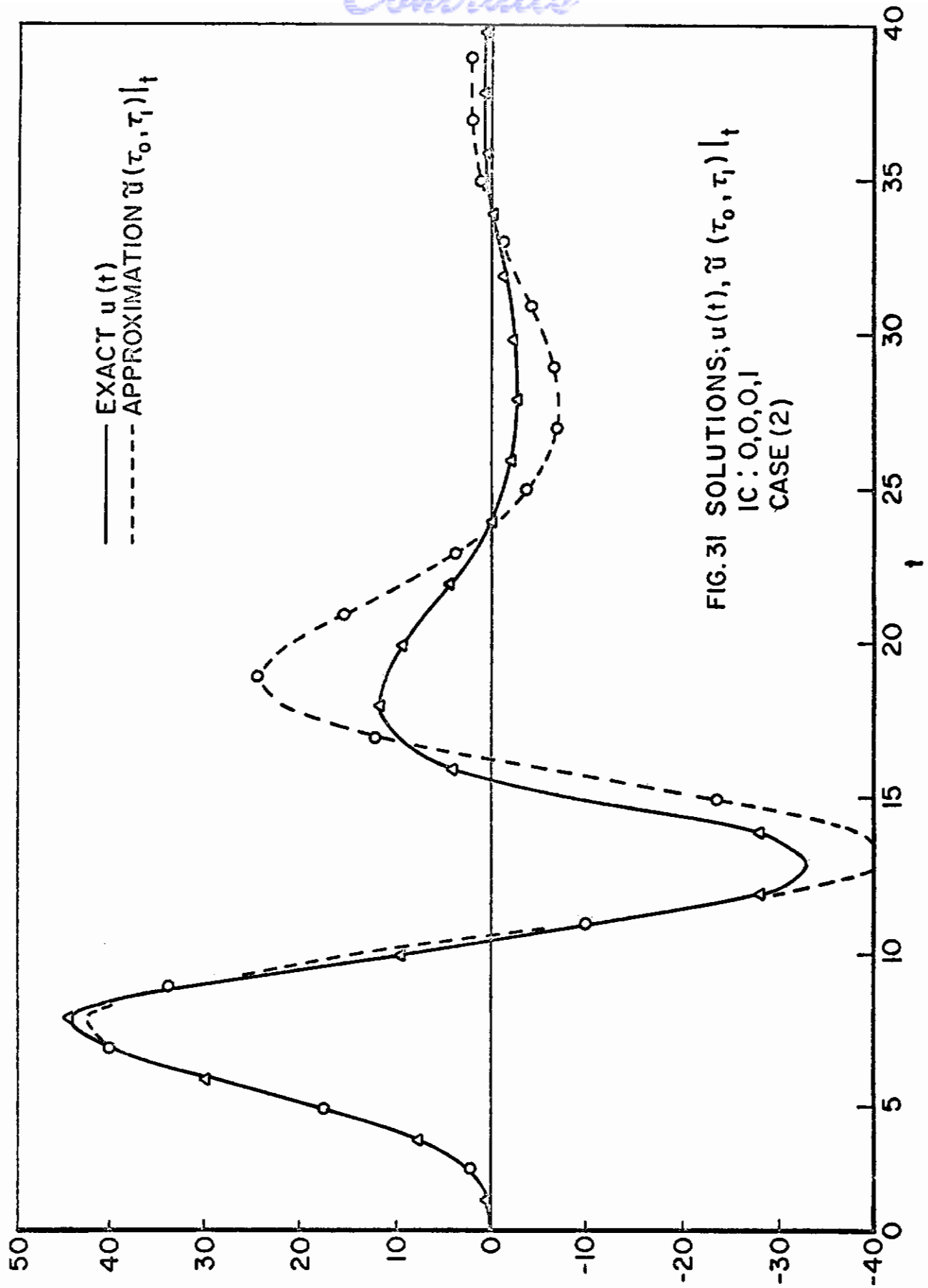
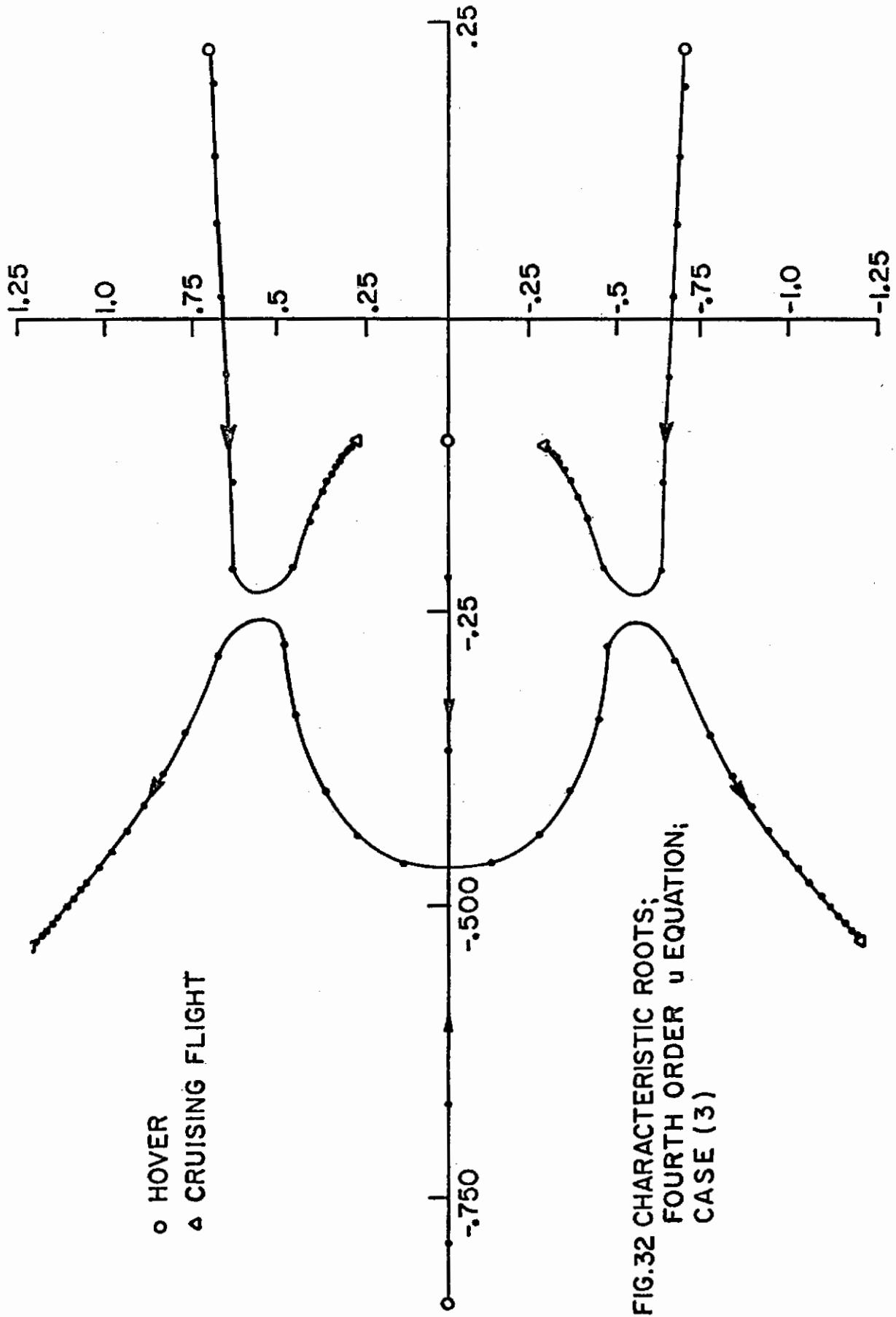
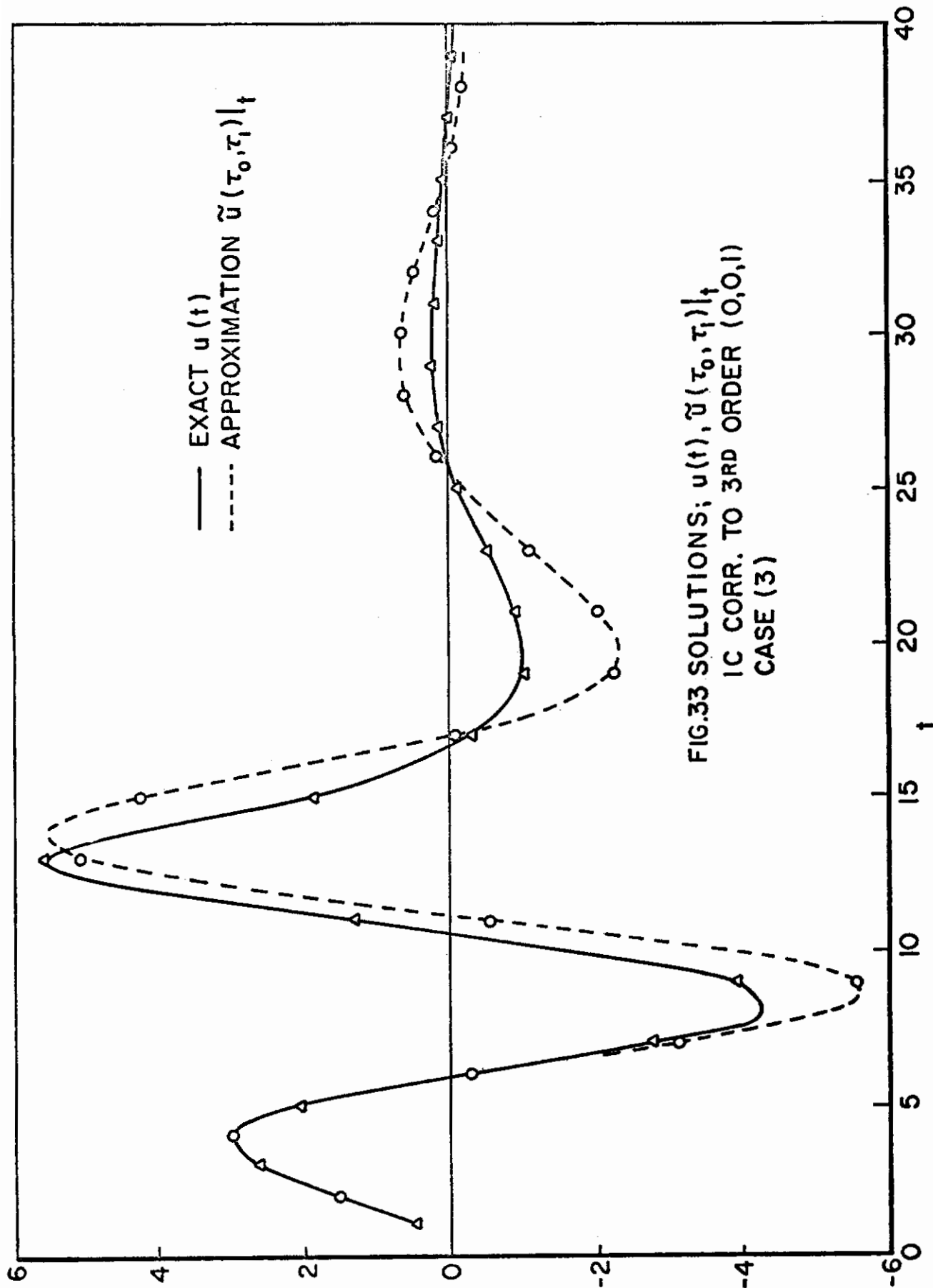
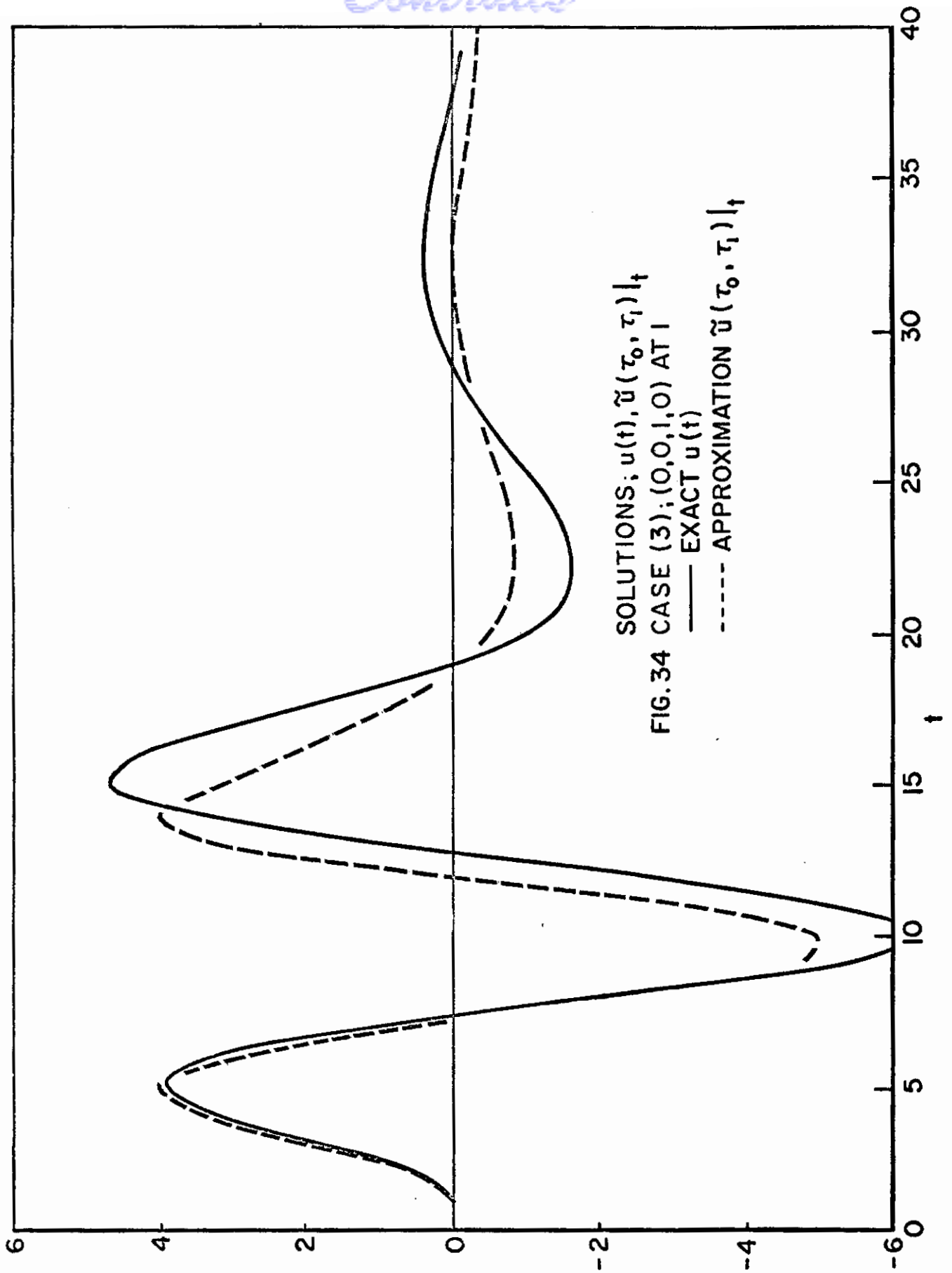

FIG. 30 CHARACTERISTIC ROOTS;
FOURTH ORDER μ EQUATION;
CASE (2)









○ HOVER
▲ CRUISING

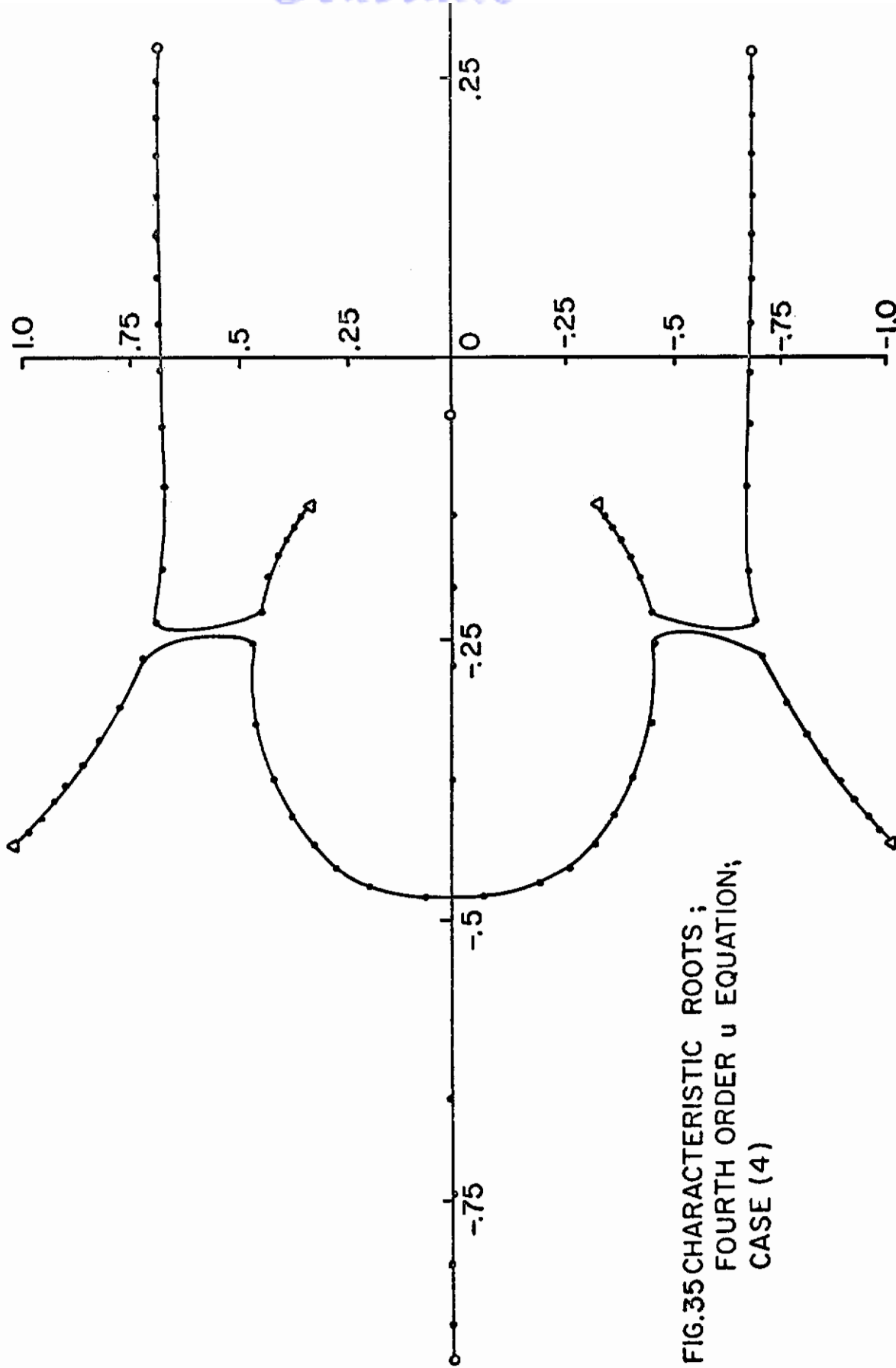
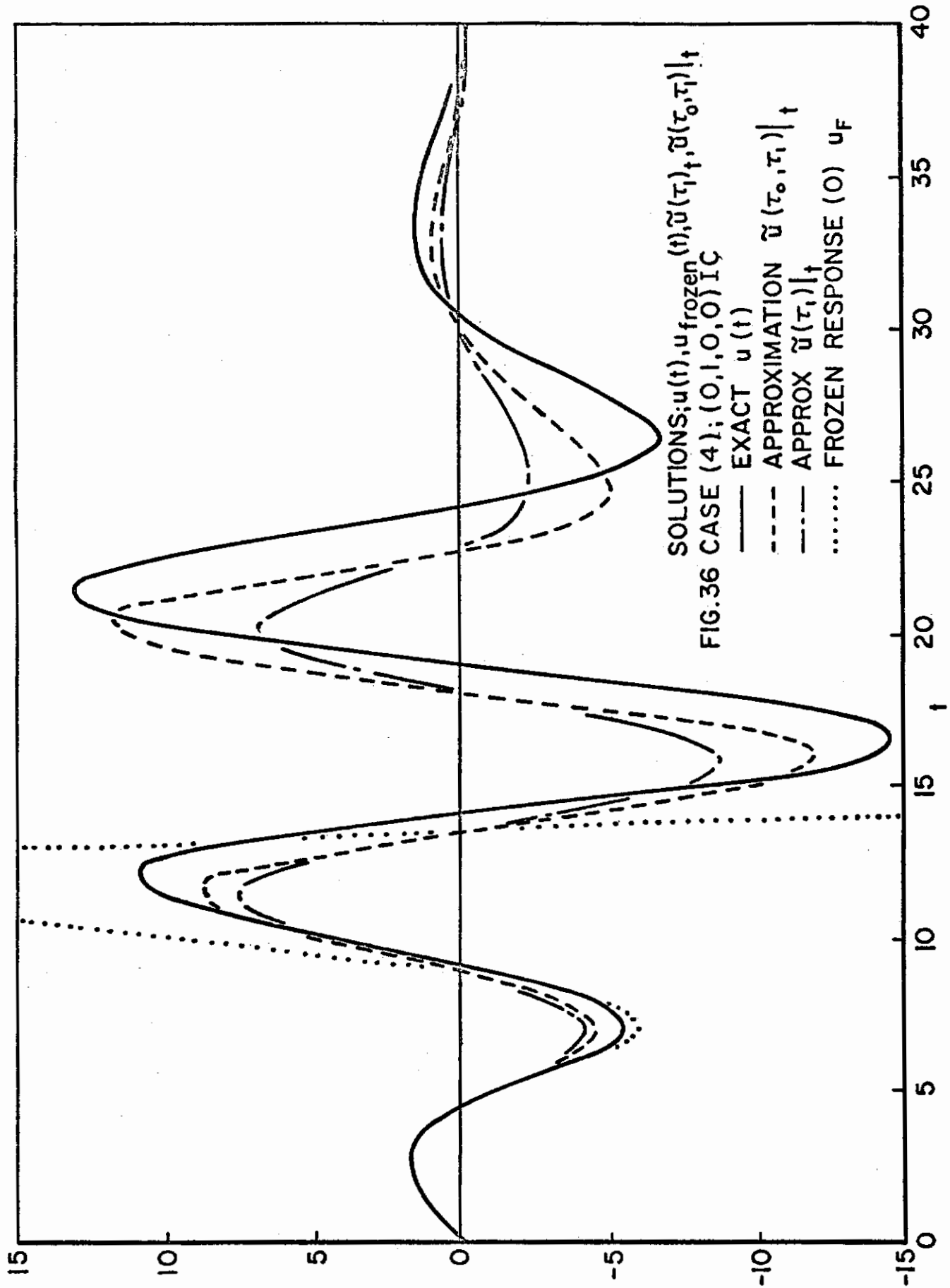
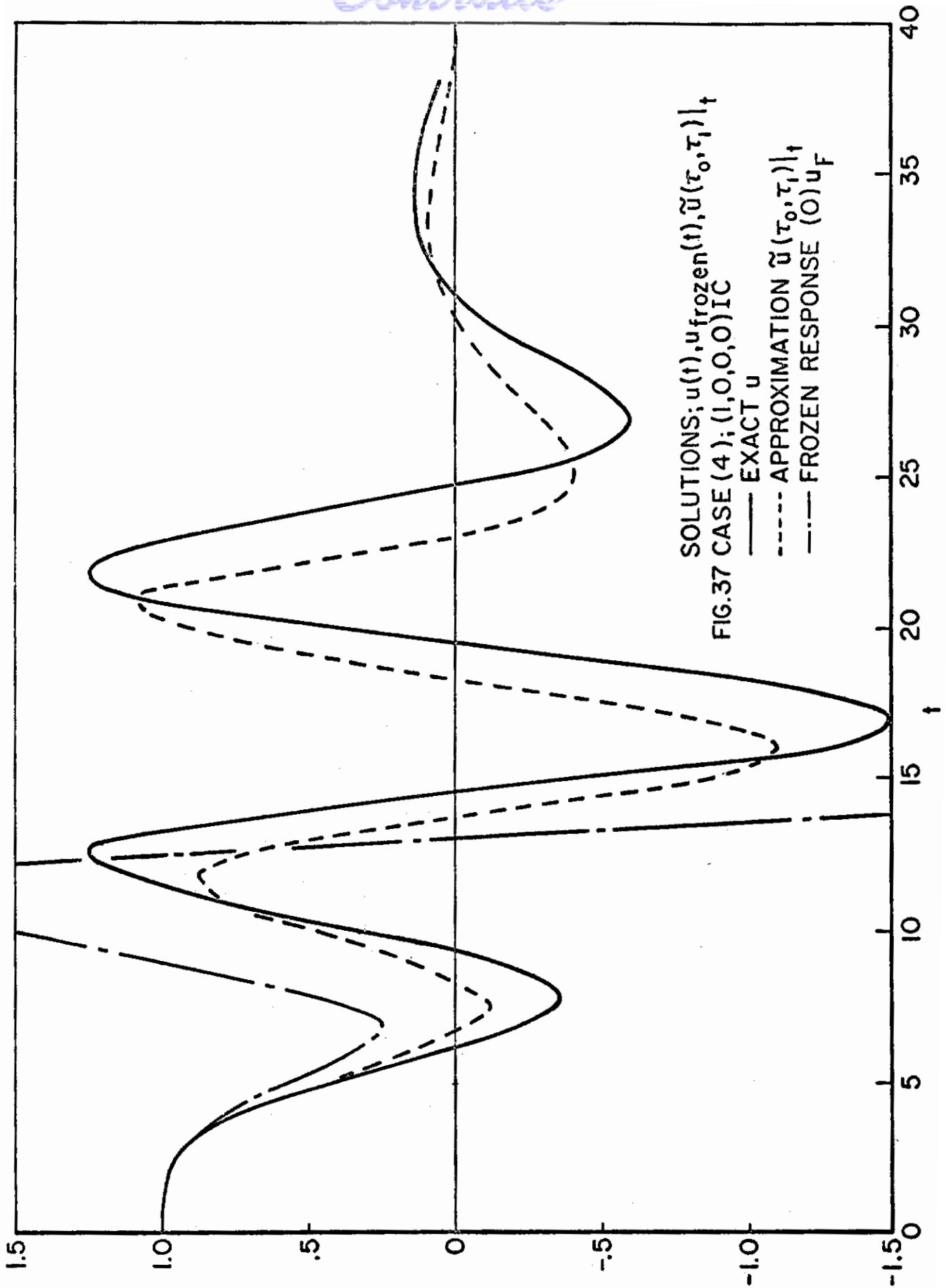

FIG.35 CHARACTERISTIC ROOTS;
FOURTH ORDER u EQUATION;
CASE (4)





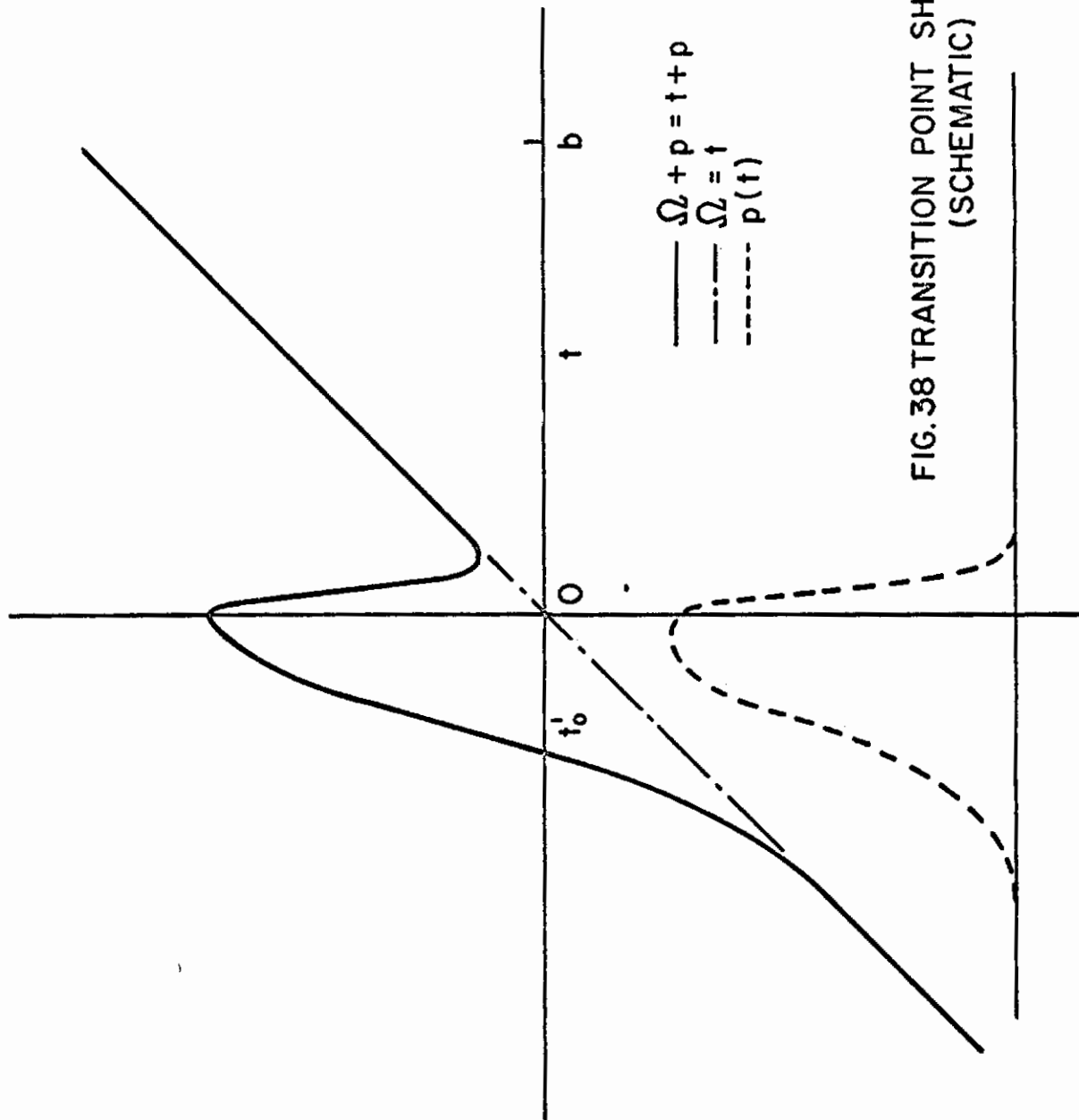

FIG. 38 TRANSITION POINT SHIFTING (SCHEMATIC)

Unclassified
Security Classification

DOCUMENT CONTROL DATA - R&D		
(Security classification of title, body of abstract and indexing annotation must be entered when the overall report is classified)		
1. ORIGINATING ACTIVITY (Corporate author) The Trustees of Princeton University Princeton, New Jersey 08540	2a. REPORT SECURITY CLASSIFICATION Unclassified	
	2b. GROUP N/A	
3. REPORT TITLE A MULTIPLE TIME SCALES APPROACH TO THE ANALYSIS OF LINEAR SYSTEMS		
4. DESCRIPTIVE NOTES (Type of report and inclusive dates) Final Technical Report		
5. AUTHOR(S) (Last name, first name, initial) Ramnath, R. V.		
6. REPORT DATE October 1968	7a. TOTAL NO. OF PAGES 192	7b. NO. OF REFS 70
8a. CONTRACT OR GRANT NO. AF33(615)-3657 b. PROJECT NO. 8219 c. Task 821904 d. Work Unit Number: 019	9a. ORIGINATOR'S REPORT NUMBER(S) AFFDL-TR-68-60 9b. OTHER REPORT NO(S) (Any other numbers that may be assigned this report) N/A	
10. AVAILABILITY/LIMITATION NOTICES This document has been approved for public release and sale; its distribution is unlimited.		
11. SUPPLEMENTARY NOTES	12. SPONSORING MILITARY ACTIVITY AFFDL (FDCC) Wright-Patterson AFB, Ohio 45433	
13. ABSTRACT In this work an investigation is made of uniform approximations to the solutions of linear differential equations with variable coefficients. The ordinary differential equations are replaced by an appropriate set of partial differential equations that determine the unknown function in terms of a set of independent "time scales". The time scales are determined so as to obtain uniformly valid approximations. The partial differential equations, in conjunction with the requirement of uniformity of the approximation in a given interval, determine the time scales through a set of "clock functions" k_i , which may depend on the interval of interest. It is essential for the success of the approximation that the clock functions be nonlinear functions of time, in addition to being complex quantities. The constant coefficient case arises as a natural limit. Thus the present approach generalizes earlier time scale analyses. With this generalization we recover for second order systems the Liouville-Green (or WKBJ) approximation. The difference between the present approach and the PLK method is emphasized with examples.		

DD FORM 1473
1 JAN 64

Unclassified
Security Classification

Unclassified
Security Classification

14.	KEY WORDS	LINK A		LINK B		LINK C	
		ROLE	WT	ROLE	WT	ROLE	WT
	<p>Time-Varying Linear Systems</p> <p>Variable Coefficient Differential Equations</p> <p>Time-Varying Analysis</p>						

INSTRUCTIONS

1. **ORIGINATING ACTIVITY:** Enter the name and address of the contractor, subcontractor, grantee, Department of Defense activity or other organization (*corporate author*) issuing the report.
- 2a. **REPORT SECURITY CLASSIFICATION:** Enter the overall security classification of the report. Indicate whether "Restricted Data" is included. Marking is to be in accordance with appropriate security regulations.
- 2b. **GROUP:** Automatic downgrading is specified in DoD Directive 5200.10 and Armed Forces Industrial Manual. Enter the group number. Also, when applicable, show that optional markings have been used for Group 3 and Group 4 as authorized.
3. **REPORT TITLE:** Enter the complete report title in all capital letters. Titles in all cases should be unclassified. If a meaningful title cannot be selected without classification, show title classification in all capitals in parenthesis immediately following the title.
4. **DESCRIPTIVE NOTES:** If appropriate, enter the type of report, e.g., interim, progress, summary, annual, or final. Give the inclusive dates when a specific reporting period is covered.
5. **AUTHOR(S):** Enter the name(s) of author(s) as shown on or in the report. Enter last name, first name, middle initial. If military, show rank and branch of service. The name of the principal author is an absolute minimum requirement.
6. **REPORT DATE:** Enter the date of the report as day, month, year, or month, year. If more than one date appears on the report, use date of publication.
- 7a. **TOTAL NUMBER OF PAGES:** The total page count should follow normal pagination procedures, i.e., enter the number of pages containing information.
- 7b. **NUMBER OF REFERENCES:** Enter the total number of references cited in the report.
- 8a. **CONTRACT OR GRANT NUMBER:** If appropriate, enter the applicable number of the contract or grant under which the report was written.
- 8b, 8c, & 8d. **PROJECT NUMBER:** Enter the appropriate military department identification, such as project number, subproject number, system numbers, task number, etc.
- 9a. **ORIGINATOR'S REPORT NUMBER(S):** Enter the official report number by which the document will be identified and controlled by the originating activity. This number must be unique to this report.
- 9b. **OTHER REPORT NUMBER(S):** If the report has been assigned any other report numbers (*either by the originator or by the sponsor*), also enter this number(s).
10. **AVAILABILITY/LIMITATION NOTICES:** Enter any limitations on further dissemination of the report, other than those

imposed by security classification, using standard statements such as:

- (1) "Qualified requesters may obtain copies of this report from DDC."
- (2) "Foreign announcement and dissemination of this report by DDC is not authorized."
- (3) "U. S. Government agencies may obtain copies of this report directly from DDC. Other qualified DDC users shall request through _____."
- (4) "U. S. military agencies may obtain copies of this report directly from DDC. Other qualified users shall request through _____."
- (5) "All distribution of this report is controlled. Qualified DDC users shall request through _____."

If the report has been furnished to the Office of Technical Services, Department of Commerce, for sale to the public, indicate this fact and enter the price, if known.

11. **SUPPLEMENTARY NOTES:** Use for additional explanatory notes.
12. **SPONSORING MILITARY ACTIVITY:** Enter the name of the departmental project office or laboratory sponsoring (*paying for*) the research and development. Include address.
13. **ABSTRACT:** Enter an abstract giving a brief and factual summary of the document indicative of the report, even though it may also appear elsewhere in the body of the technical report. If additional space is required, a continuation sheet shall be attached.

It is highly desirable that the abstract of classified reports be unclassified. Each paragraph of the abstract shall end with an indication of the military security classification of the information in the paragraph, represented as (TS), (S), (C), or (U).

There is no limitation on the length of the abstract. However, the suggested length is from 150 to 225 words.
14. **KEY WORDS:** Key words are technically meaningful terms or short phrases that characterize a report and may be used as index entries in cataloging the report. Key words must be selected so that no security classification is required. Identifiers, such as equipment model designation, trade name, military project code name, geographic location, may be used as key words but will be followed by an indication of technical context. The assignment of links, rules, and weights is optional.

Unclassified
Security Classification