

**ABSTRACT**

This volume is the first of a three-volume handbook covering the applications of electronics in monitoring bioelectric physiological responses. The fundamental concepts and methods presented in this volume form a foundation for the detailed technical discussions in the succeeding volumes and, it is hoped, provide a common language and basis of understanding between the physiologist and electronic engineer engaged in this field. The data obtained by monitoring physiological responses in varied environments can be used to improve the efficiency and increase the safety of a human subject in aircraft and spacecraft.

**PUBLICATION REVIEW**

This technical documentary report has been reviewed and is approved.

  
JOS. M. QUASHNOCK  
Colonel, USAF, MC  
Chief, Biomedical Laboratory

TABLE OF CONTENTS

	Page
<b>SECTION I - INTRODUCTION</b>	
GENERAL .....	1
MEASUREMENT OBJECTIVE .....	2
I    Research Information .....	2
II   Functional Information .....	2
THE MEASUREMENT PROBLEM .....	2
I    The Subject .....	4
II   Input Factors .....	4
A. Sustaining .....	4
B. Sensory .....	4
C. Psychological .....	4
III  Output Factors .....	5
A. Physiological .....	5
B. Intermediate .....	5
C. Psychological .....	5
<b>SECTION II - BASIC PHYSIOLOGICAL SYSTEMS</b>	
BEHAVIORAL SYSTEM .....	6
I    Description and Function .....	6
A. Nervous System .....	6
B. Central Nervous System .....	7
C. Peripheral Nervous System .....	9
II   General Monitoring Methods .....	10
A. Electroencephalography .....	10
B. Electromyography .....	12
C. Galvanic Skin Response .....	12

TABLE OF CONTENTS (Continued)

	Page
III. Problem Areas . . . . .	13
RESPIRATORY SYSTEM . . . . .	13
I Description and Function . . . . .	13
A. The Breathing Process . . . . .	14
B. The Capacity of the Lungs . . . . .	14
C. Chemical Composition of Inspired and Expired Air . . . . .	15
D. Relationship of Oxygen and Blood . . . . .	15
E. The Control of Respiration . . . . .	15
F. Minute Volume . . . . .	16
II Basic Monitoring Methods . . . . .	16
A. Air Flow Measurements . . . . .	17
B. Chest Movement Measurements . . . . .	17
C. Minute Volume . . . . .	17
D. Oxygen and Carbon Dioxide Partial Pressure . . . . .	17
CIRCULATORY SYSTEM . . . . .	18
I Description and Function . . . . .	18
A. Heart . . . . .	18
B. Blood Vessels . . . . .	21
C. Lymphatic System . . . . .	22
D. Blood Pressure . . . . .	22
II General Monitoring Methods . . . . .	24
A. Pulse Rate . . . . .	25
B. Blood Pressure . . . . .	25
C. Cardiac Activity . . . . .	27
D. Blood Flow Rate . . . . .	29
E. Oxygen Saturation of Blood . . . . .	29
METABOLIC SYSTEM . . . . .	31
I Description and Function . . . . .	31
II Basic Monitoring Methods . . . . .	31
III Problem Areas . . . . .	32

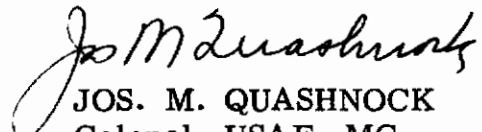
TABLE OF CONTENTS (Continued)

	Page
EXCRETORY SYSTEM .....	32
I    Description and Function .....	32
II   General Monitoring Methods .....	33
ENDOCRINE SYSTEM .....	33
I    Description and Function .....	33
A.  Endocrine Glands and Organs .....	33
B.  Functions of Endocrine Glands and Organs .....	34
II   General Monitoring Methods .....	34
III  Problem Areas .....	36
TEMPERATURE-REGULATING SYSTEM .....	36
I    Description and Function .....	36
A.  Heat Production .....	36
B.  Heat Loss .....	37
C.  Temperature Regulation .....	37
II   General Monitoring Methods .....	38
III  Problem Areas .....	38
BIOELECTRIC MEMBRANE CHARACTERISTICS .....	38
I    Cell Potentials .....	39
A.  Basic Characteristics .....	39
B.  Energy Considerations .....	39
II   Excitation .....	41
A.  Stimulus for Producing Excitation .....	41
B.  Refractory Period .....	41
C.  All-or-Nothing Law .....	42
PHYSIOLOGICAL VARIABLES IN ABNORMAL ENVIRONMENTS .....	43
I    Atmospheric Composition and Pressure .....	44

TABLE OF CONTENTS (Continued)

	Page
A. Respiration .....	44
B. Circulation .....	47
II Gravitational Forces .....	49
A. Acceleration .....	50
B. Weightlessness .....	55
III Temperature .....	57
IV Radiation .....	60
A. Biological Effects .....	60
B. Measures of Radiation .....	60
C. Radiation Exposure .....	61
D. Physiological Effects of Radiation .....	63
V Noise and Vibration .....	67
VI Emotional Stress .....	69
A. Artificial Environment .....	69
B. Day-Night Cycle .....	70
C. Fatigue .....	71
 SECTION III - BASIC PHYSIOLOGICAL MEASURING SYSTEMS  	
INTRODUCTION .....	73
GENERAL SYSTEM CONSIDERATIONS .....	73
I General System Requirements .....	74
A. Frequency Spectra .....	74
B. Dynamic Range .....	74
II Error Considerations .....	74
A. Frequency Characteristics .....	76
B. Impedance Matching .....	77
C. Nonlinearity .....	78
D. Interference and Artifacts .....	78

TABLE OF CONTENTS (Continued)

	Page
SIGNAL PICKUP DEVICES . . . . .	80
I    Transducers . . . . .	80
A. General . . . . .	80
B. Basic Considerations . . . . .	80
II   Electrodes . . . . .	81
A. Basic Considerations . . . . .	81
B. Electrode Arrays . . . . .	85
SIGNAL PROCESSING . . . . .	85
I    General . . . . .	85
II   Amplification . . . . .	86
A. Requirements . . . . .	86
B. Basic Amplifier Types for Physiological Applications . . . . .	86
DISPLAY . . . . .	90
I    Basic Data Display Method . . . . .	90
II   General Principles of Data Readout and Display Devices . . . . .	90
A. Frequency-Response Grouping of Recording Devices . . . . .	90
B. Direct Writing Versus Photodevelopment . . . . .	91
C. Curvilinear Versus Rectilinear Recording . . . . .	92
III  Recorder Impedances . . . . .	92
SPECIAL ACCESSORIES . . . . .	92
I    Telemetry . . . . .	93
II   Magnetic Tape Recording . . . . .	93
III  Computer Processing . . . . .	94
IV   Time Indexing . . . . .	94
A. General . . . . .	94
B. Establishing Correlation . . . . .	94

TABLE OF CONTENTS (Continued)

	Page
SYSTEM INTEGRATION FACTORS . . . . .	95
I    Physical Factors . . . . .	95
A. Size and Weight Limitations . . . . .	95
B. Placement and Attachment of Pickup Devices . . . . .	96
II   Information Handling Capability of Data Transmission Links . . . . .	96
III  General Environment . . . . .	96
A. Shock and Vibration . . . . .	96
B. Temperature . . . . .	96
C. Other Factors . . . . .	97
IV   Equipment Interaction . . . . .	97
V    Power Supply Problems . . . . .	97
ESTABLISHING VALIDITY OF REMOTE MEASUREMENTS . . . . .	97
EXPLANATION OF TERMS . . . . .	98
BIBLIOGRAPHY . . . . .	114

## LIST OF ILLUSTRATIONS

Figure	Title	Page
1	Factors Involved in Physiological Measurements . . . . .	3
2	The Cerebral Cortex Showing Areas and Lobes . . . . .	8
3	Electroencephalogram Showing Response Produced by Opening and Closing Eyes . . . . .	12
4	Capacity of the Lungs . . . . .	14
5	The Chambers of the Heart . . . . .	18
6	Cardiac Pressure Cycle with Corresponding EKG and Heart Sounds . . . . .	20
7	Composition of the Electrocardiogram . . . . .	28
8	Light Absorption by Hemoglobin . . . . .	30
9	Location of the Endocrine Glands and Organs . . . . .	35
10	Fiber Polarization . . . . .	40
11	Human Tolerance to Oxygen Partial Pressures . . . . .	45
12	Human Tolerance to Carbon Dioxide Partial Pressures . . . . .	48
13	Standard Terminology for Acceleration . . . . .	51
14	Human Tolerance to Temperature . . . . .	58
15	Heat Production of Nearly Nude Man . . . . .	59
16	Basic Permissible Exposure Rates to External Sources of Ionizing Radiation . . . . .	62
17	Human Tolerance to Vibration . . . . .	68
18	Basic Elements of a Physiological Measuring System . . . . .	73
19	Frequency Distortion of a Square Wave . . . . .	76
20	Typical Frequency Response Curve . . . . .	77
21	Nonlinearity of a Sine Wave . . . . .	79
22	Potential Source Parallel to the Skin Surface . . . . .	82
23	Potential Source Perpendicular to the Skin Surface . . . . .	83
24	Relative Impedances in the Use of Electrodes . . . . .	84
25	Simplified Single-Ended Amplifier . . . . .	87
26	Simplified Balanced Amplifier . . . . .	88
27	Simplified Differential Amplifier . . . . .	89
28	Physiological Measuring System with Accessories . . . . .	93

## LIST OF TABLES

Table	Title	Page
I	Gross Effects of Short-Duration Acceleration Forces . . . . .	52
II	Clinical Symptoms of Radiation Sickness . . . . .	63
III	Frequency Spectrum Requirements for Individual Monitoring Systems . . . . .	75



# *Section I*

## **INTRODUCTION**

### GENERAL

This volume is the first of a three-volume handbook covering the electronic monitoring of a physiological subject in an abnormal environment. The handbook describes instrumentation techniques that have proven useful in determining the vital state of normal subjects in varied environments. Aircraft and spacecraft applications are the principle considerations, but some contribution may be made towards stabilization of measurement practices.

Although the subject matter of this handbook lies somewhere between the bio-sciences and electronic technology, the material is presented so as to be understandable to doctors, physiologists, engineers, or technicians who are interested in the field of physiological monitoring. The handbook provides a common language and terminology for electronics and medical personnel. It is hoped it will contribute to the solution of the liaison problem between physiologists and engineers. It is not intended, however, to replace basic texts in either field.

Volume I, introductory in nature, presents basic physiological and electronic fundamentals involved in monitoring physiological reactions. The problem is defined, general procedures are outlined, and background material is supplied which should aid both electronics and medical personnel in gaining an appreciation of the factors involved. (Volume II takes up specific equipments and equipment applications, and Volume III describes complex systems, problems, and system calibration procedures.)

Volume I consists of three sections. The first section explains the purpose and defines the scope of the handbook, and briefly describes the objectives, problems, and factors involved in physiological measurements. Section II describes the various body systems and physiological phenomena subject to electronic sensing and presentation. The principles and philosophy of physiological measurement are discussed in Section III.

Physiological and psychometric monitoring parallel each other closely. However, this manual is restricted principally to techniques applicable to the measurement of physiological and related phenomena. Although there is an indefinite area where the physiological and psychological areas overlap, generally, they can be distinguished as follows: the physiological area is related to the basic or vegetative functions of living organisms; the psychological area is related to the higher order functions involving sensation, perception, memory, and thought.

## INTRODUCTION

### MEASUREMENT OBJECTIVE

Measurements provide factual, quantitative information that can be used for planning protective measures which will ensure the safety and functional capability of personnel engaged in hazardous missions. The information is of two types: research and functional.

#### I. Research Information

Research information establishes the relationship between some factor of the environment and the subject's reaction. Both input and output factors must be measured (see figure 1), and any measurement involving multiple factors requires the monitoring of the constants. The accepted procedure is to set up a controlled situation in the laboratory, if possible, in which all input factors are held constant, except the one under investigation. One factor then is varied in a controlled manner while observing all possible output factors. The environmental factor may be vibration, zero G, a radiation field, or perhaps the isolation of space. However, some of the conditions, i.e., input factors encountered in aircraft and space flight, are very difficult or impossible to simulate in the laboratory. Prolonged zero G, cosmic radiation, and psychological stress are among them.

The effect upon the vital state of the subject must be known quantitatively, if possible, to determine if protective measures are necessary or effective. Once the research information is obtained and the protective problem solved, this instrumentation is no longer needed, and a functional or historical type of monitoring system should be all that is required.

#### II. Functional Information

Functional information is sought concerning deviations from expected or hopefully established conditions, and should provide the answer to what went wrong. Ideally, only the input factors shown in figure 1 need be measured. The information obtained may help in future design work, but it is primarily historical, i.e., a record of events. Functional information probably will remain a requirement as long as a mission contains a large element of risk.

### THE MEASUREMENT PROBLEM

Figure 1 indicates the scope of the measurement problem. How may meaningful relations be established between such a large number of inputs and outputs? What input may logically be related to what output? These are a few of the questions presented. In this handbook, emphasis is placed on the measurements of the output or response factors, the items noted on the right-hand side of figure 1. This is done without intent to deemphasize the importance of the factors on the input side. Certainly

## INTRODUCTION

all of the environmental factors must be encompassed if the measurement is to have real significance. However, since the techniques for quantifying physical factors of the environment are within the scope of the physical sciences, the reader will be referred, when possible, to texts and references in the field of physical measurement.

### I. The Subject

The box labeled "subject" in figure 1 represents a human being, which is beyond doubt the most complex device in existence. A great deal is known about the device's physical structure (anatomy) and something about the functional processes (physiology) that maintain the basic life condition, i.e., the vegetative state. Very little, however, is known about the system that governs the higher order functions or the psychological behavior.

From the engineer's standpoint, the subject is jammed full of nonlinear devices and interconnecting subsystems with multiple feedback loops. It also has a self-adapting programmer and tremendous information storage capability. The output from the subject is often governed by the events of hours, days, or years past.

### II. Input Factors

The input (afferent) factors of total environment are many, and the change of any one may affect the output. These factors are grouped into the following three categories:

#### A. Sustaining

Sustaining factors include food; drink; atmospheric factors such as temperature, pressure, and composition (oxygen, nitrogen, carbon dioxide, water, and residuals or contaminants); the accelerative or G field; infectious agents; and radiation. Except for temperature and radiant heat (radiation), these inputs are, in general, non-sensory in their steady-state condition, and are important determinants of the lower order or basic physiological behavior.

#### B. Sensory

Light, sound, odor, transient pressure and vibration are sensory phenomena and form the basis of higher order behavior.

#### C. Psychological

Psychological factors are the difficult-to-measure items that are regenerated within the subject by input factors reacting with stored past experience, as indicated in figure 1 by the re-entry loop. These are the factors of anxiety, fatigue and stress, the reflex, inherent and learned behavior patterns, motivation, attitude, and other "affect"

THE MEASUREMENT PROBLEM

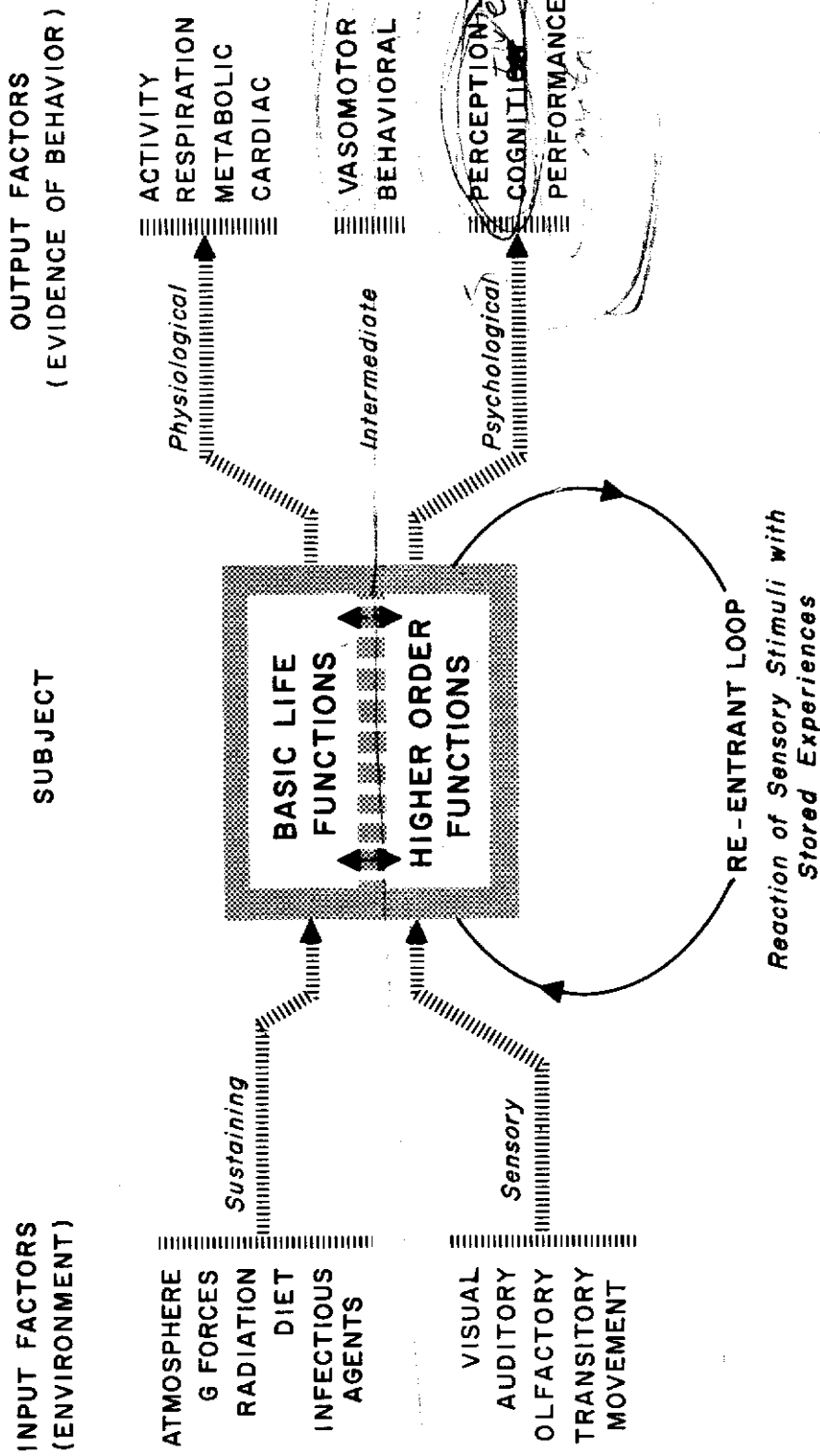

Figure 1. Factors Involved in Physiological Measurements

## THE MEASUREMENT PROBLEM

items that compose what the psychologists term the egoautonomy.

### III. Output Factors

Some input factors may present measurement problems, but the situation at the output is much more difficult. Authorities disagree markedly on the significance of many evidences of physiological activity, and more so on those of psychological behavior. They do agree, however, that there are two general classes: namely the physiological and psychological; and, because the dividing line between these two is so uncertain, a third class, called intermediate, is identified.

#### A. Physiological

The physiological class includes evidences of activity, indications of respiration and metabolism, measures of heart activity, measurements of systolic or diastolic blood pressure, etc.

#### B. Intermediate

Within the uncertain area dividing the physiological and psychological classes lie behavioral measurements such as skin responses (GSR), biochemical reactions, and brain or electroencephalographic recordings (EEG).

#### C. Psychological

Factors that are measured, such as operant behavior, tracking, and problem solving, are used as indices of the factors of perception, cognition, and performance. These measures all involve complex motor-action (limb movement) response to locally programmed (standardized) stimuli. Treatment of this subject will be minimal, not because it is unimportant, but because of the uncertain state of the measurement art in this field.



## *Section II*

# **BASIC PHYSIOLOGICAL SYSTEMS**

### BEHAVIORAL SYSTEM

#### I. Description and Function

Biologically, behavior is regarded as the action and response of a physiological subject to stimulation, and the parts of the body responsive to this stimulation comprise the behavioral system. Although the behavioral system could be considered in both its physiological and psychological aspects, only the physiology of the nervous system and those emotional and motivational conditions which stimulate the nervous system physiologically are discussed here.

Man has physiological needs which must be fulfilled in order to sustain life. When physiological needs remain unsatisfied, stresses are created which drive organisms into activity. Organisms, by their own activity, tend to maintain a physiological equilibrium. Expressed in another way, each disturbing influence induces a compensatory activity to neutralize its own disturbance. This concept is known as homeostasis. An example of this is sweating to maintain constant body temperature.

#### A. Nervous System

The nervous system is the communications network of the body. Pulse signals traveling through the nervous system affect our thoughts and emotions, and regulate our respiration, heart activity, and the activity of muscles and glands throughout the body.

The nervous system is divided into two major subsystems: the central nervous system and the peripheral nervous system. The central nervous system consists of the brain and the spinal cord, and the peripheral nervous system consists of the cranial and spinal nerves that extend to all parts of the body from the brain and the spinal cord.

The nervous system is formed of a network of nerve cells or neurons. The neuron usually is less than 0.1 millimeter in diameter, but sometimes is as long as 3 meters. It is composed of three main parts: dendrites, a cell body, and an axon. (Dendrites and axons are referred to as nerve fibers.) Impulses are picked up by the dendrites, passed through the cell body, and conducted by the axon to the junction with other neurons in the network. In this manner, impulses travel from neuron to neuron in one direction only.

Neurons generally are divided into three groups: afferent neurons which

## BEHAVIORAL SYSTEM

conduct impulses from the sensory receptors to the central nervous system, efferent neurons which conduct impulses from the central nervous system to the muscles or glands, and association neurons which lie totally within the central nervous system. Afferent neurons have only sense functions and efferent neurons usually have purely motor functions. The association neurons transfer incoming pulses to various parts of the central nervous system and relay impulses originating in the central nervous system to efferent neurons, other association neurons, or to nerve centers. Neurons are not connected to each other physically, but transmit impulses by means of synaptic junctions. The synapse is a sort of chemical rectifier which allows impulses to pass through it only in one direction (suggestive of the switching diodes used in the logic circuits of electronic computers).

The afferent nerves which convey environmental information (sensation) from the peripheral nervous system to the central nervous system are referred to as the sensory nerves. The efferent nerves, particularly those which convey nerve impulses from the central nervous system to the peripheral nervous system causing response, are referred to as the motor nerves. All impulses carried by nerve fibers, both sensory and motor, are essentially alike. Fibers from the eyes do not carry impulses that are different from those carried by fibers from the ears. The eye sees when it is stimulated and the ear hears when it is stimulated because the impulses, although alike, go to different regions of the brain. Nerve impulses, however, do differ in frequency without respect to their point of origin or point of termination. As the intensity of the stimulus increases, the frequency of the nerve impulse changes. Strong stimuli also may stimulate more fibers.

### B. Central Nervous System

The central nervous system, composed of the spinal cord and the brain, is constructed of many thousands of millions of neurons, each connected transsynaptically with hundreds of others.

#### 1. The Spinal Cord

The spinal cord serves as a pathway for nervous impulses to and from the brain and as a center for carrying out and coordinating many reflex actions independently of the brain. It is a thick longitudinal cord of nervous tissue securely encased by the bony vertebrae of the spinal column and, continuous with the hindbrain, extends virtually the whole length of the spinal column. At intervals along its length, pairs of nerves (the spinal nerves) extend from the spinal cord to the various parts of the trunk and limbs.

#### 2. The Brain

The brain is a large mass of nerve tissue contained in the skull or cranial cavity. The brain consists of gray matter made up largely of nerve cells, and white

## BASIC PHYSIOLOGICAL SYSTEMS

matter made up chiefly of nerve fibers arising from the nerve cells of the brain or reaching it from other parts of the central nervous system.

The brain represents only about 2 percent of the total weight of the body, yet it functions as the master control unit. It analyzes information it receives from the sensory organs and receptors and makes decisions and issues instructions (in the form of efferent neuron impulses) to the muscles and glands. The ultimate control of behavior depends upon the integrating mechanisms of the brain.

There are three major divisions of the brain: the forebrain, the midbrain, and the hindbrain. The forebrain contains the two cerebral hemispheres, which cover the upper or dorsal surface of the rest of the brain. The right and left cerebral hemispheres are divided by the longitudinal fissure. Each hemisphere is divided by deep crevices (sulci) into four lobes: the frontal, parietal, occipital, and temporal lobes. (See figure 2.)

The frontal lobe extends from a deep crevice in the center of the brain (the Fissure of Rolando) to the most forward section. The forward section of the frontal lobe contains the association areas which are important for such complex associative processes as recalling, thinking, and some language functions. The convolution immediately in front of the Fissure of Rolando is the motor control area of the brain. All muscles from the toes to the eyelids are controlled from this area.

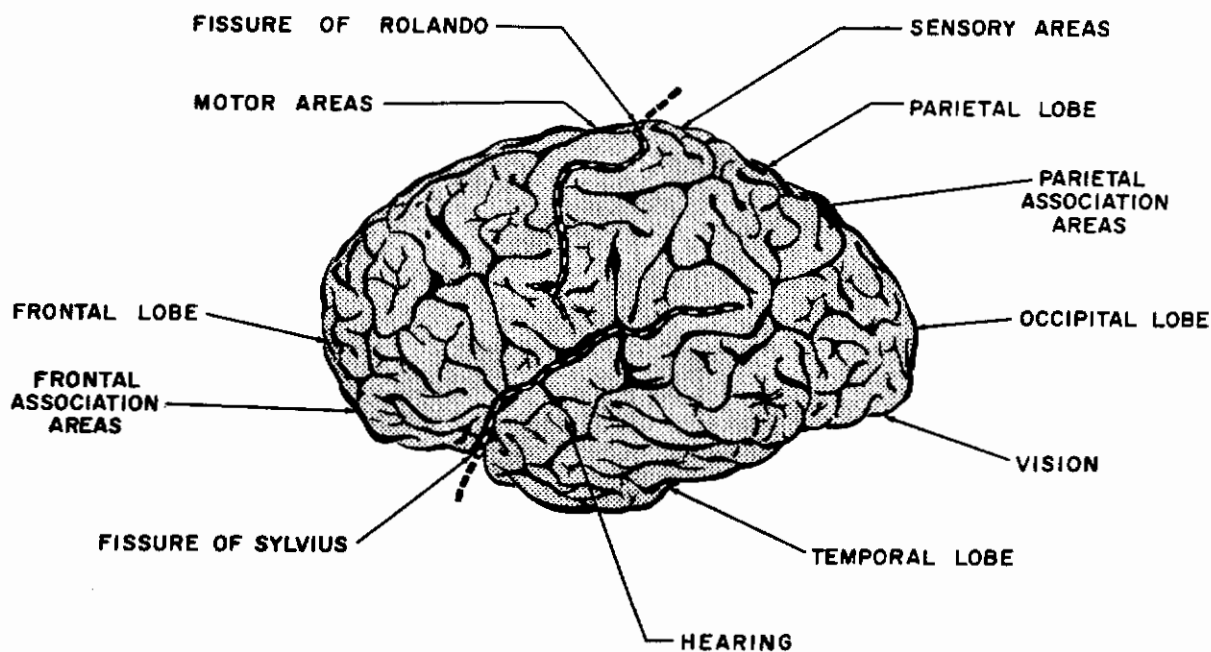

Figure 2. The Cerebral Cortex Showing Areas and Lobes



## BEHAVIORAL SYSTEM

The parietal lobe, directly behind the Fissure of Rolando, is the area of the brain that is sensitive to bodily sensations (somatesthetic). All impulses originating in the skin and in the receptors sensitive to muscular senses, such as the perception of movement, weight, resistance, and position (kinesthetic), are received here. The occipital lobe, the rear section of the brain, receives all impulses originating in the visual receptors. A deep crevice, the Fissure of Sylvius, which runs longitudinally along the side of each hemisphere, separates the temporal lobe from the frontal and parietal lobes. Impulses originating in the auditory receptors are carried to the temporal lobes.

The outer layer of each hemisphere is gray and is raised in irregular ridges called convolutions or gyri. These gray layers are the center of the highest and most complex nervous functions and are known as the cerebral cortex or gray matter. The cerebral cortex is regarded as the seat of consciousness and is essential to all voluntary activity. Neurons with sensory functions enter the central nervous system and are directed through the thalamus to appropriate areas of the cortex. Sensory areas of the cortex are connected to specific motor areas of the cortex by association neurons, and the motor areas transmit impulses to muscles throughout the body. The primary receiving areas of the cortex are not the only end stations for afferent neurons. Hearing, vision, and touch are each doubly, and possibly trebly, represented in each hemisphere of the brain with separate pathways. The motor areas also have been found to have duplicates.

The more complex body reflex actions are regulated through the various subcortical (beneath the cortex) parts of the brain. The midbrain serves as a correlation center for optic and auditory reflexes and contributes to muscle tone. Within the hindbrain, the medulla, which is the connecting point between the spinal cord and the brain, regulates the autonomic activities, such as respiration, heartbeat, and sugar metabolism. The cerebellum, also a part of the hindbrain, maintains bodily equilibrium and coordinates muscular activity.

### C. Peripheral Nervous System

#### 1. Cranial Nerves

The cranial nerves are 12 pairs of nerves that pass through openings (foramens) in the skull in their paths from various parts of the brain to (with certain exceptions) organs and other parts of the head. Some of these nerves are sensory, concerned with the sense of smell, sight, hearing, taste, and feeling; others are motor nerves, controlling the salivary glands and muscles in the eyes, jaw, tongue, pharynx, and shoulder.

#### 2. Spinal Nerves

The spinal nerves are 31 pairs of nerves that extend from either side of

# *Contrails*

## BASIC PHYSIOLOGICAL SYSTEMS

the spinal cord throughout its length. These nerves, containing both sensory and motor fibers, connect to muscles and skin of the trunk and limbs and to nerves of the sympathetic system, a part of the automatic nervous system.

### 3. Autonomic Nervous System

The autonomic nervous system exerts a regulatory influence over involuntary muscles, glands, and the viscera (the organs contained within the cranial, thoracic, abdominal, and pelvic cavities). Autonomic activities are under the control of the hypothalamus, a part of the forebrain, and are primarily motor in function. Two functionally antagonistic systems make up the autonomic nervous system: the sympathetic (sometimes called orthosympathetic) and parasympathetic. The sympathetic nervous system mobilizes the internal environment to combat external stress more effectively, whereas the parasympathetic protects, conserves, and restores the resources of the organism. For example, the sympathetic connection with the heart accelerates its activity, while the parasympathetic connection acts to slow it down. The activities of the stomach, conversely, are restricted by the sympathetic system and accelerated by the parasympathetic. The adrenal gland is the only organ known to be under control of only one division of the autonomic nervous system: it is accelerated by the sympathetic system and is not affected by the parasympathetic. An emotionally aroused individual's heart pounds, his stomach contractions and gastric secretions are checked, his bladder relaxes, his trachea and bronchi are dilated, and his adrenalin secretion is accelerated - all because his sympathetic nervous system has assumed control.

Under normal circumstances, the parasympathetic nervous system (1) constricts the pupils of the eyes, (2) promotes profuse, watery secretions of saliva, (3) slows the heart rate, (4) promotes peristalsis in the esophagus, (5) promotes secretion of pancreatic juices, (6) augments peristalsis and secretory activity in the stomach and the intestines, (7) constricts the bladder, and (8) redistributes blood volume toward the viscera. The sympathetic nervous system (1) dilates the pupils of the eyes, (2) promotes scanty, viscous secretions of saliva, (3) accelerates the heart rate, (4) dilates the trachea and bronchi, (5) inhibits peristalsis and secretory activity in the stomach and intestines, (6) relaxes the bladder, and (7) redistributes blood volume to the muscles.

## II. General Monitoring Methods

The behavioral system may be monitored by measuring the electrical potentials developed in the nervous system or muscles, or by measuring the resistances or conductances of the skin.

### A. Electroencephalography

The neurons of the brain generate electric potentials. This electrical activity of the brain may be detected with electrodes placed on the surface of the head or through the skull directly on the cortex. The recordings made with electrodes placed

on the scalp require very high amplification, although in all other ways they are the same as those made from the surface of the cortex. When measured on the scalp, the potential difference between electrodes (one electrode is connected to the lobe of the ear as a reference) is approximately 30 millionths of a volt ( $30 \times 10^{-6}$  volt). Rarely in the normal man does the potential difference exceed 200 millionths of a volt, which is about 1/10th or less of the magnitude of electrocardiographic potentials. The rhythmically varying potentials of the brain are recorded on oscillographs, producing records called electroencephalograms (EEG).

The waveforms recorded by the electroencephalograph are nonperiodic, low-frequency, complex waves of very low power. These waves contain many frequencies with shifting phase relationships and varying amplitudes within the range of 1 to 60 cycles per second. Brain waves have two predominant rhythms: alpha and beta. The most common is the alpha rhythm, which has a frequency range of approximately 8 to 13 oscillations per second. The alpha rhythm is desynchronized or reduced in amplitude by visual activity and alert attention, and for this reason, it is often referred to as the resting rhythm. It is obtained most easily from the parietal and occipital lobes, although it can be detected almost anywhere on the scalp. The beta type of rhythm is dominated by waves of approximately 18 to 30 oscillations per second. It is detected most easily in the frontal lobe.

The electroencephalograms of different persons differ widely; however, the electroencephalogram of an individual normal adult varies little from hour to hour or over periods of several months. Electroencephalographic records indicate many things about the state of the subject. Although not completely reliable as yet, important behavioral patterns such as a subject's state of alertness and whether his eyes are open or closed can be monitored. The presence of the dominant rhythms and the frequencies and amplitudes of the brain waves may be used to determine the subject's state of alertness. Since closing the eyes raises the alpha rhythm amplitude, monitoring can determine if the subject's eyes are open or closed (figure 3). Also hypoxia tends to shift the rhythm toward the very low frequencies; therefore, indications are obtained on certain functions of the respiratory and circulatory systems as well as the behavioral system.

Artifacts make the interpretation of electroencephalograms difficult. The muscles of the scalp, neck, and jaws are stimulated continuously; consequently, electromyographic (muscle) potentials may appear in electroencephalograms. Electromyographic potentials may be eliminated to a large extent by filtering out frequencies higher than 50 oscillations per second. Muscle potentials not removed by filters are recognizable by their spiky appearance, relatively high frequency, and short duration.

Voltages generated by the neurons in the brain are suppressed greatly and the rhythms reduced considerably by narcotics, anesthetics, and alcohol.

## BASIC PHYSIOLOGICAL SYSTEMS

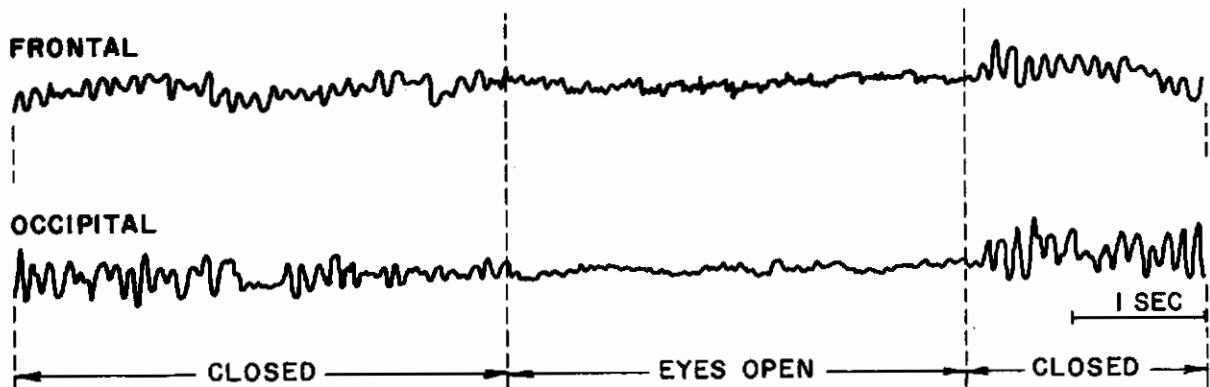

Figure 3. Electroencephalogram Showing Response Produced by Opening and Closing Eyes

### B. Electromyography

When individual muscles contract, they exhibit potential changes similar to those of nerve fibers. The potential changes are characterized by a series of spikes of relatively short duration (measured in milliseconds). The magnitudes of the potentials vary considerably, typically ranging from 1 to 3 millivolts for cardiac muscles and anywhere from 50 microvolts to 10 millivolts for skeletal muscles.

Muscle responses usually are observed from groups of muscle fibers and not individual fibers; therefore, the total potential change involves a mixture of frequencies and amplitudes. This mixture resembles "noise" when monitored on an oscilloscope or similar type of instrument.

An electromyograph (EMG) is used to measure the action potentials of muscles. This device is similar to an electroencephalograph in that electrodes are placed on the surface of the body over locations where potentials are expected to be generated. The frequencies of action potentials range from 2 to more than 1000 oscillations per second. Records obtained from an electromyograph indicate the state of synchronism in body movement patterns and may also be used to show the presence of fatigue or certain muscular diseases.

### C. Galvanic Skin Response

Galvanic skin response (GSR), psychogalvanic reflex (PGR), electrodermal response (EDR), and skin resistance are various names applied to the same procedure for monitoring the level of consciousness of a subject. This measurement has potential usefulness as an index of a number of psychological states: degree of alertness, apprehension, fear, panic, and placidity. Skin response signals are obtained by monitoring a



## BEHAVIORAL SYSTEM

small electric current between two electrodes attached to the skin of a subject to determine the resistance or conductance between the electrodes.

Physical reactions, such as changes in skin resistance, result from the reaction of the autonomic nervous system to internal or external stimuli. Autonomic nerves change the vascular bed tone by constricting near-surface capillaries and controlling the activity of the sweat glands. Both these factors are important causes of changing skin response.

Temperature-control mechanisms of the body also employ the sweat glands; consequently, skin resistance measurements of the behavioral system must not be confused with those of the temperature-regulating system. Two areas of the body with heavy concentrations of sweat glands that do not actively participate in temperature regulating, except in temperature extremes, are the palmar areas (the palms of the hands) and the plantar surfaces (the soles of the feet). When the subject is adjusted to the normal range of temperatures, changes in the electrical conduction of the palmar and plantar surfaces reflect the level of activation of the subject. Psychologically, activation is a dimension of more or less attention, more or less arousal, or more or less wakefulness.

### III. Problem Areas

In general, bioelectric signals are distorted by the instability of amplifiers and recording instruments, electrode artifacts, and signal overlapping. Amplifiers and recording instruments are discussed elsewhere in this manual. The electrode artifacts result from variations in electrical resistance at the point of contact with the skin caused by changes in mechanical pressure or the evaporation of the electrode jelly. Spurious potentials can be generated at bimetallic junctions or between the electrodes and saline body secretions. Bioelectric signals overlap (for example, electroencephalographic and electromyographic potentials) because the various separated body tissues are not insulated from each other. The reliability of signal responses may degrade when monitoring occurs for long periods of time because of maceration of the skin by electrode pastes.

## RESPIRATORY SYSTEM

### I. Description and Function

The respiratory system provides the body with oxygen from the atmosphere to oxidize carbonaceous food, thereby generating heat and supplying the body with energy for performing work. The system also returns to the atmosphere the carbon dioxide and some water that are formed by chemical reactions occurring in the cells and body tissues. Respiration processes involve the exchange of gases at the body cells and in the lungs. The exchange between the respiratory membrane or alveoli (air cells of the lungs) and the blood in the capillaries of pulmonary circulation is known as external

## BASIC PHYSIOLOGICAL SYSTEMS

respiration; the diffusion of gases between the blood in the systematic capillaries and the body cells is known as internal respiration. The exchange of gases is accelerated by the respiratory movements of inspiration and expiration.

### A. The Breathing Process

During inspiration (inhalation), the chest increases in volume and the pressure in the chest cavity (thorax) falls, permitting the higher pressure of the atmosphere to force air into the lungs. When the intrapulmonic pressure reaches that of the outside air, inspiration ceases. As the muscles that create the inspiratory movement relax, the thoracic volume decreases and the pressure within the lungs increases, expelling air to the atmosphere.

### B. The Capacity of the Lungs

The maximum volume of air that the lungs can contain may be divided into four portions (figure 4). Three of these portions (tidal volume, inspiratory reserve volume, and expiratory reserve volume) can be controlled voluntarily and constitute the vital capacity. (The vital capacity is the maximum amount of air that can be exchanged in a single respiration.) The fourth portion, the residual air, represents the air volume (about 1500 cc) that remains in the lungs as long as the thoracic cavity remains in an airtight compartment. With each normal inspiration, an adult at rest inhales

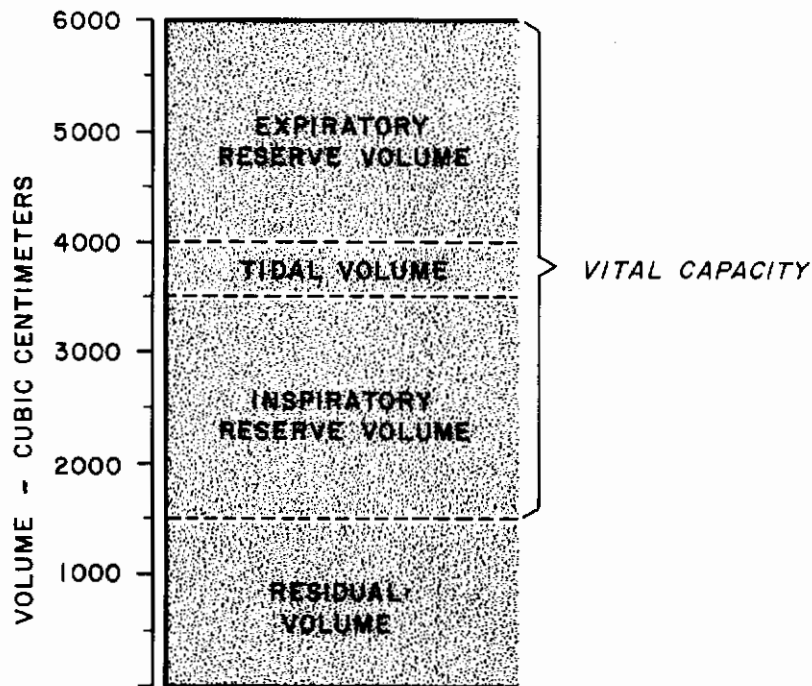

Figure 4. Capacity of the Lungs

## RESPIRATORY SYSTEM

about 500 cc of air and exhales the same amount. This volume of air is called tidal air. The inspiratory reserve volume (about 2000 cc) is the maximal volume that can be inspired in addition to the tidal air. The air that may be forcibly exhaled after a normal expiration (about 2000 cc) is the expiratory reserve volume. The air remaining in the lungs after maximal expiration is the residual air.

Tidal inspiration and expiration normally exchange about 500 cc of air, while more than 3500 cc of air remain in the lungs. In addition, about one third of the tidal air remains in the air passageways to the lungs; therefore, less than 10 percent of the air in the lungs is renewed during a quiet respiratory cycle. Were it not for the large volume of alveolar air (sac-air) in the lungs, the blood flowing in the lungs would be subject to alternate large surges of oxygen and carbon dioxide during intermittent inspiration and expiration. The exchange of alveolar air is dependent on the volume of tidal air, the blood flow rate, and the respiratory rate.

### C. Chemical Composition of Inspired and Expired Air

The chemical composition of inspired air is approximately 21 percent oxygen and 0.03 percent carbon dioxide (the remainder is nitrogen). The composition of expired air is approximately 16 percent oxygen and 4.5 percent carbon dioxide. Within the alveoli, the oxygen content of the air is 14 percent and the carbon dioxide content is 5.6 percent.

### D. Relationship of Oxygen and Blood

An interchange of gases takes place between the alveoli and the blood in the lung capillaries. The blood extracts oxygen from the alveoli and returns carbon dioxide. The partial pressure of the oxygen in the alveoli, being higher than that of the blood entering the lung capillaries, forces oxygen into the blood by physical diffusion. In the fraction of a second that the blood is present in the blood capillary, enough diffusion takes place to raise the oxygen partial pressure of the blood to almost that of the alveoli. As the oxygen is passing into the blood stream, carbon dioxide is being diffused in the opposite direction: from the capillary blood to the alveoli. This occurs because the partial pressure of the carbon dioxide in the capillary blood is higher than the partial pressure of the carbon dioxide in the alveolar air.

The gaseous exchange between the blood and the tissues is the reverse of that taking place in the lungs, since the oxygen concentration is lower and the carbon dioxide concentration is higher in the tissues than in the arteries.

### E. The Control of Respiration

Although some control can be exercised over breathing, it is essentially involuntary, controlled automatically by the rhythmical discharge of impulses from nerve cells in the medulla of the brain. This involuntary control of respiration is influenced

## BASIC PHYSIOLOGICAL SYSTEMS

principally by changes of carbon dioxide concentration in the blood. (Changes in oxygen concentration can also influence the breathing rate, but this is an indirect influence through chemoreceptors in the walls of the aorta and the carotid arteries.) Whenever the carbon dioxide concentration of the blood is increased, the excess directly stimulates the respiratory system to increased activity, and deeper, faster breathing follows.

As bodily activity increases, more carbon dioxide is produced, which increases the concentration of carbon dioxide in the venous blood. This, in turn, raises the carbon dioxide content in the alveolar air, which reduces the carbon dioxide partial pressure gradient between the blood and the alveoli. With a lower pressure gradient, less carbon dioxide is passed out of the blood during pulmonary circulation. The carbon-dioxide-laden blood stimulates the chemoreceptors and the respiratory center, increasing the rate of stimulation from the respiratory center. This acts to increase the activity of the muscles concerned with respiration through excitation of their motor nerves. The resulting increase in ventilation augments the renewal of alveolar air and decreases its carbon dioxide content. The decrease in carbon dioxide concentration in the alveoli increases the passage of carbon dioxide from the blood and permits the breathing rate and depth to return to normal.

A lack of oxygen in the blood causes the chemoreceptors to increase respiration; however, this only occurs when the oxygen content of the blood is reduced significantly. The only effect of decreased oxygen on the respiratory center in the brain is a depression, which is characteristic of a lack of oxygen on nerve tissues in general.

### F. Minute Volume

Although respiratory depth and rate are important, the product of these two, minute volume, is a more significant index of pulmonary ventilation. The minute volume is the volume of air taken in during each breath times the number of breaths per minute; i.e., the total volume of air breathed per minute. The initial adjustment to increased bodily activity is an increase in the depth of respiration, but as bodily activity reaches a high level and there is a demand for further increases in ventilation, the respiratory rate is increased. In adults at rest, the normal range of respiratory rate is between 12 and 20 complete cycles per minute, although rates of 2 to 30 per minute have been observed in normal persons. The pulmonary ventilation rate for an adult at rest is between 5.8 and 10.3 liters per minute.

## II. Basic Monitoring Methods

There are two basic methods for obtaining information concerning the respiratory system: by monitoring the flow of inspired and expired air and by monitoring the movements of the chest caused by breathing.



## RESPIRATORY SYSTEM

### A. Air Flow Measurements

A temperature-sensitive device, such as a thermistor, may be used to monitor the respiratory rate by converting the difference in temperature between the inspired air and the expired air to variations of electrical resistance. The sensing device usually is located in the subject's mask or head attachment.

The depth of respiration is a measure of the volume of air inspired during each respiration. This volume can be measured by inserting a temperature-sensitive device in the oxygen line and by monitoring the changes in temperature in the line caused by the mass flow of oxygen.

The best method of measuring respiratory rate, monitoring air flow, requires that the subject wear a mask or other type of head attachment. If the subject cannot be encumbered with this equipment, measurement is difficult.

### B. Chest Movement Measurements

Respiratory rate and depth may be measured by encircling the chest of the subject with a strap and measuring the change of chest circumference. The ends of the strap (nonelastic) are connected to a strain gage which provides electrical indications of chest expansion and contractions.

Chest bands constrict the subject, affect his breathing, and often create abdominal expansion which does not register on the strain gage. Artifacts, as a result of movements not associated with respiration, may be introduced. In addition, the chest strap is difficult to calibrate.

### C. Minute Volume

Any combination of transducers which records respiration rate and depth may be used to measure minute volume by feeding the results of the two readings into an integrating circuit. The majority of the transducers used in measuring minute volume described thus far require that an oxygen mask be used. When a full pressure suit is used in lieu of a mask, the chest-strap strain-gage transducer must be relied upon to measure respiration rate, depth, and their product: minute volume.

### D. Oxygen and Carbon Dioxide Partial Pressure

The oxygen and carbon dioxide content of expired air may be determined by polarographic means. In this method, the current from a special voltaic cell is dependent on the presence of either oxygen or carbon dioxide, depending on the design of the cell. Current output is proportional to the amount of gas present. Two cells, one for each of the gases, are required.

## BASIC PHYSIOLOGICAL SYSTEMS

This technique is more practical for monitoring the environmental air of a cockpit or space vehicle than for monitoring expiratory air directly, since the response time is rather long. The response time for the oxygen sensor is approximately 1 minute, while the response time for the carbon dioxide sensor is about 3 minutes. These are not excessive if the partial pressures are not expected to vary at rapid rates.

The cell electrodes are pressure sensitive; consequently, the pressure must either be controlled or it must be recorded so that correction factors may be applied.

Other more commonly used systems for measuring the partial pressures of oxygen and carbon dioxide are not suitable for space vehicles or high-altitude aircraft because of the weight and space limitations of these craft.

### CIRCULATORY SYSTEM

#### I. Description and Function

The circulatory system consists of the heart and vessels, which circulate the blood to all parts of the body, and the lymphatics, which return excess tissue fluid to the blood stream. This system is the means by which nutrients and oxygen are distributed to the body cells and their wastes and carbon dioxide are carried away.

##### A. Heart

The heart furnishes the power to maintain the circulation of the blood. There are four chambers in the heart (figure 5): two upper chambers called the atria, and two lower chambers called the ventricles. The two chambers on the right side of the heart

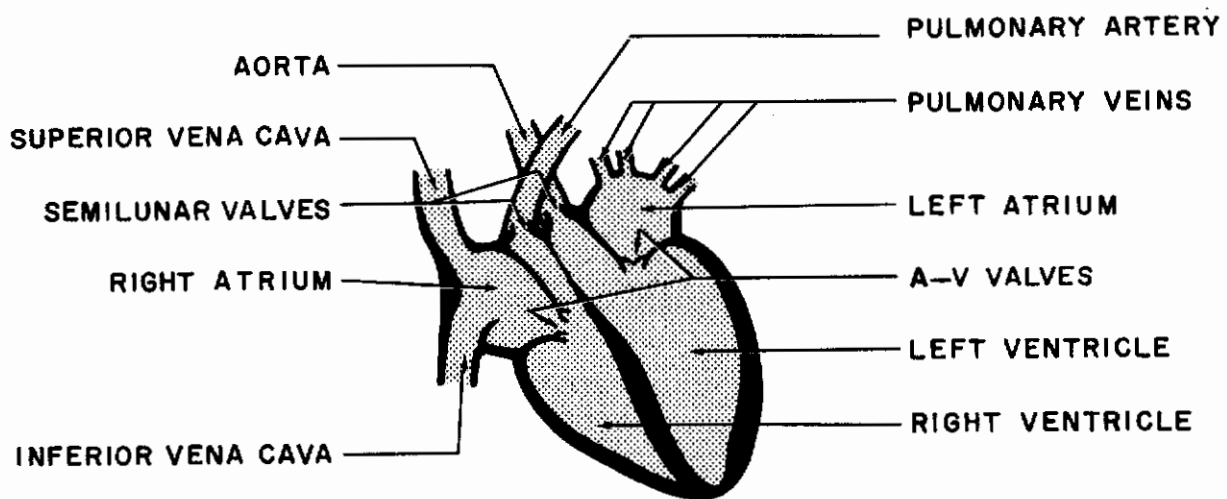

Figure 5. The Chambers of the Heart

## CIRCULATORY SYSTEM

are associated with pulmonary circulation; that is, the venous blood returning to the heart enters the right atrium and passes through the right ventricle into the lungs, where it gives up carbon dioxide and absorbs oxygen. Oxygenated blood returning from the lungs enters the left atrium and passes through the left ventricle into the systemic circulation system which serves the body. Between each atrium and ventricle there is a valve (A-V valve) which permits blood to pass only from the atrium to the ventricle and not in the reverse direction. Between each ventricle and its artery, there is a one-way semilunar valve which allows blood to pass into the arteries, but blocks its re-entry to the ventricle. The pumping action of the heart results from pressure changes within various sections of the heart because of the contracting of heart muscles. The rhythmic contraction of the heart muscle constitutes the heart beat, and the sequence of events occurring during one beat of the heart is called the cardiac cycle.

### 1. Cardiac Cycle

The cardiac cycle begins with the contraction (systole) of the right atrium, followed closely by the contraction of the left atrium. After a short pause, both ventricles contract. The contraction of each chamber is followed by its relaxation (diastole) and then by a brief period of inactivity. During these contractions, the valves between the chambers of the heart and between the heart and the arteries respond to the changes of pressure to determine the direction of flow through the heart. Figure 6 illustrates the pressure changes occurring during the cardiac cycle. Venous blood, returning from the lungs and from the systemic circulation, flows into the left and right atria, respectively, during the period of atrial diastole (relaxation). As the atria fill with blood, the pressures within the atria rise. When the pressures within the atria exceed the pressures within the ventricles, the A-V valves between the chambers open and blood flows into the ventricles. This accomplishes the greater part of ventricular filling. Atrial systole begins, completing ventricular filling, but although this aids, it is not the chief factor in moving blood into the ventricles.

During the latter part of atrial systole, ventricular systole is initiated. The pressures mount rapidly, and, when they exceed the pressures in the atria, the A-V valves between the atria and the ventricles close, preventing the return of blood to the atria. As the pressures in the ventricles continue to rise, they finally exceed the pressures in the arteries and cause the semilunar valves to open. The sudden ejection of blood into the arteries increases arterial pressures and decreases ventricular pressures. When the pressures in the ventricles fall sufficiently (below arterial pressures), the semilunar valves snap shut.

About the time the semilunar valves open and the ventricles begin to empty, atrial diastole begins. As the ventricle muscles relax, the intraventricular pressures continue to fall until the pressures in the atria open the A-V valves and the cardiac cycle is repeated.

*Contrails*  
BASIC PHYSIOLOGICAL SYSTEMS

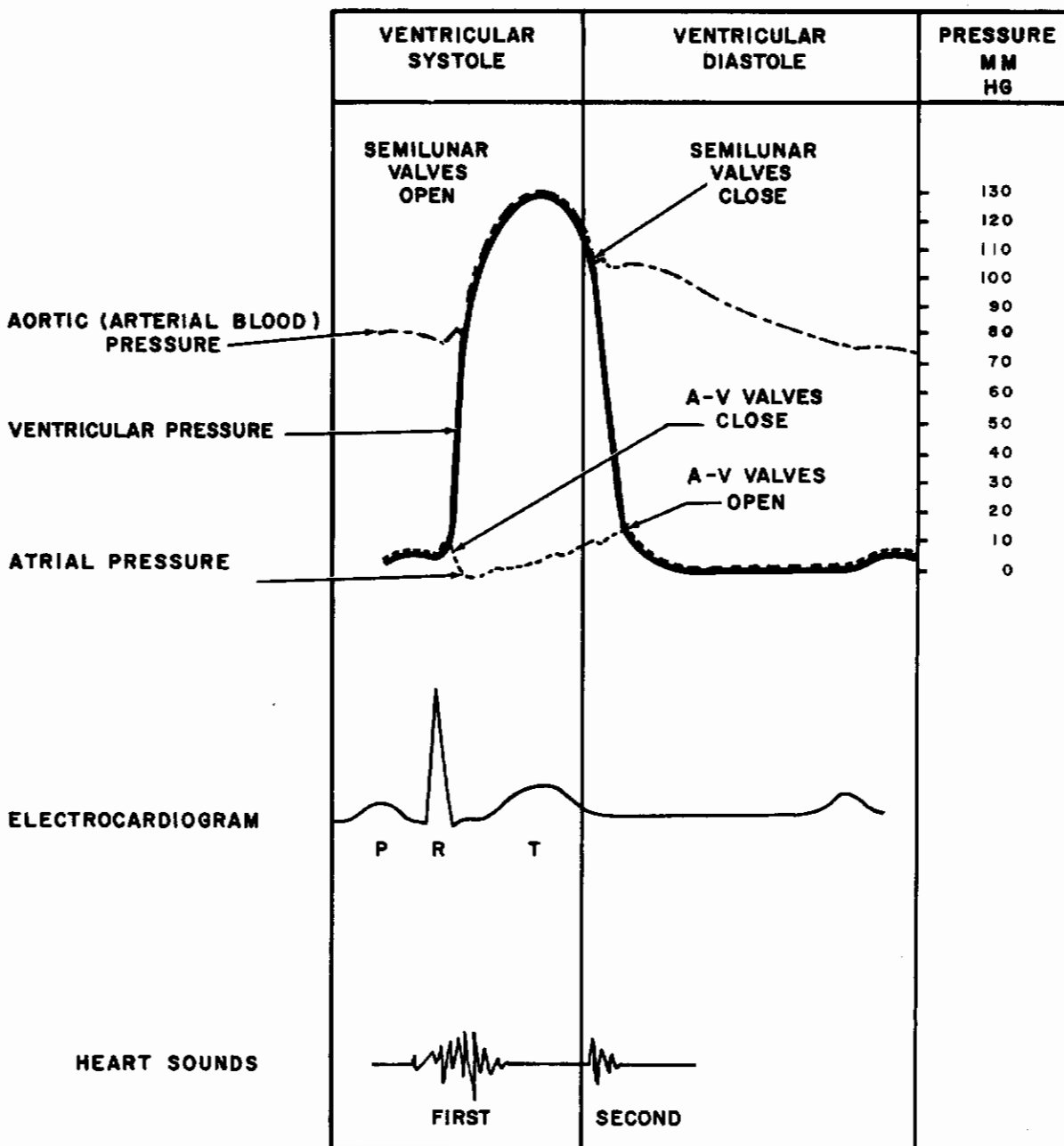

Figure 6. Cardiac Pressure Cycle with Corresponding EKG and Heart Sounds



## CIRCULATORY SYSTEM

### 2. Electrical Activity

Electrical changes precede each contraction of the heart and are partly responsible for the onset of contractions. Because of the chemical and physical processes at work, an active, contracting region becomes electrically negative to a resting, relaxed region. (The electrical phenomena of activity are described under BIOELECTRIC MEMBRANE CHARACTERISTICS, page 38.) The electrical activity of the cardiac muscles is of sufficient intensity to be transmitted to the surface of the body, and may be observed at almost any spot on the body. Figure 6 shows the relationship of cardiac potentials to the cardiac cycle.

### 3. Heart Sounds

During each cardiac cycle, two sounds are produced by the heart. The first sound, which is longer lasting, lower pitched, and softer than the second, results from the noise of the A-V valves closing and the sound of muscle contraction in the ventricles (figure 6). The snapping shut of the semilunar valves at the start of ventricle diastole produces the second sound.

#### B. Blood Vessels

As mentioned previously, blood leaving the left ventricle is distributed through arterial branches which ramify to all parts of the body. Blood travels from these branches into capillaries which supply all of the tissues. The capillaries unite to form veins; the blood in the veins returns to the heart where it enters on the right side. Blood leaving the right side of the heart divides into two branches and carries blood to the lungs, where it passes through a network of capillaries lying close to the air sacs (alveoli) of the lungs. Here the blood exchanges carbon dioxide for oxygen. The capillaries then coalesce into veins, which return oxygenated blood to the left side of the heart.

The circulatory system not only serves to carry oxygen to body cells and to remove carbon dioxide, but it also is responsible for a number of functions which may be considered nutritive, excretory, regulatory, and protective. The blood vascular system accomplishes these functions maintaining a constant cellular environment. As blood flows through the body, it carries metabolic products such as glucose, acids, fats, minerals, etc, from the digestive tract to the body cells. It removes the waste products of metabolism and transports them to the excretory organs. It distributes hormones from endocrine glands to cells. Water is transported in the blood to excretory organs to aid in maintaining a constant water level in the body, and peripheral circulation aids in maintaining constant body temperature. Antibodies and white corpuscles also are transported by the blood to aid in fighting injurious agents.

The blood supply in any part of the body may be varied greatly by the nervous system and other systems of the body acting upon the heart and the blood vessels. The

# *Contrails*

## BASIC PHYSIOLOGICAL SYSTEMS

heart can be made to pump more blood, or the same amount at a higher pressure. The blood supply to a part of the body can be altered by an increase or decrease in the caliber of blood vessels. These changes occur as a result of nervous control or through chemical means.

The nervous control of circulation is exerted chiefly by reflexes originating in the atria, aortic arch, carotid sinus, and mesentery. These reflexes are integrated in the medulla, hypothalamus, and higher centers in the central nervous system (see BEHAVIORAL SYSTEM, page 6), and exert their control over the circulation by way of the vagus and sympathetic nerves to the heart and the vasomotor nerves to the blood vessels. In certain circumstances, a chemical control may be exerted directly by secretions of the adrenals and kidney, and indirectly by the chemoreceptors in the aortic arch and the carotid body.

### C. Lymphatic System

The lymphatic system is an accessory part of the circulatory system. It gathers the excess tissue fluids from the body cells, strains foreign particles and bacteria from the fluid, and empties the fluid into the veins.

The blood in the circulatory system flows from the heart through the arteries into smaller and smaller blood vessels. The smallest of these vessels, the capillaries, feed the nutrients contained in the blood to the tissue cells of the body by diffusion through the capillary walls. These nutrients are in the form of a watery solution called tissue fluid. When the cells have assimilated the nutrients in the fluid, some of the fluid is returned to the capillaries from which the blood flows on to the veins and thence back to the heart.

The excess tissue fluid remaining in the body cells filters into other small tubes, the lymph capillaries. These capillaries merge with larger and larger lymph vessels until the fluid, now known as the lymph, is returned to the veins.

The flow of lymph is maintained by the pumping action of muscles and fluctuation in intrapleural pressure. However, the rate of flow is slow in comparison to the flow of blood in the circulatory system.

### D. Blood Pressure

Blood pressure is the result of the pumping action of the heart which empties blood into a closed system of elastic blood vessels. The volume capacity of this system changes as a result of the stretching of the vessels and by caliber changes in response to nervous and chemical stimuli.

During ventricular systole, blood is forced into the highly elastic arterial system faster than it can escape into the arterioles, capillaries, and veins. The arteries

# *Contrails*

## CIRCULATORY SYSTEM

therefore are stretched to greater capacity. Since blood is leaving the arterial system constantly and passing into the capillaries, the pressure falls when the flow of blood into the artery is stopped at the end of ventricular systole. The elastic recoil of the arterial walls forces the blood onward through the capillaries at a constantly decreasing pressure until the arteries regain their presystolic caliber (see figure 6). The energy that was stored in the arterial walls during the stretching of the vessels is expended between heart beats, ensuring a relatively continuous flow of blood through the arterioles and capillaries. The pulsations of the arteries are convenient indications of heart rate.

The blood pressure is maintained at a normal level by a combination of five factors: cardiac output, peripheral resistance, blood volume, elasticity of the arterial walls, and blood viscosity.

### 1. Cardiac Output

The heart controls the amount of blood that is ejected into the arteries during each cycle; therefore, anything that increases cardiac output (if other factors are kept constant) increases arterial pressure. Variations in cardiac output in response to bodily activity are determined by changes in venous return (the rate at which blood is returned to the heart), the force of the heart beat, and the frequency of the heart beat.

The venous return to the heart is (1) increased by the contraction of skeletal muscles (increased activity), (2) increased by deep respirations, (3) decreased by the dilation of blood vessels over a wide area, and (4) affected by the force of gravity (dependent on the position of the subject).

The heart rate is determined by nervous, chemical, and thermal control. The heart is innervated by the vagus nerves, which are part of the parasympathetic division of the autonomic nervous system, and the accelerator nerves, which are part of the sympathetic division. These nerves are mutually antagonistic in that the vagus nerves decelerate the heart rate while the accelerator nerves accelerate the heart beat. Besides these nervous controls, the heart rate may be increased or decreased by chemical action. Hormones released by the vagus nerves and hormones of the endocrine system, especially those released by the thyroid and adrenal glands, may increase or decrease the heart rate. A great excess of carbon dioxide or a marked lack of oxygen depresses the excitability of both the heart muscles and the cardiac centers in the medulla. A rise in body temperature also increases the heart rate.

### 2. Peripheral Resistance

Variations in the caliber of blood vessels change the resistance to the flow of blood, and this resistance is referred to as peripheral resistance. Stimulation of almost any somatic sensory nerve can change the caliber of blood vessels. An excess of carbon dioxide or lack of oxygen acts directly to depress the vasomotor centers,

## BASIC PHYSIOLOGICAL SYSTEMS

which control the constriction or dilation of blood vessels. Moderate increases in the carbon dioxide content of the blood or a lack of oxygen stimulates the chemoreceptors in the aortic and carotid bodies (major arteries leaving the heart) and causes vasoconstriction, which increases the arterial pressure. The temperature of the tissues through which the vessels pass also affects the caliber of blood vessels. A rise or a moderate drop in temperature dilates the vessels, while a marked drop in temperature constricts the vessels.

### 3. Blood Volume

The circulatory system is a closed system which normally is filled with blood under pressure. Because of the elasticity of the vessels, additional blood can be added to the system after it is filled, which increases the pressure. Conversely, withdrawal of fluid (as in a hemorrhage) decreases the arterial pressure. Blood volume must be kept above a minimum level or circulation ceases.

### 4. Elasticity of the Arterial Walls

The elasticity of the arterial walls maintains a relatively constant flow of blood to the capillaries by storing the excess energy of the ventricular contraction (systole) and releasing this energy during ventricular diastole. The pressure maintained by the recoil of the arterial walls is known as the diastolic pressure. (This is also the minimum pressure which occurs during ventricular diastole.) The diastolic pressure is affected far less than systolic pressure (the maximum pressure occurring during ventricular systole) by changes in most of the factors maintaining blood pressure.

### 5. Blood Viscosity

The more viscous the blood, the greater is the force required to set it in motion because of its greater resistance to flow. The viscosity of blood is determined largely by the number of formed elements present and, to a lesser degree, by the concentration of plasma proteins. If either of these factors decreases, resistance drops and blood pressure falls. However, since blood viscosity varies only slightly, its effects are negligible.

## II. General Monitoring Methods

The obvious parameters to be measured for monitoring the circulatory system are the pulse rate and arterial pressure. However, other measurements, such as the variation and rate of change of pulse rate, cardiac cycle, flow rate of blood through specific arteries or body tissues, and the partial pressure of oxygen carried by the blood, can provide important information.



### A. Pulse Rate

As oxygen-rich blood leaves the heart under high pressure, some of its flow energy is expended in distending the elastic walls of the large arteries. The recoil of these arteries then forces the blood through the system after ventricular systole. This distension and recoil is responsible for the pulse wave which can be felt in any artery. A pulse occurs with every systole; therefore, the pulse rate can be measured to determine heart rate.

A transducer may be placed over any artery to pick up the pulse. The most common position is the wrist where the radial artery runs just below the skin. Pulse rate or heart rate also may be measured by using electrocardiographic leads to pick up cardiac muscle potential. In this case, the potential picked up by the leads is passed through a filter to eliminate high frequency electromyographic potentials. The resulting wave is clipped so that only the peak of the ventricular systole potential (QRS complex of the electrocardiogram) remains, and this information is amplified and fed into a counter (cardiotachometer) to record the heart rate. (The leads used in electrocardiography and the QRS complex are described under Cardiac Activity, page 27.)

Gross body movement and muscular activity create random signals that interfere with pulse rate measurements at the wrist or at the chest. All types of instrumentation for measuring pulse rate require filters to eliminate these random signals. In addition, there are other problems resulting from the use of electrocardiographic leads to record pulse rate similar to those described for monitoring the cardiac cycle.

### B. Blood Pressure

Blood pressure is a major parameter in monitoring the circulatory system. However, the pressures recorded at various points on the body are different, since blood would not flow if there were not a pressure gradient (a progressive drop in pressure from the large arteries to the smaller arteries, the arterioles, the capillaries, and the veins). Therefore, to obtain comparative blood pressure information, blood pressure must be recorded at the same place. Almost all blood pressure measurements are made on the forearm at the present time. At this location, it is quite easy to measure both systolic pressure (the maximum pressure which occurs during ventricular systole) and diastolic pressure (the minimum pressure which occurs as a result of arterial recoil during ventricular diastole) by auscultation. The difference between the systolic and diastolic pressures is called the pulse pressure.

A physician normally measures arterial pressure by encircling the arm with an inflatable cuff, and placing a stethoscope, microphone, or other listening device over the brachial artery below the cuff in a position where the pumping sounds of the heart are clearly audible. The cuff is inflated until the pressure in the cuff is greater than the arterial pressure; at this point, no sounds are heard, since arterial pressure is

# *Contrails*

## BASIC PHYSIOLOGICAL SYSTEMS

insufficient to force blood past the cuff. The pressure in the cuff is released slowly until the lumen in the compressed artery is opened enough to allow the passage of a jet of blood with each heart beat (ventricular systole). The pressure in the cuff at this point, recognized by the sound of the blood in the artery, represents the systolic pressure. As the cuff pressure is reduced further, the sound changes in quality and disappears completely when the blood flows continuously through the artery. The pressure in the cuff at this point is the diastolic pressure.

Blood pressure may be monitored by partially automating the above procedure. The cuff is made to inflate rapidly to a pressure above any anticipated systolic pressures, after which the gas is bled off slowly, reducing the pressure below any anticipated diastolic pressures, and the remaining pressure is dumped. This procedure may be sequenced to repeat at specific intervals. A transducer in the cuff provides an electrical indication of the pressure in the cuff. A microphone or other listening device placed over the brachial artery, immediately below the cuff, supplies the arterial sounds. The output from the listening device may be combined with the pressure transducer output so that only one signal need be transmitted. The pressure at which the sound resumes after being stopped by the peak cuff pressure indicates systolic pressure, and the pressure at which the sound ends represents the diastolic pressure. If it is inconvenient to monitor blood pressure by auscultation, the microphone may be eliminated and a transducer inserted under the occluding cuff, directly over the brachial artery. This pulse-sensing transducer may be a flexible bladder containing fluid and connect hydraulically to a pressure transducer. A strain gage could be mounted directly over the brachial artery and under the occluding cuff, but the signal from the strain gage would have to be amplified before the data could be telemetered.

The cuff method of monitoring blood pressure gives data comparable to that obtained by most clinicians; therefore, values of blood pressure taken of a subject in an abnormal environment may be compared with normally accepted values. This is only true, however, if the pressures in the abnormal environment are the same as atmospheric. Blood pressure is recorded in terms of gage pressure, which is the difference between the pressure in the cuff and atmospheric pressure. In an abnormal environment, if the environmental pressure is not equivalent to atmospheric pressure, all pressure readings must be converted to some common denominator so they can be compared. The pressure to which the cuff is inflated will vary, since the gas is admitted to the cuff until it reaches a constant gage pressure or constant volume, both of which vary with environmental pressure and temperature. Provisions must be made so the pressure exceeds systolic pressure under every condition.

If an automatic inflating-cuff device is used to monitor blood pressure, several factors must be considered. The test must be done quickly to provide a minimum of discomfort to the subject and to avoid impeding his activities. A tank of air must be provided for the remotely located subject to inflate the cuff for the test, thereby creating a space and weight problem. Serious errors may develop if the subject is doing more than light arm or wrist movements while being seated. Environmental noise

# *Contrails*

## CIRCULATORY SYSTEM

and vibration can create erroneous signals in automated monitoring systems.

### C. Cardiac Activity

The cardiac cycle may be monitored by the (1) electrical potentials generated by the contracting cardiac muscles (electrocardiography), (2) small movements produced in various parts of the body under the influence of displacements of the heart and blood occurring in connection with cardiac activity (ballistocardiography), or (3) movements of the heart by radiating ultrasonic waves from the chest wall to the heart and using the Doppler effect to detect motion (phonocardiography). Only the first of these three methods is discussed here, since the artifacts in the other two techniques are sufficient to restrict their use to the laboratory at the present time. In addition, considerably more data have been obtained on cardiac cycles through electrocardiography, and norms have been established from millions of tests.

#### 1. Electrocardiographic Potentials

If the heart were a homogeneous sphere of muscle, the potentials generated would be the same everywhere. This, however, is not the case for the muscles of the left ventricle are considerably thicker than those of the right ventricle, and the anatomically nonsymmetrical ventricles form a U-shaped shell with the open portion in the region of the atrio-ventricular valves.

#### 2. Standard Limb Leads

The activities of the cardiac muscles, as previously noted, are accompanied by electrical changes. These potential changes are transmitted to the surface of the body where they may be recorded and correlated with heart action. Since it is important for standardization purposes that potentials be read from the same places each time, and since the limbs are the only locations that are equipotential over a large area, three standard combinations of instrument lead connections have been adopted universally. Standard limb lead I measures the potential difference between the right and left arms; lead II measures the potential between the right arm and left leg; and lead III measures the potential between the left arm and left leg.

#### 3. Electrocardiogram

Figures 6 and 7 show typical electrocardiograms using any of the three standard limb leads. The letters on the various parts of the curve shown in figure 7 indicate the correlation with heart action. The P wave, the first upward deflection in the cycle, represents the period of atrium excitation (depolarization of atrial musculature). The PR interval, from the beginning of the P wave to the beginning of the QRS complex, represents the time required for excitation to travel through the atrial to the ventricular muscle. The QRS complex (beginning of Q to end of S) is the time required for the excitation waves to spread through the ventricle walls (usually from about 0.05

## BASIC PHYSIOLOGICAL SYSTEMS

to 0.10 second). The beginning of the complex represents the beginning of ventricular depolarization, while the end of the complex indicates the end of ventricular depolarization. Ventricular systole occurs during the QT interval. The duration of the depolarized state is measured from the end of the QRS complex to the beginning of the T wave. The smooth hump following the QRS complex is the T wave, which represents the wave of ventricular repolarization.

Electrocardiography has well-established standard values that are available in numerous handbooks. Typical values, therefore, are not presented in this handbook, except to illustrate relative time intervals in an electrocardiogram.

Primarily, the electrocardiogram permits the monitoring of the circulatory factors of heart rate and rhythm. The frequency of ventricular systole indicates the heart rate. Also, the presence of fibrillation (and premature atrial and nodular contractions), tachycardia, heart block, and marginal anoxia can be detected.

Since the peak voltage appearing in an electrocardiograph signal using standard electrode arrangements is approximately 2 millivolts, the signal must be ampli-

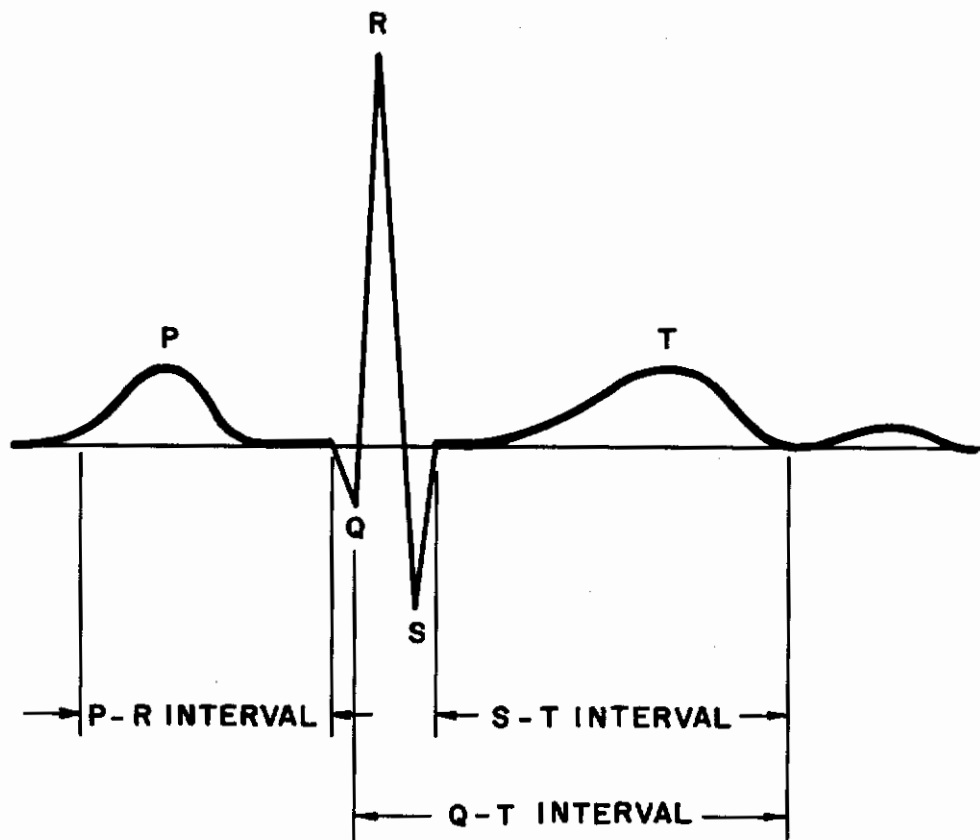

Figure 7. Composition of the Electrocardiogram



# *Contrails*

## CIRCULATORY SYSTEM

ried considerably, and the amplifiers and recording equipment must be selected carefully to avoid introducing excessive artifacts. The electrodes should be nonpolarized and must not be placed over large muscle masses where they can detect electromyographic potentials. In addition, they must be attached to the body firmly to prevent the skin from moving beneath the electrodes. Artifacts are introduced through impedance changes resulting from changes in galvanic skin reflexes, but little can be done about these except to try to avoid locations where there are numerous sweat glands, and to recognize the artifacts when they appear in the record.

### D. Blood Flow Rate

Measurement of blood flow rate is important for detecting changes in the internal resistance of blood vessels as well as for diagnosing circulatory ailments. The flow of blood may be monitored directly by flowmeters or indirectly by volume plethysmographs. There are two types of flowmeters, electromagnetic and sonic. The electromagnetic flowmeters employ the use of an electromagnetic field in which a blood vessel is placed. Two electrodes are connected to the vessel and the potential difference between the electrodes is measured. The sonic flowmeter measures the time required for a sound wave to travel a measured distance in a vessel. This time factor is a function of blood velocity.

Plethysmography offers the advantage that the veins or vessels need not be exposed to be monitored. With impedance plethysmographic techniques, the change in the volume of body tissues is used to indicate the quantity of blood they contain. A low-voltage, radio-frequency signal is passed through the subject's finger or other portion of the body. The received signal indicates the rhythmical variations in electrical impedance resulting from pulsatile volume changes (and consequently heart beat). This impedance curve may be correlated with cardiac output, or the information may be fed into a differentiating network to yield the relative change in the velocity throughout the cardiac cycle in a given pulse region. This technique generally is considered "delicate" and difficult to standardize.

Blood flow rate also may be monitored by plethysmographic methods using strain-type gages. A strain gage is connected to a strap encircling the subject's finger, arm, or calf to measure the girth of the limb. An occluding cuff is provided below the gage to occlude arterial flow (except on the finger), while another cuff above (on the heart side) the gage occludes venous flow. The change in girth may be calibrated to record flow rate. This type of device could be integrated with the occluding cuff used for determining blood pressure, thereby reducing the discomfort to the subject being monitored.

### E. Oxygen Saturation of Blood

The oxygen saturation of the blood may be determined by measuring the percentage of hemoglobin in the blood in oxygenated form with a photoelectric

## BASIC PHYSIOLOGICAL SYSTEMS

photometer. The absorption qualities of oxygenated hemoglobin and reduced hemoglobin differ considerably. Figure 8 shows two curves illustrating the transmission qualities (or absorptive qualities) of oxygenated hemoglobin and reduced hemoglobin as functions of wavelength of transmitted light. Obviously, oxygenated and reduced hemoglobin absorb the light of wavelengths in the region of 640 millimicrons (red) quite differently, while light of 800 millimicrons wavelength is absorbed equally by both forms of hemoglobin. A device can be constructed, therefore, using a photocell for each wavelength (640 and 800 millimicrons). The light of each wavelength is transmitted through a thin section of the body, such as the projecting part of the external ear, and is detected by the photocells. The difference between the readings at each wavelength is a function of the oxygen saturation of the blood.

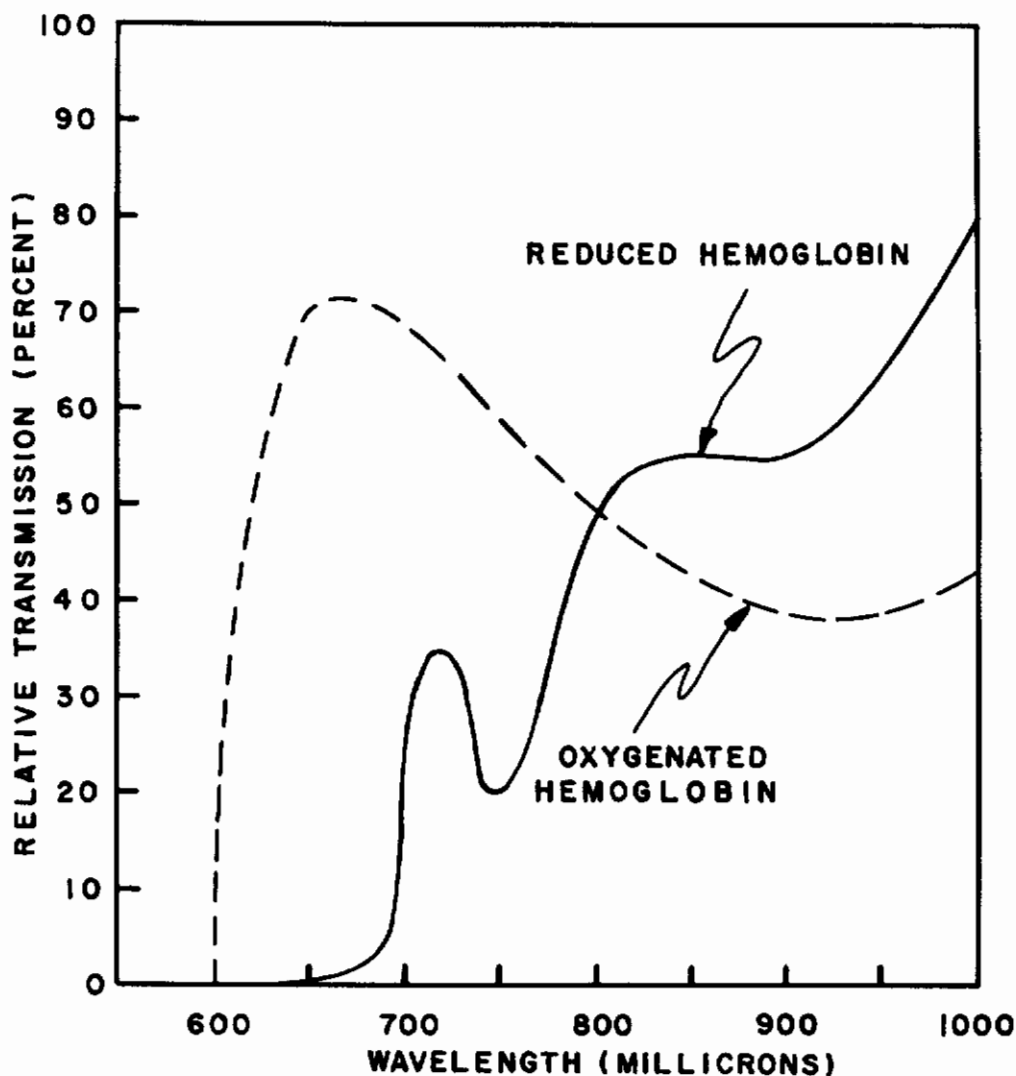

Figure 8. Light Absorption by Hemoglobin

# *Contrails*

## CIRCULATORY SYSTEM

To correct for the ear tissue interposed in the optical path of the device, a pressure device (mechanical or pneumatic) can be used to force blood from the ear so that the light absorption of the bloodless tissue can be measured. The light absorption of the blood alone would be the difference between the readings with the ear occluded and with the ear open to circulation. This technique is subject to artifacts from G forces and vibration that affect equipment performance.

### METABOLIC SYSTEM

#### I. Description and Function

The metabolic system includes those processes and chemical reactions which occur in the body that convert food into simpler substances and supply the energy for vital functions such as muscular activity. The building up or assimilative processes (formation of protoplasm) that make possible the growth and repair of tissues is referred to as anabolism. Catabolism is the breaking down or destructive process which releases energy needed for muscular activity. The source of the energy is the chemical energy of the food materials which is transformed by oxidation to heat and mechanical energy (or work).

The elements needed for the metabolic process are taken into the body through the lungs (oxygen) and the alimentary canal (food and water). As the foodstuffs in the body are oxidized by the oxygen carried in the blood, they form carbon dioxide, nitrogen-containing products, water, and heat. The total heat produced by cell metabolism is an index of total metabolism.

Since the heat produced by the oxidation of foodstuffs in the body varies at different times due to different circumstances, a standard for each individual must be established. This standard is the Basal Metabolic Rate (BMR), which is the heat produced under standard conditions with activity reduced to a minimum. Basal metabolism is the energy expenditure of a subject who is lying down at complete muscular and mental rest, some 12 to 14 hours after taking food. The environmental temperature should be maintained at about 20°C. Under these basal conditions, the three factors that are prominent in stimulating metabolism (physical exercise, ingestion of food, and environmental temperature) are controlled. The generated heat results mainly from the activity of the heart, glands, and respiratory movements, and indicates the energy necessary to maintain vital processes. Basal metabolism is proportional to the surface area of the individual, and for normal healthy men between 20 and 50 years old, it is approximately 38 to 40 calories per square meter per hour.

#### II. Basic Monitoring Methods

Since man is a warm-blooded animal and maintains within his body a surprisingly uniform temperature, the study of heat production is used as the principal measure of metabolism. Heat production results from oxidizing foodstuffs within the body; there-

## BASIC PHYSIOLOGICAL SYSTEMS

fore, measuring oxygen consumption is an indirect way of measuring heat production.

At one time, the procedure consisted of measuring the oxygen inhaled, the oxygen and carbon dioxide exhaled, and the nitrogen content of the urine excreted during the testing period. The inhalations and exhalations indicated how much of each of the three basic foodstuffs was oxidized and how much heat was produced. The nitrogen content of urine was indicative of the amount of protein oxidized. It has been found since that there is a constant relationship between the amount of oxygen consumed and the amount of heat produced. Data on oxygen consumption are converted easily to indications of heat production.

### III. Problem Areas

Except where there is arterial oxygen unsaturation, the rate of oxygen absorption within the lungs is a close measure of the rate of intracellular oxidation and of heat production. The rate of oxygen absorption in the lungs is relatively unaffected by moderate changes in lung ventilation. If carbon dioxide production is measured, however, it should be remembered that carbon dioxide elimination is particularly sensitive to changes in character and degree of lung ventilation. Blood and other body fluids contain a large amount of carbon dioxide in loose combination, which is readily washed out by overventilation of the lungs. While this is of little concern with an apparatus monitoring oxygen consumption alone, determinations of carbon dioxide production would be invalidated, and next to leaky apparatus, this sensitivity to lung ventilation has been the major problem.

## EXCRETORY SYSTEM

### I. Description and Function

The primary organs of the excretory system are the kidneys, although the lungs, skin, and large intestines also have excretory functions. The lungs excrete carbon dioxide and some water, and the skin, while regulating body temperature, excretes water and salts. The lining of the large intestine excretes calcium and iron into the lumen where they are eliminated with the feces. (Most constituents of the feces are not metabolic wastes and so they are not considered as excretory products.) The majority of metabolic wastes found in the blood are absorbed by the kidneys where they form urine, which is excreted from the body by the urinary system.

The kidneys, ureters, bladder, and urethra constitute the urinary system which rids the body of liquid and soluble waste products. Through the production and elimination of urine, the urinary system maintains a constant blood volume which helps maintain a constant blood pressure.

Urine formation is the result of two processes: filtration which takes place in the renal capsule, and reabsorption which occurs in the tubules of the kidneys. The rate of



## EXCRETORY SYSTEM

reabsorption varies to maintain a constant fluid level within the body. The formation and excretion of urine also acts to maintain the electrolytic and hydrogen ion balance of the blood. Acidity is regulated in the blood itself; however, the kidneys aid by producing ammonia from urea (a waste product of protein metabolism) and amino acids. This ammonia combines with water in the kidneys to form a base (ammonium hydroxide), which may be absorbed in the blood to neutralize the acid in the blood. The urine formed in the kidneys is transported to the bladder through the ureters. Micturition is initiated by the stimulation of afferent neurons in the bladder wall. When the pressure in the bladder is sufficient to stimulate the nerves (approximately 150 mm of water is adequate), the bladder contracts, while the sphincter (normally constricted to seal the bladder) relaxes, permitting the urine to be expelled through the urethra upon command.

### II. General Monitoring Methods

Any attempt to monitor the excretory system in an abnormal environment such as a space vehicle would be extremely complex. Monitoring systems would almost invariably require the collection of urine. On short-duration, abnormal environmental tests, it would, therefore, be impractical to monitor the excretory system.

Pressures and temperatures within the alimentary canal can be monitored if the subject swallows a radio pill with pressure or temperature transducers. The monitoring of the pill's progress through the body would provide some useful information, but would give no indication of the body's fluid level or kidney and bladder functions.

## ENDOCRINE SYSTEM

### I. Description and Function

The endocrine system is composed of glands which resemble ordinary glands in that they produce complex compounds from materials derived from the blood or lymph, but they differ in that they have no ducts for the discharge of their secretions. These secretions, called hormones, are distributed through the blood to regions scattered throughout the body. The hormones exert a specific influence on some part or activity of the body.

The endocrine system and the nervous system share in the control of all the activities of the body tissues. For the most part, the nervous system controls the more rapid responses of the body which require immediate response if the organism is to survive, while the endocrine system frequently controls the slower changes or adaptations of the body to its environment.

#### A. Endocrine Glands and Organs

The glands with definite endocrine functions (i.e., contain specific chemical

## BASIC PHYSIOLOGICAL SYSTEMS

substances which, after secretion into the blood, have specific functions) are the thyroid, parathyroid, adrenal, and pituitary glands. The pancreas, gonads (the primary sex organs), stomach, and small intestines also have endocrine functions. Other organs are thought to have endocrine functions: the kidneys are suspected of secreting a blood-pressure raising substance and the liver an anemia-preventing substance. These glands and organs are shown in figure 9.

### B. Functions of Endocrine Glands and Organs

The thyroid gland secretes the hormone, thyroxin, which regulates the basal metabolism rate and controls the liberation of heat after ingestion of food and during exercise. The parathyroid glands secrete a hormone which maintains the proper distribution of calcium in "storage depots" like bone and in body fluids. Calcium is important in the maintenance of healthy cellular activity, and in the control of muscular and nervous irritability.

Hormones secreted by the adrenal glands help to regulate the salt and water balance of the body fluids and also the level of carbohydrate substances in the blood, liver, and muscles. One of the adrenal hormones, adrenaline, in sufficient concentration, can produce effects similar to those occurring through stimulation of the sympathetic nervous system: faster heart rate, a steep rise in blood pressure, constriction of the arterioles in the abdominal viscera, release of glucose into the blood, and immobility in the digestive tract.

The relationship between the pituitary gland (the master gland) and the other endocrine glands is analogous to that of the brain to the nervous system. Although it is a small gland, it secretes more hormones than any other endocrine gland. These hormones regulate growth, sexual activities, and the amount of water secreted by the kidneys. They also aid in the control and use of carbohydrates and fats in the body, and coordinate the endocrine activities of the body by controlling the secretion of hormones by a number of other endocrine organs.

The endocrine portion of the pancreas secretes a hormone, insulin, which regulates the balance and utilization of carbohydrates in the tissues. Insulin also preserves the balance of blood sugar and insures adequate stores of glycogen in the liver and muscles.

The stomach and small intestine secrete substances which stimulate the functions of the liver and pancreas to aid in digestion.

### II. General Monitoring Methods

The endocrine system, with the nervous system, shares the responsibility for the functioning of the body during periods of stress. As a result, monitoring other systems of the body, such as the respiratory or circulatory systems, during stress situations can

ENDOCRINE SYSTEM

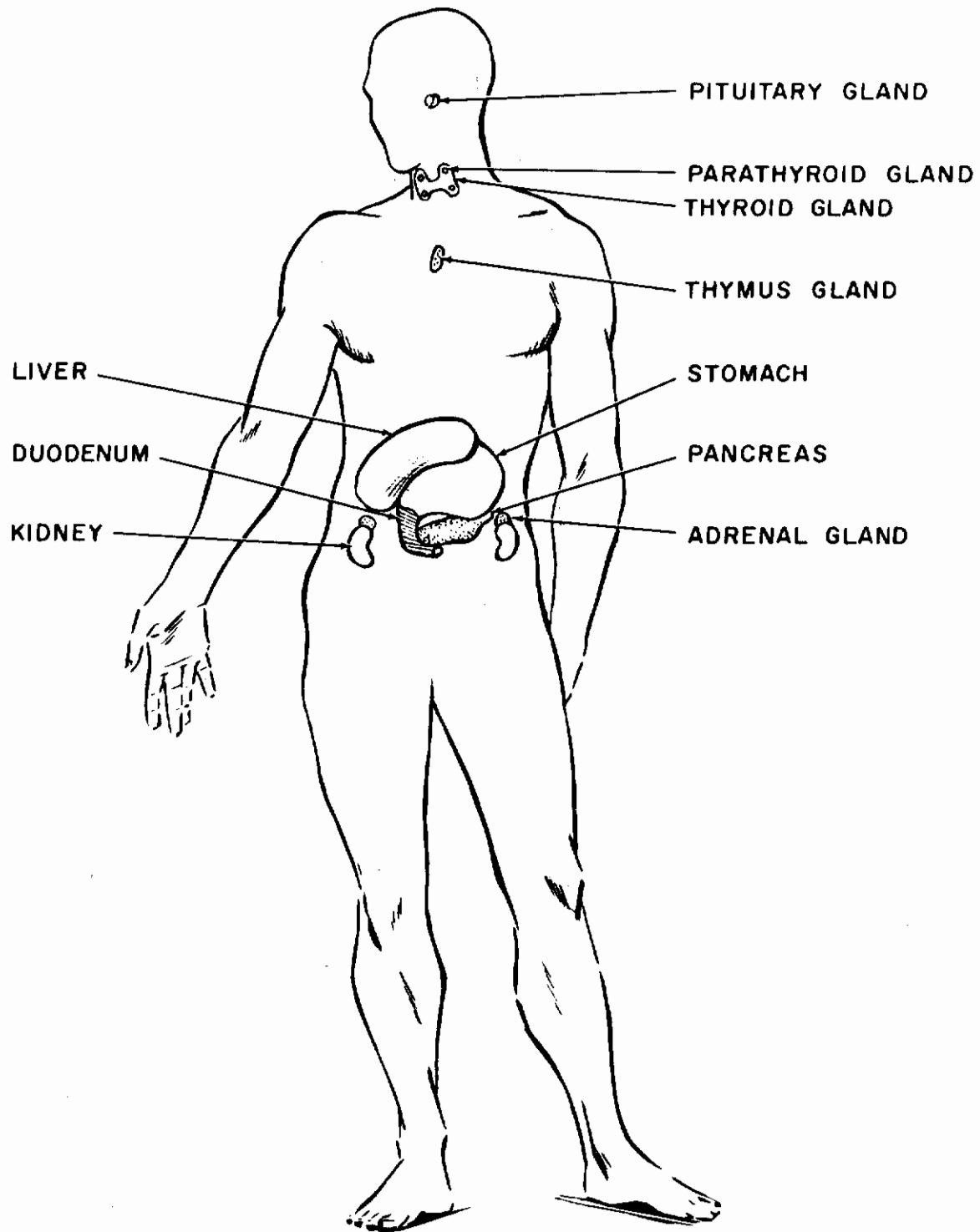

Figure 9. Location of the Endocrine Glands and Organs

## BASIC PHYSIOLOGICAL SYSTEMS

indicate that the endocrine system is functioning properly. However, direct monitoring of the endocrine system is extremely difficult, even if the monitoring took place in a laboratory.

Radioactive iodine may be injected into the circulatory system and its effect on the thyroid gland monitored to determine thyroid activity, but this test is done in a laboratory. The level of circulating thyroid hormone may be determined with serum protein-bound iodine, but this also is a highly sophisticated technique. Similarly, the adrenal gland is monitored in laboratories by both biological assay and chemical determination of an adrenal hormone in the urine, but this, again, is not the type of test that could be performed in an abnormal environment such as a spacecraft.

### III. Problem Areas

As previously stated, there is no suitable direct means of monitoring the endocrine system. Indirect methods, such as monitoring other systems in periods of stress, may indicate that the endocrine glands and organs are functioning properly, but since the nervous system shares control of many stress functions, it would be difficult to determine whether the endocrine system was functioning or whether the nervous system was responsible for the observed responses.

## TEMPERATURE-REGULATING SYSTEM

### I. Description and Function

The extent and rate of activity of "cold-blooded" animals are determined by the temperature of their environment. If the temperature is cold, their activity is sluggish; if hot, their activity is accelerated. They have no control over their body temperature. Man, however, is a "warm-blooded" animal and, therefore, has a temperature-regulating mechanism which maintains a relatively constant temperature within the body, regardless of the environmental temperature. This consistency of body temperature makes man's activity relatively independent of environmental temperature.

Body temperature is regulated by the interplay of antagonistic processes. Heat is being produced and lost by the body continually. Body temperature represents the balance struck between heat production and heat loss.

#### A. Heat Production

Heat is produced by the oxidation processes (metabolism) occurring in the tissues and cells. Any factor which affects cell metabolism thus influences heat production. Man is unable to control the metabolism of cells; his only voluntary mechanism for the control of heat production is a change in the activity of the skeletal muscles. The skeletal muscles are the greatest source of body heat and their activity can quickly be adapted to changing temperature requirements by reflex or voluntary control.



## TEMPERATURE-REGULATING SYSTEM

### B. Heat Loss

The loss of body heat is the result of a number of physical processes. Small amounts of heat are lost by warming the air we breathe and in the urine and feces excreted by the body, but the greatest amount of heat loss occurs through the skin. Heat loss from the skin occurs by the three processes of heat transfer: conduction, convection, and radiation. Considerable heat is also given up by evaporation. At high environmental temperatures, evaporation is the only effective means by which the body can give up heat, which is the reason humidity is so important to comfort in warm environments. A hot humid atmosphere (120°F) cannot be endured for more than a few minutes, while a dry atmosphere with temperatures as high as 200°F can be tolerated with no increase in body temperature.

### C. Temperature Regulation

The temperature-regulating center is in the hypothalamus. It is influenced reflexly as a result of afferent impulses from the skin (cutaneous receptors) and locally in the center itself as a result of the temperature of the blood supplying the brain.

When the body is exposed to a cold environment (i. e., the environmental temperature is lower than the temperature of the skin), the body tends to lose heat faster than it can produce heat. The cutaneous receptors send impulses to the control center (hypothalamus), which relays impulses to the body to conserve body heat. These impulses cause the smooth muscles of the arterioles to contract, reducing the flow of blood in peripheral circulation, thereby reducing conduction and radiation losses from the skin. Sweat gland activity also is reduced to eliminate heat loss through evaporation. If the environmental temperature is not too low, these actions adequately preserve the constant body temperature which is approximately 98.6°F (orally) in man. However, if the external temperature continues to drop, a point is reached where reductions in heat loss are insufficient to maintain body temperature, and heat production must be accelerated. The control center increases the tone of the skeletal muscles, and if this is insufficient, involuntary contractions (shivering and chattering of teeth) result. Experiments have shown more than 400 calories of heat may be produced each hour by shivering alone.

When the environmental temperature rises above skin temperature, an opposite series of events occurs. Stimulation of the hot cutaneous receptors causes the hypothalamus to send out impulses to inhibit the contraction of the smooth muscles of the arterioles. Thus the arterioles dilate and more blood flows through the peripheral circulatory system, permitting more heat to be dissipated by convection and radiation. If the temperature continues to rise, a point is reached where sufficient heat is not given up by this process and sweat gland activity is accelerated, permitting greater evaporation.



## BASIC PHYSIOLOGICAL SYSTEMS

The regulatory functions described above are stimulated not only by cutaneous receptors as illustrated in the discussion, but also by the temperature of the blood flowing near the hypothalamus in the brain. If the environmental temperature were kept constant, but the temperature of the blood were altered, the results would be similar to those resulting from changing environmental temperature.

### II. General Monitoring Methods

Body, blood, and skin temperatures are measured commonly in laboratories, doctors' offices, and in homes. However, for the purpose of monitoring the body temperature of a man in an abnormal environment, the devices used may be limited to two common forms. One uses the electromotive force generated at the junction of two dissimilar metals (thermocouples) to indicate temperature, and the other uses the change in electrical resistivity in a semiconductor or other material having a temperature coefficient of resistance to indicate temperature (thermistors and resistance thermometers).

The selection of a monitoring device, its method of attachment to the body, and the location to which it is attached are extremely important if reproducibility is to be expected. A rectal thermometer, which may consist of any of the devices mentioned, probably will give the most reproducible data. If the devices are attached to the skin too loosely, they will record the temperature of the surrounding air rather than that of the skin, and if attached with sufficient pressure to imbed them partially into the surface of the skin, the readings may be affected by resulting local irritation. Rectal thermometers can be inserted a specific distance in each case to insure consistency in procedure, and may be taped in place to cause a minimum of discomfort to the subject.

### III. Problem Areas

Thermocouples, thermistors, and resistance thermometers are subject to artifacts resulting from the widely different pressures of attaching these devices, as previously indicated. In addition, resistance thermometers are subject to artifacts caused by the bending or stretching of the resistance wires. However, they do offer the advantage of monitoring the temperature of a larger area of the body surface, while thermocouples and thermistors merely record the temperature of a particular point. Thermistors may be made larger to monitor areas rather than points, but there is a time delay in thermistors which is a direct function of the heat capacity of the thermistor. The signals (voltages) produced by temperature changes in thermistors are considerably larger than those of thermocouples and resistance thermometers, making thermistors more suitable for telemetering circuits.

## BIOELECTRIC MEMBRANE CHARACTERISTICS

Electric potentials can be detected almost anywhere on the surface of the human body. These potentials can be amplified and displayed on oscilloscopes or recorded on

## BIOELECTRIC MEMBRANE CHARACTERISTICS

oscillographs. For example, electroencephalograms are a record of brain wave potentials, electromyograms of muscle potentials, electrocardiograms of heart potentials, and galvanic skin response of cutaneous potentials.

### I. Cell Potentials

#### A. Basic Characteristics

In the quiescent state, a polarized cell or nerve fiber is surrounded normally with positive ions while the insides of the walls of the fiber are lined with negative ions as illustrated in figure 10A. When the cell or fiber is stimulated, ions flow through the walls (figure 10B) and the nerve or cell is depolarized, resulting in a potential difference between the neutral (depolarized) stimulated area and the unstimulated, still polarized area (figure 10C).

Many theories have been advanced to explain bioelectrical phenomena. One theory assumes that the smallest particles of organic tissues are bipolar molecules (positive on one end and negative on the other end). This theory presupposes a spatial arrangement and separation of molecules. The aligning of charged molecules accounts for the polarization of cells.

Another theory, that of selective permeability of ions (sometimes called the membrane theory), explains that nerve fiber is surrounded by semipermeable cell membrane. Because certain ions cannot pass through the membrane when the fiber is at rest, the fiber is polarized. When the nerve fiber is activated, the active region becomes more permeable and depolarization occurs as anions (positive ions) pass through the membrane and neutralize the cations (negative ions) inside the cell. This theory likens cell polarization to the charging of a capacitor.

A third theory contends that electrical phenomena within the body are produced in much the same way as potentials are produced in a battery (electrochemistry). The electromotive force in the tissue results from the numerous potential differences that exist wherever dissimilar substances contact each other.

#### B. Energy Considerations

The method by which an impulse is propagated along a nerve is still open to dispute; however, the energy for transmission of the impulse is derived undoubtedly from the nerve and not from the stimulus. A resting nerve or muscle cell is in a charged state (polarized) with positive ions on the outside separated by a membrane from cations on the inside. The potential difference between the inside and outside surfaces of unstimulated muscle cells and nerves is called the resting potential. All external points on the cell or fiber are isopotential; therefore, no current flows until the cell is stimulated (figure 10).

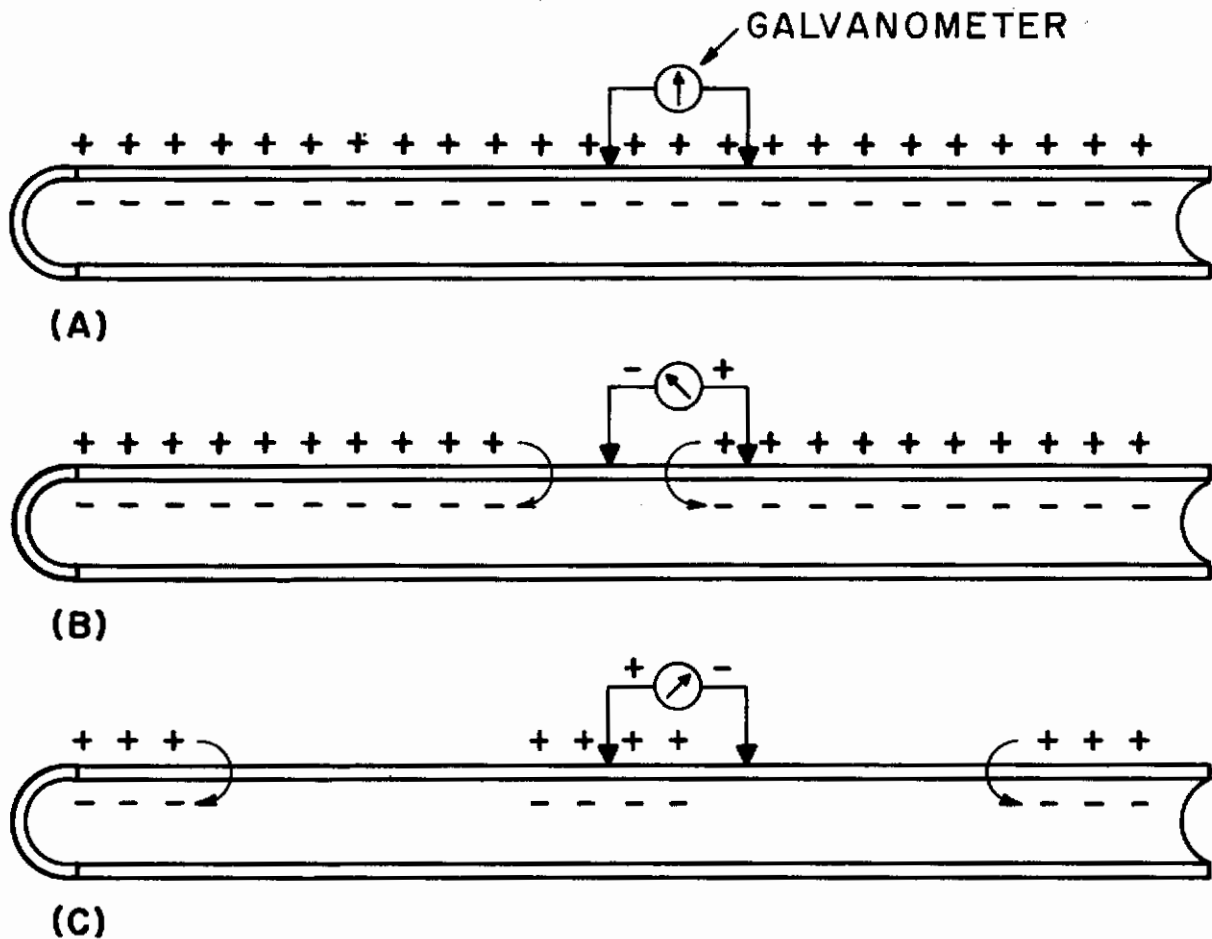

Figure 10. Fiber Polarization

If a muscle or nerve fiber is cut transversely, a potential difference, called the injury potential, can be measured between the cut end and an intact portion of the tissue. The injured surface is always negative with respect to the uninjured portion of the tissue. The difference in potential between the injured and uninjured surface results in an injury current. In terms of the membrane theory, the injury current is a "short circuit" occurring where the current may now flow through the break in the cell fiber. Since the insulation has broken down (the surface has been cut through), a potential difference exists between the injured surface (which is now depolarized) and any other surface on the fiber. The potential difference decreases with increasing distance from the injury.

When a nerve is stimulated mechanically, electrically, thermally, or chemically, the membrane's permeability changes and the nerve depolarizes at the location of stimulation (figure 10B). An action potential is created between the stimulated and

## BIOELECTRIC MEMBRANE CHARACTERISTICS

unstimulated areas of the same fiber (similar to an injury potential). The action potential acts as a stimulus to adjacent areas of the fiber and, in the form of a wave, travels along the nerve fiber as a nerve impulse.

Soon after depolarization, constructive forces within the body (homeostasis) restore the membrane to its original state of polarization and irritability. The energy for the recovery process and for maintaining polarization is furnished by metabolic processes.

The stimulation of a muscle results in an action potential similar to that of a nerve, except that muscle impulses travel at a slower rate than do nerve impulses.

### II. Excitation

#### A. Stimulus for Producing Excitation

The stimuli to which muscles and nerves respond may be caused by any change in the environment. The nature of the stimuli may be electrical, mechanical (pinching), thermal (contact with something hot), chemical (placing salt on a muscle), optical, sonic, etc. However, every stimulus does not activate tissue. For the stimulus to be effective (1) it must be of sufficient intensity, (2) it must last for a sufficient length of time, and (3) it must have a sufficient rate of change of intensity. The minimum effective values of these factors are interrelated.

If small electric currents are used to stimulate a muscle, no reaction occurs until they are of sufficient intensity. If the duration of the stimulating current is extended, the current fails to produce any additional stimulation as long as it flows continuously, because the third requirement, sufficient rate of change of intensity, is not satisfied. When the current is interrupted, another stimulation, termed the break shock, occurs because again all three requirements are satisfied. The minimal duration of current necessary for stimulation decreases with the intensity of the current.

A subminimal stimulus, by definition, does not depolarize nerve fiber membrane sufficiently to cause a reaction, but since ions do not return to the partially depolarized area immediately, a series of subminimal stimuli may cause a reaction if they occur in rapid succession.

#### B. Refractory Period

After a neuron or muscle cell has responded to stimulation, there is a brief interval during which it cannot again be activated, no matter how intense the stimulus. This interval is known as the absolute refractory period. During this time, the depolarized area becomes polarized sufficiently to respond again to stimulation. The repolarization rate is more rapid in nerve cells than in muscle cells.



## BASIC PHYSIOLOGICAL SYSTEMS

A relative refractory period follows the brief absolute refractory period. During this period, the nerve fiber or muscle may be activated, but only by a stronger than normal stimulus. A stronger stimulus, therefore, activates a fiber at shorter intervals than a weaker one, which, essentially, increases the frequency response. Increasing the stimulus intensity also may stimulate more fibers.

The intensity of the response in a nerve is independent of the intensity of the stimulus. As a result, some other characteristic must be responsible for differentiating between weak and strong stimuli. This other factor is the frequency of the response. A single impulse may cause a muscle twitch, but a stream of impulses through a nerve fiber holds a muscle in contraction.

The velocity of the impulse through the nerve fiber also is independent of the strength of the stimulus. The velocity of conduction is no faster for strong stimuli than for weak stimuli, being solely a function of the size and type of fiber.

Fibers are classified on the basis of function, and physical properties such as axon diameter and the presence or absence of myelin (a fatty sheath which acts as an insulator). Large fibers are more heavily myelinated, conduct faster, and yield larger responses. Large fibers, called A fibers, subserve the somatic (sensory and motor) system. Medium sized fibers (B fibers) subserve visceral sensation and muscle. C fibers, smallest of the three, are concerned with the perception of pain and warmth. Size classifications overlap considerably, but, generally, A fibers are approximately 1 to 20 microns in diameter, B fibers are less than 3 microns in diameter, and C fibers are less than 1 micron in diameter. All three may run together in a single bundle or nerve.

Since the velocity of conduction is dependent on the diameter of the axon of the neuron, a nerve impulse travels fastest in an A fiber, slower in a B fiber, and slowest in a C fiber; the thicker the axon the faster the conduction. The velocity of conduction in an A fiber varies from 5 to 100 meters per second while the C fibers conduct at less than 2 meters per second.

### C. All-or-Nothing Law

The all-or-nothing law states that provided a stimulus is strong enough to propagate an impulse and cause a response, the speed of conduction of the impulse and the magnitude of the response are independent of the magnitude of the stimulus. This law can be clarified with an analogy. Consider a number of thyatron electron tubes connected in cascade so that the output pulse of each thyatron triggers the next thyatron. An impulse (input pulse) must be greater than a minimal amplitude to fire the tube, but no matter how much the input pulse exceeds this minimal amplitude, the tube will not produce more plate current and the current will not travel faster.

This all-or-nothing law applies to every nerve fiber, but not to the nerve. The nerve is made up of many nerve fibers with different thresholds of excitability.



## BIOELECTRIC MEMBRANE CHARACTERISTICS

Therefore, stimulating a nerve with electric shocks of increasing intensity provokes larger and larger action potentials until all the nerve fibers are activated. At this point, the responses cannot increase.

Within neurons, the all-or-nothing law applies only to the main conducting portion of the axon. Graded response mechanisms mediate excitation at each end of the conducting fibers, providing greater flexibility to the nervous system than would be achieved by the all-or-nothing type of response.

As mentioned previously, the energy for the propagation of an impulse originates in the nerve and not in the stimulus. Within limits, when the nerve has a normal energy supply, the stimulated impulse is normal, and when the transmission is impaired locally, the response is impaired locally. For example, when a nerve is impaired by narcotics or lack of oxygen, its excitability is reduced. If only a section of the nerve is impaired, the response from this section only is subnormal, and areas of nerve fiber on either side give full response. There is no progressive decrement as an impulse passes an impaired section of nerve fiber; the size of the impulse at any location is dependent only on the state of the fiber at that location.

Referring again to the analogy of the cascaded thyatron, the amplitude of the output pulse of the last thyatron is the same as the output pulse of the first tube in the series. If one thyatron in the chain were defective so that its output pulse were reduced, the output would either be sufficient or insufficient to fire the next thyatron. If the pulse were too small, the impulse would stop; however, if the output pulse of the defective tube is sufficient to fire the next tube in the series, the output of the final tube would be identical to the output pulse of the first tube without any accumulated decrement, just as occurs in the propagation of nerve impulses in the body.

## PHYSIOLOGICAL VARIABLES IN ABNORMAL ENVIRONMENTS

In a steady-state environment, the normal individual is adjusted physiologically to his surroundings. In a new environment, physiological adjustments must occur. If the environmental change is extreme, death could result; if the change is less drastic, various physiological changes adapt the body to survive.

Of the many abnormal environmental factors which may confront man in space, the most critical have been selected for discussion: atmospheric composition and pressure, gravitational forces (acceleration and weightlessness), temperatures, radiation, and noise and vibration. Although not an environment, emotional stress has been included because it is an important condition to which the physiological systems of the body must adjust.

Although each environmental factor is discussed separately, special emphasis is given to respiration, heart activity, body temperature, blood pressure, and skin resistance, since these physiological responses must be monitored to determine the adaptation of man to the environment.

## BASIC PHYSIOLOGICAL SYSTEMS

### I. Atmospheric Composition and Pressure

The physical environment of man on earth, to a large extent, is the result of the composition and pressure of the atmosphere. Man, therefore, is greatly affected by any changes that occur in the composition and pressure of the air he breathes. In any exposure to abnormal pressures and air compositions, the most important physiological changes are likely to occur in the respiratory and circulatory systems.

#### A. Respiration

The human respiratory system is affected by the partial pressure of the oxygen which is inhaled, the barometric pressure, and the partial pressure of the carbon dioxide in the environment.

##### 1. Effects of Oxygen Partial Pressure

With increasing altitude, the barometric pressure decreases logarithmically, while the composition of the atmosphere remains relatively constant. For example, at 18,000 feet the barometric pressure is approximately half that at sea level, while the air still contains approximately 20 percent oxygen. The partial pressure of oxygen at that altitude, therefore, is only one half its value at sea level. The normal sea-level partial pressure of oxygen is 149 millimeters of mercury. As this pressure is reduced gradually, man encounters symptoms of hypoxia (inadequate supply of oxygen) such as sleepiness, headache, lassitude, altered respiratory activity, increased heart rate, impairment of thought processes, inability to perform simple tasks, and eventual loss of consciousness. To forestall the onset of hypoxia, the respiratory system automatically makes a partial but important compensation by increasing pulmonary ventilation. This increase in the depth of inspiration (hyperpnea) varies inversely with the partial pressure of oxygen. If the oxygen pressure continues to decrease, the rate and depth of breathing increase, causing a state of hyperventilation. The partial pressure of oxygen in the arterial blood, therefore, increases far above the level it would have reached if hyperventilation were not present. During prolonged exposure to slight oxygen deficiencies, the number of red cells in the blood and the blood's hemoglobin content increase. These increases result in a greater oxygen-transporting capacity which helps to reduce the effect of the drop of oxygen pressure. The affinity of hemoglobin for oxygen also is reduced by low partial pressures of oxygen, thereby favoring the unloading of oxygen to the tissues during hypoxia.

Despite the attempts of the body to acclimate to low oxygen partial pressures, there are limits to the adjusting capacity of the respiratory system. Figure 11 indicates the region of man's tolerance to variations in the partial pressure of oxygen in the air he breathes.\* The lower band represents the minimum partial pressure of

---

\*Reference 57

PHYSIOLOGICAL VARIABLES IN ABNORMAL ENVIRONMENTS

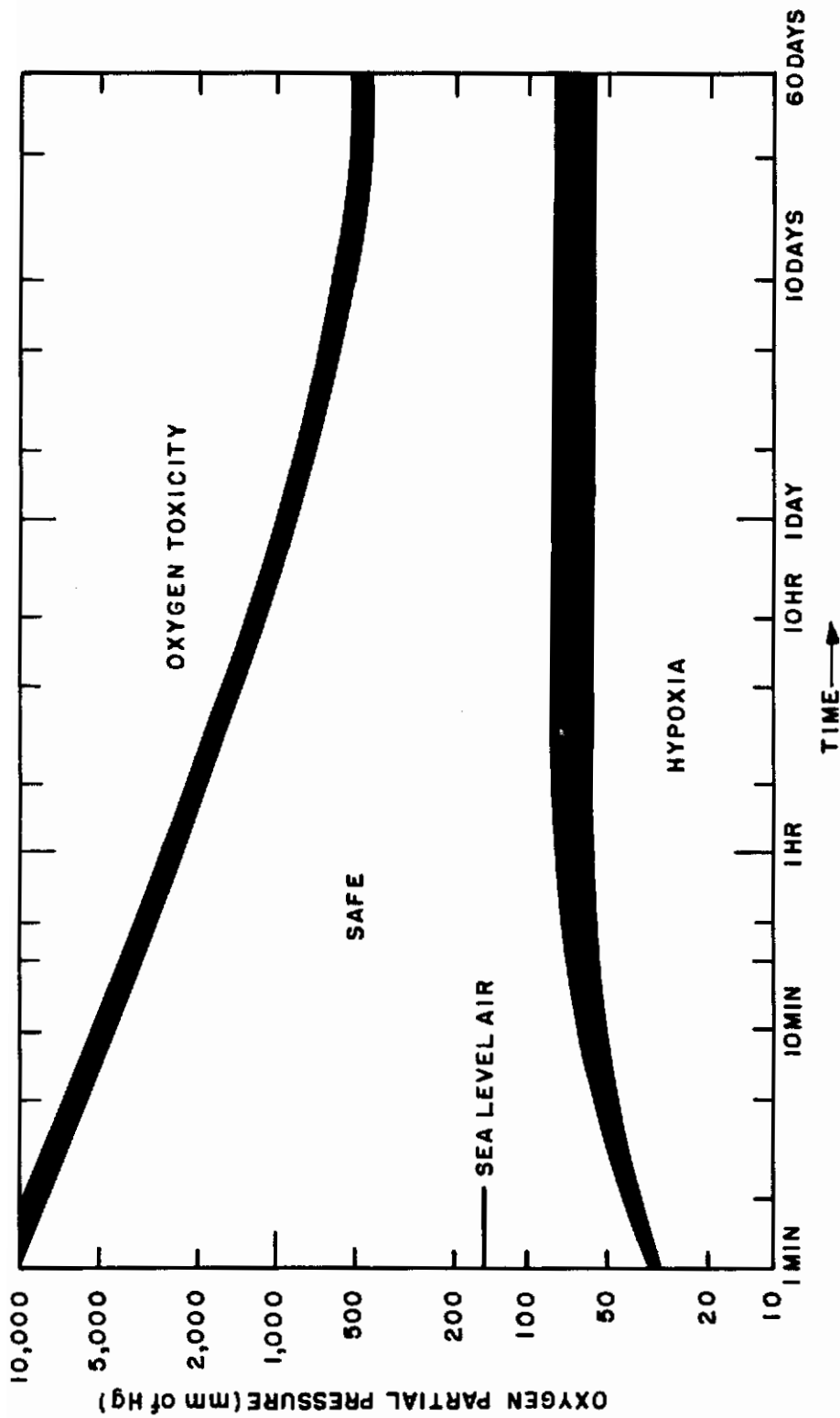

Figure 11. Human Tolerance to Oxygen Partial Pressures

## BASIC PHYSIOLOGICAL SYSTEMS

oxygen that can be tolerated in the air entering the lungs. Any physiological reaction would depend, of course, both upon the pressure of the oxygen and the rate of penetration into the intolerable region.

A continuous lack of oxygen results in hypoxia and eventually unconsciousness or death. The onset of hypoxia may be detected by electroencephalographic techniques. Tests have shown that a lack of oxygen increases the amplitude and decreases the frequency of brain waves prior to the time the subject loses consciousness. An electrical wavelength-measuring network can be used to determine when a train of four or more 5- to 7-cycle-per-second waves occur. The detection of these waves is a signal of possible oncoming hypoxia. Psychomotor changes in the early stages of hypoxia would be difficult to detect, since behavior patterns do not change uniformly; periods of lethargy alternate with periods of attention. The major deterioration often is in personality rather than in performance.

### 2. Effects of Barometric Pressure

Man can survive in an abnormal environment in which the pressure is reduced if the partial pressure of oxygen is maintained within his tolerable limits. Therefore, a man may breathe environmental air to an altitude of approximately 10,000 feet. By increasing the concentration of oxygen in the inspired air to compensate for the reduced barometric pressure (and consequently oxygen partial pressure), man may breathe comfortably up to altitudes of 33,000 feet. However, even breathing 100 percent oxygen is inadequate above 40,000 feet unless the oxygen being breathed is pressurized. Under these low barometric pressures, oxygen under pressure must be breathed and the body must be placed under pressure to counteract the internal pressure of the lungs. Above 63,000 feet, a full pressure suit or hermetically sealed chamber must be used since, at this altitude, the barometric pressure is approximately 47 millimeters of mercury. At this pressure, the body fluids boil at body temperature. This boiling is not the type associated with a pot of water on a kitchen stove, but rather a physical process involving bubble formations in the body.

### 3. Effects of Decompression

Hermetically sealed capsules or full pressure suits permit the respiratory system to function properly when ambient barometric pressures are reduced greatly, but another problem is introduced. If transition into excessively low partial pressures of oxygen occurs rapidly, the intermediate symptoms of hypoxia (sleepiness, headache, psychological impairment, etc) may be bypassed and the subject may lose consciousness rapidly and undergo spasms or convulsions. If the environmental pressure is reduced rapidly along with the oxygen pressure (as would happen if a meteorite punctured a space capsule), the subject would suffer sudden decompression. The severity of rapid decompression and its effects upon the body are dependent upon the change in pressure which occurs and the time in which this change occurs. Within the body, solids and liquids are affected only slightly, but gases attempt to expand as rapidly as the pressure



## PHYSIOLOGICAL VARIABLES IN ABNORMAL ENVIRONMENTS

falls (Boyle's law). Wherever internal gases cannot escape, the tendency to expand results in an increase in volume, depending on the elastic resistance of the surrounding organs and tissue. The expansion of gases in the intestinal tract (normally between 1 and 1-1/2 liters at sea level) may not only induce intense discomfort and pain, but also circulatory and respiratory impairment because of the displacement of the diaphragm and disturbance of blood flow in the abdomen. The fragility of pulmonary tissue could result in damage to the lungs if they are full of air at the time of decompression. The decompression rate of the lungs is limited inherently by the anatomical structure of the respiratory air passageways, which limits the rate of decompression that can be tolerated without injury.

### 4. Effects of Excessive Oxygen

Not only is it dangerous to be exposed to a lack of oxygen for any period of time, but excessive oxygen also can be harmful. Prolonged exposure to one atmosphere of pure oxygen, for example, results in inflammation of the lungs, coughing, gasping, pulmonary congestion, numbness of the fingers and toes, and nausea. Exposure to still higher partial pressures of oxygen produce nervousness, discomfort, irritations of the eyes, nausea, loss of consciousness, and convulsions. Oxygen partial pressures should be kept between 100 and 350 millimeters of mercury for comfort and efficiency. The situation becomes critical when the oxygen pressure falls below 60 millimeters of mercury. When the partial pressure of oxygen exceeds 500 millimeters of mercury for extended periods of time, the oxygen concentration is toxic. This upper limit is indicated by the upper curve in figure 11.

### 5. Effects of Carbon Dioxide

Man during a normal breathing cycle produces carbon dioxide at the same rate as he consumes oxygen. Partial pressures of carbon dioxide (in the inspired air) above 15 to 20 millimeters of mercury increase the breathing rate, distend the air sacs of the lungs, and impair the normal gas exchange between the blood and the air sacs in the lungs. These carbon dioxide partial pressures are equivalent to a concentration of 2 to 3 percent at standard atmospheric pressure. Partial pressures above 35 millimeters of mercury (equivalent to 5 percent carbon dioxide at one atmosphere) can be tolerated for only a few minutes, after which the subject experiences heavy panting, marked respiratory distress, fatigue, narcotic effects, unconsciousness, and eventual death. The partial pressure of carbon dioxide should be kept below 7 millimeters of mercury if the subject is to be exposed for long periods of time. Figure 12 illustrates the safe exposure time for various partial pressures of carbon dioxide.\*

### B. Circulation

The circulatory system also is affected by environmental pressure and the

---

\*Reference 57



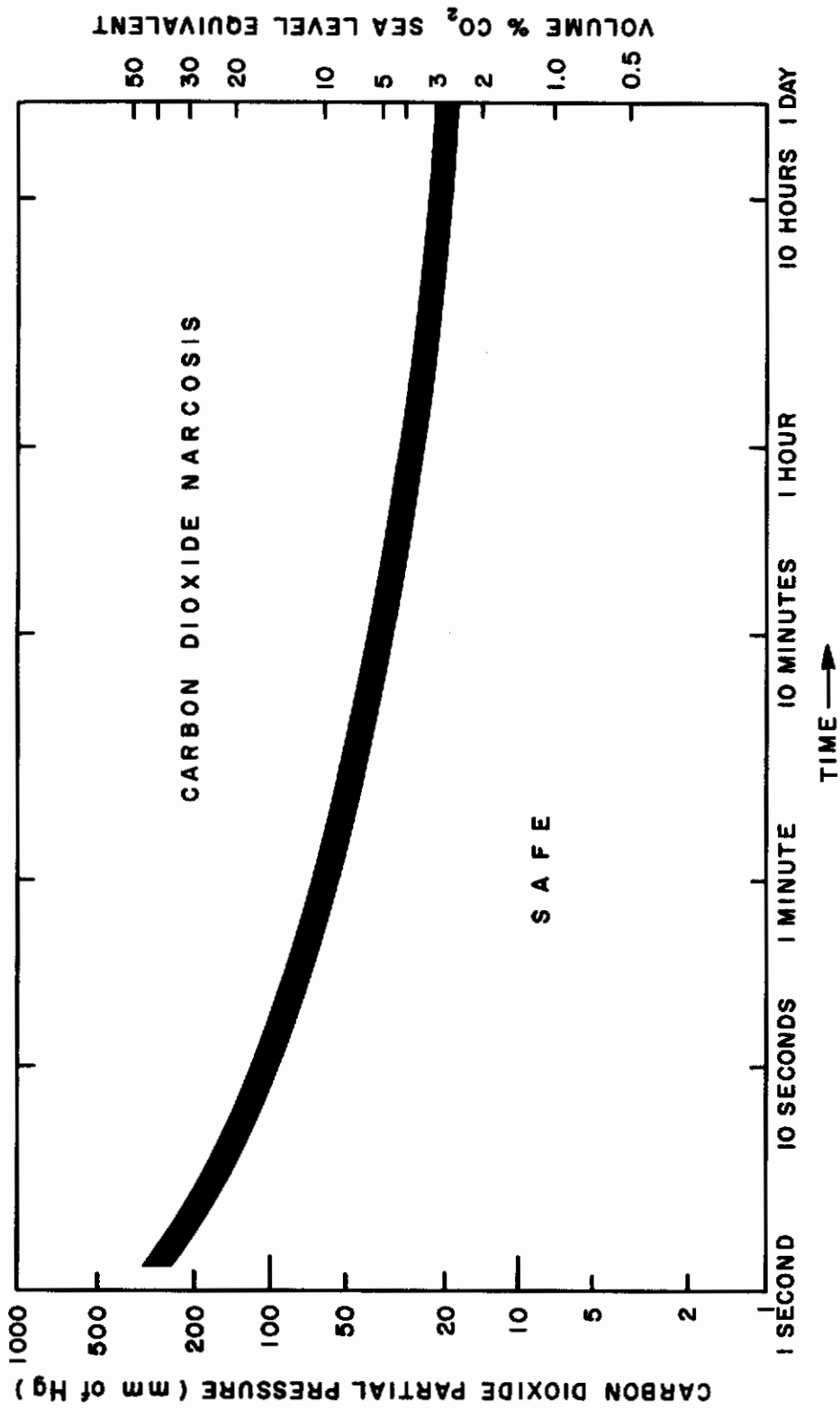

Figure 12. Human Tolerance to Carbon Dioxide Partial Pressures

## PHYSIOLOGICAL VARIABLES IN ABNORMAL ENVIRONMENTS

composition of inspired air. In fact, the change in oxygen and carbon dioxide content of the circulating blood causes the respiratory changes.

During hypoxia, the oxygen saturation of the arterial blood falls. For example, if the subject were exposed to oxygen partial pressures equivalent to breathing environmental air at 20,000 feet for 10 minutes, the oxygen saturation of arterial blood would fall to about 70 or 75 percent of normal. However, this moderate lack of oxygen would cause the heart rate to increase by 40 percent to speed the flow of oxygen to the cells. If pure oxygen were breathed at this point, the oxygen saturation of the arterial blood and the heart rate would return to normal within 1 minute.

Low oxygen partial pressures or excesses of carbon dioxide in the inspired air for prolonged periods of time result in deeper, faster breathing (hyperventilation), which attempts to increase the partial pressure of oxygen in the arterial blood. The number of red cells in the blood and the hemoglobin content of the blood increase to improve the oxygen-carrying capacity of the blood. If the oxygen saturation of the blood continues to drop or carbon dioxide content to increase, some pulmonary vasoconstriction occurs so that the flow of blood is directed in the lungs to the alveoli where the oxygen tension is greater than the oxygen tension of the lungs as a whole. The excitability of the heart muscles and the cardiac center of the medulla become depressed and the rate and force of the heart beat are decreased.

A marked oxygen lack also affects the nervous system and causes vasodilation of the peripheral circulatory system. A moderate excess of carbon dioxide in the circulating blood acts directly on the vasomotor center and causes vasoconstriction, while a great excess of carbon dioxide in the blood causes vasodilation of the peripheral circulatory system.

## II. Gravitational Forces

The gravitational pull of earth is a force that makes a free-falling body fall toward earth at a constant accelerating rate of 32.16 feet per second per second. This force is expressed as 1 G. Any body that is accelerating at a rate of 32.16 feet per second per second, regardless of the propelling force, is described as being subjected to a force of 1 G. The greater the rate of acceleration, the greater the G forces. For example, a body traveling at 64.32 feet per second per second is exposed to a force of 2 G's.

On earth, man is accustomed to mild accelerations, such as increasing speed in an automobile or riding in an elevator, and to mild sensations of weightlessness, such as those experienced when submerged in water or in simulated free fall in amusement rides. However, man in the abnormal environments of space vehicles or high-altitude aircraft is faced with short-duration exposures to high acceleration forces and long term exposures (in the order of days, weeks, and possibly months) to zero-G forces (weightlessness).

## BASIC PHYSIOLOGICAL SYSTEMS

### A. Acceleration

Accelerations of 2 G's make it difficult for man to walk and his hands and feet become heavy. The act of crawling becomes difficult, and walking and climbing become impossible under forces caused by 3 G's acceleration. At 4 G's, man is able to move only with great difficulty, and when the forces increase because of accelerations of 5 G's, only slight movements of the head and arms are possible.

Prolonged exposure to excessive acceleration forces could result in unconsciousness and eventual death. The tolerable levels of acceleration to which man may be subjected are dependent on his position relative to the direction of acceleration. (Refer to figure 13 for the terminology of acceleration.) Acceleration forces directed along the major axis of the body (i.e., from head to foot or vice versa) are called longitudinal accelerations. Longitudinal accelerations cause the blood to pool in the extremities, either head or feet. Transverse accelerations are perpendicular to the spinal column. Positive transverse acceleration (forward acceleration), or, as pilots refer to it, "eyeballs-in" acceleration, pushes the subject back into his seat. Negative transverse acceleration (backward acceleration), or "eyeballs-out" acceleration, acts to push a pilot out of his seat. Positive transverse accelerations are better tolerated than negative transverse accelerations, since it is much easier to contour a form-fitting posterior restraint away from the functional ventral side of the body.

The three body systems which limit man's tolerance to acceleration are the visual, cardiovascular, and respiratory systems. Visual disturbances are encountered primarily in negative transverse accelerations. These disturbances are not incapacitating, but they do affect visual acuity, probably as a result of the pressure of the eyelids on the cornea distorting the corneal surface. Tears, which sometimes become excessive, also are a problem. Longitudinal accelerations grossly affect the cardiovascular system by pooling blood in the extremities. Seatward accelerations where blood is pooled in the lower extremities and circulation to the head is impaired are especially objectionable. Transverse accelerations are directed perpendicular to the major arteries and veins of the body, so they do not affect the circulatory system as much as the respiratory system. The forces caused by transverse accelerations make it difficult to expand the chest to inhale. Most people cannot inhale environmental air when subjected to transverse accelerations in excess of 6 G's. Table I lists the range of short-duration accelerations at which various adverse effects are noticed.

Tolerance to acceleration varies not only from individual to individual, but it varies within the same person from day to day. Emotional states have considerable effect on an individual's G tolerance. High accelerations increase the speed of vascular responses and the level of central nervous system arousal. If the level of central nervous system arousal and the speed of vascular response already have been increased by psychological factors prior to the onset of acceleration forces, the subject's tolerance to acceleration obviously is lowered.

## PHYSIOLOGICAL VARIABLES IN ABNORMAL ENVIRONMENTS

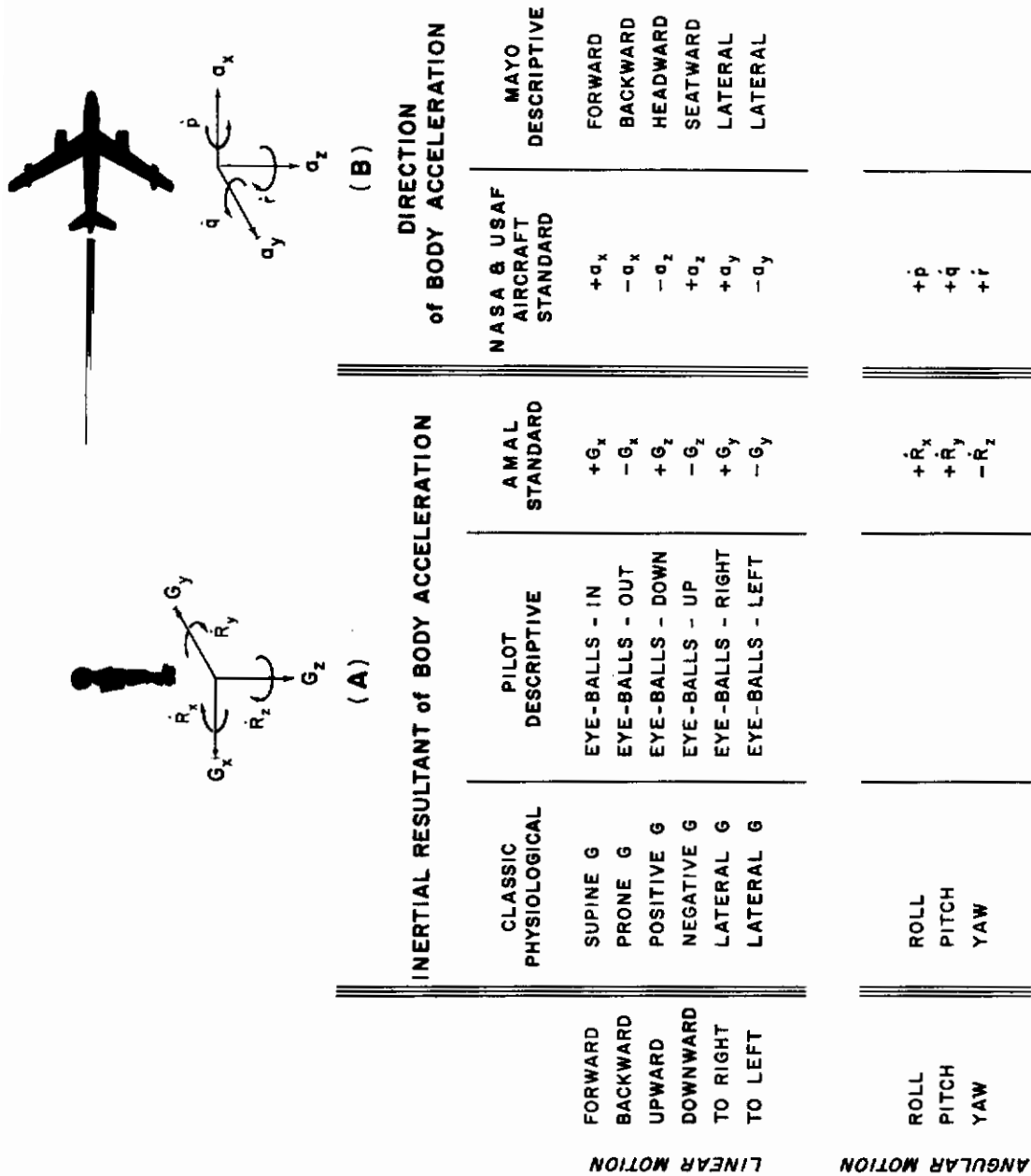

Figure 13. Standard Terminology for Acceleration

## BASIC PHYSIOLOGICAL SYSTEMS

TABLE I. GROSS EFFECTS OF SHORT-DURATION ACCELERATION FORCES\*

Effects	Longitudinal Accelerations (head to foot) (G's)	Transverse Accelerations (G's)
Impaired vision	2.5 - 7.0	0 - 17
Blackout	3.5 - 8.0	0 - 17
Structural damage may occur	> 18	> 30

The rate of onset of acceleration also affects the individual's tolerance to acceleration. Sudden accelerations may reduce arterial pressure and cerebral blood flow so suddenly that insufficient time is allowed for the jugular pressure to fall sufficiently to offset the reduced arterial pressure. When accelerational stresses are imposed slowly, the body can adjust to the new environment.

Acceleration forces also cause pain, probably resulting from the shift of certain body parts and the resultant stretch and compression of organs and tissues. The relatively heavy heart has been known to shift by as much as 2 centimeters within the air-filled chest during positive transverse accelerations of 6 G's.

### 1. Respiration

Respiration is the limiting factor in positive transverse acceleration (the acceleration vector directed from chest to back). Above 6 G's, it is difficult to inspire air, which contributes to limiting the duration of tolerance to high forward accelerations. This tolerance time is shortened further by the involuntary increase in muscular activity (and metabolism) which accompanies high acceleration forces. A forward acceleration of only 4 G's doubles the work of respiration because the respiratory muscles must operate against the compressive force of forward acceleration. This force effectively increases the weight of the thorax and lung and, in turn, reduces the volume of air within the lungs. There also is an increase in the respiratory frequency and a decrease in tidal volume.

With an increase in forward acceleration and a fixed volume of air in the lungs, intrapulmonic pressures increase, increasing the relaxation pressure of the lungs and decreasing the tidal volume. All of the lung volumes (complementary, supplementary, and tidal air) decrease proportionately as the rate of acceleration is slowly increased, with the exception of residual volume which becomes a larger percentage of the total lung capacity. It has not yet been established whether or not this increased ratio of residual air to total air capacity is a significant factor in altering the gas exchange in the lungs. The largest percentage reduction in lung volume is in the expiratory reserve volume or complementary air.

\*Reference 57



## PHYSIOLOGICAL VARIABLES IN ABNORMAL ENVIRONMENTS

Tests have shown that during forward accelerations exceeding 4 G's, the relaxation pressure even at zero lung volume is positive. This implies that complete relaxation of the inspiratory muscles at 4 G's does not occur. A condition somewhat analogous to this is negative pressure breathing. An example of negative pressure breathing is breathing through a rigid tube while submerged in water. Few men have sufficient chest and respiratory muscles to breathe ambient air from the surface of the water when submerged in deep water. Since forward acceleration exerts a condition similar to negative pressure breathing, the tolerance to forward accelerations may be increased by positive pressure breathing.

Backward accelerations are better tolerated by the respiratory system than forward accelerations because the inertial forces of acceleration assist in increasing the diameter of the chest during inspiration. Expiration is hindered by backward accelerations, but this reduced expiration is an advantage in that the chest is left expanded with a larger functional residual capacity. Maintaining the lungs in an inflated condition, typical of athletes during muscular exercise, and breathing "off the top" of the larger lung volume results in more efficient oxygenation of the blood in the lungs. However, despite this advantage, backward accelerations are more difficult to cope with because, although pressure breathing is needed, it is so much easier to contour fit a posterior restraint for forward accelerations.

Longitudinal accelerations have not been discussed, since they are limited by the circulatory system rather than by the respiratory system.

### 2. Circulation

The most favorable positions for resisting the effects of abnormal accelerations on the circulatory system are those in which the acceleration vector is directed across the major axis of the great blood vessels, i.e., transverse accelerations. However, longitudinal accelerations (accelerations parallel to the great vessels) must be withstood for short periods and, consequently, the effects of both types of acceleration on the circulatory system must be considered.

Generally, during exposure to acceleration forces, diastolic pressures change considerably more than systolic pressures. Diastolic blood pressures decrease during subgravity states and increase during periods of acceleration, probably as a result of resistance changes to the outflow of blood from the peripheral vascular beds and cardiac output changes in response to the demands made on the cardiovascular system by changes in hydrostatic pressures. Pulse pressures, conversely, increase during subgravity exposures and decrease during exposure to high acceleration forces.

During exposure to acceleration forces, the venous pressure is increased in the thorax and in the abdomen. This increased pressure is not transmitted to the peripheral veins, since the valves in the veins leading into these body cavities apparently are closed. The venous pressure increase, therefore, must result from changes

## BASIC PHYSIOLOGICAL SYSTEMS

within the extremities. When acceleration forces obstruct the return flow of blood from the extremities, the continued flow of blood from the arteries and the increase in intramuscular pressure probably combine to increase the venous pressure. The speed with which the venous pressure rises depends on the rapidity and effectiveness of peripheral vasoconstriction.

Immediately following exposure to high accelerations, blood pressure decreases because of the abrupt withdrawal of external pressures on the body. The venous blood in the systemic circulatory system is under higher than normal pressure after the acceleration ceases and the return of venous blood aids in the restoration of preacceleration blood pressure levels.

The heart rate decreases during subgravity exposures and increases during exposures to acceleration; the higher the acceleration level, the faster the heart rate.

The tolerance of circulatory systems to acceleration differs widely among individuals. There is no correlation between a man's acceleration tolerances and his blood pressure or blood sugar level, or any other measurable characteristic. Training apparently does little to increase man's tolerance to high accelerations. Tests have shown that while an inexperienced subject responds much sooner and more vigorously to initial acceleration stimuli than experienced subjects, the response differences disappear during exposure to high accelerations as both types of subjects approach maximum response.

Headward accelerations tend to pool the blood in the extremities. This loss of blood to systemic circulation is offset partially by an increase in intra-abdominal pressure, which reduces the total capacity of the blood vessels supplying the viscera. With less blood available for circulation, blood pressure in the upper extremities is reduced. If the arterial pressure falls below the value necessary to force the blood to the cerebral cortical level and keep the carotid vessels and the cerebral vascular bed open, or if the blood flow is not sufficient to oxygenate the retina and the cerebrum, blackout and unconsciousness result.

A blood pressure of 20 millimeters of mercury at eye level is necessary to prevent collapse of the retinal vessels as a result of intraocular pressure. When exposed to an accelerating force of 1 G (typical of standing still on the earth's surface), a systolic pressure below 65 millimeters of mercury measured in the arm at the level of the heart is not compatible with normal visual functions, and unconsciousness occurs at systolic pressures below 40 millimeters of mercury. (There is a high correlation between pulse rate and blood pressure at eye level, which may provide a means for predicting blackout.) Blood pressure increases during longitudinal accelerations, but it requires more pressure to supply the head with sufficient blood to maintain visual functions. For example, a mean pressure of approximately 112 millimeters of mercury at heart level is necessary to prevent blackout during exposure to 4 G's directed headward. Besides visual disturbances, cardiovascular abnormalities, such as cardiac arrhythmias (absence

## PHYSIOLOGICAL VARIABLES IN ABNORMAL ENVIRONMENTS

of rhythm) and petechial hemorrhages, occur during longitudinal accelerations. These disturbances or abnormalities do not cause any serious loss of ability to operate controls and react to stimuli, but considerable discomfort may be present.

The rapid onset of longitudinal acceleration, particularly above the 3-G level, results in temporary insufficient circulation to the head, which causes dramatic cardiovascular reactions. These reactions include changes in blood flow and decreases in right atrial pressure, intrathoracic pressure, and oxygen saturation of arterial blood proportional to the magnitude of the acceleration. These compensatory reactions are completed largely within the first 15 seconds of exposure. Vision also may be affected, but experiments have shown that clear vision is regained rapidly; usually within 15 seconds after a constant acceleration level is reached.

Cardiac output increases by as much as 20 percent during short exposures to longitudinal accelerations of less than 4 G's; however, increasing the exposure from 1 minute to 10 minutes does not increase the cardiac output above the 1 minute exposure level, although the heart rate continues to increase during the prolonged exposure to longitudinal acceleration.

Transverse accelerations are more tolerable to the circulatory system. Pooling of blood in the extremities is not as common in transverse accelerations as it is in longitudinal acceleration, but some pooling does occur. A general increase in vascular bed capacity and the slight pooling of blood are sufficient to drop the blood pressure below preacceleration levels for a short time after the termination of exposure. Cardiac output is unaffected by transverse accelerations, even during exposure to acceleration forces for as long as 10 minutes. Heart rate continues to increase throughout exposure; for example, during 5-G positive transverse acceleration, the heart rate increases by 80 percent in 10 minutes. Oxygen saturation of the arterial blood decreases, but much of this decrease can be avoided by breathing pure oxygen.

### B. Weightlessness

Weightlessness occurs during the orbiting maneuver of a space vehicle when the vehicle's acceleration produces a centrifugal force which balances the gravitational force. This abnormal environment cannot be simulated in the earth's atmosphere for more than a few minutes. Until man is exposed to weightlessness (zero G) for a substantial length of time, it is uncertain how the physiological systems of the body will adapt to this environment.

There are three physiological factors which are of concern: (1) the capability of the subject to function and fulfill a mission while weightless, (2) the temporary physiological changes occurring during and following the transition periods of entry to and departure from the zero-G state, and (3) the long-term physiological changes resulting from the departure from prolonged periods of zero G. Recent data collected from animals and man in orbiting vehicles indicate that weightlessness can be adapted



## BASIC PHYSIOLOGICAL SYSTEMS

to for relatively short periods of time without pathological aftereffects.

A major problem which confronts a weightless man appears to be disorientation. The human body is equipped with several sense organs which serve as spatial orientation mechanisms. The most commonly recognized sense organs providing the body with knowledge of its position in its environment are located in the inner ear. Other sense organs also serve exteroceptive functions (react to external forces such as gravity), although their dominant function is to provide sensory information on the tension conditions of the skin, muscles, and connective tissues (proprioceptive). These kinesthetic receptors are the nerve endings in muscles (muscle spindles), especially antigravity (postural) muscles and the nerve endings in connective tissue (Pacinian corpuscles). When the body is exposed to zero-G accelerations, the proprioceptive function of the sense organs is not disturbed, but the exteroceptive function of the mechanoreceptors is eliminated. To compensate for this loss of sensory information, the body must rely on vision to provide positional information. If sufficient visual cues are provided, disorientation apparently does not occur in the weightless state.

Many of the mechanoreceptors have strong reflex connections with the autonomic nervous system, which controls circulation, motion of the stomach, intestines, and other body functions. During abnormal motion conditions, as in an airplane or on a ship during rough weather, these reflex connections manifest themselves in the form of nausea or motion sickness. However, during zero-G accelerations, such abnormal excitation of these receptors does not occur and few subjects experience nausea. Tests with animals in rocket flights and orbiting satellites indicate that the gravireceptors, after a short conditioning period, reach a new equilibrium. These tests also indicate that although no disturbance occurs to the respiratory system, significant changes may occur to the cardiovascular system.

Short-duration tests of man in the weightless condition under water and in parabolic flights unfortunately have been too short for the body to acclimate totally to its new environment, but tests have shown that man can operate controls, drink water, and micturate with little difficulty. Regurgitation tendencies noted during human experiments indicate the need for dietary control with respect to fluid volume per feeding. The dispersion of liquids during weightless feedings may require sucking liquid from a bottle to avoid aspiration in the sinuses and respiratory tract. Just as the gastrointestinal system functions without the benefit of gravitational forces, the excretory system also functions during weightlessness. The elimination of body waste solids and liquids is a function of the elasticity and tensional tone of visceral tissues, voluntary muscular function, sphincter action and, to a slight extent, gravitational forces. However, provision must be made for the elimination of body waste products with ease and comfort to the subject.

The limited exposure to weightlessness which man has experienced and the much longer exposures of primates indicated no significant alterations in heart rate or

## PHYSIOLOGICAL VARIABLES IN ABNORMAL ENVIRONMENTS

in electrocardiographic pattern. Since exposure to weightlessness can only follow exposure to high acceleration forces, a slight lag can be expected in the return to normal heart rate from tachycardia induced by the acceleration forces because of the "contrast effect" of suddenly changing from one abnormal environment to another. Some degree of overfilling of the right side of the heart, shifts in the venous pooled blood, and minor changes in the electrical and anatomic cardiac axes also may occur, but these abnormalities are transitory, and normalcy should return during the first few minutes of weightlessness.

The dog Laika in the Russian satellite, Sputnik II, was exposed to weightlessness for several days. The only effect noticed (or at least reported by the Russians) was a slight tachycardia during the acceleration phase of the flight, with no significant physiological changes occurring during weightlessness.

### III. Temperature

Man's tolerance to temperatures should be easy to establish, since it is relatively simple to simulate abnormal temperature environments; however, temperature is a complicated variable. Man's tolerance to high temperatures also is a function of humidity, and his tolerance to low temperature is dependent on wind velocity.

Figure 14 graphically illustrates man's time tolerance to environmental temperatures.\* The transition regions allow for acclimatization, wind velocity, physical activity, and protective clothing, but, because of large individual differences (primarily due to acclimatization), some men greatly exceed these tolerances. In plotting the high-temperature curves, adequate drinking water was assumed to permit man to maintain the necessary fluid level to support the body-cooling process of perspiring. Without adequate drinking water, the limits set by the curves will not be reached.

Exposure to high temperatures may cause lassitude, loss of efficiency, weakness, headache, inability to concentrate, increased cardiac output and oxygen consumption, and apathy. If the temperatures exceed man's physiological limitations, he is subject to nausea, visual disturbances, hyperthermia, heat stroke, and convulsions. The subject also will become dehydrated if deprived of adequate drinking water during exposure to high temperatures.

Man's physiological tolerance to cold temperatures is affected by the velocity of the wind. During exposure to cold temperatures without wind, the body surrounds itself with a film of static insulating air. Wind disperses this protective layer of warm air and helps to decrease the skin temperature. Protective clothing acts to trap an insulating layer of air around the body and increase man's tolerance to cold temperatures

---

\*Reference 31



BASIC PHYSIOLOGICAL SYSTEMS

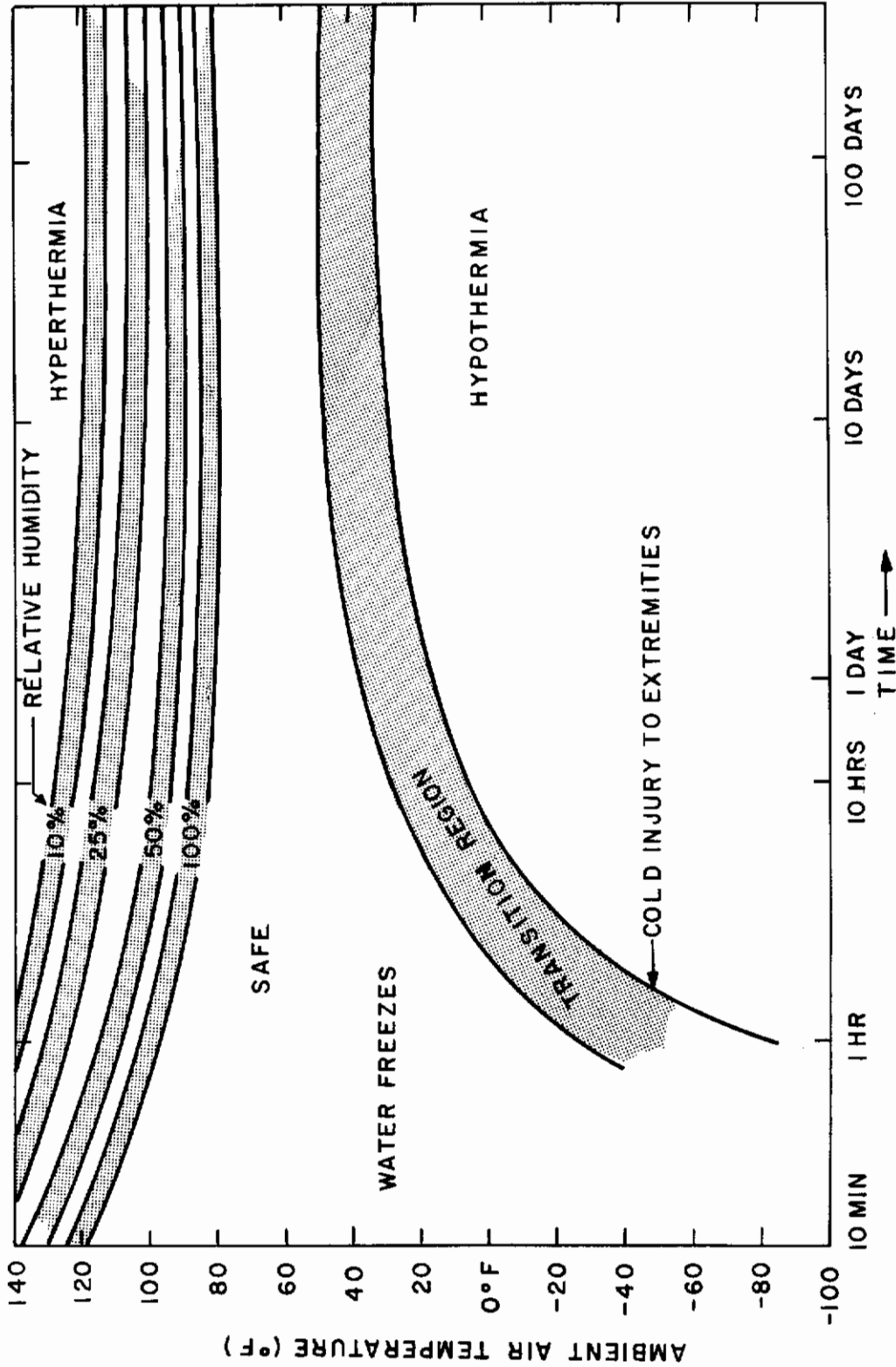

Figure 14. Human Tolerance to Temperature

## PHYSIOLOGICAL VARIABLES IN ABNORMAL ENVIRONMENTS

despite the wind. The low-temperature curve shown in figure 14 illustrates man's tolerance to cold when wearing the warmest clothing that can be worn without relinquishing the ability to move about freely (clothing about 1 inch thick).

When the body is unable to produce sufficient heat to maintain normal body temperature by metabolic processes, the heat production of the body is augmented by shivering. Tests have shown that a nearly nude sedentary man can produce up to 425 calories of heat per hour through shivering. These tests also have shown that increasing the velocity of the wind has a relatively greater effect on the body's heat production than decreasing the dry bulb temperature. Figure 15 shows the heat produced by nearly nude sedentary men while exposed to low temperatures and wind velocities from less than 1 mile per hour to 10 miles per hour. During heat productions of about 400 calories per hour, the subjects are shivering violently and uncontrollably. Any increase in activity aids in increasing the heat production of the body and, therefore, man's tolerance to cold.\*

\*Reference 36

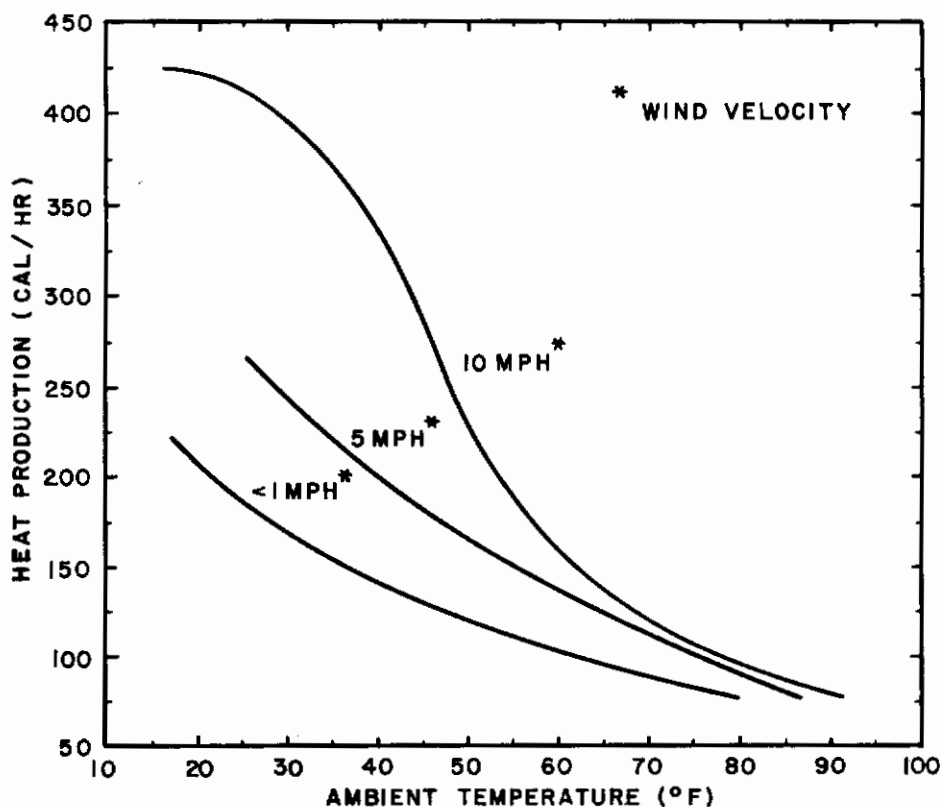

Figure 15. Heat Production of Nearly Nude Man

## BASIC PHYSIOLOGICAL SYSTEMS

When exposed to cold temperatures, man may suffer from exhaustion, local freezing, depression of respiration and circulatory functions, hypothermia, paralysis, and death.

### IV. Radiation

The injurious effects of ionizing radiation have been recognized since the discovery of X-rays. Radiation alters the structure of the atoms of the irradiated body cells and causes symptoms which are no different than those of a variety of injuries. However, unlike most injuries, there is no immediate pain associated with overexposure to ionizing radiation and weeks, months, or even years may elapse between the exposure to radiation and the manifestation of physiological changes.

#### A. Biological Effects

The biological effects of radiation may be direct or indirect; i.e., the effects may be localized within the irradiated cells or they may be transmitted to body cells remote from the point of injury. These effects may be immediate or delayed. In the production of tumors and cataracts, for example, there is a latent period during which no effects are observable.

Radiation can produce both structural and functional changes in cells and tissues and, depending on the amount of ionization, the effects may be temporary or permanent.

As the cells that make up the different tissues and organs of the body differ in nature and appearance, so also do they differ in their response to radiation. The Law of Bergonie and Tribondeau states that "the radiosensitivity of a tissue is directly proportional to its degree of differentiation." In other words, cells most active in reproducing themselves and cells not fully mature will be most harmed by radiation. The following is a partial list of cells, in the diminishing order of their radiosensitivity: white blood cells, alveoli (lung) cells, bile duct cells, cells of the tubules of the kidneys, endothelial cells, structural cells that support organs, muscle cells, bone cells, and nerve cells.

#### B. Measures of Radiation

A quantity of radiation cannot be measured directly. Instead, it is measured by the ionization produced by the passage of the radiation through a medium. The units of widest acceptance in physiological measurements are the roentgen and the rem. The roentgen is a measure of ionization in air due to X- or gamma-radiation, and the rem relates the effectiveness of the different radiations in producing biological damage to the quantity of radiation.

## PHYSIOLOGICAL VARIABLES IN ABNORMAL ENVIRONMENTS

### 1. The Roentgen

The roentgen is the standard unit for expressing quantities of X- and gamma-radiation. It is defined as the quantity of X- or gamma-radiation that will produce 1 electrostatic unit (esu) of charge, either positive or negative, in one cubic centimeter of standard air (0°C and 760 millimeters of mercury). It is also equivalent to the production of  $2.083 \times 10^9$  ion pairs per cubic centimeter of standard air.

### 2. The Rem (Roentgen Equivalent, Man)

The rem was established to compensate for the differences in ionization of the wide variety of radiations encountered in atomic energy research and space. It is the quantity of radiation (of any type) which will produce the same biological effects in man as those resulting from the absorption of 1 roentgen of X- or gamma-radiation.

The biological effectiveness of ionizing radiation cannot be measured exactly, since it varies with the part of the body irradiated, the type of radiation, and many other factors such as the age and sex of the individual. However, by use of a relative biological effectiveness factor (RBE), a close approximation is possible. Tables of RBE factors are readily available in books devoted solely to radiobiology and therefore are not presented in this handbook.\*

### C. Radiation Exposure

The tenure of radiation exposure is either chronic or acute. Chronic exposure is the absorption of relatively small amounts of radiation (up to 5 roentgens) daily over a long period of time. A single exposure to radiation of 25 roentgens or more constitutes an acute exposure. For the prevention of radiation injury, permissible levels of radiation exposure have been set for chronic exposures. These permissible levels are based upon the effectiveness of the repair processes in the body after irradiation. If permissible levels are exceeded, the damage may be irreparable. Figure 16 illustrates the basic permissible exposure rates of ionizing radiation to various parts of the body.

No permissible level for acute exposure has been established. Present knowledge indicates that 25 roentgens causes no observable reactions, 50 roentgens produces nausea and vomiting, 400 to 500 roentgens gives the individual a 50-50 chance of survival without medical care, and 650 roentgens is lethal.

The reaction to radiation injury depends upon the radiosensitivity of the organs and tissues irradiated and the function of these organs and tissues in the body.

---

\*Reference 5

## BASIC PHYSIOLOGICAL SYSTEMS

Nerve tissue (including the brain) and muscular tissue (including the heart) are generally insensitive to radiation. No significant effects have been noted in these tissues, other than small hemorrhages, even after lethal doses of radiation. Damage to a tissue or organ may result in an increase or decrease in its products (hormones, specialized cells, enzymes, etc), alteration of its growth, or death of the tissue or organ. The symptoms of radiation sickness are presented in table II. These symptoms were observed in the Japanese at the end of World War II.

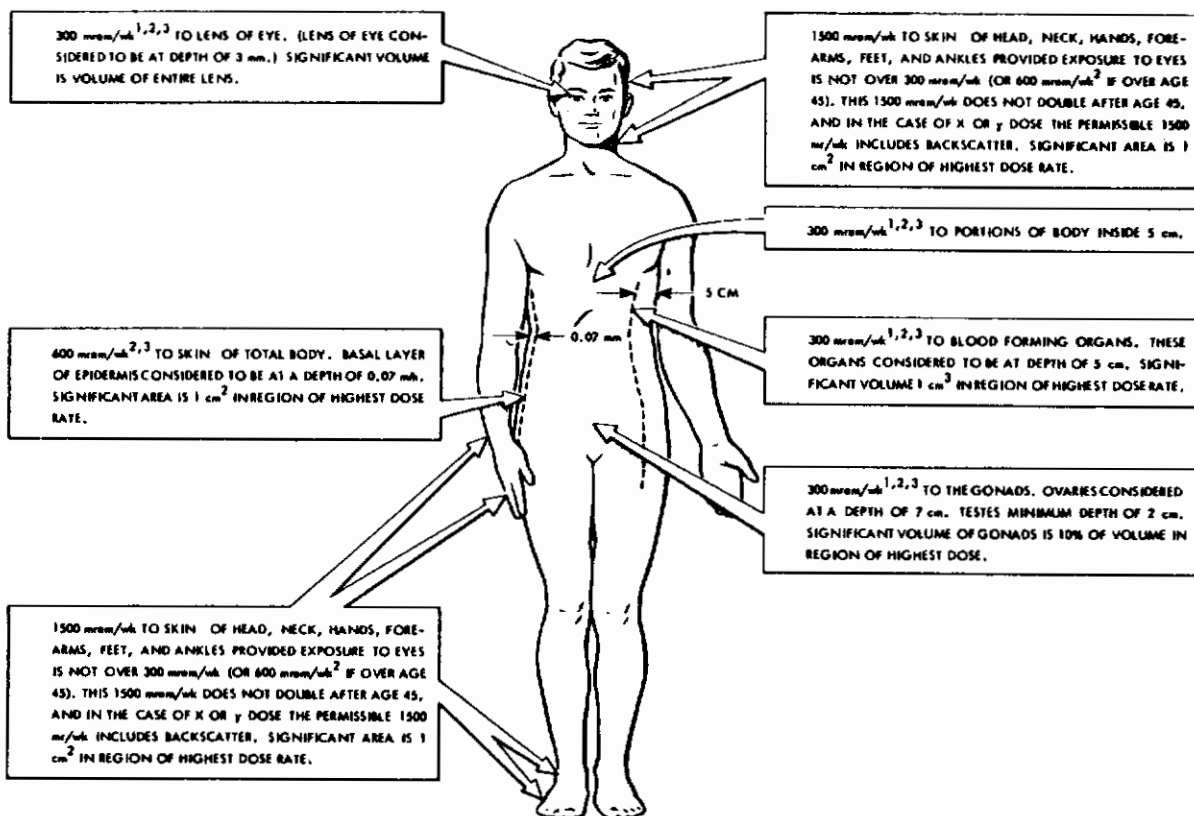

- (1) THE 300 mrem/wh OF X OR γ RADIATION MEASURED IN AIR (WHEN  $E < 3$  Mev) MAY BE INCREASED TO 450 mrem/wh TO THE LENS OF THE EYE, AND ABOUT 400 mrem/wh TO THE BONE, AND TO OTHER TISSUE MORE THAN 5 cm INSIDE THE BODY WITH EXCEPTION OF THE GONADS WHICH ARE LIMITED TO 300 mrem/wh UNTIL AFTER AGE 45.
- (2) TOTAL BODY DOSE RATE (INCLUDING DOSE RATE TO THE GONADS) MAY BE DOUBLED AFTER AGE 45 PROVIDED THE LENS OF THE EYES DO NOT RECEIVE >300 mrem/wh FROM RADIATION OF HIGH SPECIFIC IONIZATION AND >450 mrem/wh TOTAL DOSE.
- (3) ALTERNATE RULE: MAXIMUM PERMISSIBLE WEEKLY DOSE OF X OR γ ( $E < 3$  Mev) RADIATION MAY BE 300 mrem<sup>1,2</sup> MEASURED IN OCCUPIED AREA.

Figure 16. Basic Permissible Exposure Rates to External Sources of Ionizing Radiation



PHYSIOLOGICAL VARIABLES IN ABNORMAL ENVIRONMENTS

TABLE II. CLINICAL SYMPTOMS OF RADIATION SICKNESS\*

Time After Exposure	Lethal Dose (650 r)	Median Lethal Dose (400 r)	Sublethal Dose (250-100 r)
First week.	Nausea, vomiting within 2 hours.  Diarrhea. Vomiting. Inflammation of mouth and throat.	Nausea, vomiting after 2 hours.  No definite symptoms.	Possible nausea, vomiting.  No definite symptoms.
Second week.	Fever. Rapid loss in weight. Death.	Loss of hair. Loss of appetite, general discomfort.	No definite symptoms.
Third week.		Fever. Severe reddening of mouth and throat.	Loss of hair. Loss of appetite, general discomfort. Sore throat. Pallor. Bleeding. Diarrhea.
Fourth week.		Pallor. Bleeding, diarrhea. Rapid loss in weight. Death (Mortality rate up to 50 percent).	Recovery likely.

D. Physiological Effects of Radiation

The effects of radiation on the various physiological systems of the body that are most affected by radiation are described briefly in the following paragraphs. Numerous publications are available which present detailed biological effects of radiation.

1. The Skin and Hair

The skin is injured easily, but is remarkable for its capacity for local repair. Fortunately, most injured skin areas are relatively small compared to the whole

\*Reference 5

## BASIC PHYSIOLOGICAL SYSTEMS

area of the skin, leaving plenty of normal tissue to promote healing. Skin reaction, observed microscopically, is one of the first clinical indications of irradiation. Cellular changes are recognizable within an hour after even small local exposures. An exposure of about 140 rem produces an erythema (reddening) of the skin. This reaction indicates partially damaged skin with normal cells among the damaged. The normal cells immediately begin repair, and recovery is fairly rapid. Large dose (chronic or acute) irradiation of the skin may result in the formation of cancerous cells.

Radiation burns develop from exposure to large amounts of radiation in any form, although the most likely causes are alpha and beta radiation. They may be preceded by symptoms of itching or tingling. There is no biological warning of radiation burns; a person may be exposed for hours unknowingly and may suffer permanent skin damage. Severe radiation burns may not heal for months. Radiation burns rarely develop from doses of 300 rem or less. The threshold single dose for erythema is about 140 rem. Erythema is a danger signal. If it appears, the subject should not be exposed to further radiation.

Irradiation of the cells lining the hair follicles can stop the growth of hair or cause temporary baldness (epilation). After a large dose (300 to 500 rem) of beta and alpha radiation, the hair begins to fall out in bunches.

### 2. The Circulatory System

The differences in the lifespan and radiosensitivity of the blood cells are important factors in radiation injury. When the body is irradiated, the first cells to be reduced in number are the white cells. (A deficiency of white cells is called leukopenia.) Within a week after severe irradiation, the platelets (blood cells important in bloodclotting) are reduced in supply, both because of damage to the cells which produce them and because of injury to the platelets themselves. About 7 weeks after irradiation, red cells of the blood are reduced. (A deficiency of red cells (erythrocytes) is known as anemia.) Injury from acute exposure probably will heal without further exposure; injury from chronic exposure is likely to be permanent.

The effects of reduced supplies of blood cells are manifold. Leukopenia reduces resistance to infection, and the body is susceptible to ordinarily harmless numbers of bacteria. The loss of platelets results in the blood not clotting and open wounds not healing. The effects of anemia are pallor, shortness of breath, fluttering of the heart, and general weakness.

The lymphatic system is affected by radiation. Lymph nodes, which normally filter out and destroy bacteria, show the first stages of hemorrhaging and infection after acute irradiation. Blood passing into the lymphatic system from damaged blood vessels is collected at the nodes and the reduced number of white cells in the nodes permits bacteria to multiply and produce infection. The spleen which stores lymphocytes (lymph cells) is affected in a similar manner.

## PHYSIOLOGICAL VARIABLES IN ABNORMAL ENVIRONMENTS

Bone cells are relatively insensitive to external radiation; however, strontium 89 and 90 as well as plutonium 239 (popularly called "bone-seekers") and other radioisotopes circulated by the blood can damage the bone cells as well as the marrow cells.

### 3. The Respiratory System

Radiation affects the lungs by damaging the alveoli (air sacs). The damage can result from penetrating external radiation, but the greatest hazard is radiation from inhaled dusts and vapors. Although only a small proportion of the material taken into the lungs in one breath remains there when the breath is exhaled, an accumulation of these small amounts may cause severe injury.

Undissolved radioactive particles in the lung can result in the formation of tumors. Soluble materials may pass through the alveoli membranes into the blood to cause damage elsewhere in the body. If radiation creates toxic byproducts in remote parts of the body, these substances may be carried to the lungs by the circulatory system.

### 4. The Endocrine System

Radiation affects the adrenal glands and the reproductive organs and, to a lesser extent, the thyroid gland, liver, and gall bladder. When the cells of the adrenal glands are damaged by radiation, the body functions less efficiently while the tissues are repaired and replaced. The individual may be more susceptible to heat, cold, injury, and infection; his blood pressure may drop; and the balance of salts in his blood plasma may be upset.

Exposure of the reproductive organs to large doses of radiation (about 400 rem) may cause sterility. Exposures of about 100 rem severely damage the cells of the sex organs, and thereby slow the production of sperm. The sperm, however, is radiation-resistant, and irradiation of the sex organs does not destroy the sperm. The slowing down of sperm production, because of injury both to irradiated cells and to the repair functions of nonirradiated cells, results in only partial sterility.

The thyroid is not considered sensitive to external radiation; however, it will concentrate internally absorbed radioactive iodine. Radiation damage to the thyroid decreases thyroxine production, which reduces the basal metabolism rate and the ability of muscle tissue to absorb needed oxygen, severely impairing the health of the individual.

Radiation damage to the liver and the gall bladder impairs digestion. Small doses of external radiation apparently do not injure the gall bladder, but they may alter the production of fatty acids in the liver, thereby changing one phase of the

## BASIC PHYSIOLOGICAL SYSTEMS

body's metabolism. Large doses of external radiation produce small areas of dead tissue and hemorrhaging in the liver, gall bladder, and interface between the two organs. The cells of the gall bladder also may show tissue death and peeling, but this has not been established to be a direct effect of radiation. Internal radiation is a great hazard because the liver concentrates many radioisotopes. Damage is similar to that caused by comparable amounts of external radiation.

### 5. The Excretory System

Both external and internal radiation may damage the urinary tract. External radiation breaks down the tissues and reduces kidney functions. Internal emitters can concentrate in the kidneys; for example, the rate of excretion of uranium from the kidneys is slow, so that the chances of extensive damage are great.

Blood in the urine following irradiation indicates that the kidneys have been injured. The cells lining the kidneys that filter wastes out of the blood are damaged and there is no barrier to prevent the blood from passing directly into the kidneys. Lesser injury to the kidneys is indicated by an increase of amino acids in the urine.

The first effect of irradiation of the alimentary canal is impaired secretion and discontinued cell production. The symptoms are nausea and vomiting. When cell breakdown follows, large numbers of cells are released from the walls of the canal, and the folds of the intestines become cluttered with debris. Continued vomiting produces thirst; irritation of exposed cells by digestive juices produces convulsions of the intestines and diarrhea.

If cell destruction is widespread and includes the shedding of large masses of cells, the extensive exposure of tissues under the surface layer produces ulcers. Ulcer formation, seldom limited to one area, further irritates the intestines to cause cell damage elsewhere. Diarrhea, the evidence of intestinal injury, is accompanied in severe cases by loss of blood through the bowels.

### 6. The Eyes

Unlike other cells of the body, the transparent lens cells of the eye cannot be replaced by regrowth. When the cells making up the lens become damaged or die, a cataract forms. The cells lose their transparency slowly and, as a result, the individual loses his sight. Apparently, only one or two damaged lens cells are necessary to initiate cataract formation. These act either by releasing toxic substances or by preventing the transfer of food to the other lens cells. The opacity resulting from exposure of the eyes to radiation may not occur until 3 to 5 years after exposure.

Radiation is more likely to cause cataracts in younger persons, because of the continuing growth of the lens at that age (growing cells are more radiation-sensitive).



## PHYSIOLOGICAL VARIABLES IN ABNORMAL ENVIRONMENTS

### V. Noise and Vibration

Noise and vibration problems in aircraft are not new. Mainly, however, the concern has been the breakdown of equipment when exposed to these environments; now, with spacecraft, the effects of noise and vibration on the physiological systems of the body must be considered. Not only can physical damage result directly from exposure to loud noises or severe vibrations, but this exposure can deteriorate human behavior and performance to the extent that man's overall tolerance to physical and psychological stresses are reduced significantly. For example, the heart rate and respiration rate of the Russian dog in Sputnik II took three times as long to return to normal following the actual launching than was required in the simulated ascent in the laboratory. One of the suspected causes was noise and vibration; these environments were not simulated in ground experiments, since they were not anticipated to be severe enough to cause a physiological response.

High noise levels (i. e., 120 to 130 decibels or more) can damage the hearing mechanism of the body and increase psychological stress because of difficulties in communication. In addition, noise levels above 120 decibels in the frequency range of 200 to 500 cycles per second can cause dizziness and vestibular disturbances. A well designed, properly fitted helmet attenuates frequencies above 500 cycles per second by 20 to 30 decibels, which ensures that communications can be maintained. Below 300 cycles per second, the helmet provides little attenuation and, if an ear oximeter is used to measure the oxygen saturation of the blood, one ear is exposed, so another means of protection is necessary. Whether or not the ear can tolerate noise levels continuously for long periods of time (days or weeks) without periodic quiet rest periods is yet to be determined.

Vibrations may interfere directly with physical activity and performance, may cause various psychological and physiological responses, or may cause physiological damage. Some body displacements caused by vibration, if of sufficient magnitude, can be disturbing to the sensory and neuromuscular activities, such as reading instruments or adjusting controls. Speech communication may be rendered difficult or visual acuity may be disturbed.

Vibrations may stimulate receptor organs or may excite parts of the nervous system, resulting in reflex activity. The stimuli also initiate nervous processes relating to food assimilation and muscular activity. Exposure to vibration (mechanical forces) of sufficient strength and duration can cause fatigue and reduce work capacity and alertness. Excitation of brain centers may produce emotional reactions, such as fear or unpleasantness, and result in automatic or deliberate compensatory (protective) behavior. Changes in respiration, heart activity, and peripheral circulation are common during exposure to moderate vibrations. Certain postural reflexes appear to be inhibited by vibratory motion.

Man's tolerance of vibrations is by necessity determined subjectively. A series of



## BASIC PHYSIOLOGICAL SYSTEMS

curves representing the average vibration tolerance for standing, sitting, and lying positions, as determined by a number of investigators, is presented in figure 17.\* These curves are based on exposure of 5 to 20 minutes and represent the three thresholds which can be determined most accurately: perception, unpleasantness, and tolerance. The threshold of tolerance depicts the limit of vibrations which the subjects would tolerate. Long exposure to vibrations above the threshold of perception causes irritation and fatigue. Larger accelerations than those indicated by the maximum-tolerance-to-vibration curve may be tolerated for only a short time without harmful effects. The upper curve of figure 17 illustrates the higher accelerations which may be tolerated for less than 1 minute (less than one-half minute for frequencies between 5 and 15 cycles per second). This curve must be considered the borderline beyond which physical tissue damage occurs in a relatively short time. The shaded areas on the curves in figure 17 represent one standard deviation above and below the mean.

\*Reference 30

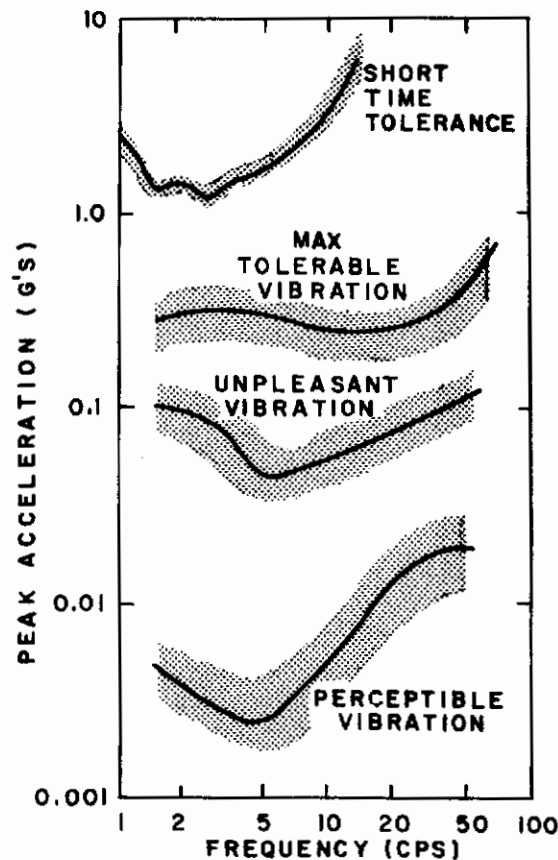

Figure 17. Human Tolerance to Vibration

## PHYSIOLOGICAL VARIABLES IN ABNORMAL ENVIRONMENTS

Severe vibrations may damage the body. The heart and lungs may be injured from their beating against each other and against the rib cage, or the brain may be injured by superficial hemorrhage due to the motion of the brain within the skull. Soft tissues in the intestines and rectum may be torn or crushed, and tendons and joints may be strained. If the vibration accelerations exceed 3 G's, severe chest pain results and possible vestibular damage in the ear may occur. A rise in body temperature, probably resulting from mechanical friction inside the body, and dyspnea (difficult or labored breathing) accompany most exposures to vibration.

Repeated abuse to the tissues of the body, even by relatively minor vibrations, gradually affects the capillaries and their nerve supply. For example, after several months of using a pneumatic hammer or hand-held grinder, the operator experiences pain and numbing of the fingers on exposure to cold. Similar symptoms may occur if a subject is exposed to a vibrating environment for a considerable length of time.

In designing a space vehicle or other enclosure, certain resonant frequencies should be avoided because of physiological and motor performance disturbances. There are considerable individual differences depending in part on body build, but, in most cases, resonant frequencies between 15 and 20 cycles per second should be avoided to prevent damage to the spine. The head is bothered most by resonant frequencies between 5 and 15 cycles per second and the brain and the eyeballs are believed to be affected most by frequencies of approximately 50 cycles per second.

### VI. Emotional Stress

All loads or influences that displace man's structure, function, and behavior from their accustomed norms may be considered stresses. Exposure to the abnormal environments of space vehicles will doubtless bring into being a host of new influences, forces, and conditions which are potentially stressful. The three primary influences which will affect man psychologically are his artificial environment, disruption of his day-night cycle, and fatigue.

#### A. Artificial Environment

When man is encapsulated in a space vehicle, he will be subjected to three interrelated, yet unique, problems: sensory deprivation, detachment or isolation, and confinement.

Sensory deprivation may occur in several functionally different situations. The subject may be placed in a contrived sensory environment where the composite patterns of stimuli to which he is accustomed are reduced drastically. The effects of such an environment on the subject are equally drastic. These effects include deteriorative changes in cognitive and emotional processes, as evidenced by increased irritability. Extreme intellectual aberrations in the form of hallucinatory experiences are possible.

## BASIC PHYSIOLOGICAL SYSTEMS

Sensory deprivation also occurs in completely normal sensory environments, if the subject is committed for a prolonged period of time to a rigid and extremely confining pattern of stimuli: typically, a complex work situation. To maintain proficiency on such tasks, complete attention must be confined to a small perceptual field (the field of work). This confines the subject to a small, rigid pattern of highly repetitious stimuli which, in effect, deprives the subject of the ambient sensory events which otherwise would maintain sensory input at normal levels. Within the confines of a space vehicle, man will be subjected to both of the situations which lead to sensory deprivation: extreme reduction of sensory levels normally experienced, and commitment to the confining stimuli structure of work. After prolonged exposure to sensory deprivation, physiological abnormalities are observable for a considerable length of time. Behavior and cognitive functions may be disrupted for several days following exposure to such an environment.

Detachment is that unusual state of isolation in which man is separated from his accustomed behavioral environment by inordinate physical or physiological distances. An extreme state of detachment cannot be produced experimentally, but considerable information (subjective) is available in reports of Admiral Byrd, who remained alone in an antarctic advance base for six months, and Dr. Bombard, who sailed alone for 65 days across the Atlantic Ocean. Their reports indicate that the initial shock of being separated from society causes the newly isolated individual to feel apathy, anxiety, and fear. Since isolation is associated frequently with sensory deprivation, the persons isolated suffer reductions in overall mental efficiency, hallucinatory experiences, and a feeling of depersonalization and aloneness. Physical separation of men from fellow human beings can be made more tolerable by maintaining communication during exposure to the abnormal environment. It must be remembered, however, that separation from Earth itself may have unique implications, and its effects must be predicted with caution.

Confinement may result from encapsulation or from such minor things as wearing a space suit or observing military or social restrictions. Essentially, confinement means restriction of movement. Unlike sensory deprivation and isolation, confinement is possibly a greater problem when two or more persons are confined to an environment. Tests indicate that confinement typically engenders substantial levels of irritability which, for some subjects, develop into frank hostility. This may not alter the reliability of performance for a single human operator, but, when other operators are placed in the same environment, their reliability is affected adversely in direct proportion to the existing degree of their functional interdependence.

### B. Day-Night Cycle

Space travel will divorce man from the normal light-dark, day-night cycle associated with terrestrial existence. Diurnal curves of body temperature show that a basic biological cycle is tied to the night-sleep and daytime-work schedule, but, within broad limits, variations may be introduced without harmful effects. Man does, however,

## PHYSIOLOGICAL VARIABLES IN ABNORMAL ENVIRONMENTS

require several days for complete psychophysiological adaptation to a new schedule.

The most important feature of a satisfactory long-term regimen is that 7 to 8 hours of unbroken rest be incorporated in the schedule. The long-established maritime duty shifts of 4 hours on duty and 8 hours off is a workable split-shift arrangement for the continuous manning of duty stations with a minimum crew, but emergency shifts (4 hours on and 4 hours off) have been shown to be feasible for 3 to 5 days. A test of confinement for 7 days in a capsule using a 4-hours-on, 4-hours-off schedule showed a general lessening of proficiency throughout the 24-hour day after the first three days. The subject could not adjust to the extreme revision of his normal day-night cycle, and he gradually became more and more fatigued, which lowered his proficiency to the point of being inadequate during the greater portion of the 7-day test.

### C. Fatigue

Fatigue resulting from sleep deprivation or prolonged commitment to a skilled task is the greatest problem associated with emotional stress. The other factors concerned with emotional stress (artificial environment and day-night cycling) contribute to fatigue and tend to emphasize its effects.

The adverse effects of sleep deprivation are impaired judgment, slower decision time, decline in vigilance, increased variability of reliability, and degradation of attitudes and feelings. Although electroencephalographic records can show the results of sleep deprivation through the loss of the alpha rhythm, monitoring the psychophysiological performance of an individual is best performed by galvanic skin response. It should be remembered, however, that galvanic skin response measures only the state of arousal of the individual and not fatigue or stress directly. During isolation studies, the experimenter is able to see the pattern of response of a subject at a glance and determine if he is comfortable or not (the resistance level is higher in a comfortable subject; the uncomfortable subject not only has a lower skin resistance, but a sawtooth pattern is recorded) and his state of arousal due to the stresses involved.

Tasks which require perception of minute cues, such as monitoring slow-continuous indicator movements, should not be undertaken for more than 1 hour at a time since these tasks have the greatest susceptibility to fatigue. The proficient execution of tasks of this type (observing minute cues) are dependent on the subject's state of vigilance or alertness. More proficient performance can be obtained by providing the subject with discrete gross cues or events, such as the flashing on of a light.

Decrements in performance are difficult to define in basic physiological terms and the psychological criteria are subtle and variable, but methods of allaying fatigue are known. High motivation and confidence in the task to be accomplished as well as limiting the forces and skill required by the task are prime methods of reducing fatigue. Physiological stresses such as exposure to heat, cold, hypoxia, and acceleration forces produce impairments which accelerate fatigue and therefore should be minimized.

BASIC PHYSIOLOGICAL SYSTEMS

Tests indicate that a certain amount of routine is desirable when under stress, but too much routine can become monotonous, and monotony promotes fatigue.



## *Section III*

# **BASIC PHYSIOLOGICAL MEASURING SYSTEMS**

### INTRODUCTION

This section presents the principles of operation and the characteristics of instrumentation used in "dynamic" measurements of physiological systems. General system parameters and functions are emphasized rather than the details of specific hardware and electrical circuits.

### GENERAL SYSTEM CONSIDERATIONS

Measuring systems used in physiological applications are almost entirely electrical in nature. A block diagram of a basic physiological measuring system is shown in figure 18. The signal pickup or detection device normally consists of either a transducer, which converts the phenomena being measured into some form of electrical energy, or an array of electrodes, which detects various biopotentials. Signal modifiers amplify or otherwise modify the signal to any desired form before it is transferred to the display unit.

The display unit or output indicator, which may provide a one-time visual observation or a permanent record, must consist of a scale and a pointer. The scale may be divided on the face of a meter or on the edge of a ruler, or it may be a set of grid lines on a length of recorder chart paper. The pointer may be a meter needle, the edge of a geometric plane or solid, or a line inscribed on a chart. Even the cathode-ray oscilloscope has a scale and a pointer, since the light spot moves with reference to

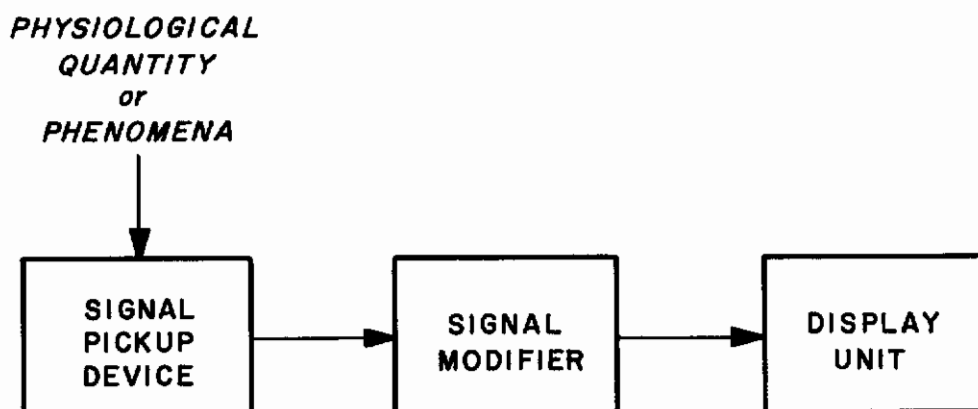

Figure 18. Basic Elements of a Physiological Measuring System

## BASIC PHYSIOLOGICAL MEASURING SYSTEMS

a fixed set of grid lines. Data can be reduced and analyzed manually or automatically with computers and other electronic devices.

### I. General System Requirements

An effective physiological measuring system must meet two general requirements: (1) it must have minimal effect or reaction on the phenomenon being measured, and (2) it must respond to only one phenomenon at a time. In addition to these two general requirements, a physiological measuring system must have certain dynamic capabilities that correspond to the range of the phenomena being monitored, and the individual components of a measuring system must be compatible with each other as well as with the physiological system being monitored.

#### A. Frequency Spectra

The frequency range that must be covered is perhaps the most important factor to consider when selecting a system, a system component, or an instrument. Proper frequency response is especially important in physiological monitoring applications. Even a slight amount of frequency or phase distortion, which would be undetectable in many other applications, can cause serious inaccuracies in physiological measurements. If the frequency-response capabilities of a measuring system are inadequate, some components of the desired signal may be attenuated or incorrectly presented. Conversely, if the measuring system accepts all frequencies indiscriminately, unwanted signals containing frequencies outside the range of the desired physiological signal may create severe interference.

An all-purpose physiological measuring system should be capable of handling frequencies ranging from 0 to greater than 5000 cps and have some means of attenuating unwanted or interfering frequencies within this range. Table III presents the frequency response requirements for various physiological measurement systems.

#### B. Dynamic Range

All components of a physiological measuring system must be compatible with the physiological phenomena being monitored and with each other. For instance, if the normal range of a pressure variation is 0 to 75 pounds per square inch (psi), a transducer with an operating range of 0 to 50 psi obviously could not be used. On the other hand, a transducer with an operating range of 0 to 5000 psi would not be a proper selection, since all measurements would be at the extreme low end of the transducer's range, reducing the accuracy of the readings.

### II. Error Considerations

If physiological measurements are to be interpreted correctly, the degree of accuracy of the measurement must be known. The major factors affecting the accuracy of a measuring system are: (1) frequency response and phase characteristics, (2) impedance

GENERAL SYSTEM CONSIDERATIONS

TABLE III. FREQUENCY SPECTRUM REQUIREMENTS FOR INDIVIDUAL MONITORING SYSTEMS

Signal	Source	Spectrum (cps)
Electrocardiographic	Human Human - diagnostic Dogs and medium-sized animals	0.1 to 20 0.1 to 100 0.1 to 200
Electroencephalographic	Human and animal	1 to 80
Skin Response	Basal Specifics	0 to 1 0.01 to 1
Myographic	Restricted Special and single fibre	10 to 5000 0 to 5000
Respiration	Human, qualitative Human, true shape Animal	0.1 to 2 0 to 10 0.01 to 20
Arterial Pulse	Human blood pressure Animal blood pressure	0 to 30 0 to 200
Venous Return	Human and animal blood pressure	0 to 5
Plethysmographic Pulse		0 to 30
Heart Sounds	Human	16 to 2000
Voice	Full range Intelligibility only	60 to 5000 400 to 2000

Notes: 1. The spectrum limits are between the half-power points (3 db down).  
2. The true waveform for each signal is dependent on the phase characteristics of the signal.

## BASIC PHYSIOLOGICAL MEASURING SYSTEMS

matching, (3) nonlinearity, and (4) interference and artifacts. The degree of importance of each of these considerations is determined by the degree of error that can be tolerated in the measurement.

### A. Frequency Characteristics

Pure waveforms of a single sinusoidal frequency are encountered rarely in physiological measurements. Instead, physiological signals normally contain a mixture of sinusoidal waves of different frequencies, varying in both phase and amplitude. Therefore, if a measuring system is to process the signals without distortion, it must be capable of handling all of the frequency, phase, and amplitude components of the signals. Sharp changes in slope, such as those encountered in square waves and step functions, contain high-frequency components in addition to the basic repetition frequency. Measuring systems, therefore, must be designed to process such signals. If the measuring system is incapable of handling the higher frequency components of a square wave, for example, distortion occurs, resulting in rounded corners as shown in figure 19A. If the system has adequate high-frequency response but lacks low-frequency response, the wave may be distorted as noted in figure 19B.

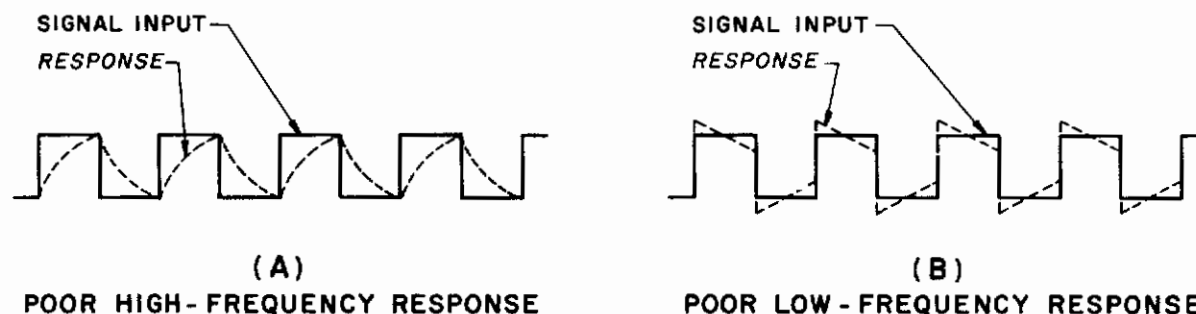

Figure 19. Frequency Distortion of a Square Wave

Consequently, the frequency-response curve of a physiological system, system component, or instrument is of primary interest. A frequency-response curve plots the relative output level of the system against the input frequency, with the input amplitude held constant at all frequencies. A typical frequency-response curve is shown in figure 20. A general rule to adhere to in order to ensure an output signal with minimal distortion is that the output levels of the highest and the lowest frequency contained in the measured signal should be at least 95 percent of the output level of the midrange frequency. In some instances, this rule may be modified, depending upon the importance of phase distortion in the measurement. The subject of phase distortion will be treated later in more detail.



## GENERAL SYSTEM CONSIDERATIONS

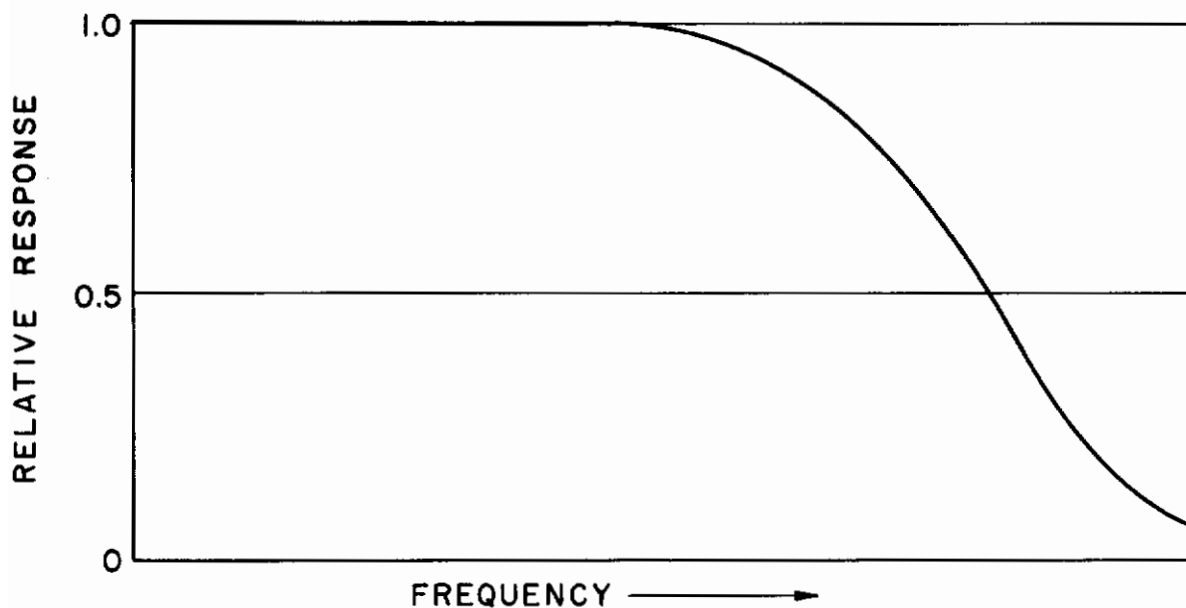

Figure 20. Typical Frequency-Response Curve

#### B. Impedance Matching

There are two major considerations when evaluating the impedance characteristics of a measuring system: (1) the input and output impedances of the individual components of the system, and (2) the input impedance of the measuring system with respect to the impedance of the physiological system being monitored.

When selecting components for a complete measuring system, adjacent components must be matched properly if the maximum amount of signal is to be transferred with minimum distortion. The transfer of a physiological signal between components may involve either (1) a transfer of voltage only (disregarding current) or (2) a transfer of power (voltage and current). If the signal transfer involves voltage only, the input circuit of the driven component may load the output circuit of the driving component to the point where the signal is distorted. To avoid this, the input impedance of the driven component should be as high as possible with respect to the output impedance of the driving component, consistent with system operation.

If power is to be transferred, the problem is considerably more complex. The maximum transfer of power occurs only when the impedances of the two adjacent components are equal. If a particular system component (an amplifier, for example) has a characteristic low input impedance and a high output impedance, the component preceding it must possess a low output impedance (to match the low input impedance of the amplifier), and the component following it must have a high input impedance (to

## BASIC PHYSIOLOGICAL MEASURING SYSTEMS

match the high output impedance of the amplifier). When these conditions are satisfied, maximum undistorted transfer of power will result. In many instances, an impedance-matching device, such as a transformer, may be necessary to transfer power efficiently.

The input impedance of the measuring system must be compatible with the physiological phenomena being monitored, since the electrical quantities (body resistance, potentials, etc.) of the human body normally are especially susceptible to influences from external measuring systems. High-impedance physiological systems, for example, cannot be monitored by a low-impedance measuring system. The low impedance of the measuring system would effectively "shunt" the physiological impedance and result in erroneous measurements. The input impedance of the measuring system normally should be several times greater than the internal impedance of the body system for proper results.

### C. Nonlinearity

Nonlinearity is distortion in the output indication of a measuring system relative to the input signal. Nonlinearity can result from many factors. For example, a mechanical system may have play in a lever system or backlash in a gear train. The most common cause of nonlinearity in physiological electronic measuring systems, however, is improper operation of vacuum tube or transistor circuits. Improper selection of circuit values and/or supply voltages may cause an amplifier to operate in the non-linear portion of its operating range. When this occurs, different levels of signal voltage result in different factors of amplification. For example, a signal with an amplitude of 0.5 volt may be amplified by a factor of 10, while a signal with an amplitude of 1 volt may be amplified only by a factor of 7. Typical results and causes of nonlinear operation are shown in figure 21. In some instances, transducers also may exhibit nonlinear operation over certain portions of their operating range. As a result, it is of prime importance that transducers, amplifiers, and all other system components be selected so that the linear portions of their operating ranges coincide with the signal levels to be handled.

### D. Interference and Artifacts

Interference and artifacts are sources of error that may originate within the measuring system itself or external to the system. Interference can be any form of noise or erroneous signal that tends to mask the desired measurement. There are two general methods by which external interference enters the measuring system: electrostatic induction and electromagnetic induction. Electrostatic interference results from the capacitive coupling effect between two conductors. The most common form of electrostatic interference is 60-cycle hum originating from the power lines of the building in which the measuring system is located. Electromagnetic interference results from the electromagnetic field produced by a varying current flow through a conductor. When another conductor is placed within the magnetic field, a current is induced in it.

## GENERAL SYSTEM CONSIDERATIONS

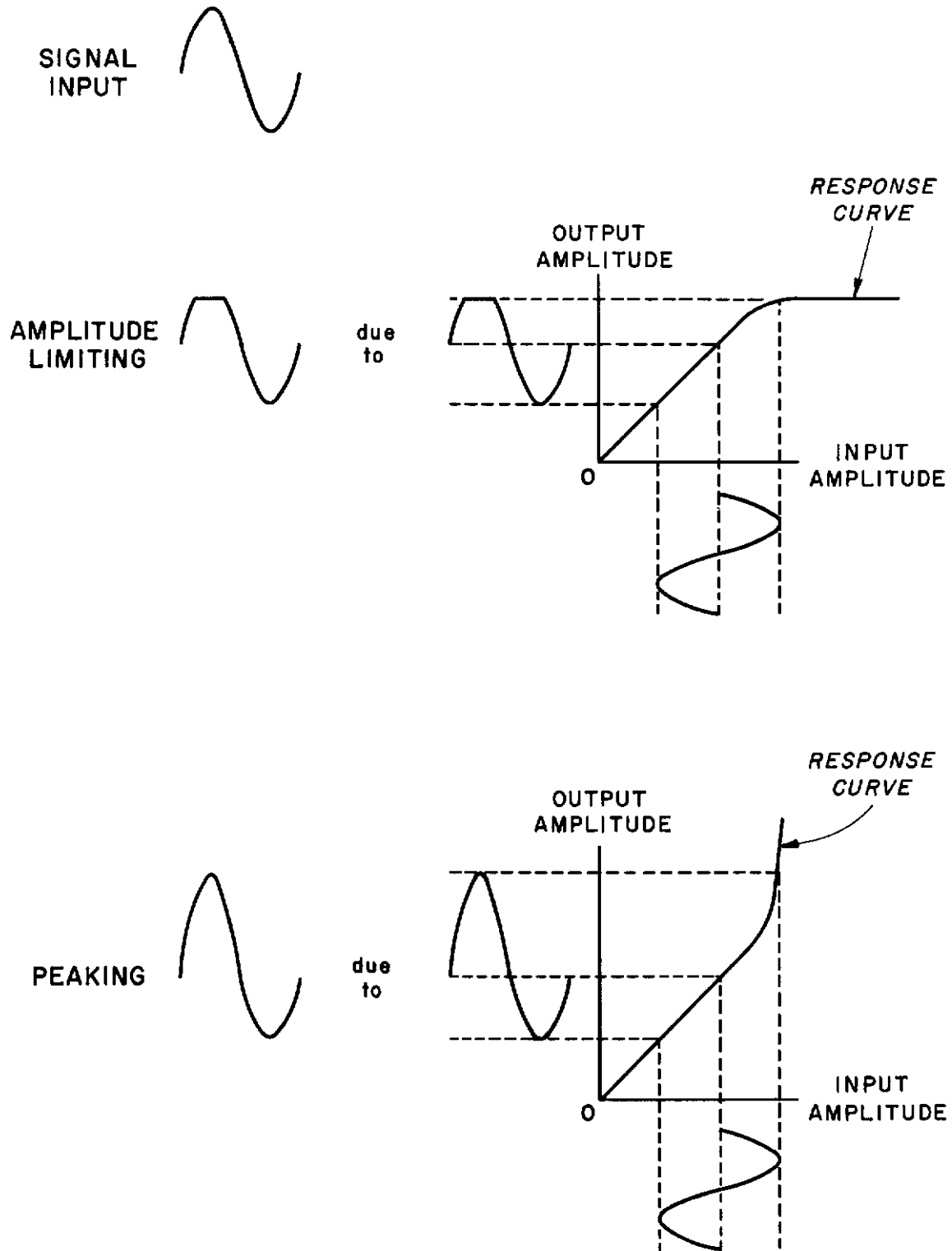

Figure 21. Nonlinearity of a Sine Wave

## BASIC PHYSIOLOGICAL MEASURING SYSTEMS

Erroneous signals resulting from artifacts are those which originate at the signal source itself. Artifacts usually occur as the result of interaction between the measuring system and the physiological system being monitored.

### SIGNAL PICKUP DEVICES

The signal pickup device is probably the most critical item in the measurement chain. The sensing device must be activated by the phenomena being measured and deliver, as an output, an electrical signal which quantitatively represents the phenomena. Furthermore, it must do this with a minimum effect or reaction on the source.

Two general classes of pickup devices are used in biomeasurements: transducers and electrodes. Transducers are used for measuring most of the environmental factors listed on the input side of figure 1. Electrode systems are required for many of the measurements on the output side. As mentioned in the introduction, the field of physical measuring devices will not be given detailed treatment. To do so means covering practically the whole field of physical measurement. Signal pickup devices concerned only and uniquely with physiological measurement are discussed.

#### I. Transducers

##### A. General

Generally defined, a transducer converts one type of energy into another. However, in physiological instrumentation, the term transducer usually is limited to include only the part of a monitoring system that is first exposed to the quantity being measured and that converts the quantity into an electrical form (voltage, current, or impedance).

Several types of transducers are available for monitoring the afferent (input) factors which affect physiological behavior. For example, abnormally high atmospheric pressure may be measured with a piezoelectric pressure transducer, consisting of a piezoelectric crystal which, when exposed to pressure from all sides (hydrostatic pressure), produces a corresponding voltage. Environmental temperature variations may be monitored with a temperature transducer consisting of a resistive element (resistance thermometer). The resistance of the element varies with temperature, and any change in temperature is detected as a change in the element's resistance.

##### B. Basic Considerations

Several basic operating characteristics must be considered when selecting a transducer for a specific application. These include input sensitivity and output impedance, which must be considered in all applications, and frequency response which becomes an important factor in certain physiological applications such as the monitoring of heart sounds.

## SIGNAL PICKUP DEVICES

### 1. Input Signal Level Response

The ability of a transducer to respond to input signals of varying amplitudes is one of its most important characteristics. The lower limit of the useful input range is governed generally by the amount of noise originating within the transducer. The upper limit of the useful input level usually is determined by excessive distortion of the signal or by possible damage to the pickup element.

### 2. Output Impedance

The output impedance of a transducer and the input impedance of the following stage (the signal modifier in figure 18) determine the amount of power that can be transferred from the pickup device at a given output-signal level. Maximum power transfer occurs only when the impedances are matched.

### 3. Frequency Response

The useful frequency ranges of different transducer types vary considerably, so the frequency range of the quantity being measured must be known and compared with the responses of the available transducers. For monitoring heart sounds, for example, a microphone (a transducer which converts sound energy into electrical energy) with a frequency response ranging from approximately 30 cps to several thousand cps is required.

## II. Electrodes

An electrode is a conductor that serves as a current transfer path from one medium to another. In physiological monitoring, electrodes form the connecting link between the source of biological potentials in the body tissue and the instrumentation. Electrodes usually are placed on the surface of the skin and respond to electrical impulses originating at various sources within the body tissue. The placement of the electrodes in relation to the source of potentials and the attenuation of signals by the resistance of the body tissue and skin are important reliability factors.

### A. Basic Considerations

#### 1. Electrode Placement

Electrodes must be positioned on the skin where they can obtain an adequate signal from the potential source. Simply placing the electrodes as close as possible to the source is not adequate. A source of biological potentials is a dipole; that is, it has a positive and a negative terminal. Potential sources are located in body tissue, a homogeneous medium that forms a conducting path in all directions from the source. As the distance from the source increases, the amplitude of the potentials is reduced by the resistance of the body tissue. In figure 22, the poles of the potential



BASIC PHYSIOLOGICAL MEASURING SYSTEMS

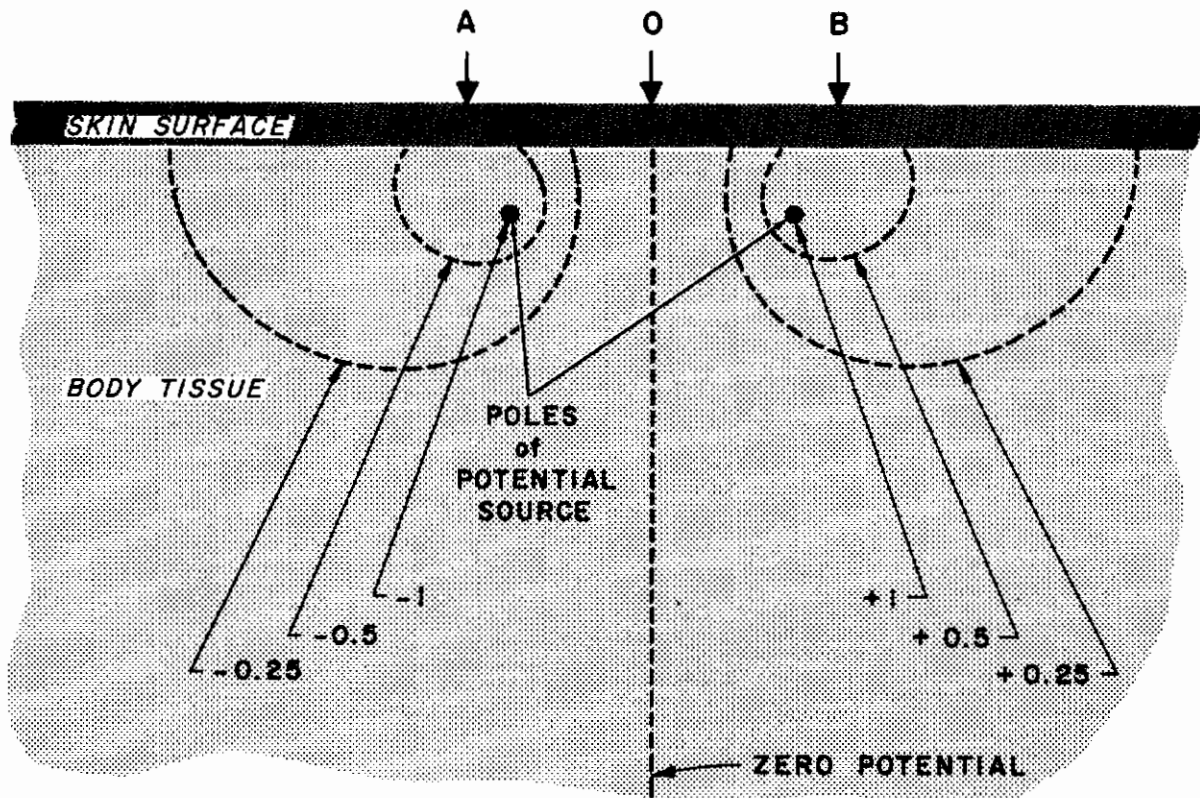

Figure 22. Potential Source Parallel to the Skin Surface

source are located near and parallel to the skin surface where the conducting medium ends. Surface electrodes placed at O and B would indicate a potential difference of slightly over 0.5 unit; between A and B there would be a potential difference somewhat over one unit.

Figure 23 illustrates the case where the poles of the potential source are oriented perpendicular to the outer surface. Here the optimum electrode position would be different. Electrodes equally spaced on either side of the source produce no output. The best position would be with one electrode (active) at A and another (indifferent) at O. The second electrode may be placed almost anywhere in the region beyond O without producing much difference in the observed potential. Hence the term "indifferent" or "reference" electrode.

The illustrations in figures 22 and 23 are intended only to give a qualitative idea of the general principles concerned with the detection of bioelectric potentials using surface electrodes. Conditions may vary considerably in practice.

## SIGNAL PICKUP DEVICES

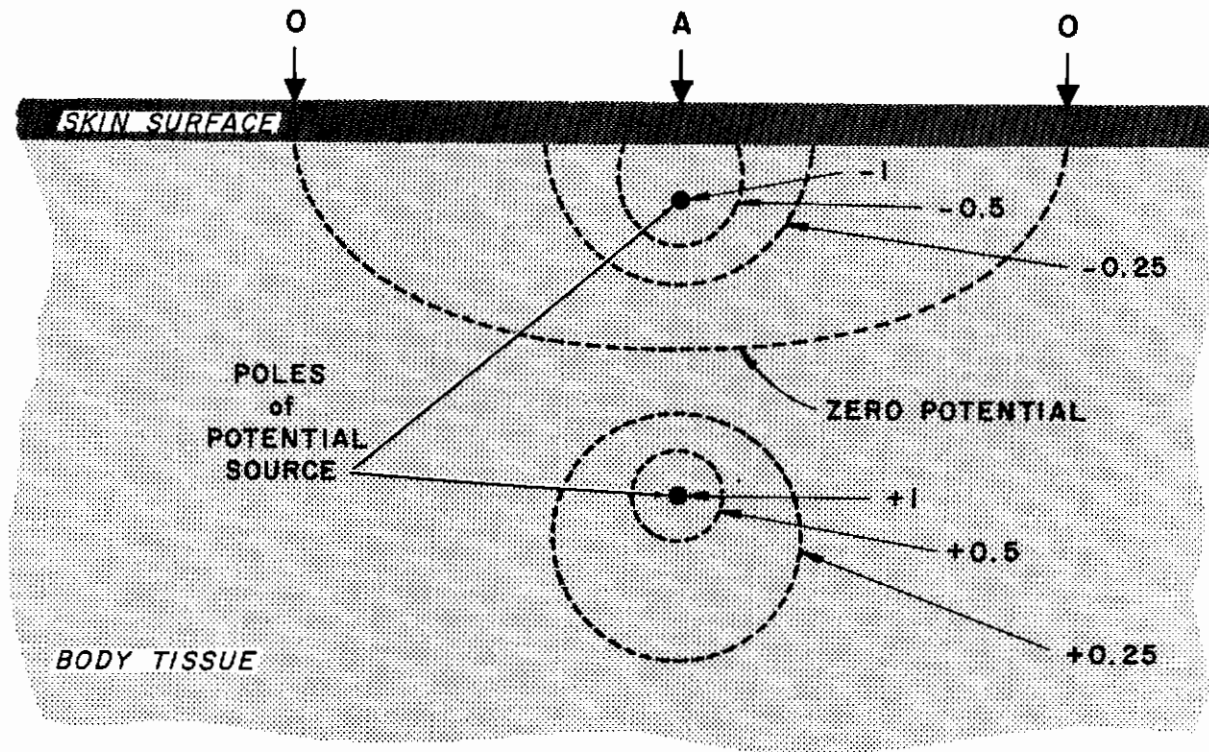

Figure 23. Potential Source Perpendicular to the Skin Surface

### 2. Skin and Tissue Resistance

The contact made by the electrode and skin surface is almost as important as electrode placement. The deep body tissues generally present very low resistance to the flow of electrical currents, being somewhere in the order of 100 ohms per unit cube. Skin resistance is mostly in the outer layer and can be extremely high, running as high as 2 kilohms per square centimeter for dry skin. The objective (the GSR is an exception) is to have resistance as low and as constant as possible, using electrodes of a practicable size.

The relationship of electrode resistance or impedance to the other input circuit factors is illustrated in figure 24. Figure 24A represents the circuit pictorially; figure 24B shows the equivalent electrical circuit. From figure 24B, it is evident that this is effectively a series circuit, and the same current flows throughout. Therefore, the voltage drop due to the high skin resistance is lost to the load circuit, which can be a serious factor. For example, in the extreme case of a transistor amplifier having an input resistance of less than 1000 ohms and a combined electrode resistance of 100,000 ohms, the voltage loss or attenuation will be more than 100 to 1.



BASIC PHYSIOLOGICAL MEASURING SYSTEMS

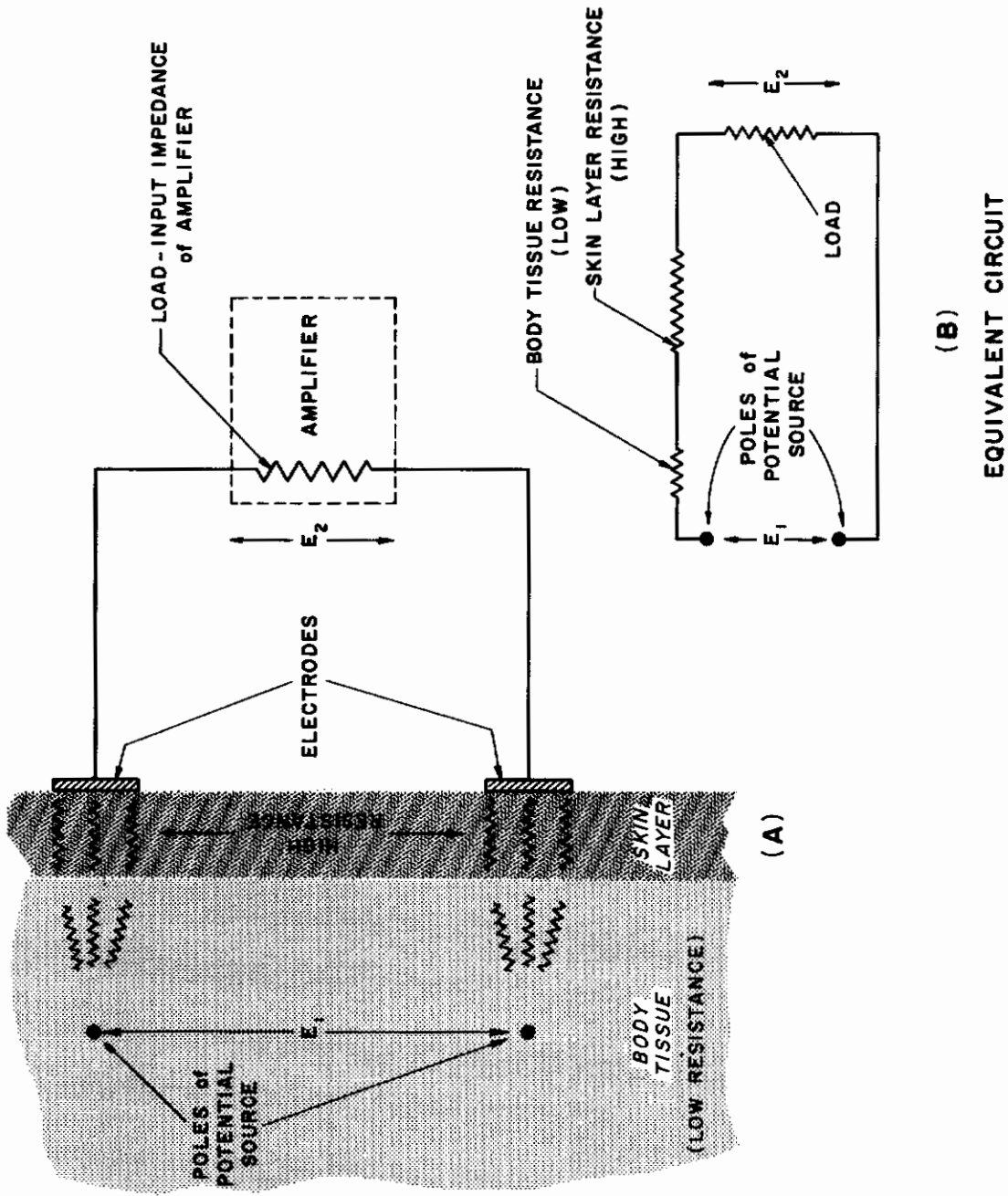

Figure 24. Relative Impedances in the Use of Electrodes

## SIGNAL PICKUP DEVICES

### B. Electrode Arrays

#### 1. Single-Ended Arrays

The single-ended or unipolar array is the simplest type of electrode array. It consists basically of two electrodes, each located at a different part of the body. One of the electrodes (normally the one nearest the bioelectric source being monitored) is called the "active" electrode, while the other one is referred to as the "reference" or "indifferent" electrode. The potential at the active electrode is measured with respect to the potential at the reference electrode.

Three or more electrodes can form a single-ended array by connecting all the electrodes but one to a central terminal as a reference and using the remaining electrode as the active electrode. When this configuration is used, the average potential at the reference electrodes (potential of the central terminal) is compared with the potential of the active electrode. Thus, the array remains single-ended; although a number of electrodes may be used, only one potential difference is available.

#### 2. Balanced Arrays

A basic balanced or double-ended electrode system may consist of one reference or indifferent electrode and two active electrodes. The potential difference between the reference electrode and the two active electrodes is compared, resulting in an output that is a function of the difference in potential between the two active elements. In some cases, the reference electrode may be omitted.

## SIGNAL PROCESSING

### I. General

In a physiological measuring system, the portion of the system located between the signal pickup device and the display unit generally is known as the signal-processing or modifying section. Signal processing may consist of any or all of several functions, including amplification, attenuation, modulation, frequency conversion, rectifying, filtering, or any other that might be required to prepare the signal for recording, transmission, or display.

The operation performed most commonly is amplification. The signal from the pickup device usually is weak and must be raised to a power level that permits the transmission and operation of recording or display devices. Because of its importance in physiological work, some discussion is provided here on the special features of amplification systems. Other signal processing functions will be covered in detail in the succeeding volumes of this handbook.

## BASIC PHYSIOLOGICAL MEASURING SYSTEMS

### II. Amplification

Since most physiological phenomena are evidenced by signals of extremely small amplitude, amplification is an important phase of signal processing. Physiological amplifiers may amplify either voltage, current, or power, and they may use either vacuum tubes or transistors. A voltage amplifier increases the voltage amplitude of its input signal without attempting to increase the power appreciably. A current amplifier increases signal current considerably; some current amplifiers have no voltage gain, and others provide a voltage output that is less than the input. Power amplifiers increase both voltage and current to develop enough power to drive a large device (for example, a transducer output is amplified to drive a power-driven recording device). Whether vacuum tubes or transistors are used in the amplifier's circuitry is dependent upon several factors, such as operational requirements, power availability, and environmental conditions.

#### A. Requirements

Although moderate signal distortion may be tolerable in some applications, physiological measurements generally require that low-distortion amplifiers be used. Signal distortion can be caused by inadequate frequency response, nonlinear operation, instability, insufficient or excessive signal input, and several other factors.

#### B. Basic Amplifier Types for Physiological Applications

Amplifiers can be classed in many ways. For example, they may be grouped by the type of coupling used between stages, by their operating frequency range, or by their class of operation. A convenient method of classifying amplifiers, especially those used in physiological applications, is to divide them into two general groups: single-ended and double-ended (balanced or differential) amplifiers. Each group of amplifiers may then be subdivided into various types, such as direct-coupled amplifiers, pulse amplifiers, and carrier amplifiers.

##### 1. Single-Ended Amplifiers

A single-ended amplifier consists basically of a single vacuum tube or transistor circuit with single input and output signals. A simplified single-ended amplifier is shown in figure 25. Several single-ended amplifiers can be connected in series (cascaded) to form a multistage amplifier with a higher gain. In practice, single-ended amplifiers present several problems, some of which are great enough to render the amplifier unsuitable for many physiological applications. They are especially prone to self-oscillation and unstable operation when slight changes in circuit parameters (supply voltages, cathode temperature, etc) occur.



## SIGNAL PROCESSING

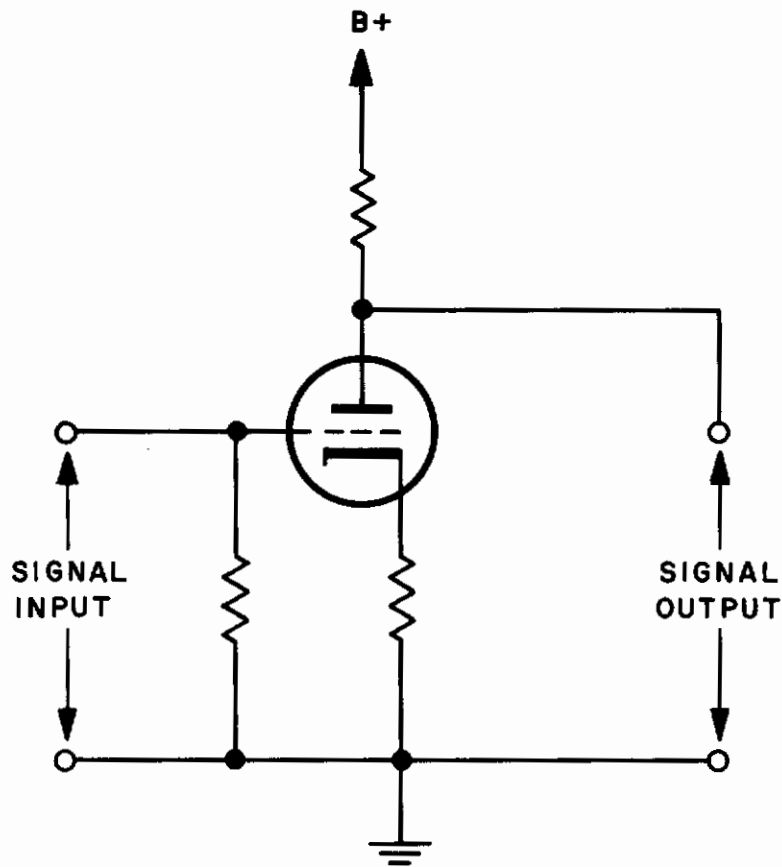

Figure 25. Simplified Single-Ended Amplifier

### 2. Double-Ended Amplifiers

There are several types of double-ended amplifiers; this discussion, however, is restricted to balanced and differential double-ended amplifiers, since these types are used most commonly in physiological applications. A balanced amplifier consists essentially of two single-ended amplifiers connected back-to-back symmetrically about a common reference point (usually ground). A schematic diagram of a simplified balanced amplifier is shown in figure 26. The input signal, which is balanced about the same reference point, is applied to the two amplifier grids in a way that causes the voltage at one grid to be swinging in a positive direction while the voltage at the other grid is becoming more negative. The voltages at the two plates, therefore, move in opposite directions so that an amplified output signal appears between them. This is known as push-pull operation, and balanced amplifiers also are called push-pull amplifiers.

BASIC PHYSIOLOGICAL MEASURING SYSTEMS

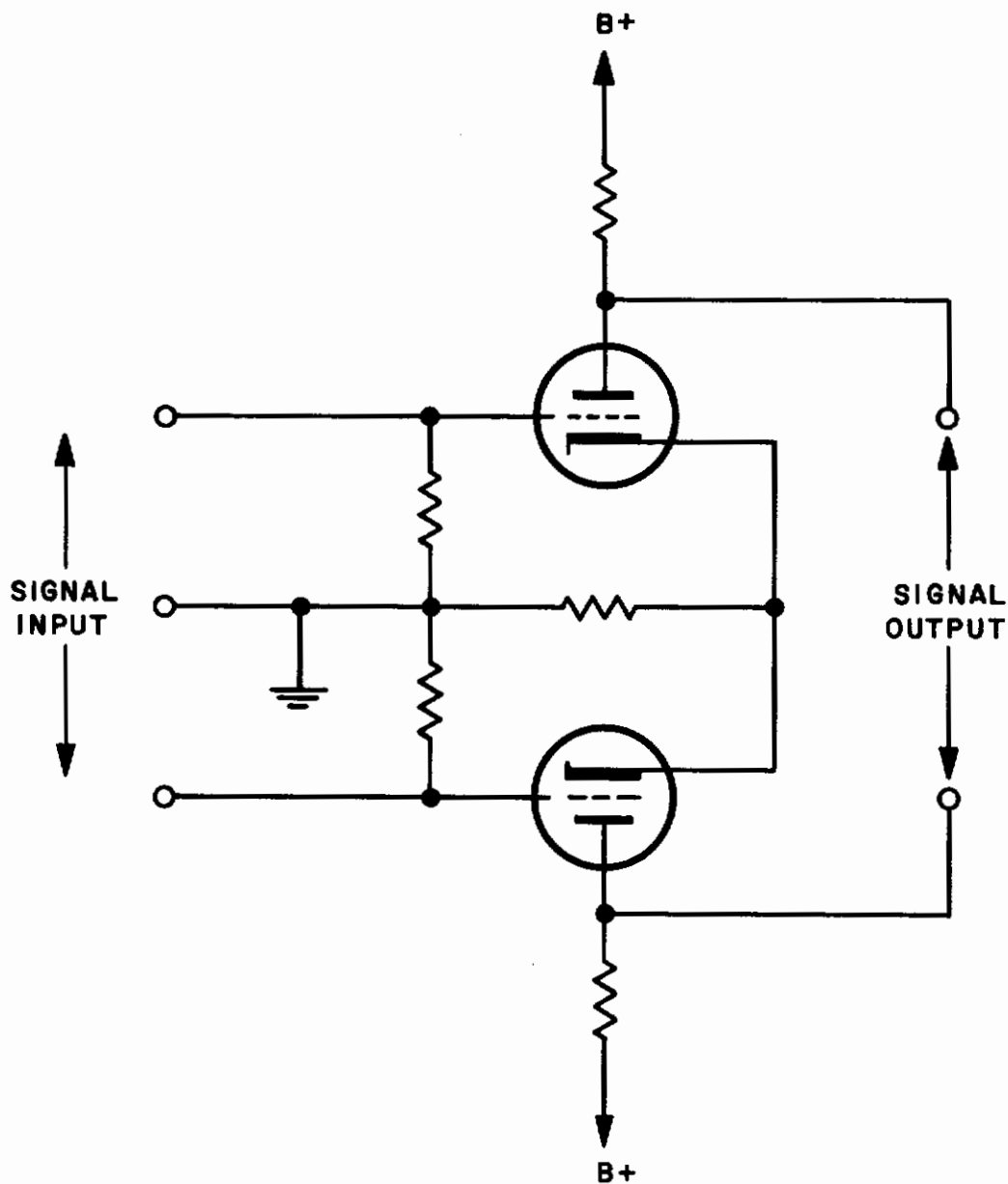

Figure 26. Simplified Balanced Amplifier

A differential amplifier, such as that shown in figure 27, is similar to a balanced, direct-coupled amplifier with one important difference. A differential amplifier responds to any difference of potential between the two input grids, whereas a normal balanced amplifier requires input signals to the two grids that are equal in amplitude and opposite in polarity (balanced antiphase input). If a +100-millivolt input signal is applied to one grid of a differential amplifier at the same time that an input

## SIGNAL PROCESSING

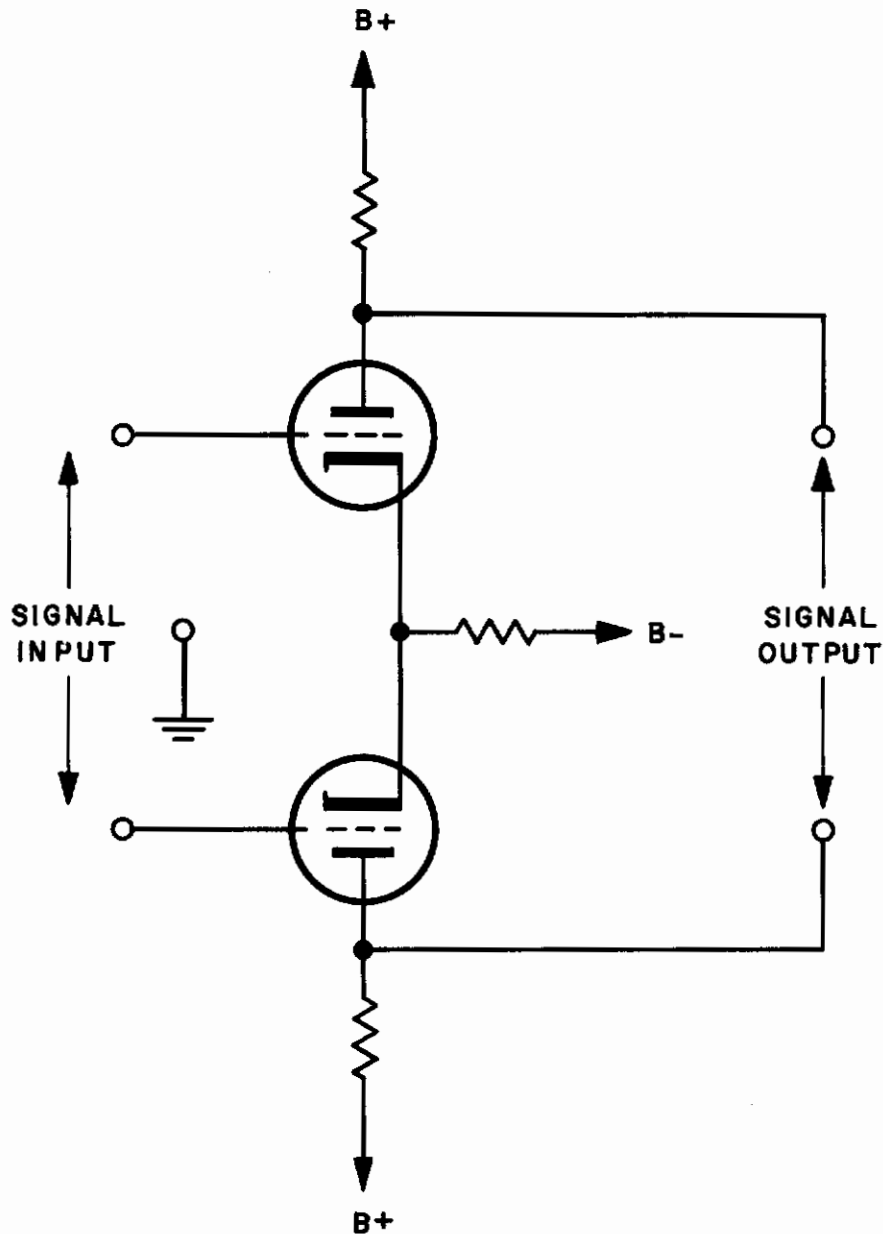

Figure 27. Simplified Differential Amplifier

of +110 millivolts is applied to the other grid, the effective input signal is 10 millivolts. The input signals to the two grids of a differential amplifier may be of the same or opposite polarity (e.g., an input of +40 millivolts applied simultaneously with an input of -50 millivolts produces an effective input of 90 millivolts). A differential amplifier also responds to an input applied to one grid only.

Double-ended operation offers several advantages. In a single-ended

## BASIC PHYSIOLOGICAL MEASURING SYSTEMS

amplifier, for example, a slight change in the supply voltage produces a corresponding change in the amplifier tube's plate voltage, which is indistinguishable from the output signal, resulting in a considerable signal distortion. In a balanced amplifier, however, slight changes in the supply voltage result in plate voltage changes on both amplifier tubes. Since the output of a balanced amplifier is the instantaneous voltage difference between the two amplifier plates, no change in the output signal results from slight power supply variations. The same principle holds true for slight variations in other circuit parameters. For any given set of circuit parameters, balanced amplifiers always offer better performance than can be obtained from a single-ended amplifier.

### DISPLAY

#### I. Basic Data Display Method

Data usually are displayed as a function of time. In other words, most display devices use time as one of the coordinates of the reading system. For example, a strip of recording paper or film passes a recording point at a known rate and a pen or other recording device records the signal. In cathode-ray-tube displays, the trace usually travels horizontally as a linear function of time, and vertical displacement of the trace is an indication of the magnitude of the phenomena. All display devices that present data as a function of time can be classified as time-axis recorders.

#### II. General Principles of Data Readout and Display Devices

##### A. Frequency-Response Grouping of Recording Devices

Recording devices may be classified according to their frequency response; there are low-frequency recorders, intermediate-frequency recorders, high-frequency recorders, and ultrahigh-frequency recorders. (These frequency classifications apply only to recording devices, and should not be confused with the frequency bands in the radio-frequency spectrum.) In all four frequency categories, the response of the recorders normally extends from zero to some specified limit. The frequency classifications, therefore, mostly apply to the upper frequency-response limitations of the recorders, and a high-frequency recorder may be used in place of a low- or intermediate-frequency recorder. If the low-frequency response limit of the recorder does not extend to zero, such as is the case with a cathode-ray oscilloscope employing a capacitively coupled input circuit, this generalization does not hold true, since the low-frequency response also must be considered.

##### 1. Low-Frequency Recorders

Low-frequency recorders generally are used in the frequency range from 0 to 2 cps. Ink-writing recorders that respond to input signals in the order of a few millivolts or to currents of 1 milliampere or less are examples of low-frequency or slow



## DISPLAY

recorders. These devices are slow because the mechanical arrangements used for converting electrical energy into a mechanical displacement of a pen or scribing point contain a considerable amount of inertia.

### 2. Intermediate-Frequency Recorders

Intermediate-frequency recorders have a frequency range extending from 0 to approximately 60 cps. The increased frequency range is obtained with the use of a pen motor, a device using a large quantity of electrical energy to produce a displacement against a stiff spring, so that the return from displacement is rapid in spite of the considerable masses being moved. The power requirement and the circuitry necessary to furnish it make the intermediate-frequency recorder much more expensive and more difficult to operate and maintain than the low-frequency recorders.

### 3. High-Frequency Recorders

The frequency response of high-frequency recorders is from 0 cps to approximately 5000 cps. The inertia and, therefore, the reaction time of high-frequency recorders is reduced by eliminating mass from the system. This is accomplished by using light beams and mirrors. The mirrors are mounted so that they turn with the coil movement of a galvanometer. A light beam falling on the mirror is reflected to a photosensitive surface and "writes" on the surface as it is moved by the mirror displacement. High-frequency recorders require optical systems, camera drives, and galvanometers. As a result, they are quite expensive compared to low- and intermediate-frequency recorders.

### 4. Ultrahigh-Frequency Recorders

The cathode-ray oscilloscope is an excellent ultrahigh-frequency recorder in that it is capable of operating with input frequencies ranging from 0 cps to beyond several hundred kc. Although the oscilloscope by itself does not provide a permanent record of displayed data, it is adaptable to both still and motion picture recording. Thus a record of the monitored data may be obtained and examined thoroughly at a later time.

#### B. Direct Writing Versus Photodevelopment

There are both direct-writing and photographic type recorders. With direct-writing recorders, the results are available immediately, while the photographic type requires a development process which results in some delay. Whether the application requires that results be immediate may be a factor in choosing a recording instrument.

Most direct-writing instruments use ink, and the displaced writing point is part of a pen. However, some recorders use heat-sensitive paper, and a heated stylus does

## BASIC PHYSIOLOGICAL MEASURING SYSTEMS

the writing. Electrosensitive papers also are available, on which the writing is accomplished by using the moving stylus as one electrode and passing a current through the paper.

Photographic recorders may use either film or paper. Both are available in many sizes, speeds, and emulsion types. In general, film is used only when the phenomenon occurs so rapidly that it cannot be recorded conveniently on the relatively slow paper. Recording devices are available in which the recording is done optically, and the development occurs right in the recorder. Theoretically, this combines the advantages of direct-writing and light-beam recording; however, some time still is needed for development.

### C. Curvilinear Versus Rectilinear Recording

The scribing point of many recording devices is located at the end of an arm that is pivoted at its other end; when the pivot is turned, the scribing point describes an arc. If the arm is parallel to the time axis in the middle of the chart, the scribing point is displaced along the time axis either above or below this midpoint. The resulting curvilinear recording does not provide a true displacement-versus-time record. This is less a disadvantage if chart paper containing curved time lines is used; however, it is still difficult to produce a perfectly accurate result.

The ideal type of recording is rectilinear recording, in which the vertical displacement of the scribing point is along a true straight line perpendicular to the time axis. Mechanical yokes are designed to convert a curvilinear or angular displacement into a rectilinear displacement; however, these yokes add inertia and mass to the system and therefore limit the upper frequency of the recorders.

### III. Recorder Impedances

Impedance must be considered when selecting recorders. Many low-frequency recorders used for millivolt measurements actually are recording potentiometers. As a result, they draw no current when balanced and therefore exhibit infinite impedance. Most recorders, however, use a galvanometer with a basic D'Arsonval movement or a penmotor coil. Both are current-actuated devices that must draw current in order to operate. Consequently, they are low-impedance devices and must be matched to low-impedance outputs in the signal-processing units.

### SPECIAL ACCESSORIES

The three functional classes of components noted in figure 18 (signal pickup devices, signal modifiers, and display devices) are common to practically all dynamic measuring systems. However, many situations encountered in practical usage require the addition of other items to the basic chain, as shown in figure 28.

## SPECIAL ACCESSORIES

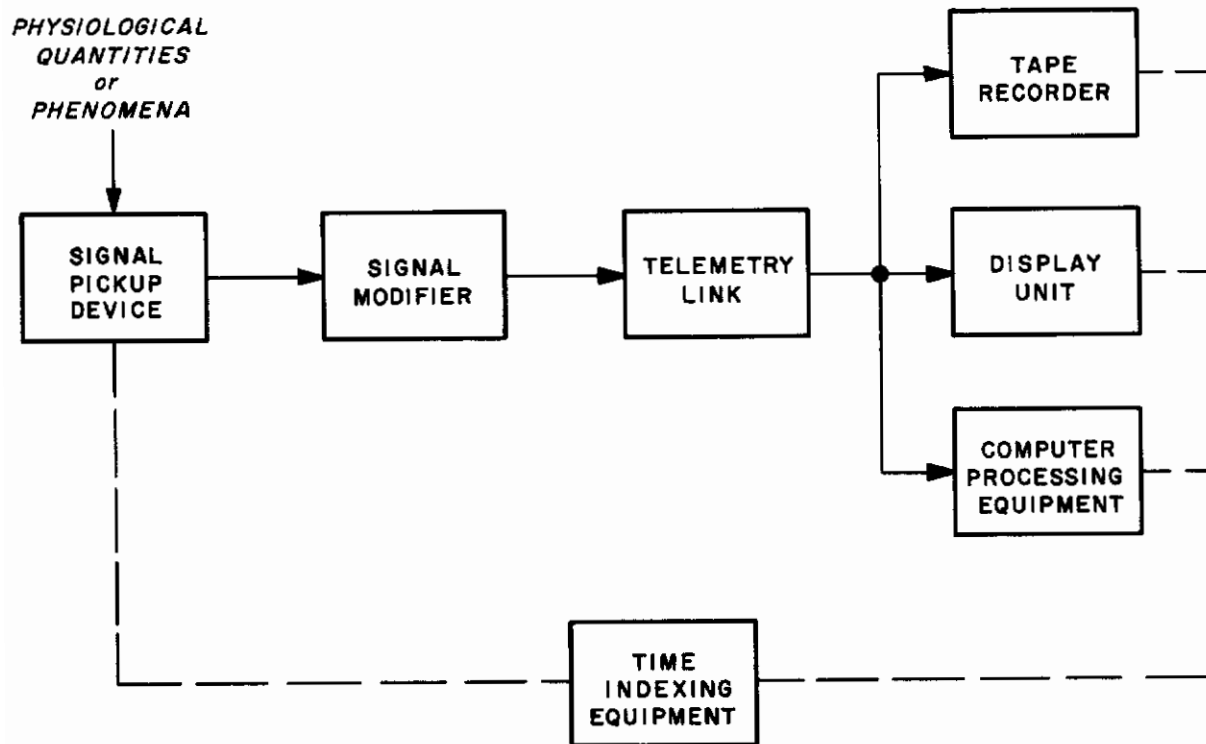

Figure 28. Physiological Measuring System with Accessories

### I. Telemetry

Telemetry, an extremely useful adjunct to many experimental situations, is an extra link in the measuring system chain, usually at the point between the modifier and the display device. The term telemetry embraces a number of processes or techniques for conveying quantitative information (i. e., measurement data) over a communication channel. The communication channel may be a wire link, in which case it is referred to as hard-wire telemetry, or it may be by radio transmission.

Telemetering systems are used when the experimental circumstances involve the element of danger or risk to the observer, or when ordinary methods of observation or recording are impracticable. It is the only method for ensuring the return of information when the vehicle or experimental site may be lost or destroyed in the course of an experiment. Telemetry generally involves complex electronic techniques and will be the subject of a separate section in another volume.

### II. Magnetic Tape Recording

Magnetic tape recording provides a record which permits electrical signals to be reproduced in the same form as they occurred during the actual experiment. Tape

## BASIC PHYSIOLOGICAL MEASURING SYSTEMS

recording performs a function similar to telemetry, except that tape-recording systems can provide a time lapse or delay between the experimental events and the subsequent observation or display.

Tape recording also helps data processing and interpretation. The electrical signals from the tape may be fed repeatedly to electronic computers for processing in different ways. Time axes also may be expanded or compressed easily by playing tape back at speeds different from that at which the recording took place. The general subject of tape recording systems will be treated at greater length in the succeeding volumes of this handbook.

### III. Computer Processing

Computer processing is a general term applied to special operations performed on certain signals. It is difficult to draw a definite line between operations classed as signal modification and those classed as computer processing. In many cases, the decision is arbitrary. However, in general the term computer processing applies to the more complex operations, particularly those involving accurate and rapid interpretation of several channels of data. For this purpose, automatic data-processing equipment, of which a computer is the central unit, is required. This equipment not only records and stores data, but it performs arithmetic operations as well as "logic" and "decision" functions.

### IV. Time Indexing

#### A. General

Data obtained by monitoring the physiological reactions of a human in an abnormal environment are of limited value unless the data can be correlated with variations in the environment. For example, if the subject is placed in an environment having a variable atmospheric pressure, the monitored data are significant only if some method is provided to relate the data with the variations in pressure. Since most physiological monitoring is accomplished remotely, automatic time correlation is the method that is used.

A convenient method of displaying data as a function of time is to provide strategically spaced time marks on the recorded data. The displayed data then can be compared with the phenomena occurring in the abnormal environment because they both are related in time. In some instances, some form of significant event markers may be desirable; i.e., markers which represent the occurrence of a particular change or event in the abnormal environment.

#### B. Establishing Correlation

One available reference for correlating data with time is the 60-cps line



## SPECIAL ACCESSORIES

voltage. When low-speed devices are used to record the monitored data, a synchronous electric clock (operating from the 60-cps line voltage) can be used to drive a bank of cams possessing a number of striking arms. These strikers can operate electrical contacts so that, by proper external connections, an electrical circuit is closed at intervals ranging from 1 second to 1 minute. The circuit can be completed by a battery and an electromagnetic event marker, with the marker producing a time mark on the recording paper. The accuracy of the time marks depends upon how closely the line voltage approximates 60 cps. Over an extended period, the cumulative error normally is zero; however, at any instant, an error as great as 2 percent is possible. For greater accuracy, the synchronous clock may be replaced by an electrically maintained pendulum, rotating a similar cam system.

The 60-cps line voltage also can be used for producing time markers on a separate time trace for high-speed display devices, such as the cathode-ray tube. However, this method is limited to displays with a time base that is longer than the duration of one complete cycle of the 60-cps line voltage (approximately 17 milliseconds). Although the 60-cps, sine-wave voltage can be used directly for time measurement marks, its accuracy is limited, since the peaks of the wave are so ill-defined. A more satisfactory timing waveform consists of a train of pips or triggers. The 60-cps line voltage can be converted into a train of pips by means of rectifying and differentiating circuits.

## SYSTEM INTEGRATION FACTORS

The basic physiological measuring systems discussed previously can be used under ideal conditions and for simple measurements. In practice, however, simple experimental situations seldom are encountered. The experimental environment may be so extreme as to affect system accuracy or even damage components and inactivate the system; simultaneous measurements on the same subject may be necessary which may cause interference or interaction problems; the experimental site may be isolated and unavailable for instrument adjustment or calibration; or the transmission link or channel may permit only a limited flow of information because of bandwidth requirements or transmission path characteristics. All these considerations affect the design of the instrumentation system. Although system integration factors will be treated in detail in the succeeding volumes of this handbook, the most critical factors are summarized here to present an overall picture.

### I. Physical Factors

#### A. Size and Weight Limitations

The size and weight of components of a monitoring system become critical in applications where the subject must carry portions of the system and in airborne and spaceborne applications. Large and bulky amplifiers, power supplies, etc, obviously

## BASIC PHYSIOLOGICAL MEASURING SYSTEMS

cannot be tolerated in such instances. Miniature components that satisfy the operational requirements of the task at hand must be used.

### B. Placement and Attachment of Pickup Devices

The placement and attachment of physiological pickup devices often present a major problem. If the subject is to perform certain tasks and remain reasonably comfortable during the monitoring procedure, the electrodes or transducers must be attached externally. This may result in a loss of signal accuracy in applications which normally require internal or surgically implanted electrodes for maximum accuracy and reliability. When selecting body locations for the attachment of pickup devices, both the physical restrictions imposed on the subject by the devices and the signal-to-interference ratio obtained from various locations during body movements must be considered carefully. A satisfactory compromise between these two extreme situations must be effected if proper system/subject compatibility is to be realized.

## II. Information Handling Capability of Data Transmission Links

The data transmission link or channel becomes a critical factor in applications where a telemetering system must be used to relay information from the experimental site to a remote display area. This is especially true in circumstances requiring a radio transmission link. The link must be designed to be compatible with the phenomena being monitored, the length of time available for transmitting information, transmission path characteristics, natural and manmade interference, etc.

## III. General Environment

Since environmental factors may affect the operation of physiological instrumentation, the design and integration of equipment to be used in abnormal surroundings must be considered carefully. General environmental factors and their possible effects on instrumentation are discussed in detail in volumes 2 and 3 of this handbook; a brief summary of the problem follows:

### A. Shock and Vibration

Shock and vibration may change electrical parameters in electronic circuitry or cause complete equipment failure.

### B. Temperature

When the environment of temperature is considered, it usually is thought of in combination with other environments. For example, most materials become brittle at low temperatures; conversely, at high temperatures the stiffness of materials decreases. Therefore, the reaction of equipment to shock and vibration forces will vary depending upon the temperature.

## SYSTEM INTEGRATION FACTORS

### C. Other Factors

X-ray, gamma, and nuclear radiation, corrosion resulting from gas, ozone, and other agents, and pressure variations may change physical and electrical parameters, and may result in erratic equipment operation or interrupted operation.

### IV. Equipment Interaction

Interaction between equipments often is a critical factor in system integration. Interaction (the pickup of carriers and pulses radiated from adjacent equipment) can result from ground currents or from electromagnetic coupling between circuits. To avoid ground current interaction, all components in a system should be grounded properly at one common point. Interaction caused by electromagnetic coupling can be minimized by shielding transformer circuits, which are the most potent sources of this type of interaction.

### V. Power Supply Problems

Various problems are encountered in conjunction with the source of power of a measuring system. In a conventional power supply operating from a 115-volt, a-c line supply, for example, ripple and hum may be present, and, when a single power supply is used to power two or more system components, intercoupling is possible, although a high-quality, well-regulated supply normally does not cause major interaction problems. Artifacts also may be introduced through unstable regulators and diodes.

When portable power sources are necessary, operating efficiency in severe environments and for extended periods of time becomes a critical factor. Batteries often are sensitive to ambient temperatures (they do not operate well under heavy loads at low temperatures), have a relatively short life expectancy, and are affected by low-pressure environments.

## ESTABLISHING VALIDITY OF REMOTE MEASUREMENTS

Test and "dry" runs that simulate actual mission conditions should be a planned part of every developmental program. Also, a so-called "blind" test of the data system should be made to determine the capabilities of the system and establish the validity of remote measurements. In a blind test an analytical group is supplied with "display" data from an experimental run in which various parameters are varied purposely. The analytical group, without knowledge of the programmed variables, then interprets or reconstructs the experiment from the accumulated data.

## **EXPLANATION OF TERMS**

"A" supply

Power used to heat the filaments of vacuum tubes in electronic equipment.

Acetylcholine

Substance released from nerves to activate the muscles.

Action potential

The alteration in electrical potential which accompanies the passage of an impulse along a nerve fiber.

Adrenal gland

Endocrine gland which secretes hormones for the regulation of the salt and water balance of body fluids, and the regulation of the level of carbohydrate substances in the blood, liver, and muscles.

Afferent

Bearing or conducting inward.

Alimentary canal

A tubular, food-carrying passage that extends from the mouth to the anus.

Alveoli

Air cells of the lungs.

Amino acids

A group of acids from which new protein molecules are formed.

Amplifier

An electrical device, usually containing vacuum tubes or transistors, whose output waveform is an enlarged reproduction of the essential characteristics of the input waveform.

Anabolism

The assimilative processes that make possible the growth and repair of tissues.

Anemia

A condition resulting from a deficiency of red cells or hemoglobin in the blood.

Antenna

The apparatus used to radiate the electromagnetic waves produced by a radio transmitter or to intercept or pick up electromagnetic waves for a radio receiver.



# Contrails

## Aortic arch

The large vessel (curved portion) arising from the left ventricle of the heart and distributing, by its branches, arterial blood to all parts of the body.

## Arterioles

A very small artery.

## Artifact

A spurious signal appearing in the display of a biological phenomenon that is caused by external means.

## Atria

The two upper chambers of the heart which receive the blood from the veins.

## Auricles

The two upper chambers of the heart which receive the blood from the veins.

## Auscultation

The detection and study of sounds arising from various organs, particularly the heart and lungs.

## Autonomic

Independent in origin, action, or function.

## Axon

Process of a nerve cell which conveys impulses away from the cell body.

## "B" supply

Power used to operate the plate and/or screen grid circuits of vacuum tubes in electronic equipment.

## Ballistocardiography

Recording of the movements of the body caused by the impact of the circulating blood and recoil of the body.

## Basal metabolism

The minimum amount of energy expenditure necessary to maintain body activity with the body at complete rest.

## Basal metabolism rate (BMR)

The amount of heat produced by the oxidation of foodstuffs in the body per 24 hours under standard conditions with activity reduced to a minimum.

## Behavioral system

Body system consisting of the parts of the body which are responsive to physiological stimulation.

## Bioelectric

The electrical phenomena that occurs in living tissue; the effects of electric currents upon living tissues.

## Bradycardia

Abnormal slowness of heart action.

## Bronchi

The two primary branches of the windpipe within the lungs.

## "C" supply

Power used to supply grid-bias voltage in vacuum tube circuits.

## Capacitor

An electrical device consisting of 2 conducting surfaces separated by an insulating material. The capacitor blocks the flow of direct current, stores electrical energy, and permits the flow of alternating current. Capacitors are rated in microfarads or micromicrofarads.

## Capillary

A minute blood vessel, one of a network connecting the smallest arteries and veins.

## Cardiac cycle

The sequence of events occurring during one beat of the heart.

## Carotid sinus

The principal large artery on each side of the neck.

## Carrier-current propagation

The method by which radio communication is conducted with the use of conventional power lines as the propagation medium.

## Catabolism

The process which releases energy for muscular activity by using up energy stored chemically in the body.

## Cerebral cortex

The external gray layer of the brain.

# Contrails

## Cerebral hemispheres

The two main portions of the brain, occupying the entire upper portion of the cranial cavity.

## Chemoreceptor

One of the receptors in a living cell capable of controlling chemical substances.

## Circulatory system

Body system, consisting of the heart, blood vessels, and lymphatic system.

## Computer

A device that is capable of accepting information, applying definite reasonable processes to the information, and supplying the results of these processes.

## Counter

An electrical circuit that receives uniform pulses, representing units to be counted, and produces a voltage proportional to their frequency.

## Cranial cavity

The part of the skull that contains the brain and its membranes and vessels.

## Dendrite

A process of the neuron which carries the nerve impulse to the cell body.

## Detection (demodulation)

The process of extracting the signal intelligence from a modulated carrier wave.

## Diastole

The rhythmic period of relaxation and dilatation of a chamber of the heart as it fills with blood.

## Diastolic pressure

The minimum arterial pressure occurring during ventricular diastole.

## Differentiating circuit

A circuit in which the amplitude of the output waveform is proportional to the rate of change of amplitude of the input waveform.

## Distortion

An undesired change in the waveform of an electrical quantity.

## Doppler effect

The apparent change in the frequency of an electromagnetic or sound wave as the distance between the source and the observer increases or decreases.

## Edema

The presence of abnormally large amounts of fluid in tissues.

## Efferent

Carrying away from a center.

## Electrocardiogram

The graphic record obtained with an electrocardiograph.

## Electrocardiograph

An instrument that records the changes in voltage produced by the contraction and relaxation of the heart muscle occurring in a physiological subject in synchronism with heart beats.

## Electrode

A terminal at which electricity passes from one medium into another.

## Electrodermal response (EDR)

Galvanic skin response.

## Electroencephalogram

The graphic record obtained with an electroencephalograph.

## Electroencephalograph

An instrument that records the electrical activity of the cerebral cortex.

## Electromagnetic coupling

Coupling that exists between circuits when they are affected by the same electromagnetic field.

## Electromagnetic field

Field of influence (combined electrical and magnetic fields) which is produced by the flow of current through a conductor.

## Electromyogram

The graphic record obtained with an electromyograph.

## Electromyograph

An instrument that records the changes of electric potential of muscle.

## Electrophysiology

The branch of physiology dealing with the production of electricity by living organisms and the effects of electric currents on living organisms.



## Endocrine system

Body system composed of glands which produce complex compounds (hormones) that pass directly into the blood.

## Epilation

Removal of hair by destruction of its roots (through the use of forceps, chemical means, or roentgen therapy).

## Erythema

An increased content of blood near the surface of the skin, resulting in red blotches of variable size and shape.

## Erythrocyte

A red blood corpuscle.

## Excretory system

Body system, consisting primarily of the kidneys, which eliminates waste products.

## Exteroceptor

An end organ which receives stimuli from the external world.

## Frontal lobe

Area of the brain that controls all body muscles and is responsible for complex association processes, such as recalling and thinking.

## G

Symbol for the acceleration due to the gravity at the surface of Earth (approximately 32 feet per second each second).

## Galvanic skin response (GSR)

The change in the electrical resistance of the skin that occurs when the subject is exposed to psychosensory stimuli.

## Galvanometer

An instrument for indicating or measuring an electrical current or a function of a current.

## Gastrointestinal system

Body system consisting of the stomach and the intestines.

## Gravireceptor

One of the receptors in a living cell that responds to gravitational forces.

## Gyrus

A convolution on the surface of the cerebral hemisphere.

## Hemoglobin

The respiratory pigment of the red blood cells.

## High-vacuum rectifier

Vacuum-tube rectifier in which conduction occurs entirely by electrons emitted from the cathode.

## Homeostasis

Maintenance of steady states in an organism by coordinated physiological processes.

## Homogeneous

Of uniform character in all parts.

## Hyperpnea

An increase in the depth of inspiration resulting from a reduction in partial pressure of oxygen.

## Hyperventilation

An increase in the quantity of air breathed (minute volume) particularly beyond that required physiologically resulting from an increase in the rate and/or depth of respiration.

## Hypothalamus

A part of the forebrain involved in the regulation of body temperature, sleep, water balance, carbohydrate and fat metabolism, and other functions.

## Hypoxia

Condition resulting from an inadequate supply of oxygen.

## Impedance

The opposition to the flow of alternating current in a circuit that contains resistance, inductance, and/or capacitance. The unit of impedance is the ohm.

## Inductance

The inherent property of an electric device to set up a self-induced electromotive force that opposes any change of current in the circuit. The unit of inductance is the henry.

## Innervate

Distribution of nerves to a part.

## Integrating circuit

A circuit in which the output signal is proportional to the frequency and amplitude of the input signal.

# Contrails

## Interference

Electrical disturbance which causes undesirable responses in electronic equipment.

## Ion

An atom or group of atoms which has lost or gained one or more orbital electrons and has thus become capable of conducting electricity.

## Ischemia

Local or temporary deficiency of blood.

## Kelvin scale

An absolute scale of temperature which has its zero at  $-273^{\circ}\text{C}$ .

## Kinesthetic

Pertaining to the perception of movement, weight, resistance, and position by muscular receptors.

## Korotoff sounds

Sounds heard during blood pressure determination.

## Leukopenia

A decrease below the normal number of certain white blood cells (leukocytes) in the peripheral blood.

## Lumen

The space inside a tube such as a blood vessel.

## Lymphatic system

Body system which circulates tissue fluids from the blood to the cells and back to the blood.

## Medulla

The lowest portion of the brain stem. It is connected to the spinal cord and is the center of many reflex activities.

## Mercury-vapor rectifier

A rectifier tube containing mercury vapor which is ionized by the application of a plate voltage.

## Mesentery

The membrane that anchors the small intestine to the abdominal wall.

## Metabolic system

Body system responsible for those processes and chemical reactions that convert food into simpler substances and supply the energy for vital functions.

## Metabolism

The process of synthesizing foodstuffs to provide the energy for vital processes and activities.

## Micturition

The act of passing urine.

## Minute volume

The total volume of air breathed per minute.

## Modulation

The process in which the amplitude, frequency, or phase of a wave is varied with time in accordance with the waveform of superimposed intelligence.

## Motor

Concerned with or pertaining to motion.

## Multiplexing

The process of transmitting a number of messages simultaneously on the same communication link.

Frequency division - The use of a different frequency band for each signal in a multiplex circuit.

Time division - The use of different time intervals for each signal in a multiplex circuit.

## Multivibrator

A two-stage oscillator in which the output of each stage is coupled to the input of the other. The output waveform is essentially a square wave.

## Mutual inductance

Common property of two associated circuits which determines, for a given rate of current in one of the circuits, the electromotive force induced in the other.

## Myelin

A fatty substance encasing the larger nerve fibers. Considered a poor electrical conductor.

## NBSG

British standard wire gauge.

## Neuron

Complete nerve cell, including the cell body, axon, and dendrites.



## Occlusion

A closure or a condition of being shut off.

## Ocular

Pertaining to the eye.

## Oscillator

An electronic device which generates alternating current power at a frequency determined by the values of certain circuit elements.

## Oscillogram

The recorder trace produced by an oscillograph.

## Oscillograph

An instrument that records the waveform of one or more varying electrical quantities.

## Oscilloscope

A device which makes the shape of a voltage or current wave visible on the screen of a cathode-ray tube.

## Oxygenate

To saturate a substance with oxygen.

## Oxyhemoglobin

Oxidized hemoglobin found mainly in arterial blood.

## Parathyroid gland

Endocrine gland which secretes the hormone which maintains the proper distribution of calcium in bones and in body fluids.

## Parietal lobe

Area of the brain that is sensitive to bodily sensations.

## Peripheral resistance

Resistance of peripheral blood vessels to the flow of blood.

## Peristalsis

The progressive wave of muscular contraction by which the contents of a tube are forced toward an end.

## Permeability (electrical)

A measure of the relative ability of a substance to conduct magnetic lines of force as compared with air, or magnetic conductivity.

# Contrails

## Permeability (physiological)

The property of plasma membranes which permits transit of molecules and ions by solution in membranes, and by mechanical passage through fine pores in the membranes.

## Phonocardiography

Graphic recording of heart sounds and murmurs by electric reproduction.

## Photoconductor

A substance whose electrical conductivity varies with illumination, as in gases, selenium, and some non-metallic crystals.

## Photoelectric

Concerning the electrical effects on a substance when exposed to light or other radiation.

## Photometer

An instrument that measures the intensity or quantity of light.

## Physiology

The science that deals with the functions of living organisms or their parts.

## Pituitary gland

Master endocrine gland which secretes hormones which regulate growth, sexual activities, and the amount of water secreted by the kidneys.

## Platelets

Blood cells important in blood clotting.

## Plethysmography

The graphical display of the change in volume of an organ resulting from an increase in the quantity of blood therein.

## Pleura

The delicate serous membrane enveloping the lung and lining the internal surface of the thoracic cavity.

## Potential

A measure of the concentration of an electrical charge at a given point.

## Potential difference

The algebraic difference between the voltages at two given points.

## Potentiometer

A three-terminal rheostat which functions as an adjustable voltage divider.

## Precordial leads

Leads attached to the torso of the subject.

## Proprioception

Appreciation of position, balance, and changes in equilibrium on the part of the muscular system.

## Proprioceptor

A receptor or sense organ whose reflex function is concerned with locomotion or posture.

## Psychogalvanic reflex (PGR)

Galvanic skin response.

## Psychological

Pertaining to the functions of the mind, such as sensation, perception, memory, and thought.

## Psychomotor

Pertaining to muscular action ensuing directly from a mental process.

## Pulmonary circulation

Circulation of air in the lungs.

## QRS complex

The portion of the electrocardiogram representing the electrical activity caused by excitation of the ventricles.

## Recorder

A device that prepares a record, usually graphic or numerical, of the value of a quantity as a function of time. The recorder is used to store information until needed.

## Rectifier circuit

A circuit which converts alternating current into unidirectional current.

## Rectification

The process of converting alternating current into unidirectional current.

## Relaxation oscillator

An oscillator which generates a nonsinusoidal periodic voltage by gradually storing electric energy and then quickly releasing that energy or vice versa.

## Rem

Roentgen equivalent, man (the quantity of any type of radiation which will produce the same biological effects in man as one roentgen of X or gamma radiation).

## Resistance (electrical)

The property of an electric circuit that opposes the flow of current through it. The unit of resistance is the ohm.

## Respiration depth

A measure of the volume of air inspired and expired during each respiration.

## Respiration rate

Rate of breathing, usually measured in breaths per minute.

## Respiratory membranes

The membranes lining the respiratory tract.

## Respiratory system

Body system that provides the body with oxygen to oxidize carbonaceous food, thereby generating heat and supplying the body with energy for performing work.

## Response

A quantitative expression of the output of a device or system as a function of the input under a given set of conditions.

## Rheostat

A resistor whose value can be varied; often used to adjust the current flow in a circuit.

## Roentgen

Standard unit for expressing quantities of X and gamma radiation (the quantity of X or gamma radiation required to produce one electrostatic unit of charge in one cubic centimeter of standard air).

## Selsyn

A single-phase, self-synchronous device which converts mechanical position into electrical signal, or vice versa. A trade name applied to this type of synchro.

## Semiconductor

A material, such as germanium or silicon, whose electrical resistivity is between that of a good insulator and that of a good conductor such as a metal.

## Sine Wave

An electrical wave of a periodically varying quantity with the form of a sine curve; the waveform of a normal alternating current.

# Contrails

## Sinusoidal

See sine wave.

## Square wave

A symmetrical periodic wave that varies, in time and amplitude, between two fixed values. Plotted graphically against time, it is square or rectangular in shape.

## Stimulus

Something that excites an organism or part to functionable activity.

## Subcutaneous

Beneath the skin.

## Synapse

The point at which an impulse passes from an axon of one neuron to a dendrite or to the cell body of another neuron.

## Synchro

A type of wound-rotor a-c motor used for repeating angular motion both as to speed and total angle.

## Systole

The contraction phase of the cardiac cycle.

## Systolic pressure

The maximum arterial pressure occurring during ventricular systole.

## Tachycardia

Abnormally rapid heart action.

## Telemetry

The science of accumulating and transmitting data to a remote receiving station.

## Thalamus

A mass of gray matter at the base of the brain which relays sensory signals to other brain parts and the spinal cord.

## Thermistor

A type of resistor in which the resistive element is a semiconductor whose resistivity varies with temperature. Used in temperature transducers.

## Thermocouple

A device consisting of two dissimilar metallic substances across which a voltage is developed when the junction of the two metals is heated.



## Thermoelectric effect

The electromotive force that results from a difference in temperature between two dissimilar metals that are joined.

## Thorax

The chest cavity or that portion of the trunk above the diaphragm and below the neck.

## Thyratron

A hot-cathode gas-discharge electron tube used to control relatively large amounts of electric current with a small control voltage.

## Thyroid gland

Endocrine gland which secretes the hormone, thyroxin, which regulates the basal metabolism rate and controls the liberation of heat after ingestion of food and during exercise.

## Time indexing

The method by which correlation is made between measured data and variations in environmental conditions.

## Tissue

An aggregate of similar cells and their intercellular substance forming one of the structural materials of the body.

## Trachea

The windpipe, a cartilaginous and membranous tube extending from the lower end of the larynx to its division into the two bronchi.

## Transducer

A device that transmits energy from one system to another and may be used to convert the energy from one form to another (mechanical to electrical or vice versa).

## Transformer

An electrical device, without moving parts, which by electromagnetic coupling transfers electrical energy from one circuit to another without change in frequency but usually with changed values of voltage and current.

## Transistor

A semiconducting device that transfers energy from one system to another and exercises control over this transfer. Its function is comparable to that of a vacuum tube.

Vagus

The tenth cranial nerve.

Vascular

Pertaining to a vessel for the conveyance of a fluid.

Vascular bed

The total blood supply of the arteries, veins, and capillaries of an organ or region.

Vasoconstriction

The constriction of blood vessels.

Vasodilation

The dilation of blood vessels.

Vasomotor

Regulating the size of the blood vessels; pertaining to those nerves concerned with the muscle fibers in the walls of the blood vessels.

Vasomotor centers

Nerve centers which control the size of the blood vessels.

Ventilation

Oxygenation of the blood in the capillaries of the lungs.

Ventricles

The two lower chambers of the heart which supply blood to the arteries.

Viscus (pl. viscera)

An organ enclosed within the cranial, thoracic, abdominal, or pelvic cavities; particularly the abdominal cavity.

Weightlessness

A condition characterized by the absence of gravitational force.

## **BIBLIOGRAPHY**

1. Altman, Philip L. (Analyst), et al., Handbook of Circulation, WADC Technical Report 59-593, Wright Air Development Center, Wright-Patterson AFB, Ohio, 1959.
2. Armington, John C. and Leonard L. Mitnick, Electroencephalogram and Sleep Deprivation, Walter Reed Army Institute of Research, Walter Reed Army Medical Center, Washington, D.C., ASTIA Document No. AD 219707.
3. Astronautics Communications-Electronics, Air Force Manual No. 100-25, Department of the Air Force, Washington, D.C., 1961.
4. Banner, E. H. W., Electronic Measuring Instruments, Chapman and Hall, Ltd., London, England, 1954.
5. Barbieri, Robert E., et al., A Radiobiology Guide, RCA Service Company, Inc., Camden 8, New Jersey, WADC Technical Report 57-118, Wright Air Development Center, Wright-Patterson AFB, Ohio, 1957, ASTIA Document No. AD 118082.
6. Basic Electronics, Navy Training Course NAVPERS 10087, U.S. Government Printing Office, Washington, D.C., 1955.
7. Beckman, Edw. L., LCDR, MC, USN, et al., Human Tolerance to High Positive G Applied at a Rate of 5 to 10 G per Second, Report No. NADC-MA-5302, Aviation Medical Acceleration Laboratory, U.S. Naval Air Development Center, Johnsville, Pa., 1953, ASTIA Document No. 20520.
8. Begun, S. J., Magnetic Recording, Technical Division, Rinehart and Company, Inc., New York, N. Y., 1958.
9. Benson, Otis O., Jr., and Hubertus Strughold (Editors), Physics and Medicine of the Atmosphere and Space, John Wiley and Sons, Inc., 1960.
10. Black, Harold S., Modulation Theory, D. VanNostrand Company, Inc., Princeton, N. J., 1953.
11. Boothby, Walter M., M.D. (Editor), Handbook of Respiratory Physiology, Air University, USAF School of Aviation Medicine, Randolph Field, Texas, 1954, ASTIA Document No. AD 49179.

# Contrails

12. Borden, Perry A. and Wilfred J. Mayo-Wells, Telemetering Systems, Reinhold Publishing Corporation, New York, N. Y., 1959.
13. Braestrup, Carl B. and Harold O. Wyckoff, Radiation Protection, published by Charles C. Thomas, Springfield, Ill., 1958.
14. Brazier, Mary A. B., B.Sc., Ph.D., The Electrical Activity of the Nervous System, The Macmillan Company, New York, N.Y., 1960.
15. Chance, Britton, et al., (Editors), Electronic Time Measurements, McGraw-Hill Book Company, Inc., New York, N. Y., 1949.
16. Closed Circuit Respiratory Systems Symposium, WADD Technical Report 60-574, Wright Air Development Division, Wright-Patterson AFB, Ohio, 1960, ASTIA Document No. AD 242587.
17. Communications-Electronics Terminology, Definitions, and Abbreviations, Air Force Manual No. 100-39, Department of the Air Force, Washington, D.C., 1960.
18. Dantzig, George B., et al., A Mathematical Model of the Human External Respiratory System, Research Memorandum RM-2519, The Rand Corporation, Santa Monica, Calif., prepared for the Directorate of Development Planning, Headquarters USAF, 1959, ASTIA Document No. AD 246199.
19. Donaldson, P. E. K., "A Multiple-Channel Oscilloscope for Electrophysiology," Electronic Engineering, Volume 29, February 1957.
20. Donaldson, P. E. K., et al., Electronic Apparatus for Biological Research, Butterworths Scientific Publications, London, England, 1958.
21. Eagan, C. J., The Mercury Gauge Method of Digital Plethysmography, Technical Note AAL-TN-60-15, Arctic Aeromedical Laboratory, Alaskan Air Command, Fort Wainwright, Alaska, 1961, ASTIA Document No. AD 253711.
22. Electronics Technician 3, Navy Training Course, NAVPERS 10188, U.S. Government Printing Office, Washington, D.C., 1954.
23. Ellinger, Fredrich, M.D., Medical Radiation Biology, published by Charles C. Thomas, Springfield, Ill., 1957.
24. Flaherty, Bernard E., Lt. Col., USAF (MC), et al., Psychiatry and Space Flight, School of Aviation Medicine, USAF Aerospace Medical Center (ATC), Brooks AFB, Texas, 1960, ASTIA Document No. AD 245416.

# Contrails

25. Frederick, Carl L., et al., Design Techniques for Interference-Free Operation of Airborne Electronic Equipment, Wright Air Development Center, Wright-Patterson AFB, Ohio, 1952.
26. Glassner, Harvey F. and George A. Peters, Bio-Electronic Analysis of Performance, DAC Engineering Paper No. 897, Douglas Aircraft Company, Inc., El Segundo, Calif., prepared for the Office of Naval Research, 1960, ASTIA Document No. 235969.
27. Glossary of Computer, Missile and Electronic Terms, Field Support Engineering, Government Services, RCA Service Co., Camden 8, N. J., 1960.
28. Goldberg, M. N., et al., Instrumentation Package for Inflight Physiological Studies, North American Aviation, Inc., Los Angeles, Calif., WADD Technical Report 60-83, Wright Air Development Division, Wright Patterson AFB, Ohio, 1960.
29. Goldman, David E., Commander, MSC, USN, Short Wave Electromagnetic Radiation as a Hazard to Personnel, Lecture and Review Series No. 60-6, Naval Medical Research Institute, Bethesda, Maryland, 1960, ASTIA Document No. AD 252582.
30. Goldman, David E., Commander, MSC, USN and Henning E. Von Gierke, The Effects of Shock and Vibration on Man, Lecture and Review Series No. 60-3, Naval Medical Research Institute, Bethesda, Md., 1960, ASTIA Document No. AD 241621.
31. Hammel, Harold T., Thermal and Metabolic Responses of the Alacaluf Indians to Moderate Cold Exposure, Department of Physiology, University of Pennsylvania, WADD Technical Report 60-633, Wright Air Development Division, Wright-Patterson AFB, Ohio, 1960, ASTIA Document No. 252095.
32. Headley, Robert N., Captain, USAF, MC, et al., Human Factors Responses During Ground Impact, WADD Technical Report 60-590, Wright Air Development Division, Wright-Patterson AFB, Ohio, 1960, ASTIA Document No. 252444.
33. Hodgeman, Charles D. (Editor), et al., Handbook of Chemistry and Physics, The Chemical Rubber Publishing Company, Cleveland, Ohio, 1960.
34. Hoerr, Normand L., M.D. and Arthur Osol, Ph.D. (Editors), Illustrated Pocket Medical Dictionary, Blakiston Division of McGraw-Hill Book Company, Inc., New York, N. Y., 1952.



# Contrails

35. Hoffman, Rudolf A., Radiation Hazards of Primary Cosmic Particles, Air Force Missile Development Center Technical Report 59-32, Holloman AFB, New Mexico, 1959, ASTIA Document No. 226633.
36. Lampietro, P. F., et al., Heat Production from Shivering, Technical Report EP-145, U.S. Army Quartermaster Research and Engineering Center, Natick, Mass., 1961, ASTIA Document No. AD 252092.
37. Johnson, Gilbert E., 1/Lt, USAF, et al., Application of Skin Resistance in Psychophysiological Studies, WADC Technical Report 59-688, Wright Air Development Center, Wright-Patterson AFB, Ohio, 1959, ASTIA Document No. AD 243613.
38. Kaehler, Richard C. and John P. Meehan, M.D., Human Psychomotor Performance Under Varied Transverse Accelerations, School of Medicine, University of Southern California, WADD Technical Report 60-621, Wright Air Development Division, Wright-Patterson AFB, Ohio, 1960, ASTIA Document No. AD 247169.
39. Kolin, Alexander, "Improved Apparatus and Technique for Electromagnetic Determination of Blood Flow," Review of Scientific Instruments, Volume 23, May 1952.
40. Langford-Smith, F. (Editor), Radiotron Designer's Handbook, Amalgamated Wireless Valve Company Pty, Ltd., Sydney, Australia, reproduced and distributed by the Tube Division, Radio Corporation of America, Harrison, N.J., 1953.
41. Lion, Kurt S., "Electrical Input Transducers," Instrumentation in Scientific Research, McGraw-Hill Book Company, Inc., New York, N. Y., 1959.
42. Murray, Edward J., Conflict and Repression During Sleep Deprivation, Walter Reed Army Institute of Research, Walter Reed Army Medical Center, Washington, D.C., 1958, ASTIA Document No. AD 226482.
43. Nichols, Myron H. and Lawrence L. Rauch, Radio Telemetry, John Wiley and Sons, Inc., New York, N. Y., 1956.
44. Nisbet, W., "Instrument for Measuring Respiratory Rates and Volumes," Journal of Scientific Instruments, Volume 33, April, 1956.
45. O'Kelley, L. F., et al., Telemetry Transducer Handbook, Volume I, Research Division, Radiation Incorporated, Orlando, Florida, WADD Technical Report 61-67, Wright Air Development Division, Wright-Patterson AFB, Ohio, 1961.

46. Pettitt, Julia A., M.T., et al., Multiple Psychophysiologic Measures During Gradual Onset Acceleration, WADC Technical Note 57-234, Wright Air Development Center, Wright-Patterson AFB, Ohio, 1958, ASTIA Document No. AD 130796.
47. Physiology of Flight, Air Force Pamphlet No. 160-10-4, Department of the Air Force, 1961.
48. Proceedings of the IRE, Volume 47, No. 11, Bio-Medical Electronics Issue, Institute of Radio Engineers, Inc., November, 1959.
49. Randall, James, "Electromagnetic Blood Flowmeter," Review of Scientific Instruments, Volume 20, December 1949.
50. Rushmer, Robert F., Captain, MC, Physiology of Increased Interthoracic Pressure in Relation to the Effect of Centrifugal Forces: (2) Arterial Pressure, Venous Pressure, and Finger Volume During Increased Intrapulmonic Pressure, report of the School of Aviation Medicine, Randolph Field, Texas, 1943, ASTIA Document No. 132985.
51. Rushmer, Robert F., Captain, MC, Physiology of Increased Interthoracic Pressure in Relation to the Effect of Centrifugal Forces: (4) Comparison of Physiological Responses to Increased Intrapulmonic Pressure and to Applied Centrifugal Forces, report of the School of Aviation Medicine, Randolph Field, Texas, 1944, ASTIA Document No. 132986.
52. Schock, Grover J. D., Capt., USAF, Airborne Galvanic Skin Response Studies, AFMDC-TN-59-14, Air Force Missile Development Center, Holloman AFB, New Mexico, 1959, ASTIA Document No. AD 215465.
53. Schwan, Herman P., Determination of Biological Impedances, Electromedical Division, Moore School of Electrical Engineering, University of Pennsylvania, prepared under grants by the United States Public Health Services and the Office of Naval Research, 1961, ASTIA Document No. 246604.
54. Smedal, Harold A., Captain, USN (MC), et al., Flight Evaluation of an Airborne Physiological Instrumentation System, Including Preliminary Results Under Conditions of Varying Accelerations, Technical Note D-351, National Aeronautics and Space Administration, Ames Research Center, Moffett Field, Calif., ASTIA Document No. AD 247141.
55. Smedal, Harold A., Capt., USN (MC), et al., Physiological Effects of Acceleration Observed During a Centrifuge Study of Pilot Performance, NASA Technical Note D-345, Ames Research Center, Moffett Field, Calif., 1960, ASTIA Document No. AD 247140.

56. Sosnow, W. and E. Ross, Electrodes for Recording Primary Bioelectric Signals, Litton Industries, Beverly Hills, California, prepared for Aerospace Medical Division, Wright Air Development Division, Wright-Patterson AFB, Ohio, 1960.
57. Space Handbook: Astronautics and Its Applications, staff report of the Select Committee on Astronautics and Space Exploration, 85th Congress, 1959.
58. Space Technology Lecture Series, WADC Technical Report 59-732, Wright Air Development Center, Wright-Patterson AFB, Ohio, 1959, ASTIA Document No. AD 235424.
59. Stacy, Ralph W., Ph.D., Biological and Medical Electronics, McGraw-Hill Book Company, Inc., New York, N. Y., 1960.
60. Stoll, Alice M., M.S., Human Tolerance to Positive Gas Determined by Physiological End Points, Report No. NADC-MA-5508, U.S. Naval Air Development Center, Johnsville, Pa., 1955, ASTIA Document No. AD 75326.
61. Tall, Joel, Techniques of Magnetic Recording, The Macmillan Company, New York, N. Y., 1958.
62. Thorner, Melvin W., Major, MC, The Effect of Carbon Dioxide on the Electroencephalogram at Ground Level, report of the School of Aviation Medicine, Randolph Field, Texas, 1944, ASTIA Document No. 135571.
63. Tokay, Elbert, Ph. D., Fundamentals of Physiology, Barnes and Noble, Inc., New York, N. Y., 1959.
64. Tolles, Walter E. and William J. Carbery, A System for Monitoring the Electrocardiogram During Body Movement, Airborne Instruments Laboratory Division of Cutler-Hammer, Inc., WADC Technical Report 58-453, Wright Air Development Center, Wright-Patterson AFB, Ohio, 1959, ASTIA Document No. AD 215538.
65. Traite, M., et al., "Environmental Testing of Future Spacemen," Electronics, Volume 32, 9 October 1959.
66. Watson, John F., Capt., USAF, MC, et al., Respiratory Mechanics During Forward Acceleration, WADD Technical Report 60-594, Wright Air Development Division, Wright-Patterson AFB, Ohio, 1960, ASTIA Document No. AD 252621.
67. Webb, Paul, "Measurement of Respiratory Air Temperature," Review of Scientific Instruments, Volume 23, May 1952.
68. Whitfield, I.C., D.Sc., An Introduction to Electronics for Physiological Workers, St. Martin's Press, Inc., New York, N. Y., 1960.

69. Wood, Earl H., M.D. et al., Effect of Headward and Forward Accelerations on the Cardiovascular System, Mayo Foundation, Mayo Clinic, Rochester, Minn., WADD Technical Report 60-634, Wright Air Development Division, Wright-Patterson AFB, Ohio, 1961, ASTIA Document No. AD 255298.