

EFFECTS OF ULTRAHIGH PRESSURES ON THE FORMATION
AND PROPERTIES OF ORGANIC, SEMIORGANIC,
AND INORGANIC MATERIALS

E. J. Bradbury, C. M. Schwartz, R. C. Himes, C. B. Sclar, L. C. Carrison,
H. H. Krause, H. E. Bigony, C. R. Gray, and R. I. Leininger

Battelle Memorial Institute

ABSTRACT

Studies on the effect of ultrahigh pressures (up to 90,000 atmospheres) were carried out on organic polymers and a variety of semiorganic and inorganic materials. The experimental work was done in a Belt-type internally heated high-pressure apparatus calibrated by means of electrical-resistance discontinuities in Bi, Tl, and Ba using the fixed pressure points of the "new" post-1960 absolute pressure scale.

With organic polymers results to date indicate that the effect of compression is influenced by: (1) The compression attained, (2) the compression rate, (3) the holding period, and (4) the polymer used. The most influential parameters within the target range of compression appear to be the polymer and the holding period. Results to date do not show any generalized pattern of behavior for polymers. Rather the limited data suggest that each material may well have its individual response to compression.

Among the semiorganic compounds studied, dimethyldicyano silane apparently polymerized at 60,000 atmospheres through conversion of the nitrile groups to $>C=N-$. Other semiorganics, alumino-siloxanes, ethyldicyanophosphine, arseno-siloxane, phosphonitrilic chloride trimer and diphenylphosphinoborine showed little effect of pressure or decomposed.

In the work with inorganic materials, ultrahigh-pressure high-temperature studies of two heteropolynuclear acids (silicotungstic and phosphotungstic acid) and two heteropolynuclear salts (ammonium-arseno-vanado tungstate and ammonium-phospho-vanado tungstate) revealed what appear to be pressure-dependent modifications over a broad pressure-temperature range to 75,000 atmospheres and 1300 C. The results of preliminary high-pressure experiments on a group of sulfides, including Sb_2S_3 and As_2S_3 , and on apatite $[Ca_5(PO_4)_3(OH,F)]$ were negative.

INTRODUCTION

Relatively recently (in the past few years) equipment and techniques for ultrahigh pressure* have been developed to the point where it is available for use as a method to modify or synthesize polymers.

Bridgman pioneered studies in the 1930's on very high pressures and interest continued but at a relatively low level until the last decade. At that time internally heated high-pressure devices, such as the Belt, were developed making the attainment of ultrahigh pressures at elevated temperatures feasible. Shortly thereafter came the development of a process (which quickly became commercial) for the production of diamonds from graphite and later the production of the heretofore unknown Borazon.

With this precedence, the question arose as to the possibility of improved polymers through such ultrahigh pressures and to answer this the Aeronautical Systems Division of the Air Force has sponsored this present study.

As the background relating to the effects of ultrahigh pressure was quite limited, this program was directed primarily towards a screening of the effects upon three classes of polymers, organic, semiorganic, and inorganic. Past efforts in the field of ultrahigh pressures were reviewed in a separate, initial phase of this study.

In the case of organic polymers, two general types of changes can be expected — physical in which some property such as crystallinity is enhanced and chemical in which new bonds are established. It is the latter case which offers the most promise. It is expected that bonds which do not normally participate in polymerization reactions will be activated by the pressures exerted. These bonds include double and triple bonds, carbonyl linkages, aromatic carbon-carbon double bonds, nitrile, and the like. As has been already noted, evidence has been found of reaction of nitrile triple bonds under extreme pressure. It is known that rates and molecular weight increase as the pressures are increased in polymerizations but the phenomena have been studied only to much lower pressures than the target of this work. Possibilities here lie not only in the production of higher molecular weight materials but also in products of higher density through more complete crystallization. Unconventional routes to polymers through normally inactive groups are also of interest as is possible grafting to preformed polymers.

As was stated before, this program was designed to determine whether the extreme pressures would cause any of these changes in starting materials of the

*Ultrahigh pressures is here meant to be equal or greater than 30,000 atmospheres (new 1960 scale).

three classes of interest. Detection of these changes was to be made by measurement of physical or chemical properties by any one or combination of suitable methods.

APPARATUS

The high-pressure device used in all the studies on this project was the G.E. Belt based on the original design of H. T. Hall. Essentially, the Belt device consists of a pair of truncated tungsten carbide pistons which are forced by a hydraulic ram into a tungsten carbide die. Both the die and the pistons are surrounded by a series of concentric steel binding rings to afford massive support, and the device may be internally heated and instrumented. Hydraulic ram force was supplied by either a 1,000-ton Hall multiple-piston ram, a 100-ton Blackhawk jack, or a 150-ton Watson-Stillman press. Figure 1 shows an over-all view of the Belt apparatus and Figure 2 shows details of the apparatus as used with organic materials.

It should be noted that the pressure scale used in this research is the new (mid-1960) scale which is now generally accepted by workers in this field.

EFFECT OF PRESSURE ON ORGANIC MATERIALS

Polymer Compression

Compression studies conducted during the course of this program have been divided into two categories for convenience in discussion. First, those conducted in an intermediate range to investigate the effects of different parameters, and, second, compressions conducted within target range. Characterization in all instances was based upon net density change of the polymer.

Parameter Investigation at Intermediate Compression

Effect of Compression on Density. Currently the density-gradient apparatus appears to be the most satisfactory method for rapidly determining the extent of change in the polymers used in this study. At present, the columns are designed to give resolution to one in the fourth decimal place. Density gradient columns were used to provide a comparison of the density of molding materials with extruded material. There generally was a slight increase, possibly due to some

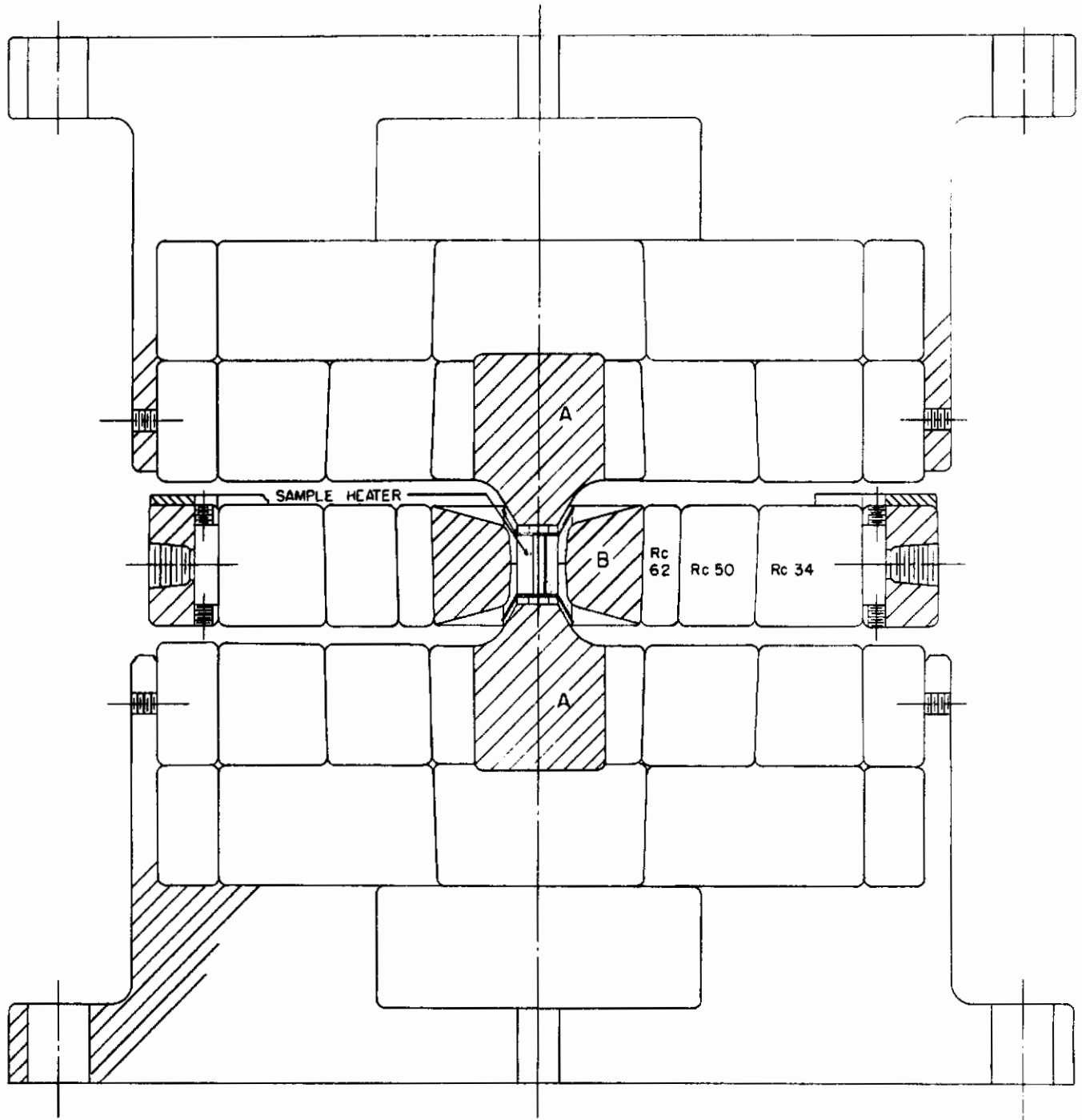
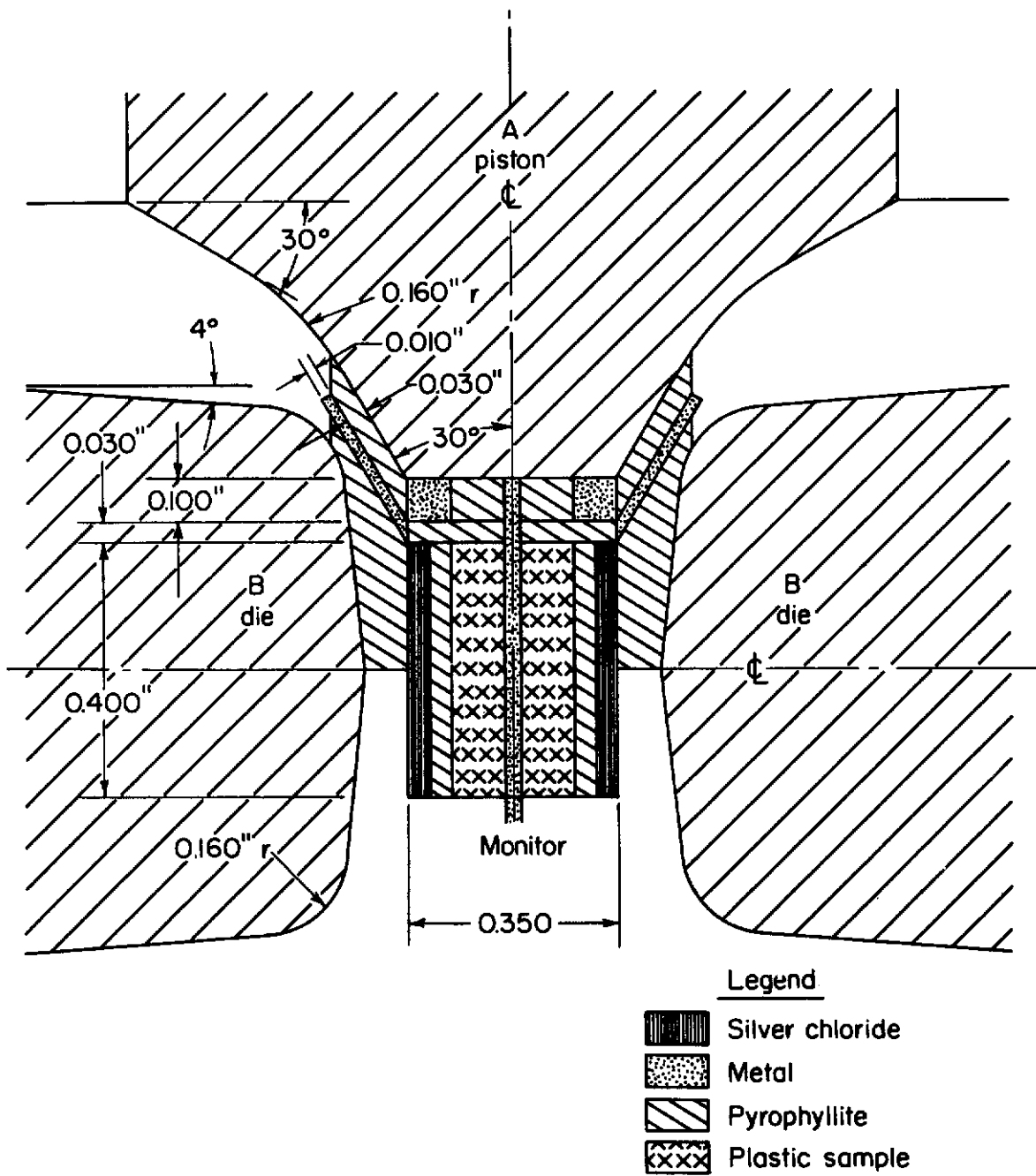

FIGURE 1. BELT ULTRAHIGH-PRESSURE APPARATUS



A-39885

FIGURE 2. ULTRAHIGH PRESSURE ASSEMBLY USED IN POLYMER COMPRESSION

loss of volatile components, but more likely due to slower cooling rates after molding, permitting a higher degree of crystallization than is found in the molding pellets. This effect was rather pronounced in the case of the high-density polyethylene. Initially, the density was determined to be 0.9581, but after molding the density was 0.9647.

The effect of compression on polymers appeared to vary with the material, maximum pressure, rate and time of loading and temperature. These factors were not comprehensively studied during the intermediate compression program, nor have these preliminary results been verified by confirmatory runs.

Reductions in density were observed for most of the short-period runs at moderate compressions. This was true for runs with low- and high-density polyethylene, and polypropylene. However, several runs were made in which reductions either were not observed or the density was increased by the compression conditions used. These runs were made either by slow compression, prolonged holding under pressure, or by heating under pressure. This behavior was observed for low-density polyethylene which was used for the greater part of the study directed toward an extension of techniques. It appears reasonable to expect somewhat similar behavior with the high-density polyethylene and possibly polypropylene.

Compressions with polystyrene and polymethylmethacrylate, on the other hand, showed increasing densities roughly correlatable with estimated compression pressures. Results for work to date appear to be in general agreement with work reported by several investigators^{1,2}. Larsen and Drickamer applied a shearing force to polymers under 50,000 atmospheres. Short-time loads were used in which degradation was observed for polyethylene, polymethylmethacrylate, and others. Polymers containing unsaturation (olefinic or aromatic), such as polyisoprene or polystyrene, were crosslinked by this treatment. The mechanism postulated was free-radical formation by bond rupture. In systems containing unsaturation, the free radicals apparently reacted readily to form crosslinked materials. Similar studies by Professor Roy were reported to give degradation with polyethylene and polyacrylonitrile, but to have no effect on polystyrene.

It is interesting to note that in this work with hydrostatic loading, density reductions, suggestive of degradation, occurred with moderate super-pressures up to 35,000 to 40,000 atmospheres, under fairly rapid loading and short holding periods. This conceivably could produce sufficient stress to cause bond rupture similar to that reported by Larsen and Roy. However, slower loading, longer compression periods, higher temperatures or pressures have in several cases shown a reversal of this trend.

It is suspected that the effect of the currently used hydrostatic compression would be considerably less drastic than the effect of high-pressure shearing of a polymer. Correlations of over-all experimental results to date with Larsen-Drickamer's results appear to confirm this. Since their studies indicate the degradation reaction, as determined by infrared methods, is virtually complete within a minute compared to the very small changes noted in the present work.

During preparation of equipment capable of attaining pressures of about 100,000 atmospheres, the effect of several compression parameters on density were studied for polyethylene and two types of polyamides. It was hoped that critical parameters could be further defined during this period to minimize the runs required to obtain a fairly valid appraisal of the maximum effect of 100,000-atmosphere compression. The results of work suggest that both loading rate and maximum compression modify the effect on a given polymer. However, in the range of parameters studied in the intermediate compression range, the most critical parameter still seems to be the polymer used.

Effect of Loading Rate on Polymer Density and Compression. Studies to evaluate the effect of this factor were conducted on polyethylene, and two types of polyamides.

Results of this study are shown in Figures 3 and 4. In general, results for polyethylene (Petrothene) and polyhexamethylenediamine sebacic acid (Nylon 610) show fairly well-defined patterns at least in the lower compression ranges. The polyethylene showed some irregularities above 35,000 atmospheres, but results qualitatively agree with the projected trend. Generally, results to date with it and Nylon 610 indicate that slow compression of a sample tends to produce increased density reduction. However, the tendency for the polyethylene patterns to converge might imply that density increases would be effected at sufficiently high compressions. The pattern is more random for the polyamide, and projection, at present, less meaningful. Where polyethylene and Nylon 610 appear to show higher relative densities as compression pressures are raised at constant time, the reverse is shown for polycaprolactam (Nylon 6). The more rapid loading rate appears to produce greater reductions in density. The data for studies with this polymer do not show the well-defined patterns of polyethylene and Nylon 610, but graphical interpretation of the data tends to support the observation.

Concurrently with the evaluation of the effect of loading rate on density, a brief study was made of the effect of loading rate on internal compressions. This work conducted on Nylon 610 compared the behavior of this system through the lower bismuth transition at three different loading rates. Results of this work, Figure 5, indicate that, at least for this system, slower loading rates are more

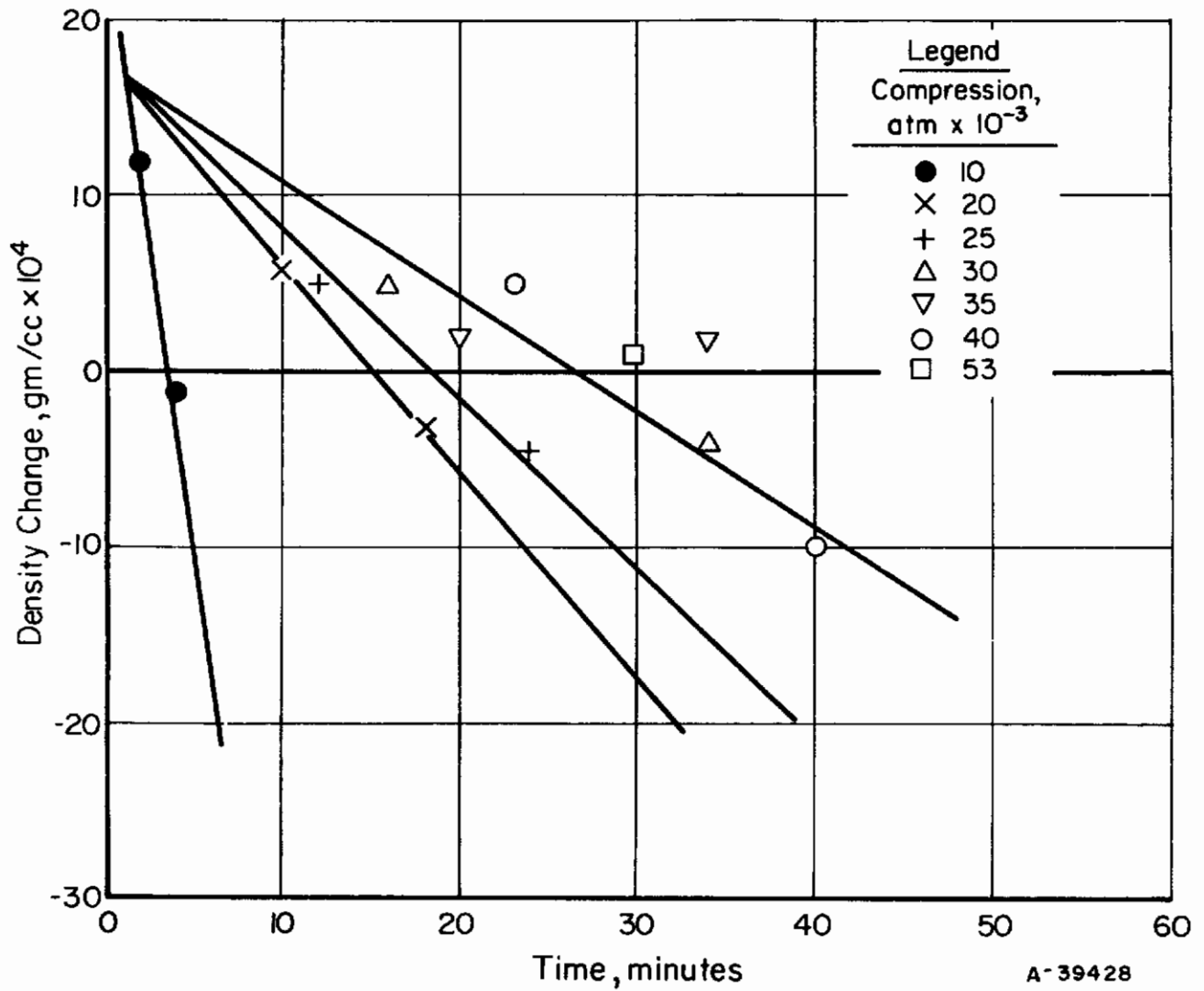
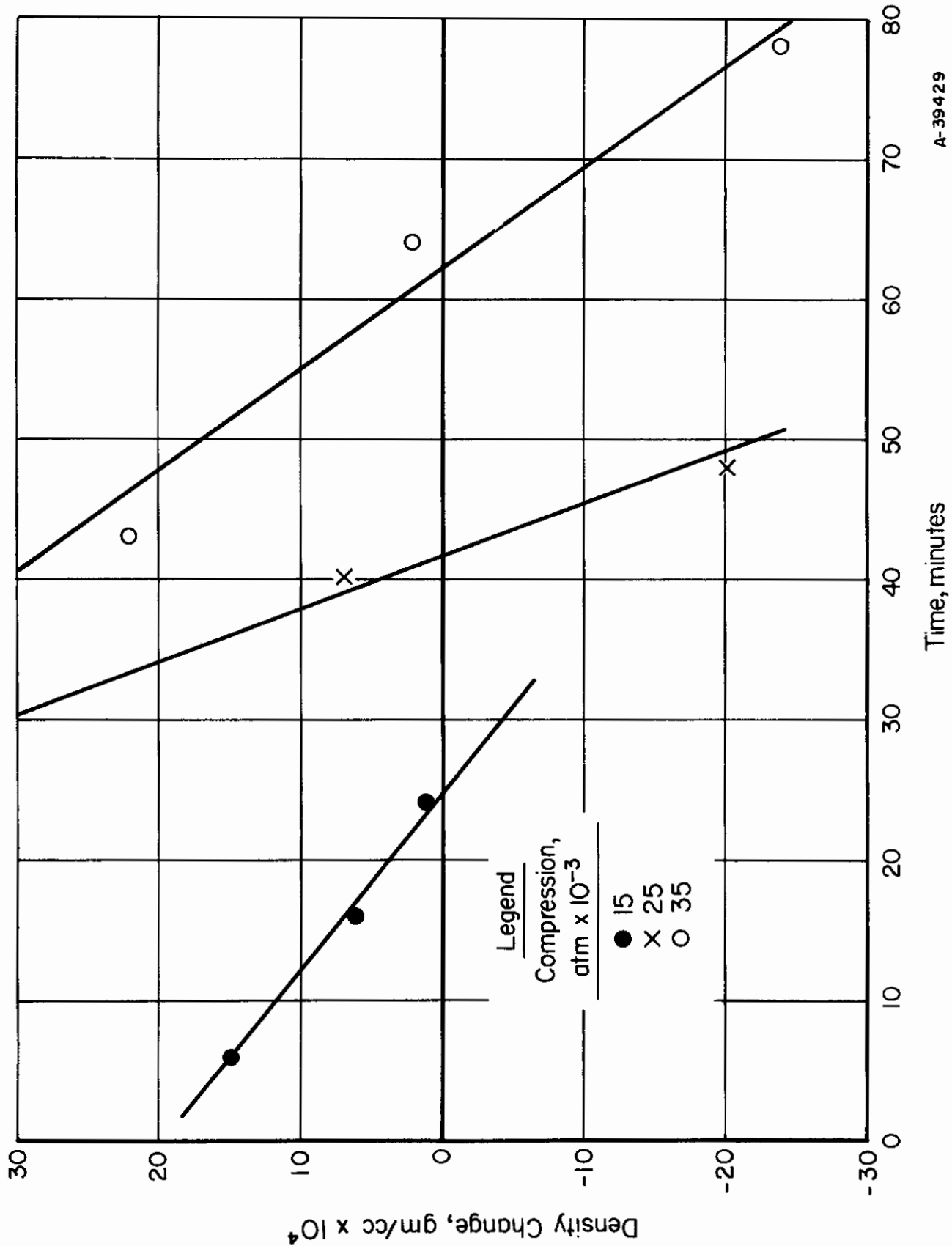
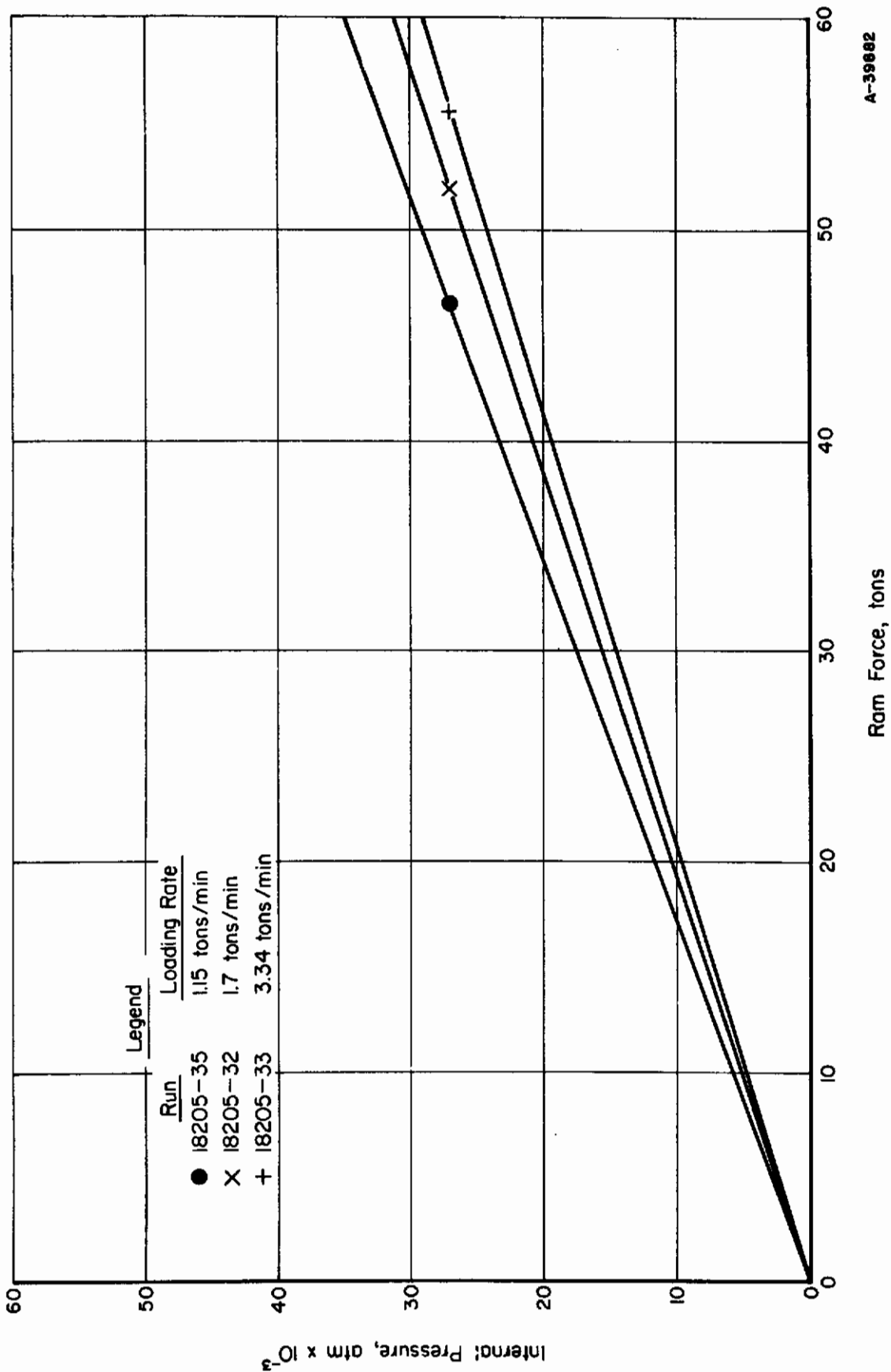

FIGURE 3. EFFECT OF TIME TO REACH MAXIMUM LOAD ON POLYETHYLENE DENSITY



A-39429

FIGURE 4. EFFECT OF TIME TO REACH MAXIMUM LOAD ON NYLON 610 DENSITY



A-39682

FIGURE 5. EFFECT OF LOADING RATE ON INTERNAL COMPRESSION IN NYLON 610

efficient. About 20 per cent more loading was required to produce the bismuth I-II transition at a loading rate of 3.3 tons per minute than at a loading rate of 1.1 tons per minute.

Correlation of Polymer Compression Studies. Although data from an adequate number of runs to determine the interrelationship of internal compression, loading rate, and density change with unquestionable validity for the polymers studied was not available, an attempt was made to correlate these effects to determine possible trends. Sufficient data were obtained for polyethylene and polyhexamethylenediamine sebacic acid (Nylon 610) to show slight similarity in pattern. Polycaprolactam (Nylon 6) appeared to behave differently. Preliminary work with these materials was conducted with a short holding time (two minutes) at maximum compression.

In the case of polyethylene, Figure 6, the effect of compression rate appears to diminish as compression pressures are raised. Rapid loading, however, appears to give the greatest increase in density. While data suggest the convergence of polymer densities under higher compressions to minimize the effect of compression rate, the projection suggests that only limited density increases may be obtained. A somewhat similar situation exists for Nylon 610. Fewer data, however, were available for correlation with this system and results are inconclusive at present.

Data available for Nylon 6 on the effect of time to reach maximum load were interpolated to provide a pattern for projecting Figure 7. This also indicates a tendency for the rate effect to diminish as the compression pressure is raised. This projection, however, indicates a marked tendency for a reduction of polymer density with increasing compression.

Projected correlation of data for polyethylene and Nylon 610 suggested that under present target compression, around 100,000 atmospheres, present compression rates and short holding times, very little net density change would be predicted. Data for Nylon 6, however, suggested that similar super-pressure treatment might effect significant density reductions.

Present conclusions based upon data available to date are: (1) that compression rate, compression used, temperature, and undoubtedly holding time, effect the net density change, (2) that different polymers may have a characteristic response to a given set of compression conditions.

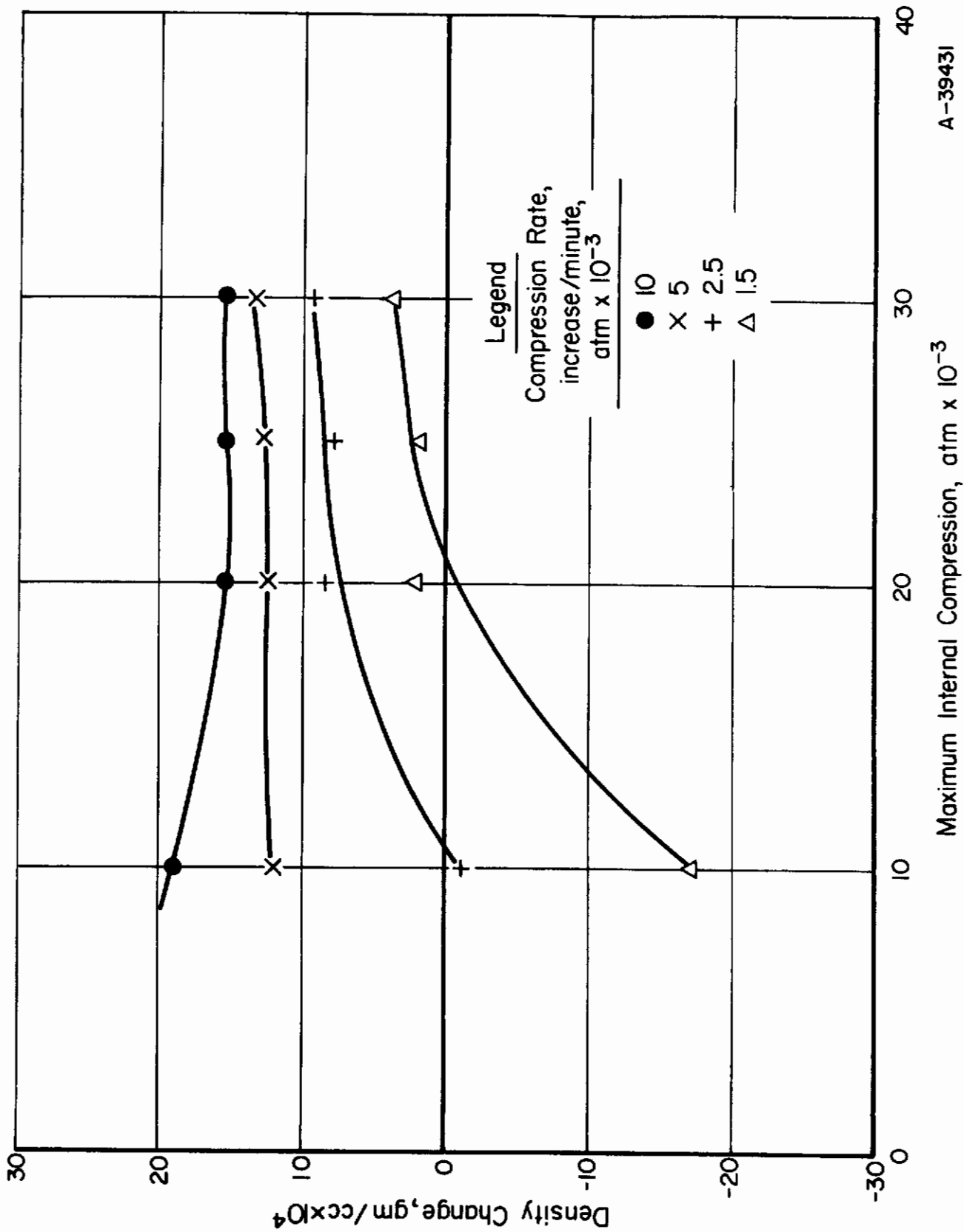

A-39431

Maximum Internal Compression, atm x 10⁻³

FIGURE 6. PROJECTED EFFECT OF INTERNAL COMPRESSION AND COMPRESSION RATE ON DENSITY OF POLYETHYLENE TO 30 KILOBARS

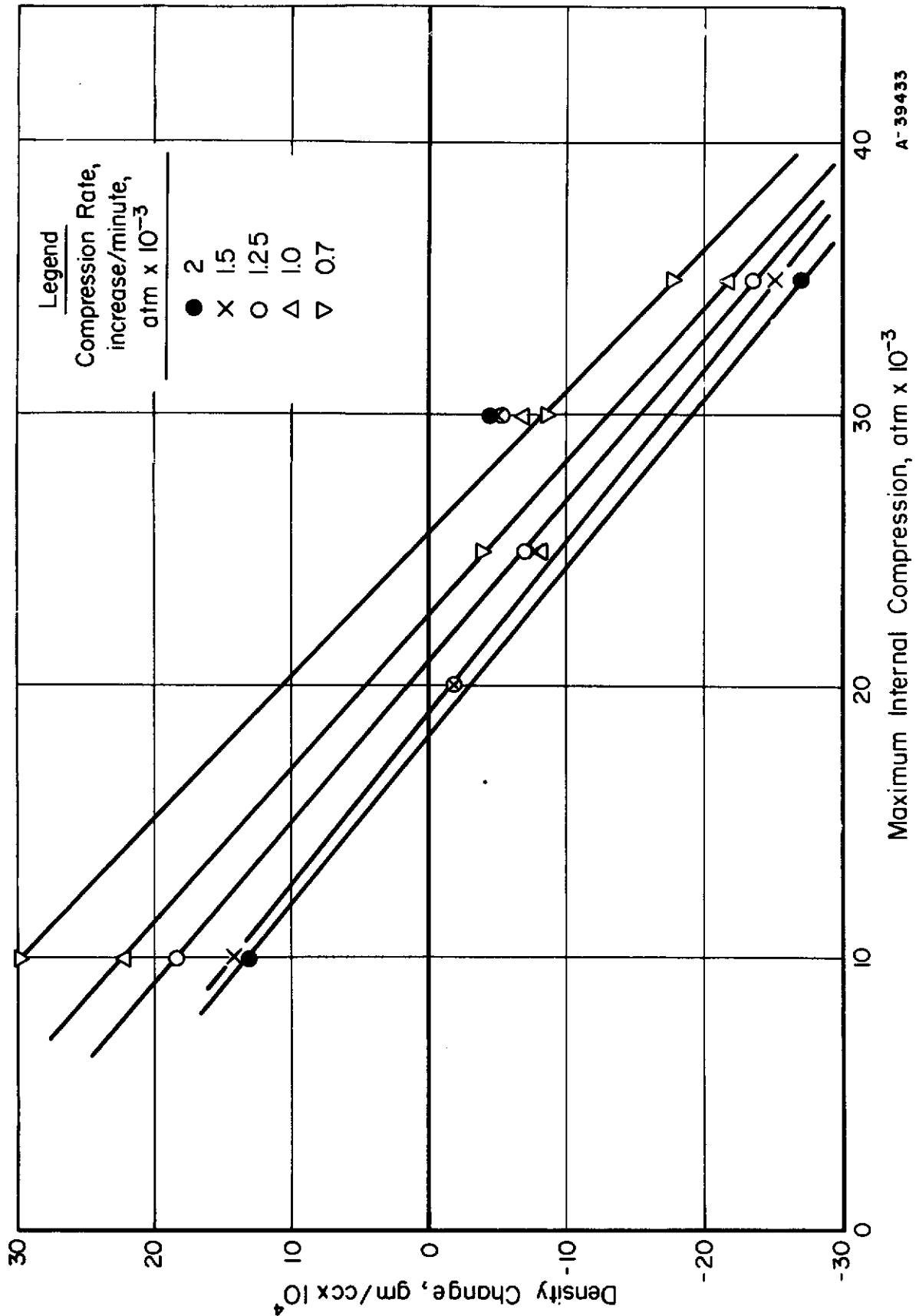

FIGURE 7. PROJECTED EFFECT OF INTERNAL COMPRESSION AND COMPRESSION RATE ON POLYMER DENSITY FOR NYLON 6 TO 35 KILOBARS

A-39433

Polymer Compression in Target Range

Effect of Compression Holding Time and Correlation With Intermediate Compression Data. Work was conducted with polyethylene to verify the projected trend and runs of longer duration made to determine the effect of compression holding time. The predicted effect of negligible density change for a 2-minute holding period was confirmed at 90,000 atmospheres with an observed net density change of (-0.0001 gm/c. c.) Figure 8. However, prolonged holding periods (30 and 60 minutes) at comparable compressions produced significant density increases (0.0010 -- 0.0026 gm/c. c.). Similarly density increases were observed for ethyl cellulose and polystyrene. Prolonged holding of polycaprolactam (Nylon 6) Figure 9, did produce net density increases greater than that predicted from the preliminary correlation, but increasing compressions continued to show reductions in density which were consistent with the established behavior at lower compressions. Similar prolonged compressions of polyformaldehyde (Delrin) will require evaluation in a salt column since the compressed material appears sensitive to the solvent column.

Effect on Polymer Properties. This factor has not been studied in detail. Density evaluations have been used for the most part to determine whether pressure induced changes have been effected. Early studies with high-density polyethylene and polypropylene revealed that electron microscopy techniques could be used to show differences in fine structure of control and compressed polymers. This, however, has not been employed in the more recent runs at the higher pressures. Some evidence has been obtained to indicate changes in the solubility characteristics of compressed polymers. Polyformaldehyde appears unaffected by the solvent density gradient columns before compression. Solvent absorption of the compressed polymer, however, appears so rapid that meaningful density data cannot be obtained with the solvent columns.

Effect of Generic Types on Polymer Compression. The fact that early work indicated varying behavior for different polymers under compression makes this correlation of extreme interest. The program was set up to study a broad spectrum of carbon backbone polymers modified either in the main chain or on a side chain. Materials scheduled in the study included several types of polyethylenes, and polyamides, polypropylene, polystyrene, polyacrylonitrile, polymethylmethacrylate, and ethyl cellulose. Results of work to date suggest differing behavior for individual polymers. Data presently are incomplete for all materials under target conditions, but polymer behavior under compression appears, to date, to be more influenced by the generic structure than by the types within a given generic structure.

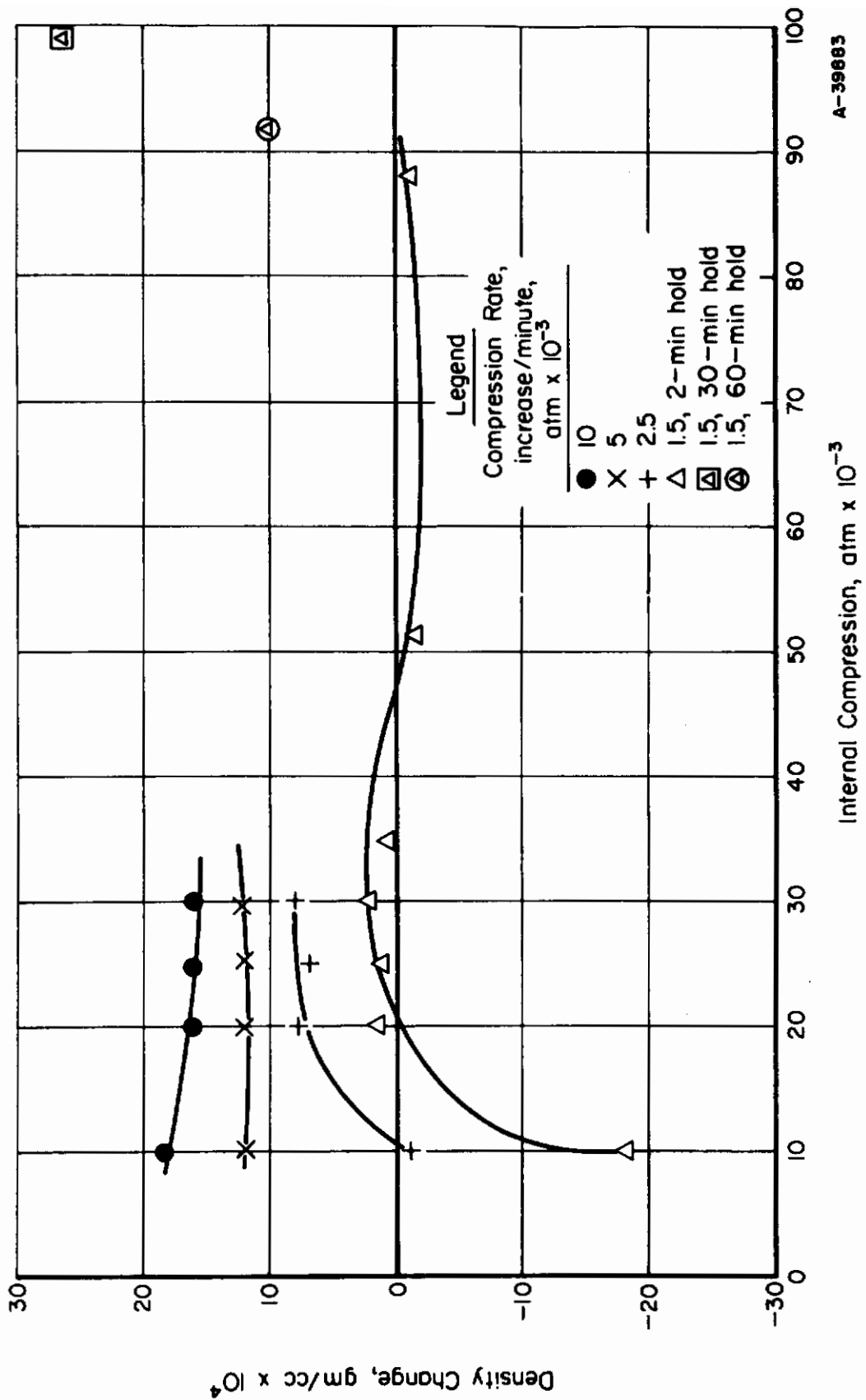

A-39883

FIGURE 8. EFFECT OF COMPRESSION HOLDING TIME ON POLYMER DENSITY - POLYETHYLENE

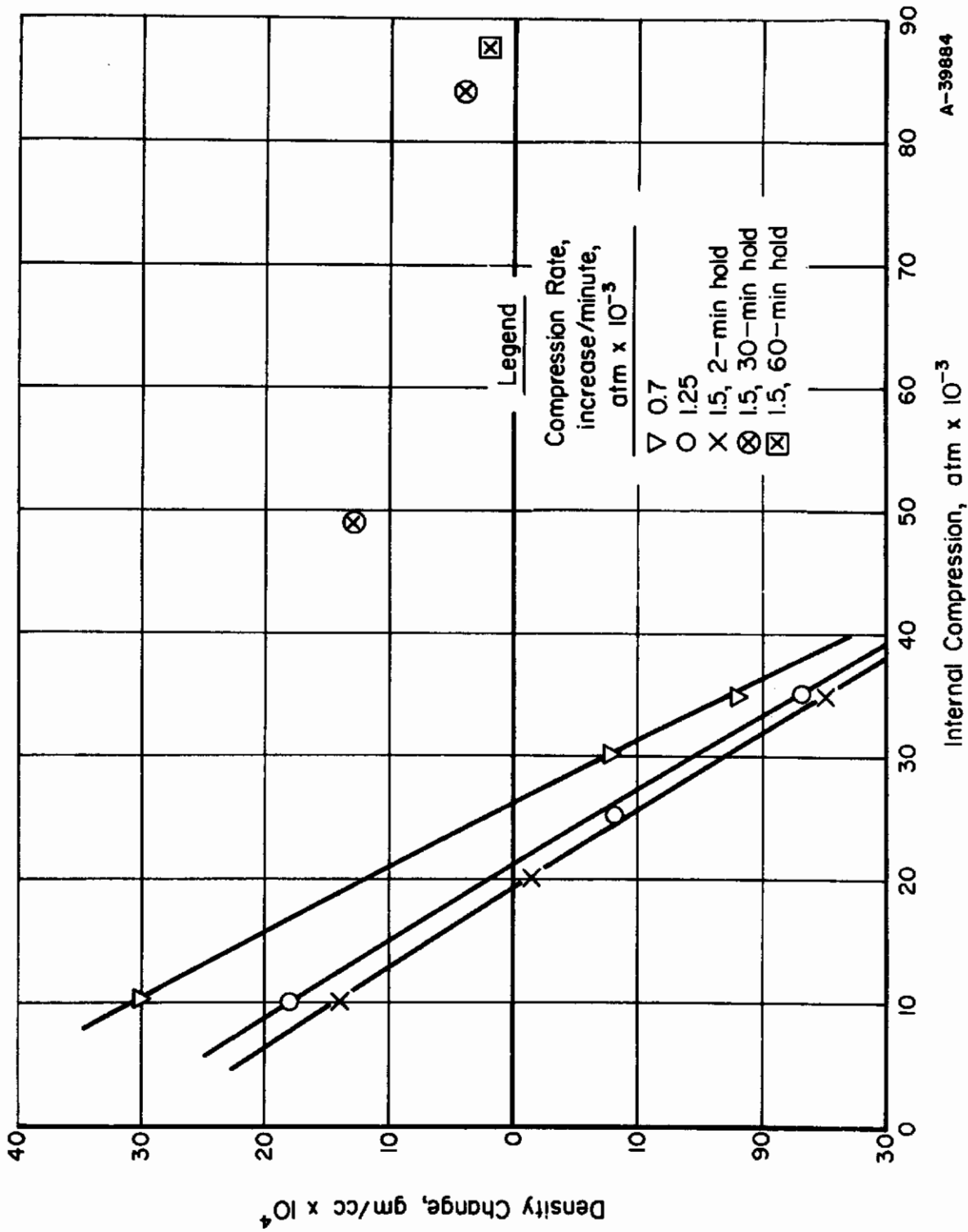

A-39884

FIGURE 9. EFFECT OF COMPRESSION HOLDING TIME ON POLYMER DENSITY-NYLON 6

Current Status of the Program

Compression techniques, instrumentation and critical parameters of this phase of study have been resolved and a number of polymers compressed in the target range. The most influential parameter appears to be the holding time. Data pertinent to this observation are summarized in Table 1. Results indicate that increased holding time is effective in increasing polymer density under compression. Prolonged runs, however, have not been made to determine whether equilibrium densities of compressed polymers ultimately reach the same value regardless of compression. Runs are contemplated under target conditions to explore this effect and with the remainder of the polymer series to further clarify the generic effect on polymer compression.

EFFECT OF PRESSURE ON SEMIORGANIC MATERIALS

Pressurization Experiments

The semiorganic materials were subjected to compressive forces which produced 60,000 to 75,000 atmospheres when silver chloride was used as a calibration medium. The semiorganic materials studied in this phase were synthesized as a part of the work.

Dimethyldicyanosilane

This compound is very sensitive to moisture and changes from a white crystalline solid to a colorless oil in 1 - 2 min. when exposed to the atmosphere. Consequently, it was loaded into the platinum capsule under dry argon.

When this material is pressurized (at 60,000 atm), reaction as indicated by changes in its infrared spectrum does not occur until the temperature is raised to 100°C. Heating the compound in a sealed Pyrex tube at 100°C for 3 hrs. leaves it unchanged, but combined pressure and heat cause the dimethyldicyanosilane to change to a brownish-black product, which is not moisture sensitive and is no longer soluble in common organic solvents. The infrared spectrum of the product indicates the formation of some C=N bonds, although not all of the C≡N character has disappeared. Analysis for C, H, and N shows a loss of all three components which is equivalent to the loss of 3 HCN from 4 molecules of $(\text{CH}_2)_2\text{Si}(\text{CN})_2$. However, the result is complicated by the appearance of absorption bands in the spectrum, which may come from water introduced from the pyrophyllite gasket

TABLE 1. EFFECT OF EXTREME COMPRESSION IN THE DENSITY OF ORGANIC POLYMERS

Run ⁽¹⁾	Material	Maximum Press Load, tons	Estimated Maximum Compression, atmospheres x 10 ³	Holding Time, minutes	Density Change, grams/cc
64	Petrothene	140	90	2	-0.0001
65	Petrothene	150	92	30	+0.0010
66	Petrothene	150	98	60	+0.0020
68	Nylon 6	50	30	Blow-out	-0.0007
67	Nylon 6	80	49	30	+0.0013
68	Nylon 6	145	83	30	+0.0004
69	Nylon 6	150	86	60	+0.0002
71	Ethocel	125	72	30	+0.0040
70	Ethocel	150	84	60	+0.0045

material. Further investigation with baked-out pyrophyllite will be made. Increasing the pressure to 75,000 atm at 100°C increases the amount of C=N that appears.

Figure 10 shows the conditions of temperature and pressure under which reaction has been observed. It is expected that subsequent experiments will define a boundary between the regions of reactivity and inactivity. Efforts will also be made to resolve the nature of the C=N bonding. It could be the result of either partial condensation to a triazine structure, or linking of adjacent molecules in a linear structure.

Aluminum-Oxygen-Silicon Polymers

The pressure experiments on the four polymeric materials having Al-O-Si bonds were all performed at 60,000 atm. The temperature ranged from 100 to 400°C and the time of pressurization varied from 2 to 8 hours.

Dimethylsiloxy-Aluminum-Acetylacetonate Polymer. The combined heat and pressure had no permanent effect on this material at 100 or 200°C. At 300°C no change was observed after 2 hours at pressure. However, when the time was extended to 8 hours, some of the silicon-carbon bonds were broken, as indicated by the infrared spectrum, with consequent reduction in carbon and hydrogen content. A comparison experiment, run at 300°C and atmospheric pressure, resulted in breaking of the acetylacetonate ring in addition to silicon-carbon bonds and showed greater loss of carbon and hydrogen. At 400°C pyrolysis occurred.

Diethylsiloxy-Aluminum-Acetylacetonate Polymer. This material was unchanged under pressure at 100°C and at 200°C in three-hour experiments. The silicon-carbon bonds were affected at 300°C and, as the time of exposure at this temperature was increased to 8 hours, differences between the pressurized and unpressurized samples were observed. The acetylacetonate ring was broken in the case of the unpressurized sample, but the over-all loss of carbon and hydrogen was less than that for the pressurized sample. This material also underwent pyrolysis at 400°C.

Diethylsiloxy-Aluminum-Isopropoxide Polymer. This material was unaffected by the combined heat and pressure at 100°C and 200°C. At 300°C, the breaking of the silicon-carbon bonds occurred more rapidly than it did for the polymers in which the acetylacetonate was bonded to the aluminum.

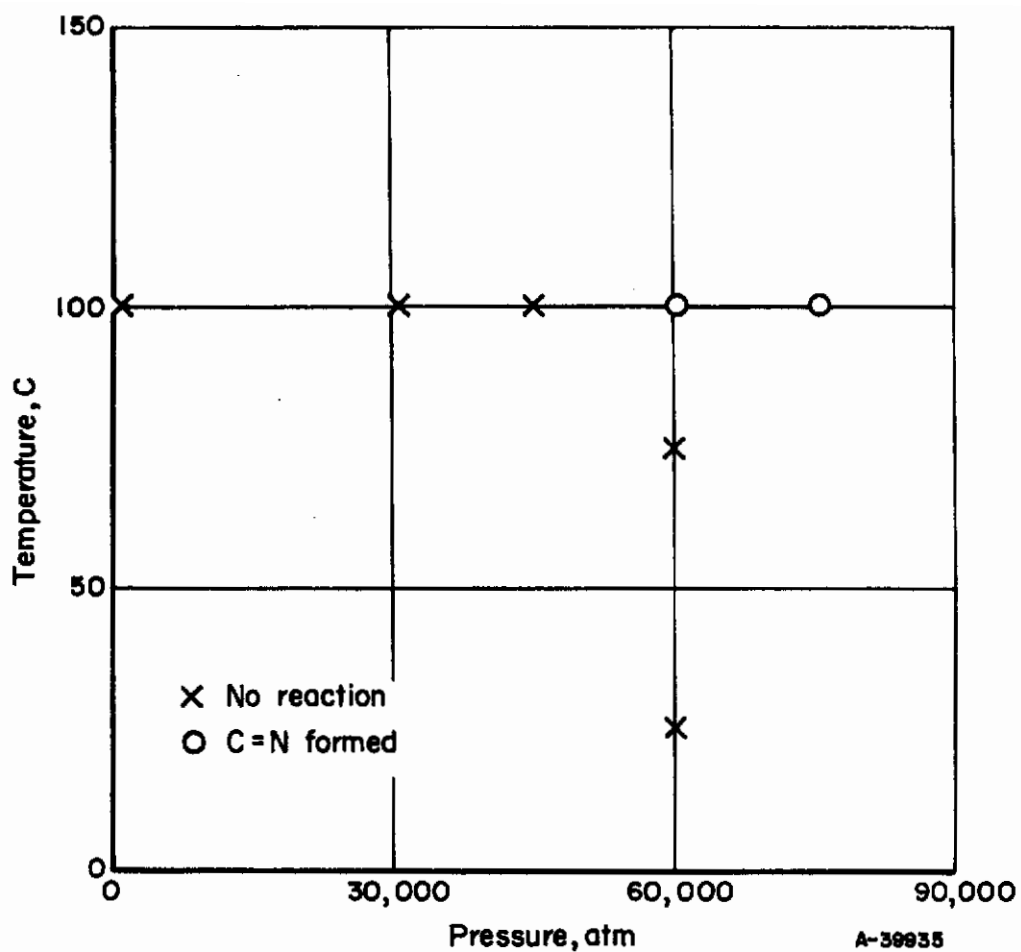

FIGURE 10. EFFECT OF PRESSURE AND TEMPERATURE ON C=N FORMATION IN $(\text{CH}_3)_2\text{Si}(\text{CN})_2$

The unpressurized sample showed greater effect on the group bonded to aluminum than on that bonded to silicon. Pyrolysis occurred at 400°C in this case also.

Diphenylsiloxo-Aluminum-Isopropoxide Polymer. No change occurred in this material when pressurized at 100 or 200°C, but when the temperature was raised to 300°C, pyrolysis took place rapidly.

Ethylidicyanophosphine

This compound is extremely sensitive to atmospheric moisture and had to be loaded into the pressure capsules under the blanket of dry argon. Extensive decomposition of this compound began at 50°C under 60,000 atm pressure. Pressurization at room temperature resulted in the disappearance of $C\equiv N$ bonding, as indicated by infrared spectra. However, allowing the compound to stand uncovered in air at ambient temperature brought about these same structural changes. In future experiments, it may be possible to separate the effects of moisture and oxygen from those of pressure on this compound, to establish whether or not there is any real effect of pressure.

Tris(Diphenylsiloxo) Diarsenic (III)

This cyclic material having As-O-Si bonding, $As [OSi(C_6H_5)_2O]_3As$, was unaffected by pressures of 60,000 atm at temperatures as high as 400°C for periods of several hours. When pressurization was conducted at 500°C for three hours, definite structural changes occurred. As indicated by the infrared spectra, these appear to be breaking of the silicon-carbon bonds. Unpressurized samples held at 500°C for a 3-hour period did not degrade quite as extensively. This case was the first encountered in this study in which high pressure appears to have increased the rate of decomposition of a material.

Diphenylsiloxo-Arsenoxane Polymer

The linear polymer of the As-O-Si series, which has been formulated as $AsO(OH)_2[OSi(C_6H_5)_2OAsO(OH)]_nOH$ started decomposing when subjected to 60,000 atm at 100°C for 3 hours. Pyrolysis occurred readily when the material was pressurized at 200°C.

Phosphonitrilic Chlorides

The phosphonitrilic chloride trimer, $(\text{PNCl}_2)_3$, was subjected to 60,000 atm pressure and a temperature of 240°C was maintained for 30 min. The sample changed in color from white to tan and the melting point was lowered from 113-114°C to 106-107°C. However, identical results were obtained by simply heating a sample of the trimer at 240°C for 30 min. The infrared spectra of the two samples were identical also. In another experiment the temperature was maintained at 300°C while the pressure was applied. A high polymer which could be heated to 500°C without melting was obtained. However, in this case also, the same result was obtained by application of heat alone. Thermal energy appears to be sufficient to break the bonds in the ring structure of the PNCl_2 trimer, and pressure does not contribute any permanent effect.

The linear polymer fraction of phosphonitrilic chloride, which had been extracted from a mixture of the cyclic and linear polymers, was subjected to 60,000 atm also. After 3 hours at 200°C the thermal stability of the material was altered. The starting material did not melt, but slowly charred as the temperature was raised to 300°C. However, the pressurized product melted in the range 270-300°C. This result points to the formation of lower molecular weight polymers than the starting material, but no suitable solvent for molecular weight determination could be found. Infrared analyses were inconclusive also, as there was no significant absorption in the infrared region for either the treated or untreated specimens.

Phosphinoborine Polymers

Diphenylphosphinoborine trimer, $[(\text{C}_6\text{H}_5)_2\text{PBH}_2]_3$, was pressurized at 60,000 atm at temperatures up to 400°C, where pyrolysis occurred. Only slight structural changes were observed below the pyrolysis temperature, and these could be brought about by heat alone.

A solid which separated during the preparation of the diphenylphosphinoborine trimer appears to have some unusual properties, although it has not been characterized completely. This material melted at 188-192°C and remained liquid to 360°C, where it volatilized slowly. Analysis showed lower carbon and hydrogen content than the trimer, and molecular weight determinations were inconclusive. Under pressure it did not pyrolyze until the temperature reached 500°C, although an unpressurized sample held at 400°C for 8 hours in a sealed Pyrex tube degraded extensively. Further study of this material seems to be warranted.

EFFECT OF PRESSURE ON INORGANIC MATERIALS

Effect of Pressure on Heteropolynuclear Acids and Salts

Experimental high-pressure high-temperature work was done on two heteropolynuclear acids and two heteropolynuclear salts. The former pair are silicotungstic acid ($H_4SiW_{12}O_{40} \cdot nH_2O$) and phosphotungstic acid ($H_3PW_{12}O_{40} \cdot nH_2O$), and the latter pair are hydrated ammonium phospho-vanado-tungstate [$(NH_4)_{3+x}PV_xW_{12-x}O_{40} \cdot nH_2O$ in which x approximates 1, crystallized from solution at high pH with initial solution weight ratios of P:V:W = 1:1:16] and hydrated ammonium arseno-vanado-tungstate [$(NH_4)_{3+x}AsV_xW_{12-x}O_{40} \cdot nH_2O$ in which x approximates 2, crystallized from solution at high pH with initial solution weight ratios of As:V:W = 1:3:16].* The experimental runs and the results obtained are summarized in a set of temperature-pressure diagrams (Figures 11, 12, 13, 14). The boundary lines on the diagrams which delineate the stability fields for the various structural modifications are, of course, solely schematic, and many more experimental data are required to determine their positions accurately. At this juncture, however, they are useful as guides for further experimental work. The products corresponding to the points on the diagrams have been evaluated by X-ray powder diffraction methods and, for some of the silicotungstic acid products, by optical crystallographic methods as well. X-ray powder diffraction data have been obtained for the various structural modifications found in experimental products. As a control on the validity of any conclusions regarding pressure-induced transformations, the effects of temperature at 1 atmosphere on each of the materials under study has been determined.

Experimental High-Pressure Products From Silicotungstic Acid

Silicotungstic acid has been studied in greater detail than the other materials, and, accordingly, descriptive notes on some of the products are recorded.

The starting material (Fisher Reagent A-289) is a colorless coarsely crystalline powder composed of single-crystal grains up to 2 mm in size. It is uniaxial negative with $\omega = 1.724$, $\epsilon = 1.692$, and a moderately high birefringence. It is probably a higher hydrate than the cubic material with 8 H_2O listed in the ASTM index of X-ray powder diffraction patterns (data of Scroggie and Clark³). When the Fisher compound is heated in air at 1 atmosphere it transforms above about 125°C to a colorless isotropic material with an index of refraction of 1.915 ± 0.005 and a powder pattern corresponding to a body-centered cubic cell

*Synthesized by J. J. Bulloff and P. F. Kurz at Battelle Memorial Institute.

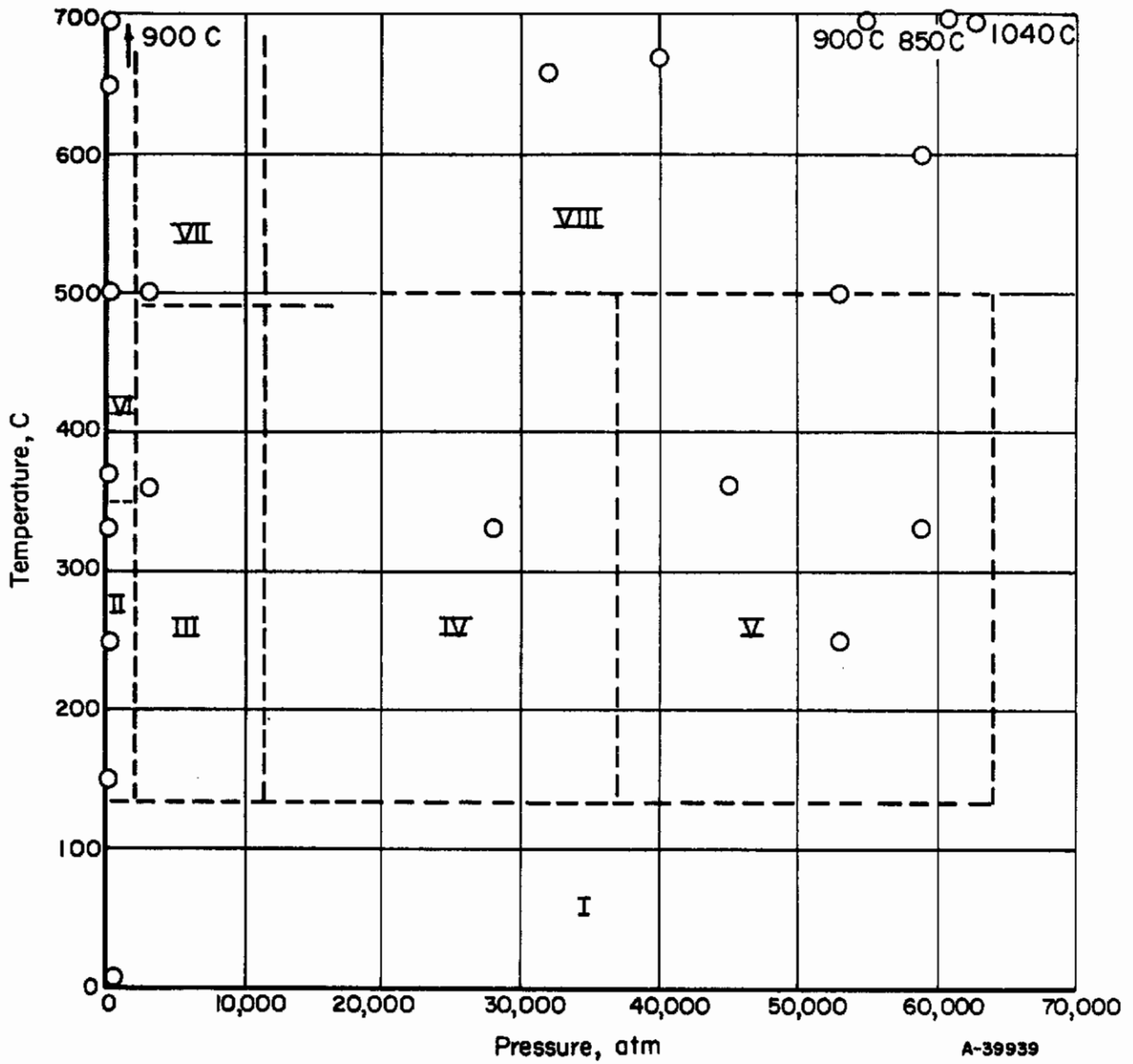

FIGURE 11. PILOT OF EXPERIMENTAL RUNS ON SILICOTUNGSTIC ACID

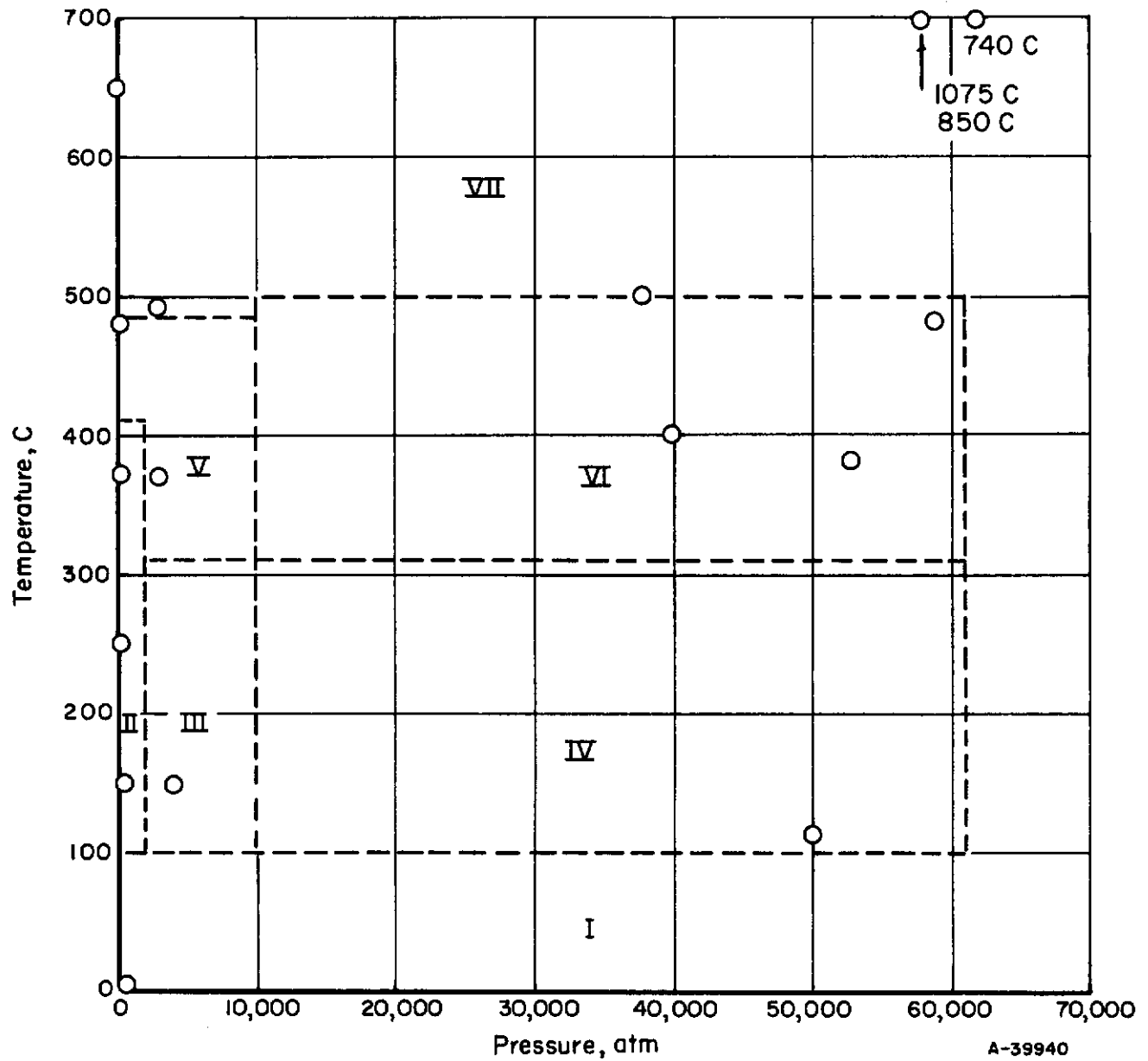

FIGURE 12. PLOT OF EXPERIMENTAL RUNS ON PHOSPHOTUNGSTIC ACID

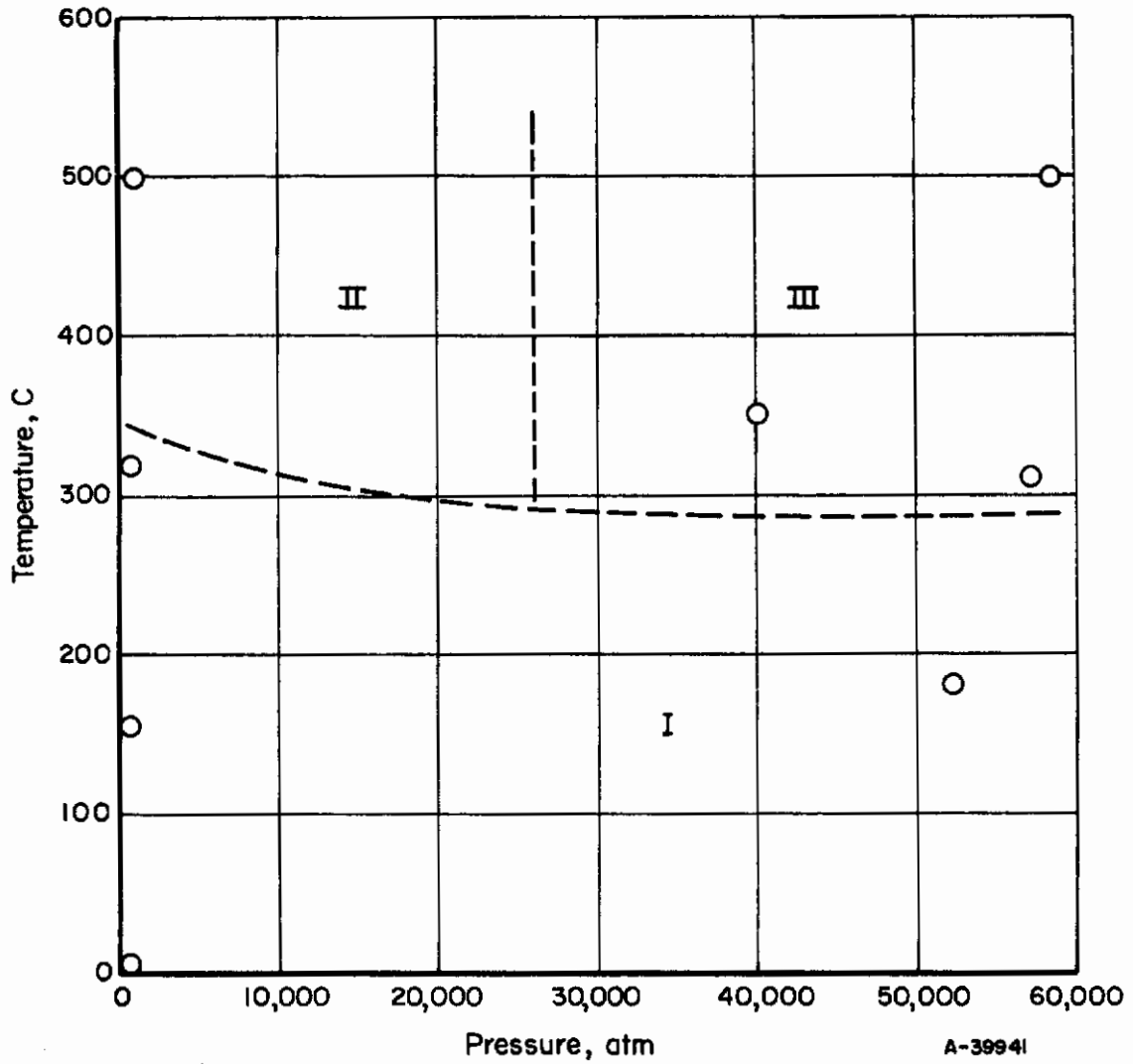

FIGURE 13. PLOT OF EXPERIMENTAL RUNS ON HYDRATED AMMONIUM-ARSENO-VANADO-TUNGSTATE

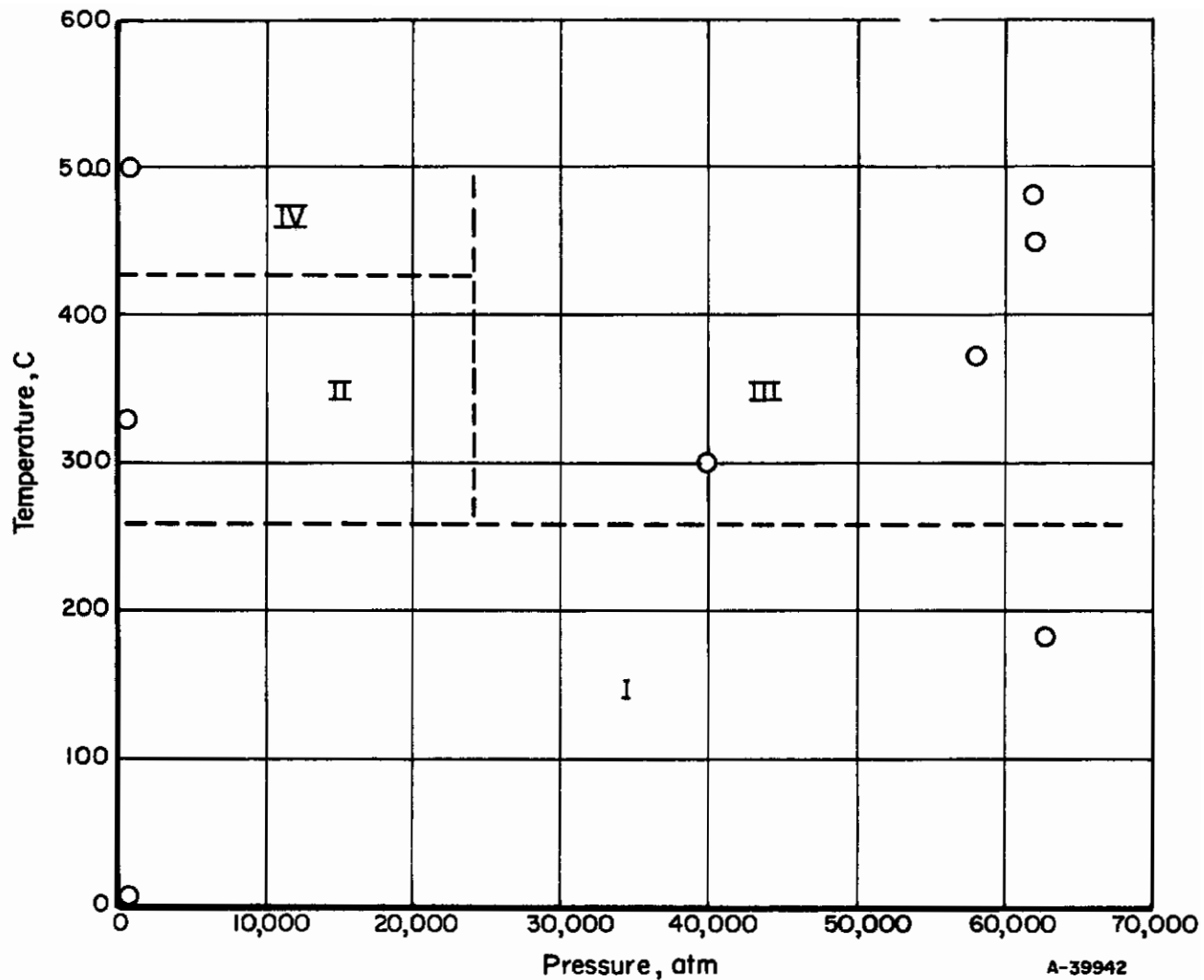

FIGURE 14. PLOT OF EXPERIMENTAL RUNS ON HYDRATED AMMONIUM-PHOSPHO-VANADO-TUNGSTATE

with $a_0 = 12.16 \text{ \AA}$, which is equivalent to that given on the ASTM card. Two spacings ($d = 8.6 \text{ \AA}$ and $d = 6.08 \text{ \AA}$ for hkl of 110 and 200, respectively) were not obtained on a cylindrical film by Scroggie and Clark but were verified by them on a flat film. Because of these experimental differences the relative intensities of these two lines with respect to the rest of the pattern were not recorded, and, probably for this reason, these lines were not listed on the ASTM card. In the present study, both of these spacings were obtained with the entire pattern on a cylindrical film, using a 114.6-mm camera, and the 8.6- \AA spacing was found to be the strongest (100) line of the pattern; the 6.08- \AA spacing has a relative intensity of about 35.

When the Fisher reagent is heated to 500°C at 2600 atmospheres, a black powder with a unique pattern and optical properties is obtained.

The powder is composed of square to rectangular tablets with an average side length of about 10 microns; a few are as long as 35 microns. The tablets have an intense pleochroism with extraordinarily strong absorption when observed in transmitted light in the direction of the optic axis which is normal to the broad face of the tablets. The pleochroic formula is $\omega =$ deep green-blue to practically opaque even in strongly convergent light depending on thickness, and $\epsilon =$ pale yellow to colorless. Because of the strong absorption it is not possible to measure the index of refraction, but; is probably greater than 2.00. The tablets show extinction between crossed nicol prisms parallel to their sides; this suggests tetragonal symmetry. The product might be anhydrous ($\text{SiO}_2 \cdot 12\text{WO}_3$), possibly a defect structure, and it may have useful properties as a pigmenting and opacifying agent in refractory paint. It should impart a jet black appearance to paints because the tablets tend to lie on their broad faces whose poles are the direction of greatest light absorption.

The product obtained at 28,000 atmospheres and 350°C (Figure 2, Field IV) is a white fine-grained material which is barely resolvable with the light microscope. It has a high birefringence and indices of refraction greater than 2.00. By contrast, Field V is occupied by a fine-grained canary-yellow material with an average crystallite size of 1 to 2 microns and individual crystals as large as 5 microns. The crystals are yellow square to rectangular tablets, probably tetragonal in symmetry, and with the optic axis apparently normal to the broad face of the tablets. The extinction positions are parallel to the diagonals of the tablets, and the indices of refraction are $\omega > 2.10$ and $\epsilon \approx 2.00$ with high birefringence.

The product obtained at 53,000 atmospheres and 500°C was zoned, with a yellow core and a pale, greenish peripheral zone. The yellow core material was shown to be equivalent to Field V by both optical measurements and by X-ray

powder diffraction. It is, however, more coarsely crystalline, and many tablets have side lengths up to 10 microns. The greenish peripheral zone gives the diffraction pattern of Field VIII. The peripheral zone is composed of relatively large square and rectangular tablets commonly with side lengths as great as 30 microns and, rarely, as great as 90 microns. The tablets are pale yellow to colorless in transmitted light and have extinction positions parallel to the sides, which suggests tetragonal symmetry. Most of the crystals have a very high birefringence when viewed normal to their broad faces; this suggests that the optic axis is probably in the plane of the tablets. Many crystals of this green peripheral zone are internally zoned with a central, irregularly shaped, deep-blue core (Field VII material) which is in apparent optical continuity with the pale yellow to colorless peripheral zone.

The product obtained at 59,000 atmospheres and 600°C is a pale yellowish-green well crystallized powder composed of crystals with rectilinear outlines, many of which approach the equidimensionality of cubes. Eighty-five to 90 per cent of the crystals are homogeneous and pale yellow to colorless in transmitted light. Their mean index of refraction is greater than 2.10. The remaining 10 to 15 per cent are zoned with deep blue to almost opaque irregular cores (Field VII material) and pale yellow to colorless peripheral zones. The cores of the zoned crystals are typically volumetrically dominant and are in optical continuity with peripheral zones, and the direction with the deep blue color appears to coincide with the direction of an optic axis. The crystals are probably tetragonal and uniaxial negative. They appear to be equivalent to those which constitute the greenish peripheral zone of the zoned product, described in the preceding paragraph.

General Conclusions

The experimental results to date may be summarized as follows:

- (1) Silicotungstic acid transforms above 475°C to a phase which is stable at pressures between 20,000 atmospheres and 60,000 atmospheres and at temperatures to at least 1100°C. This phase may be obtained by pressurizing either reagent-grade hydrated silicotungstic acid as received or silicotungstic acid which was preheated in air at 1 atmosphere at 650°C. The phases obtained by preheating reagent-grade silicotungstic acid in air at 1 atmosphere between 300 and 700°C are not equivalent to the stable phase obtained by pressurization above 450°C and 20,000 atmospheres.

- (2) Phosphotungstic acid transforms above 500°C to a phase which is stable at pressures between 1 atmosphere and 60,000 atmospheres to at least 1075°C. This phase is obtained by pressurizing either reagent-grade hydrated phosphotungstic acid as received or phosphotungstic acid which was preheated in air at 1 atmosphere at 650°C. It may also be obtained by heating reagent-grade phosphotungstic acid to 650°C in air at 1 atmosphere. This phase is not equivalent to other phases obtained from both preheated and hydrated phosphotungstic acid at temperatures below 500°C and at pressures up to 60,000 atmospheres.
- (3) Both silicotungstic acid and phosphotungstic acid appear to have at least three pressure-dependent hydrated(?) forms which occupy regions on a P-T diagram between 200 and 500°C and between 5,000 and 75,000 atmospheres.
- (4) It is interesting to note that although silicotungstic acid preheated at 650°C will transform at 60,000 atmospheres and between 850 and 1000°C to the same phase as is obtained by application of the same P-T conditions to reagent grade silicotungstic acid, both silicotungstic and phosphotungstic acid preheated to 370°C at 1 atmosphere and then subjected to 75,000 atmospheres at 370°C remain unchanged. The reason for this anomalous condition is unknown.
- (5) The heteropolynuclear salts also appear to have pressure-dependent (ammonia-deficient ?) modifications (Figures 12 and 13).

Effect of Pressure on Polynuclear Sulfides

In preliminary experimentation prior to intensive study of polynuclear sulfides, a group of sulfides of diverse structure including As_2S_3 , Bi_2S_3 , Ag_3SbS_3 , PbCuSbS_3 , FeS , and HgS were subjected to pressures between 60,000 and 75,000 atmospheres at temperatures between 250 and 1000°C under anhydrous conditions. Finely ground natural crystalline compounds were used as reactants. Experimental details are assembled in Table 5. No pressure-dependent changes were found in any of these materials, but one problem has arisen, namely, that Sb_2S_3 reacted with and largely digested the platinum tube at high pressures and at temperatures above 550°C. The reaction products are a crystalline multiphase

TABLE 2. HIGH PRESSURE EXPERIMENTS ON SULFIDES

Starting Material	Temperature, °C	Pressure, (10 ³ atms)	Time, hr
STIBNITE (Sb ₂ S ₃)	200	75	42
Ditto	300	60	45
"	490	75	25
"	550	60	25
Troilite (FeS)			
Ditto	200	50	24
"	500	65	24
	1000	60	24
Pyrhotite (Fe _{1-x} S)	700	50	20
Pyrargyrite (Ag ₃ SbS ₃)	400	60	14
Bourmonite (PbCuSbS ₃)	200	75	15
Ditto	400	75	20
Bismuthinite (Bi ₂ S ₃)	400	60	16
Orpiment (As ₂ S ₃)	240	60	15
Cinnabar (HgS)	400	60	15

mixture, the components of which may be revolved microscopically in incident light in polished section. The phases have thus far defied identification by either optical or X-ray powder methods. Reactions between sulfides and metallic platinum at relatively low pressures (<3000 atmospheres) and temperatures between 300 and 800°C have long been known and have been ascribed to the formation of stable sulfides of platinum. Recent hydrothermal investigations⁽⁴⁾ on sulfide systems between 200 and 800°C and up to 6000 atmospheres have shown that gold may be employed successfully as an inert sample container. Accordingly, experiments are now under way in which gold is being used as both sample container and heater tube in the Belt apparatus. In addition, high pressure experiments on sulfides in which mineralizers will be employed are being planned.

Effects of Pressure on Phosphates

An exploratory study of the effects of combined pressure and temperature on phosphates of diverse atomic structure has been started. In preliminary experimentation finely ground natural crystalline apatite [$\text{Ca}_5(\text{PO}_4)_3(\text{OH},\text{F})$] was subjected anhydrously to 60,000 atmospheres at 1100°C for 15 hours. No change was detected. Other experiments are under way with this and other phosphates using hydrothermal as well as anhydrous conditions and finely divided chemical components to prepare the reactant.

Effects of Pressure on Germanium Dioxide And Zirconium Orthosilicate

In the early stages of this experimental program a number of exploratory high-pressure high-temperature runs were made on stable substances of simple chemistry, fixed stoichiometry, and known structures. Although this work was only of a cursory nature, some of the results and observations are considered to be worthy of record.

The dimorphism of GeO_2 has long been known⁽⁵⁾. The low-temperature high-density "insoluble" modification is tetragonal and has the rutile structure whereas the high-temperature low-density "soluble" form is hexagonal and has the low-quartz structure. The enantiotropic inversion point is $1033^\circ\text{C} \pm 10^\circ\text{C}$. The soluble form is obtained by hydrolysis of germanium tetrahalides and the insoluble form may be prepared from the "soluble" form by hydrothermal methods at a few hundred degrees C. In view of the structural equivalence of the soluble form with low quartz, the possibility of producing a coesite⁽⁶⁾ analogue from this form of GeO_2 was considered, and several exploratory runs were made at 1000°C and

between 40,000 and 50,000 atmospheres. The resultant products were composed of well-developed tetragonal prisms of the "insoluble" form of GeO_2 as large as 80 microns in length and 30 microns in width. The measured indices of refraction are: $\epsilon = 2.04 \pm 0.01$ and $\omega = 1.96 \pm 0.005$. These data are believed to be more accurate than those given by Mason (7) who "estimated" the indices as $\epsilon = 2.05-2.10$, $\omega = 1.99$ at time when calibrated sets of stable high-refractive index liquids were not readily available. The X-ray powder diffraction pattern of these products is equivalent to that given for insoluble GeO_2 prepared hydrothermally at the National Bureau of Standards (8). Shortly after this experimental work was started, it was found that a paper (9) by Dachille, Shafer, and Roy entitled "High Pressure Studies in the System $\text{GeO}_2\text{-SiO}_2$ " was in press. As a result, further work on GeO_2 was stopped pending the publication of this paper.

Zircon (ZrSiO_4) is a refractory substance with a melting point of 2550°C and a density of 4.7 which is commonly used as a molding sand in foundries. It is a tetragonal nesosilicate built of isolated SiO_4 tetrahedral and zirconium in eight-fold coordination with oxygen. The effect of pressure on such a material is of interest. Two runs were made with natural zircon molding sand* composed of closely sized single-crystal prismatic grains with c-axes between 150 and 250 microns in length. The first run was made using ammonium chloride as a mineralizer at 900°C and 60,000 atmospheres for 14 hours. The product was fine-grained zircon which was evidently the comminuted and recrystallized equivalent of the original zircon in view of the small but measurable changes in indices of refraction from $\epsilon = 1.988$ and $\omega = 1.927$ to $\epsilon = 1.972$ and $\omega = 1.920$ (Na light, all indices ± 0.002). The second run was made with ammonium fluoride as a catalyst at 1300°C and 60,000 atmospheres for 15 hours. The fine-grained product was equivalent to the first run. Both products give the X-ray diffraction pattern of zircon. Two additional runs were made using a charge of zirconium nitrate and silicic acid which were mixed in the proportions required for zircon and a small amount of excess silica. These charges were pressurized at 60,000 atmospheres at 600 and 800°C for 19 and 16 hours, respectively. The products were composed of very fine-grain zircon as shown by X-ray diffraction powder patterns.

*Zircon Sand, Titanium Alloy Division, National Lead Corporation.

REFERENCES

1. Larsen, H. A. , and Drickamer, H. G. , "Mechanical Degradation and Cross-linking of Polymers by Plastic Deformation at High Pressure", J. Phys. Chem. 61, 1643 (1957).
2. Roy, R. , Professor, University of Pennsylvania. Private communication to E. J. Bradbury.
3. Scroggie, A. G. , and Clark, G. L. , "The Crystal Structure of Anhydrous Silicotungstic Acid and Related Compounds and Their Probable Molecular Formulas", Proc. Nat. Acad. Sci. , 15, 1-8 (1929).
4. Kullerud, G. , and Yoder, H. S. , "Pyrite Stability Relations in the Fe-S System", Econ. Geol. , 54, 533-572 (1959).
Clark, L. A. , "The Fe-As-S System: Phase Relations and Applications", Econ. Geol. , 55, 1345-1381, 1631-1652 (1960).
5. Laubengayer, A. W. , and Morton, D. S. , "Germanium XXXIX. The Polymorphism of Germanium Dioxide", J. Am. Chem. Soc. , 54, 2302-2320 (1932).
6. Zoltai, T. , and Buerger, M. J. , "The Crystal Structure of Coesite, The Dense, High-Pressure Form of Silica", Z. Krist. , 111, 129-141 (1959).
7. Op. Cit. Reference 38, p. 2316.
8. Swanson, H. E. , et al. , "Standard X-Ray Diffraction Patterns", Natl. Bur. Stand. Circular 539, 28-29 (1959).
9. Dacheille, F. , and Roy, R. , "High-Pressure Studies of the System Mg_2GeO_4 - Mg_2SiO_4 with Special Reference to the Olivine-Spinel Transition", Am. J. Sci., 258, 225-246 (1960).
Dacheille, F. , and Roy, R. , "The High-Pressure Region of the Silica Isotypes", Z. Krist. , 111, 451-461 (1959).