

**THE ACUTE INHALATION TOXICITY OF  
MONOMETHYLHYDRAZINE VAPOR**

*C. C. HAUN*

*J. D. MacEWEN, Ph.D*

*E. H. VERNOT*

*G. F. EGAN*

This document has been approved for public  
release and sale; its distribution is unlimited.

FOREWORD

This is one of a series of technical reports describing results of the experimental laboratory program being conducted in the Toxic Hazards Research Unit. This report is concerned with the acute inhalation toxicity of monomethylhydrazine, a rocket propellant chemical. The experimental program has been accomplished by Systemed Corporation (Newport Beach, California) under Contract F33615-67-C-1025 for the Toxicology Branch, Toxic Hazards Division, Aerospace Medical Research Laboratory Wright-Patterson Air Force Base, Ohio. The contract was initiated in support of Project 6302, "Toxic Hazards of Propellants and Materials," and Task 630201, "Toxicology." K. C. Back, Ph. D., was the contract monitor for the Aerospace Medical Research Laboratory. This report covers research conducted from February 1966 through November 1967.

J. D. MacEwen, Ph. D., was the principal investigator for the Systemed Corporation. Acknowledgement is made to M. S. West and L. C. DiPasquale, Systemed Corporation, for development of analytical procedures.

This report is identified by Systemed Corporation as report number W68003.

This technical report has been reviewed and is approved.

C. H. KRATOCHVIL, Colonel, USAF, MC  
Commander  
Aerospace Medical Research Laboratory

## ABSTRACT

The lack of adequate data and the increased use of monomethylhydrazine (MMH), a rocket propellant, prompted additional studies of the acute inhalation toxicity of this compound. The reactive nature of MMH necessitated the use of modified test systems designed to minimize the degradation of MMH during animal exposures. Rats, mice, beagle dogs, squirrel monkeys, and rhesus monkeys were exposed to various measured concentrations of MMH vapor for specified time periods. Rodents were exposed for 30-, 60-, 120-, and 240-minute periods; dogs and squirrel monkeys, for 15, 30, and 60 minutes; and rhesus monkeys for 60 minutes only. The toxicity of MMH for the five animal species was defined by determinations of  $LC_{50}$  values, pathology examination of organs, observations of symptoms, measurements of body weight in rats and mice, and blood chemistry and hematology tests on dogs and rhesus monkeys. Squirrel monkeys proved to be the most sensitive and rats the least sensitive to the lethal effects of MMH. MMH exposure produced definite hemolytic changes in dogs and, to a lesser extent, in rhesus monkeys. These experiments show MMH to be a highly toxic compound. Studies are currently in progress to determine the level at which MMH produces no irreversible injury.

TABLE OF CONTENTS

| SECTION  | PAGE |
|--|------|
| I INTRODUCTION                                 | 1    |
| II PRELIMINARY EXPERIMENTS                     | 2    |
| III MATERIALS AND METHODS                      | 3    |
| EXPERIMENTAL ANIMALS                           | 3    |
| Rodents  | 3    |
| Dogs and Monkeys                               | 3    |
| EXPOSURE CHAMBERS AND VAPOR GENERATION SYSTEMS | 4    |
| Rodent Chambers                                | 4    |
| Large Animal Chambers                          | 10   |
| ANALYTICAL METHOD                              | 10   |
| EXPOSURE TECHNIQUE                             | 13   |
| IV EXPERIMENTAL RESULTS AND DISCUSSION         | 15   |
| CONTROL OF EXPOSURE CONCENTRATIONS             | 15   |
| MORTALITY                                      | 15   |
| Rodents  | 15   |
| Dogs and Monkeys                               | 20   |
| RESPONSIVE SIGNS AND SYMPTOMS                  | 31   |
| CLINICAL DETERMINATIONS                        | 34   |
| Body Weight                                    | 34   |
| Hematology                                     | 35   |

TABLE OF CONTENTS (CONT'D)

| SECTION            | PAGE |
|--------------------|------|
| PATHOLOGY          | 38   |
| Repeated Exposures | 39   |
| V    CONCLUSIONS   | 40   |
| REFERENCES         | 41   |

## LIST OF FIGURES

| FIGURE |   | PAGE |
|--------|---|------|
| 1      | Rodent Inhalation Toxicity Exposure System  | 6    |
| 2      | Apparatus for Final Dilution of MMH   | 9    |
| 3      | Modified Rochester Chamber Air Flow Control System  | 11   |
| 4.     | Rochester Chamber System for Toxicity Tests on Large Animals  | 12   |
| 5      | Monomethylhydrazine Standard Calibration Curve  | 14   |
| 6      | Effect of Relative Humidity on MMH Concentration  | 16   |
| 7      | Mortality Response of Rats to MMH   | 19   |
| 8      | Mortality Response of Mice to MMH   | 25   |
| 9      | Hemolytic Response in Dogs that Survived a 60-Minute Exposure to 92 ppm MMH. Plotted Values are Arithmetic Means. | 36   |
| 10     | Hemolytic Response in One Female Rhesus Monkey that Survived a 60-Minute Exposure to 170 ppm MMH                  | 37   |

## LIST OF TABLES

| TABLE |  | PAGE |
|-------|--|------|
| I     | Clinical Hematology and Chemistry Tests Performed on Dogs and Rhesus Monkeys                           | 5    |
| II    | Compatibility of Construction Materials with MMH   | 8    |
| III   | Mortality Response of Male Rats to Various Concentrations of MMH for 240 and 120 Minutes               | 17   |
| IV    | Mortality Response of Male Rats to Various Concentrations of MMH for 60 and 30 Minutes                 | 18   |
| V     | Mortality Response of Male Mice to the Inhalation of MMH for 240 Minutes                               | 21   |
| VI    | Mortality Response of Male Mice to the Inhalation of MMH for 120 Minutes                               | 22   |
| VII   | Mortality Response of Male Mice to the Inhalation of MMH for 60 Minutes                                | 23   |
| VIII  | Mortality Response of Male Mice to the Inhalation of MMH for 30 Minutes                                | 24   |
| IX    | LC <sub>50</sub> Values and 95% Confidence Limits for Rats and Mice Exposed to MMH                     | 26   |
| X     | Mortality Response of Dogs to the Inhalation of MMH  | 27   |
| XI    | Mortality Response of Female Squirrel Monkeys to the Inhalation of MMH                                 | 28   |
| XII   | Mortality Response of Rhesus Monkeys to the Inhalation of MMH  | 29   |
| XIII  | LC <sub>50</sub> Values and 95% Confidence Limits for Dogs, Squirrel and Rhesus Monkeys Exposed to MMH | 30   |
| XIV   | Acute Toxicity Ranking by Species  | 32   |

# *Contrails*



## SECTION I

### INTRODUCTION

In recent years, the broad search for new exotic chemical formulations with properties suitable as high energy rocket propellants has been replaced with increased emphasis on a selected smaller number of fuels. One of the fuels, monomethylhydrazine (MMH), has been employed extensively because of its high performance characteristics, thermal stability and long term storability if contact with air is prevented.

Whereas the literature contains a substantial amount of inhalation toxicity data on hydrazine and its dimethylated derivatives (references 1, 2, 3, and 4), only one publication was found that reported information on MMH. Jacobson et al (reference 5) conducted single, 4-hour exposures of dogs, hamsters, mice, and rats to the vapors of hydrazine, 1, 2-dimethylhydrazine, 1, 1-dimethylhydrazine and monomethylhydrazine and found, in the order the compounds are listed, increasing toxic response. He concluded that MMH was the most toxic and also the most hazardous of the four hydrazine compounds tested.

The paucity of acute inhalation data along with the increased use of MMH clearly indicated the need for additional studies to provide the basis for improvement of existing methods for hazard reduction and safe handling. The experiments reported herein were conducted to confirm and supplement the existing inhalation data. They also served to establish the experimental methodology for planned emergency exposure limit studies to verify current values (reference 6). These latter experiments are currently in progress in this laboratory and will be reported in subsequent publications.

This paper reports the effects of exposures on rats, mice, beagles, squirrel monkeys, and rhesus monkeys to various MMH vapor concentrations. Rodents were exposed for 30-, 60-, 120-, and 240-minute periods, dogs and squirrel monkeys for 15, 30, and 60 minutes, and rhesus monkeys for 60 minutes only.

The MMH used in these experiments was manufactured under military specification MIL-P-27404. To insure a fresh supply of the chemical, long term storage was avoided, and any samples in use that showed evidence of decomposition or discoloration were discarded. Safety precautions for handling and storage recommended by the manufacturer were followed (reference 7).

## SECTION II

## PRELIMINARY EXPERIMENTS

Initial acute inhalation experiments to test the inherent toxicity of unreacted MMH were mostly unsuccessful when groups of rats were exposed for 1 hour in a large inhalation chamber to various measured concentrations of MMH. The chamber MMH concentrations were determined by the method of Watt and Chrisp (reference 8) from a series of samples collected during the exposure period. No consistent pattern was found in the toxic response to MMH by the exposed rats. The relationship between nominal concentrations of MMH and actual measured concentrations was completely irregular, and the observed mortality was apparently unrelated to MMH concentration. The reactive nature of MMH was immediately suspected as the primary problem, and analytical studies were conducted to illuminate the mechanism of its disappearance in the exposure chamber. These studies, reported by Vernot et al (reference 9), revealed that MMH underwent relatively rapid oxidation in air. This oxidation was catalyzed by a variety of materials, including some plastics and formulations of stainless steel. The primary end products of the oxidative reaction were molecular nitrogen and methane, although traces of other hydrocarbons and heterocyclic nitrogen compounds were observed.

The initial animal exposure attempts showed that MMH was a highly toxic substance that required the use of relatively low concentrations for test purposes and that the differences in mortality produced within the specified time periods were contingent upon concentration differences as small as 5 ppm. The experimental test system in use was not sufficiently refined to meet the obvious requirements of precise metering, analysis and control needed for accurate testing of this highly reactive compound. Close examination of the equipment used for generation, concentration attainment and control, and of the results of chemical analysis of MMH by the batch sampling method revealed inadequacies. Accordingly, corrective changes were made to equipment and methods used for vapor generation and analysis, and chamber systems were modified to provide the air flow capacity, temperature, and relative humidity control necessary for conducting animal exposures to unreacted MMH. These changes are presented in detail in subsequent sections and constitute the experimental technique used for the investigations reported in this paper.

SECTION III

MATERIALS AND METHODS

EXPERIMENTAL ANIMALS

Rodents

Groups of 10 Sprague-Dawley rats (125-175 gm) and 20 ICR (Swiss Origin) mice (17-23 gm) were exposed to a series of measured concentrations of MMH for single 30-, 60-, 120-, and 240-minute periods. All rodents used in these experiments were males. To examine the reproducibility of mortality results, groups of 20 mice were exposed in "paired" experiments at the selected concentration levels and time intervals. All animals were weighed on the day of exposure and observed for toxic signs during exposure and for 14 days thereafter. The rats that survived the various MMH exposure concentrations for 240 minutes were weighed at 3-, 7-, and 14-day postexposure, while those exposed in the 120-, 60-, and 30-minute series were followed more closely and weighed at 1-, 2-, 3-, 7-, and 14-day postexposure. All of the exposed groups of mice were weighed as a unit at 1-, 2-, 3-, 7-, and 14-day postexposure. Each mouse was weighed prior to exposure to insure normal weight range uniformity within and between groups. The growth rates of MMH exposed rats were compared with those of the controls. Some rodents that died during or were killed following the various exposure combinations were submitted for histopathologic studies of the lung, liver, kidney, heart, and spleen after routine gross examination. The time of death of each individual animal was noted and the total number of deaths occurring in each experiment was recorded. The respective  $LC_{50}$  values and their 95% confidence limits were calculated by the probit method utilizing the BMD03S Computer Program (reference 10). This service was provided by the Digital Computation Division of the Aeronautical Systems Division, Wright-Patterson Air Force Base, Dayton, Ohio.

Dogs and Monkeys

Male and female beagle dogs, 8 to 30 months of age (7 to 13 kg) and young female squirrel monkeys (*Saimiri sciurea*) (560 to 680 gm) were exposed to various concentrations of MMH for 15-, 30-, and 60-minute time periods either singly or in groups of 2, 3, and 5. Male and female rhesus monkeys (*Macaca mulatta*) were exposed only for 60-minute periods using one or two animals in each experiment. All animals were weighed on the day of the exposure and care was taken to include as much as possible the same range of body weights in each of the exposure groups. Symptoms of toxic stress observed during exposure and postexposure until the animals died or were killed

for pathologic examination were recorded. The mortality resulting in each experiment was recorded, and the respective  $LC_{50}$  values and 95% confidence limits were calculated or estimated using the Thompson method of moving averages (reference 11).

Baseline hematology and blood chemistry determinations were made biweekly on blood samples collected from dogs and rhesus monkeys for a number of weeks before exposures were initiated. The blood measurements were not made on squirrel monkeys due to the small size of the animals and the difficulty in taking enough blood for analysis. A battery of blood determinations was selected to monitor effects induced by MMH, depending on the expected results of the exposure. That is, if the MMH concentration was expected to produce death, a series A profile was called for that consisted of 19 determinations to be made on blood samples taken immediately pre- and postexposure. If survival was expected, the experimental design followed required a series B profile which measured 13 factors at weekly intervals and a series C profile consisting of 7 determinations made semiweekly until the blood picture returned to normal. The various blood determinations made for each of the profile series are listed in table I. Blood samples were taken from the femoral vein of the monkeys and from the jugular or cephalic vein of the beagles.

All animals that died during or following exposure were submitted for postmortem gross and histopathologic examination to determine the mechanism of acute toxicity. Selected rodents and all dogs and monkeys were submitted for examination at the termination of the postexposure observation period.

## EXPOSURE CHAMBERS AND VAPOR GENERATION SYSTEMS

### Rodent Chambers

As noted previously, the reactive nature of MMH required equipment specifically designed to insure that animals were being exposed to unreacted material. Figure 1 shows a schematic presentation of the apparatus constructed to accomplish this purpose for rodent toxicity studies.

An infusion pump was used to meter the correct quantities of MMH at the desired delivery rate for each exposure. An adjustable syringe cradle was constructed to firmly hold a 5-, 10-, or 20-cc syringe, making it possible to use the apparatus in a vertical rather than in the normal horizontal position. A smaller version of the evaporator unit described by Carpenter et al (reference 12) was used to vaporize the test material. Exposures were carried out in a 30-liter bell jar chamber at an air flow of 30-40 liters per minute. Chamber MMH concentrations were first established in a parallel

TABLE I

Clinical Hematology and Chemistry Tests  
Performed on Dogs and Rhesus Monkeys

| Series   |          |          |  |
|----------|----------|----------|--|
| <u>A</u> | <u>B</u> | <u>C</u> | <u>Hematology</u>                                  |
| x        | x        | x        | Hematocrit (vol %)                                 |
| x        | x        | x        | Hemoglobin (gm %)                                  |
| x        | x        | x        | Plasma Hemoglobin (mg %)                           |
| x        | x        | x        | Total RBC (Million Cells/mm <sup>3</sup> )         |
| x        | x        | x        | Total WBC (Cells/mm <sup>3</sup> )                 |
| x        | x        | x        | Differential (Per 100 White Cells)                 |
| x        | x        | x        | Reticulocyte Count (%)                             |
|          |          |          | <u>Chemistry</u>                                   |
| x        |          |          | Sodium (meq/l)                                     |
| x        |          |          | Potassium (meq/l)                                  |
| x        |          |          | Calcium (meq/l)                                    |
| x        | x        |          | Total Protein (gm %)                               |
| x        | x        |          | Albumin (gm %)                                     |
| x        |          |          | SGPT (Reitman-Frankel Units)                       |
| x        |          |          | SGOT (Reitman-Frankel Units)                       |
| x        |          |          | Alkaline Phosphatase (Kein, Babson,<br>Read Units) |
| x        |          |          | Total Phosphorus (mg %)                            |
| x        |          |          | LDH (Cabaud-Wroblewski Units)                      |
|          | x        |          | Bilirubin (mg %)                                   |
|          | x        |          | Prothrombin Time (% Activity)                      |
| x        | x        |          | Blood Urea Nitrogen (mg %)                         |
| x        | x        |          | Creatinine (mg %)                                  |

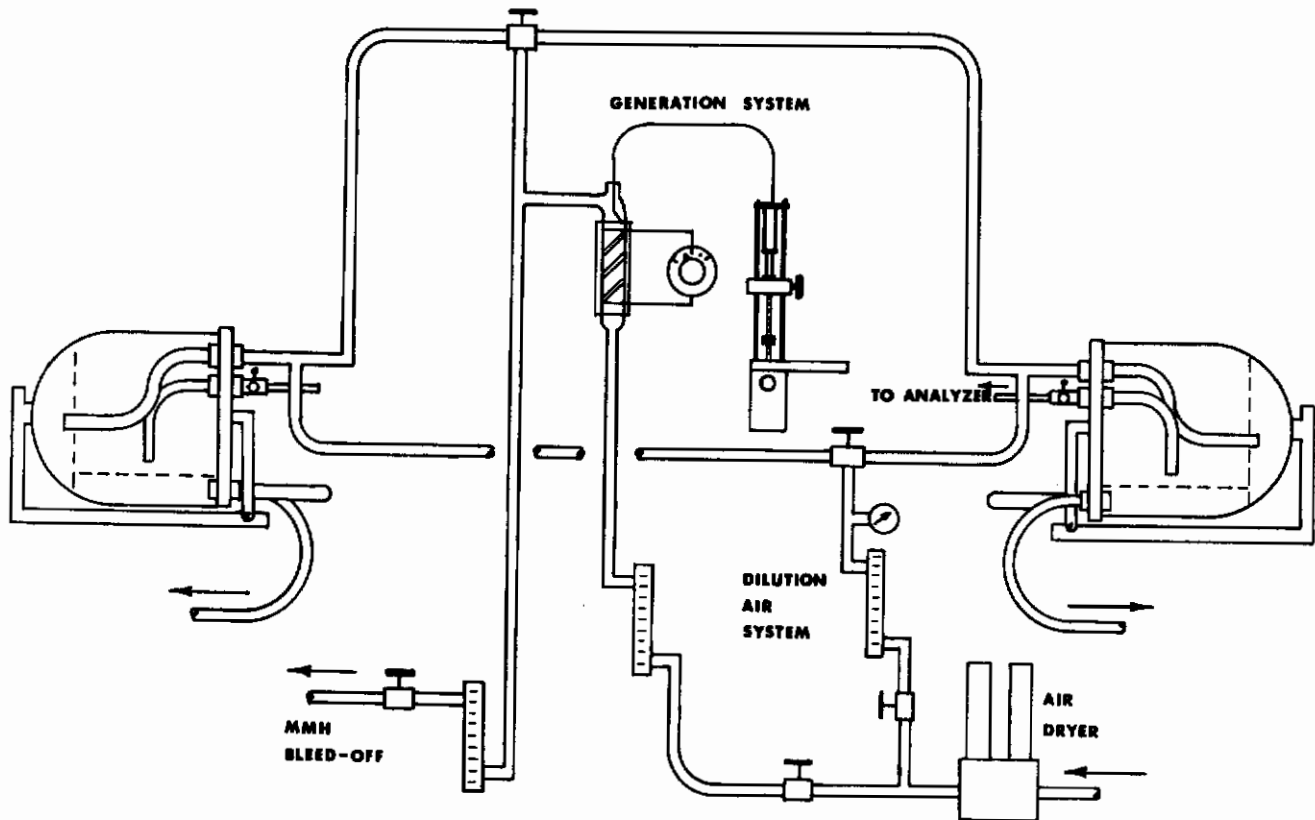

Figure 1. Rodent Inhalation Toxicity Exposure System

# Contrails

empty exposure system and the gas stream was then switched to the test animals in the alternate chamber to commence the exposure. To substantially reduce decomposition of MMH, water vapor in the metered air flows to the evaporator and the chamber (dilution air system) was reduced to 40 F dew point by means of an automatic regenerating air dryer using molecular sieve as the water vapor absorbent.

One of the problems alluded to previously in the discussion on preliminary rodent testing concerned the metering of very small quantities of MMH to obtain the desired low chamber concentrations. Despite all precautions, bubbles would occasionally form in the MMH syringe reservoir causing erratic liquid flow to the evaporator and producing concentration fluctuation in the rodent chamber. To overcome this problem, approximately 5 times the volume of MMH actually required to produce a given chamber concentration was delivered to the evaporator generation system. The increased volume flow of MMH in the generation system reduced residence and reaction time with all surfaces. Immediately beyond the evaporator, the excess was then bled off at a metered rate through a tee in the gas line. This arrangement is also shown in figure 1.

To further minimize decomposition, all transfer of liquid MMH took place in a nitrogen atmosphere or through nonreactive material (Teflon stopcocks and type 304 stainless steel). Metered flows of one to three liters per minute of air conducted the vapor from the evaporator into a contaminant piping system specifically constructed of materials found to be compatible with MMH (table II).

The dilution apparatus shown in figure 2 (A section of 1/4-inch 304 SS tubing inserted through a 1/2-inch pipe tee, pipe connection and bulkhead union) was utilized to delay final dilution of the MMH vapor until just before delivery to the chamber. The primary air stream entered at the top of the tee and was mixed with the MMH vapor supply. The comparatively high gas flow and its baffling on the rear wall of the chamber prevented channeling. A floor barrier and backwall made of type 321 SS expanded wire mesh formed a cage for containing the animals and preventing interference with the gas flow pattern. Effluent gas was discharged through an outlet at the bottom center of the chamber door. The interior of the door was lined with sponge rubber covered with a thin Teflon sheet. The chamber door was operated by a spring-loaded, snap-handle mechanism attached to the metal framework which supported the inhalation chamber.

TABLE II

Compatibility of Construction Materials with MMH\*

| <u>Material</u>           | <u>Compatibility Rating</u> |
|---------------------------|-----------------------------|
| Type 304 Stainless Steel  | A                           |
| Type 316 Stainless Steel  | C                           |
| Type 321 Stainless Steel  | A                           |
| TFE Teflon                | A                           |
| FEP Teflon                | A                           |
| Kel-F Fluorinated Polymer | B                           |

A - Materials acceptable for general use.

B - Materials acceptable for limited use.

C - Materials which should be avoided.

\*Monomethyl Hydrazine Handling and Storage,  
September, 1965. Product Data Guide of  
Chemicals Division, Olin Matheson Company,  
Hydrazine Products Division.

The necessary fittings for construction were available only in 316 SS. However, the two items involved represent less than 5 percent of the total surface area of the contaminant piping system.



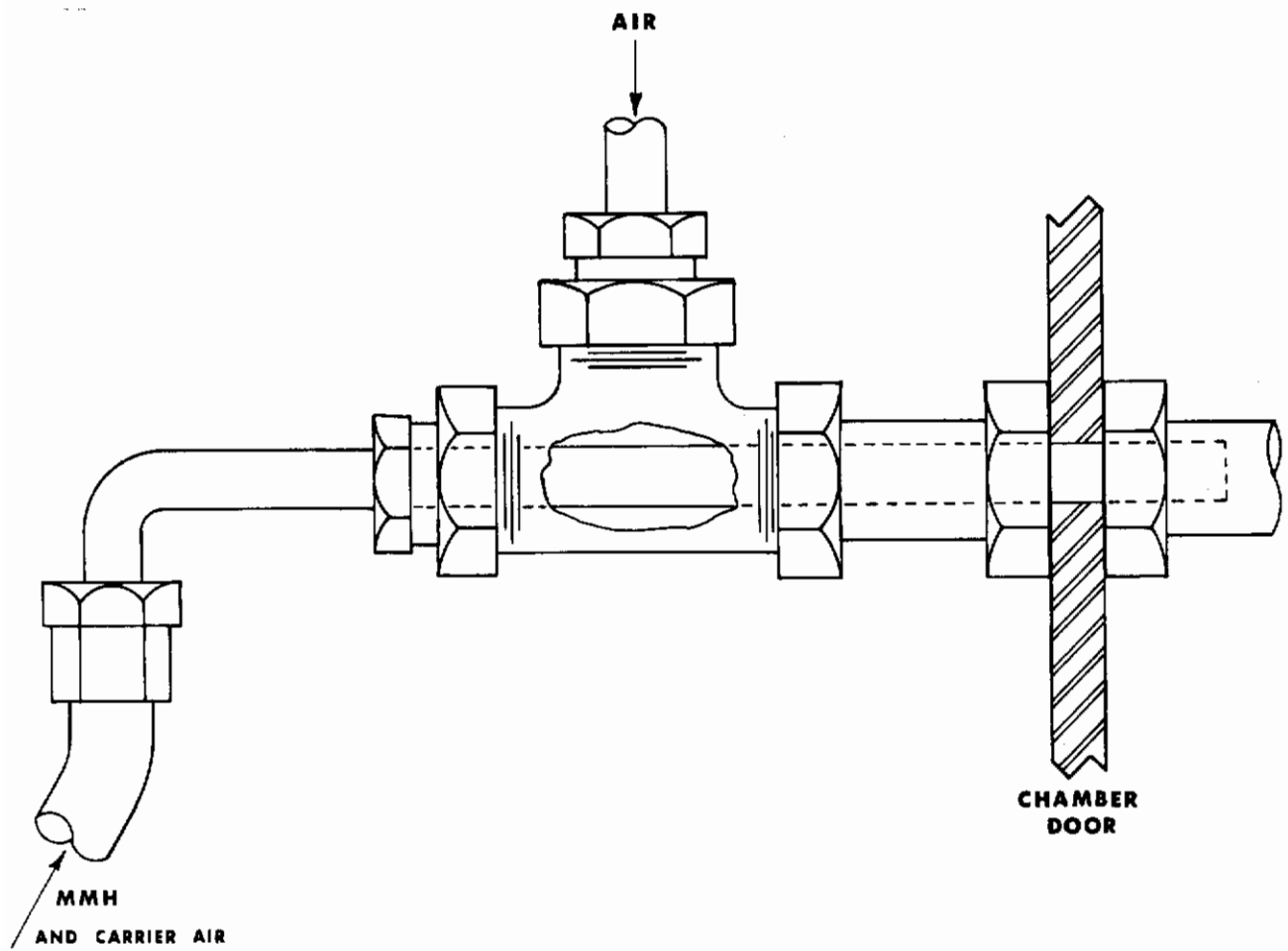

Figure 2. Apparatus for Final Dilution of MMH

## Large Animal Chambers

A modification of a standard Rochester Chamber (references 13 and 14) was used for the exposure of dogs and monkeys. Further changes were made in the chamber air supply and exhaust systems to minimize decomposition of the test materials. The orifice plate, used to measure chamber air flow rate in the exhaust duct, was replaced with a stainless steel laminar flow element. The substitution of the new air flow metering device allowed a higher operating range of flow rates necessary to reduce residence time in the chamber and decrease degradation of the MMH. The final flow rate selected was 100 cfm. It was also necessary to replace the chamber exhaust blower with one having the appropriate flow characteristics. An electrically actuated butterfly valve was installed in the chamber exhaust line to provide for adjustment of chamber air flow at the control panel (figure 3).

The chamber air conditioning system provided filtered input air controlled at approximately 72 F and 50% relative humidity. It was impractical from an engineering standpoint to predry the large volumes of air used in this system and, therefore, tests were conducted to determine the effect of water vapor on MMH concentration. These tests showed that while MMH did decompose under the experimental conditions, its decomposition was reproducible and could, therefore, be compensated. Desired chamber concentrations of MMH were achieved and maintained without difficulty.

Equipment similar to that used for the bell jar exposure chamber system was used to meter and evaporate predetermined quantities of MMH. The equipment, consisting of a multiple speed motor driven syringe assembly and a full size evaporator, proved satisfactory for use in the large chamber. Predried air at a flow rate of 5 to 8 cfm carried the vaporized MMH and introduced it into the air supply duct near the top portion of the chamber. The components and this system are shown in figure 4.

## ANALYTICAL METHOD

Because of the reactive nature of MMH and the extremely small range of concentrations between the no-effect and lethal levels seen in the preliminary experiment, a method of continuous analysis was required. The continuous monitoring of chamber MMH concentrations was accomplished by use of an electron capture instrument (reference 15) which measured the concentration of an aerosol formed by the reaction of MMH with trifluoroacetic acid vapor.

This instrument is a self-contained monitoring system suitable for continuous analysis, in the parts per billion range, of acidic or basic vapors which can be reacted to form aerosols within the apparatus. An electrical signal generated by the electron capture detector was transmitted to a millivolt recorder.

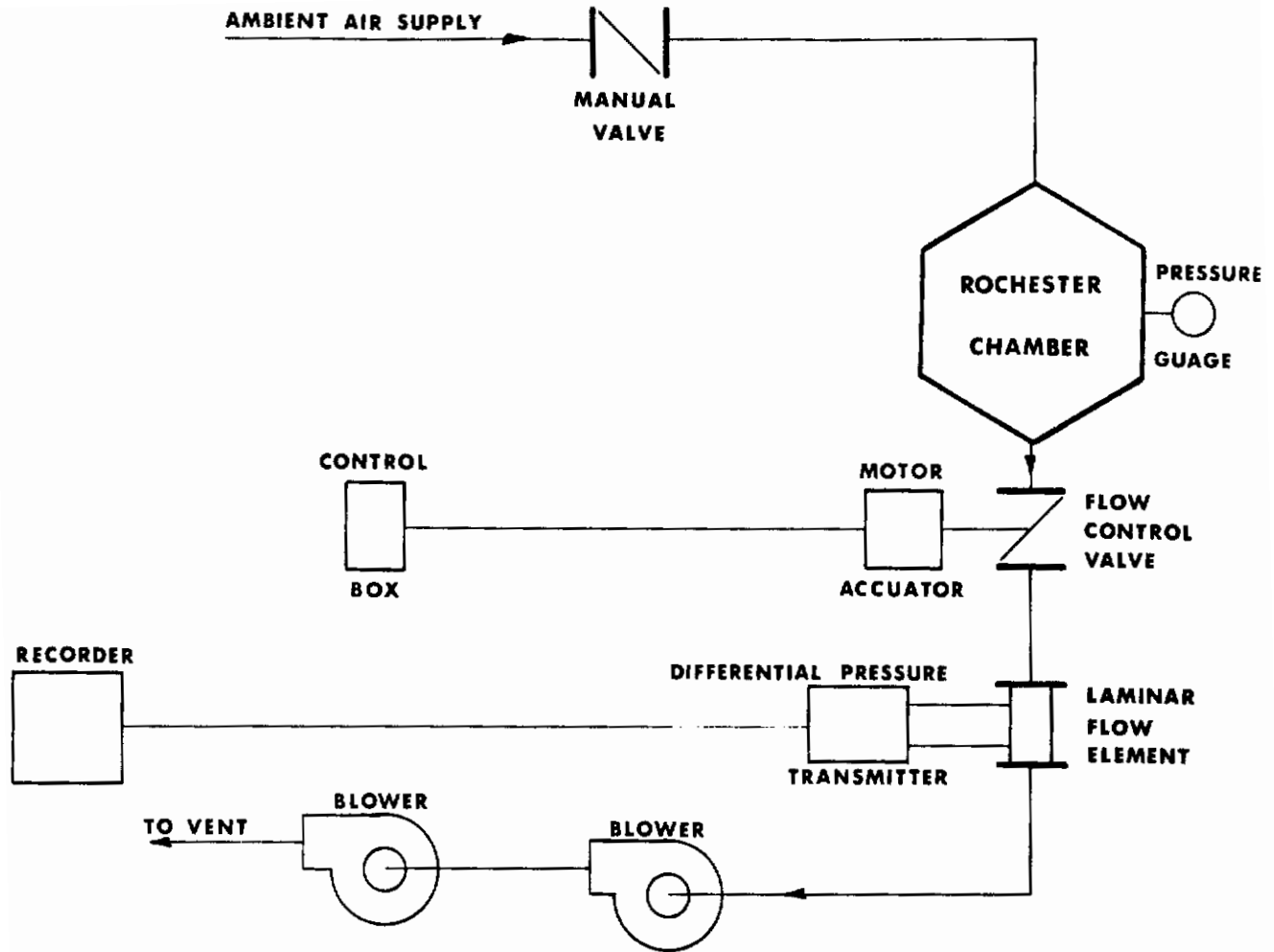

Figure 3. Modified Rochester Chamber Air Flow Control System

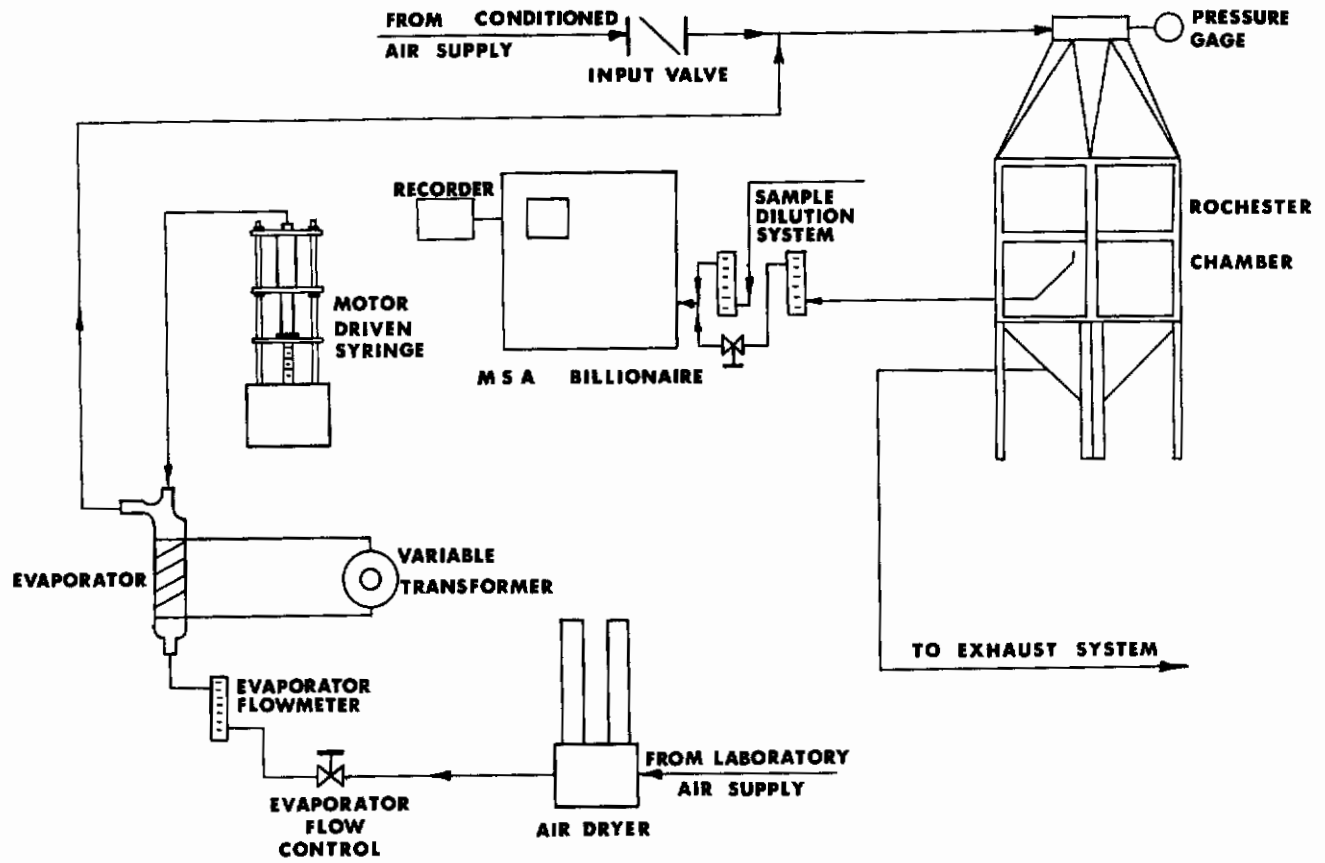

Figure 4. Rochester Chamber System for Toxicity Tests on Large Animals

Typically, the instrument recorder response time was only 12 seconds, permitting almost instantaneous readout of chamber concentrations.

The automatic MMH analyzer was calibrated daily using standards made in polyester film bags filled with 200 liters of dry nitrogen into which the desired amount of liquid MMH was injected through a rubber septum. Gentle warming and manipulation of the bag insured complete evaporation and mixing. The extreme sensitivity of the electron capture instrument made it necessary to predilute the chamber samples tenfold with room air before analysis could be made. A typical calibration plot is shown in figure 5.

Sampling from different positions in both Rochester and bell jar chambers showed that MMH concentrations were uniform throughout. During exposures, samples were taken from a point as near the animal breathing zone as possible. The sampling probe was movable and could be relocated if necessary to prevent animal interference with air flow.

## EXPOSURE TECHNIQUE

Exposures of rodents were conducted in the small 30-liter chamber as follows:

1. Experimental animals were placed in one of the chambers with the door slightly ajar.
2. The desired concentration of MMH was obtained in the second parallel chamber.
3. The chamber door was closed.
4. The MMH-air mixture was then diverted to the chamber containing the animals by means of simultaneous switching of two 3-way valves.

Desired concentrations of MMH in the Rochester Chamber were achieved without animals. MMH generation was then stopped and the chamber purged rapidly at maximum air flow. The test animals were then inserted in the chamber, the MMH generation started and the timing of the 30- or 60-minute exposures was begun. Fifteen-minute exposures, performed only on dogs and squirrel monkeys, were conducted in a slightly different manner. After the desired chamber concentration was attained and stabilized, one door of the Rochester Chamber was opened with due precaution to minimize concentration fluctuations and to prevent human exposure, and the dogs or squirrel monkeys were quickly inserted. The door was closed and the timing of the exposure begun.

**TYPICAL CALIBRATION CURVE  
FOR  
0-300 PPM OF MMH**

**bridge voltage = 5.0 volts**

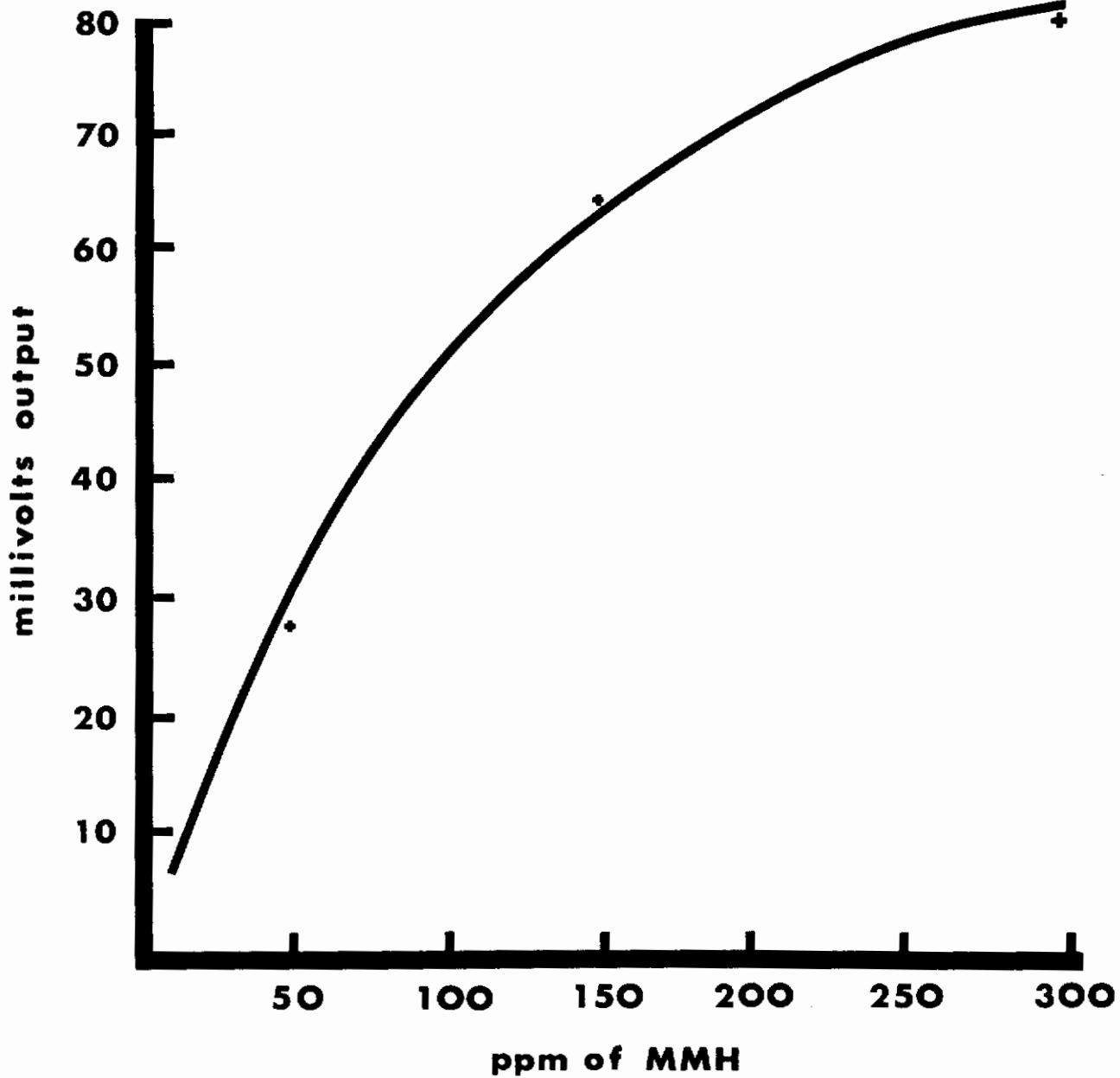

Figure 5. Monomethylhydrazine Standard Calibration Curve

## SECTION IV

## EXPERIMENTAL RESULTS AND DISCUSSION

## CONTROL OF EXPOSURE CONCENTRATIONS

A number of preliminary experiments were conducted with rodents prior to establishing reliable and accurate systems for the generation, control, and analysis of MMH vapors. Since MMH was a reactive chemical which could not be handled easily in conventional test systems, a number of preliminary experiments were carried out to determine the effect of chamber air flow rate and relative humidity on MMH. Figure 6 is a graph of results obtained.

The tests were conducted in a Rochester Chamber at 40% RH and 100 cfm at an MMH delivery rate leading to a theoretical concentration of 200 ppm. Analysis, however, gave an actual chamber MMH concentration of 100 ppm showing a 50% loss under these conditions. When the humidity was increased to 70% by water vapor injection, only 60 ppm was found in the chamber, a 70% loss. However, decreasing the flow rate at any relative humidity level had little, if any, effect on MMH concentrations.

It appeared, therefore, that the major factor leading to the disappearance of MMH from the chamber was relative humidity. This conclusion was strengthened by the initial animal work in small 30-liter bell jar chambers in which the air was predried to 40 F dewpoint. In these experiments, the analyzed MMH concentration was reduced only 10% below theoretical. Since the relative humidity in Rochester Chambers cannot readily be decreased below 40%, the loss of contaminant could not be eliminated. Analysis, however, revealed that the desired MMH chamber concentration throughout the exposures could be satisfactorily controlled and was reproducible when relative humidity was maintained at a fixed level.

## MORTALITY

Rodents

The detailed rat mortality data with mean measured MMH concentrations and ranges are presented in tables III and IV. The only rat deaths during exposure occurred at the two highest concentration levels in the 240-minute studies. Two of three animal deaths caused by exposure to 75 ppm MMH and one of nine resulting from exposure to 85 ppm succumbed during the exposure. The concentration x time (CT) products in these two exposures were higher than in any other, thus indicating a threshold for during-exposure mortality. Without exception, all other deaths occurred within 4 hours postexposure. Mortality obtained in the various experiments with rats is shown graphically in figure 7.

1.19 ml./min. Liquid MMH Vaporized Into Chamber  
Theoretical Concentration at 100 cfm was 200 ppm MMH

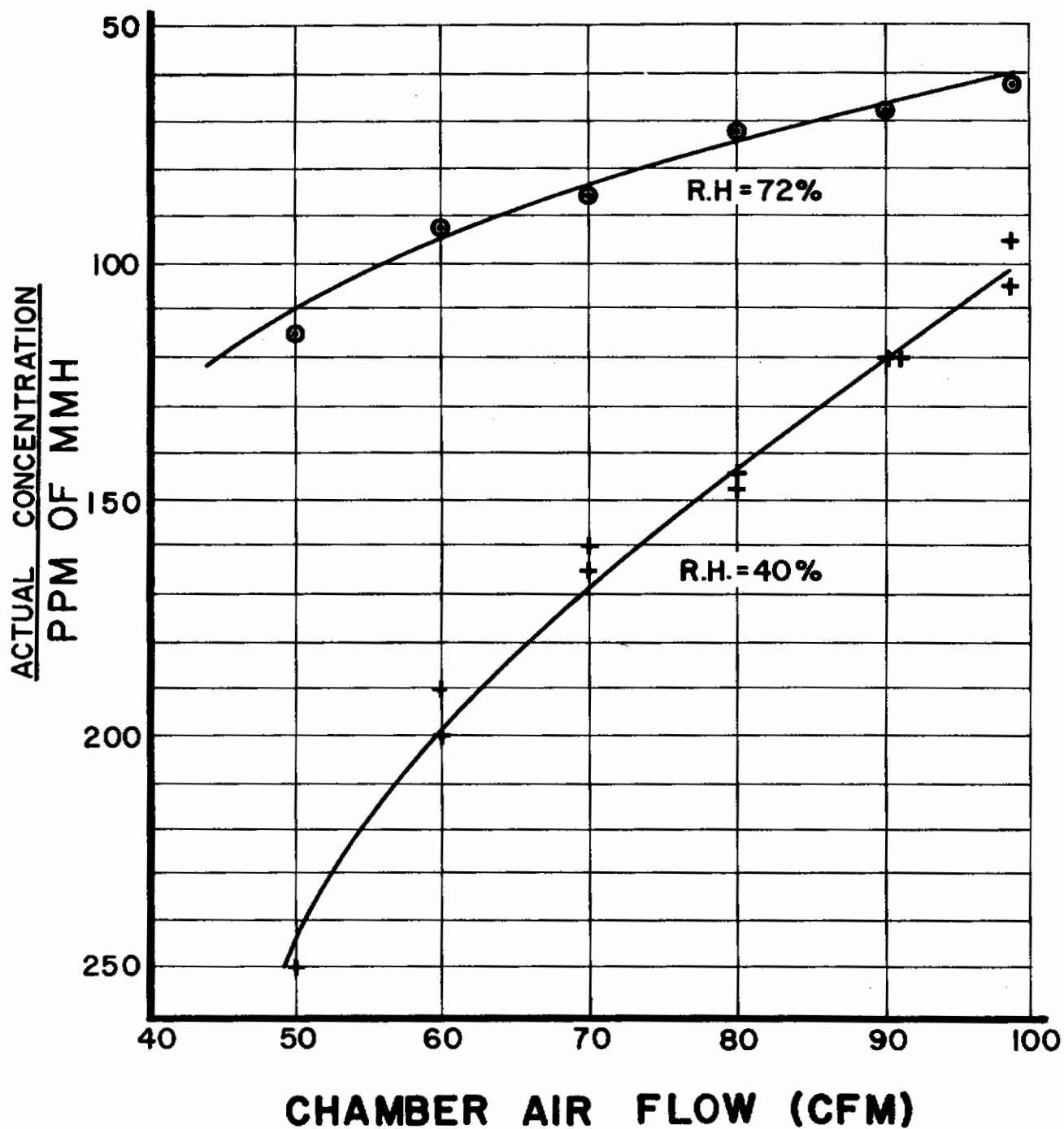

Figure 6. Effect of Relative Humidity on MMH Concentration



TABLE III

Mortality Response of Male Rats  
To Various Concentrations of MMH  
for 240 and 120 Minutes

240 Minute

| <u>Expt. No.</u> | <u>ppm</u>        |              | <u>Mortality*</u> |
|------------------|-------------------|--------------|-------------------|
|                  | <u>Mean Conc.</u> | <u>Range</u> |                   |
| 202-14           | 65                | (55-75)      | 0/10              |
| 202-18           | 70                | (63-75)      | 0/10              |
| 202-16           | 75                | (68-80)      | 3/10              |
| 202-15           | 85                | (78-95)      | 9/10              |

120 Minute

|        |     |           |      |
|--------|-----|-----------|------|
| 202-12 | 100 | (97-103)  | 0/10 |
| 202-19 | 113 | (110-122) | 2/10 |
| 202-17 | 125 | (115-135) | 5/10 |
| 202-13 | 150 | (140-155) | 9/10 |

\*Number Died/Number Exposed

TABLE IV

Mortality Response of Male Rats  
To Various Concentrations of MMH  
for 60 and 30 Minutes

60 Minute

| <u>Expt. No.</u> | <u>ppm</u>        |              | <u>Mortality*</u> |
|------------------|-------------------|--------------|-------------------|
|                  | <u>Mean Conc.</u> | <u>Range</u> |                   |
| 202-1            | 200               | (155-208)    | 2/10              |
| 202-2            | 250               | (195-260)    | 5/10              |
| 202-3            | 268               | (173-295)    | 7/10              |

30 Minute

|        |     |           |      |
|--------|-----|-----------|------|
| 202-6  | 375 | (344-380) | 3/10 |
| 202-5  | 400 | (370-410) | 6/10 |
| 202-20 | 400 | (390-415) | 3/10 |
| 202-8  | 425 | (400-460) | 2/10 |
| 202-4  | 450 | (400-476) | 6/10 |
| 202-7  | 475 | (425-500) | 8/10 |

\*Number Died/Number Exposed

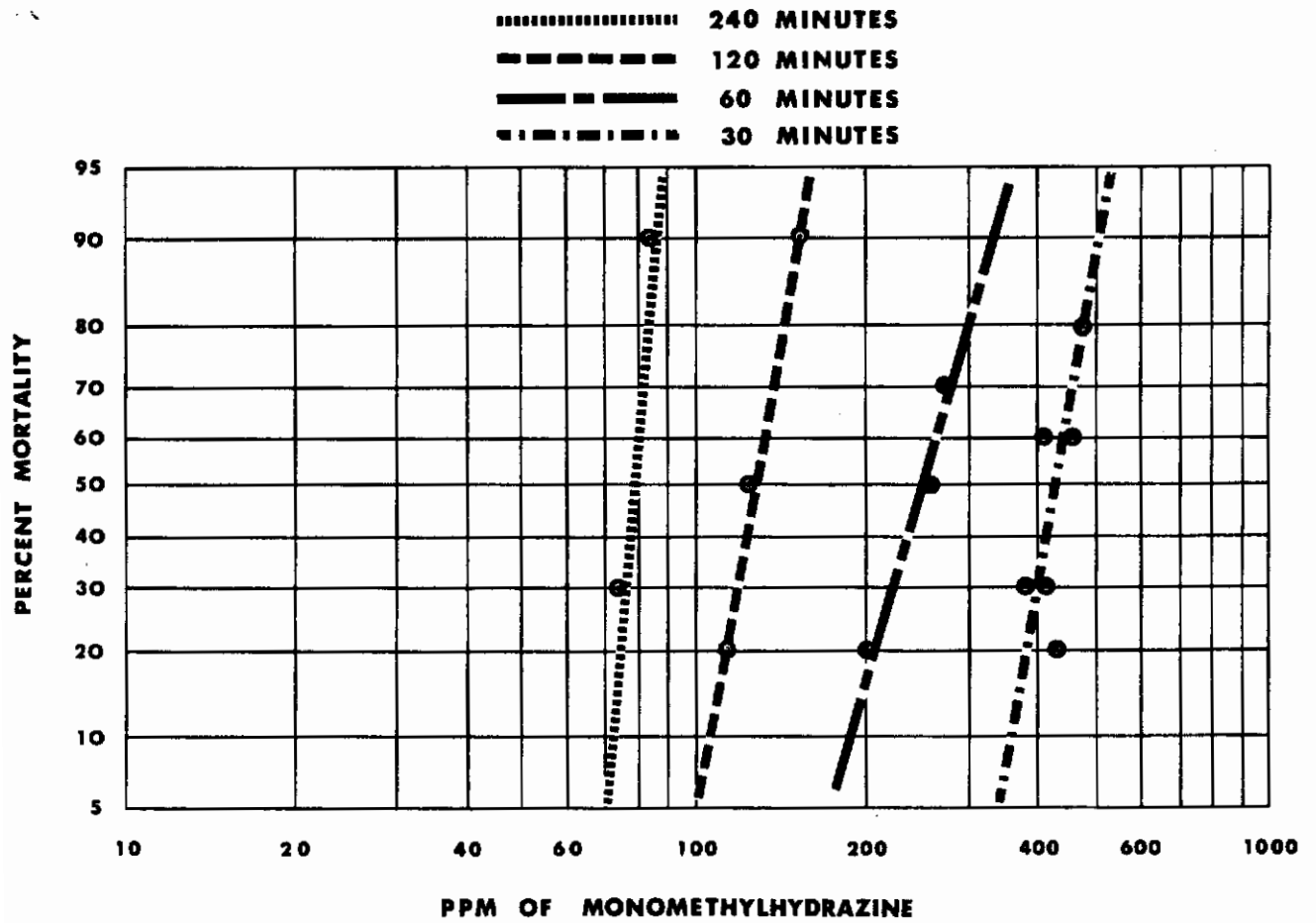

Figure 7. Mortality Response of Rats to MMH

Mouse deaths, too, were generally delayed until after exposure. Except for the higher concentrations at 120 and 240 minutes, which produced some mortality during exposure, practically all of the mice died within 5 hours after exposure. Here again, it appears that a CT threshold may have been exceeded to produce during-exposure deaths. Mortality data are given in tables V to VIII. The tables also illustrate the good reproducibility of mortality attained in the paired exposure experiments. The percent mortality is plotted against MMH concentration in ppm in figure 8.

The  $LC_{50}$  values and the 95% confidence limits for rats and mice exposed to MMH for 240, 120, 60, and 30 minutes are shown in table IX. A comparison of these  $LC_{50}$  values obtained for four-hour exposures to mice and rats was made with data presented by Jacobson (reference 5). Jacobson's values are essentially the same (74 ppm vs. 78 ppm in rats and 56 ppm vs. 65 ppm in mice) as those obtained in this laboratory.

## Dogs and Monkeys

No deaths occurred during exposure of large animal species regardless of the duration or MMH concentration. The pattern of postexposure deaths observed in dogs was similar to that of rodents since the dogs died within two hours following the conclusion of exposure. Squirrel monkeys exhibited delayed deaths to a much greater degree than did dogs. Although a few squirrel monkeys died as early as 2 and 4 hours, most deaths were observed between 10 to 24 hours after exposure. Tables X, XI, and XII detail mortality for dogs, squirrel monkeys and rhesus monkeys, respectively. The number of rhesus monkeys tested was too small to give a precise measure of time to death.

The  $LC_{50}$  values and the 95% confidence limits for the three large animal species tested can be seen in table XIII. Although Jacobson did not expose dogs for less than 4 hours, his data may be compared to these experiments by analysis of the CT values. His 4-hour data permit estimation of a CT value of 6000 ppm-minutes compared to the 5860 CT calculated from our 60-minute dog exposure. This comparison appears to be valid since dogs exhibited a consistent CT relationship throughout the range tested. The  $LC_{50}$  values for all animals were plotted against the reciprocal of the exposure time in minutes to test the validity of the classical assumption:

$$LC_{50} \times T = K.$$

If this expression was valid for our data, we should have obtained a straight-line plot passing through the origin at  $1/T = 0$  or  $T = \infty$ . Straight-line plots appeared to fit the data very well and, in the case of squirrel monkeys and dogs, passed through the origin. However, although good linearity was achieved from the rodent data, the plots did not pass through the origin

TABLE V

Mortality Response of Male Mice to the  
Inhalation of MMH for 240 Minutes

| <u>Expt. No.</u> | <u>ppm</u>        |              | <u>Mortality*</u> | <u>Total Mortality*</u> |
|------------------|-------------------|--------------|-------------------|-------------------------|
|                  | <u>Mean Conc.</u> | <u>Range</u> |                   |                         |
| 182-62 A         | 27                | (10-35)      | 0/20              | 0/20                    |
| 182-62 B         | 25                | (23-30)      | 0/20              |                         |
| 182-63 A         | 50                | (48-53)      | 0/20              | 0/40                    |
| 182-63 B         | 50                | (45-55)      | 0/20              |                         |
| 182-67 A         | 55                | (50-58)      | 0/20              | 1/40                    |
| 182-67 B         | 55                | (50-58)      | 1/20              |                         |
| 182-66 A         | 63                | (55-70)      | 5/20              | 7/40                    |
| 182-66 B         | 60                | (50-68)      | 2/20              |                         |
| 182-68 A         | 63                | (48-68)      | 13/20             | 23/40                   |
| 182-68 B         | 63                | (58-68)      | 10/20             |                         |
| 182-65 A         | 68                | (63-75)      | 18/20             | 31/40                   |
| 182-65 B         | 66                | (60-70)      | 13/20             |                         |
| 182-64 A         | 83                | (60-113)     | 19/20             | 37/40                   |
| 182-64 B         | 83                | (65-88)      | 18/20             |                         |

\*Number Died/Number Exposed

TABLE VI

Mortality Response of Male Mice to the  
Inhalation of MMH for 120 Minutes

| <u>Expt. No.</u> | <u>ppm</u>        |              | <u>Mortality*</u> | <u>Total<br/>Mortality*</u> |
|------------------|-------------------|--------------|-------------------|-----------------------------|
|                  | <u>Mean Conc.</u> | <u>Range</u> |                   |                             |
| 182-58 A         | 58                | (50-63)      | 0/20              | 0/40                        |
| 182-58 B         | 60                | (58-80)      | 0/20              |                             |
| 182-60 A         | 68                | (60-75)      | 1/20              | 1/40                        |
| 182-60 B         | 68                | (58-75)      | 0/20              |                             |
| 182-57 A         | 83                | (65-88)      | 6/20              | 15/40                       |
| 182-57 B         | 85                | (75-88)      | 9/20              |                             |
| 182-59 A         | 105               | (93-123)     | 15/20             | 31/40                       |
| 182-59 B         | 108               | (95-120)     | 16/20             |                             |
| 182-61 A         | 120               | (90-140)     | 20/20             | 38/40                       |
| 182-61 B         | 128               | (100-250)    | 18/20             |                             |

\*Number Died/Number Exposed

TABLE VII

Mortality Response of Male Mice to the  
Inhalation of MMH for 60 Minutes

| <u>Expt. No.</u> | <u>ppm</u>        |              | <u>Mortality*</u> | <u>Total<br/>Mortality*</u> |
|------------------|-------------------|--------------|-------------------|-----------------------------|
|                  | <u>Mean Conc.</u> | <u>Range</u> |                   |                             |
| 182-51 A         | 85                | (55-98)      | 0/20              | 0/40                        |
| 182-51 B         | 70                | (53-83)      | 0/20              |                             |
| 182-53 A         | 100               | (80-110)     | 10/20             | 15/40                       |
| 182-53 B         | 98                | (85-110)     | 5/20              |                             |
| 182-52 A         | 113               | (85-118)     | 4/20              | 7/40                        |
| 182-52 B         | 105               | (70-115)     | 3/20              |                             |
| 182-50 A         | 120               | (93-145)     | 16/20             | 29/40                       |
| 182-50 B         | 120               | (90-145)     | 13/20             |                             |
| 182-54 A         | 145               | (130-163)    | 12/20             | 22/40                       |
| 182-54 B         | 140               | (88-170)     | 10/20             |                             |
| 182-47 A         | 155               | (93-163)     | 15/20             | 30/40                       |
| 182-47 B         | 155               | (90-163)     | 15/20             |                             |
| 182-48 A         | 180               | (78-213)     | 20/20             | 40/40                       |
| 182-49 B         | 200               | (80-225)     | 20/20             |                             |

\*Number Died/Number Exposed

TABLE VIII  
Mortality Response of Male Mice to the  
Inhalation of MMH for 30 Minutes

| <u>Expt. No.</u> | <u>ppm</u>        |              | <u>Mortality*</u> | <u>Total<br/>Mortality*</u> |
|------------------|-------------------|--------------|-------------------|-----------------------------|
|                  | <u>Mean Conc.</u> | <u>Range</u> |                   |                             |
| 182-41 A         | 143               | (80-168)     | 0/20              | 0/80                        |
| 182-41 B         | 135               | (88-168)     | 0/20              |                             |
| 182-41 C         | 142               | (88-155)     | 0/20              |                             |
| 182-41 D         | 143               | (78-168)     | 0/20              |                             |
| 182-42 A         | 205               | (130-243)    | 0/20              | 4/40                        |
| 182-42 B         | 200               | (93--213)    | 4/20              |                             |
| 182-43 A         | 250               | (118-315)    | 9/20              | 16/40                       |
| 182-43 B         | 250               | (118-300)    | 7/20              |                             |
| 182-44 A         | 322               | (220-360)    | 15/20             | 28/40                       |
| 182-44 B         | 324               | (190-390)    | 13/20             |                             |
| 182-46 A         | 345               | (98-413)     | 19/20             | 37/40                       |
| 182-46 B         | 380               | (203-413)    | 18/20             |                             |

\*Number Died/Number Exposed



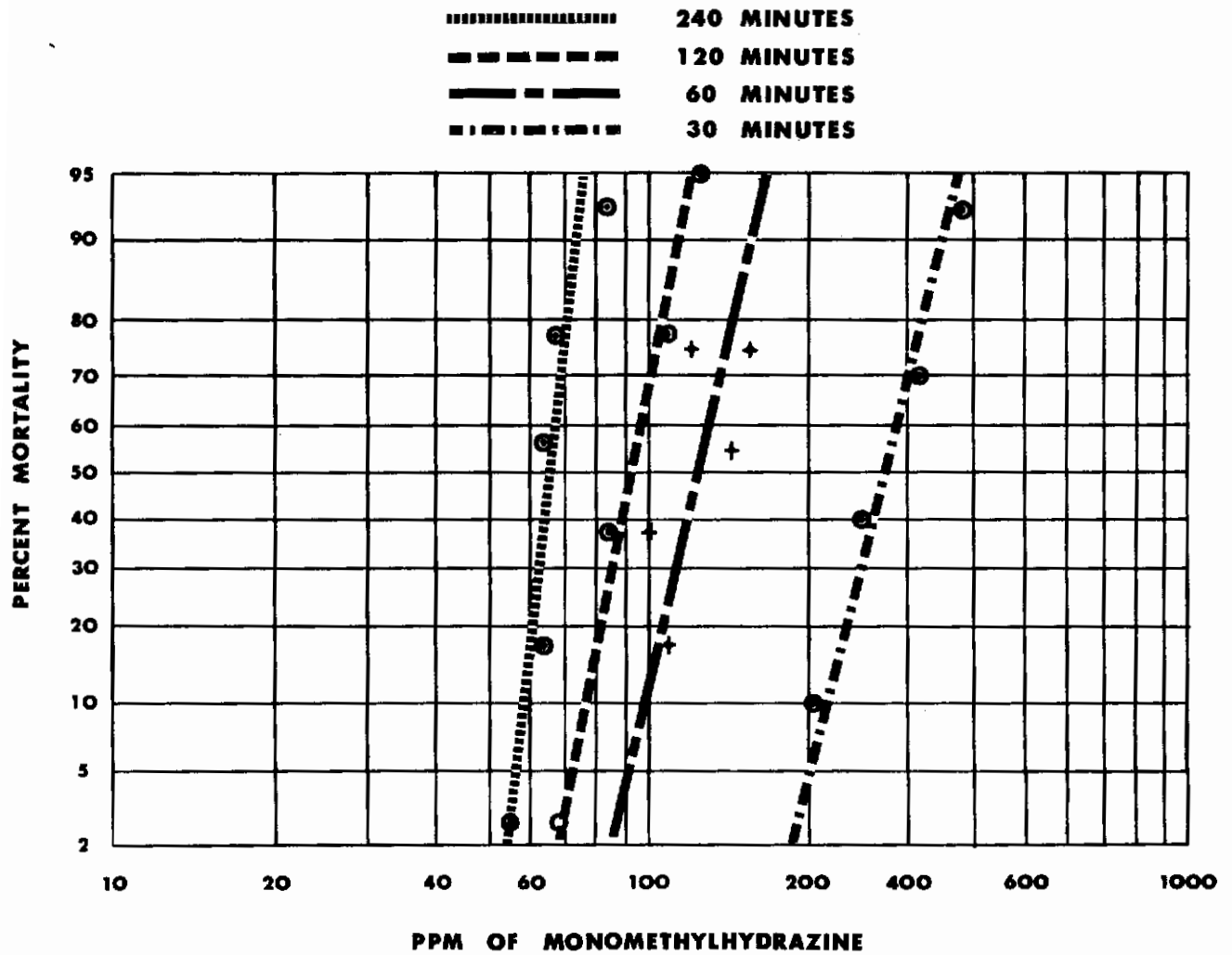

Figure 8. Mortality Response of Mice to MMH

TABLE IX  
LC<sub>50</sub> Values and 95% Confidence Limits  
for Rats and Mice Exposed to MMH

| <u>Animals<br/>and Sex</u> | <u>Duration of<br/>Exposure (min. )</u> | <u>LC<sub>50</sub><br/>ppm</u> | <u>Confidence<br/>Limits-ppm</u> |
|----------------------------|---|--------------------------------|----------------------------------|
| Male Rats                  | 240                                     | 78                             | 71-86                            |
|                            | 120                                     | 127                            | 119-134                          |
|                            | 60                                      | 244                            | 219-275                          |
|                            | 30                                      | 427                            | 398-458                          |
| Male Mice                  | 240                                     | 65                             | 63-66                            |
|                            | 120                                     | 92                             | 88-96                            |
|                            | 60                                      | 122                            | 116-128                          |
|                            | 30                                      | 272                            | 258-287                          |

TABLE X

Mortality Response of Dogs  
to the Inhalation of MMH

60 Minute

| <u>Mean Conc.</u> | <u>Range</u> | <u>Mortality*</u> |
|-------------------|--------------|-------------------|
| 92                | (83-96)      | 0/3               |
| 104               | (98-110)     | 3/3               |

30 Minute

|     |           |     |
|-----|-----------|-----|
| 180 | (155-200) | 0/2 |
| 190 | (148-200) | 1/3 |
| 200 | (170-213) | 2/2 |

15 Minute

|     |           |     |
|-----|-----------|-----|
| 380 | (350-400) | 0/2 |
| 390 | (345-410) | 1/2 |
| 400 | (345-440) | 3/5 |

\*Number Died/Number Exposed

TABLE XI

Mortality Response of Female Squirrel Monkeys  
to the Inhalation of MMH

| <u>Expt. No.</u> | <u>60 Minute</u>  |              | <u>Mortality*</u> | <u>Total Mortality*</u> |
|------------------|-------------------|--------------|-------------------|-------------------------|
|                  | <u>Mean Conc.</u> | <u>Range</u> |                   |                         |
| 201-5            | 75                | (75-80)      | 0/1               | 0/2                     |
| 201-7            | 75                | (75-80)      | 0/1               |                         |
| 201-6            | 85                | (82-85)      | 1/1               | 2/4                     |
| 201-8            | 85                | (80-85)      | 1/1               |                         |
| 201-28           | 85                | (70-95)      | 0/2               |                         |
| 201-29           | 90                | (88-92)      | 2/2               | 2/2                     |
| <u>30 Minute</u> |                   |              |                   |                         |
| 201-19           | 130               | (130-135)    | 0/1               | 0/3                     |
| 201-21           | 130               | (128-133)    | 0/2               |                         |
| 201-9            | 150               | (135-155)    | 1/1               | 2/3                     |
| 201-12           | 150               | (145-155)    | 1/1               |                         |
| 201-14           | 150               | (148-155)    | 0/1               |                         |
| 201-11           | 170               | ---          | 1/1               | 2/2                     |
| 201-13           | 170               | (155-170)    | 1/1               |                         |
| <u>15 Minute</u> |                   |              |                   |                         |
| 201-15           | 300               | (293-310)    | 0/1               | 1/4                     |
| 201-17           | 300               | (No range)   | 0/1               |                         |
| 201-26           | 300               | (292-310)    | 1/2               |                         |
| 201-16           | 340               | (296-340)    | 1/1               | 1/2                     |
| 201-18           | 340               | (340-345)    | 0/1               |                         |
| 201-20           | 376               | (350-400)    | 3/3               | 3/3                     |

\*Number Died/Number Exposed

TABLE XII

Mortality Response of Rhesus Monkeys  
to the Inhalation of MMH

| <u>ppm</u>        |              |            |                   |   |                         |
|-------------------|--------------|------------|-------------------|---|-------------------------|
| <u>Mean Conc.</u> | <u>Range</u> | <u>Sex</u> | <u>Mortality*</u> |   | <u>Total Mortality*</u> |
| 160               | (150-165)    | M          | 0/1               | } | 0/5                     |
| 160               | (145-162)    | F          | 0/2               |   |                         |
| 160               | (150-170)    | F<br>M     | 0/2               |   |                         |
| 170               | (150-175)    | M          | 1/1               | } | 2/3                     |
|                   |              | F          | 0/1               |   |                         |
| 170               | (138-180)    | M          | 1/1               |   |                         |

\*Number Died/Number Exposed

TABLE XIII  
LC<sub>50</sub> Values and 95% Confidence Limits  
for Dogs, Squirrel and Rhesus Monkeys  
Exposed to MMH

| <u>Animals<br/>and Sex</u>          | <u>Duration of<br/>Exposure (Min.)</u> | <u>LC<sub>50</sub><br/>ppm</u> | <u>Confidence<br/>Limits-ppm</u> |
|-------------------------------------|--|--------------------------------|----------------------------------|
| Beagle Dogs<br>(Male and Female)    | 60                                     | 96                             | *                                |
|                                     | 30                                     | 195                            | 174-218                          |
|                                     | 15                                     | 390                            | 377-404                          |
| Squirrel Monkeys<br>(Female)        | 60                                     | 82                             | 67-101                           |
|                                     | 30                                     | 145                            | 115-182                          |
|                                     | 15                                     | 340                            | 298-390                          |
| Rhesus Monkeys<br>(male and Female) | 60                                     | 162                            | 118-222                          |

\*Insufficient data to calculate range.

but showed intercepts on the  $LC_{50}$  axis. Calculation of the equations corresponding to these lines gave the following expressions:

1. Dogs,  $LC_{50} \times T = 5860 \text{ ppm-min.}$
2. Squirrel Monkeys,  $LC_{50} \times T = 4840 \text{ ppm-min.}$
3. Rats,  $LC_{50} = \frac{12000 \text{ ppm-min.}}{T} + 20$
4. Mice,  $LC_{50} = \frac{6400 \text{ ppm-min.}}{T} + 39$

These expressions may then be used to calculate  $LC_{50}$  values for any reasonable time-concentration range.

In addition to the  $LC_{50}$  values determined for different species, the results of these experiments provide other useful information. Variable mixing of sexes in tests conducted on rhesus monkey and dog exposure groups provided evidence that no measurable difference due to sex could be demonstrated as a result of exposure to MMH. The experiments further show that a steep dose-mortality response curve obtains for all the species tested regardless of length of exposure. A comparison of the  $LC_{50}$  values obtained during 60-minute exposures of the 5 species tested is shown in table XIV in which the species are ranked by order of their decreasing response to the acute effects of MMH. Rats were the most resistant while squirrel monkeys were found to be the most susceptible to MMH.

## RESPONSIVE SIGNS AND SYMPTOMS

The degree of symptomatic response of rats and mice appeared to be dose related. That is, as the MMH concentration was increased for each series of experiments, the number and degree of toxic signs increased from mild to severe; in the following sequence.

1. Irritation of nose and eyes.
2. Diarrhea, abnormally frequent urination and more rapid labored breathing.
3. Increased alertness; piloerection; hyperactivity, interrupted by periods of inactivity characterized by rigid posture and exophthalmos.
4. Tonic convulsions and tremors, mucous discharge from mouth and nose and frequent biting.

TABLE XIV  
Acute Toxicity Ranking  
by Species

| <u>Species</u>   | <u>60 Minute LC<sub>50</sub> (ppm)</u> |
|------------------|--|
| Squirrel Monkeys | 82                                     |
| Beagle Dogs      | 96                                     |
| Mice             | 122                                    |
| Rhesus Monkeys   | 162                                    |
| Rats             | 244                                    |



The last two categories of toxic signs occurred either during exposure or within a few hours postexposure. The rodents that developed all of the toxic signs except the convulsions survived, whereas those that convulsed died during or following exposure. The mice that succumbed to MMH usually died immediately after a single convulsive seizure.

Class 3 symptoms, as listed above, could be induced in rats by tapping the cage sharply with a metal object. These rats had been exposed to concentrations normally leading only to class 1 and class 2 signs. This induced response led to terminal (class 4) seizures in some of the affected rats. This deliberate stimulation was applied only to rats during 60-minute exposures and may account for the slightly erratic mortality pattern seen in these exposures. Certainly such susceptibility to stimulation may have led to deaths which might not have occurred otherwise. Care was taken in all other experiments to prevent this stimulation.

The general pattern of symptoms observed in dogs and monkeys was similar to that seen in rodents. However, some additional symptoms were noted in the larger animals that may have been due either to physiological or biochemical difference, or possibly to their larger size. The signs of toxicity, in the general order of occurrence during and after exposure, were as follows:

1. Eye irritation
2. Salivation and licking
3. Emesis (Occurred earliest in dogs)
4. Diarrhea, frequent urination and pupil dilation. Ataxia in dogs.
5. Hyperactivity, convulsions, tremors and cyanosis (dogs only)
6. Prostration and apparent unconsciousness.

Although the emetic response occurred later in monkeys than dogs, its severity was greater and it reoccurred frequently. The more severe response of dogs to MMH in comparison to both monkey species was noticeable not only in the early postexposure mortality (within 2 hours), but in the rapid onset of symptoms. Convulsions produced in dogs during MMH exposure were not as rapid as in either squirrel or rhesus monkeys.

Postexposure recovery of surviving dogs was fairly rapid compared to monkeys. There were fewer episodes of convulsive seizures and emesis in dogs (none after 6 hours postexposure), whereas these overt signs of toxicity

were seen in rhesus and squirrel monkeys as late as 10 and 24 hours after exposure, respectively. Emesis in monkeys, more persistent in duration than in dogs, occurred with such frequency and severity that survival in many cases was unexpected, particularly in the squirrel monkeys. Convulsions in large animals did not lead inevitably to death since some dogs as well as monkeys were able to withstand the stress and survive until completion of the post-exposure observation period. The severity and number of convulsions produced in each animal appeared to be dose related. Although no attempt was made to quantitate this dose-response relationship, dogs exposed to mean concentrations of 92 and 180 ppm MMH for 60 and 30 minutes exhibited no convulsions, while higher doses invariably produced convulsions. Postexposure convulsions were produced in squirrel monkeys at all dose levels but the frequency of episodes was most numerous at the highest MMH levels tested.

Although only one exposure time was investigated using rhesus monkeys, the greater number of convulsions occurred after exposure to the highest dose level. Both primate species suffered more convulsive seizures than dogs, paralleling a delayed recovery in these species relative to dogs. Further evidence of the faster recovery of dogs was seen in the eating and drinking behavior in both species. Dogs were drinking and sometimes eating as early as 8 hours postexposure, with normal patterns returning no later than 24 hours, while the rhesus monkeys made no attempt to eat or drink for at least 12 hours. Food and water consumption returned to normal in rhesus monkeys between 48 and 72 hours postexposure.

Gross evidence of renal and intestinal damage was seen in two dogs exposed to MMH when blood was observed in their urine and feces on more than one occasion after exposure. One dog had been exposed to 92 ppm MMH for 60 minutes, the other to 180 ppm for 30 minutes.

## CLINICAL DETERMINATIONS

### Body Weight

Rats surviving MMH exposures lost weight or showed subnormal gain on the first and second days after exposure. As mentioned previously, no weights were recorded at one and two days postexposure for the rats exposed for 240 minutes. Near normal gains occurred in all of the survivors on the third day, and growth rates had returned to normal by the fourteenth post-exposure day except for animals exposed to the highest dose levels where subnormal gains were noted. In many cases at the lower concentrations of each series, the exposed rats gained significantly more weight than the controls.

At 1-day postexposure, mouse survivors showed mean weight losses of 10-15%. A trend to weight recovery was observed in most of the groups at

the second and third postexposure weighings. A comparison of the third- and seventh-day weights evidenced a sharp increase in body weight during this time period for the majority of the survivor groups. Examination of weights taken 14 days after exposure showed that the mice had made up all losses and were essentially identical to controls.

## Hematology

Of the various blood parameters selected to monitor possible effects of MMH on dogs and rhesus monkeys, only the hematologic factors reflected positive evidence of deleterious change. Comparison of hematocrit, hemoglobin, red blood cell and reticulocyte values obtained from blood samples taken before, immediately after, and twice weekly postexposure from surviving dogs and rhesus monkeys clearly indicated red blood cell hemolysis induced by exposure to MMH. Moderate to severe anemia occurred in all surviving dogs, while mild to moderate hemolytic effects were produced in all rhesus monkey survivors. Decreasing hematocrit and increasing reticulocyte values were the obvious indications of this reaction in rhesus monkeys, while pronounced changes in all four hematologic determinations occurred in dogs.

Figure 9 is a graph of the hematocrit, hemoglobin, red blood cell and reticulocyte values for three dogs that survived a 60-minute exposure to 92 ppm. As shown on the graph, the hematocrit, hemoglobin and red blood cell values from blood samples taken immediately postexposure were slightly elevated. This elevation may have resulted from mild dehydration due to emesis rather than any specific effect of MMH. These values were markedly reduced 3 days postexposure while reticulocyte counts showed a modest rise. A rapid compensatory rise is seen in reticulocytes by the seventh day, at which time the other 3 determinations had fallen to the lowest values recorded for the entire observation period. By 10 days, reticulocyte counts reached their maximum value and the hematocrit and hemoglobin values had begun to increase slightly. Reticulocytes declined rapidly thereafter, evidenced by measurements made on the 17th day, and returned to near normal levels by the 24th day. The hematocrit and hemoglobin values show a gradual rise approaching preexposure levels 9 weeks later. The red cell counts fluctuated during recovery without reaching the preexposure value by the time the experiment was terminated.

A graph of the same four hematology determinations made on one female rhesus monkey that survived a 60-minute exposure to 170 ppm is shown in figure 10. The moderate decline of hemoglobin and red blood cell values and particularly the sharp drop in the hematocrit level 14 days postexposure, as well as the characteristic rise in reticulocytes between the 14th and 7th days presents evidence that the hemolytic response does occur in

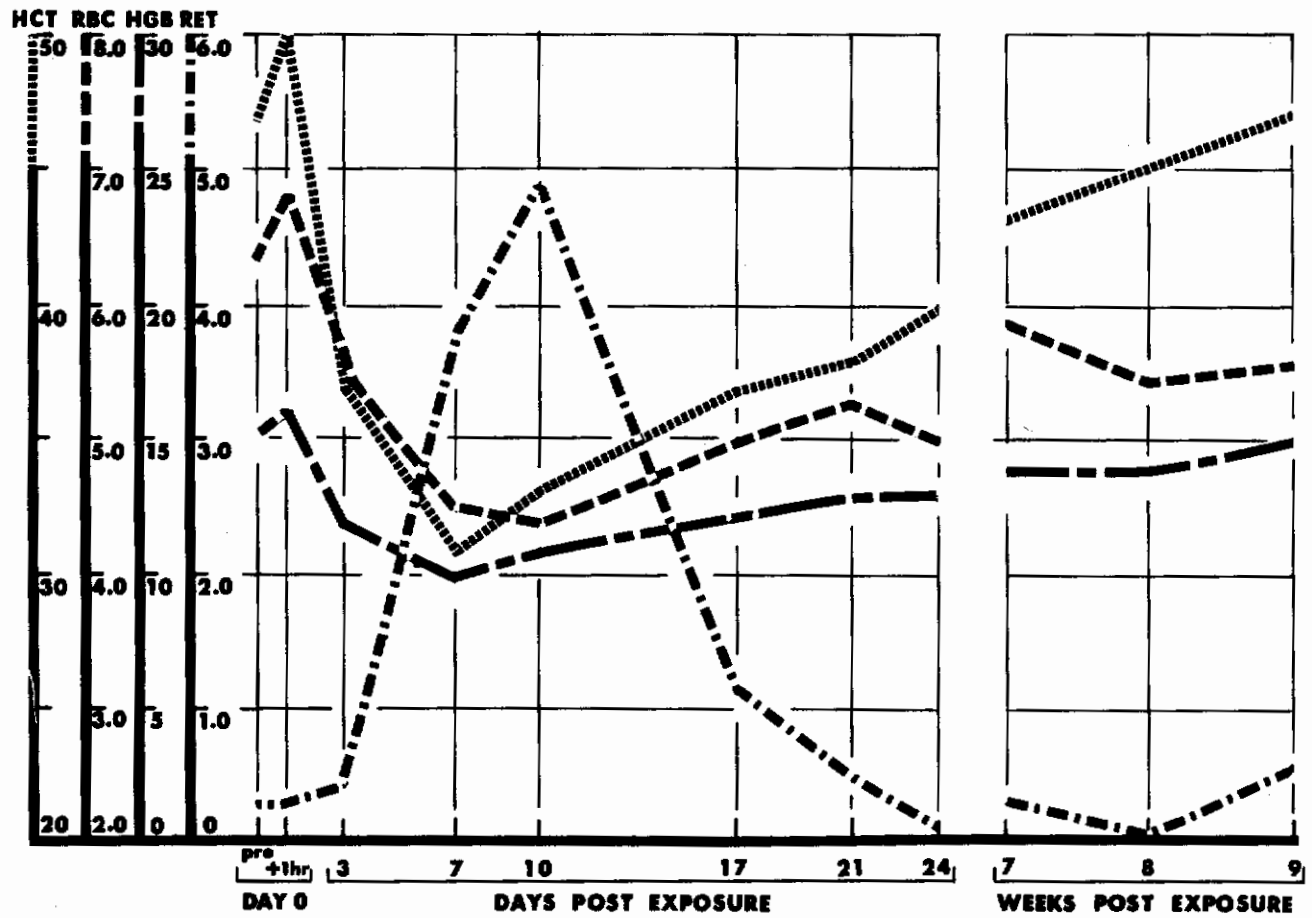

Figure 9. Hemolytic Response in Dogs that Survived a 60-Minute Exposure to 92 ppm MMH. Plotted values are arithmetic means.

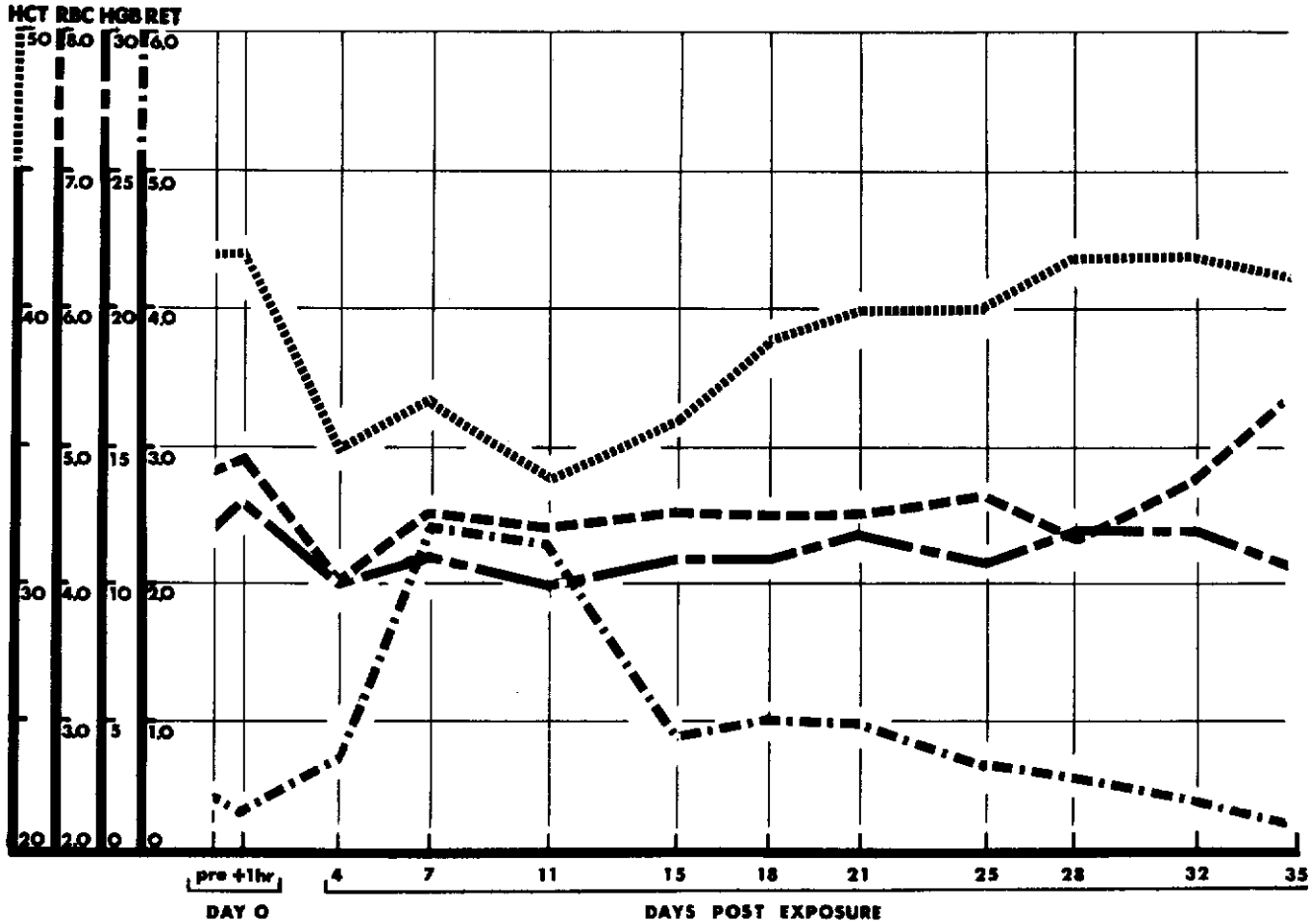

Figure 10. Hemolytic Response in One Female Rhesus Monkey that Survived a 60-Minute Exposure to 170 ppm MMH.

rhesus monkeys also as a result of exposure to MMH. Other monkeys showed milder responses. Recovery appears to be complete 35 days later, when the last blood samples were taken.

Manifestations of cyanosis observed in dogs, alluded to previously, suggested the possibility of methemoglobin formation. During convulsive seizures, the tongues of the exposed animals were blue to dark purple in color, while mucous membranes appeared dusty brown. The color of blood samples taken immediately postexposure from those dogs that survived the higher dose levels of MMH was rusty brown rather than the characteristic dark-red color of normal venous blood.

Methemoglobinemia has been produced in anesthetized dogs 1 hour after intravenous injection of MMH (reference 16). Jandl et al (reference 17) present a theoretical model for the production of methemoglobin by aromatic compounds having N-N groupings. Since no analyses for methemoglobin were performed on our test dogs, no definite conclusion can be drawn concerning its presence. However, it is plausible that cyanosis was the result of a combination of the following factors: (1) Involuntary respiratory arrest during repeated and sustained convulsive episodes resulting in oxygen depletion; (2) Accumulation of fluids in the respiratory passages interfering with respiration and oxygen transport; (3) Transformation of normal hemoglobin into methemoglobin.

## PATHOLOGY

The pathologic evaluation of tissues from animals exposed to lethal or near lethal concentrations of MMH is not complete. However, preliminary information on dogs, rats, and squirrel monkeys can be summarized at this time. A common finding in all species following lethal exposures to MMH was pulmonary congestion with some hemorrhage, hepatic congestion of varying degree, and swelling of the renal tubular epithelium which was frequently glassine and eosinophilic in appearance. In large animals whose brain tissues were examined, subarachnoid hemorrhage was frequently observed. This response was probably related to the severe convulsions observed as was the consistent finding in dogs of remarkably bloodless spleens in which the sinusoids were virtually empty. In some cases, the splenic smooth muscle bundles appeared thickened and contracted.

The amount of visceral congestion and hemorrhage observed was not sufficient to produce death which could only be attributed to CNS damage as previously reported by Jacobson et al (reference 5).

In animals that survived near lethal exposures to MMH and were killed over a period of approximately 60 days postexposure, the visceral congestion was still apparent although not as severe as in those animals that died during exposure. The most common and persistent finding, however, was renal damage which ranged from mild swelling of the tubular epithelium to vacuolization and coagulative necrosis of those epithelial cells.

## Repeated Exposures

A group of three rhesus monkeys were subjected to repeated inhalation exposures at a 160 ppm concentration of MMH at weekly intervals for 4 weeks during which time the exposed animals appeared to be developing tolerance to its effects. Initial exposures resulted in emesis and convulsions which were delayed and increasingly less severe in subsequent exposures. The test animals were again exposed on the fifth week to an MMH concentration of 170 ppm, a 10 ppm increase, and at this time two additional rhesus monkeys were included in the exposure group. The original three animals demonstrated only mild CNS responses while the two previously unexposed monkeys exhibited severe CNS changes including convulsions during which one animal died. After a 1-month rest period, two of the original group of three rhesus monkeys received a sixth MMH exposure; this time to a 180 ppm concentration, again with only mild CNS responses. While conclusive evidence of MMH tolerance was not demonstrated, there is some evidence that adaptation of these monkeys had occurred. Hematologic studies of these animals revealed mild to moderate erythrocyte hemolysis (approximately 10%) with rapid recovery.

SECTION V

CONCLUSIONS

In terms of mortality, squirrel monkeys proved to be the most sensitive and rats the least sensitive to the lethal effects of MMH. The descending order of sensitivity found in comparable experiments was squirrel monkeys, dogs, mice, rhesus monkeys, and finally rats. Signs of toxicity occurred earlier in dogs and rodents than in monkeys. The symptoms of MMH intoxication were irritation, emesis (seen only in large animals), ataxia and convulsions, which did not always prove fatal. Indicative of the pronounced acute effects of MMH was the time pattern of postexposure mortality. Rodents and dogs exposed to lethal MMH concentrations died within a few hours, while monkeys survived for a longer period. Weight losses seen in surviving rodents were recovered and the exposed animals were not significantly different from their unexposed controls after 14 days.

MMH has been shown to be an active hemolytic agent most notably in dogs and to a lesser extent in rhesus monkeys. This effect was temporary, however, with blood values returning to normal ranges within a few weeks postexposure.

The results of these acute inhalation experiments classify MMH as a highly toxic compound. The toxicity information and experience gained in these investigations was used in planning further studies, currently in progress, to determine the level at which MMH produces no irreversible injury.



REFERENCES

1. Rinehart, W. E., E. Donati, and E. A. Greene, "The Sub-Acute and Chronic Toxicity of 1, 1-Dimethylhydrazine Vapor," Amer. Ind. Hyg. Asso. J., 21, 207, 1960.
2. Weeks, M. H., G. C. Maxey, M. E. Sicks, and E. A. Greene, "Vapor Toxicity of UDMH in Rats and Dogs from Short Exposures," Amer Ind. Hyg. Asso. J., 24, 137, 1963.
3. Comstock, C. C., L. Lawson, E. A. Greene, F. W. Oberst, "Inhalation Toxicity of Hydrazine Vapor," A.M.A. Arch. Indust. Hyg., 10, 476, 1954.
4. Shook, B. S., Sr., and O. H. Cowart, "Health Hazards Associated with Unsymmetrical Dimethylhydrazine," Ind. Med. Surg., 26, 333, 1957.
5. Jacobson, K. H., J. H. Clem, H. J. Wheelwright, Jr., W. E. Rinehart, and N. Mayes, "The Vapor Toxicity of Methylated Hydrazine Derivatives," A.M.A. Arch. Ind. Health, 12, 609, 1955.
6. Smyth, H. F., Jr., "Military and Space Short-Term Inhalation Standards," A.M.A. Arch. Environ. Health, 12, 488, 1966.
7. Monomethyl Hydrazine Handling and Storage, Product Data Guide of Chemicals Division, Olin Matheson Co., Hydrazine Products Division, September, 1965.
8. Watt, G. W., and J. P. Chrisp, "A Spectrophotometric Method for the Determination of Hydrazine," Anal. Chem., 24, 2006, 1952.
9. Vernot, E. H. J. D. MacEwen, D. L. Geiger, and C. C. Haun, "The Air Oxidation of Monomethyl Hydrazine," Amer. Ind. Hyg. Asso. J., 28, 343, 1967.
10. Dixon, W. J., BMD: Biomedical Computer Programs, Health Science Computing Facility, Department of Preventive Medicine and Public Health, School of Medicine, UCLA, September, 1965.
11. Thompson, W. R., "Use of Moving Averages and Interpolation to Estimate Median Effective Dose," Bact. Rev., 11, 115, 1947.

# Contrails

12. Carpenter, C. P., H. F. Smyth, Jr., and U. C. Pozzani, "The Assay of Acute Vapor Toxicity, and the Grading and Interpretation of Results on 96 Chemical Compounds," J. Ind. Hyg. and Toxicol., 31, 343, 1949.
13. Leach, L. J., C. J. Spiegl, R. H. Wilson, G. E. Sylvester, and K. E. Lauterbach, "A Multiple Chamber Exposure Unit Designed for Chronic Inhalation Studies," Amer. Ind. Hyg. Asso. J., 20, 13, 1959.
14. MacEwen, J. D., Toxic Hazards Research Unit Design and Construction Phase, AMRL-TR-65-125, September, 1965, Aerospace Medical Research Laboratories, Wright-Patterson Air Force Base, Ohio.
15. Geiger, D. L., "Approaches to Continuous Analysis of Exposure Chamber Atmospheres," Proceedings of the Third Annual Conference on Atmospheric Contamination in Confined Spaces, 263, AMRL-TR-67-200, Aerospace Medical Research Laboratories, Wright-Patterson Air Force Base, Ohio, December, 1967.
16. Fortney, S. R., and D. A. Clark, "Effect of Monomethylhydrazine on Methemoglobin Production in Vitro and in Vivo," Aerospace Medicine, 38, 239, 1967.
17. Jandl, J. H., L. K. Engle, and D. W. Allen, "Oxidative Hemolysis and Precipitation of Hemoglobin," J. Clin. Invest., 39, 1818, 1960.

Security Classification

**DOCUMENT CONTROL DATA - R & D**

*(Security classification of title, body of abstract and indexing annotation must be entered when the overall report is classified)*

|   |  |   |                              |
|---|--|---|------------------------------|
| <b>1. ORIGINATING ACTIVITY (Corporate author)</b><br>Systemed Corporation<br>Overlook Branch, P. O. Box 3067<br>Dayton, Ohio 45431  |  | <b>2a. REPORT SECURITY CLASSIFICATION</b><br>UNCLASSIFIED   |                              |
|   |  | <b>2b. GROUP</b><br>N/A   |                              |
| <b>3. REPORT TITLE</b><br><br>THE ACUTE INHALATION TOXICITY OF MONOMETHYLHYDRAZINE VAPOR  |  |   |                              |
| <b>4. DESCRIPTIVE NOTES (Type of report and inclusive dates)</b><br>February 1966-November 1967   |  |   |                              |
| <b>5. AUTHOR(S) (First name, middle initial, last name)</b><br><br>C. C. Haun, J. D. MacEwen, Ph. D., E. H. Vernot, G. F. Egan  |  |   |                              |
| <b>6. REPORT DATE</b><br>April 1969   |  | <b>7a. TOTAL NO. OF PAGES</b><br>42   | <b>7b. NO. OF REFS</b><br>17 |
| <b>8a. CONTRACT OR GRANT NO.</b> F33615-67-C-1025   |  | <b>9a. ORIGINATOR'S REPORT NUMBER(S)</b><br><br>Systemed Report No. W68003  |                              |
| <b>b. PROJECT NO.</b> 6302  |  | <b>9b. OTHER REPORT NO(S) (Any other numbers that may be assigned this report)</b><br><br>AMRL-TR-68-169  |                              |
| <b>c. Task No.</b> 630201   |  |   |                              |
| <b>d. Work Unit No.</b> 630201008   |  |   |                              |
| <b>10. DISTRIBUTION STATEMENT</b><br><br>This document has been approved for public release and sale; its distribution is unlimited.  |  |   |                              |
| <b>11. SUPPLEMENTARY NOTES</b>  |  | <b>12. SPONSORING MILITARY ACTIVITY</b><br>Aerospace Medical Research Laboratory,<br>Aerospace Medical Div., Air Force Systems<br>Command, Wright-Patterson AFB, OH 45433 |                              |
| <b>13. ABSTRACT</b><br>The lack of adequate data and the increased use of monomethylhydrazine (MMH), a rocket propellant, prompted additional studies of the acute inhalation toxicity of this compound. The reactive nature of MMH necessitated the use of modified test systems designed to minimize the degradation of MMH during animal exposures. Rats, mice, beagle dogs, squirrel monkeys, and rhesus monkeys were exposed to various measured concentrations of MMH vapor for specified time periods. Rodents were exposed for 30-, 60-, 120-, and 240-minute periods; dogs and squirrel monkeys, for 15, 30, and 60 minutes; and rhesus monkeys for 60 minutes only. The toxicity of MMH for the five animal species was defined by determinations of LC50 values, pathology examination of organs, observations of symptoms, measurements of body weight in rats and mice, and blood chemistry and hematology tests on dogs and rhesus monkeys. Squirrel monkeys proved to be the most sensitive and rats the least sensitive to the lethal effects of MMH. MMH exposure produced definite hemolytic changes in dogs and, to a lesser extent, in rhesus monkeys. These experiments show MMH to be a highly toxic compound. Studies are currently in progress to determine the level at which MMH produces no irreversible injury. |  |   |                              |

**DD FORM 1473**  
1 NOV 65

Security Classification

| 14. KEY WORDS  | LINK A |    | LINK B |    | LINK C |    |
|--|--------|----|--------|----|--------|----|
|  | ROLE   | WT | ROLE   | WT | ROLE   | WT |
| Monomethylhydrazine (MMH)<br>Inhalation toxicology<br>Exposure chambers<br>Pathology<br>Clinical chemistry<br>Hematology<br>Rodents<br>Dogs<br>Monkeys |        |    |        |    |        |    |