

WADC TECHNICAL REPORT 52-102

DEVELOPMENT OF TEST METHODS FOR ANTISEIZE COMPOUNDS

*John W. Cunningham
Southwest Research Institute*

September 1952

*Materials Laboratory
Contract No. AF 33(038)-22805
RDO No. 601-299*

**Wright Air Development Center
Air Research and Development Command
United States Air Force
Wright-Patterson Air Force Base, Ohio**

McGregor & Werner, Inc., Wakefield, Mass.
Dec. 5, 1952 150

FOREWORD

This investigation was conducted by Southwest Research Institute under Contract No. AF 33(038)-22805 which is further identified by Research and Development Order No. 601-299, "Aircraft Lubricating Greases". The official authorization applied only to Steps I, II, V, and VI of the Institute's original proposal, dated 3 February 1951 (PR 92949). Steps III, IV, and VII were omitted with the understanding that further work would be considered for authorization at a later date. The authorized steps were selected because they included a phase of the investigation which would have utility even if the project were not extended. Work on this phase was completed during the period from 9 April 1951 to 8 April 1952. Additional work has since been authorized under Supplemental Agreement No. S-1 (52-187). The extension is based on a new proposal submitted by the Institute on 21 March 1952 (PR 282181).

The greater part of the completed phase of the project was conducted by the Chemical Engineering Department of Southwest Research Institute under the direction of the Department Chairman, Dr. J. S. Swearingen. On 1 February 1952, an organizational change occurred and the project was continued by the new Chemistry and Chemical Engineering Department under the general direction of the Associate Director of the Institute, Dr. Louis Koenig. The author is indebted to both for their helpful advice and guidance and also for specific technical contributions.

Others who cooperated in the study were: Mr. F. Dashek-literature survey; Mr. J. D. Millar-preliminary experimental work; Mr. W. A. Moore-test analysis and specimen design; and Mr. H. E. Metcalf-machine design. The basic principle of the test methods (torque vs. rotation as a quantitative measure of galling) was first observed and recognized by Mr. Millar. Dr. Swearingen conceived the original test machine including the mechanism for recording torque vs. rotation. The use of tapered pins as specimens was first suggested by Mr. Moore.

Technical liaison with the Air Force was maintained through project engineers Mr. Bernard Rubin and 2nd Lt. H. C. Markle of the Materials Laboratory, Directorate of Research, Wright Air Development Center. Their aid and cooperation was a tangible benefit to the progress of the work.

WADC TR 52-102

Contrails

ABSTRACT

The seizure of threaded connections and other tight fits was found to result from galling of the contacting surfaces. A quantitative method was developed for measuring the galling characteristics of standard metal surfaces under controlled conditions. Anti-seize compounds can be evaluated by observing their effect on these measured characteristics. A seizure tester was designed and constructed which automatically records galling test data and can be used for rapid routine testing. Metal specimens which are used with this machine can be (1) assembled with an anti-seize compound between the test surfaces, (2) exposed to conditions simulating specific applications, and then (3) tested for seizure. The results of seizure tests made with several commercial anti-seize compounds are included. A preliminary correlation was obtained between these testing procedures and other performance ratings. It is concluded that this basic test method can be used to evaluate anti-seize compounds for:

- (1) High temperature service (1200° - 2000°F)
- (2) Aircraft oxygen system service
- (3) Liquid oxygen system service
- (4) Similar specific applications.

PUBLICATION REVIEW

Manuscript Copy of this report has been reviewed and found satisfactory for publication.

FOR THE COMMANDING GENERAL:

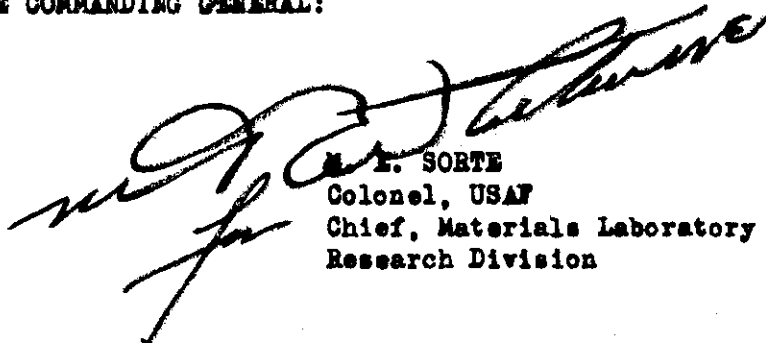

M. E. SORTE
Colonel, USAF
Chief, Materials Laboratory
Research Division

Contrails

TABLE OF CONTENTS

	<u>Page</u>
SECTION I - Basic Preliminary Investigation	1
SECTION II - Development of Testing Equipment	6
SECTION III - Seizure Tester, Model II	36
SECTION IV - Correlation of Test Results With Other Performance Ratings	62
SECTION V - Summary and Conclusions	70
BIBLIOGRAPHY	75

Contrails

LIST OF ILLUSTRATIONS

	<u>Page</u>
<u>FIGURE</u>	
1. Damage to Threads Due to Metal Seizure	3
2. Schematic of Seizure Tester, Model I	9
3. Seizure Tester, Model I	10
4. Sheet Metal Specimens and Holding Jaws	12
5. Galled Surface of Copper Sheet After Seizure Test	15
6. Typical Chart Record of Seizure Test	16
7. Typical Chart Record of Seizure Test	17
8. Tapered Pin Specimen and Holding Jaws	20
9. Taper Pin and Block Test Specimens	22
10. Results of a Seizure Test Indicating a Completely Ineffective Anti-Seize Compound	27
11. Results of a Seizure Test Indicating the Limited Effectiveness of a Compound	28
12. Results of a Seizure Test Indicating an Effective Anti-Seize Compound	29
13. Tapered Pin Seizure Tests	30
14. Tapered Pin Seizure Tests	31
15. Tapered Pin Seizure Tests	32
16. Tapered Pin Seizure Tests	33

Contents

	<u>Page</u>
17. Schematic of Seizure Tester, Model II	38
18. Seizure Tester, Model II, Full View	39
19. Seizure Tester, Model II, Drive and Clutch Detail .	40
20. Seizure Tester, Model II, Specimen Holding and Torque Recording Details	41
21. Galled Surfaces of Tapered Pin and Block Specimen After Seizure Test	46
22. Seizure Test Chart	49
23. Seizure Test Chart	50
24. Seizure Test Chart	51
25. Seizure Test Chart	52
26. Seizure Test Chart	53
27. Seizure Test Chart	54
28. Seizure Test Chart	55
29. Seizure Test Chart	56
30. Seizure Test Chart	57
31. Seizure Test Chart	58
32. Wrenches and Specimens Used for Simulated Performance Test	64

TABLES

I. Test Results	25
II. Seizure Test Data	59
III. Maximum Torque Required to Disassemble Stain- less Steel Bolts and Nuts	65
IV. Maximum Torque Required to Disassemble Alum- inum Tubing Fittings	68
V. Maximum Torque Required to Disassemble Pipe Fittings	69
VI. Preliminary Correlation of Test Methods	71

Contrails

INTRODUCTION

One of the major functions of thread compounds and anti-seize compounds in general is to prevent the seizure of threaded connections and other tight fits between metallic surfaces. Seizure, in this case, can be defined as a condition, which results in mechanical failure or excessive surface damage to the component parts when disassembly of a tight fit is attempted. Relative motion between the parts is resisted by a force exceeding the strength of the materials from which they are constructed.

The most familiar compounds of this nature in use today are:

- (1) White lead and oil mixtures - for general purpose uses where exposure is limited to room temperature conditions
- (2) Graphite and oil mixtures - especially suitable for applications exposed to relatively high temperatures (in the neighborhood of 750°F.).

The use of such compounds helps to maintain a tightly sealed joint and to facilitate the assembly, disassembly, and reassembly of mechanical equipment by preventing seizure and the resulting damage to component parts.

New design trends for Air Force material and equipment indicate that for certain applications, especially those relating to jet engines and rocket powered missiles, the operating temperatures of some components will be in the 1200°F. to 2000°F. range. It has also been reported that the anti-seize compound specified for oxygen systems is not always satisfactory, especially when applied to liquid oxygen piping from one inch to six inches in diameter. These are all very severe operating conditions for anti-seize compounds, and none of the compounds presently specified by the Air Force function satisfactorily for these applications. Materials are available from various manufacturers which are claimed to be satisfactory as anti-seize compounds under these particular conditions, but there are no satisfactory simulated performance tests by which these materials or other newly developed materials can be evaluated. All of the foregoing factors have indicated the need for additional research and development work in the field of anti-seize compounds including new test methods by which to evaluate them.

Contrails

Previous to this investigation, the test methods used to evaluate anti-seize compounds have been highly empirical in nature. For example, a thread compound would be applied to a large number of threaded connections which would be tightened to a definite torque value. These test assemblies would then be subjected to actual or simulated use conditions after which the torque required to loosen the connections would be measured and the condition of the test surfaces would be inspected for possible damage. A statistical analysis of the resulting data provides a basis for judging the relative merit of each compound tested. Although this type of test seems to be reasonably effective, it is lengthy, expensive, requires a large amount of expendable materials, and extensive facilities for particular test conditions. Threshold conditions are seldom approached; consequently, the results apply only to the specific test specimens at specific test conditions. In addition, the results are often non-conclusive.

The anti-seize compounds currently used by the Air Force are specified for purchase on a composition basis. It is highly desirable that test methods be developed that will enable such specifications to be based solely on performance ratings. Such methods would make possible evaluation of the relative effectiveness of various compositions and also foster the development of new and improved compositions by private manufacturers.

The broad object of the investigation covered by this report is to develop suitable test methods by which the satisfactory performance limits of anti-seize compounds can be predicted for the wide variety of applications in which they may be used by the Air Force. Work completed during the past year on this project was directed toward the following specific objectives:

- (1) Development of test methods for the evaluation of materials used as thread and anti-seize compounds in the temperature range of 1200°F. to 2000°F.
- (2) Development of test methods for the evaluation of materials used as thread and anti-seize compounds in aircraft oxygen systems and in the liquid oxygen systems of missiles, especially those having piping from one inch to six inches in diameter.

It is understood that present specifications covering such secondary factors as sealing properties, non-corrosiveness, and oxygen safety requirements are adequate and that the failure of currently specified materials has been due to unsatisfactory anti-seize properties.

SECTION I

BASIC PRELIMINARY INVESTIGATION

Literature Survey

The first step in our investigation of seizure, anti-seize compounds, and methods of testing these compounds was to make a survey of the published technical literature. This survey included such general subjects as lubrication and lubricants, friction and wear, deformation and rupture of metals, effect of oxidation and high temperatures on physical properties of metals, and other related factors as well as specific references to seizure. Scientific and engineering journals, abstracts, indices, and reviews published during the past ten years and more were carefully checked for pertinent information and additional references.

As a result of this survey, a list of references was compiled on cards with a brief abstract covering the significant features of each publication. This list was referred to and brought up to date from time to time during the course of the investigation. The most applicable references have been selected from this list and included at the end of this report as a bibliography.

Our literature survey revealed a large amount of information on metallic materials and their properties under severe exposure conditions, lubricants and lubrication, and friction and wear. In addition, some information was found on seizure; however, the largest portion of this was concerned with relatively high velocity conditions such as those found in bearings. A few patents were found dealing with anti-seize compounds, but published information on the specific subjects in which we are interested is noticeably lacking.

In general, the survey was of great value in helping the investigators to understand the nature of the problems, but of little use in formulating a practical approach.

Exploratory Experimental Work

Preliminary laboratory work was conducted in parallel with the literature survey for the specific purpose of familiarizing the investigators with the mechanics of seizure and with the type of damage resulting from the seizure of threaded connections and other tight fits in mechanical equipment. During this work emphasis was given to observations which would help determine the specific causes of seizure and methods by which seizing tendency could be measured.

A simple specimen was designed so as to insure positive seizure of a threaded connection after exposure to relatively high temperature conditions. This type of specimen consisted of a carbon steel rod, the cross-sectional area of which was substantially reduced at the ends and threaded so that applied stresses would be higher in the threaded portion than in the body of the bolt. A sleeve of 18-8 stainless steel was made to slip over the body of this bolt and to be held under compression by carbon steel nuts on the threaded sections at each end of the bolt. The cross-sectional area of the sleeve was reduced so as to be comparable with that of the root of the threads. Since the thermal coefficient of expansion is higher for the stainless steel than for carbon steel, an extremely high stress was applied to the threads when such a specimen assembly was heated.

Ten of these specimen assemblies were made and exposed at temperatures from 850°F. to 1000°F. in a muffle furnace for various time intervals from three to twenty hours. All of the tests made with these specimens resulted in seizure of the threaded sections upon attempted disassembly.

The use of this simple device produced good examples of the difficulties encountered in practice with mechanical equipment designed to operate at high temperatures. The materials under stress can creep or flow to some extent at these temperatures so that irregularities in the contacting surfaces will form an intimate fit. After cooling, the intermeshing irregularities must disengage without progressive deformation of the surfaces before disassembly is possible. It is this disengagement that is facilitated by the use of anti-seize compounds on the surfaces before assembly and subsequent heating. In some cases, the application of excessive stresses can produce this condition without heat. Figure 1 illustrates the extent of surface deformation resulting from seizure of the threaded test specimens described above.

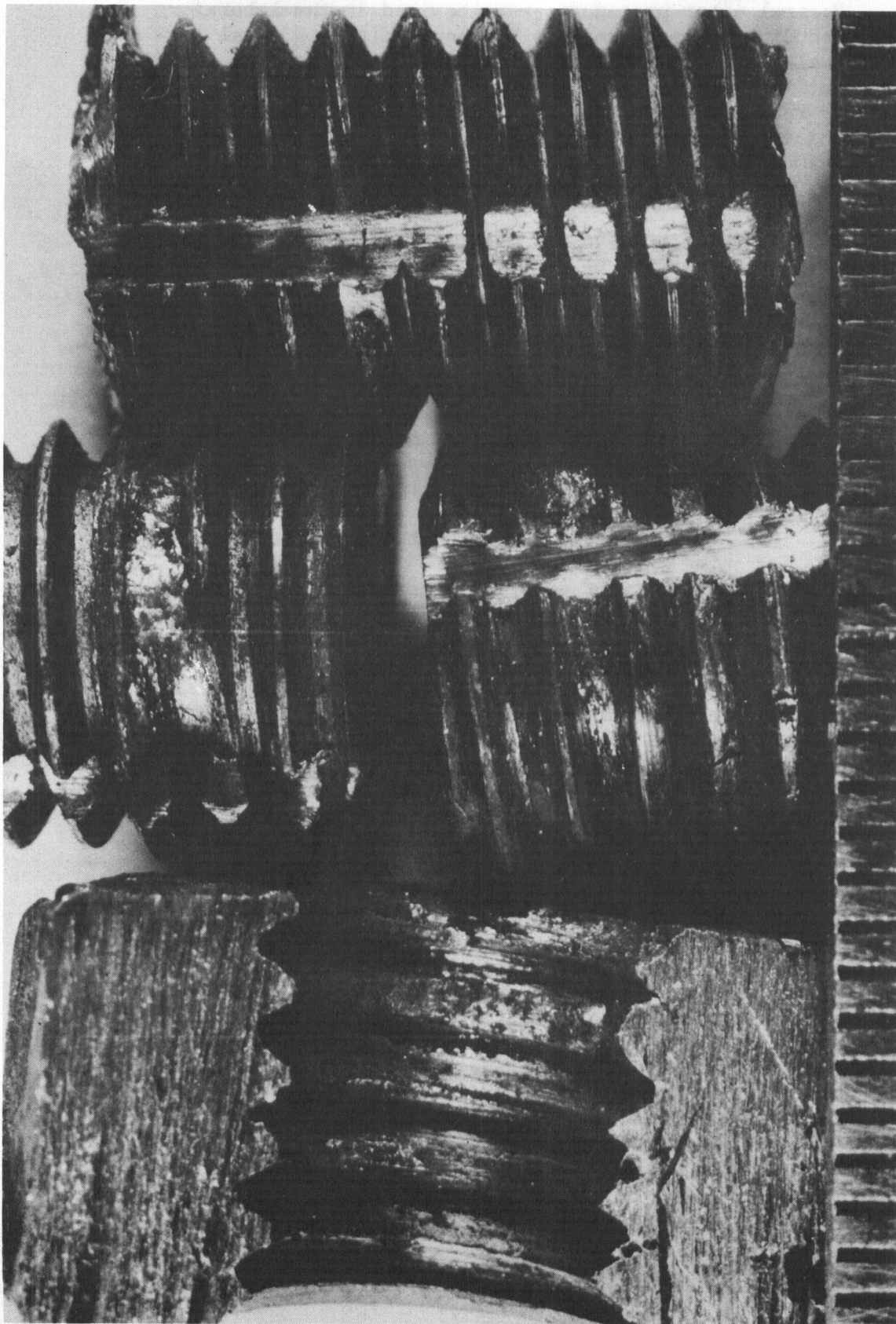

FIGURE 1. Damage to Threads Due to Metal Seizure (Magnification 11.5X)

Contrails

Several other procedures were devised in the laboratory for producing a forced seizure between contacting metal surfaces, always with the thought in mind of finding some sort of quantitative measurement of surface damage. These procedures resulted in seizure at normal room temperature in contrast to the first method which required exposure to heat. Copper and aluminum were used for most of these trials because of the known susceptibility of these metals to seizure.

The following methods for quantitatively measuring the seizure characteristics of metal surfaces were suggested by the literature survey and by individual staff members of the laboratory. These were evaluated for relative merit on the basis of accuracy and simplicity.

- (1) Light reflection measurements
- (2) Depth of scar measurements
- (3) Torque measurements on threaded bolts under stress
- (4) Coefficient of friction by inclined plane tests
- (5) Electrical conductance through contacting surfaces
- (6) Quantity of material transferred from opposing surfaces by radioactive tracer techniques.

While exploring the practical aspects of the above possibilities, a temporary device was improvised by which the surfaces of two metal blocks in intimate contact could be rotated with respect to each other. This action produced surface deformation resulting in seizure. An extremely important observation made during tests with this device was that when one surface was rotated relative to the other, the torque required for the rotation progressively increased until seizure occurred. An initial torque was required due to the friction between the contacting surfaces, but the increase in torque seemed to be a direct indication of the extent of the surface damage. It is believed that here was found a suitable index for seizing tendency and therefore a sound basis for the development of practical test methods.

Further exploratory work using this technique of rotating surfaces relative to each other under a controlled compressive load was conducted with sheet metal strips and finally sheet metal discs. The results were promising; but it was found that special equipment would be necessary in order to measure the

changes in torque which occurred during each test.

Discussion

The initial portion of this investigation consisted primarily of a study of the nature of seizure between metal surfaces and methods by which this condition is prevented. This study indicated that seizure could be caused by each of the mechanisms discussed below:

(1) Fusion or Welding of the Contacting Surfaces.

This condition would occur generally only at temperatures exceeding the maximum allowable working temperatures of the metals in question. Theories have been advanced suggesting spot welding at high points of surfaces due to intimate contact and localized friction heat. In our opinion, this mechanism is not a major factor except possibly at high velocities, such as in bearing failures.

(2) Fusion or Adhesion of a Foreign Material Between the Contacting Surfaces.

Materials of this nature could be from dirt, oil, chemical reaction products of the metals, etc. Such substances would in most cases have a strength lower than the metal surfaces and therefore would not cause any damage to the component parts even though higher torque values would be required for disassembly.

(3) Galling or Progressive Surface Damage.

This condition has been found to be a function of the work-hardening properties of metals. The intimate contact of two surfaces causes the inter-locking of minute irregularities in each surface. The relative motion between the two surfaces necessary for disassembly of a tight fit is possible only by deforming the inter-locking obstructions. Metals which work harden easily will also progressively resist such deformation. As the force is increased, minute hard spots grow in size causing the metal at the surface to "ball up" until the inter-locking obstructions are so large that disassembly is impossible without excessive damage. In our opinion, this mechanism is the major source of trouble requiring the use of anti-seize compounds. This is corroborated by difficulties experienced in the field with copper, aluminum, and the Austenitic stainless alloys, all of which work-harden readily.

The galling of metal surfaces which results in seizure at tight fits can be prevented by the application of some foreign material acting as an anti-seize compound between the contacting surfaces. This material will facilitate relative motion by preventing intimate contact or by acting as some form of lubricant.

Contrails

Any given formulation, when used as an anti-seize compound under specific conditions, will have a certain effectiveness due to its fundamental chemical and physical nature. However, this effectiveness is subject to change depending on the conditions to which it is exposed in actual use and on its inherent stability under those conditions. Anti-seize effectiveness is often reduced by service conditions capable of changing the chemical or physical nature of the compound. Some of these conditions are:

- (1) Ageing
- (2) Temperature extremes
- (3) Mechanical disruption of the protective film by abrasion, vibration, repeated assembly and disassembly, thermal or mechanical shock, etc.
- (4) Thermal decomposition
- (5) Chemical reaction with the metal surfaces, the atmosphere, or other contaminants.

Due to the nature of seizure and the basic function of anti-seize compounds, it was concluded that the effectiveness of such compounds could best be evaluated by measuring the degree to which the seizing tendency of a metal surface is reduced by use of the compound. The effectiveness of compounds designed for specific uses, such as high temperatures, could be evaluated by measuring seizing tendency after the contacting surfaces had been exposed to the specific conditions of use. In order to develop tests of this nature, it was necessary to find a reliable method for measuring the extent of galling or the susceptibility to seizure of a standard metal surface. Such a method was found in observing the changes in torque required to rotate two contacting metal surfaces with respect to each other under a controlled compressive load. Steps were then taken to design and construct equipment suitable for the accurate measurement of these torque values.

SECTION II

DEVELOPMENT OF TESTING EQUIPMENT

General Function and Design

From the results of the preliminary investigation described

Contrails

in Section I, it was determined that the most desirable means for evaluating the anti-seize compounds would require a basic test method by which the galling and seizure characteristics of metal surfaces could be defined. If possible, this galling characteristic should be expressed in numerical terms based on a measurement of the rate of galling, tendency to gall, extent of galling, or some similar related factor. The value of various compounds as anti-seize agents could then be ascertained by their effect on this measured galling characteristic of standard test surfaces.

The next step was to design and construct a suitable testing device by which the significant variables associated with the mechanism of galling could be controlled and measured. The design of this device was based on the torque variation phenomena observed during the preliminary work when two contacting surfaces were subjected to counter-rotation under a compressive load. It was believed that one or a combination of several of the following variables would provide a suitable numerical index:

- (1) Torque required for rotation
- (2) Magnitude of rotation
- (3) Magnitude of the compressive load (surface contact pressure)
- (4) Speed of rotation
- (5) Type of metal surfaces (similar and dissimilar)
- (6) Condition and finish of the contacting surfaces.

At this stage of development, it was desired that the testing device be designed as simply as possible with provisions for easy modification. It was felt that a preliminary study of the importance of each of the variables listed above was a definite prerequisite to the final design of a practical testing device, and it was expected that several modifications would be made or even different machines might be required depending on the results of the work. Fundamental requirements considered in the design were:

- (1) Size and shape of the metal test specimens
- (2) Means for mounting specimens and holding surfaces in intimate contact
- (3) Provision for the application of a compressive load for the maintenance and control of surface contact pressure
- (4) Means for rotating one specimen relative to the other and controlling the speed and magnitude of

Contrails

- rotation
- (5) Method of measuring the torque required for rotation
 - (6) Provision for the exposure of test specimen assemblies to simulated use conditions such as: high temperatures, oxygen gas, and liquid oxygen.

The fundamental requirements for this device were so complex and incompatible that many concessions had to be made in order to produce a simple and practical piece of equipment. A great amount of time and effort was required for the actual design work due to the many difficulties encountered.

The resulting testing device will be referred to as the Seizure Tester, Model I. Figure 2 is a schematic diagram of the working parts of this tester, and Figure 3 is a photograph showing the recording chart details. This testing device consists essentially of two opposing shafts located on the same horizontal axis and supported by tapered roller bearings capable of resisting both radial and thrust loads. The opposing end of each shaft is shaped so as to hold complementary test specimens during rotation. (The nature of these specimens will be discussed in detail later in this section of the report.) One shaft is connected to a torsion bar which is designed to indicate the amount of torque applied. The other shaft is fitted with a crank for manual rotation and also a spring and lever arm capable of applying a continuous thrust load on the test specimens, the maximum being 2,000 pounds. A torque recording device is mounted on the machine which will automatically plot a curve of the torque versus the magnitude of rotation on a circular chart. The recording pen is actuated by strain of the torsion bar, and the chart board is driven by a belt from the rotating crank shaft. Provisions were made for adjusting the length of the indicating pen arm. By changing the pen radius, the deflection of the torsion bar due to the application of a torque load can be compensated for. This deflection would otherwise appear on the chart as rotation of the test specimen. Standard 2 $\frac{1}{4}$ -hour x 150 degrees temperature recorder charts were used to record the torque. The torsion bar and chart drive were calibrated so that one hour on the chart was equivalent to four radians of rotation, and 150 degrees on the chart was equivalent to a torque load of 100 inch-pounds.

In operating this tester during various seizure tests, the following general procedure was used:

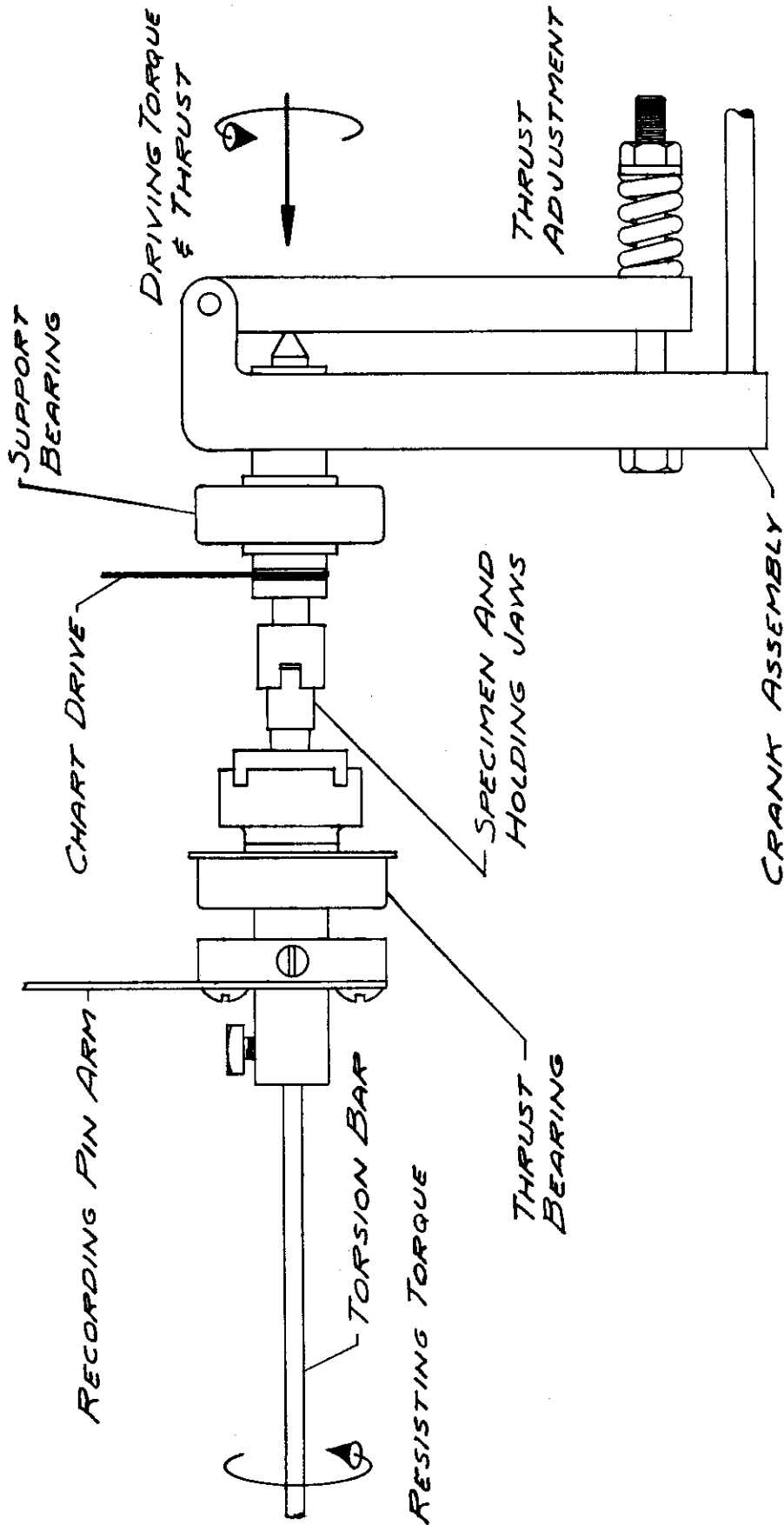

FIGURE 2
SCHEMATIC OF SEIZURE TESTER,
MODEL I

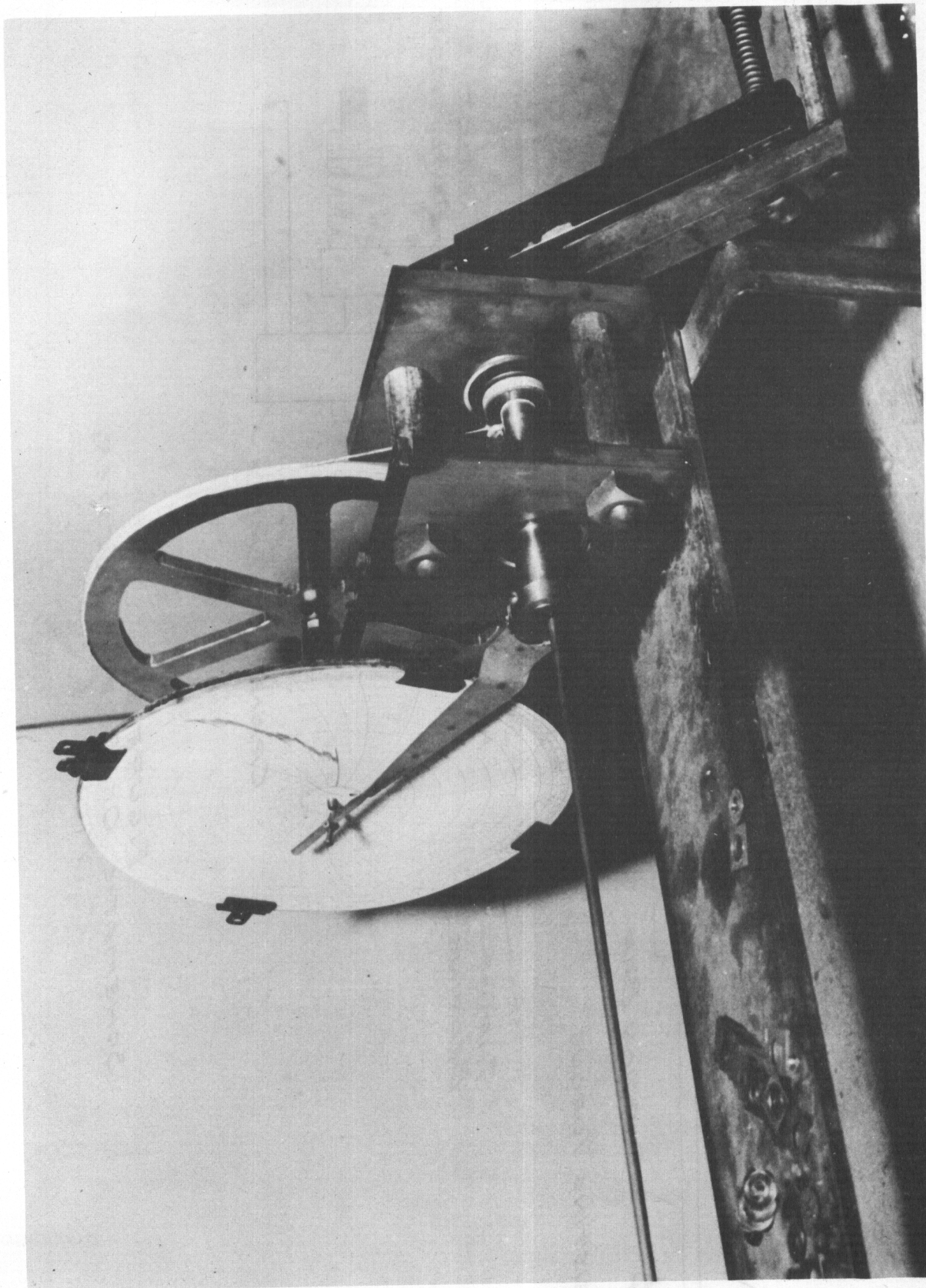

FIGURE 3. Seizure Tester Model I

Contrails

- (1) A fresh chart is mounted on the chart board and the indicator pen filled with ink and adjusted to zero.
- (2) A prepared set of test specimens is mounted on the ends of the opposing shafts.
- (3) The thrust lever arm is placed in position and the spring compression adjusted for the desired thrust load.
- (4) The crank arm is turned by hand at the desired speed for the duration of the test.
- (5) The spring load is then released and the specimens removed in order to observe the condition of the test surfaces.

During such a test, the indicator pen will continuously record the torque required for rotation versus the magnitude of the relative rotation between the contacting surfaces of the test specimens.

The Seizure Tester, Model I, was intentionally designed for simplicity and flexibility. The crank arm was made to be rotated by hand so that the effect of speed and variations in speed could be studied and understood. Although operation of this tester was awkward and time-consuming, and the accuracy of the measurements left much to be desired, it served a very worthwhile purpose in proving the soundness of the operating principles.

Sheet Metal Specimens

Selection of the proper size and shape for the specimens necessary for the seizure tests was a major problem throughout the investigation. An undamaged pair of standard surfaces was necessary for each individual test; therefore, economy and expendability were given first consideration in their design. Methods of holding and driving the specimens imposed many limitations on the design due to particular conditions of the test.

Because of the design limitations and the favorable results obtained during the preliminary work, sheet metal stampings were selected as the first choice. Matched pairs of specimens were made from .032 inch copper, aluminum, and 18-8 stainless sheet. One member consisted of a $7/8$ inch square with a $1/2$ inch round hole in the center. Its matching mate was a $3/4$ inch disc with a $1/4$ inch square hole in the center. Figure 4 is an illustration of this type of specimen and how each shape was held and driven by the seizure tester.

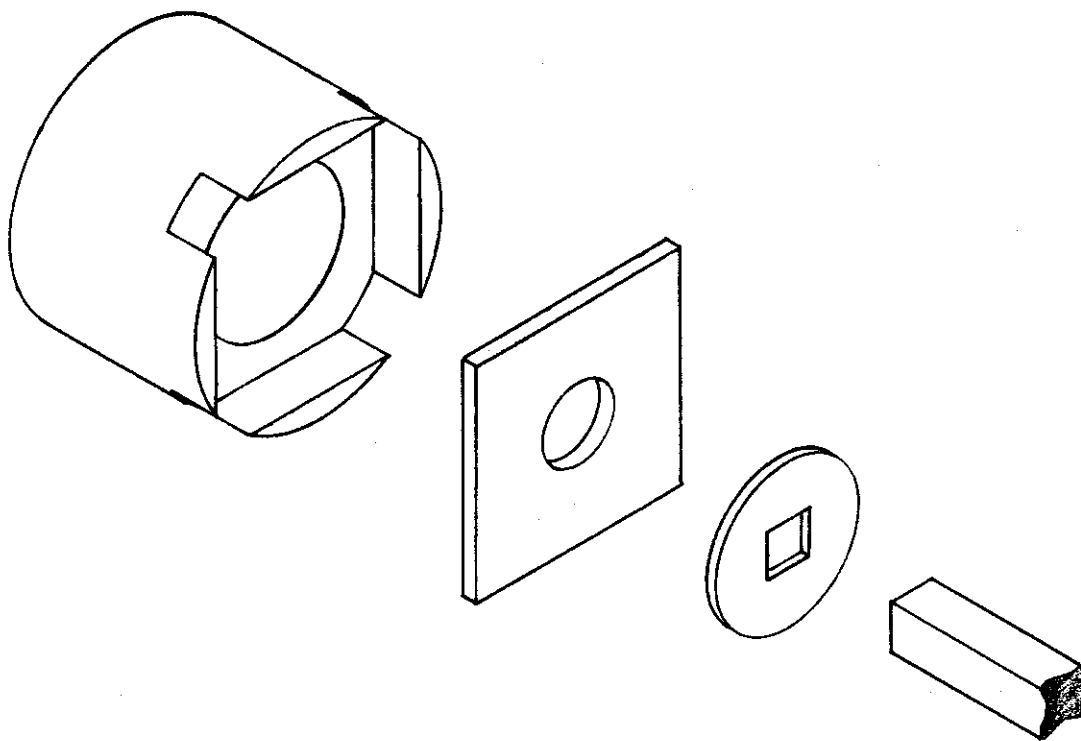

FIGURE 4
SHEET METAL SPECIMENS
AND HOLDING JAWS

Contrails

When a pair of these sheet metal specimens is mounted in operating position on the ends of the opposing shafts of the tester, an annular contact surface is formed. The nominal area of this surface is 0.25 square inches, although the actual contact area is smaller, depending on the smoothness of the contacting surfaces. These surfaces were prepared for testing by grinding flat with #550 emery paper followed by a carbon tetrachloride rinse. They were then left clean or were coated with a sample anti-seize compound, according to the purpose of each test.

During this portion of the experimental work, approximately 200 pairs of sheet metal specimens were tested with the seizure tester. The purpose of these tests was to determine the general effect of the following factors:

- (1) Surface contact pressure
- (2) Speed of rotation
- (3) Presence and absence of anti-seize compounds
- (4) Type of metal used for specimens
- (5) Surface finish of specimens
- (6) Length of test
- (7) Test procedures

It should be emphasized that these tests were purely exploratory in nature. Many variations were tried; in some cases procedures and techniques were changed in the middle of a test because of a promising indication under particular conditions. The main purpose of the series was to foster a basic understanding of the mechanism of the test and to evaluate its possibilities for the quantitative measurement of galling characteristics.

By continuously recording the torque required for rotation during each test, a graphic picture of galling progress was formed. This, together with observation of the test surfaces at the conclusion of each test, helped the investigators to understand the effect of the many variations tried. Detailed reporting of the data would involve pictures of each chart and test surface as well as a specific description of each test procedure. All of this information is obsolete in the light of subsequent developments, and its inclusion here is not justified by its present value..

The general results of the sheet metal tests proved the deductions made during the preliminary work. The change in torque required for rotation was in reality a measure of the galling that actually took place between the specimens and resulted in seizure.

Contrails

The typical appearance of galled test specimens can be clearly seen in Figure 5. This was always the result when no compound was used. The application of an anti-seize compound between the contacting surfaces prevented this deformation.

Figures 6 and 7 are illustrations of typical curves obtained by this type of test. An instantaneous increase in torque indicates immediate seizure. A constant torque value throughout the test indicates no galling. A constant torque would result if a perfect anti-seize compound was applied to the test surfaces. It will be noticed in these illustrations that a discontinuous or oscillating motion, where the rotation was actually stopped and started again (five to ten times per radian), resulted in a much smoother curve than that obtained by continuous rotation. The curve formed by the peak values during discontinuous rotation is in effect the torque required at zero speed. This is obviously the condition most conducive to galling and therefore most significant from a testing standpoint. It was planned for some time to use a ratchet drive on an improved model of the seizure tester, but subsequent work showed that a power-driven, slow speed rotation was equally effective. The non-uniformity of the curves obtained with continuous rotation was evidently a result of speed variations. A constant speed test was found to be impossible with the manual drive due to sudden changes in load.

Comparison of the data from our tests on sheet metal specimens provided the following general conclusions:

- (1) Clean metal (copper, aluminum, stainless steel) galls very quickly followed by seizure. This was indicated by a major increase in torque within two to four radians of rotation.
- (2) An oil film between the contacting surfaces delays seizure due to its lubricating effect, but does not prevent eventual galling and seizure. This was indicated by a major increase in torque after twelve to fourteen radians of rotation.
- (3) Four types of commercial anti-seize compounds prevented galling completely under the conditions of these tests. This was indicated by the fact that no major increase in torque occurred during extended rotation of the specimens and no deformation of the contacting surfaces occurred.

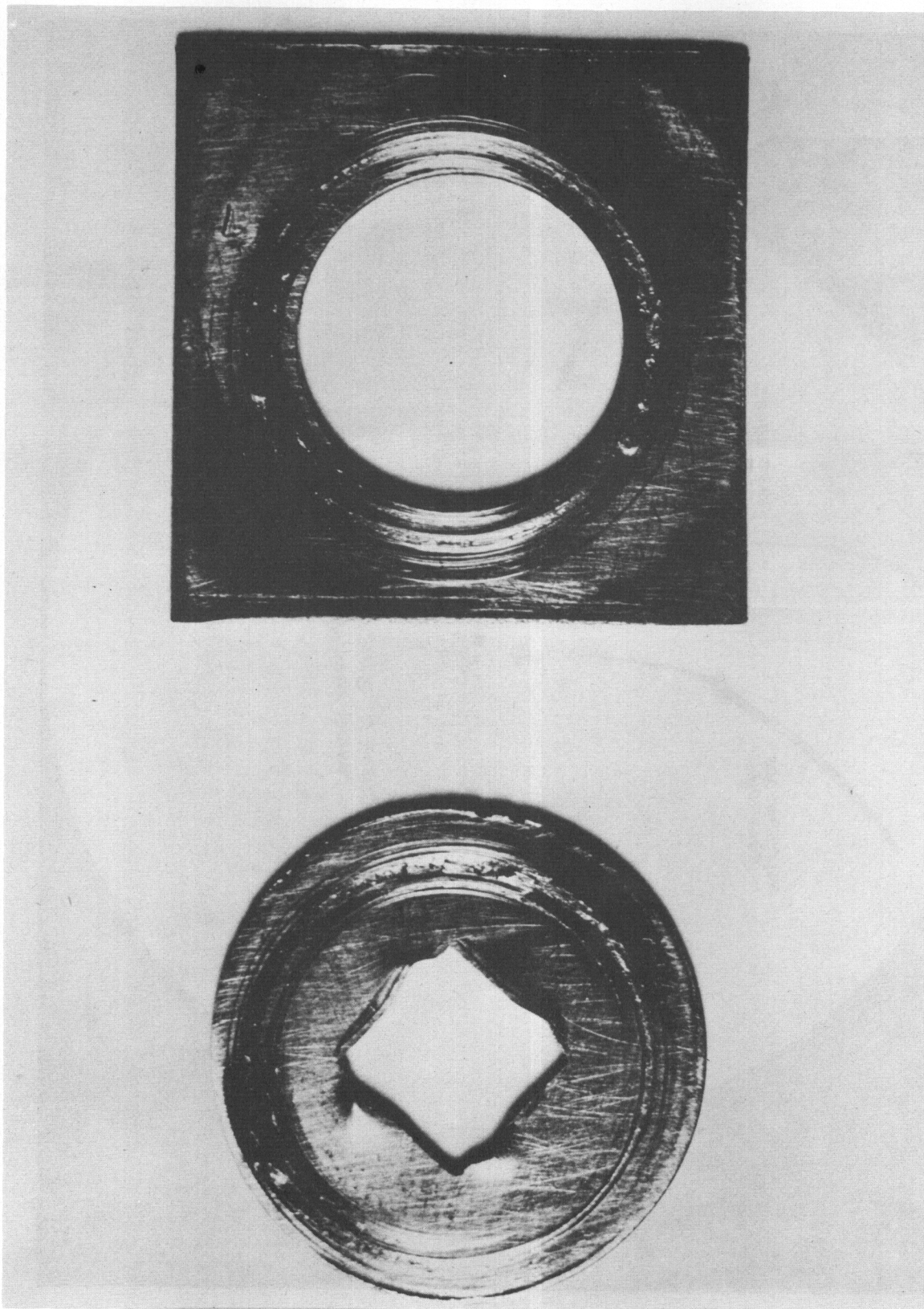

**FIGURE 5. Galled Surface of Copper Sheet after Seizure Test
(Magnification 5X)**

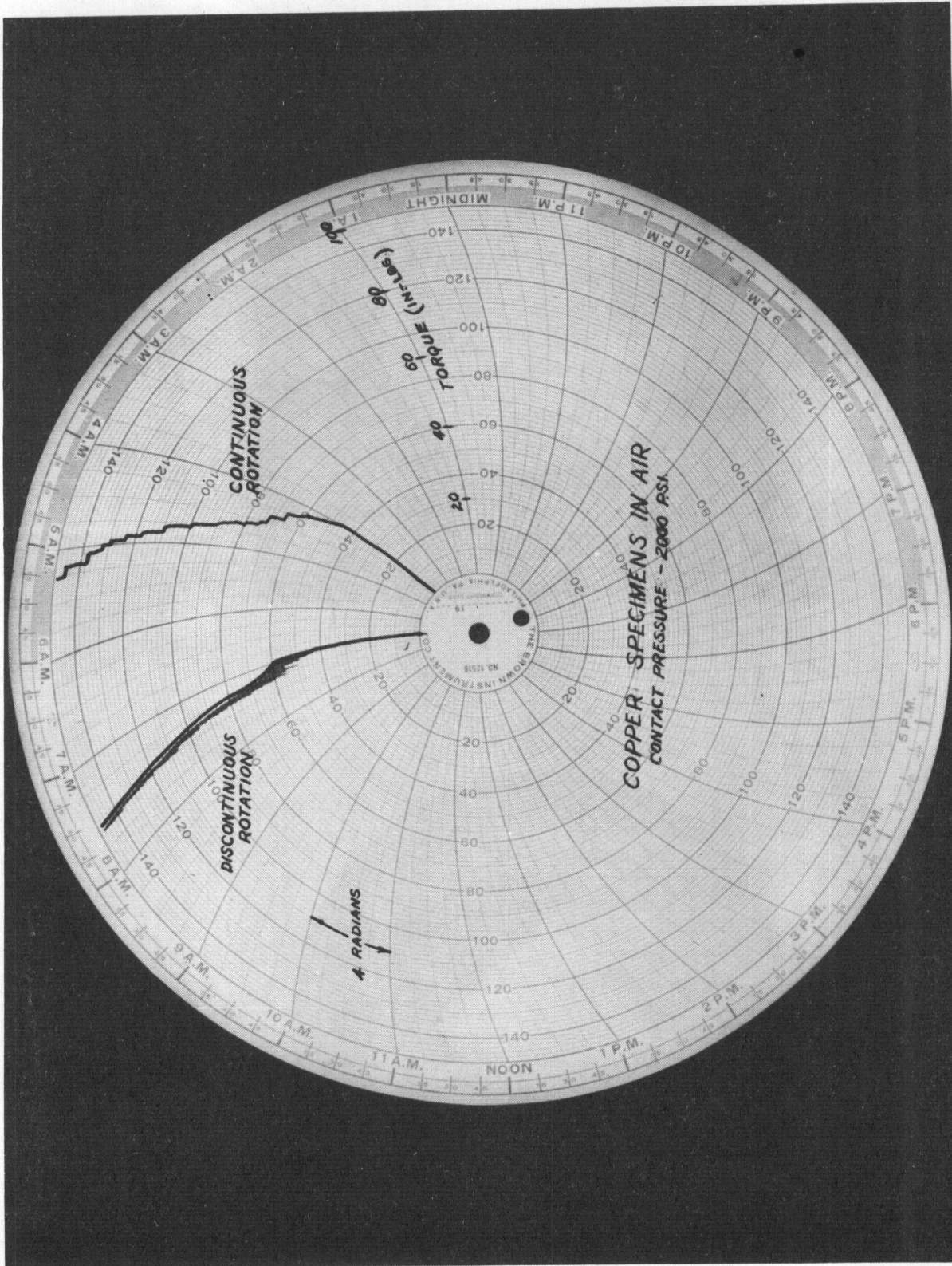

FIGURE 6. Typical Chart Record of Seizure Test

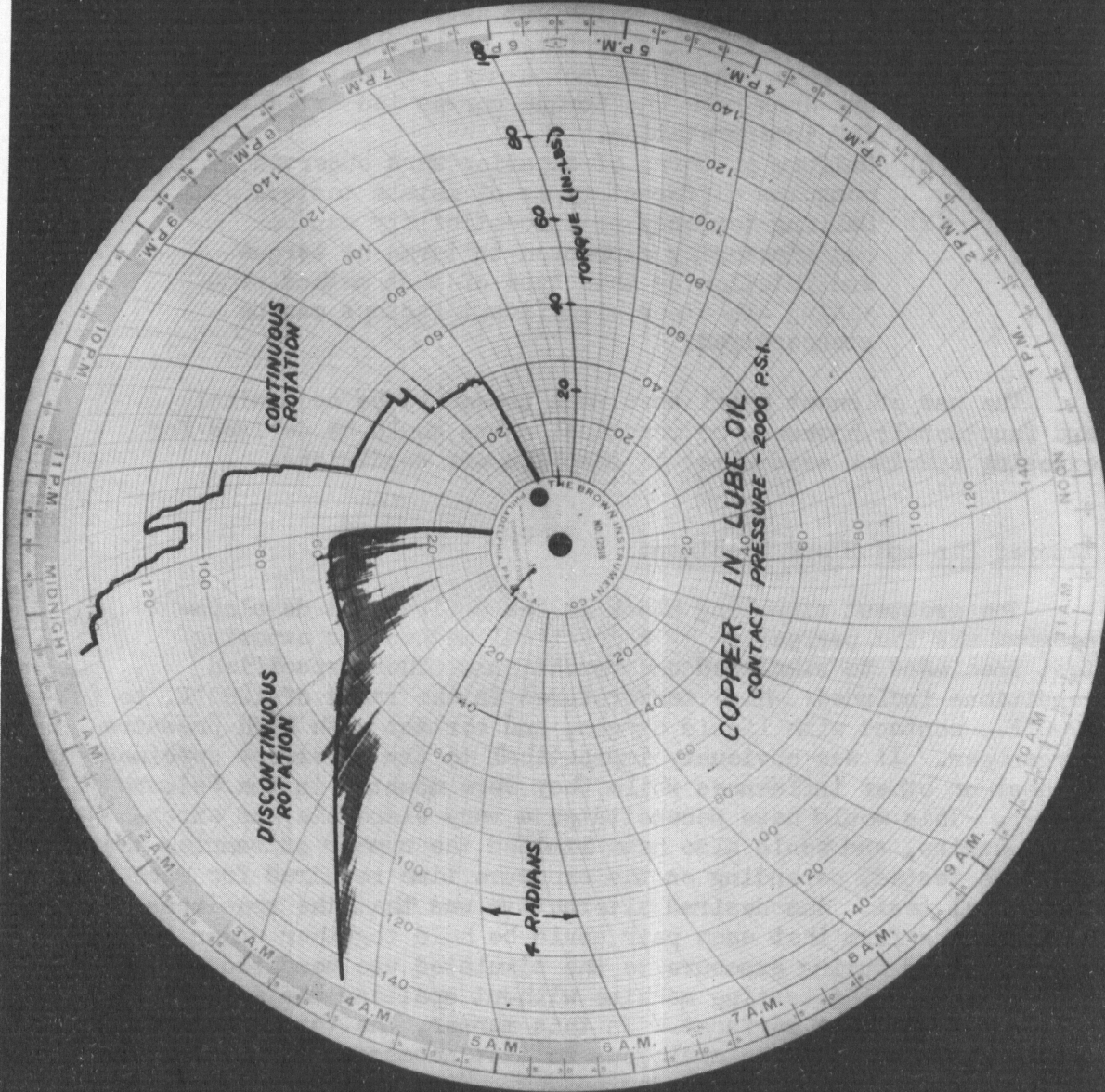

FIGURE 7. Typical Chart Record of Seizure Test

Conclusions

- (4) Contact pressure seemed to have some effect on the rate of galling but was not found to be critical within the range of our machine at low speeds.
- (5) Speed of rotation between specimens was found to be critical. Increases in speed create shearing forces which cut away the obstructions on mildly galled surfaces as soon as they are formed. This does not always prevent seizure but does make the torque curves too irregular for interpretation.
- (6) Uniform patterns of behavior were observed among the different types of metals tested.
- (7) Galling tendency or susceptibility can be satisfactorily expressed in terms of torque and rotation by this type of test method providing all other significant factors can be standardized.

The use of sheet metal specimens proved to be economical and functional; however, no practical means could be devised for exposing specimen assemblies to specific use conditions.

Tapered Pin and Block Specimens

The greatest stumbling block in the entire test development program was the perfection of a practical method for exposing test specimens to simulated use conditions. These specified conditions included: high temperatures in the range of 1200°F. to 2000°F., contact with liquid oxygen, and contact with high pressure oxygen gas. It was obviously impractical to try to expose specimens to heat or other influences while they were mounted in the Seizure Tester. This would have necessitated a very elaborate and expensive machine, and would also have limited the number of samples that could be tested, depending on the exposure time required for each individual test. The desired alternative was that the specimens be in such a form that each pair could be held together under a specific load during exposure to the simulated use conditions and then placed in the testing machine without spoiling the intimate contact of the test surfaces. In this manner, the torque recorded during the test would be analogous to that necessary to disassemble equipment after actual use under corresponding field conditions.

A great many varieties of specimen shapes were considered in an effort to solve this problem. Methods of clamping or bolting specimens together were found to be too awkward and expensive and also of dubious value at extremely high temperatures. The logical

Contrails

solution was to use a threaded specimen, the threads themselves forming the test surfaces. However, the pitch of commercial quality threads was found to be too inaccurate, resulting in distorted and inconsistent torque values. Furthermore, rotation during the test would result in an axial movement between the male and female specimens and would bring into play new surfaces previously outside the test area.

The controlling factors indicated a test specimen with a thread having a zero pitch. A tapered fit was selected as the closest approximation to this condition. It was found that by selection of a suitable taper, the assembly could be made self-holding and an intimate contact could be provided which would maintain its position and alignment during heating or exposure to other conditions without the use of external loading except during the actual seizure test.

Preliminary experiments with mild steel tapered pin and block combinations indicated that this type of specimen was definitely the answer to the problem. With such specimens, anti-seize compounds could be tested in the following manner:

- (1) Coat male tapered surfaces with sample of compound to be tested.
- (2) Press the tapered pin into its mating block with a predetermined thrust load.
- (3) Remove the load and expose this self-holding tight fit to heat or any other specific test condition.
- (4) After exposure, mount specimen assembly in the testing device and test for seizure.
- (5) The anti-seize properties of the sample compound could then be evaluated by comparison of the resulting curve of torque versus rotation with that of known standards. Specifications for compounds intended for particular applications could be set up after correlation of this test method with actual field test results.

Figure 8 is an exploded view showing the final form selected for this type specimen and the jaws used for holding and driving the specimen assembly in the Seizure Tester.

The next step in the development was the selection of the

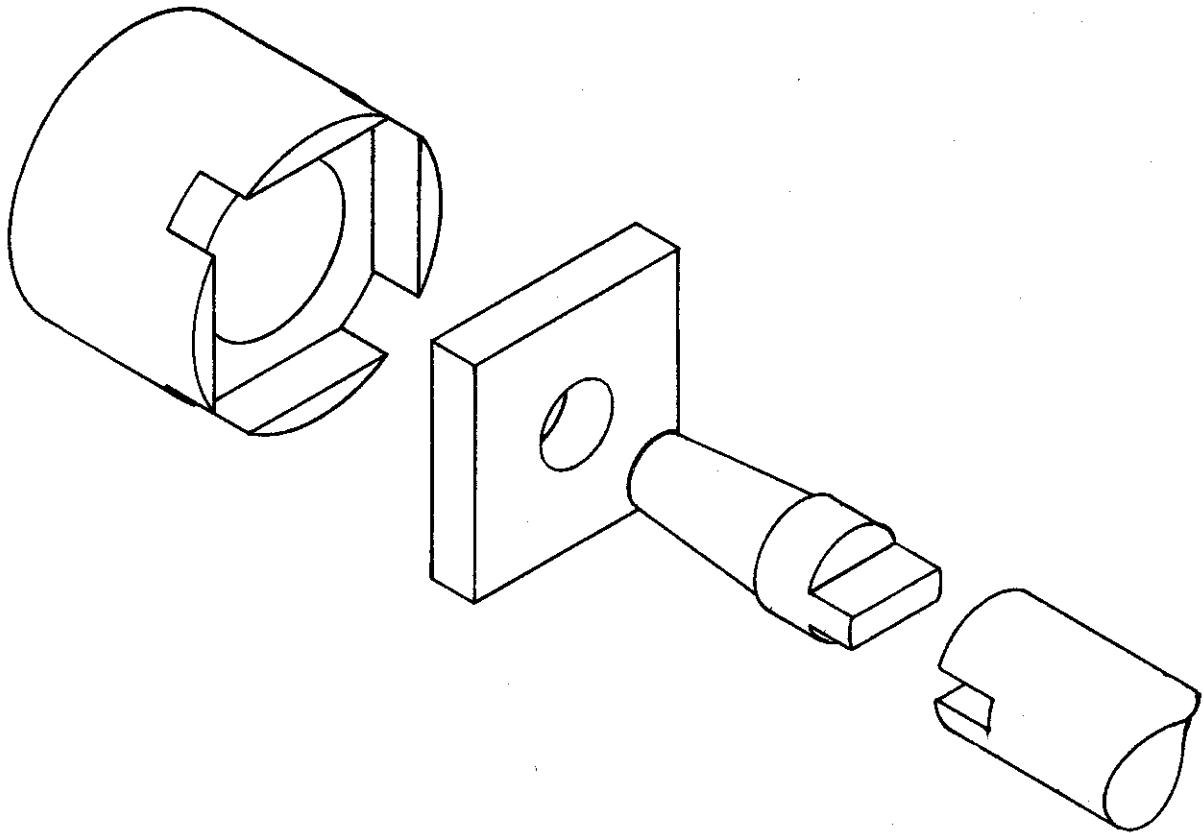

*FIGURE 8
TAPERED PIN SPECIMEN
AND HOLDING JAWS*

Contrails

correct taper for the test specimens. It was necessary that the taper be self-holding under routine handling conditions of the test. It was also desired that the taper be a maximum so that any inaccuracy in thrust loading of the specimen during the seizure test would not result in an excessive error in the load normal to the contacting surfaces. Use of too small a taper could result in excessive contact pressures due to sources other than the thrust load.

In order to determine the correct taper, a series of specimen pins with corresponding blocks were constructed from type 302 stainless steel with various tapers ranging from 1/2 inch to 4 inches per foot. These specimens were tested for their self-holding characteristics by subjecting each pair to a thrust load equivalent to 2000 psi normal to the contacting surfaces. The force required to disengage this tight fit was then measured. This was done with various lubricants between the contacting surfaces. The specimens were also heated to 1200°F. with an anti-seize compound and tested for seizure. The results of these experiments indicated a taper of two and one-half inches per foot to be the maximum taper with sufficient self-holding characteristics. However, subsequent seizure tests resulted in several cases of failure to hold during heating and cooling cycles with one anti-seize compound in particular. A taper of two inches per foot has since proved satisfactory in all cases. Although the results of seizure tests made on specimens with various tapers have shown that the degree of taper is not critical within a certain range, the specimens used in the future for this work will be standardized with a taper of two inches per foot. Figure 9 is a working drawing of the standard specimen assembly used during the remainder of this investigation.

The tapered pin type test specimen was evaluated by making a number of actual seizure tests with various anti-seize compounds. These tests included specimens having several different degrees of taper; this aided in the selection of the optimum taper to be used for this purpose. All of the tests in the series were made on specimen assemblies that had been exposed to a high temperature for several hours so that their behavior under these conditions could be noted.

Seizure Tester, Model I, was modified in order to use tapered pin specimens by changing the shape of one holding jaw, the size of the torsion bar, and the means for applying the thrust load. All test specimens used in this series were constructed from

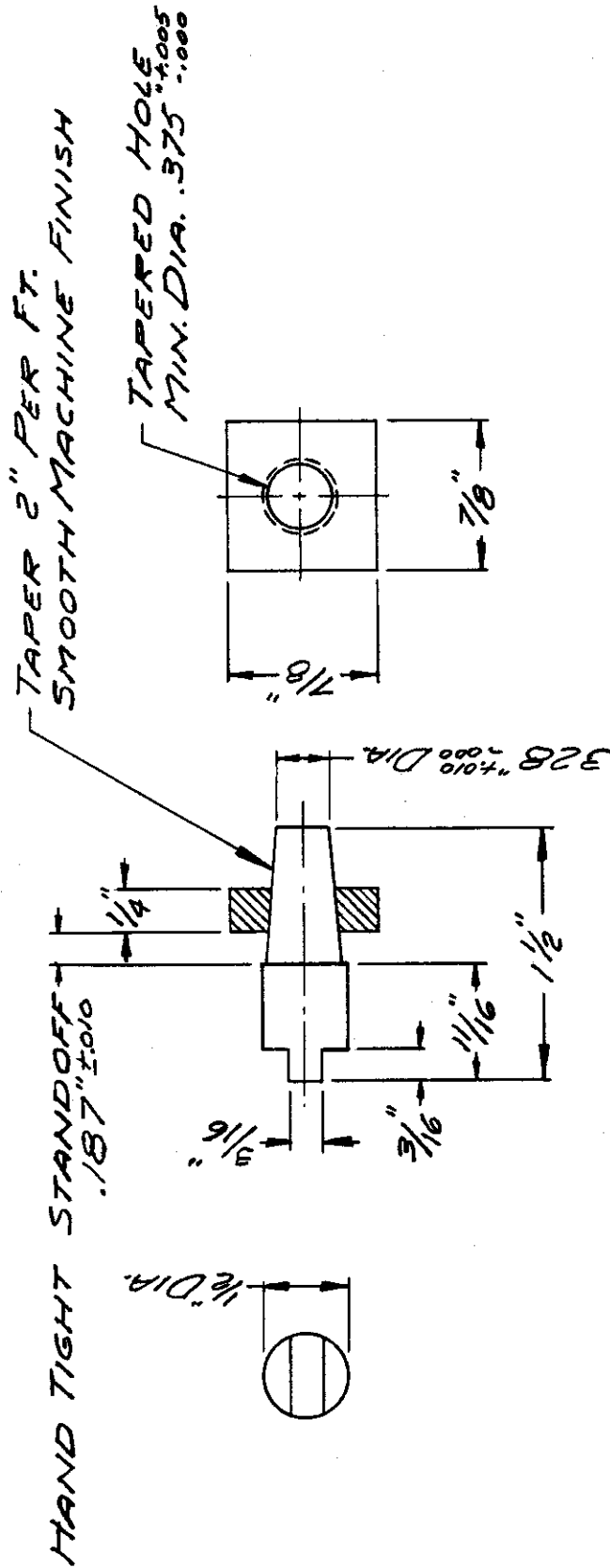

UNLESS OTHERWISE SPECIFIED ALL TOLERANCES $\pm 1/64$ "

FIGURE 9
TAPER PIN AND BLOCK TEST SPECIMENS

Contrails

type 302 stainless steel. The anti-seize compounds used were all supplied by the Air Force and were labeled as follows:

<u>Air Force Stock No.</u>	<u>Compound</u>	<u>Specification No.</u>
7500-NL	Compound, Anti-Seize, Thread, High-Temp., Fel-Pro.-C-5	
7500-NL	Compound, Anti-Seize, Thread, High-Temp., Du Page	
7500-NL	Compound, Anti-Seize, Templube, #26	
7500-NL	Compound, Anti-Seize, Ease-off #990	
7500-NL	Compound, Thread, Santa Susana Sealube (Molykote, Powd. Lead, Fluorolube Oil)	MLC-4370
7500-051000	Compound, Anti-Seize Graphite-Petrolatum	MIL-C-5544 (AN-C-147)

The following procedure was used for each seizure test:

- (1) The tapered surface of each pin was coated with the anti-seize compound to be tested.
- (2) Each pin was then inserted in a matching block, and the resulting assembly was loaded with an end thrust equivalent to a surface contact pressure of 2000 psi. The pin was rotated 90 degrees relative to the block while the load was applied in order to squeeze out excess compound and insure an intimate contact.
- (3) The specimens were then placed in a muffle furnace and heated to 1200°F. This temperature was maintained at 1200 ± 25°F. for a period of two hours.
- (4) After cooling, each pin and block assembly was mounted in the testing device and tested for seizure. This test consisted of applying a constant compressive load to the specimen assembly, equivalent to a surface

Contrails

contact pressure of 2000 psi, then rotating the pin relative to the block at a slow (less than 5 rpm) speed while under this load. During this rotation, the testing device recorded the variations in the torque required to produce the rotation. Since an increase in torque under these conditions has been shown to be a direct indication of galling, the relative effectiveness of the various compounds were tentatively evaluated by comparison of the torque versus rotation data.

Reproduction of the actual torque data curves which resulted from these tests would make this report much too bulky. For this reason, several significant features have been selected and listed in Table I. Specific illustrations and an analysis of the data follow the table.

Contrails

TABLE 1. - Test Results, Tapered Pin Specimens Exposed to 1200° F for two hours, Tested with Seizure Tester Model I.

Specimen No.	Degree of Taper (inches per foot)	Anti-Seize Compound	Initial Torque Re'd. to Break Contact (in-lb)	Revs. to Produce Seizure	Appearance of Mating Surfaces After Test
E-1	2-1/2	None	above 250 (did not break)	Less Than One	Galled
B-1	1	Fel-Pro-C-5	above 250 (did not break)	Less Than One	Galled
B-2	1				
C-1	1-1/2				
C-2	1-1/2				
D-1	2				
D-2	2				
E-2	2-1/2				
E-3	2-1/2		248 above 250		
B-3	1	Di Page	193	Did not Seize	Slightly corroded with no indication of Galling
B-4	1		173		
C-3	1-1/2		188		
C-4	1-1/2		188		
D-3	2		174		
D-4	2		93		
E-4	2-1/2		133		
E-5	2-1/2		77		
B-5	1	Templube #26	over 250 (did not break)	Less Than One	Galled
B-6	1				
C-5	1-1/2				
C-6	1-1/2				
D-5	2				
D-6	2				
E-6	2-1/2				
E-7	2-1/2				
B-7	1	Ease-off #990	158	Did not Seize	severely scored and deformed
B-8	1		158	13	
C-7	1-1/2		165	1	
C-8	1-1/2		145	2	
D-7	2		157	24	
D-8	2		147	5	
E-8	2-1/2		80	10	
E-9	2-1/2		104	20	
B-9	1		Graphite-Petrolatum	over 250 (did not break)	
C-9	1-1/2				
D-9	2				
B-10	1	Santa Susana Sealube	128	Did not Seize	slightly scored and corroded
C-10	1-1/2		126		
D-10	2		134		

Contrails

Figure 10 illustrates the results obtained with tapered pin specimens in cases where the anti-seize compound is completely ineffective under the specified test conditions. This curve is the actual result of the test made on Specimen No. B-9, using a **graphite petrolatum (Spec. MIL-C-5544)** compound. It shows an instantaneous increase in torque with practically zero rotation. This indicates immediate seizure of the contacting surfaces. The galled appearance of the surfaces after testing proved this to be true.

Figure 11 shows the actual curve resulting from the seizure test on Specimen No. E-8, using the Ease-Off #990 compound. Under the test conditions, the use of this compound results in an easy break of the contacting surfaces, good anti-seize properties for several revolutions, followed by gradual galling and eventual seizure.

Figure 12 is the actual curve resulting from the seizure test on Specimen No. D-10, using the Santa Susana Sealube compound (molybdenum disulfide, powdered lead, and fluorolube oil). This illustrates the results obtained with an anti-seize compound which prevents galling during an extended number of revolutions.

It will be noticed in Figures 11 and 12 that there was a definite minimum and maximum torque required during each revolution of the test. These irregularities were found to be due to variations in contact pressure resulting from misalignment of the opposing shafts of the testing machine. An improved model of the Seizure Tester was built later which eliminated such variations.

A more accurate picture of the galling characteristics indicated by each test can be formed by selecting the maximum torque required for each revolution and plotting these values versus the number of revolutions on rectangular coordinates. This has been done to construct the data curves shown in Figures 13 through 16. These curves, although still irregular due to other inaccuracies in the Seizure Tester, give a good, graphic representation of the effectiveness of the anti-seize compounds under the conditions of these tests. The data shown in Figure 13 is contradictory, but is included here to show the difficulties that can arise in controlling the contact pressure on specimens having too small a taper.

Several tentative conclusions were drawn concerning the use of these particular anti-seize compounds as a result of the evaluation tests using tapered pin specimens. These conclusions apply to the application of these compounds in equipment constructed of

Contrails

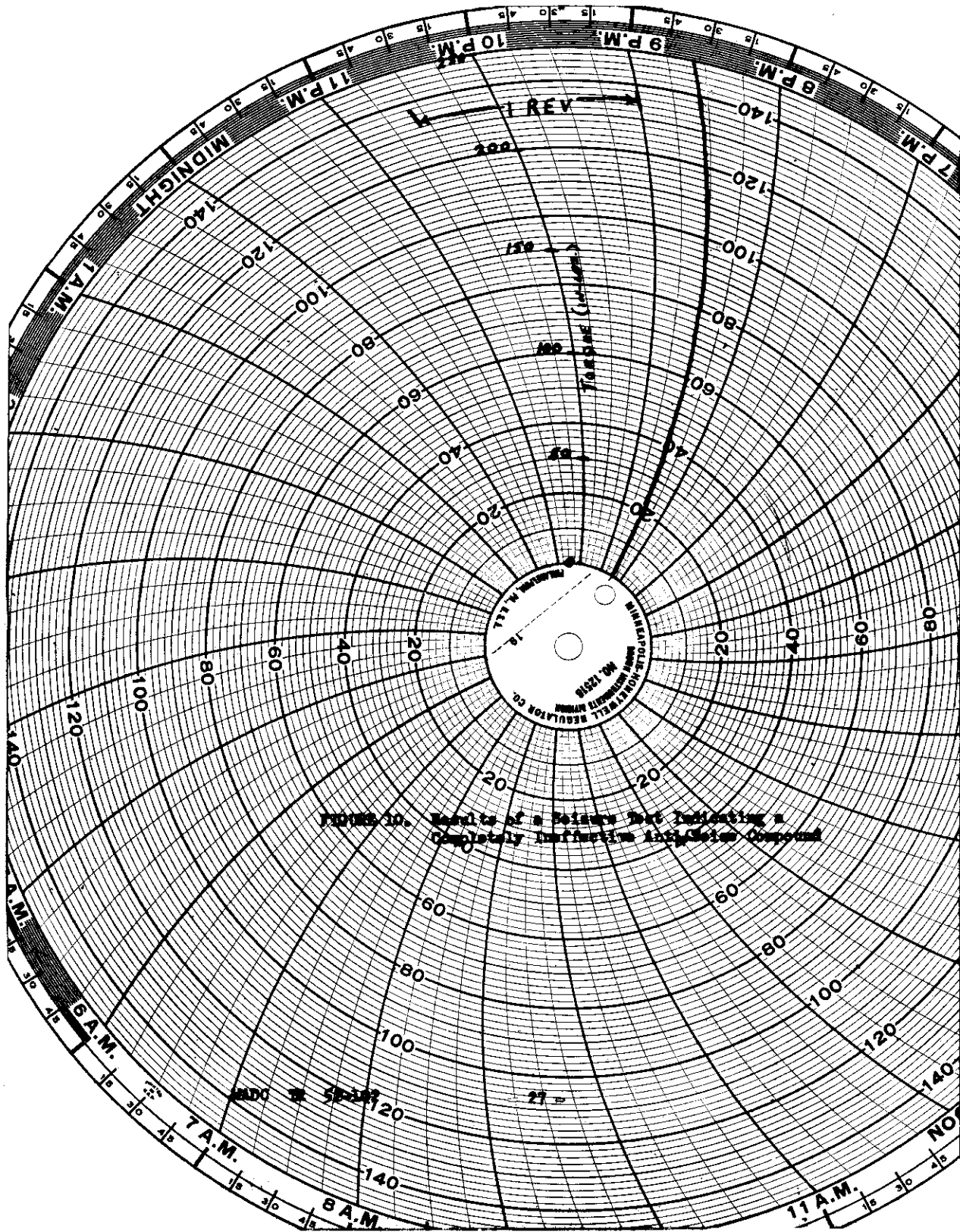
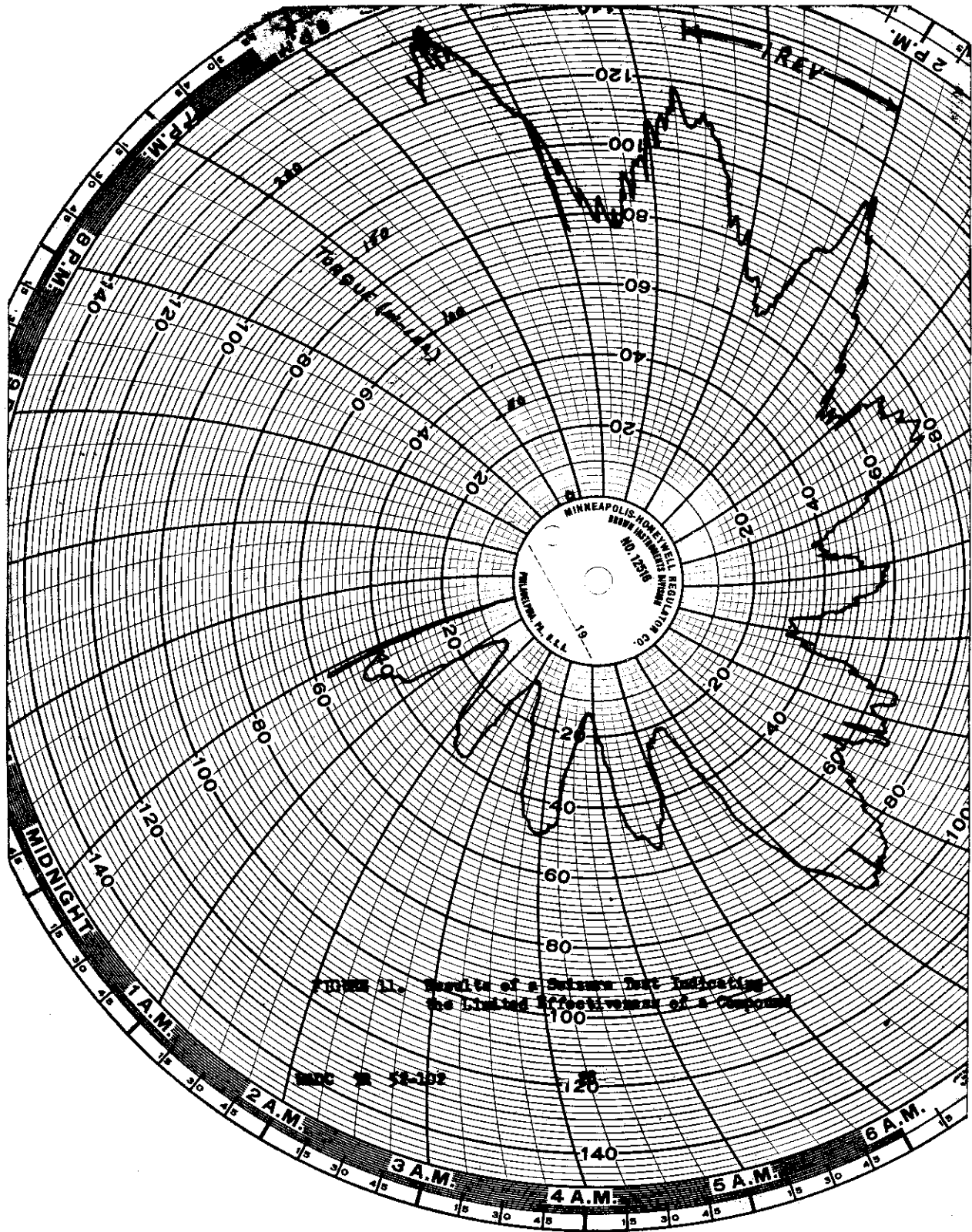
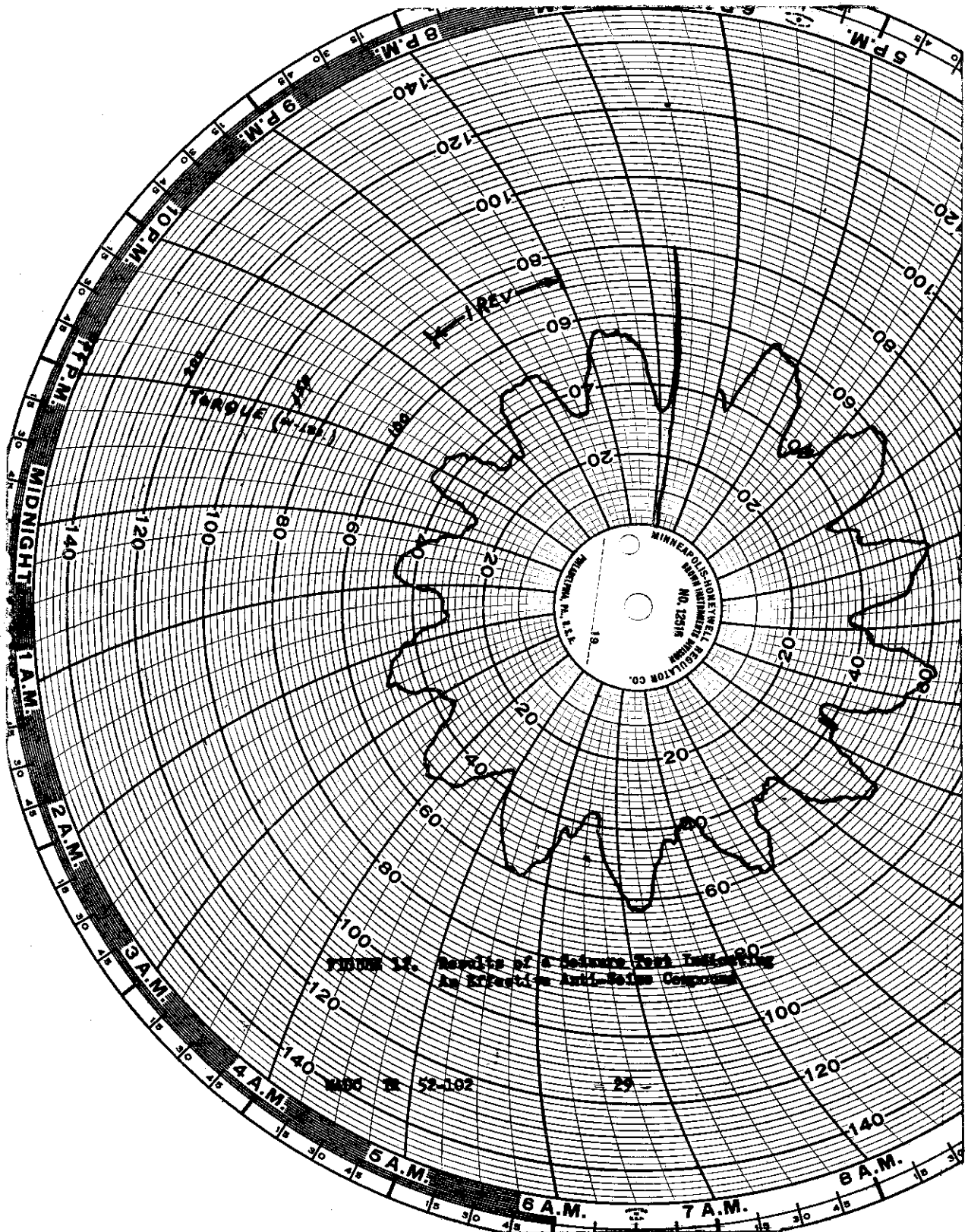

FIGURE 10. Results of a Peisera test indicating a Completely Ineffective Anti-Glare Compound

Contrails



Contrails



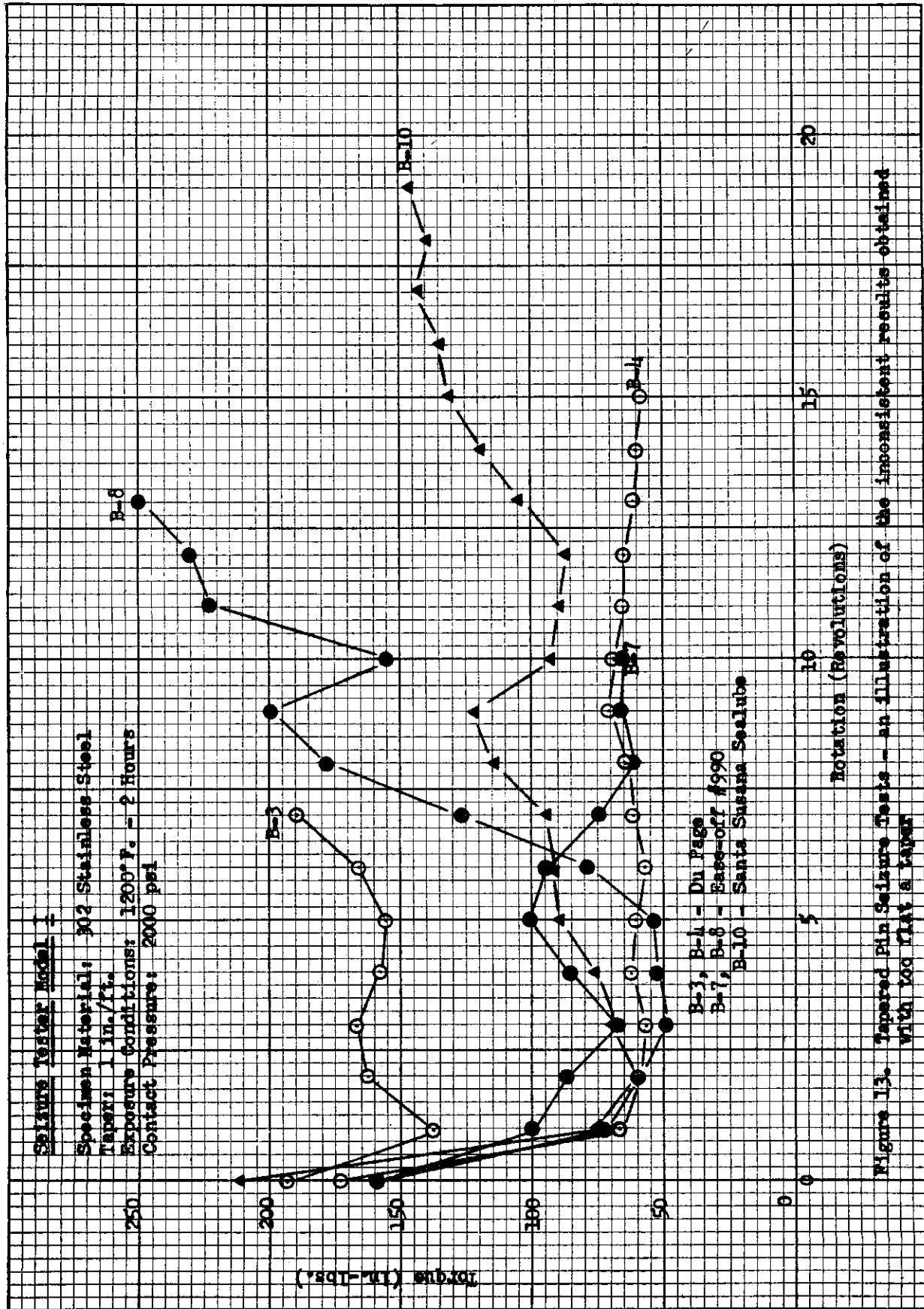
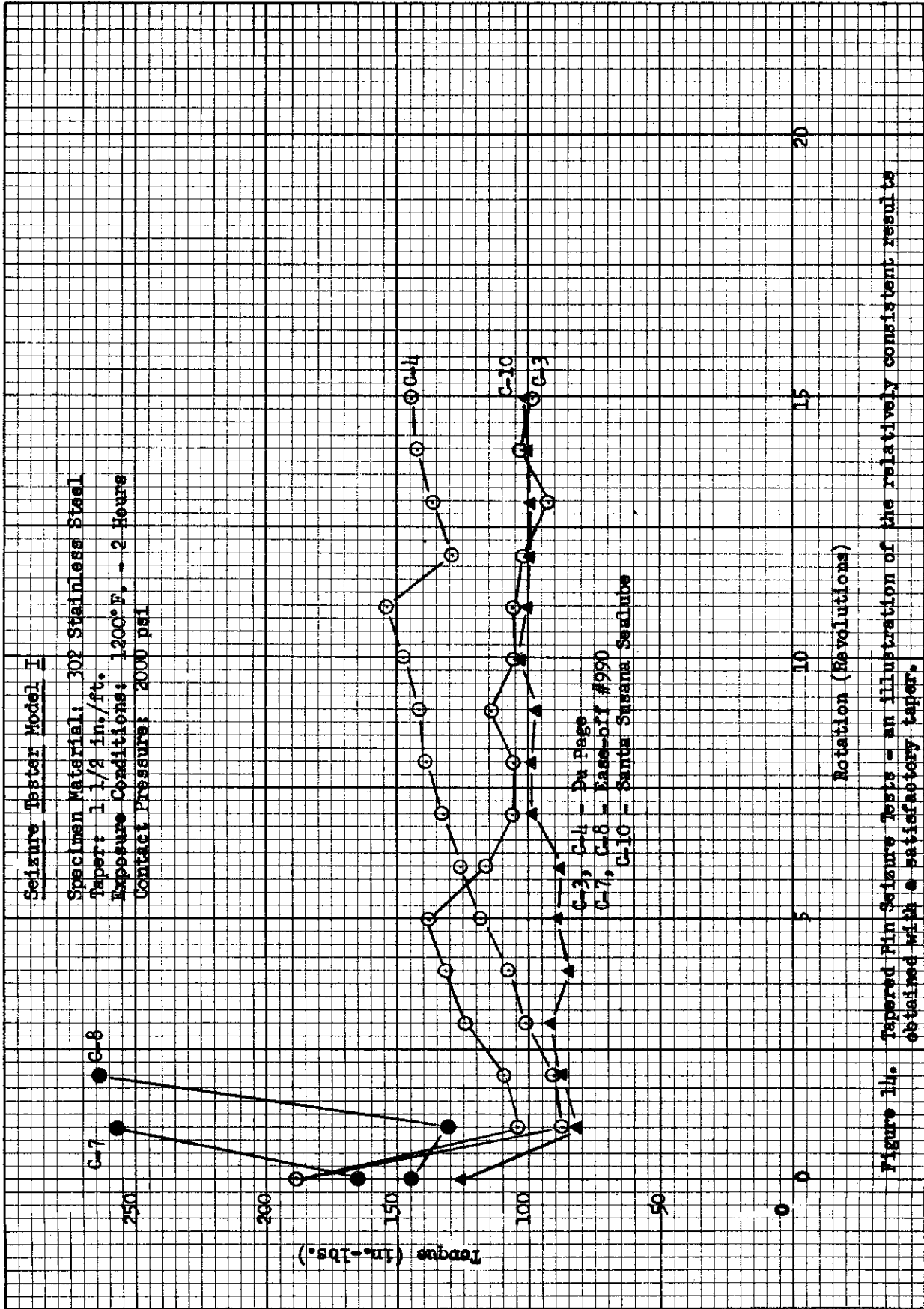
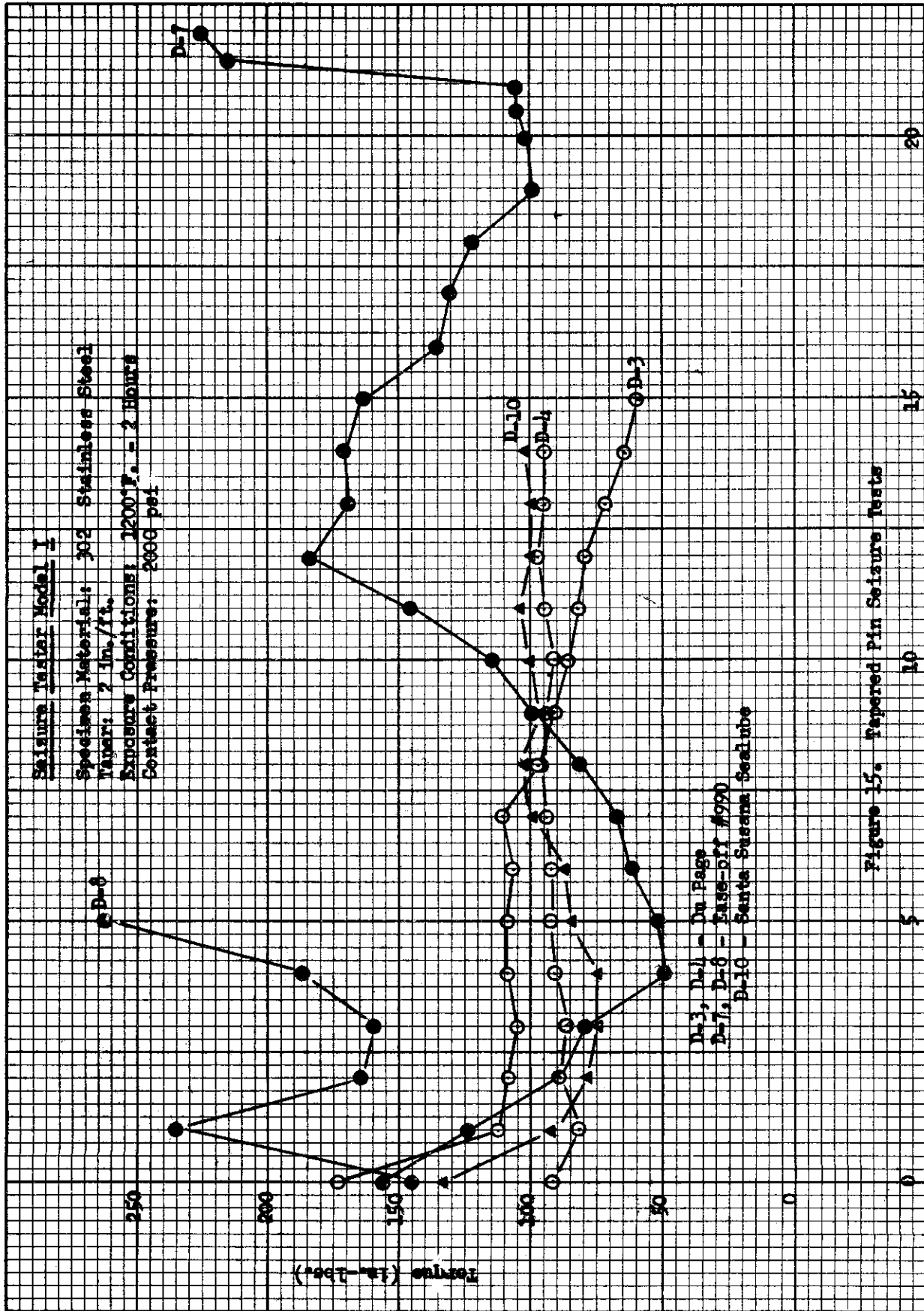

Figure 13. Tapered Pin Seizure Tests - an illustration of the inconsistent results obtained with too flat a taper





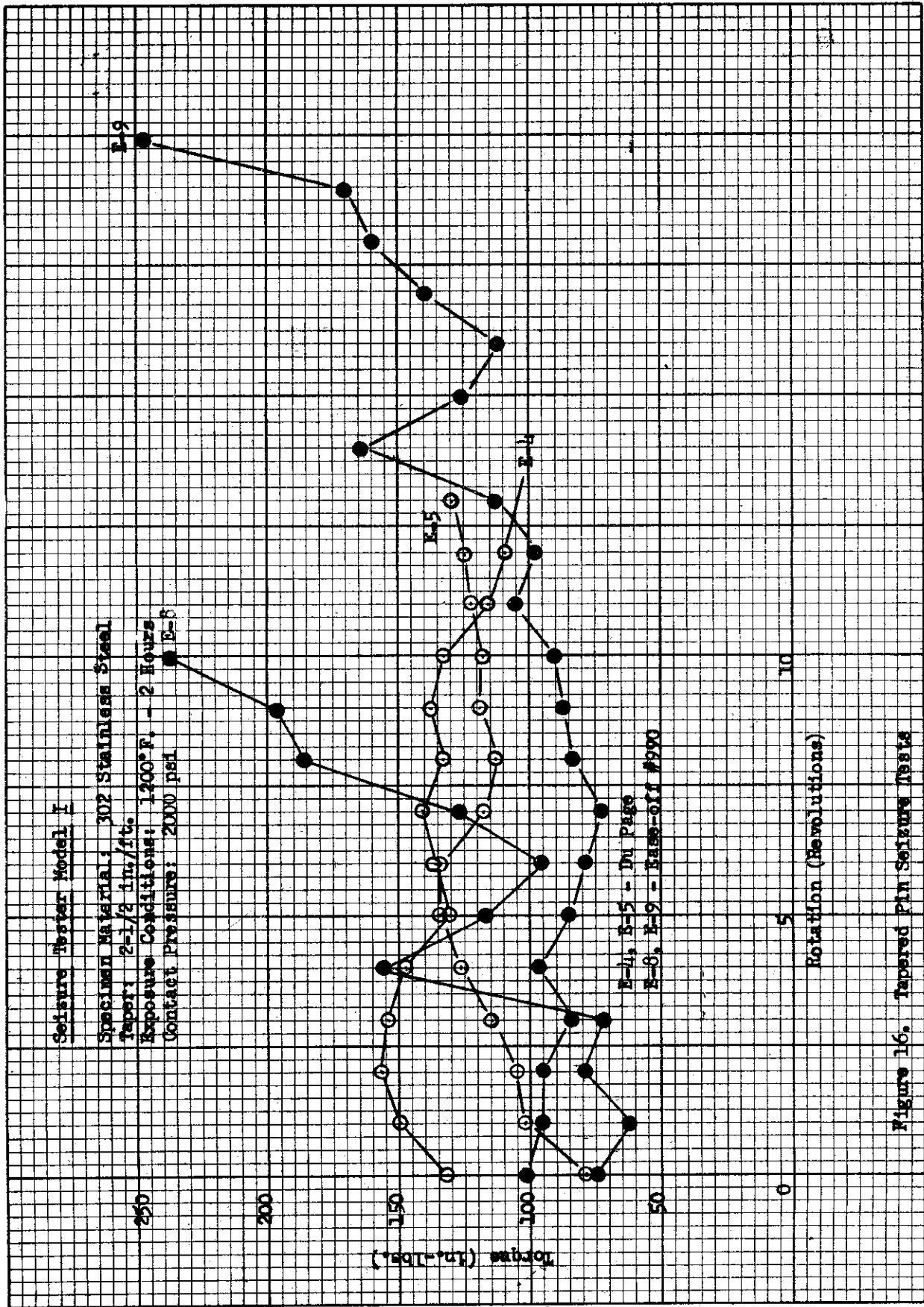

Figure 16. Tapered Pin Seizure Tests

Contrails

Austenitic alloys, such as type 302 stainless steel, and where the temperature of operation is in the neighborhood of 1200°F.

- (1) According to the procedure described, the following compounds appeared to be ineffective for the prevention of immediate seizure in threads and tight fits under the conditions specified above. The results recorded were the same as when no compound was used.
 - (a) Fel-Pro-C-5
 - (b) Templube #26
 - (c) **Graphite-Petrolatum (Specification Material No. MIL-C-5544)**
- (2) The test compound Ease-Off #990 appeared to prevent galling to a limited extent only. Continued rubbing between contacting surfaces eventually voided this protection and resulted in seizure. The indications are that this compound would not be satisfactory in cases of repeated assembly and disassembly of equipment without renewed application of the compound. Unsatisfactory service is also indicated in cases of large diameter threads and equipment subject to vibration.
- (3) Both the Du Page, Hi-temp. compound and the Santa Susana Sealube compound are indicated to be satisfactory for the prevention of galling and seizure under these conditions. Although the Du Page compound seems to offer slightly better resistance to deformation of the contacting surfaces, the Sealube allows a breaking apart of the contact at a lower torque value which would facilitate disassembly of equipment.

Discussion

This phase of the investigation resulted in the design and construction of testing equipment suitable for measuring the galling characteristics of metal surfaces. The results of tests made with sheet metal specimens proved the potential value of the seizure test and that a fundamental relationship existed between the degree of galling and the torque required for the counter-rotation of the two contacting surfaces under standard conditions.

The selection of a self-holding tapered fit as the shape of the test surface made possible the universal application of the test

Contrails

method. Tapered pin and block test specimens can be exposed to specific use conditions before each seizure test. These specimens can also be constructed from the same materials as those used for the intended application of the compound being tested.

This test method results in a quantitative determination of the galling characteristics of a metal surface. The results are recorded as a curve depicting the torque required for rotation as a function of the magnitude of the rotation. Given two metal surfaces subject to galling and separated by an anti-seize compound of limited effectiveness, the following curve can be expected.

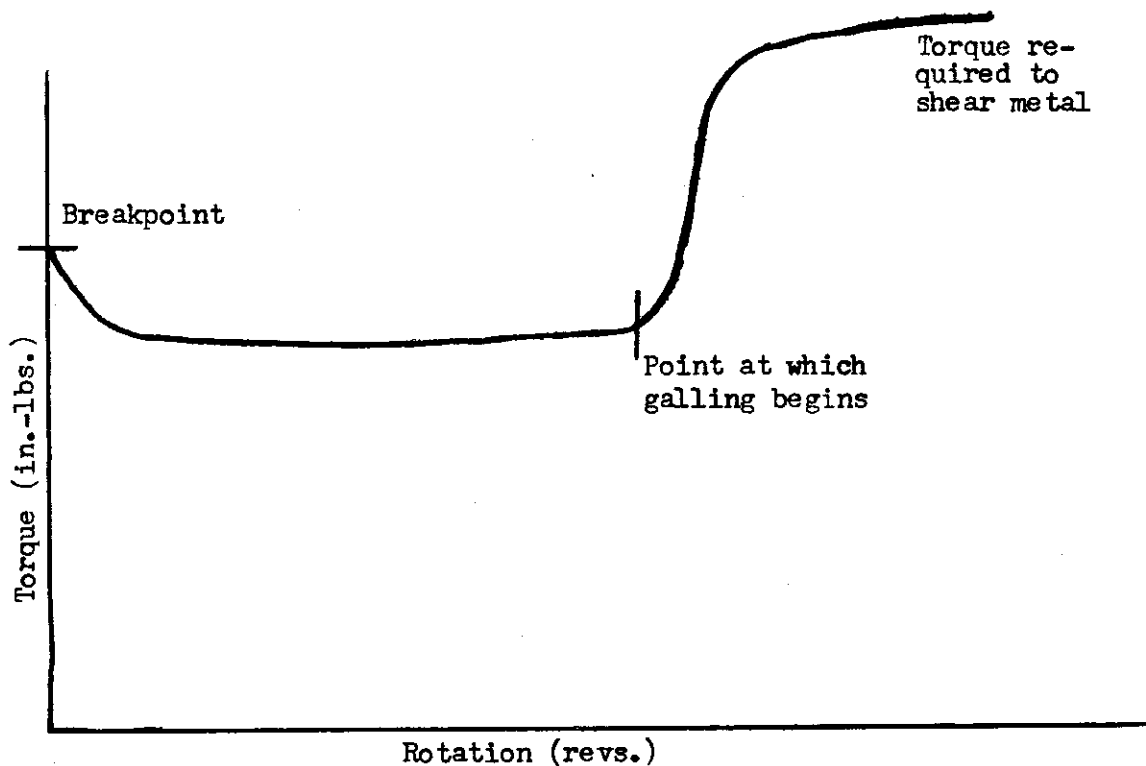

Two points on the above curve are most significant in the evaluation of an anti-seize compound. The breakpoint signifies the torque required for initial relative motion between the contacting surfaces. A low breakpoint will facilitate the disassembly

Contrails

of equipment, especially on small diameter threads where a minimum of rotation will lower the contact pressure appreciably. The second significant point on the curve is that at which galling begins. The number of revolutions required to get to this point is a direct indication of how well anti-seize properties are maintained under adverse mechanical conditions such as vibration, shock loads, repeated assembly and disassembly of equipment, and large diameter threads requiring appreciable rotation before a reduction in contact pressure is effected.

The results of seizure tests conducted during this phase of the investigation have shown that the proposed type of test method is ideally suited for evaluating the effectiveness of anti-seize compounds in applications subject to high operating temperatures. It is also indicated that the method will be just as advantageous in cases of exposure to other severe or special conditions such as applications in liquid or gaseous oxygen systems.

Although the basis for the test was found to be sound, the testing equipment was not adequate for practical routine work. In order to improve accuracy and ease of operation, an improved testing device was found necessary (Seizure Tester, Model II).

SECTION III

SEIZURE TESTER, MODEL II

General Design Features

The design of the improved seizure tester was based on the same principles as the original model but with several refinements added in order to provide increased accuracy and ease of operation. The following modifications were indicated by experience with the original tester:

- (1) A constant, low speed power drive.
- (2) An improved torque indicating and recording mechanism.
- (3) A positive chart drive.
- (4) Positive alignment between the tapered pin and block test specimens.

Major features such as the power drive and positive alignment of the specimens could not be accomplished by simply modifying the first

Contrails

model. Space limitations and application of the thrust load at a different point in the system necessitated a completely new design.

The major components of the improved testing machine are illustrated schematically by Figure 17. Mechanical details can be seen in the photographs, Figures 18, 19, and 20. The most radical change from the first model was the location of the opposing shafts in a vertical position instead of horizontally. This was done in order to effect a major improvement in the operation of the recording mechanism.

Power Drive

An electric motor-reduction gear combination was selected as the main drive. This drive operates at a speed of 4 rpm. with a maximum output torque of 1200 inch-pounds. A spring-loaded slip coupling (clutch) was installed on the output shaft of the drive unit in order to limit the maximum torque applied to the specimen assembly during each test. This coupling can be adjusted to slip at any value from 0 to 500 inch-pounds. It serves to protect other parts of the machine from overload when seizure occurs between test specimen surfaces. The output shaft from this coupling drives the lower specimen holding jaw and also the recorder chart board whose speed is reduced further by means of a chain and gear combination.

Specimen Holding Jaws

Since misalignment of the specimens was a major fault of the first model, every precaution was taken to correct for it here. The final design provided for positive self-alignment by the use of two universal joints. These can be seen clearly in Figure 20. The lower holding jaw is shaped to receive the square block specimen and is in reality a universal joint with the center of the joint in the exact center of the specimen block. The upper holding jaw is shaped to receive the tongue of the specimen pin. It was made by machining the ends of a standard line shaft universal joint. This combination, under compression, will align itself under all practical conditions. Without this system, it would have been necessary to use something like lathe chucks to hold each specimen on center. Also, it would have been necessary to machine

Contrails

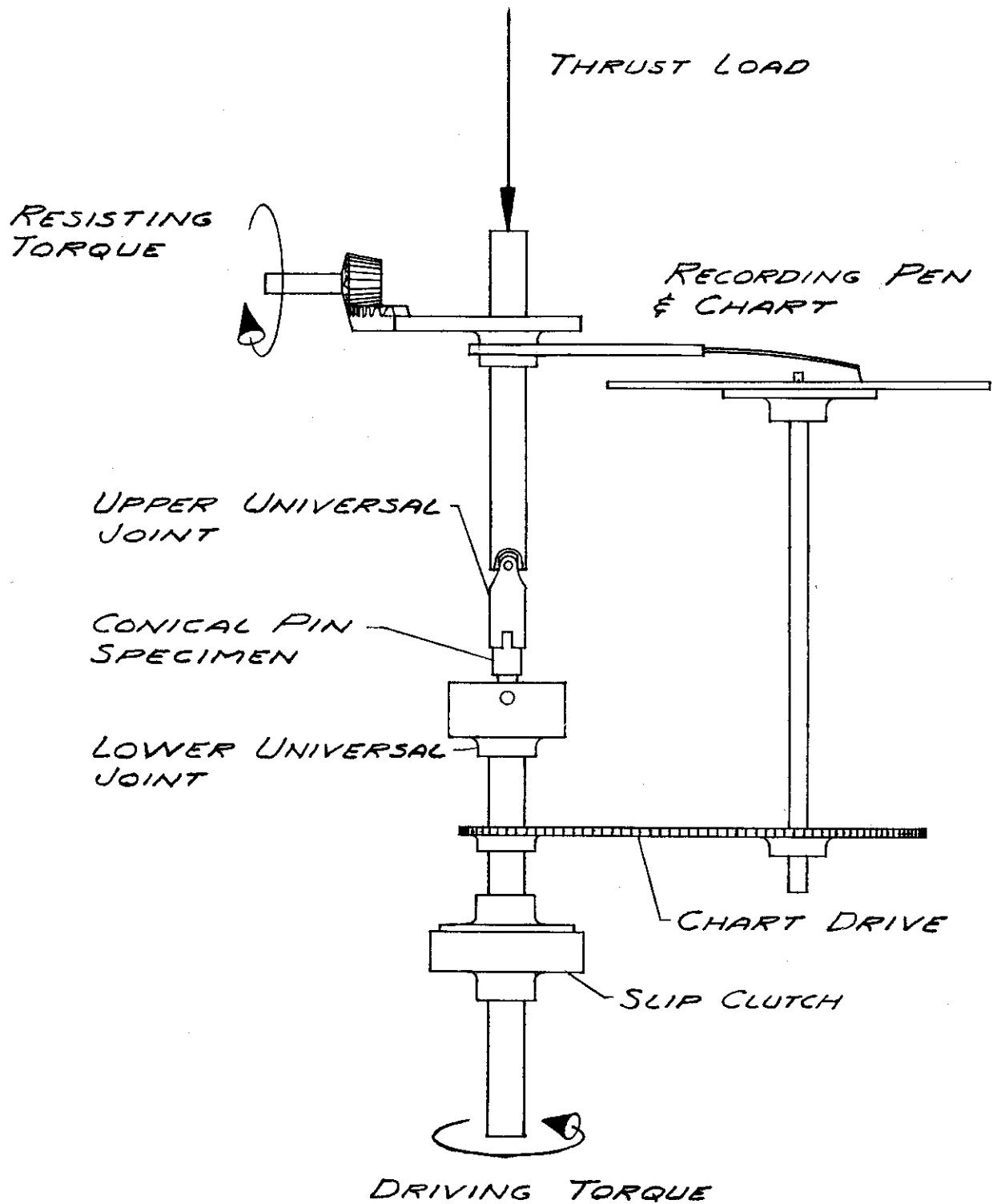

FIGURE 17. SCHEMATIC OF SEIZURE TESTER - MODEL II

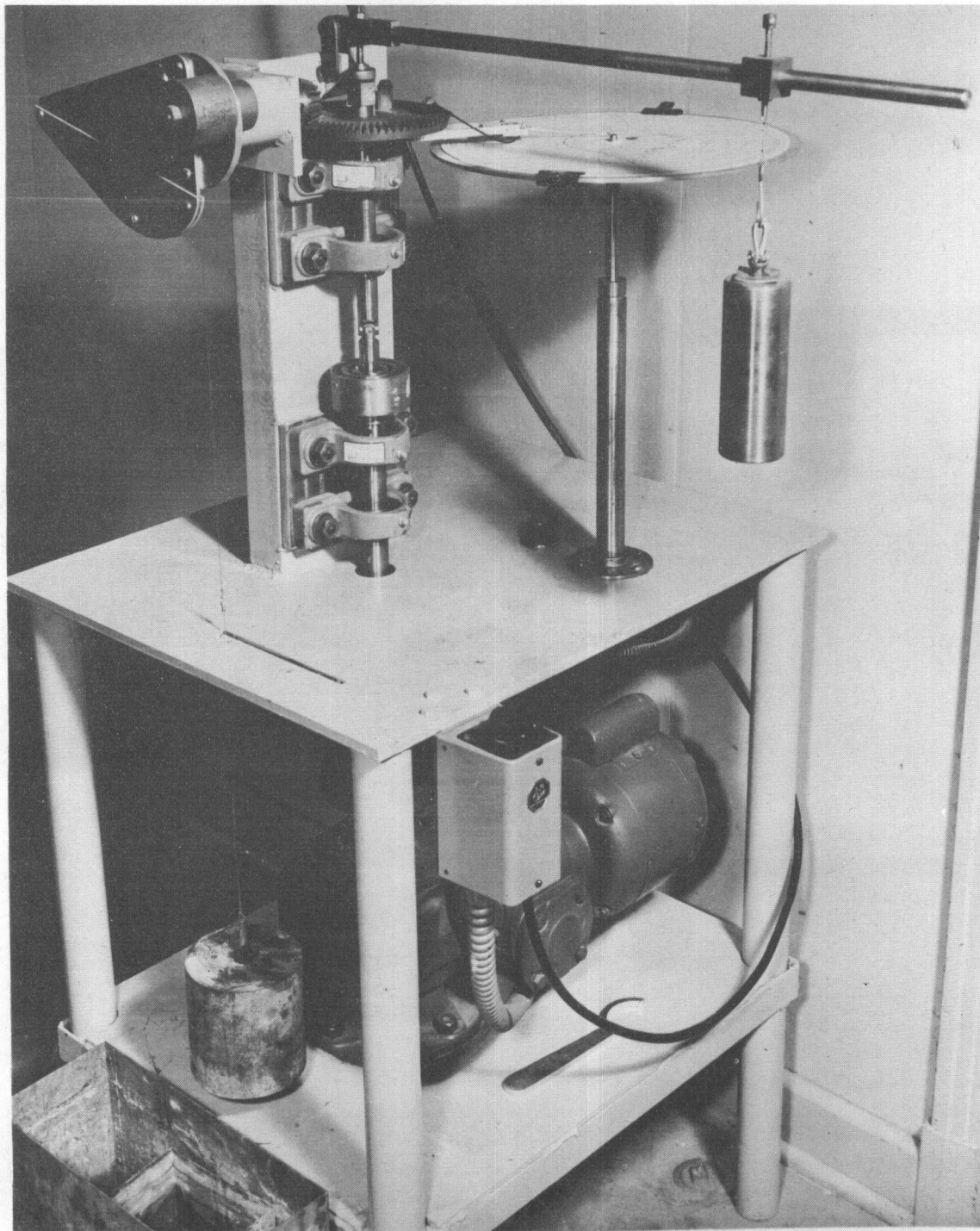

FIGURE 18. Seizure Tester Model II - Full View

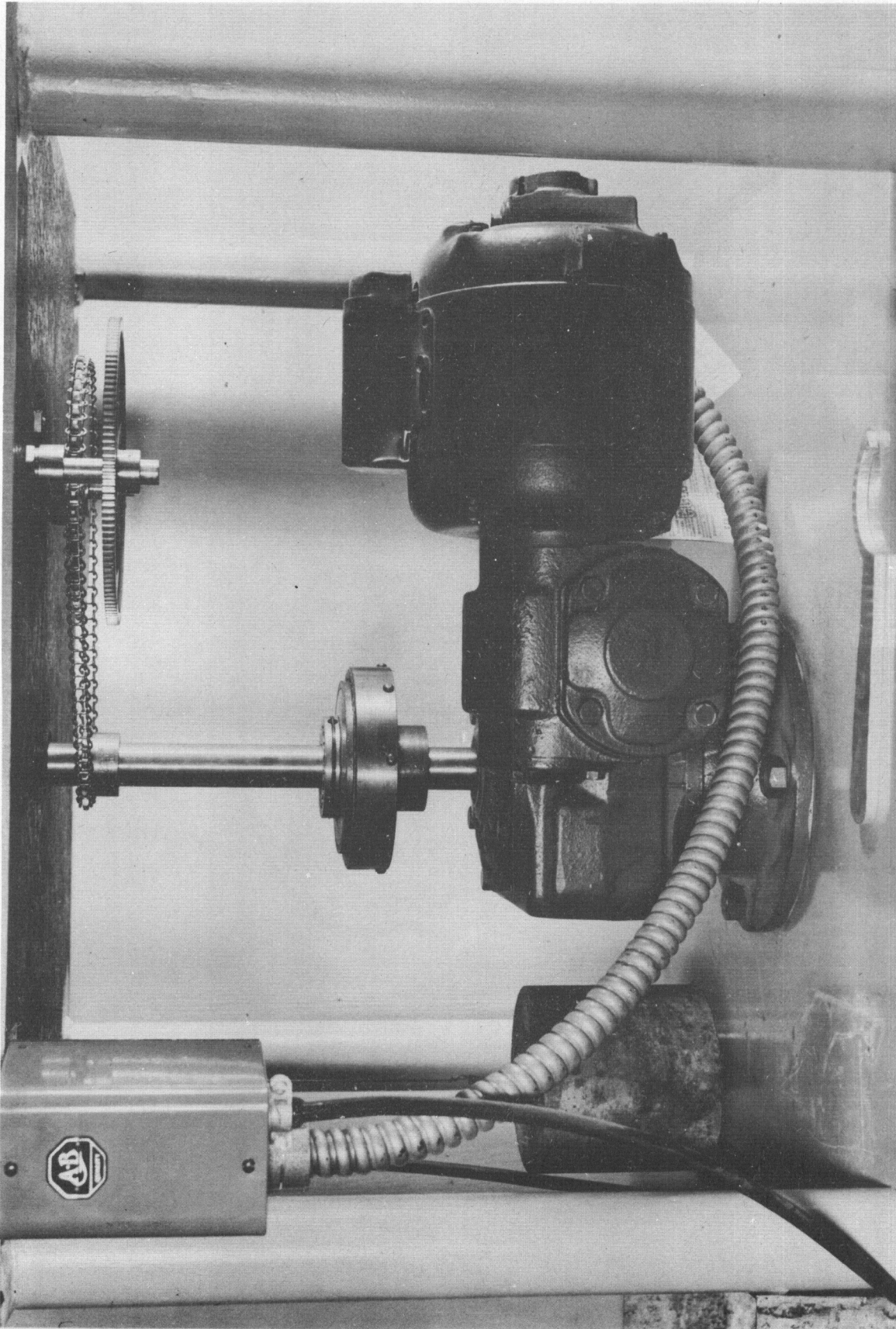

FIGURE 19. Seizure Tester Model II - Drive and Clutch Detail

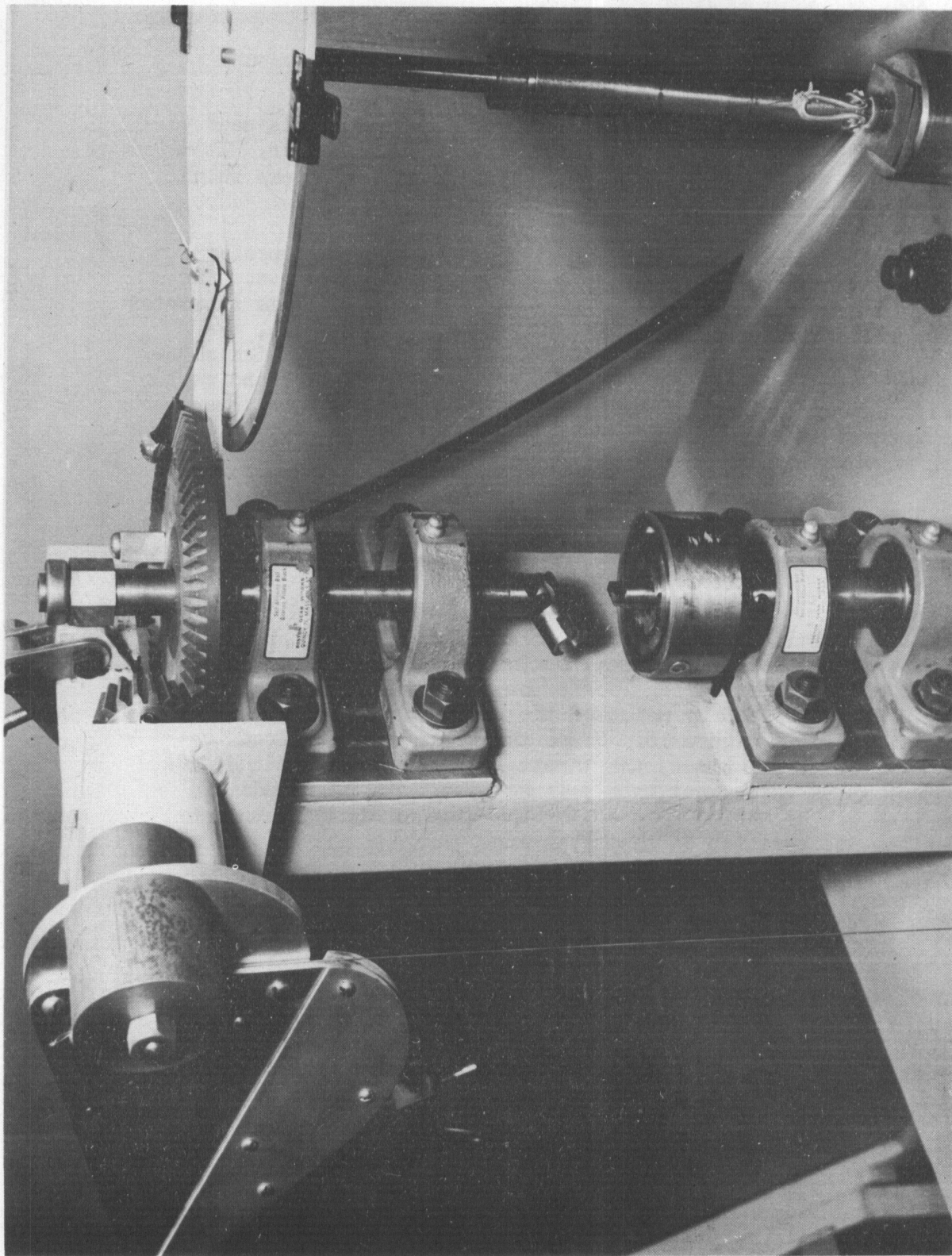

FIGURE 20. Seizure Tester Model II - Specimen Holding and Torque Recording Details

Contrails

each specimen with extreme accuracy.

Opposing Shafts

The lower shaft of the tester is power driven and is used to drive the chartboard as well as the lower specimen holder. It is supported by two self-aligning, ball-bearing pillow blocks which resist both radial and thrust loads.

The upper shaft of the tester is used to hold the specimen pin in place and to supply and record the resisting torque. The thrust load is also transmitted through this shaft. It is supported by two self-aligning pillow blocks; however, in this case, the pillow blocks are equipped with porous bronze bushings which allow the shaft to move axially. The torque resisting element and recording pen are driven from this shaft by means of a bevel gear. This gear is keyed to the shaft but in such a manner as to allow axial movement of the shaft.

These two shafts will be referred to in the remainder of this section as the main shafts.

Thrust Load

The thrust load is transmitted to the specimen assembly through a small ball thrust bearing located on the top of the upper main shaft. It is applied by means of the weight and lever arm arrangement, pictured in Figure 18. Since the upper shaft is free to move axially at all times, the thrust load can be maintained at a constant value throughout each seizure test. The magnitude of this load can be varied by changing the size of the weight or by adjusting its position on the lever arm.

Torque Resisting Element

For recording purposes, it was desired that the resisting torque be a linear function of the magnitude of rotation of the upper main shaft. This was done by supporting a fixed weight by a flexible wire from the face of a cam attached to a horizontal camshaft. This cam and weight are shown in Figure 18. The cam is shaped so that its rotation changes the effective lever arm of the

force exerted by the weight.

The camshaft is driven by bevel gears from the upper main shaft. A 6:1 gear ratio here decreases the deflection of the upper shaft necessary to effect a maximum resisting torque. With the cam and weight arrangement, it was found that sudden changes in torque during a seizure test induced a swinging action in the suspended weight with resulting variations in the measured torque. This fault was corrected by submerging the weight in a tank of water. The tank and its interior baffle chamber can be seen in the lower left of Figure 18. The resistance of the water was sufficient to dampen the swinging action and prevent its interference.

Torque Recorder

The chart board of the recorder was mounted on an independent vertical shaft and driven from the lower main shaft by the drive illustrated in Figure 19. Standard 24 hour x 150°, temperature recorder, circular charts were used. A 24:1 reduction in speed resulted in one hour on the chart being equivalent to one revolution of rotation between the test surfaces of the specimen assembly.

The recording pen is actuated by rotation of the bevel gear mounted on the upper main shaft. It was calibrated with the torque resisting element so that 150° on the chart is equivalent to 300 inch-pounds of torque. The magnitude of the torque is directly proportional to the rotation of the upper shaft and therefore to the deflection of the pen. The recorder details are shown in Figure 20. Mechanical stops together with the slip coupling of the power drive were adjusted so that the maximum torque value cannot exceed the limit of the chart.

As with Model I of the seizure tester, the rotation of the specimen pin necessary to produce the resisting torque and to effect deflection of the recording pen had to be compensated for. Otherwise, this rotation would be recorded on the chart as relative rotation between specimens. This was done as before by adjusting the length of the pen arm and the location of the center of the chart. Due to this compensation, the chart actually records only relative rotation between the two opposing shafts and not the full rotation of the lower shaft alone.

An extremely light weight pen was found to be necessary for this recorder due to sudden changes in torque which occur during

Contrails

some seizure tests. Ink is fed to the pen through a small tube from a glass reservoir mounted on the large bevel gear.

General Test Procedure

The following procedure is used for conducting seizure tests with the Model II tester:

- (1) A thoroughly cleaned tapered pin specimen is coated with a sample of the anti-seize compound being tested.
- (2) This pin is then fitted into a matching block after which this assembly is mounted in the holding jaws of the seizure tester.
- (3) A predetermined thrust load is applied and the specimens rotated 90° relative to each other under this load. This rotation insures an intimate fit of the contacting surfaces.
- (4) The specimen assembly is then removed from the tester and exposed to specific test conditions such as: heat, oxygen gas, or liquid oxygen.
- (5) After exposure the assembly is again mounted in the seizure tester under the same thrust load.
- (6) A new chart is placed on the recorder, the recording pen is lowered into position and the zero adjustment is checked.
- (7) The motor is switched on in the forward direction and the test is allowed to proceed until the recorded torque value reaches the maximum limit of the chart. If this does not occur the test is usually stopped after 2½ revolutions between specimens (1 chart revolution).
- (8) The motor is now reversed in order to reduce the resisting torque to zero.
- (9) The specimen assembly is then removed from the tester, the pin and block separated by force, and the contacting surfaces inspected for surface deformation.

During such a test the torque required to rotate the specimen block relative to the specimen pin is continuously recorded as a function of the magnitude of the rotation. The torque indicates numerically the degree of surface deformation resulting from any galling that takes place. The appearance of typical galled test surfaces is shown by

Contrails

Figure 21. It is this type of surface deformation that results in actual seizure. The relative effectiveness of various anti-seize compounds can be determined by comparison of the recorded torque curves and by the appearance of the contacting surfaces at the conclusion of each test.

Seizure Tests Conducted With Improved Seizure Tester

In order to evaluate the performance of the improved seizure tester and to further study this method of testing, three series of seizure tests were conducted using tapered pin specimens. Each series was designed to evaluate the effectiveness of anti-seize compounds after exposure to different use conditions. The main object of this entire investigation specified the development of test methods for the evaluation of anti-seize compounds designed for the following applications:

- (1) In equipment subject to high operating temperatures (1200°-2000°F.)
- (2) In aircraft oxygen systems
- (3) In liquid oxygen systems having piping from one to six inches in diameter.

For each series of tests, exposure conditions were selected for specimen assemblies which duplicated the specific conditions encountered in each of the above applications.

For the high temperature tests, specimen assemblies (prepared according to the testing procedure previously described) were heated in a furnace at $1200 + 10^{\circ}\text{F}$. for six hours in an oxidizing atmosphere. The furnace (normally used by the machine shop for heat treating) was gas fired, the temperature being recorded and controlled electrically. Five specimen assemblies were exposed and tested for each different anti-seize compound. All specimens were constructed from cold-rolled stainless steel (type 302).

Prepared specimen assemblies for the aircraft oxygen system tests were exposed to commercial quality oxygen gas at 450 psi and 160°F. for six hours. The maximum operating pressure for such systems is 450 psi and 160°F. is the maximum temperature usually employed by the Air Force for materials used at room temperatures. An electrically heated, high pressure autoclave

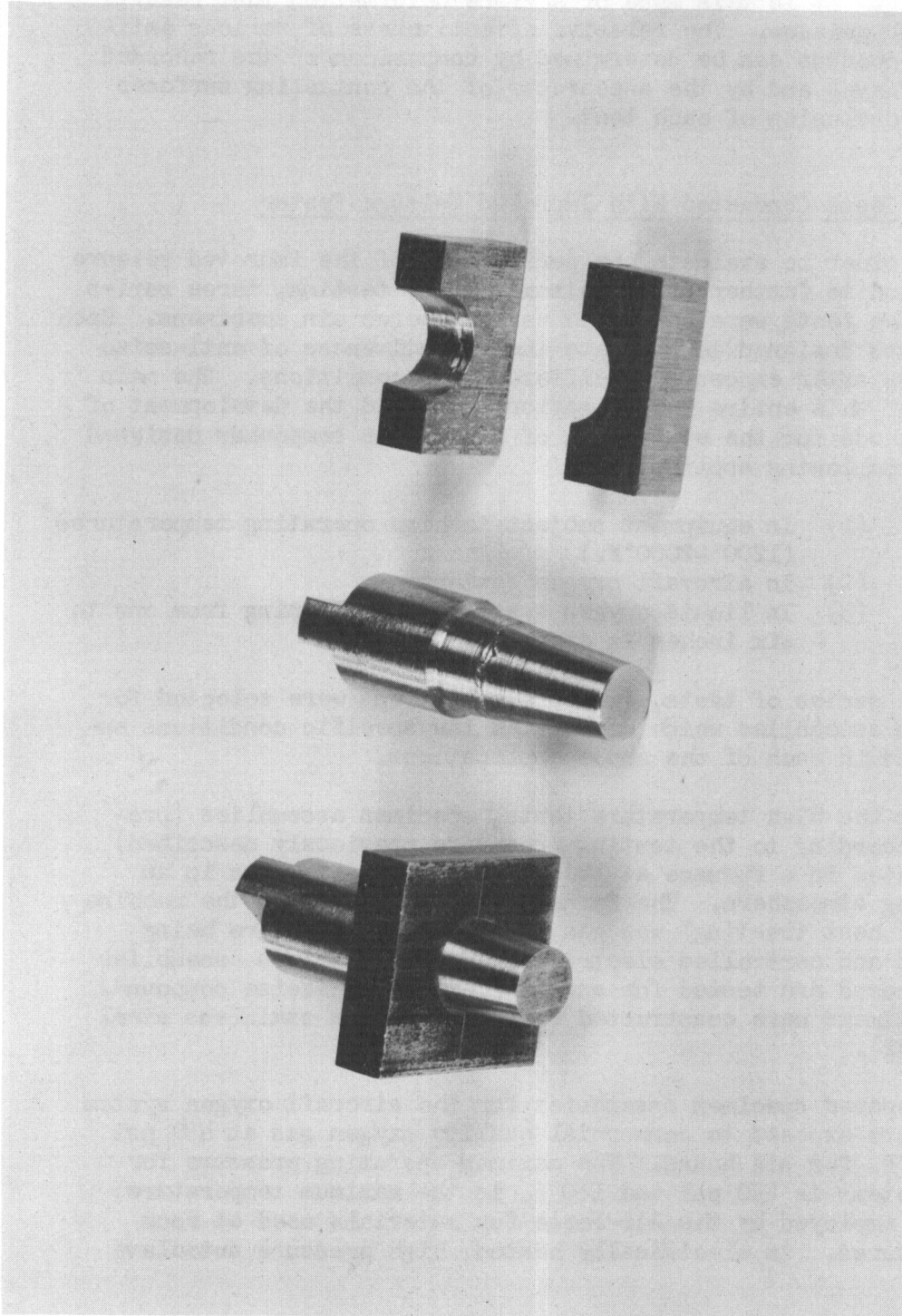

FIGURE 21. Galled Surfaces of Tapered Pin and Block Specimen after Seizure Test (Magnification 1.5X)

Contrails

was used for these exposures. This piece of laboratory equipment is constructed from stainless steel and equipped with a safety valve, pressure gages, and suitable equipment for controlling pressure and temperature. Eleven specimen assemblies were used for each anti-seize compound tested; five of type 302 stainless steel, two of aluminum, two of brass, and two of mild steel.

Five prepared specimen assemblies were used for each compound tested by exposure to liquid oxygen. These were all constructed from type 302 stainless steel. They were exposed by immersion in commercial quality, medium purity, liquid oxygen for a period of six hours. An ordinary silvered glass vacuum flask was used as the container.

After exposure to the specific simulated use conditions described above, the three series of specimen assemblies were tested for seizure by the standard procedure discussed previously in this section. A 100-pound thrust load was used which resulted in a surface contact pressure of approximately 4,000 psi.

Four anti-seize compounds were used in the evaluation of these test methods. Samples of these compounds were supplied by the Air Force and labeled as follows:

<u>AF Stock No.</u>	<u>Compound</u>	<u>Specification No.</u>
7500-NL	Du Page, High-Temp. Thread Compound	
7500-NL	Santa Susanna Sealube	
7500-051000	Graphite - Petrolatum Anti-Seize Compound	MIL-C-5544
7500-050200	Abso-LUTE, Oxygen Sealing Compound	MIL-C-5542

The Du Page, Santa Susanna Sealube, and Graphite-Petrolatum compounds were used on specimens exposed to high temperature conditions. The Santa Susanna Sealube and Abso-LUTE (MIL-C-5542) compounds were used on specimens exposed to oxygen gas and on specimens exposed to liquid oxygen.

Seizure Test Results

Since the results of each seizure test by this method are recorded graphically on a circular chart, the data is difficult to consolidate and report. This is especially true because the significance of all of the variations in the resulting curves is not yet fully understood. However, the potential advantages that can be realized by analysis of these curves is obvious. A typical test record chart of specimens exposed to each of the specific test conditions with each anti-seize compound tested is included in this report in Figures 22 through 31. These illustrate the current status and the future possibilities of the seizure test method. A curve showing a sudden increase in torque indicates galling and eventual seizure of the test surfaces. A prolonged constant torque value indicates that no surface deformation occurred under the conditions of these tests.

Figure 31 is followed by Table 2 which is a list of significant data selected from the torque curves obtained as a result of seizure test conducted on each specimen assembly included in this series. Observations concerning the condition of the test surfaces at the conclusion of each test are also included.

Contrails

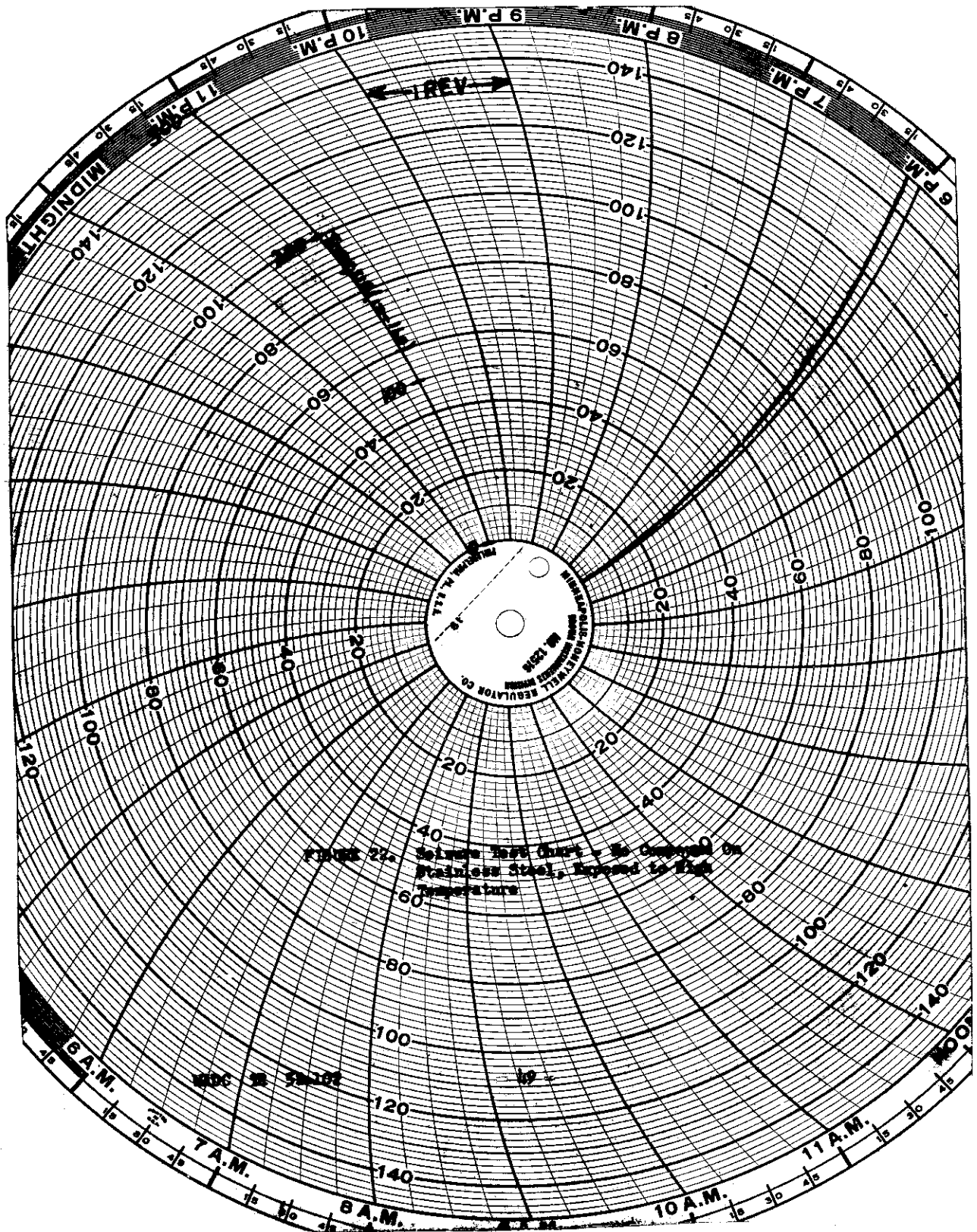

Contrails

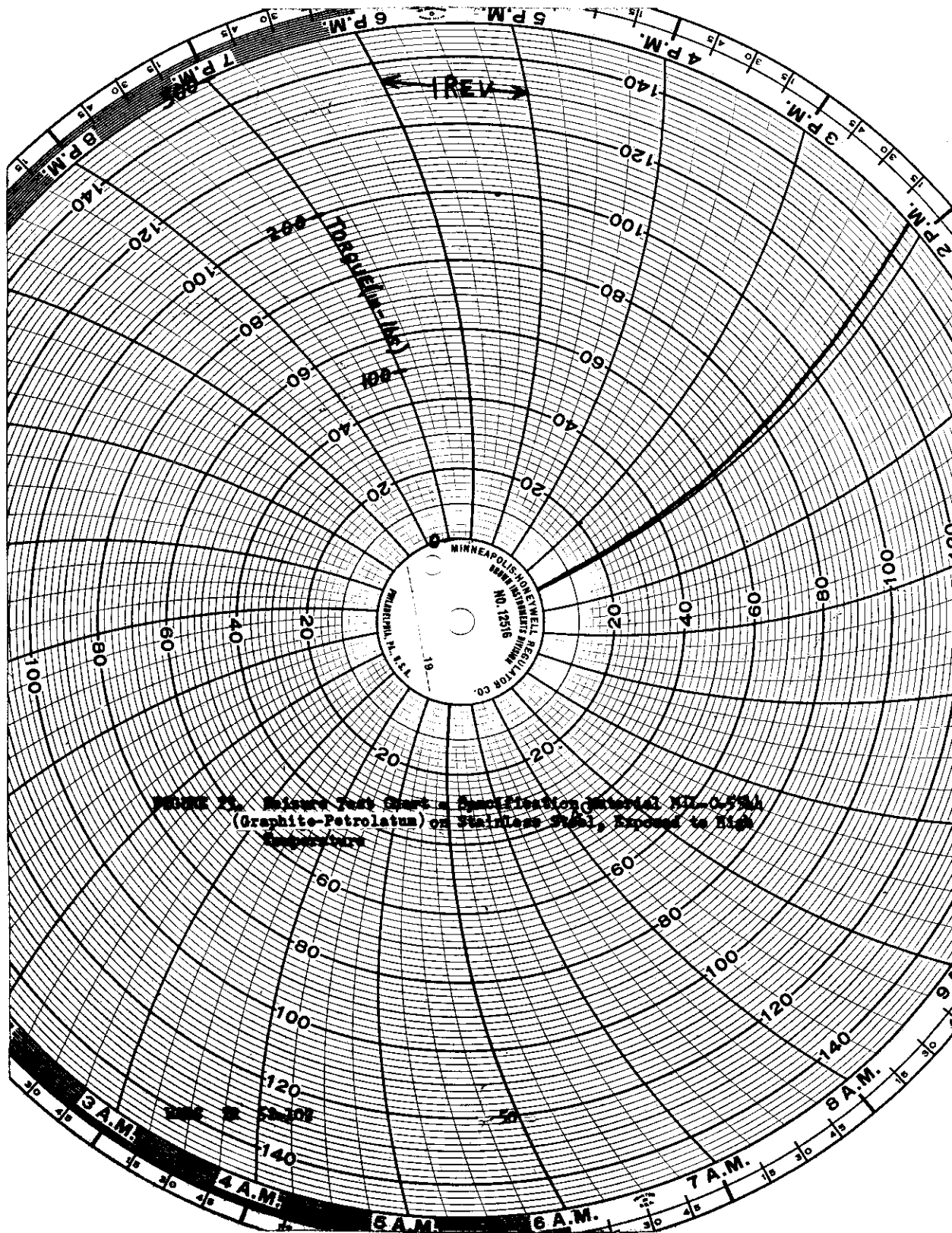
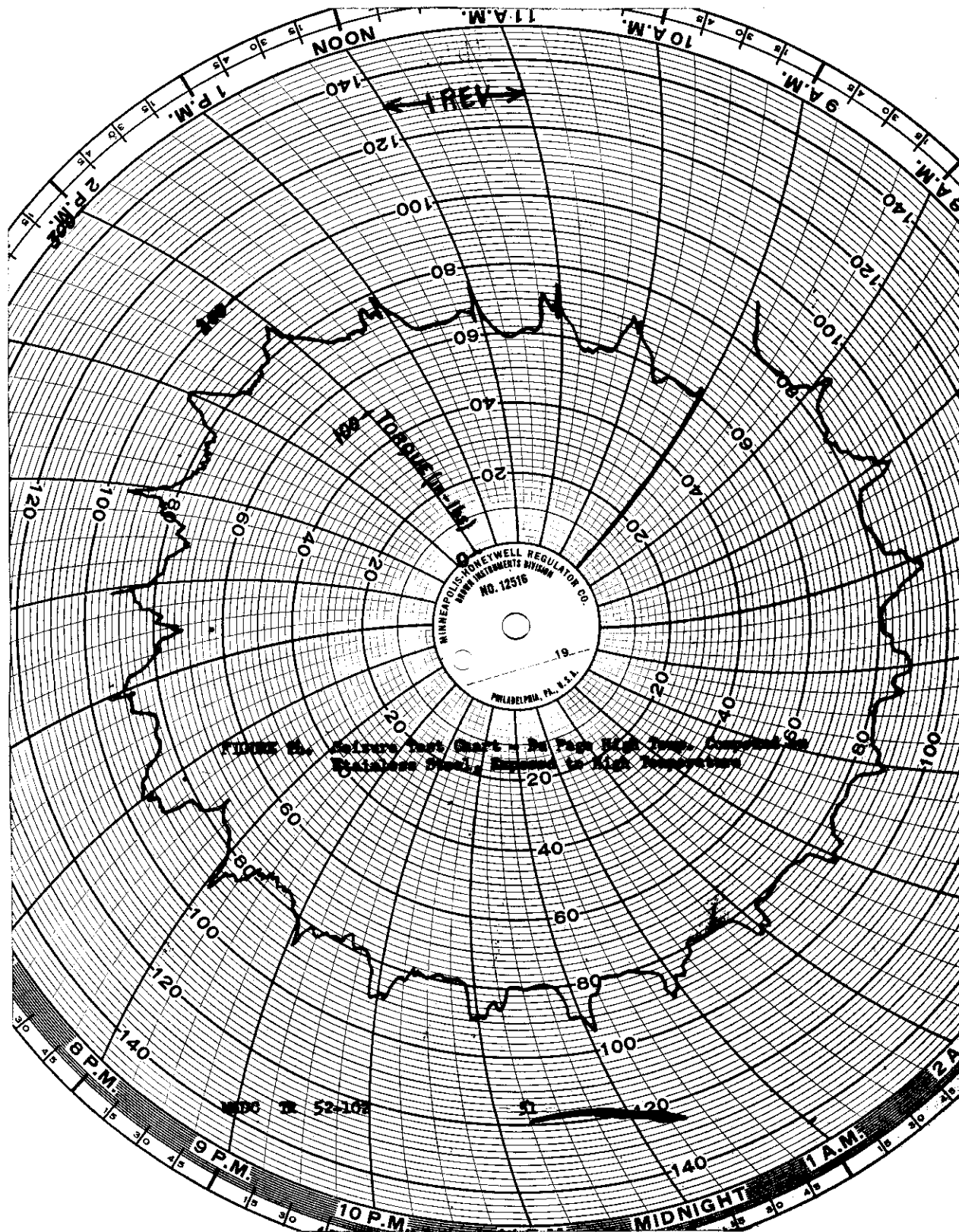
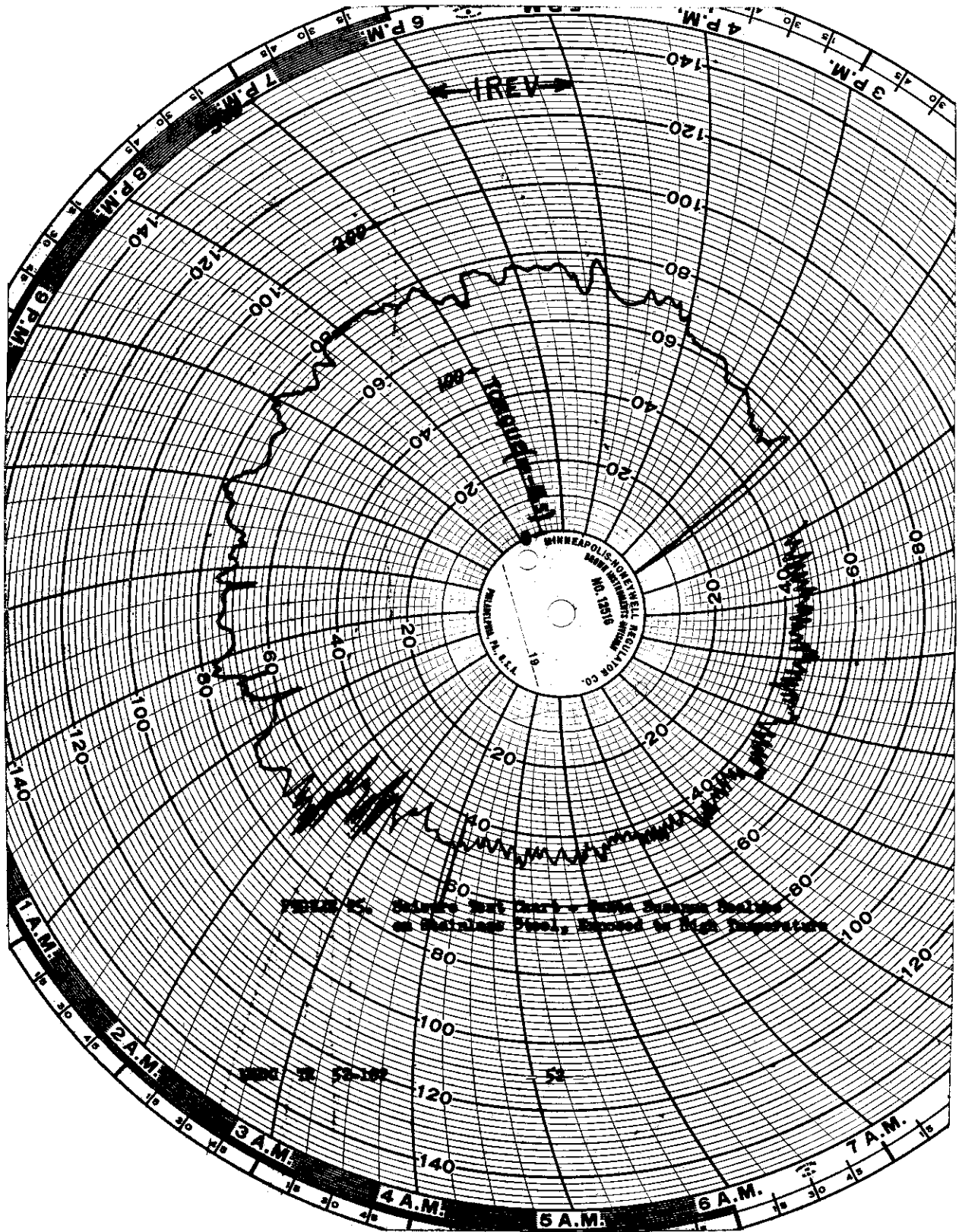

FIGURE 11. Release Test Curve - Specification Material MIL-C-554A (Graphite-Petrolatum) on Stainless Steel, Exposed to High Temperatures

Contrails



Contrails



Contrails

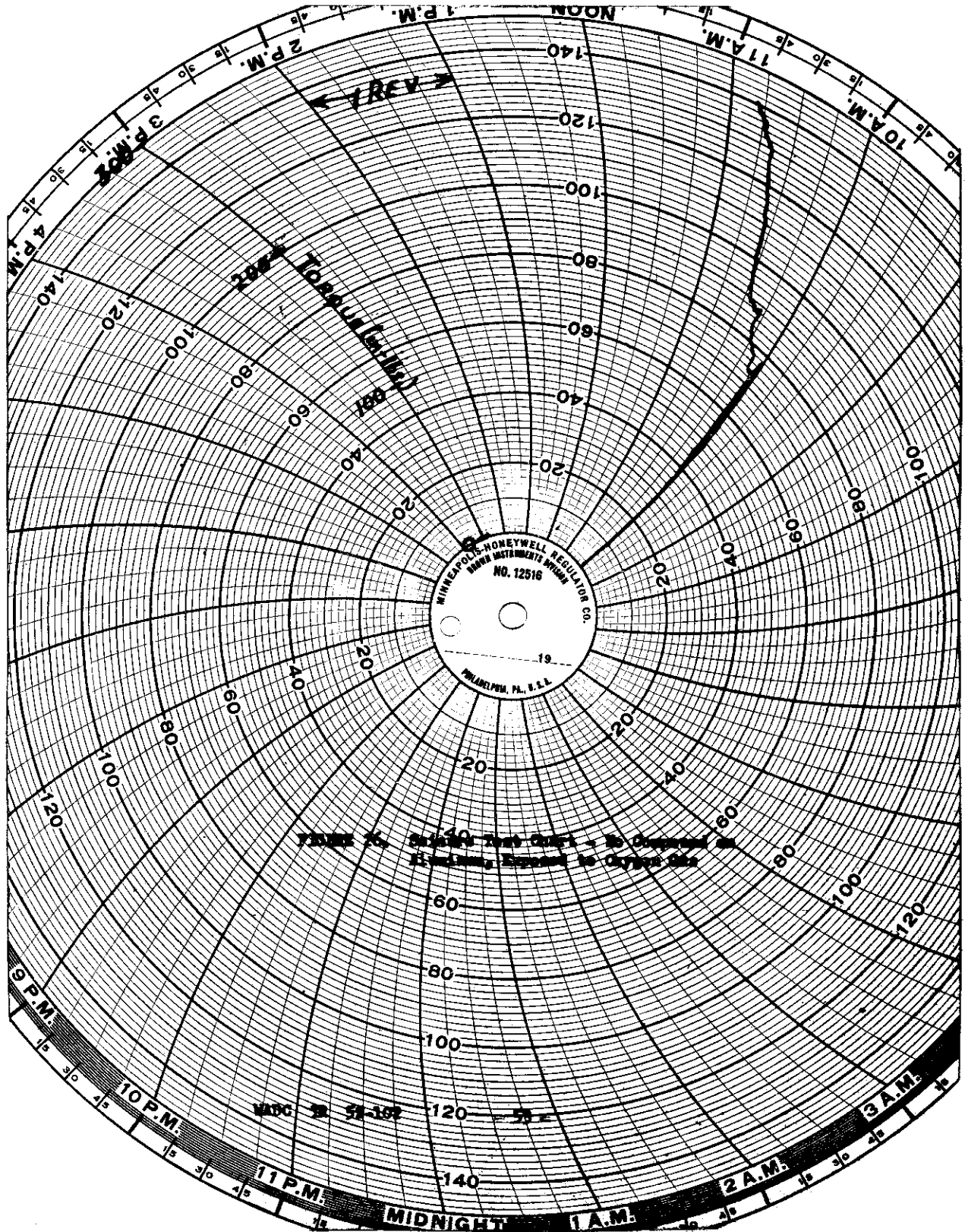

Contrails

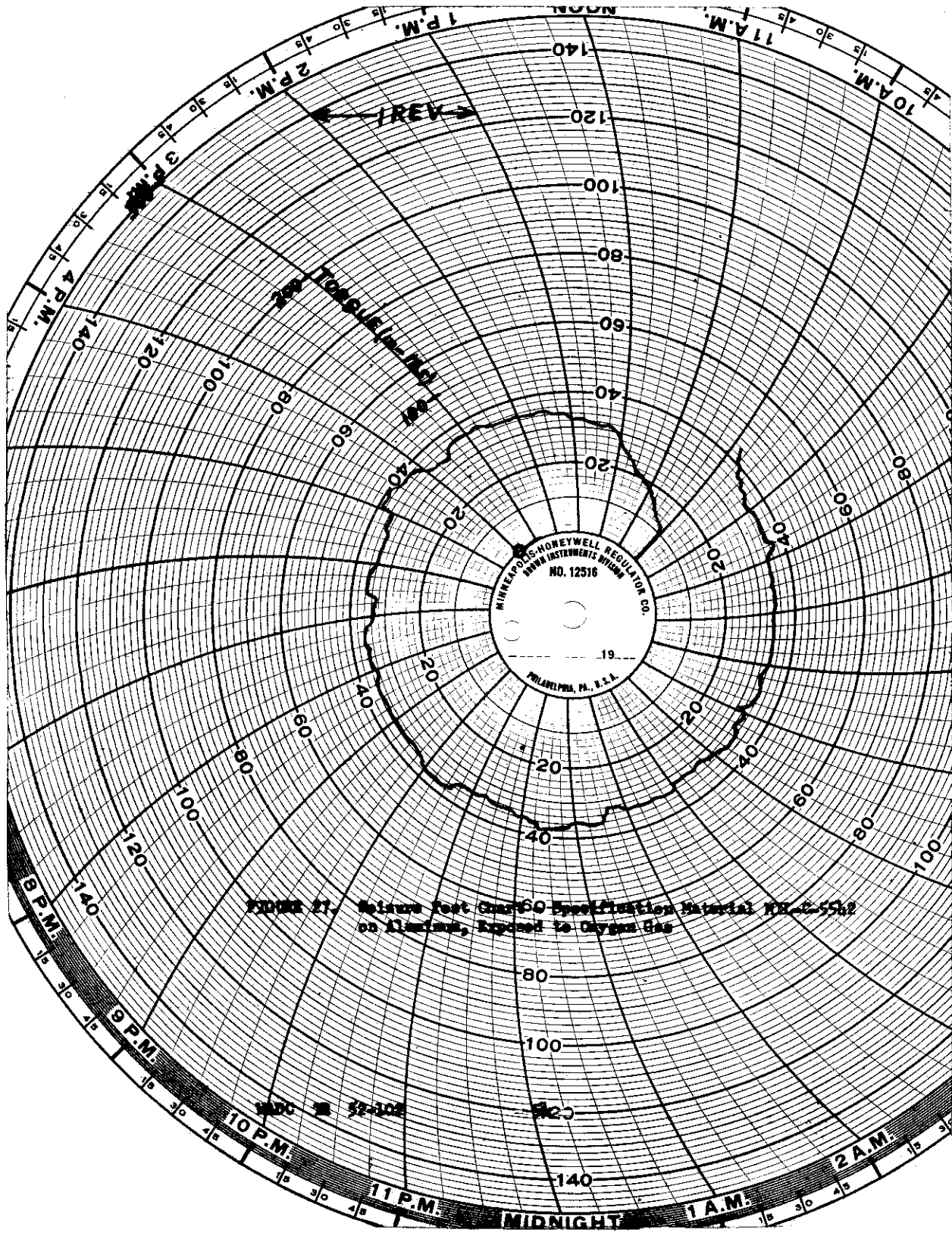

FIGURE 21. Seizure Test Chart 60 Specification Material RR-C-5542 on Aluminum, Exposed to Oxygen Gas

Contrails

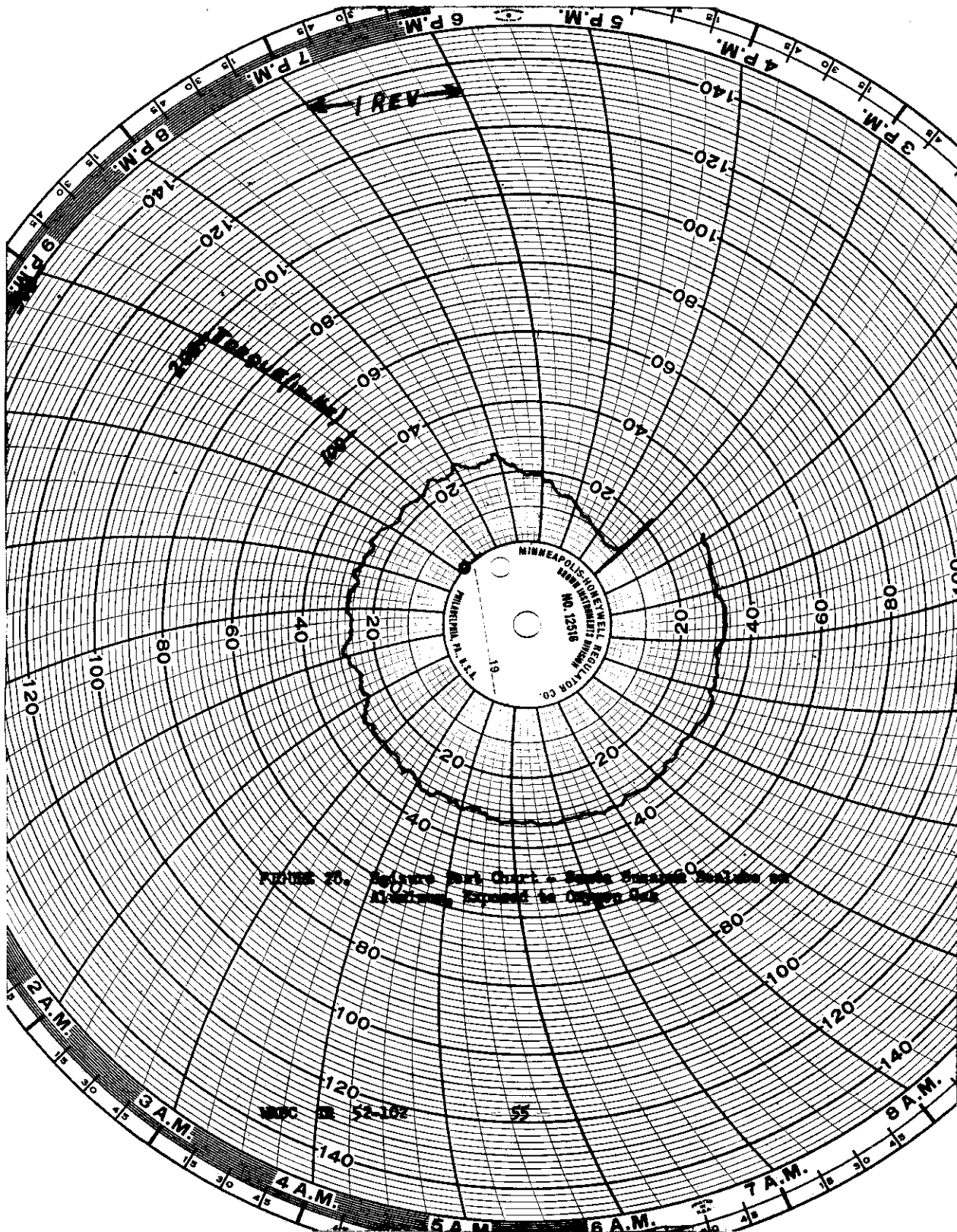
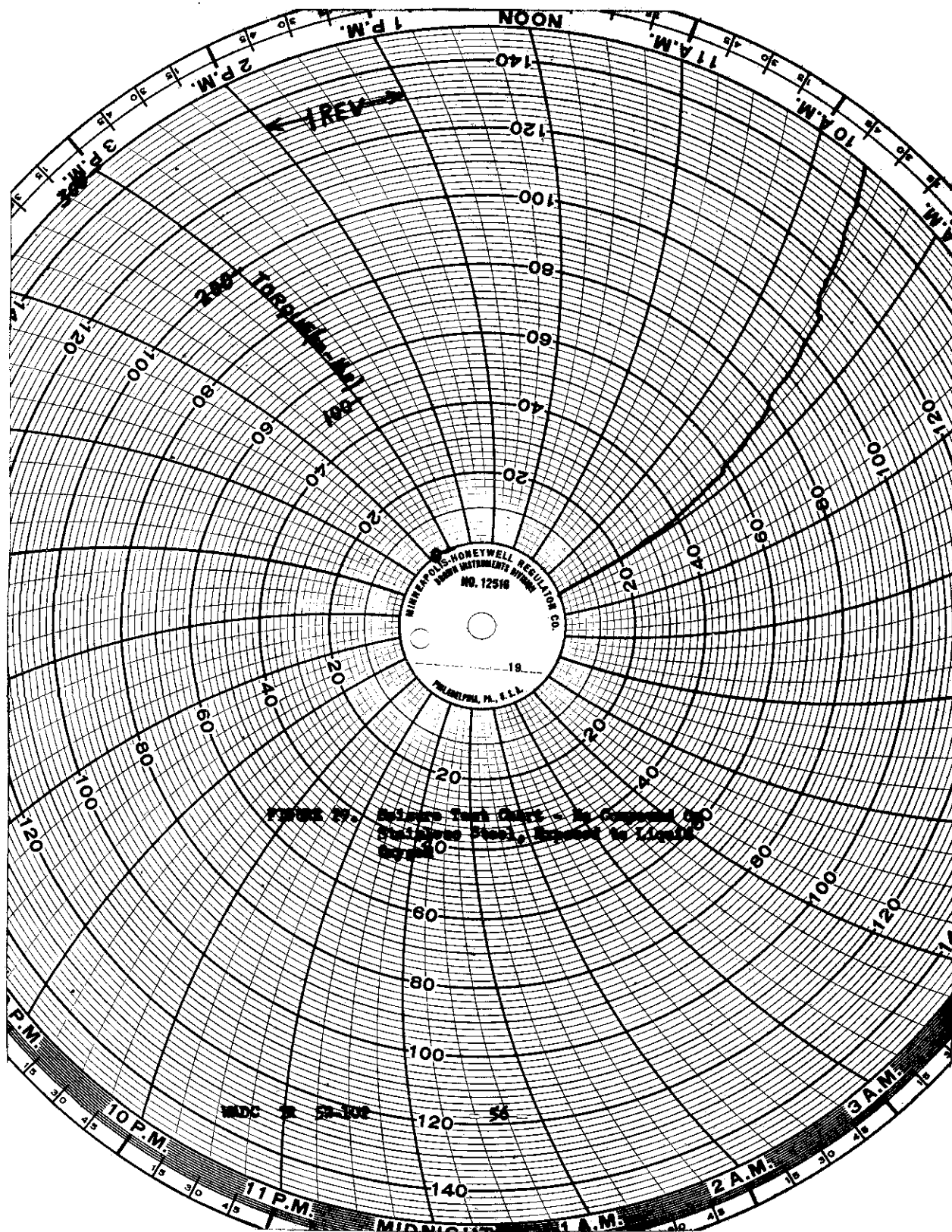
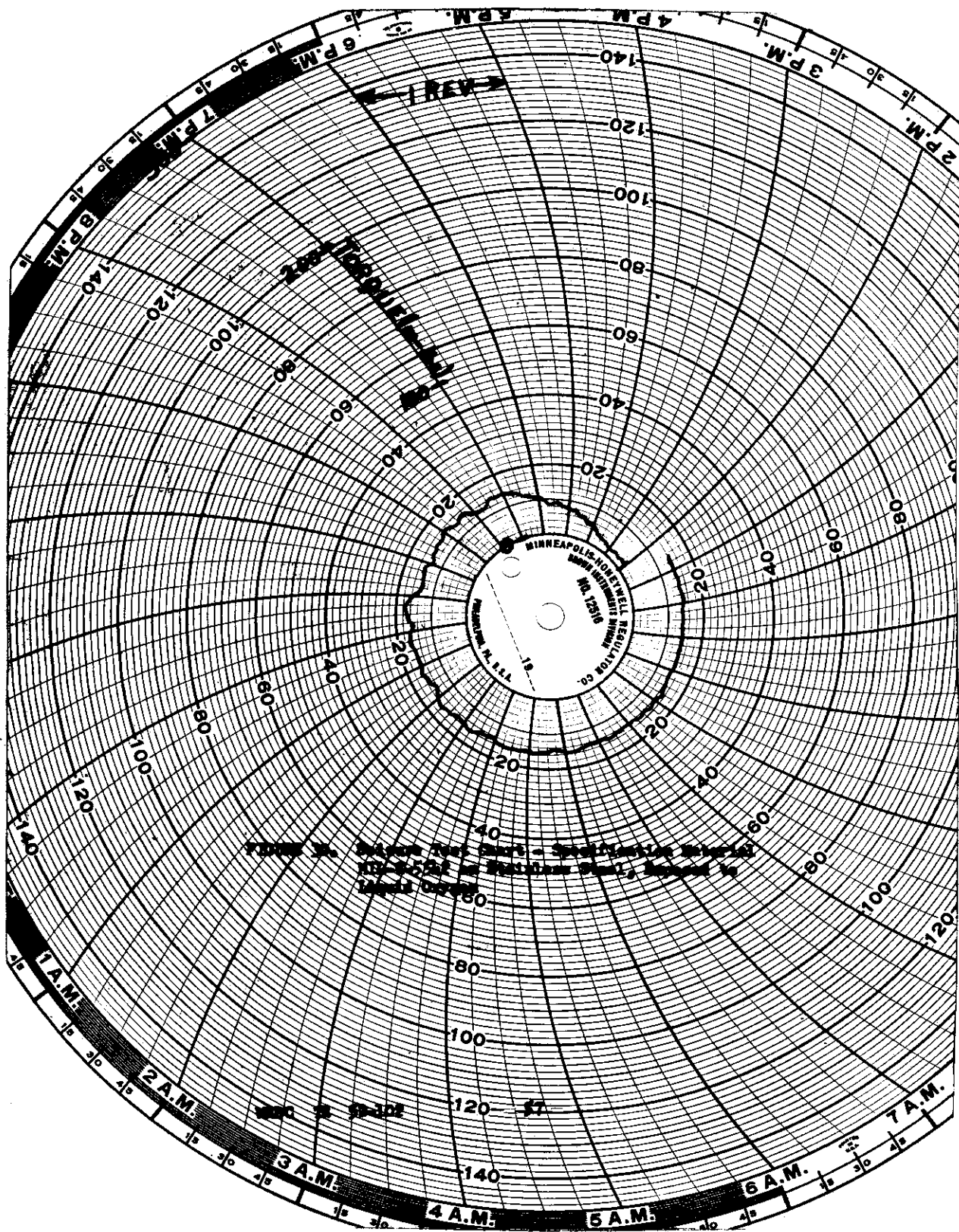

FIGURE 26. Software Part Chart - Sample Tracking Section for
Reference, Expanded for Display Size

Contrails



Contrails



Contrails

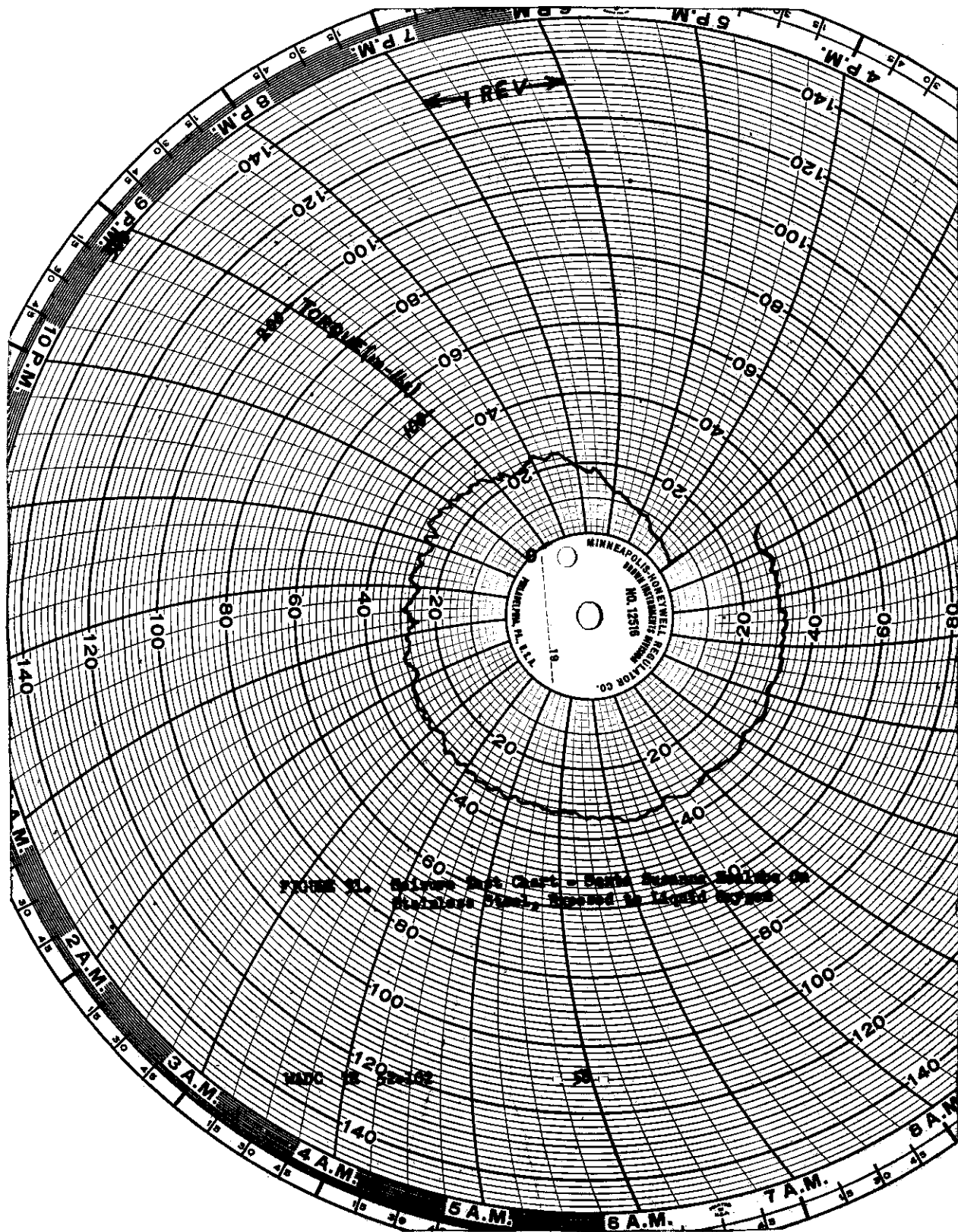

Contrails

TABLE II. - Seizure Test Data - Tapered Pin Specimens
Tested with Seizure Tester, Model II.

Specimen No.	Specimen Material	Anti-Seize Compound	Break-point (in-lbs)	Max. Torque Recorded (in-lbs)	Rotation Req'd for Seizure (Revs.)	Condition of Test Surfaces
--------------	-------------------	---------------------	----------------------	-------------------------------	------------------------------------	----------------------------

I - Exposed to High Temperature - 1200° F., 6 hours

A-1 A-2 A-3 A-4 A-5	Stainless Steel type 302	None	did not break	300	<1	Galled
B-1 B-2 B-3 B-4 B-5	Stainless Steel type 302	Graphite Petrolatum	did not break	300	<1	Galled
C-1 C-2 C-3 C-4 C-5	Stainless Steel type 302	Du Page	94 172 170 175 164	160 212 198 192 212	did not seize	Coated with dark film; continuous grooves; no galling.
D-1 D-2 D-3 D-4 D-5	Stainless Steel type 302	Santa Suzanna	132 117 170 140 113	164 160 161 173 161	did not seize	bright, shiny; few grooves; no galling

II - Exposed to Oxygen Gas - 450 psi, 160° F., 6 hours

A-1 A-2 A-3 A-4 A-5	Stainless Steel type 302	None	110 117 120 112 112	300	<1	Galled
A-6 A-7	Aluminum	None	156 120	282 214	<1	Galled
A-8 A-9	Brass	None	88 74	125 140	<1	Galled

Contrails

TABLE II. - Seizure Test Data - Tapered Pin Specimens
Tested with Seizure Tester, Model II (cont'd)

Specimen No.	Specimen Material	Anti-Seize Compound	Break-point (in-lbs)	Max. Torque Recorded (in-lbs)	Rotation Req'd for Seizure (Revs.)	Condition of Test Surfaces
A-10	Mild Steel	None	did not break	300	<1	Galled
A-11			65			
B-1	Stainless Steel type 302	Abso-LUTE	14	34	did not seize	black, mobile film; no surface damage.
B-2			9	40		
B-3			14	50		
B-4			16	72		
B-5			8	67		
B-6	Aluminum	Abso-LUTE	21	87	did not seize	black film; grooved some galling
B-7			11	102		
B-8	Brass	Abso-LUTE	14	48	did not seize	black film; some grooves.
B-9			21	48		
B-10	Mild Steel	Abso-LUTE	16	300	17	Galled
B-11			12		4	
C-1	Stainless Steel type 302	Santa Suzanna	30	72	did not seize	mobile film intact; no surface damage.
C-2			34	80		
C-3			22	70		
C-4			28	73		
C-5			22	68		
C-6	Aluminum	Santa Suzanna	37	62	did not seize	film worn; slight surface damage.
C-7			47	68		
C-8	Brass	Santa Suzanna	32	58	did not seize	film broken; some damage.
C-9			51	64		
C-10	Mild Steel	Santa Suzanna	28	93	did not seize	film intact; slight damage to one specimen
C-11			50	81		

III - Submerged in Liquid Oxygen - 6 hours

X-1	Stainless Steel type 302	None	116	300	<1	Galled
X-2			>300			
X-3			92			
X-4			116			
X-5			>300			
Y-1	Stainless Steel type 302	Abso-LUTE	7	34	did not seize	film intact; no surface damage.
Y-2			4	61		
Y-3			6	36		
Y-4			6	41		
Y-5			6	30		
Z-1	Stainless Steel type 302	Santa Suzanna	16	66	did not seize	film interrupted; no surface damage.
Z-2			28	68		
Z-3			18	72		
Z-4			18	65		
Z-5			15	65		

Discussion

Efforts directed toward improvement of the accuracy and practical operation of the original seizure tester resulted in the design and construction of an entirely new machine based on the same principles. Seizure tests conducted with the new tester proved it capable of providing reproducible results with good overall accuracy. In general, when five duplicate tests were run with this machine, four out of the five resulting torque curves would match each other almost perfectly; one out of each five would disagree. This disagreement was probably due to variations in the machining of the test specimens or to variations in the metal from which they were constructed. On the basis of present experience, it is believed that three tests will be the maximum number required for the evaluation of an anti-seize compound at any one set of test conditions.

The versatility of the basic test method is illustrated by the variety of tests conducted during its evaluation. The results of these tests show that it is suitable for determining the relative effectiveness of anti-seize compounds designed for:

- (1) High temperature service
- (2) Aircraft oxygen system service
- (3) Liquid oxygen system service.

The seizure test provides a quantitative measurement of the galling characteristics of a test surface. By use of tapered pin specimens, test surfaces of any metal or alloy can be coated with an anti-seize compound and exposed to simulated use conditions before testing. Consequently, the basic test method can be used to evaluate anti-seize compounds for any specific application.

As a result of the seizure tests reported in this section, the following conclusions can be drawn concerning the effectiveness of each of the anti-seize compounds tested:

- (1) Graphite-Petrolatum (Specification Material MIL-C-55141) is not effective in applications where operating temperatures reach 1200°F. or higher. The maximum allowable temperature for this compound can be determined by this test method but this has not yet been done.
- (2) Du Page High Temperature Thread Compound prevents galling and seizure of type 302 stainless steel after exposure to 1200°F. for six hours.
- (3) Santa Suzanna Sealube prevents galling and seizure of

type 302 stainless steel after exposure to 1200°F. for six hours. This compound also prevents galling of type 302 stainless steel, aluminum, brass, and mild steel after exposure to oxygen gas at 450 psi and 160°F. for six hours. In addition, galling of stainless steel is prevented after exposure to liquid oxygen for six hours.

- (4) Abso-LUTE Oxygen Sealing Compound (Specification Material MIL-C-5542) prevents the galling and seizure of type 302 stainless steel, aluminum, and brass after exposure to oxygen gas (450 psi, 160°F., six hours); also, it prevents galling of stainless steel after exposure to liquid oxygen (six hours). Two tests indicated seizure of mild steel with this compound after exposure to oxygen gas, but further investigation should be undertaken before drawing a definite conclusion in this case.

It is believed that valid comparisons between effective compounds can be made by further analysis of variations in torque curves. However, the full significance of all the variations is not yet fully understood. The results of future work, especially a thorough correlation of the test method with actual field performance, will make possible a more complete analysis of test data.

SECTION IV

CORRELATION OF TEST RESULTS WITH OTHER PERFORMANCE RATINGS

Simulated Performance Tests

A thorough correlation between the proposed seizure test methods and other performance ratings was not included in the scope of this phase of the investigation but some preliminary work was done along these lines as a check on the overall validity of the test methods. Simulated performance tests were conducted in parallel with the seizure tests reported in Section III. Test specimens and exposure conditions were selected which would duplicate actual field applications as much as possible. The three specific applications

considered were those mentioned in the primary object of the investigation, namely, high temperature service, aircraft oxygen system service, and liquid oxygen system service. The general procedure for these tests was to:

- (1) Select a standard connection or fastener common to each specific application,
- (2) Apply an anti-seize compound to the male contacting surface,
- (3) Assemble and tighten the connection to a standard torque value,
- (4) Expose to simulated conditions common to the application, and
- (5) Measure the torque required to disassemble the connection.

Figure 32 shows the type of test specimen selected for each specific application and also the wrenches used for measuring the torque required for assembly and disassembly of these specimens. These simulated performance tests and the tapered pin seizure tests discussed in Section III are strictly comparative since the same anti-seize compounds were used and exposures were conducted simultaneously in the same equipment under identical conditions.

High Temperature Service Tests

Standard cap screws and nuts were selected as test specimens for the high temperature service tests. These were $3/8" \times 1 1/4" - 24(NF)$. A small length of pipe (length - $7/8"$) was used as a spacer between the head of the bolt and the nut as shown in Figure 32. All of the component parts were constructed from type 304 stainless steel (same as type 302 except that a maximum carbon content is specified). Ten specimen assemblies were used for each anti-seize compound tested. Each specimen assembly was tightened to a torque value of 16 ft.-lbs. (190 in.-lbs.) before heating. This is the recommended torque value for tightening standard nickel steel bolts. Standard values were not available for stainless steel bolts. All specimen assemblies were heated to $1200 \pm 10^{\circ}F.$ for six hours. After cooling, these specimens were then disassembled. The maximum torque required in each case is listed in Table 3.

The following observations were noted concerning the behavior of each compound during this series of tests:

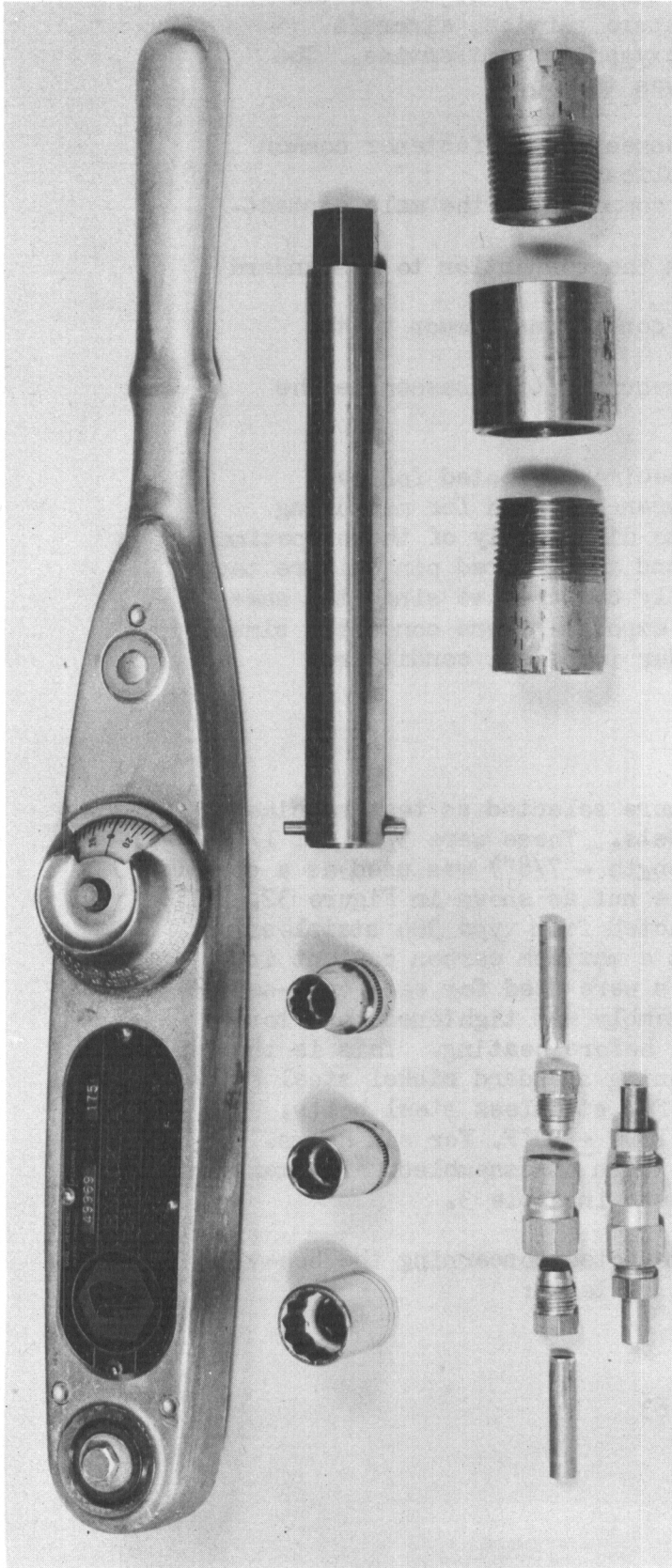

OXYGEN GAS EXPOSURE

LIQUID OXYGEN EXPOSURE

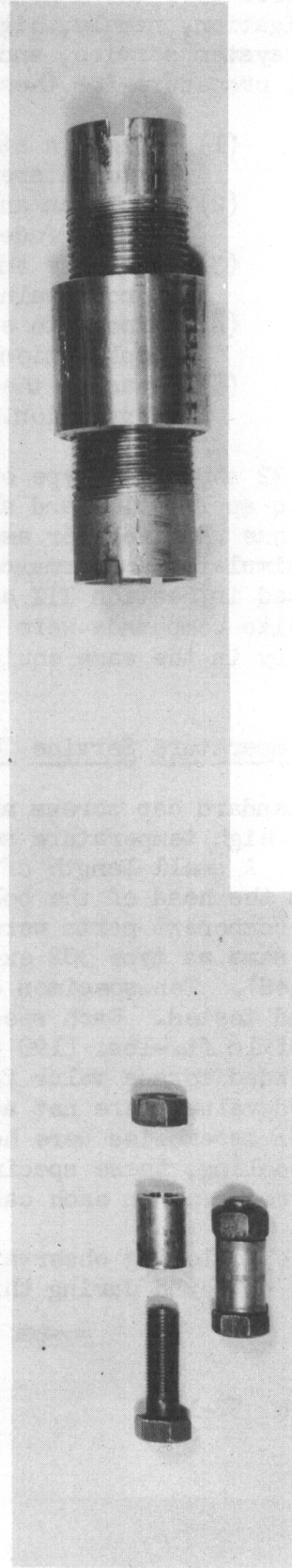

HIGH TEMPERATURE EXPOSURE

FIGURE 32. Wrenches and Specimens Used for Simulated Performance Test

Contrails

TABLE III. Maximum Torque Required to Disassemble Stainless Steel Bolts and Nuts at Room Temperature After Six Hours at 1200°F. (Nuts initially tightened to 16 foot-pounds)

Specimen No.	Torque (foot-pounds)			
	No Compound	Graphite-Petrolatum (MIL-C-5514)	Du Page High Temp. Thread Compound	Santa Suzanna Sealube
1	45	46	22	24
2	48	52	22	24
3	50	48	23	26
4	52	47	21	26
5	48	49	20	26
6	49	48	21	24
7	49	49	20	22.5
8	48	21	22	26
9	47	47	22.5	26
10	48	50	20	24

Contrails

- (1) No Compound - Nuts could be loosened at a moderate torque value (24-26 ft.-lbs.); however, all bolts sheared before nuts could be completely removed.
- (2) Graphite-Petrolatum - Nuts could be loosened at a moderate torque value (20-22 ft.-lbs.); however, nine out of ten bolts sheared before nuts could be completely removed.
- (3) Du Page - Nuts were loosened at the torque values listed in Table 3. After initial loosening, nuts could be removed by hand. Threads were undamaged.
- (4) Santa Suzanna - Nuts were loosened at the torque values listed in Table 3. After initial loosening, nuts were removed at a lower torque, but a wrench was necessary. Threads were undamaged.

In order to further compare and evaluate the Du Page and Santa Suzanna compounds, the test specimens were repeatedly assembled with a torque of 25 foot-pounds and then disassembled for five consecutive times. These specimens were not subjected to additional heating cycles and additional compound was not applied. The torque required for loosening was lower in all cases than the initial values listed in Table 3. Surfaces of the threads remained undamaged.

Aircraft Oxygen System Service Tests

Aluminum alloy tubing unions were selected as specimens for gaseous oxygen system service tests. The complete assembly is shown in Figure 32. Short lengths of 5/16 inch aluminum alloy tubing were used in conjunction with 5/16 inch aluminum alloy tubing unions (Imperial No. 282-AL). This was the only type of aluminum union that could be purchased for delivery within the allotted time. Unfortunately, the threads were very loose fitting and their surfaces were anodized in order to reduce galling and seizure tendencies to a minimum.

Ten threaded test areas (five specimen assemblies) were used for each of the anti-seize compounds tested. Compound was applied to the male threads and each nut tightened to a torque value of 21 ft.-lbs. (250 inch-pounds). This value was based on data for pipe fittings

Contrails

of similar size (listed in Specification MIL-C-5542). Specimen assemblies were exposed to oxygen gas at 450 psi and 160°F. for six hours. The maximum torque required to disassemble these specimens was measured; then, the nuts were re-tightened and loosened four additional times without renewed application of compound. The maximum torque value required for each disassembly is listed in Table 4.

It will readily be seen from the test data that the aluminum tubing fittings were unsuitable for seizure tests. Actual galling and seizure did not occur under any conditions. The threads actually "bottomed" in the assembled condition, and tightening to higher torque values merely stripped the bottom threads. No valid conclusions could be drawn from this series.

Liquid Oxygen System Service Tests

Type 304 stainless steel pipe fittings were selected as specimens for liquid oxygen system tests. One inch nipples and couplings were assembled as shown in Figure 32. Ten threaded connections (five assemblies) were used for each compound tested. The male threads were coated with compound and the connections assembled with a torque value of 100 foot-pounds (1200 in.-lbs.). This value was selected from data listed in Specification MIL-C-5542. The assembled specimens were immersed in liquid oxygen at 1 atmosphere pressure for six hours. The maximum torque required to loosen these connections was then measured. These values are listed in Table 5.

The following observations were noted concerning the behavior of each compound during this series of tests:

- (1) No Compound - The threads were severely damaged on these specimens. Galling occurred as the thread was tightened and actually prevented satisfactory assembly. In this case, the torque values required for disassembly do not indicate the extent of damage satisfactorily.
- (2) Abso-LUTE - This compound appears to be the best lubricant according to these tests. There was no damage to the threads even after re-tightening each assembly five consecutive times. Prime contractors of missiles for the Air Force have reported that this compound is unsatisfactory for

Contrails

TABLE IV. - Maximum Torque Required to Disassemble
Aluminum Tubing Fittings at Room Temperature
after Six Hours in Oxygen Gas, 450 psi, 160°F.
(Nuts initially tightened to 21 foot-pounds)

Specimen No.	Compound	T O R Q U E (ft.-lbs.)				
		First Disassembly	Second	Third	Fourth	Fifth
A-1-L	No Compound	15	12.5	13	16	15
A-1-R		12	12.5	12.5	15	20
A-2-L		12.5	14	17	16	17
A-2-R		12.5	16	14	14	15
A-3-L		12.5	14	15	14	14
A-3-R		12	13	16	15	15
A-4-L		14	14	14	13	14
A-4-R		11	14	14.5	14	14
A-5-L		11	16	16	14.5	15.5
A-5-R		15	15	18	16	16
B-1-L	Santa Suzanna Sealube	12.5	13	14	15	15
B-1-R		14	10	14	14	15
B-2-L		12	11	14	15.5	15
B-2-R		14	14	15	13	14
B-3-L		12.5	15	15	15	16
B-3-R		12.5	15	14	15	15
B-4-L		12.5	14	14.5	15	15
B-4-R		15	14	14	14	15
B-5-L		14	16	14	15	15
B-5-R		14	15	15	15	16
C-1-L	Abso-IUTE Oxygen Sealing Compound	11	15	15	15	14
C-1-R		11	15	15	16	15
C-2-L		11	14	15	17	15
C-2-R		11	14	12.5	14	15.5
C-3-L		12	12	16	17	16
C-3-R		9	14	15	12.5	17
C-4-L		12	14	15	15	15
C-4-R		9	11	14	14.5	14.5
C-5-L		11	15	15.5	15	17
C-5-R		12	14.5	15	14	16

Contrails

TABLE V. Maximum Torque Required to Disassemble Stainless Steel Pipe Fittings at Room Temperature After Six-Hour Immersion in Liquid Oxygen (Fittings initially tightened to 100 foot-pounds)

Specimen No.	Torque (foot-pounds)		
	No Compound	Abso-LUTE Oxygen Sealing Compounds (Spec. Mat'l. MIL-C-5542)	Santa Suzanna Sealube
1-L	94	75	85
1-R	71	83	89
2-L	127	78	106
2-R	67	78	93
3-L	76	84	120
3-R	48	73	106
4-L	57	71	130
4-R	124	77	103
5-L	90	81	98
5-R	64	73	69

Contrails

use in liquid oxygen systems. No basis has been found for such a conclusion during this investigation of anti-seize properties. It is possible that it is not an effective sealant under these conditions.

- (3) Santa Suzanna - Anti-seize properties were good. Specimen threads were not damaged even after five consecutive reassemblies. "Chattering" which occurred during tapered pin seizure tests as well as this series indicates that lubricating properties could be improved.

Discussion

An adequate evaluation of new test methods depends to some extent on a correlation of the test results with other types of performance ratings. Comparison between various testing methods is also helpful in arriving at correct interpretations of the data obtained during the development of new methods. In this case, ratings have previously been based on field performance data and simulated performance methods of testing.

A preliminary correlation has been obtained by a general comparison between the results of tapered pin seizure tests and the other performance ratings. This comparison which is shown by Table 6 indicates that the seizure test methods provide essentially the same results as simulated performance tests and field performance records. Although the ratings listed are very general in nature, the correlation shows that the basic principles of the proposed test methods are correct. A more detailed correlation is scheduled to be included in future work on this project. This together with further test development work is expected to show that a finer distinction can be made between anti-seize compounds by tapered pin seizure test than by any current method of evaluation.

SECTION V

SUMMARY AND CONCLUSIONS

Previous work by other investigators in the field of test methods for the evaluation of anti-seize compounds has been confined

TABLE VI. Preliminary Correlation of Seizure Test Methods With Other Performance Ratings

Specific Application	Anti-Seize Compound	Seizure Test Results		Other Performance Ratings	
		Seizure Tester Model I	Seizure Tester Model II	Field Performance Data	Simulated Performance Data
General Purpose (room temp.)	None				
	Lube Oil	Bad		Bad	
	Graphite-Petrolatum	Very Poor		Very Poor	
High Temperature (1200°F.)	None	Good		Good	
	Graphite-Petrolatum	Bad	Bad	Bad	Bad
	Du Page	Bad	Bad	Bad	Bad
	Santa Suzanna	Good	Good	Good	Good
Aircraft Oxygen Systems	None				
	Abso-LUTE			Bad	
Liquid Oxygen Systems	Santa Suzanna		Good	Not Always Satisfactory*	
	None			Good	
	Abso-LUTE		Bad	Bad	Bad
	Santa Suzanna		Good	Good	Good

* Information source -- Exhibit A of Contract No. AF 33(038)22805. These comments may refer to sealing or other properties of the compound.

Contrails

largely to actual or simulated field application testing. During this investigation and development program, the problem has been attacked from a somewhat different viewpoint. It is believed that a testing method has been proposed which is unique in that the basic method and testing equipment can be used to evaluate anti-seize compounds for all the varied applications in which the Air Force is interested. It is also believed that the proposed testing method will have great value as a research tool. The test data is recorded in a form suitable for detailed analysis and interpretation. Many fundamental characteristics of anti-seize compounds can be determined from such analysis of the data curves. By this means, the individual components of each compound could be tested separately and their function in the overall performance of the mixture could be accurately determined. Such information would make possible the evaluation of a large number of new materials and would aid in the selection of the optimum composition of new anti-seize compounds designed for specific applications.

The test development began with a literature survey and preliminary experimental work designed to define the problems involved. During this period it was concluded that seizure at low speeds is a result of the progressive deformation of contacting surfaces following relative motion between the two. This occurrence is known as galling and is a function of the work-hardening properties of metals. It was soon recognized that anti-seize compounds could best be evaluated by measuring the degree to which they effected the galling characteristics of metal surfaces. In order to do this, it was necessary to find a practical method for measuring galling characteristics. Several procedures were used for inducing galling and producing a forced seizure between various types of metal specimens. During this exploratory work, it was observed that when one of two contacting surfaces was rotated relative to the other, the torque required for rotation was a quantitative indication of the amount of surface damage leading to seizure. This principle was used as a basis for the testing methods and the testing equipment subsequently devised.

The proposed universal testing method is basically a means of determining in graphic form the galling characteristics of a standard metal surface. Special testing equipment was designed and constructed for measuring the torque required for the counter-rotation of two standard test surfaces under a controlled compressive load. With this equipment the torque value is recorded

Contrails

automatically on a circular chart as a function of the magnitude of rotation. Anti-seize compounds are evaluated by comparing their effectiveness which is indicated by these torque curves.

The first model of the seizure tester was designed to study the importance of the controlling variables, to formulate tentative testing procedures, and to develop suitable test specimens. One of the major problems was to find a means for evaluating anti-seize compounds for specific applications. This was solved by developing a special test specimen consisting of a tapered pin and block combination. This type of specimen can be assembled with a sample compound between the contacting surfaces, exposed to high temperatures or other simulated use conditions, and then tested for seizure without spoiling the intimate contact between surfaces. The selection of a self-holding tapered fit as the shape of the test surface made possible the universal application of the basic test method.

Testing procedures were further developed by the construction of an improved model of the seizure tester. This machine was based on the same principles as the first model but with modifications resulting from experience during the primary evaluation. With the improved seizure tester, it is possible to do rapid, routine testing with accurate, reproducible results. Several commercial anti-seize compounds were evaluated for three specific applications in order to illustrate the versatility of the seizure test methods and to further perfect the testing procedures. In addition, a preliminary correlation was obtained with known field performance records and simulated performance test data. The results of this evaluation indicate the promising possibilities that can be expected from further development of this type of test method.

The following conclusions are substantiated by the results of this work:

- (1) Seizure of threaded connections and other tight fits is caused by galling of the contacting surfaces.
- (2) The galling characteristics of metal surfaces can be measured quantitatively by the use of specialized testing techniques and equipment.
- (3) The effectiveness of anti-seize compounds can be determined by observing their influence on these measured galling characteristics.
- (4) Anti-seize compounds can be evaluated for specific applications on the basis of their effectiveness after exposure to conditions

Contrails

- common to each application.
- (5) The proposed test method with some variations in procedure can be used to evaluate anti-seize compounds for:
- (a) High temperature service (1200°-2000°F.)
 - (b) Aircraft oxygen system service
 - (c) Liquid oxygen system service
 - (d) Similar specific applications

BIBLIOGRAPHY

In addition to specific references to information on the galling and seizure of metal surfaces, this bibliography includes several related subjects which were considered helpful in the development of test methods for anti-seize compounds. The list is subdivided according to subject matter, and each group is arranged chronologically beginning with the latest date.

I. Galling and Seizure

McFarlane, J. S. and Tabor, D. Adhesion of Solids and Effect of Surface Films. Royal Society Proceedings. Volume 202, No. 1069, Serial A. July 7, 1950. pp. 224-43.

Schnurmann, R. Discussion on the Seizure of Metals and on Boundary Friction. Institute of Mechanical Engineering Journal. Volume 160, No. 3. 1949. p. 397.

Tabor, D. Discussion on the Seizure of Metals and on Boundary Friction. Institute of Mechanical Engineering Journal. Volume 160, No. 3. 1949. p. 395.

Ford, Hugh. Discussion on the Seizure of Metals and on Boundary Friction. Institute of Mechanical Engineering Journal. Volume 160, No. 3. 1949. p. 397.

Factors Reducing Seizure and Wear. Institute of Mechanical Engineering Journal. Volume 160, No. 3. 1949. p. 382.

Bowden, F. B. and Tabor, D. The Adhesion of Metals. Institute of Mechanical Engineering Journal. Volume 160, No. 3. 1949. p. 381.

Bowden, F. B. and Tabor, D. The Shearing of Metallic Junctions. Institute of Mechanical Engineering Journal. Volume 160, No. 3. 1949. p. 381.

Factors Favouring Seizure. Institute of Mechanical Engineering Journal. Volume 160, No. 3. 1949. pp. 381, 382.

Contrails

Bowden, F. B. and Tabor, D. Seizure of Metals. Institution of Mechanical Engineers.-Proc. Volume 160, No. 3. 1949 pp. 380-3; 392-402; see also Engineer. Volume 187, No. 4863. April 8, 1949. pp. 395-7.

What is Bearing Seizure? Mechanical World. Volume 125, No. 3255. June 3, 1949. pp. 645-6.

Schottky, M. and Hiltenkamp, H. How Atmospheric Nitrogen Encourages Galling and Fatigue Failures. Steel. Volume 123, No. 1. July 5, 1948. pp. 97,110, 113-4.

Bychinsky, W. A.; Ford, J. T.; Kirk, W. S. (to General Motors Corp.) Prevention of Seizure of Metal Parts. April 22, 1947. U. S. Patent 2,419,252.

Parker, A. L. Anti-seize Lubricating Paste for Sealing Threaded Joints Between Metals Such as Aluminum and Its Alloys. Feb. 23, 1942. U. S. Patent 2,311,772

Nelson, Roy F. and Hurwitc, W. S. (to Texas Company) Lubrication For Use on Pipe Threads to Prevent Seizing, Galling and Stripping. June 25, 1940. U. S. Patent 2,205,990.

Place, Charles E. (to Clare L. Brackett) Inhibiting Screw-Thread Seizure. Sept. 12, 1939. U. S. Patent 2,173,003.

Underwood, A. F. Some General Aspects of Rubbing Surfaces. Proceedings of the Conference on Friction and Surface Finish, Massachusetts Institute of Technology. 1940.

Seizure of Metals at Elevated Temperatures. Report of Subgroup N on Wear and Seizure. ASTM-ASME Joint Research Committee on the Effect of Temperature on the Properties of Metals, Mechanical Engineering. 58. 1936. pp. 165-168.

II. Deformation and Rupture

Foley, F. B. Factors Affecting Deformation and Rupture of Metals at Elevated Temperatures. Journal of Metals. Volume 188, No. 6. June, 1950. (Trans.) pp. 845-50.

Wood, W. A. and Rachinger, W. A. The Mechanism of Deformation in Metals. J. Inst. Metals. Volume 76. 1949. pp. 237-53.

Contrails

Drucker, D. C. A Reconsideration of Deformation Theories of Plasticity. American Society of Mechanical Engineers, Transactions. Volume 71, No. 5. July, 1949. pp. 587-592.

Jones, P. G. and Worley, W. J. An Experimental Study of the Influence of Various Factors on the Mode of Fracture of Metals. American Society for Testing Materials, Proceedings. Volume 48. 1948. pp. 648-663.

Boas, W. and Honeycombe, R. W. K. The Anisotropy of Thermal Expansion as a Cause of Deformation in Metals and Alloys. Proceedings of Royal Society. A 188, 427-39. 1947.

McAdam, D. J.; Geil, G. W.; and Mebs, R. W. Influence of Plastic Deformation. Am. Inst. Mining Met. Engrs. Iron and Steel Der., Metals Technol. 14, No. 5. Tech. Pub. No. 2220. 40 pp. 1947.

Gensamer, Maxwell and Saibel, Edward; Ransom, J. T. and Lowrie, R. E. The Fracture of Metals. American Welding Society. 1947. 84 pp.

Bertram, Werner. Deformation of Threaded Sections. Chemical Abstracts. 38. Jan.-June, 1944. p. 2601^o.

III. Friction and Wear

Damon, Samuel. Carbon Restoration Improves Wear Resistance. Steel. 127, No. 17. 1950. pp. 66-7.

Dedrick, J. H. Effects of Certain Addition Agents Upon the Frictional and Wear Characteristics of Powder Metallurgy Bronzes. ASTM Bull. No. 169. 1950. pp. 46-50.

Gemant, A. Frictional Phenomena. Chemical Publishing Co. Brooklyn, N. Y. 1950. p. 497.

Strang, C. D. and Lewis, C. R. On Magnitude of Mechanical Component of Solid Friction. J. Applied Physics. Volume 20, No. 12. Dec. 1949. pp. 1164-7.

Strang, C. D. and Burwell, J. T. The Incremental Friction Coefficient -- A Non-Hydrodynamic Component of Boundary Lubrication. Journal of Applied Physics. Volume 20. Jan. 1949. pp. 79-89.

Contrails

- Palmer, F. What About Friction? Amer. Journal of Physics. Volume 17. April 1949. pp. 181-7.
- Whitehead, J. R. Metallic Friction and Surface Damage at Light Loads. Research. Volume 2. 1949. pp. 145-147.
- Morgan, F.; Muskat, M.; and Reed, D. W. The Friction of Dry and Lubricated Surfaces as Determined by the Stick-Slip Method. Lubrication Engineering. Volume 5. 1949. pp. 75-82 and 103.
- Tabor, D.; Thomas, P. H.; MacFarlane, J. S.; Tingle, E. D.; Schnurmann, R.; Fogg, A.; Horak, Z. Wear and Lubrication. Editorial Review of Papers at 7th International Congress of Applied Mechanics, held in London. Engineering. Volume 166. Oct. 29, 1948. pp. 421-2.
- Tingle, E. D. Fundamental Work On Friction, Lubrication and Wear In Germany During the War Years. Institute of Petroleum, Journal. Volume 34. Oct. 1948. pp. 743-773.
- Gwathmey, A. T.; Leidheiser, H., Jr.; Smith, G. Pedro. Influence of Crystal Plane and Surrounding Atmosphere on Some Types of Friction and Wear Between Metals. National Advisory Committee On Aeronautics. Tech. Note No. 1461, 37 pp. 1948.
- Moore, A. J. W. Surface Damage Caused By Friction Between Sliding Metals. Can. Machy. Volume 58. Dec. 1947. pp. 202-3.
- Unstaetter, H. Oiliness and Boundary Phase Friction. Engineers' Digest. Volume 4. Dec. 1947. pp. 570-2. see also Engineers' Digest (British edition) Volume 8. Dec. 1947. pp. 402-4.
- Boulanger, Christian. Internal Friction of Metals and of Ferromagnetic Alloys. Compt. Rend. 224, 1286-8 (1947). Chemical Abstracts. 41. June 20-Dec. 10, 1947. p. 5075g.
- Bristow, J. R. Kinetic Boundary Friction. Royal Society of London, Proceedings, Series A. Volume 189. March 27, 1947. pp. 88-102.
- Riumin, P. I. and Riabinin, I. U. N. Friction and Wear of Metals in the Presence of Liquid Gases. The Engineers' Digest. Volume 5. May-June, 1948. p. 186.
- Clayton, D. Surface Finish in Relation to Friction and Lubrication. Engineering. 159. March 16, 1945. pp. 215-216.

Contrails

Bowden, F. P. and Tabor, D. The Theory of Metallic Friction and the Role of Shearing and Flowing. Council for Scientific and Industrial Research. Bulletin No. 145. Commonwealth of Australia. 1942.

Bowden, F. P. and Tabor, D. The Friction of Thin Metallic Films. Council for Scientific and Industrial Research, Commonwealth of Australia. Bulletin No. 155. 1942.

Morgan, F. and Muskat, M., and Reed, D. W. Friction Phenomena and the Stick-Slip Process. Journal of Applied Physics. 12. 1941. pp. 743-752.

IV. Oxidation

McCullough, H. M.; Fontana, M. G.; and Beck, F. H. Formation of Oxides on Some Stainless Steels at High Temperatures. Trans. Am. Soc. Metals, Reprint No. 4. 1950. 17 pp.

Tofaute, Walter and Bandel, G. Phenomena Occurring on Oxidation of Heat-Resistant Steels and Alloys. Inst. Hierro 6 Acero 3. 1950. pp. 177-86. Chemical Abstracts. Jan. 10, 1951. p. 97, c, d, e.

Dravnieks, Andrew and McDonald, H. J. High Temperature Corrosion of Metals. Corrosion. Volume 5. July, 1949. pp. 227-233.

Hickman, J. W. Metal Oxide Film at Elevated Temperatures. Iron Age. 162, No. 7. pp. 90-94; No. 8. pp. 90-94. 1948.

Mott, N. F. The Oxidation of Metals. J. Chem. Phys. 44. 1947. pp. 172-80.

Frictional Oxidation as Chemical Mechanical Process. Archiv. fuer das. Eisenhuettenwesen. Volume 16. April 1943. pp. 399-407. The Engineering Index. 1948. p. 509.

Dies, K. Frictional Oxidation as a Chemical-Mechanical Process. Chem. Zentr. II. 1942. 1399. Chemical Abstracts. Volume 37. p. 5680². (1943).

V. Miscellaneous Materials and Characteristics

Schwartz, A. New Thread Form Reduces Bolt Breakage. Steel. Volume 127. Sept. 4, 1950. pp. 86-7.

Miller, R. F. and Heger, J. J. Report on Strength of Wrought Steels at Elevated Temperatures. Am. Soc. Testing Materials. Special Tech. Pub. No. 100. March 1950.

Sefing, F. G. Some Engineering Problems Associated With Metals in Elevated Temperature Service. Am. Soc. Mech. Engrs. Advance Paper No. 49-F-14 for meeting Sept. 28-30, 1949. 7 pp.; see also Can. Metals, and Met. Industries. Volume 12. Nov. 1949. pp. 14-17.

Evans, U. R. Mechanism of the Formation of Films on Metals. Pittsburgh Int. Conf. on Surface Reactions. 1948. pp. 71-6.

Hawthorne, P. A. Sheet Metals for High-Temperature Service. Iron Age. Volume 162. 1948. pp. 89-95.

Robinson, E. L. High-Temperature Bolting Materials. Am. Soc. Testing Materials Proceedings -Preprint No. 165, 22 pp. 1948.

High-Temperature Materials for Gas Turbines. Iron Age. Volume 161. 1948. pp. 56-60.

Robinson, E. L. High Temperature Bolting Materials. Am. Soc. Testing Materials. Preprint 165 for meeting June 21-25, 1948. 22 pp.

Sykes, C. Developments in Alloy and Special Steels. Metallurgie 37. 1947. pp. 75-9.

Gensamer, Maxwell; Saibel, Edward; and Lowrie, R. E. The Fracture of Metals. Welding J. 26, 443_s-84_s. 1947.

Grant, J. J.; Frederickson, A. F.; and Taylor, M. E. Heat-Resistant Alloys from 1200 to 1800°F. Research Memo No. 3-47, Navships 250-330-12. Sept. 1, 1947.

Mochel, N. L. Metallurgical Considerations of Gas Turbines. Amer. Soc. of Mech. Engrs., Transactions. Volume 69. Aug., 1947. pp. 561-568.

Binder, W. O. Alloys for High Temperature Service. Iron Age. Volume 158. Nov. 7, 1946. pp. 46-52; 92-95.

Contrails

Schurig, O. R. How Should Engineers Describe A Surface? Proceedings of the Special Summer Conferences on Friction and Surface Finish. Massachusetts Institute of Technology. June 1940. pp. 141-156.

VI. Lubrication

Menter, J. W. A Study of Boundary Lubricant Films By Electron Diffraction. Phys. of Lubrication, Brit. J. Applied Phys., Supplement 1. 1951. pp. 52-54.

Finch, G. I. The Boundary Layer. Phys. of Lubrication, Brit. J. Applied Phys. Supplement 1. 1951. pp. 34-5.

Bowden, F. P. and Tabor, D. The Friction and Lubrication of Solids. Oxford Univ. Press. London. 1950.

Murphy, C. M. and Zisman, W. A. Structural Guides For Synthetic Lubricant Development. Ind. Eng. Chem. 1950. pp. 42, 2415-20.

Larson, R. G. and Bondi, A. Functional Selection of Synthetic Lubricants. Ind. Eng. Chem. 1950. pp. 42, 2421-7.

Currie, C. C. and Hommel, M. C. Boundary Lubricating Characteristics of Organopolysiloxanes. Ind. Eng. Chem. 1950. pp. 42, 2452-6.

Davey, W. Development of Extreme Pressure Lubricants. Petroleum. Volume 13. Nov. 1950. pp. 279-82, 284.

Davey, W. Synthetic Lubricants. Sci. Lubrication. Volume 2. June 1950. pp. 10-3.

Stuart, A. H. Lubricating Properties of Some Dry Films. Sci. Lubrication. Volume 2. May 1950. pp. 10-12, 14.

"Molykote - A New Lubricant". Sci. Lubrication. Volume 2. No. 4. April 1950. p. 16.

Rubin, B. and Glass, E. M. Air Force Looks at Synthetic Lubricants. Soc. Automotive Engrs., Trans. Volume 4. April 1950. pp. 287-96.

Contrails

Tingle, E. D. Importance of Surface Oxide Films in Friction and Lubrication of Metals. Faraday Soc. - Trans. Volume 46. Feb. 1950. pp. 93-102.

Dry Film Lubrication. Mech. World. Volume 127. Feb. 3, 1950. pp. 119-20.

Johnson, R. L. and Swikert, M. A. and Bisson, E. E. Friction and Wear of Hot-Pressed Bearing Materials Containing Molybdenum Disulphide. Nat. Advisory Committee Aeronautics, Tech. Note No. 2027. Feb. 1950.

Gregory, J. N. Lubrication By Compounds: The Lubrication of Metals By Compounds Containing Chlorine. J. Inst. Petroleum. Volume 34. 1949. pp. 670-6.

Roach, A. E. A Bibliography of the Literature on Bearings and Lubrication. General Motors Corp. Detroit. 1949.

How Lubrication Licks Friction. Power. Volume 93. Oct. 1949. pp. 98-9, 164, 162.

Sellei, H. Sulfurized Extreme-Pressure Lubricants and Cutting Oils. Petroleum Processing. Volume 4. Sept. 1949. pp. 1003-8. Oct. pp. 1116-20.

Greenhill, E. B. Lubrication of Metal Surfaces by Mono- and Multi-Molecular Layers. Faraday Soc.-Trans. Volume 45. July 1949. pp. 631-5.

High-Temperature Lubrication. Sci. Lubrication. Volume 4. May-June 1949. pp. 14-5.

Ross, F. High Temperature Lubrication. Cer. Industry. Volume 52. April 1949. pp. 83-4.

Glass, E. M. Lubrication Engineering - U. S. Air Forces Approach. Society Automotive Engrs. - J. Volume 57. Feb. 1949. pp. 45-50.

Savage, Robert H. Graphite Lubrication. J. Applied Phys. Volume 19. 1948. pp. 1-10.

Bowden, F. B. The Importance of Chemical Attack in the Lubrication of Metals. J. Inst. Petroleum. Volume 34. 1948. pp. 654-8.

Contrails

Greenhill, E. B. Lubrication of Metal By Compounds Contain-
ing Sulfur. J. Inst. Petroleum. Volume 34. 1948. pp. 659-69.

Stuart, A. H. Application of Colloidal Graphite to Some
Lubrication Problems. Sci. Lubrication. Volume 1. Oct.-Dec.
1948. pp. 15-7, 24.

Lubrication of Equipment Operating at High Temperatures. Machy
(Lond). Volume 73. Sept. 16, 1948. pp. 445.

Campbell, W. E. and Thurber, E. A. Studies in Boundary Lub-
rication. II. Am. Soc. Mech. Engrs.-Trans. Volume 70. May
1948. pp. 401-6.

Savage, R. H. Graphite Lubrication. J. Appl. Physics. Volume
19. Jan. 1948. pp. 1-10.

Brewer, A. F. and Van Gundy, J. C. Metals-Lubricants. Steel.
Volume 121. 1947. pp. 93-5, 102-9.

Brix, V. H. An Electrical Study of Boundary Lubrication. Air
Craft Engineering. Volume 19. 1947. pp. 294-297.

Glass, E. M. and Salzberg, L. F. Grease Lubrication of Military
Aircraft and Components. U. S. Air Force-Air Tech. Intelligence
-Tech. Data Digest. Volume 12. Dec. 15, 1947. pp. 7-14.

Sakmann, B. W. Geometrical and Metallurgical Changes in Steel
Surfaces Under Conditions of Boundary Lubrication. Am. Soc.
Mech. Engrs.-Trans. (J. Applied Mechs.) Volume 14. March
1947. pp. A43-A52.

Hagg, A. C. Heat Effects in Lubricating Films. Transactions
of the American Society of Mechanical Engineers. Volume 66.
1944. pp. 72-76.

Wright, Donald L. Lubricants Suitable For Use at High Temp-
eratures. (to Jasco, Inc.) U. S. 2,356,367. Aug. 22, 1944.

Burwell, J. T. The Role of Surface Chemistry and Profile in
Boundary Lubrication. S.A.E. Journal 50. 1942.p. 450-7.

Atlee, Z. J.; Wilson, J. T.; and Filmer, J. C. Lubrication in
Vacuum by Vaporized Thin Metal Films. J. Applied Physics.
Volume 11. 1940. pp. 611-15.

Contrails

Needs, S. J. Boundary Film Investigations. Transactions of the American Society of Mechanical Engineers. Volume 63. 1940. pp. 331-345.

Porter, B. H. High-Temperature Lubrication. Ind. Heating. Volume 6. 1939. pp. 602-4.

Campbell, W. E. Studies in Boundary Lubrication. Transactions of the American Society of Mechanical Engineers. Volume 61. 1929. pp. 633-641.

Adams, N. K. Molecular Forces in Friction and Boundary Lubrication. Inst. Mech. Engrs. Lubrication Discussion. Oct. 1937. Group IV. 1-5.

Higinbotham, H. Lubrication Under High-Temperature Conditions With Reference to the Use of Colloidal Graphite. Inst. Mech. Engrs. Lubrication Discussion Oct. 1937. Group II, pp. 89-95.

Bowden, F. P. and Ridler, K. E. W. The Temperature of Lubricated Surfaces. Proceedings of the Royal Society of London, Series A. Volume 154. 1936. pp. 640-656.

VII. Test Methods

Rabinowicz, E. An Investigation of Surface Damage With Radioactive Metals. Phys. of Lubrication, Brit. J. Applied Phys. Supplement 1. 1951. pp. 82-5.

Bristow, J. R. Measurement of Kinetic Boundary Friction or Experimental Investigation of 'Oiliness'. Instn. Mech. Engrs.-Proc. Volume 160. 1949. pp. 384-92, 392-402.

Sichikov, M. F. and Vishnevecky, Z. D. Method of Testing Fatigue of Steel Samples at High Temperatures. Engrs'. Digest. Volume 10. Feb. 1949. p. 46.

Cameron, A. Some Experiments on Bearing and Wear-Testing Machines. Inst. Petroleum J. Volume 35. Feb. 1949. pp. 126-31.

Contrails

Krotov, I. V. and Khachadurova, T. M. New Method of Determination of Thickness of Natural Passivating Films on Metal. S. Ordzhonikidze Aviation Inst., Moscow. Bull. Acad. Sci. U.S.S.R. Class Sci. Chim. 1948. 50-6 (Russian). Chemical Abstracts. Volume 42. p. 4886d (1948).

Moore, A. J. W. A Refined Metallographic Technique for the Examination of Surface Contours and Surface Structure of Metals. Metallurgia. Volume 38. 1949. pp. 71-4.

Griffin, C. B. Fatigue-Testing Production Parts. Iron Age. Volume 161. 1948. pp. 59-62.

Wilson, T. Y. Testing the Super-Alloys. Instrumentation. Volume 3. 1948. pp. 12, 13.

Symbols and Nomenclature for Fatigue Testing. American Society for Testing Materials, Bull. No. 153. August 1948. pp. 36, 37.

Sprankle, A. F. and Dayton, R. W. Galling Tests of Graphitic and Regular Oil Hardening Die Steels. Metal Progress. Volume 54. July 1948. pp. 65-9.

Tapsell, H. J.; Pollard, H. V.; and Wood, W. A. A Combined Creep Machine and X-Ray Spectrometer. Journal of Scientific Instruments. Volume 25. June 1948. pp. 198-199.

Marin, Joseph. New Creep Testing Machine. Automotive Industries. Volume 98. May 15, 1948. pp. 46, 78.

Smith, G. V.; Benz, W. G.; and Miller, R. F. Creep and Creep Rupture Testing. Steel. Volume 121. 1948. pp. 89, 90; 106-8.

Foley, Francis B. Interpretation of Rupture Data. Metal Progress. Volume 51. 1947. pp. 951-B.

Burwell, J. R., Jr. Radioactive Tracers in Friction Studies. Nucleonics. Volume 1. Dec. 1947. pp. 38-50.

Brunot, A. W. Tensile Testing at Elevated Temperatures. Steel. Volume 121. Aug. 4, 1947. pp. 90, 91, 110, 112.

McKibben, R. F. Determining Consistency on Small Samples of Lubricating Grease. American Society for Testing Materials. Bull. No. 146. May 1947. pp. 74-77.

Contrails

Luthander, S. and Waallgren, G. Static and Dynamic Tests of Attachment Bolts of High Alloy Steel. FFA Rapport H R-84. 1944. 16 pp. (Swedish) The Aeronautical Engineering Index. 1947. p. 149.

Blok, H. Seizure-Delay Method for Determining the Seizure Protection of EP Lubricants. S.A.E. Journal 44. 1939. pp. 193-200T.