

Contrails

Cleared: May 1st, 1987

Clearing Authority: Air Force Aerospace Medical Research Laboratory

AS AD NO. 30067

WADC TECHNICAL REPORT 53-266

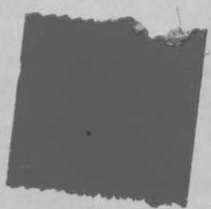

**MASKING OF CATHODE RAY TUBE DISPLAYS
BY AMBIENT ILLUMINATION**

*HELMUT-E. ADLER
MARGARET P. KUHNS
JOHN L. BROWN*

COLUMBIA UNIVERSITY

NOVEMBER 1953

WRIGHT AIR DEVELOPMENT CENTER

**MASKING OF CATHODE RAY TUBE DISPLAYS
BY AMBIENT ILLUMINATION**

*Helmut E. Adler
Margaret P. Kubns
John L. Brown*

Columbia University

November 1953

*Aero Medical Laboratory
Contract No. AF 33(038)-22616
RDO No. 694-45*

**Wright Air Development Center
Air Research and Development Command
United States Air Force
Wright-Patterson Air Force Base, Ohio**

FOREWORD

This report was prepared by Columbia University under USAF Contract No. AF 33(038)-22616 covering work on Visual Factors in Cathode Ray Tube Data Presentation. The contract was initiated under a project identified by Research and Development Order No. 694-45, "Presentation of Data on Radar Scopes", and was administered by the Psychology Branch of the Aero Medical Laboratory, Directorate of Research, Wright Air Development Center, with Dr. Kenneth T. Brown acting as Project Engineer.

Contrails

ABSTRACT

Masking thresholds of ambient illumination were obtained for a signal presented as a horizontal trace on a cathode ray tube. Seven trace luminances and two trace widths were used. Ambient illumination was measured in terms of the luminance superimposed on the surface of the tube. The results show that in radar operation ambient light can be present considerably in excess of the signal strength without masking the signal display, except when the signal luminance is below 0.1 ml. If the signal strength is increased by a small amount, the masking threshold for ambient light rises rapidly at first, but at a decreasing rate, and eventually reaches a point where further increases in trace luminance do not result in a further increase in masking threshold. Above this level of ambient light (somewhat higher than 1000 ml in this experiment) no increase in signal strength can compensate for the masking effects of the ambient light.

Increasing the dimensions of the trace, while holding trace luminance constant, appears to afford tolerance for somewhat more ambient light.

PUBLICATION REVIEW

This report has been reviewed and is approved.

FOR THE COMMANDER:

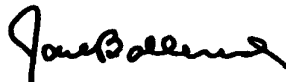

JACK BOLIERUD
Colonel, USAF (MC)
Chief, Aero Medical Laboratory
Directorate of Research

Contrails

TABLE OF CONTENTS

	Page
Introduction	1
Apparatus	3
Procedure	6
Results	7
Discussion	14
Summary	18
Bibliography	19

LIST OF ILLUSTRATIONS

Figure

1. Schematic diagram of apparatus	4
2. Total ambient luminance for masking threshold of a CRT trace	10
3. Average masking threshold as a function of trace luminance	10
4. Masking thresholds as a function of direct ambient light	12
5. Contrast ratios as a function of the average masking threshold ambient luminance	13

LIST OF TABLES

Table

1. Masking thresholds of ambient luminance for 1 mm trace width	8
2. Masking thresholds of ambient luminance for 2 mm trace width	9

Contrails

INTRODUCTION

It has generally been assumed that viewing cathode ray tube displays, as found in oscilloscopes, television viewing screens, or radar scopes, is most satisfactory under conditions of dim illumination or complete darkness. In practice, however, it is often necessary for the radar operator to work under other conditions of illumination. The viewer is frequently in a room with other workers engaged in tasks requiring illumination, and the operator himself may need to perform some tasks which cannot be carried out in dim illumination.

Ambient illumination falling on the tube face will reduce the effective contrast of signals and thus may be presumed to decrease visibility. It is of interest, therefore, to investigate the effect of extraneous light on the visibility of cathode ray tube displays and to determine the intensity of ambient illumination that will effectively mask a signal of a given strength.

The effect of direct light on the tube face has been investigated for both PPI and A-scan displays.

Williams and Hanes (15), using a PPI type intensity modulated screen, determined the effect of adding ambient illumination on threshold visibility in terms of the decibel increase in line voltage over a standard signal voltage which was needed to make the signal just visible. Both spectral and white lights were used. Significant losses in visibility were found when the ambient luminance measured in foot-candles exceeded the luminance of the viewing screen by more than one half log unit. Complete darkness was also found unfavorable. Blue and green ambient illumination caused less impairment at higher levels than amber, red, mazda, and "daylight." Craik and McPherson (4) also report a detrimental effect on performance on the PPI radar scope when ambient illumination is increased beyond a certain intensity, but the relation of the critical level to trace brightness is not specified.

A study with an A-scan scope, which places less emphasis on differential sensitivity, is reported by Lindsley et al (9). Using several levels of signal brightness and ambient illumination, they found that signal detection was essentially the same under all combinations of conditions used. There was some indication that with the maximum illumination and minimum signal brightness, performance was impaired, but no attempt was made to determine a critical ambient level.

Contrails

In the foregoing studies, the ambient light source was placed so that the light fell directly on the viewing screen. This method has the advantage of realistically duplicating the practical situation, but it fails to provide exact control of the amount of light entering the eye under different experimental conditions.

In the present experiment, the level of ambient illumination which masked a trace signal on the scope was determined for a wide range of trace luminances and for two different trace widths. Two kinds of ambient illumination were employed, direct and indirect.

The indirect ambient illumination was reflected into the eye by a piece of plain glass placed at an angle of 45° to the line of sight. The circular field of ambient light was seen superimposed on the circular screen of the cathode ray tube, but none of this light actually reached the tube face and was reflected from it. By this method it was possible to obtain a uniform field, the luminance of which could be varied continuously. This method is used frequently in the study of the effect of glare. [Cf. Stiles and Crawford (14), Fry and Alpern (5).]

An additional reason for using the indirect ambient illumination was to provide a reference with which to evaluate possible secondary effects of direct illumination of the tube face. It seemed at least possible that part of the masking effect of direct ambient illumination might be attributed to its excitation of the phosphor coating of the tube. The relation between luminance of a point on the scope and excitation in terms of incident energy is not a linear relation. Luminance increases at a decreasing rate with increase in the energy of excitation. The effectiveness of the exciting electron beam within the tube for increasing the luminance of a point on the tube face conceivably could be diminished by reason of the fact that external light has driven the phosphor nearer to its point of saturation. If this is the case, then the masking effect on a given electrical signal of direct ambient illumination might differ from that of indirect ambient illumination even though both were of the same luminance as seen by an observer looking at the scope face.

In order to test this possibility, three levels of direct illumination of the scope face were also investigated for their masking effect on various trace signals.

Contrails

APPARATUS

The apparatus consisted of a cathode ray oscilloscope modified to present either a horizontal or vertical trace of a predetermined width and specified luminance. An optical system was used to present a veiling glare at the pupil which appeared superimposed on the cathode ray tube face. Ambient illumination was also provided by light falling directly on the tube face. A signal light system was used with which the subject could indicate the orientation (horizontal or vertical) of the trace line.

1. Cathode ray tube display.

A DuMont 304H cathode ray oscilloscope, fitted with a 5CP4A tube was placed in a light-proof box with the tube face 19 inches from the observer's eye. By appropriate adjustment of the sweep frequency a steady trace line was obtained. In order to specify width and luminance, the trace was calibrated at various settings by the method proposed by Ranken (10). By varying the intensity control from the lowest to the highest intensity available and defocusing the line to produce the desired widths of 1 mm and 2 mms, a series of trace lines was obtained ranging in luminance from 0.08 ml to 101.20 ml, as measured with the Macbeth illuminometer. In addition, the oscilloscope was set to produce the maximum trace luminance possible, giving a line somewhat wider than 2 mm at a luminance of 264.16 ml. The line voltage was kept at a monitored 117.5 volts A.C. throughout.

The diameter of the tube face was 5 in, giving at the eye a visual angle of 15° . The 1 mm line subtended a visual angle of $7'7''$ and the 2 mm line subtended $14'15''$.

Two modifications were introduced to provide a control over exposure time and trace position. The deflection of the trace was set so as to produce no visible signal on the tube face until additional potential, provided by a 45 volt battery, was supplied to the deflection plates. This circuit was closed every five seconds for 0.1 second by a micro-switch, actuated by an eccentric cam mounted on a constant speed motor. A push button operated by the experimenter completed the circuit, deflecting the trace signal into the center of the tube face for 0.1 second presentations.

The leads from the horizontal and vertical amplifier were tapped and a circuit added which enabled reversal of the leads to the two amplifiers. A trace could thus be presented as a horizontal or vertical line on any given exposure by means of

Contrails

a two position switch mounted on the control board.

Since it was found that the width and luminance of a given trace setting varied in the horizontal and vertical position, the horizontal display was used for obtaining data and the vertical trace only provided a check on the ability of the observer to see the line. It was also found that switching the trace from vertical to horizontal or vice versa was accompanied by some random "noise" on the tube. In order to rule out this cue to trace orientation, a shutter (B in Figure 1) was closed during the changeover, when only indirect ambient light was in use. When the tube face was illuminated by direct light this weak "noise" was not visible and the shutter was left open when changing trace orientation.

2. Ambient light.

Two sources of ambient light were used. All letters refer to the schematic diagram of the apparatus in Figure 1.

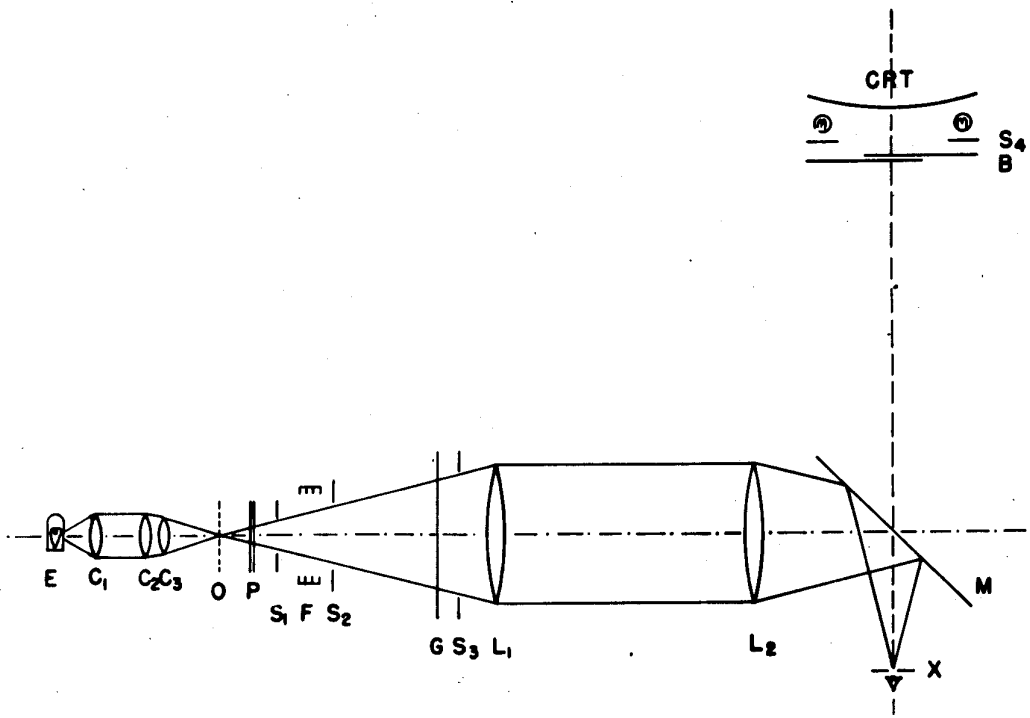

Figure 1: Schematic diagram of apparatus. See text for explanation of symbols.

Contrails

a. Indirect ambient illumination.

Light from an air-cooled 500 watt projection lamp E passed through a condensing system (C_1, C_2, C_3) to provide a focused spot of light on the flashed opal glass O.

The light passed through the variable polaroid filter P and aperture stops $S_1, S_2,$ and S_3 , to lens L_1 of 114 mm diameter and at its focal distance of 286 mm from O. The light intensity could be further controlled by neutral density filters placed in the filter box F. Lens L_2 identical to L_1 and $3/4$ inch behind it, was at its focal distance of 286 mm from the 3 mm artificial pupil X, mounted inside a dark room. A plain piece of glass M, set at 45 degrees, reflected a portion of the light which filled lens L_2 so that it appeared superimposed on the face of the cathode ray tube, producing an even field of illumination $22^{\circ}52'$ in diameter.

Fixation was achieved by means of a double fixation cross, ruled on the glass slide G. The two horizontal arms of the cross were ruled on the slide, and a single vertical line doubled by means of the reflection from the back surface of the glass to produce a parallel second line. The trace was positioned to appear between the double lines of the cross for both horizontal and vertical orientations. The separation of G from L_1 was adjusted so that the fixation cross appeared to the observer on the same plane as the trace line, as evidenced by the absence of movement parallax between the two.

Projection lamp E was operated at 120 volts D. C. and monitored at 4.3 amps. The luminance produced at the eye was measured by a binocular match against a light source standardized on the Macbeth illuminometer and was found to be 3.7 log ml. The variable polaroid filter P was calibrated at ten degree intervals by means of direct measurement against a known source using the illuminometer. These measurements were checked on an Eastman densitometer for five degree intervals. Readings on the polaroid scale were converted from degrees to density by means of a calibration curve, drawn from the above data and found to agree closely with the theoretical value derived from the equation $D = -2 \log \cos \theta + D_0$, where θ is the angle between the two polaroids and D_0 is the density at maximum transmission.

b. Direct ambient illumination.

Direct illumination of the scope face was obtained from four Mazda bulbs mounted $2\frac{1}{2}$ in. from the tube face and $3\frac{1}{2}$ in. from the center of the tube. Two lamps were mounted above and two below the screen. The observer was shielded from the lamps

Contrails

by shutter B and stop S_4 , so that only the illumination striking the tube face was reflected to the observer.

The illumination was uniform in the center, but near the edge of the tube there was some shadow from the tube mounting and specular reflection of the light sources.

The central luminance of the tube face was measured directly with the Macbeth illuminometer at three fixed levels of ambient illumination. Four 75 watt bulbs in parallel at 1.56 amps D. C. gave a luminance of 14.44 ml. Using four 100 watt bulbs in parallel, a luminance of 109.6 ml. was obtained with 2.4 amps and 348.5 ml. with 2.82 amps D., C.

3. Signal lights.

The observer responded to the orientation of the trace line by means of a signal light system. Mounted inside the dark room were two telegraph keys, one horizontal and one vertical. During an experimental session the observer kept his left hand on the horizontal and his right hand on the vertical key, pressing the key corresponding to the orientation of the trace line when it was seen. The keys were connected to two 7 volt signal lamps mounted next to the switch controlling the trace line position, so that the correct response would light up the lamp corresponding to the position of the switch.

PROCEDURE

Two subjects were used, a female (MK) with essentially emmetropic eyesight and a male (HA) with corrected myopia.

Threshold ambient luminance was determined for the conditions shown in Tables 1 and 2. There were two trace widths, 1 mm and 2 mm, with seven levels of trace luminance at each width. In addition, a trace of maximum luminance for the oscilloscope used was investigated. Trace width for this condition was somewhat more than 2 mm. The four levels of direct ambient light employed were 0 ml, 14.44 ml, 109.6 ml and 348.5 ml.

Before each experimental session, the eye was dark adapted for ten minutes. At the end of dark adaptation the observer's head was placed in a previously adjusted chin rest so that the right eye was at the level of the exit pupil. The subject then fixated the fixation cross for a period of five minutes light adaptation to the lowest intensity of ambient light for a particular session.

Contrails

At the end of light adaptation the experimenter presented five flashes of the horizontal trace line, interspersed with presentations of the trace in a vertical position and "blanks." The subject indicated the position of the line by pressing the horizontal or vertical signal key, or made no response if no trace was seen. The experimenter counted the number of correct responses.

A modified ascending method of limits was used to obtain frequency of seeing functions. Starting with ambient illumination at which five exposures of the trace line could be seen, the ambient luminance was increased by small steps, allowing one minute adaptation at each level. Percentage of seeing was obtained from ten observations when frequency of seeing fell below 100 per cent. For each trace condition the levels of ambient light were selected to cover the range from a luminance where the flash was almost always seen to a luminance where it was rarely seen. This procedure always involved four levels and usually required more than that.

After a rest period of five minutes in the dark the observer light adapted for five minutes to the lowest intensity of ambient light for the next higher level of trace luminance and the frequency of seeing function for this level was determined.

After determination of frequency of seeing functions at all seven levels of trace luminance for 1 mm trace width, the same procedure was followed for the 2 mm trace.

In the case of direct ambient light the subject was light adapted, without any indirect light being added, for the determination of the lowest trace luminance that could be seen. Indirect light was then added in the usual manner until the trace could not be seen.

Presentations of the trace line were separated by at least five second intervals, longer intervals in multiples of five seconds occurred when the experimenter missed a revolution of the flashing mechanism.

Frequency of seeing functions for from one to eight levels of trace luminance were obtained in a single session, lasting from one to four hours. The average session lasted two hours and yielded curves for four levels.

RESULTS

The data were plotted in terms of the percentage of times out of ten presentations at a given level of ambient luminance

TABLE 1

Masking threshold of ambient luminance in log millilamberts for 60% seeing of a CRT trace of one millimeter width at seven luminance levels. Three levels of direct ambient illumination. Subjects MK and HA. (Direct and indirect luminance summed to obtain masking threshold.)

Trace luminance Log ML	Direct ambient light								
	None		1.16 log ML		2.04 log ML		2.54 log ML		
	MK	HA	MK	HA	MK	HA	MK	HA	
-0.22	0.43	0.80	-	-	-	-	-	-	-
0.52	1.92	1.59	1.52	1.67	-	-	-	-	-
1.18	2.69	2.58	2.50	2.52	2.50	2.53	-	-	-
1.45	2.92	2.75	2.80	2.75	2.86	2.82	2.88	2.88	2.88
1.67	2.98	2.78	2.86	2.80	2.93	2.88	3.00	3.00	2.97
1.82	3.00	2.88	2.98	2.89	3.03	2.94	3.04	3.04	3.02
2.04	3.06	2.97	3.02	2.92	3.08	3.03	3.09	3.09	3.06

TABLE 2

Masking threshold of ambient luminance in log millilamberts for 60% seeing of a CRT trace of two millimeters width at seven luminance levels. Three levels of direct ambient illumination. Subjects MK and HA. (Direct and indirect luminance summed to obtain masking threshold.)

Trace luminance LOG ML	Direct ambient light								
	None		1.16 log ML		2.04 log ML		2.54 log ML		
	MK	HA	MK	HA	MK	HA	MK	HA	
-1.12	-1.67	-1.52	-	-	-	-	-	-	-
0.35	1.58	1.44	1.70	1.48	-	-	-	-	-
0.96	2.48	2.50	2.52	2.41	2.26	2.24	-	-	-
1.31	2.83	2.72	2.69	2.69	2.72	2.77	2.80	2.83	
1.54	2.96	2.88	2.81	2.89	2.90	2.85	2.99	2.93	
1.75	3.03	2.96	2.89	2.96	3.05	2.93	3.05	3.00	
1.89	3.21	3.05	2.97	3.04	3.09	2.99	3.13	3.08	

Contrails

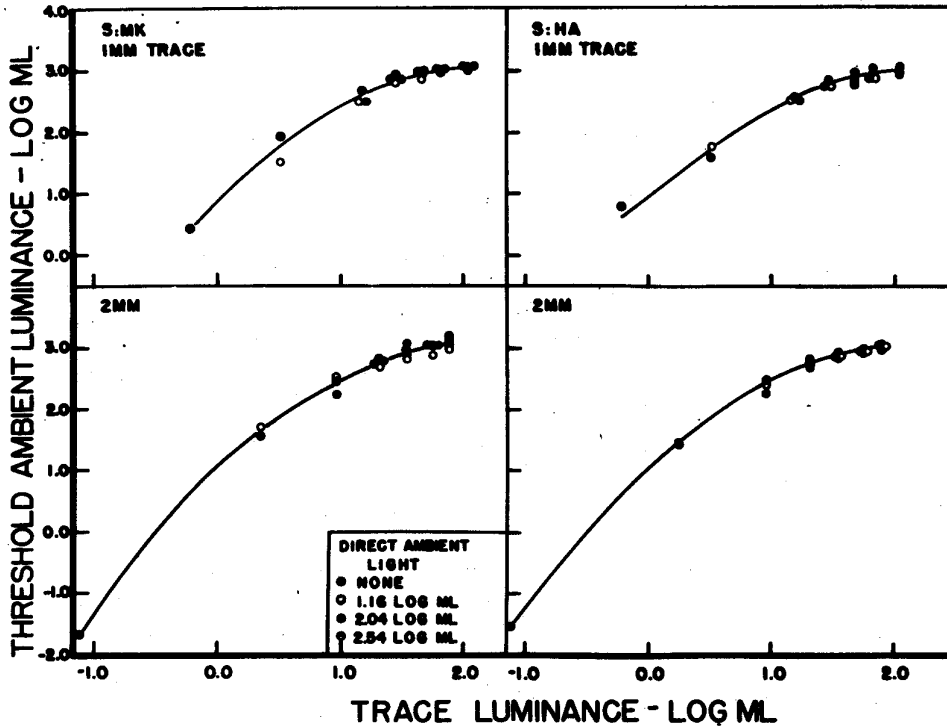

Figure 2: Ambient luminance for masking threshold of a CRT trace. Coding of points indicates the level of direct ambient light. Subjects MK and HA.

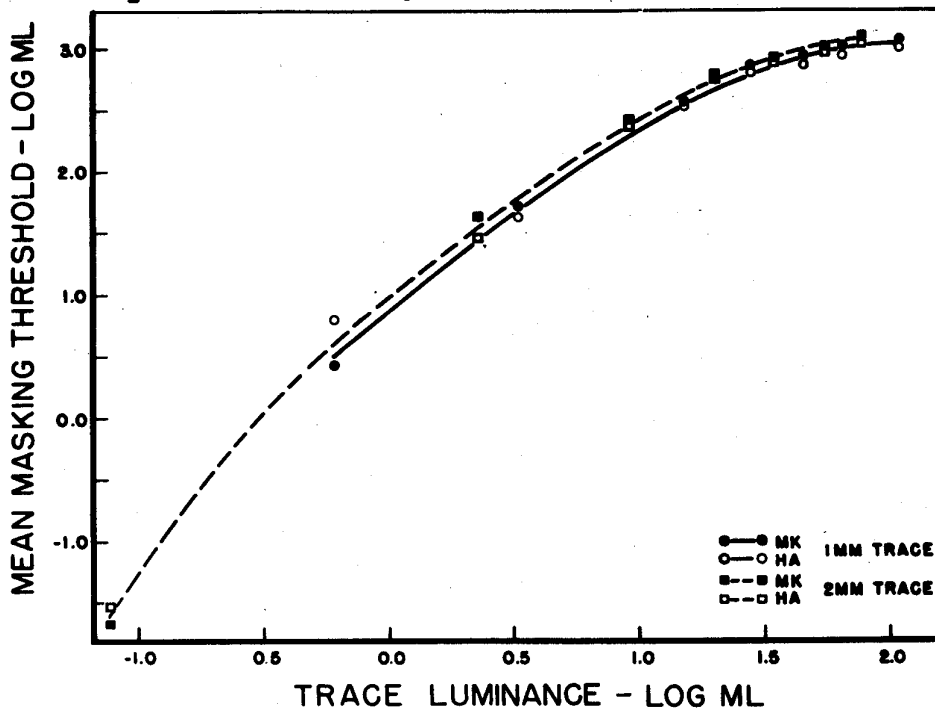

Figure 3: Masking threshold ambient luminance plotted against trace luminance for two width of trace line. The ambient light values are averages of all thresholds obtained at a given luminance, both with direct and indirect light. Subjects MK and HA.

Contrails

a given horizontal trace line was correctly identified. Smooth curves were fitted to the plotted points by eye and the point where 60% of the flashes were seen was taken as the masking threshold. These thresholds are summarized in Tables 1 and 2 for the two subjects and the conditions used.

Figure 2 presents the same data in the form of curves of log threshold ambient luminance plotted as a function of log trace luminance. The level of direct ambient illumination is indicated by the coding of the points. Separate curves are plotted for each observer and for the two trace widths used. As the amount of direct ambient light is increased, the range of trace luminance values at which a threshold can be obtained is decreased, since the direct light alone is sufficient to mask the weaker signals on the tube. A single curve was fitted to the data, since no consistent differences are apparent with changes in the direct luminance values.

The average values of the masking threshold for the two conditions of trace width and the two observers are plotted in Figure 3. Each point represents an average of the values obtained with both the direct and indirect ambient light for a threshold at a particular level of trace luminance.

The masking level of log ambient luminance increases as a negatively accelerated function of log trace luminance. Increasing the trace width from 1 mm to 2 mm raised the masking thresholds by a small amount if the overall data are considered. This difference is small but appears to be consistent.

Throughout the experiment it was found that most of the threshold values of MK were slightly higher than those of observer HA. Exceptions are apparent at the two lowest levels of trace luminance.

In the determinations where direct ambient illumination was used, the total ambient light reaching the observer's eye is assumed to have consisted of the following parts: constant amounts reflected from the outer glass surface of the tube and from the surface of the phosphor; a constant amount emitted by the phosphor as a result of excitation by the incident light; and a variable amount supplied as veiling luminance by the projection lamp via the optical system, i.e. the indirect ambient light. Figure 4 shows a plot of the total ambient light for masking threshold as a function of direct illumination in log ml. The first point on the abscissa represents threshold with no direct light being reflected from the tube face. Separate curves are shown for each trace luminance used.

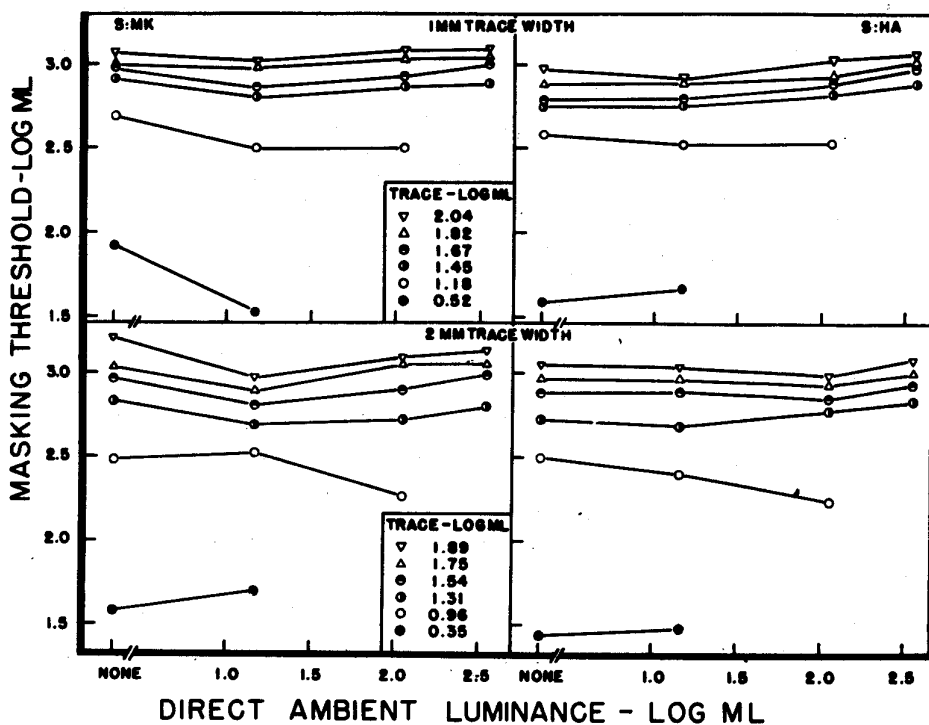

Figure 4: Total ambient luminance for a masking threshold as a function of direct ambient light for seven levels of trace luminance and two trace widths. Subjects MK and HA.

The curves for each level of trace luminance are approximately straight lines, indicating that the threshold was about the same, whether the ambient light reached the eye through the tube face. The median change in threshold due to the direct light for all points was +0.015 log ml for the 1 mm and -0.020 for the 2 mm trace width. It is clear that there was no significant difference between the conditions of direct and indirect ambient illumination.

Thresholds at different levels of direct light were always obtained at separate sessions. Day to day variability of the threshold therefore would tend to cause greater variation from one level of direct light to another than among trace luminance levels, which were usually covered in one or two successive sessions. This accounts for the fact that curves for different trace luminances show similar trends when compared on the basis of subject and trace width.

Contrails

The possibility that the direct and the indirect light were not additive was ruled out by direct measurement. A filter of known density was interposed between the light reflected from the tube face and one eye and a measurable amount of light added through the optical system to match a standard source viewed with the other eye. The indirect light needed for a match agreed closely with the amount of direct luminance cut out. (Differences of 0.01 log ml at a low intensity of direct light and 0.06 log ml at a high intensity are well within the amount of variation usually found in the binocular matching technique.)

The contrast ratios of trace luminance to ambient luminance as a function of mean ambient luminance are shown in Figure 5. Contrast is plotted in terms of the log of the quotient of trace luminance divided by ambient luminance, where the value for ambient illumination at a given trace luminance is obtained by averaging the masking threshold of ambient luminance with both indirect and direct illumination and for the two observers. Separate curves are shown for the 1 mm and 2 mm trace widths.

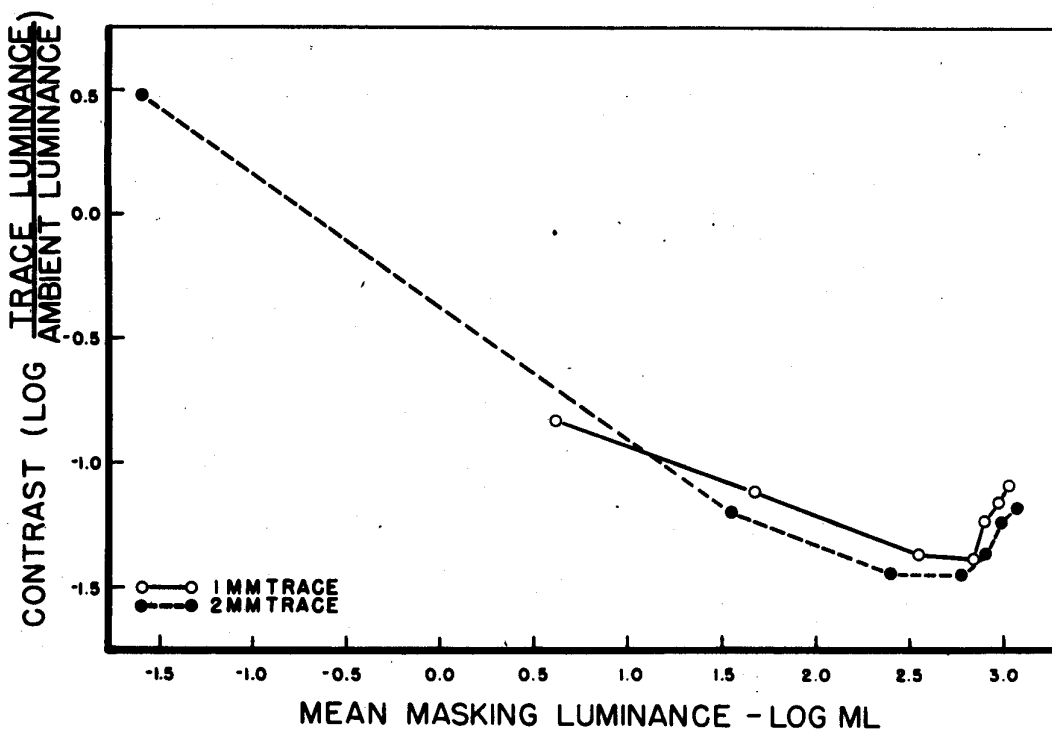

Figure 5: Contrast ratios plotted as a function of the mean masking threshold ambient luminance for both subjects. Two levels of trace width.

Contrails

Beginning at the lowest ambient luminance value, the contrast ratio decreases with increasing log ambient luminance, approaching a minimum value at an ambient luminance of 2.5 log ml. Further increase in log ambient luminance results in a rapid increase in the contrast ratio. The 2 mm trace requires a somewhat lower contrast than the 1 mm trace for its threshold over the range for which comparable data were obtained.

The thresholds for the condition of maximum trace luminance, with the trace measured at 264 ml, yielded a masking threshold of 3.71 log ml for subject MK and 3.60 log ml for HA. These measurements had to be made by removing the polaroid and using the two highest levels of direct light, since the projection lamp alone (indirect light) gave only a luminance of 3.7 log ml. Variation of the ambient light was accomplished by inserting filters in steps of one-tenth of a log unit in density in the path of light from the projection lamp. No direct comparison with the data obtained during the regular experiment is attempted, since sweep frequency was increased to maximum to increase the luminance of the line and the trace was not only wider than 2 mm but also showed a noticeable gradient in luminance with a bright central portion falling off on both sides. It will be noted that a trace line which was less than one-tenth the luminance of the ambient light could still be detected.

DISCUSSION

When a radar operator is required to work in illuminated surroundings, ambient light reflected from the face of the cathode ray scope may mask scope signals of low luminance. The results of the present experiment indicate the character of the relation between the luminance of a signal on the scope and the approximate minimum ambient luminance which is effective in masking the signal. For signals of a very low luminance, (0.1 ml) ambient illumination which provides a luminance at the scope face of nearly the same value as signal luminance will effectively mask the signal. As the luminance of the signal is increased, the ambient luminance required to mask the signal also increases. The initial rate of increase in masking ambient luminance is high relative to the rate of increase in signal luminance. With trace signal luminances of the order of 15 or 20 ml, ambient luminances must be 25 or 30 times as great, before they will effectively mask the trace signals. Masking luminance increases at a decreasing rate, however, and appears to reach an asymptote at slightly higher than 1000 ml. Thus, when ambient luminance is of the order of 1000 ml or higher, it becomes impossible to make the luminance of a trace signal on a cathode ray scope great enough so that the signal can be seen at all.

Contrails

The normal mode of excitation of the screen of a cathode ray tube is by the action of the electron beam within the tube. However, radiant energy in the form of light striking the outer surface of the tube also excites the tube coating to a limited extent (12). It is conceivable, as outlined in the introduction, that during direct illumination this effect might contribute to reduced visibility of presentations on the tube. At the levels tested in this experiment, however, adding direct illumination to the face of the cathode ray tube did not bring about any systematic change in the threshold values of total ambient illumination from those determined with the use of indirect ambient illumination alone. This is taken to indicate that the discrimination of a trace line on a cathode ray tube under conditions of ambient illumination may be considered as a simple case of brightness discrimination, and is not complicated by the action of the ambient illumination on the phosphor coating of the tube. It should be pointed out that, except for the lowest values of trace luminance, the proportion of direct ambient light was small as compared with the luminance of the indirect light.

The ability of the eye to discriminate small changes in brightness against the background of an illuminated visual field is well known and has been studied intensively (3, 7, 8, 13). Many factors are known to influence this function.

1. Area. With an increase in the area in which a luminance increment occurs, there is a decrease in the amount of change required for discrimination of the increment (6). This kind of an effect is evident in the present experiment. Increasing the dimensions of the trace, while holding trace luminance constant appears to afford tolerance for somewhat more ambient light. Similar results were obtained in an experiment on radar scopes by Bartlett, Williams, and Hanes (2).

The relative size of the area in which an increment is presented as compared to the area of the adapting field may be expected to affect the form of the brightness discrimination function. Ratoosh and Graham (11) and other investigators found that the foveal brightness discrimination function tended to rise at high adapting field luminance values, especially when the test field was almost as large as the adapting field. The areas which were used were much smaller than in the present case. The adapting field of $22^{\circ} 32'$ employed in the present experiment is rather large when compared with the usual conditions under which the brightness discrimination function is obtained. The trace, 15° in length and of widths of respectively $7' 7''$ for the 1 mm and $14' 15''$ for the 2 mm display, is also of rather unusual proportions. Both foveal and peripheral

stimulation can be expected to occur. In Figure 5 results of the present experiment are plotted in the manner usually employed for presenting brightness discrimination data. A decided increase in the ratio between trace luminance and masking ambient luminance is evident at high values of ambient luminance. This secondary rise has been a source of disagreement since first reported by Koenig and Brodhun (8).

While the contrast ratio is plotted in the usual way as a function of ambient light in Figure 5, it should be noted that trace luminance (corresponding to ΔI , the luminance increment in the classical situation) was actually the independent variable and ambient luminance (corresponding to I , the adapting luminance in the classical situation) the dependent variable in this experiment. Whether an identical function would result if I were the independent variable as in the traditional brightness discrimination situation is open to question.

2. Duration. At a given adapting luminance, brightness discrimination threshold decreases as duration of the luminance increment is increased, up to a limiting critical duration. The duration of the trace presentation on the cathode ray tube was held constant at 0.1 second. Cf. Recommendations of the Armed Forces-NRC Vision Committee (16). This involves the assumption that the decay time of the P-4 phosphor was negligible and the actual trace exposure therefore coincided temporally with the time that the circuit was closed. No exact data are available on critical duration for the relatively large area of both foveal and peripheral retina stimulated, but it is possible that the duration was at or above critical duration for the higher levels of trace luminance.

Bartlett and Sweet (1) have shown that with the P-7 radar screen an exposure of 0.1 second for a bright screen is very close to optimum visibility but that a gradual increase in visibility can be expected with low screen brightness when exposure is lengthened beyond 0.1 second.

3. Color. The signal produced by a P-4 phosphor appears white, but is known to differ in spectral composition from the ambient illumination used in the experiment. It has been assumed that chromaticity contrast is negligible in the present experiment. It must be recognized, however, that our results may be limited to the specific conditions of chromaticity which were employed.

Williams and Hanes (15) used ambient light of distinctly different colors with a P-7 phosphor and found only slight

Contrails

differences in favor of blue and green light at 1.0 f.c. over red, mazda and "daylight" illumination.

Before making any statements concerning the applicability of the results of the present experiment to Air Force situations, several possible limitations must be considered. First, the masking ambient luminances reported in this experiment are based on a 60% frequency of seeing criterion. If a 100% frequency of seeing criterion were demanded, as it might well be in a practical situation, masking ambient luminances would be somewhat lower than those reported here. On the other hand, the longer exposure of targets on many scopes, and freedom of the operator to scan the presentation might tend to raise masking ambient luminances. Finally, it should be recognized that many of the displays employed on operational cathode ray scopes differ radically in dimension and character from the display employed in this experiment. It is probable that such variation is accompanied by similar variation in the masking threshold in practical situations.

Several important generalizations seem justified on the basis of the results of the present experiment. In any application where it is of importance to be able to detect extremely weak signals on a cathode ray scope, ambient illumination should be kept to a minimum. As soon as the luminance of ambient light reflected from the scope face approaches the luminance of weak signals on the scope, it will begin to mask these signals. If it is not possible to reduce overall ambient illumination, then some kind of hood or shield should be used which will reduce the amount of light reflected from the scope face. It has been reported that the visibility of a signal on a cathode ray scope is improved when the eye of the observer is adapted to the luminance of the background against which the signal appears (15). Although this is true, it should not be interpreted to mean that some ambient illumination is better than none.

If a cathode ray scope is used in an application where low luminance signals do not impose limitations, e.g., in an oscilloscope which is used to monitor frequency or wave form, then small increases in ambient luminance can be compensated by very slightly increasing trace luminance on the scope. When ambient luminance exceeds a level of approximately 100 ml, however, relatively much greater increases in trace luminance are required to prevent masking. The masking effects of ambient luminances in excess of 1000 ml may be impossible to overcome even when trace luminances are increased to the maximum.

SUMMARY

1. The masking thresholds of ambient illumination were determined for a steady horizontal trace line displayed on a cathode ray oscilloscope. Ambient illumination was presented as a veiling luminance and also combined with three constant levels of direct illumination reflected from the tube face. Seven different trace luminances were investigated at each of two trace widths, 1 mm and 2 mm, in addition to a maximum luminance at a width of somewhat more than 2 mm.
2. The logarithm of ambient illumination for masking threshold increases as a negatively accelerated function of log trace luminance to a limiting value depending on the trace characteristics.
3. Ambient light cannot exceed trace luminance at low values. With an increase in signal strength, ambient illumination in excess of trace luminance can be tolerated. The ratio of trace luminance to masking ambient luminance decreases at a decreasing rate as a function of ambient luminance up to an ambient luminance of 2.75 log ml. Increasing ambient luminance above 2.75 log ml results in a rapid increase in the contrast ratio. It would appear that for an ambient luminance somewhat higher than 3.00 log ml, the required increase in contrast ratio exceeds practical limits.
4. Substitution of direct light on the tube face for part of the indirect ambient illumination does not result in consistently different thresholds.
5. Increasing trace width from one to two millimeters results in a slight increase in masking threshold.
6. Relations of area, duration and color of the signal to threshold are discussed briefly and applications to radar operation are considered.

BIBLIOGRAPHY

1. Bartlett, N. R. and Sweet, A. L. Visibility on Cathode-Ray Tube Screens: Signals on a P-7 Screen exposed for Different Intervals. Journal of the Optical Society of America, Volume 39, 1949, pp. 470-473.
2. Bartlett, N. R., Williams, S. B., and Hanes, R. M. Visibility on Cathode-Ray Tube Screens: The Effect of Size and Shape of Pip. Journal of the Optical Society of America, Volume 39, 1949, pp. 463-470.
3. Blackwell, H. R. Contrast Thresholds of the Human Eye. Journal of the Optical Society of America, Volume 36, 1946, pp. 624-643.
4. Craik, K. J. W. and McPherson, S. J. The Effect of Certain Operating Conditions on the Visibility of PPI Radar Scopes. Medical Research Council, APRU, Psychological Laboratory, Cambridge, APU 16, 1945.
5. Fry, G. A. and Alpern, M. The Effect of a Peripheral Glare Source upon the Apparent Brightness of an Object. Journal of the Optical Society of America, Volume 43, 1953, pp. 189-195.
6. Graham, C. H. and Bartlett, N. R. The Relation of Size of Stimulus and Intensity in the Human Eye: III The Influence of Area on Foveal Intensity Discrimination. Journal of Experimental Psychology, Volume 27, 1940, pp. 149-159.
7. Hecht, S. A Theory of Visual Intensity Discrimination. Journal of General Physiology, Volume 18, 1935, pp. 767-789.
8. Koenig, A. and Brodhun, E. Experimentelle Untersuchungen über die psychophysische Fundamentalformel in Bezug auf den Gesichtssinn. Sitzungsbericht Kaiserliche Akademie der Wissenschaften, Berlin. Volume 2, 1888, pp. 917-931.
9. Lindsley, D. B. et. at. The Effect of Extraneous Illumination upon Detection of Signals on an A-scan Oscilloscope. USRD Report No. 4264, 1944.
10. Ranken, H. B. Determination of Width and Luminance of a CRT Trace. WADC Technical Report 52-17, United States Air Force, Air Research and Development Command, 1952.

Contrails

11. Ratoosh, P. and Graham, C. H. Areal Effects in Foveal Brightness Discrimination. Journal of Experimental Psychology, Volume 42, 1951, pp. 367-375.
12. Soller, T., Starr, M. A., and Valley, G. E. Jr. Cathode-Ray Tube Displays. First edition. McGraw-Hill Book Company, Inc., New York 1948, pp. 623-625.
13. Steinhardt, J. Intensity Discrimination in the Human Eye. I. The Relation of $\Delta I/I$ to Intensity. Journal of General Physiology. Volume 20, 1936, pp. 185-209.
14. Stiles, W. S. and Crawford, B. H. The Effect of a Glaring Light Source on Extrafoveal Vision. Proceedings of the Royal Society B, Volume 122, 1937, pp. 255-280.
15. Williams, S. B. and Hanes, R. M. Visibility on Cathode-Ray Tube Screens: Intensity and Color of Ambient Illumination. Journal of Psychology, Volume 27, 1949, pp. 231-244.
16. Armed Forces--NRC Vision Committee. Standards to be Employed in Research on Visual Displays. Revised. University Lithoprints, Ypsilanti, Mich, 1950.