

FOREWORD

This report presents the results of one segment of an experimental program for the investigation of hypersonic flow separation and control characteristics being conducted by the Research Department of Grumman Aircraft Engineering Corporation, Bethpage, N. Y. Mr. Donald E. Hoak of the Flight Dynamics Laboratory, Research and Technology Division, located at Wright-Patterson Air Force Base, Ohio, is the Air Force Project Engineer for the program, which is being supported primarily under Contract AF 33(616)-8130, Air Force Task 821902.

The experimental data to be obtained, pressure distributions, heat transfer, and six component aerodynamic force data, are extensive and must be presented in a series of reports, of which this is one. These data reports are presented without analysis for the purpose of disseminating experimental information as rapidly as possible. Analyses of the data will be presented in the final report for the subject contract.

The author wishes to express his appreciation to the staff of the von Karman Facility, ARO Inc., for their helpfulness in conducting the tests and particularly to Messrs. Burchfield and Deitering for providing the machine plotted graphs of the experimental data included in this report. The tabulated data, not included herein, are available to qualified Air Force requestors as an appendix to this report. The appendix can be obtained on loan from the Flight Dynamics Laboratory, Research and Technology Division, Air Force Systems Command, Wright-Patterson Air Force Base, Ohio.

Contrails

ABSTRACT

Pressure data were obtained at Mach 8 for a winged re-entry configuration having aerodynamic controls. The basic model consisted of a clipped delta wing with an overslung cone-cylinder body. The main controls tested were partial span trailing edge flaps. Data were also obtained on the effect of tip fins, hemisphere-cylinder body and a trailing edge spoiler. The data were obtained over an angle of attack range of -50° to $+50^{\circ}$. Due to load limitations on the controls the unit test section Reynolds number varied from 3.3×10^6 at low angle of attack to 2.5×10^6 at high angle of attack.

This report has been reviewed and is approved.

for 
W. A. Sloan, Jr.
Colonel USAF
Chief, Flight Control Division
AF Flight Dynamics Laboratory

TABLE OF CONTENTS

	<u>Page</u>
Introduction	1
Description of Models	2
Description of Wind Tunnels and Equipment	4
Test Conditions	5
Data Reduction and Accuracy	6
Results and Discussion	6
References	8

Contracts

LIST OF ILLUSTRATIONS

<u>Figure</u>		<u>Page</u>
1	Model Illustration and Photographs	
	a) General Outline of Models and Remarks for Over-all Program ..	15
	b) Configuration I - Basic Wing-Body	16
	c) Configuration IV - Basic Wing-Body + Tip Fins (for dimensions see Figure 1b)	17
	d) Configuration VII - Wing - Blunt Body + Full Span Plug Spoiler (for dimensions see Figure 1b)	18
	e) Configuration VIII - Wing - Blunt Body + Full Span Plug Spoiler + Tip Fins (for dimensions see Figures 1b, 1c, 1d)	19
	f) Pressure Tap Location and Model Coordinate System	20
	g) Top View Photograph - Configuration I	21
	h) Bottom View Photograph - Configuration I	22
	i) Top View Photograph - Configuration IV	23
	j) Photograph - Configuration IV, Mounted on Actuator Housing in the 50" Hypersonic Mach 8 Wind Tunnel	24
	k) Photograph - Actuator Housing Components (1) Actuator Housing Cover, (2) Actuator Assembly, (3) Water Jacket, (4) Actuator Housing	25
	l) Photograph - Actuator Assembly (1) Electric Motors, (2) Potentiometers, (3) Lead Screws, (4) Control Rods (5) Water Cooled Bulkheads	26
2	Sign Convention for Model Angles and Control Deflection Angles	27
3	Configuration I $\alpha = 0$	
	a) C_p vs. X' $\delta_2 = \delta_3 = 0$ lower surface	
	b) C_p vs. X' $\delta_2 = \delta_3 = 0$ upper surface	
	c) C_p vs. Y' $\delta_2 = \delta_3 = 0$ lower surface	
	d) C_p vs. Y' $\delta_2 = \delta_3 = 0$ upper surface	28
	e) C_p vs. X' $\delta_2 = \delta_3 = +10$ lower surface	
	f) C_p vs. X' $\delta_2 = \delta_3 = +10$ upper surface	
	g) C_p vs. Y' $\delta_2 = \delta_3 = +10$ lower surface	
	h) C_p vs. Y' $\delta_2 = \delta_3 = +10$ upper surface	29
	i) C_p vs. X' $\delta_2 = \delta_3 = +20$ lower surface	
	j) C_p vs. Y' $\delta_2 = \delta_3 = +20$ lower surface	30
	k) C_p vs. Y' $\delta_2 = \delta_3 = +20$ upper surface	
	l) C_p vs. X' $\delta_2 = \delta_3 = +20$ upper surface	31
	m) C_p vs. Y' $\delta_2 = \delta_3 = +30$ lower surface	
	n) C_p vs. X' $\delta_2 = \delta_3 = +30$ lower surface	32
	o) C_p vs. Y' $\delta_2 = \delta_3 = +30$ upper surface	
	p) C_p vs. X' $\delta_2 = \delta_3 = +30$ upper surface	33



Contrails

	q)	C_p vs. X'	$\delta_2 = \delta_3 = +39$	lower surface	
	r)	C_p vs. Y'	$\delta_2 = \delta_3 = +39$	lower surface	34
	s)	C_p vs. Y'	$\delta_2 = \delta_3 = +39$	upper surface	
	t)	C_p vs. X'	$\delta_2 = \delta_3 = +39$	upper surface	35
4	Configuration I		$\alpha = 0$		
	a)	C_p vs. X'	$\delta_2 = \delta_3 = -10$	lower surface	
	b)	C_p vs. X'	$\delta_2 = \delta_3 = -10$	upper surface	
	c)	C_p vs. Y'	$\delta_2 = \delta_3 = -10$	lower surface	
	d)	C_p vs. Y'	$\delta_2 = \delta_3 = -10$	upper surface	36
	e)	C_p vs. Y'	$\delta_2 = \delta_3 = -20$	lower surface	
	f)	C_p vs. X'	$\delta_2 = \delta_3 = -20$	lower surface	37
	g)	C_p vs. Y'	$\delta_2 = \delta_3 = -20$	upper surface	
	h)	C_p vs. X'	$\delta_2 = \delta_3 = -20$	upper surface	38
	i)	C_p vs. Y'	$\delta_2 = \delta_3 = -30$	lower surface	
	j)	C_p vs. X'	$\delta_2 = \delta_3 = -30$	lower surface	39
	k)	C_p vs. X'	$\delta_2 = \delta_3 = -30$	upper surface	
	l)	C_p vs. Y'	$\delta_2 = \delta_3 = -30$	upper surface	40
	m)	C_p vs. X'	$\delta_2 = \delta_3 = -39$	lower surface	41
	n)	C_p vs. X'	$\delta_2 = \delta_3 = -39$	upper surface	42
	o)	C_p vs. Y'	$\delta_2 = \delta_3 = -39$	lower surface	
	p)	C_p vs. Y'	$\delta_2 = \delta_3 = -39$	upper surface	43
5	Configuration I		$\alpha = +10$		
	a)	C_p vs. X'	$\delta_2 = \delta_3 = 0$	lower surface	
	b)	C_p vs. X'	$\delta_2 = \delta_3 = 0$	upper surface	
	c)	C_p vs. Y'	$\delta_2 = \delta_3 = 0$	lower surface	
	d)	C_p vs. Y'	$\delta_2 = \delta_3 = 0$	upper surface	44
	e)	C_p vs. Y'	$\delta_2 = \delta_3 = +10$	lower surface	
	f)	C_p vs. X'	$\delta_2 = \delta_3 = +10$	lower surface	45
	g)	C_p vs. Y'	$\delta_2 = \delta_3 = +10$	upper surface	
	h)	C_p vs. X'	$\delta_2 = \delta_3 = +10$	upper surface	46
	i)	C_p vs. Y'	$\delta_2 = \delta_3 = +20$	lower surface	
	j)	C_p vs. X'	$\delta_2 = \delta_3 = +20$	lower surface	47
	k)	C_p vs. Y'	$\delta_2 = \delta_3 = +20$	upper surface	
	l)	C_p vs. X'	$\delta_2 = \delta_3 = +20$	upper surface	48
	m)	C_p vs. X'	$\delta_2 = \delta_3 = +30$	lower surface	49
	n)	C_p vs. Y'	$\delta_2 = \delta_3 = +30$	lower surface	50
	o)	C_p vs. Y'	$\delta_2 = \delta_3 = +30$	upper surface	
	p)	C_p vs. X'	$\delta_2 = \delta_3 = +30$	upper surface	51

Contrails

	q)	C _p vs. Y'	$\delta_2 = \delta_3 = +39$	lower surface	52
	r)	C _p vs. X'	$\delta_2 = \delta_3 = +39$	lower surface	53
	s)	C _p vs. Y'	$\delta_2 = \delta_3 = +39$	upper surface	
	t)	C _p vs. X'	$\delta_2 = \delta_3 = +39$	upper surface	54
6	Configuration I		$\alpha = +10$		
	a)	C _p vs. X'	$\delta_2 = \delta_3 = -10$	lower surface	
	b)	C _p vs. X'	$\delta_2 = \delta_3 = -10$	upper surface	
	c)	C _p vs. Y'	$\delta_2 = \delta_3 = -10$	lower surface	
	d)	C _p vs. Y'	$\delta_2 = \delta_3 = -10$	upper surface	55
	e)	C _p vs. X'	$\delta_2 = \delta_3 = -20$	lower surface	
	f)	C _p vs. X'	$\delta_2 = \delta_3 = -20$	upper surface	
	g)	C _p vs. Y'	$\delta_2 = \delta_3 = -20$	lower surface	
	h)	C _p vs. Y'	$\delta_2 = \delta_3 = -20$	upper surface	56
	i)	C _p vs. X'	$\delta_2 = \delta_3 = -30$	lower surface	
	j)	C _p vs. X'	$\delta_2 = \delta_3 = -30$	upper surface	
	k)	C _p vs. Y'	$\delta_2 = \delta_3 = -30$	lower surface	
	l)	C _p vs. Y'	$\delta_2 = \delta_3 = -30$	upper surface	57
	m)	C _p vs. Y'	$\delta_2 = \delta_3 = -39$	lower surface	
	n)	C _p vs. X'	$\delta_2 = \delta_3 = -39$	lower surface	58
	o)	C _p vs. Y'	$\delta_2 = \delta_3 = -39$	upper surface	
	p)	C _p vs. X'	$\delta_2 = \delta_3 = -39$	upper surface	59
7	Configuration I		$\alpha = +20$		
	a)	C _p vs. X'	$\delta_2 = \delta_3 = 0$	lower surface	
	b)	C _p vs. X'	$\delta_2 = \delta_3 = 0$	upper surface	
	c)	C _p vs. Y'	$\delta_2 = \delta_3 = 0$	lower surface	
	d)	C _p vs. Y'	$\delta_2 = \delta_3 = 0$	upper surface	60
	e)	C _p vs. X'	$\delta_2 = \delta_3 = +10$	lower surface	
	f)	C _p vs. Y'	$\delta_2 = \delta_3 = +10$	lower surface	61
	g)	C _p vs. Y'	$\delta_2 = \delta_3 = +10$	upper surface	
	h)	C _p vs. X'	$\delta_2 = \delta_3 = +10$	upper surface	62
	i)	C _p vs. X'	$\delta_2 = \delta_3 = +20$	lower surface	
	j)	C _p vs. X'	$\delta_2 = \delta_3 = +20$	upper surface	63
	k)	C _p vs. Y'	$\delta_2 = \delta_3 = +20$	lower surface	
	l)	C _p vs. Y'	$\delta_2 = \delta_3 = +20$	upper surface	64
	m)	C _p vs. Y'	$\delta_2 = \delta_3 = +30$	lower surface	65
	n)	C _p vs. X'	$\delta_2 = \delta_3 = +30$	lower surface	66
	o)	C _p vs. Y'	$\delta_2 = \delta_3 = +30$	upper surface	
	p)	C _p vs. X'	$\delta_2 = \delta_3 = +30$	upper surface	67

Contrails

	q)	C_p vs. Y'	$\delta_2 = \delta_3 = +39$	lower surface	68
	r)	C_p vs. X'	$\delta_2 = \delta_3 = +39$	lower surface	69
	s)	C_p vs. Y'	$\delta_2 = \delta_3 = +39$	upper surface	
	t)	C_p vs. X'	$\delta_2 = \delta_3 = +39$	upper surface	70
8	Configuration I		$\alpha = +20$		
	a)	C_p vs. X'	$\delta_2 = \delta_3 = -10$	lower surface	
	b)	C_p vs. Y'	$\delta_2 = \delta_3 = -10$	lower surface	71
	c)	C_p vs. X'	$\delta_2 = \delta_3 = -10$	upper surface	
	d)	C_p vs. Y'	$\delta_2 = \delta_3 = -10$	upper surface	72
	e)	C_p vs. X'	$\delta_2 = \delta_3 = -20$	lower surface	
	f)	C_p vs. Y'	$\delta_2 = \delta_3 = -20$	lower surface	73
	g)	C_p vs. X'	$\delta_2 = \delta_3 = -20$	upper surface	
	h)	C_p vs. Y'	$\delta_2 = \delta_3 = -20$	upper surface	74
	i)	C_p vs. X'	$\delta_2 = \delta_3 = -30$	lower surface	
	j)	C_p vs. Y'	$\delta_2 = \delta_3 = -30$	lower surface	75
	k)	C_p vs. X'	$\delta_2 = \delta_3 = -30$	upper surface	
	l)	C_p vs. Y'	$\delta_2 = \delta_3 = -30$	upper surface	76
	m)	C_p vs. X'	$\delta_2 = \delta_3 = -39$	lower surface	
	n)	C_p vs. Y'	$\delta_2 = \delta_3 = -39$	lower surface	77
	o)	C_p vs. X'	$\delta_2 = \delta_3 = -39$	upper surface	
	p)	C_p vs. Y'	$\delta_2 = \delta_3 = -39$	upper surface	78
9	Configuration I		$\alpha = +30$		
	a)	C_p vs. X'	$\delta_2 = \delta_3 = 0$	lower surface	
	b)	C_p vs. X'	$\delta_2 = \delta_3 = 0$	upper surface	79
	c)	C_p vs. Y'	$\delta_2 = \delta_3 = 0$	lower surface	
	d)	C_p vs. Y'	$\delta_2 = \delta_3 = 0$	upper surface	80
	e)	C_p vs. X'	$\delta_2 = \delta_3 = +10$	lower surface	
	f)	C_p vs. X'	$\delta_2 = \delta_3 = +10$	upper surface	81
	g)	C_p vs. Y'	$\delta_2 = \delta_3 = +10$	lower surface	
	h)	C_p vs. Y'	$\delta_2 = \delta_3 = +10$	upper surface	82
	i)	C_p vs. Y'	$\delta_2 = \delta_3 = +20$	lower surface	83
	j)	C_p vs. X'	$\delta_2 = \delta_3 = +20$	lower surface	84
	k)	C_p vs. Y'	$\delta_2 = \delta_3 = +20$	upper surface	
	l)	C_p vs. X'	$\delta_2 = \delta_3 = +20$	upper surface	85
	m)	C_p vs. Y'	$\delta_2 = \delta_3 = +30$	lower surface	86
	n)	C_p vs. X'	$\delta_2 = \delta_3 = +30$	lower surface	87
	o)	C_p vs. Y'	$\delta_2 = \delta_3 = +30$	upper surface	
	p)	C_p vs. X'	$\delta_2 = \delta_3 = +30$	upper surface	88

Contrails

	q)	C_p vs. Y'	$\delta_2 = \delta_3 = +39$	lower surface	89
	r)	C_p vs. X'	$\delta_2 = \delta_3 = +39$	lower surface	90
	s)	C_p vs. Y'	$\delta_2 = \delta_3 = +39$	upper surface	
	t)	C_p vs. X'	$\delta_2 = \delta_3 = +39$	upper surface	91
10	Configuration I		$\alpha = +30$		
	a)	C_p vs. Y'	$\delta_2 = \delta_3 = -20$	lower surface	
	b)	C_p vs. X'	$\delta_2 = \delta_3 = -20$	lower surface	92
	c)	C_p vs. Y'	$\delta_2 = \delta_3 = -20$	upper surface	
	d)	C_p vs. X'	$\delta_2 = \delta_3 = -20$	upper surface	93
	e)	C_p vs. Y'	$\delta_2 = \delta_3 = -39$	lower surface	
	f)	C_p vs. X'	$\delta_2 = \delta_3 = -39$	lower surface	94
	g)	C_p vs. Y'	$\delta_2 = \delta_3 = -39$	upper surface	
	h)	C_p vs. X'	$\delta_2 = \delta_3 = -39$	upper surface	95
11	Configuration I		$\alpha = +40$		
	a)	C_p vs. X'	$\delta_2 = \delta_3 = 0$	lower surface	
	b)	C_p vs. X'	$\delta_2 = \delta_3 = 0$	upper surface	96
	c)	C_p vs. Y'	$\delta_2 = \delta_3 = 0$	lower surface	
	d)	C_p vs. Y'	$\delta_2 = \delta_3 = 0$	upper surface	97
	e)	C_p vs. Y'	$\delta_2 = \delta_3 = +10$	lower surface	98
	f)	C_p vs. X'	$\delta_2 = \delta_3 = +10$	lower surface	99
	g)	C_p vs. Y'	$\delta_2 = \delta_3 = +10$	upper surface	
	h)	C_p vs. X'	$\delta_2 = \delta_3 = +10$	upper surface	100
	i)	C_p vs. Y'	$\delta_2 = \delta_3 = +20$	lower surface	101
	j)	C_p vs. X'	$\delta_2 = \delta_3 = +20$	lower surface	102
	k)	C_p vs. Y'	$\delta_2 = \delta_3 = +20$	upper surface	
	l)	C_p vs. X'	$\delta_2 = \delta_3 = +20$	upper surface	103
	m)	C_p vs. Y'	$\delta_2 = \delta_3 = +30$	lower surface	104
	n)	C_p vs. X'	$\delta_2 = \delta_3 = +30$	lower surface	105
	o)	C_p vs. Y'	$\delta_2 = \delta_3 = +30$	upper surface	
	p)	C_p vs. X'	$\delta_2 = \delta_3 = +30$	upper surface	106
	q)	C_p vs. Y'	$\delta_2 = \delta_3 = +39$	lower surface	107
	r)	C_p vs. X'	$\delta_2 = \delta_3 = +39$	lower surface	108
	s)	C_p vs. Y'	$\delta_2 = \delta_3 = +39$	upper surface	
	t)	C_p vs. X'	$\delta_2 = \delta_3 = +39$	upper surface	109
12	Configuration I		$\alpha = +40$		
	a)	C_p vs. Y'	$\delta_2 = \delta_3 = -20$	lower surface	
	b)	C_p vs. X'	$\delta_2 = \delta_3 = -20$	lower surface	110
	c)	C_p vs. Y'	$\delta_2 = \delta_3 = -20$	upper surface	111

Contrails

	d)	C_p vs. X'	$\delta_2 = \delta_3 = -20$	upper surface	111
	e)	C_p vs. Y'	$\delta_2 = \delta_3 = -39$	lower surface	
	f)	C_p vs. X'	$\delta_2 = \delta_3 = -39$	lower surface	112
	g)	C_p vs. Y'	$\delta_2 = \delta_3 = -39$	upper surface	
	h)	C_p vs. X'	$\delta_2 = \delta_3 = -39$	upper surface	113
13	Configuration I		$\alpha = +50$		
	a)	C_p vs. Y'	$\delta_2 = \delta_3 = 0$	lower surface	114
	b)	C_p vs. X'	$\delta_2 = \delta_3 = 0$	lower surface	115
	c)	C_p vs. Y'	$\delta_2 = \delta_3 = 0$	upper surface	
	d)	C_p vs. X'	$\delta_2 = \delta_3 = 0$	upper surface	116
	e)	C_p vs. Y'	$\delta_2 = \delta_3 = +10$	lower surface	117
	f)	C_p vs. X'	$\delta_2 = \delta_3 = +10$	lower surface	118
	g)	C_p vs. Y'	$\delta_2 = \delta_3 = +10$	upper surface	
	h)	C_p vs. X'	$\delta_2 = \delta_3 = +10$	upper surface	119
	i)	C_p vs. Y'	$\delta_2 = \delta_3 = +20$	lower surface	120
	j)	C_p vs. X'	$\delta_2 = \delta_3 = +20$	lower surface	121
	k)	C_p vs. Y'	$\delta_2 = \delta_3 = +20$	upper surface	
	l)	C_p vs. X'	$\delta_2 = \delta_3 = +20$	upper surface	122
	m)	C_p vs. Y'	$\delta_2 = \delta_3 = +39$	lower surface	123
	n)	C_p vs. X'	$\delta_2 = \delta_3 = +39$	lower surface	124
	o)	C_p vs. Y'	$\delta_2 = \delta_3 = +39$	upper surface	
	p)	C_p vs. X'	$\delta_2 = \delta_3 = +39$	upper surface	125
14	Configuration I		$\alpha = +50$		
	a)	C_p vs. X'	$\delta_2 = \delta_3 = -20$	upper surface	
	b)	C_p vs. X'	$\delta_2 = \delta_3 = -20$	lower surface	126
	c)	C_p vs. Y'	$\delta_2 = \delta_3 = -20$	upper surface	
	d)	C_p vs. Y'	$\delta_2 = \delta_3 = -20$	lower surface	127
	e)	C_p vs. X'	$\delta_2 = \delta_3 = -39$	upper surface	
	f)	C_p vs. X'	$\delta_2 = \delta_3 = -39$	lower surface	128
	g)	C_p vs. Y'	$\delta_2 = \delta_3 = -39$	upper surface	
	h)	C_p vs. Y'	$\delta_2 = \delta_3 = -39$	lower surface	129
15	Configuration I		$\alpha = -5$		
	a)	C_p vs. X'	$\delta_2 = \delta_3 = 0$	upper surface	
	b)	C_p vs. X'	$\delta_2 = \delta_3 = 0$	lower surface	
	c)	C_p vs. Y'	$\delta_2 = \delta_3 = 0$	upper surface	
	d)	C_p vs. Y'	$\delta_2 = \delta_3 = 0$	lower surface	130
16	Configuration I		$\alpha = -10$		
	a)	C_p vs. X'	$\delta_2 = \delta_3 = 0$	lower surface	
	b)	C_p vs. X'	$\delta_2 = \delta_3 = 0$	upper surface	131

Contrails

c)	C _p vs. Y'	$\delta_2 = \delta_3 = 0$	lower surface	
d)	C _p vs. Y'	$\delta_2 = \delta_3 = 0$	upper surface	131
e)	C _p vs. X'	$\delta_2 = \delta_3 = +10$	lower surface	
f)	C _p vs. X'	$\delta_2 = \delta_3 = +10$	upper surface	
g)	C _p vs. Y'	$\delta_2 = \delta_3 = +10$	lower surface	
h)	C _p vs. Y'	$\delta_2 = \delta_3 = +10$	upper surface	132
i)	C _p vs. X'	$\delta_2 = \delta_3 = +20$	lower surface	
j)	C _p vs. X'	$\delta_2 = \delta_3 = +20$	upper surface	
k)	C _p vs. Y'	$\delta_2 = \delta_3 = +20$	lower surface	
l)	C _p vs. Y'	$\delta_2 = \delta_3 = +20$	upper surface	133
m)	C _p vs. Y'	$\delta_2 = \delta_3 = +30$	lower surface	
n)	C _p vs. X'	$\delta_2 = \delta_3 = +30$	lower surface	134
o)	C _p vs. Y'	$\delta_2 = \delta_3 = +30$	upper surface	
p)	C _p vs. X'	$\delta_2 = \delta_3 = +30$	upper surface	135
q)	C _p vs. Y'	$\delta_2 = \delta_3 = +39$	lower surface	
r)	C _p vs. X'	$\delta_2 = \delta_3 = +39$	lower surface	136
s)	C _p vs. Y'	$\delta_2 = \delta_3 = +39$	upper surface	
t)	C _p vs. X'	$\delta_2 = \delta_3 = +39$	upper surface	137

17

Configuration I $\alpha = -10$

a)	C _p vs. Y'	$\delta_2 = \delta_3 = -10$	lower surface	
b)	C _p vs. X'	$\delta_2 = \delta_3 = -10$	lower surface	138
c)	C _p vs. Y'	$\delta_2 = \delta_3 = -10$	upper surface	
d)	C _p vs. X'	$\delta_2 = \delta_3 = -10$	upper surface	139
e)	C _p vs. Y'	$\delta_2 = \delta_3 = -20$	lower surface	
f)	C _p vs. X'	$\delta_2 = \delta_3 = -20$	lower surface	140
g)	C _p vs. Y'	$\delta_2 = \delta_3 = -20$	upper surface	
h)	C _p vs. X'	$\delta_2 = \delta_3 = -20$	upper surface	141
i)	C _p vs. Y'	$\delta_2 = \delta_3 = -30$	lower surface	
j)	C _p vs. X'	$\delta_2 = \delta_3 = -30$	lower surface	142
k)	C _p vs. Y'	$\delta_2 = \delta_3 = -30$	upper surface	143
l)	C _p vs. X'	$\delta_2 = \delta_3 = -30$	upper surface	144
m)	C _p vs. Y'	$\delta_2 = \delta_3 = -39$	lower surface	
n)	C _p vs. X'	$\delta_2 = \delta_3 = -39$	lower surface	145
o)	C _p vs. Y'	$\delta_2 = \delta_3 = -39$	upper surface	146
p)	C _p vs. X'	$\delta_2 = \delta_3 = -39$	upper surface	147

18

Configuration I $\alpha = -15$

a)	C _p vs. X'	$\delta_2 = \delta_3 = 0$	lower surface	
b)	C _p vs. X'	$\delta_2 = \delta_3 = 0$	upper surface	148

Contrails

	c)	C_p vs. Y'	$\delta_2 = \delta_3 = 0$	lower surface	
	d)	C_p vs. Y'	$\delta_2 = \delta_3 = 0$	upper surface	148
19	Configuration I		$\alpha = -20$		
	a)	C_p vs. Y'	$\delta_2 = \delta_3 = 0$	lower surface	
	b)	C_p vs. X'	$\delta_2 = \delta_3 = 0$	lower surface	149
	c)	C_p vs. Y'	$\delta_2 = \delta_3 = 0$	upper surface	
	d)	C_p vs. X'	$\delta_2 = \delta_3 = 0$	upper surface	150
	e)	C_p vs. Y'	$\delta_2 = \delta_3 = +10$	lower surface	
	f)	C_p vs. X'	$\delta_2 = \delta_3 = +10$	lower surface	151
	g)	C_p vs. Y'	$\delta_2 = \delta_3 = +10$	upper surface	
	h)	C_p vs. X'	$\delta_2 = \delta_3 = +10$	upper surface	152
	i)	C_p vs. Y'	$\delta_2 = \delta_3 = +20$	lower surface	
	j)	C_p vs. X'	$\delta_2 = \delta_3 = +20$	lower surface	153
	k)	C_p vs. Y'	$\delta_2 = \delta_3 = +20$	upper surface	
	l)	C_p vs. X'	$\delta_2 = \delta_3 = +20$	upper surface	154
	m)	C_p vs. Y'	$\delta_2 = \delta_3 = +30$	lower surface	
	n)	C_p vs. X'	$\delta_2 = \delta_3 = +30$	lower surface	155
	o)	C_p vs. Y'	$\delta_2 = \delta_3 = +30$	upper surface	
	p)	C_p vs. X'	$\delta_2 = \delta_3 = +30$	upper surface	156
	q)	C_p vs. Y'	$\delta_2 = \delta_3 = +39$	lower surface	
	r)	C_p vs. X'	$\delta_2 = \delta_3 = +39$	lower surface	157
	s)	C_p vs. Y'	$\delta_2 = \delta_3 = +39$	upper surface	
	t)	C_p vs. X'	$\delta_2 = \delta_3 = +39$	upper surface	158
20	Configuration I		$\alpha = -20$		
	a)	C_p vs. Y'	$\delta_2 = \delta_3 = -10$	lower surface	
	b)	C_p vs. X'	$\delta_2 = \delta_3 = -10$	lower surface	159
	c)	C_p vs. Y'	$\delta_2 = \delta_3 = -10$	upper surface	
	d)	C_p vs. X'	$\delta_2 = \delta_3 = -10$	upper surface	160
	e)	C_p vs. Y'	$\delta_2 = \delta_3 = -20$	lower surface	
	f)	C_p vs. X'	$\delta_2 = \delta_3 = -20$	lower surface	161
	g)	C_p vs. Y'	$\delta_2 = \delta_3 = -20$	upper surface	162
	h)	C_p vs. X'	$\delta_2 = \delta_3 = -20$	upper surface	163
	i)	C_p vs. Y'	$\delta_2 = \delta_3 = -30$	lower surface	
	j)	C_p vs. X'	$\delta_2 = \delta_3 = -30$	lower surface	164
	k)	C_p vs. Y'	$\delta_2 = \delta_3 = -30$	upper surface	165
	l)	C_p vs. X'	$\delta_2 = \delta_3 = -30$	upper surface	166
	m)	C_p vs. Y'	$\delta_2 = \delta_3 = -39$	lower surface	
	n)	C_p vs. X'	$\delta_2 = \delta_3 = -39$	lower surface	167

Contrails

	o) C_p vs. Y'	$\delta_2 = \delta_3 = -39$	upper surface	168
	p) C_p vs. X'	$\delta_2 = \delta_3 = -39$	upper surface	169
21	Configuration I	$\alpha = -25$		
	a) C_p vs. Y'	$\delta_2 = \delta_3 = 0$	lower surface	
	b) C_p vs. X'	$\delta_2 = \delta_3 = 0$	lower surface	170
	c) C_p vs. Y'	$\delta_2 = \delta_3 = 0$	upper surface	
	d) C_p vs. X'	$\delta_2 = \delta_3 = 0$	upper surface	171
22	Configuration I	$\alpha = -30$		
	a) C_p vs. Y'	$\delta_2 = \delta_3 = 0$	lower surface	
	b) C_p vs. X'	$\delta_2 = \delta_3 = 0$	lower surface	172
	c) C_p vs. Y'	$\delta_2 = \delta_3 = 0$	upper surface	
	d) C_p vs. X'	$\delta_2 = \delta_3 = 0$	upper surface	173
	e) C_p vs. Y'	$\delta_2 = \delta_3 = +20$	lower surface	
	f) C_p vs. X'	$\delta_2 = \delta_3 = +20$	lower surface	174
	g) C_p vs. Y'	$\delta_2 = \delta_3 = +20$	upper surface	
	h) C_p vs. X'	$\delta_2 = \delta_3 = +20$	upper surface	175
	i) C_p vs. Y'	$\delta_2 = \delta_3 = +30$	lower surface	
	j) C_p vs. X'	$\delta_2 = \delta_3 = +30$	lower surface	176
	k) C_p vs. Y'	$\delta_2 = \delta_3 = +30$	upper surface	
	l) C_p vs. X'	$\delta_2 = \delta_3 = +30$	upper surface	177
	m) C_p vs. Y'	$\delta_2 = \delta_3 = +39$	lower surface	
	n) C_p vs. X'	$\delta_2 = \delta_3 = +39$	lower surface	178
	o) C_p vs. Y'	$\delta_2 = \delta_3 = +39$	upper surface	
	p) C_p vs. X'	$\delta_2 = \delta_3 = +39$	upper surface	179
23	Configuration I	$\alpha = -30$		
	a) C_p vs. X'	$\delta_2 = \delta_3 = -10$	lower surface	
	b) C_p vs. X'	$\delta_2 = \delta_3 = -10$	upper surface	180
	c) C_p vs. Y'	$\delta_2 = \delta_3 = -10$	lower surface	
	d) C_p vs. Y'	$\delta_2 = \delta_3 = -10$	upper surface	181
	e) C_p vs. Y'	$\delta_2 = \delta_3 = -20$	lower surface	
	f) C_p vs. X'	$\delta_2 = \delta_3 = -20$	lower surface	182
	g) C_p vs. Y'	$\delta_2 = \delta_3 = -20$	upper surface	183
	h) C_p vs. X'	$\delta_2 = \delta_3 = -20$	upper surface	184
	i) C_p vs. Y'	$\delta_2 = \delta_3 = -30$	lower surface	
	j) C_p vs. X'	$\delta_2 = \delta_3 = -30$	lower surface	185
	k) C_p vs. Y'	$\delta_2 = \delta_3 = -30$	upper surface	186
	l) C_p vs. X'	$\delta_2 = \delta_3 = -30$	upper surface	187

Contrails

	m)	C_p vs. Y'	$\delta_2 = \delta_3 = -39$	lower surface	
	n)	C_p vs. X'	$\delta_2 = \delta_3 = -39$	lower surface	188
	o)	C_p vs. Y'	$\delta_2 = \delta_3 = -39$	upper surface	189
	p)	C_p vs. X'	$\delta_2 = \delta_3 = -39$	upper surface	190
24		Configuration I	$\alpha = -35$		
	a)	C_p vs. Y'	$\delta_2 = \delta_3 = -30$	lower surface	
	b)	C_p vs. X'	$\delta_2 = \delta_3 = -30$	lower surface	191
	c)	C_p vs. Y'	$\delta_2 = \delta_3 = -30$	upper surface	192
	d)	C_p vs. X'	$\delta_2 = \delta_3 = -30$	upper surface	193
25		Configuration I	$\alpha = -40$		
	a)	C_p vs. X'	$\delta_2 = \delta_3 = 0$	lower surface	
	b)	C_p vs. X'	$\delta_2 = \delta_3 = 0$	upper surface	194
	c)	C_p vs. Y'	$\delta_2 = \delta_3 = 0$	lower surface	
	d)	C_p vs. Y'	$\delta_2 = \delta_3 = 0$	upper surface	195
	e)	C_p vs. X'	$\delta_2 = \delta_3 = +20$	lower surface	
	f)	C_p vs. X'	$\delta_2 = \delta_3 = +20$	upper surface	196
	g)	C_p vs. Y'	$\delta_2 = \delta_3 = +20$	lower surface	
	h)	C_p vs. Y'	$\delta_2 = \delta_3 = +20$	upper surface	197
	i)	C_p vs. X'	$\delta_2 = \delta_3 = +30$	lower surface	
	j)	C_p vs. X'	$\delta_2 = \delta_3 = +30$	upper surface	198
	k)	C_p vs. Y'	$\delta_2 = \delta_3 = +30$	lower surface	
	l)	C_p vs. Y'	$\delta_2 = \delta_3 = +30$	upper surface	199
	m)	C_p vs. X'	$\delta_2 = \delta_3 = +39$	lower surface	
	n)	C_p vs. X'	$\delta_2 = \delta_3 = +39$	upper surface	200
	o)	C_p vs. Y'	$\delta_2 = \delta_3 = +39$	lower surface	
	p)	C_p vs. Y'	$\delta_2 = \delta_3 = +39$	upper surface	201
26		Configuration I	$\alpha = -40$		
	a)	C_p vs. X'	$\delta_2 = \delta_3 = -10$	lower surface	
	b)	C_p vs. X'	$\delta_2 = \delta_3 = -10$	upper surface	202
	c)	C_p vs. Y'	$\delta_2 = \delta_3 = -10$	lower surface	
	d)	C_p vs. Y'	$\delta_2 = \delta_3 = -10$	upper surface	203
	e)	C_p vs. Y'	$\delta_2 = \delta_3 = -20$	lower surface	
	f)	C_p vs. X'	$\delta_2 = \delta_3 = -20$	lower surface	204
	g)	C_p vs. Y'	$\delta_2 = \delta_3 = -20$	upper surface	205
	h)	C_p vs. X'	$\delta_2 = \delta_3 = -20$	upper surface	206
	i)	C_p vs. Y'	$\delta_2 = \delta_3 = -30$	lower surface	
	j)	C_p vs. X'	$\delta_2 = \delta_3 = -30$	lower surface	207
	k)	C_p vs. Y'	$\delta_2 = \delta_3 = -30$	upper surface	208

Contrails

	1) C_p vs. X'	$\delta_2 = \delta_3 = -30$	upper surface	209
	m) C_p vs. Y'	$\delta_2 = \delta_3 = -39$	lower surface	
	n) C_p vs. X'	$\delta_2 = \delta_3 = -39$	lower surface	210
	o) C_p vs. Y'	$\delta_2 = \delta_3 = -39$	upper surface	211
	p) C_p vs. X'	$\delta_2 = \delta_3 = -39$	upper surface	212
27	Configuration I	$\alpha = -50$		
	a) C_p vs. X'	$\delta_2 = \delta_3 = 0$	lower surface	
	b) C_p vs. X'	$\delta_2 = \delta_3 = 0$	upper surface	213
	c) C_p vs. Y'	$\delta_2 = \delta_3 = 0$	lower surface	
	d) C_p vs. Y'	$\delta_2 = \delta_3 = 0$	upper surface	214
	e) C_p vs. X'	$\delta_2 = \delta_3 = +20$	lower surface	
	f) C_p vs. X'	$\delta_2 = \delta_3 = +20$	upper surface	215
	g) C_p vs. Y'	$\delta_2 = \delta_3 = +20$	lower surface	
	h) C_p vs. Y'	$\delta_2 = \delta_3 = +20$	upper surface	216
	i) C_p vs. X'	$\delta_2 = \delta_3 = +30$	lower surface	
	j) C_p vs. X'	$\delta_2 = \delta_3 = +30$	upper surface	217
	k) C_p vs. Y'	$\delta_2 = \delta_3 = +30$	lower surface	
	l) C_p vs. Y'	$\delta_2 = \delta_3 = +30$	upper surface	218
	m) C_p vs. X'	$\delta_2 = \delta_3 = +39$	lower surface	
	n) C_p vs. X'	$\delta_2 = \delta_3 = +39$	upper surface	219
	o) C_p vs. Y'	$\delta_2 = \delta_3 = +39$	lower surface	
	p) C_p vs. Y'	$\delta_2 = \delta_3 = +39$	upper surface	220
28	Configuration I	$\alpha = -50$		
	a) C_p vs. Y'	$\delta_2 = \delta_3 = -10$	lower surface	
	b) C_p vs. X'	$\delta_2 = \delta_3 = -10$	lower surface	221
	c) C_p vs. Y'	$\delta_2 = \delta_3 = -10$	upper surface	222
	d) C_p vs. X'	$\delta_2 = \delta_3 = -10$	upper surface	223
	e) C_p vs. Y'	$\delta_2 = \delta_3 = -20$	lower surface	
	f) C_p vs. X'	$\delta_2 = \delta_3 = -20$	lower surface	224
	g) C_p vs. Y'	$\delta_2 = \delta_3 = -20$	upper surface	225
	h) C_p vs. X'	$\delta_2 = \delta_3 = -20$	upper surface	226
	i) C_p vs. Y'	$\delta_2 = \delta_3 = -30$	lower surface	
	j) C_p vs. X'	$\delta_2 = \delta_3 = -30$	lower surface	227
	k) C_p vs. Y'	$\delta_2 = \delta_3 = -30$	upper surface	228
	l) C_p vs. X'	$\delta_2 = \delta_3 = -30$	upper surface	229
	m) C_p vs. Y'	$\delta_2 = \delta_3 = -39$	lower surface	
	n) C_p vs. X'	$\delta_2 = \delta_3 = -39$	lower surface	230
	o) C_p vs. Y'	$\delta_2 = \delta_3 = -39$	upper surface	231
	p) C_p vs. X'	$\delta_2 = \delta_3 = -39$	upper surface	232

Contrails

29

Configuration IV

$\alpha = 0$

a)	C_p vs. Y'	$\delta_2 = \delta_3 = 0$	lower surface	
b)	C_p vs. Y'	$\delta_2 = \delta_3 = 0$	upper surface	
c)	C_p vs. X'	$\delta_2 = \delta_3 = 0$	lower surface	
d)	C_p vs. X'	$\delta_2 = \delta_3 = 0$	upper surface 233
e)	C_p vs. Y'	$\delta_2 = \delta_3 = +10$	lower surface	
f)	C_p vs. X'	$\delta_2 = \delta_3 = +10$	lower surface 234
g)	C_p vs. Y'	$\delta_2 = \delta_3 = +10$	upper surface	
h)	C_p vs. X'	$\delta_2 = \delta_3 = +10$	upper surface 235
i)	C_p vs. Y'	$\delta_2 = \delta_3 = +20$	lower surface	
j)	C_p vs. X'	$\delta_2 = \delta_3 = +20$	lower surface 236
k)	C_p vs. Y'	$\delta_2 = \delta_3 = +20$	upper surface	
l)	C_p vs. X'	$\delta_2 = \delta_3 = +20$	upper surface 237
m)	C_p vs. Y'	$\delta_2 = \delta_3 = +30$	lower surface	
n)	C_p vs. X'	$\delta_2 = \delta_3 = +30$	lower surface 238
o)	C_p vs. Y'	$\delta_2 = \delta_3 = +30$	upper surface	
p)	C_p vs. X'	$\delta_2 = \delta_3 = +30$	upper surface 239
q)	C_p vs. Y'	$\delta_2 = \delta_3 = +39$	lower surface 240
r)	C_p vs. X'	$\delta_2 = \delta_3 = +39$	lower surface 241
s)	C_p vs. Y'	$\delta_2 = \delta_3 = +39$	upper surface	
t)	C_p vs. X'	$\delta_2 = \delta_3 = +39$	upper surface 242

30

Configuration IV

$\alpha = 0$

a)	C_p vs. Y'	$\delta_2 = \delta_3 = -10$	lower surface	
b)	C_p vs. Y'	$\delta_2 = \delta_3 = -10$	upper surface	
c)	C_p vs. X'	$\delta_2 = \delta_3 = -10$	lower surface	
d)	C_p vs. X'	$\delta_2 = \delta_3 = -10$	upper surface 243
e)	C_p vs. Y'	$\delta_2 = \delta_3 = -20$	lower surface	
f)	C_p vs. X'	$\delta_2 = \delta_3 = -20$	lower surface 244
g)	C_p vs. Y'	$\delta_2 = \delta_3 = -20$	upper surface	
h)	C_p vs. X'	$\delta_2 = \delta_3 = -20$	upper surface 245
i)	C_p vs. Y'	$\delta_2 = \delta_3 = -30$	lower surface	
j)	C_p vs. X'	$\delta_2 = \delta_3 = -30$	lower surface 246
k)	C_p vs. Y'	$\delta_2 = \delta_3 = -30$	upper surface	
l)	C_p vs. X'	$\delta_2 = \delta_3 = -30$	upper surface 247
m)	C_p vs. Y'	$\delta_2 = \delta_3 = -39$	lower surface	
n)	C_p vs. X'	$\delta_2 = \delta_3 = -39$	lower surface 248
o)	C_p vs. Y'	$\delta_2 = \delta_3 = -39$	upper surface 249
p)	C_p vs. X'	$\delta_2 = \delta_3 = -39$	upper surface 250

Contrails

31	Configuration IV	$\alpha = +10$		
	a)	C_p vs. Y'	$\delta_2 = \delta_3 = 0$	lower surface
	b)	C_p vs. Y'	$\delta_2 = \delta_3 = 0$	upper surface
	c)	C_p vs. X'	$\delta_2 = \delta_3 = 0$	lower surface
	d)	C_p vs. X'	$\delta_2 = \delta_3 = 0$	upper surface 251
	e)	C_p vs. Y'	$\delta_2 = \delta_3 = +10$	lower surface
	f)	C_p vs. X'	$\delta_2 = \delta_3 = +10$	lower surface 252
	g)	C_p vs. Y'	$\delta_2 = \delta_3 = +10$	upper surface
	h)	C_p vs. X'	$\delta_2 = \delta_3 = +10$	upper surface 253
	i)	C_p vs. Y'	$\delta_2 = \delta_3 = +20$	lower surface 254
	j)	C_p vs. X'	$\delta_2 = \delta_3 = +20$	lower surface 255
	k)	C_p vs. Y'	$\delta_2 = \delta_3 = +20$	upper surface
	l)	C_p vs. X'	$\delta_2 = \delta_3 = +20$	upper surface 256
	m)	C_p vs. Y'	$\delta_2 = \delta_3 = +30$	lower surface 257
	n)	C_p vs. X'	$\delta_2 = \delta_3 = +30$	lower surface 258
	o)	C_p vs. Y'	$\delta_2 = \delta_3 = +30$	upper surface
	p)	C_p vs. X'	$\delta_2 = \delta_3 = +30$	upper surface 259
	q)	C_p vs. Y'	$\delta_2 = \delta_3 = +39$	lower surface 260
	r)	C_p vs. X'	$\delta_2 = \delta_3 = +39$	lower surface 261
	s)	C_p vs. Y'	$\delta_2 = \delta_3 = +39$	upper surface
	t)	C_p vs. X'	$\delta_2 = \delta_3 = +39$	upper surface 262
32	Configuration IV	$\alpha = +10$		
	a)	C_p vs. Y'	$\delta_2 = \delta_3 = -10$	lower surface
	b)	C_p vs. Y'	$\delta_2 = \delta_3 = -10$	upper surface
	c)	C_p vs. X'	$\delta_2 = \delta_3 = -10$	lower surface
	d)	C_p vs. X'	$\delta_2 = \delta_3 = -10$	upper surface 263
	e)	C_p vs. Y'	$\delta_2 = \delta_3 = -20$	lower surface
	f)	C_p vs. Y'	$\delta_2 = \delta_3 = -20$	upper surface
	g)	C_p vs. X'	$\delta_2 = \delta_3 = -20$	lower surface
	h)	C_p vs. X'	$\delta_2 = \delta_3 = -20$	upper surface 264
	i)	C_p vs. Y'	$\delta_2 = \delta_3 = -30$	lower surface
	j)	C_p vs. Y'	$\delta_2 = \delta_3 = -30$	upper surface
	k)	C_p vs. X'	$\delta_2 = \delta_3 = -30$	lower surface
	l)	C_p vs. X'	$\delta_2 = \delta_3 = -30$	upper surface 265
	m)	C_p vs. Y'	$\delta_2 = \delta_3 = -39$	lower surface
	n)	C_p vs. X'	$\delta_2 = \delta_3 = -39$	lower surface 266
	o)	C_p vs. Y'	$\delta_2 = \delta_3 = -39$	upper surface
	p)	C_p vs. X'	$\delta_2 = \delta_3 = -39$	upper surface 267

Contrails

33	Configuration IV	$\alpha = +20$		
	a) C_p vs. Y'	$\delta_2 = \delta_3 = 0$	lower surface	
	b) C_p vs. X'	$\delta_2 = \delta_3 = 0$	lower surface	268
	c) C_p vs. Y'	$\delta_2 = \delta_3 = 0$	upper surface	
	d) C_p vs. X'	$\delta_2 = \delta_3 = 0$	upper surface	269
	e) C_p vs. Y'	$\delta_2 = \delta_3 = +10$	lower surface	270
	f) C_p vs. X'	$\delta_2 = \delta_3 = +10$	lower surface	271
	g) C_p vs. Y'	$\delta_2 = \delta_3 = +10$	upper surface	
	h) C_p vs. X'	$\delta_2 = \delta_3 = +10$	upper surface	272
	i) C_p vs. Y'	$\delta_2 = \delta_3 = +20$	lower surface	273
	j) C_p vs. X'	$\delta_2 = \delta_3 = +20$	lower surface	274
	k) C_p vs. Y'	$\delta_2 = \delta_3 = +20$	upper surface	
	l) C_p vs. X'	$\delta_2 = \delta_3 = +20$	upper surface	275
	m) C_p vs. Y'	$\delta_2 = \delta_3 = +30$	lower surface	276
	n) C_p vs. X'	$\delta_2 = \delta_3 = +30$	lower surface	277
	o) C_p vs. Y'	$\delta_2 = \delta_3 = +30$	upper surface	
	p) C_p vs. X'	$\delta_2 = \delta_3 = +30$	upper surface	278
	q) C_p vs. Y'	$\delta_2 = \delta_3 = +39$	lower surface	279
	r) C_p vs. X'	$\delta_2 = \delta_3 = +39$	lower surface	280
	s) C_p vs. Y'	$\delta_2 = \delta_3 = +39$	upper surface	
	t) C_p vs. X'	$\delta_2 = \delta_3 = +39$	upper surface	281
34	Configuration IV	$\alpha = +20$		
	a) C_p vs. Y'	$\delta_2 = \delta_3 = -10$	lower surface	
	b) C_p vs. X'	$\delta_2 = \delta_3 = -10$	lower surface	282
	c) C_p vs. Y'	$\delta_2 = \delta_3 = -10$	upper surface	
	d) C_p vs. X'	$\delta_2 = \delta_3 = -10$	upper surface	283
	e) C_p vs. Y'	$\delta_2 = \delta_3 = -20$	lower surface	
	f) C_p vs. X'	$\delta_2 = \delta_3 = -20$	lower surface	284
	g) C_p vs. Y'	$\delta_2 = \delta_3 = -20$	upper surface	
	h) C_p vs. X'	$\delta_2 = \delta_3 = -20$	upper surface	285
	i) C_p vs. Y'	$\delta_2 = \delta_3 = -30$	lower surface	
	j) C_p vs. X'	$\delta_2 = \delta_3 = -30$	lower surface	286
	k) C_p vs. Y'	$\delta_2 = \delta_3 = -30$	upper surface	
	l) C_p vs. X'	$\delta_2 = \delta_3 = -30$	upper surface	287
	m) C_p vs. Y'	$\delta_2 = \delta_3 = -39$	lower surface	
	n) C_p vs. X'	$\delta_2 = \delta_3 = -39$	lower surface	288
	o) C_p vs. Y'	$\delta_2 = \delta_3 = -39$	upper surface	
	p) C_p vs. X'	$\delta_2 = \delta_3 = -39$	upper surface	289

Contrails

35	Configuration IV	$\alpha = +30$	
	a) C_p vs. Y'	$\delta_2 = \delta_3 = 0$	lower surface
	b) C_p vs. X'	$\delta_2 = \delta_3 = 0$	lower surface 290
	c) C_p vs. Y'	$\delta_2 = \delta_3 = 0$	upper surface
	d) C_p vs. X'	$\delta_2 = \delta_3 = 0$	upper surface 291
	e) C_p vs. Y'	$\delta_2 = \delta_3 = +10$	lower surface 292
	f) C_p vs. X'	$\delta_2 = \delta_3 = +10$	lower surface 293
	g) C_p vs. Y'	$\delta_2 = \delta_3 = +10$	upper surface
	h) C_p vs. X'	$\delta_2 = \delta_3 = +10$	upper surface 294
	i) C_p vs. Y'	$\delta_2 = \delta_3 = +20$	lower surface
	j) C_p vs. X'	$\delta_2 = \delta_3 = +20$	lower surface 295
	k) C_p vs. Y'	$\delta_2 = \delta_3 = +20$	upper surface
	l) C_p vs. X'	$\delta_2 = \delta_3 = +20$	upper surface 296
	m) C_p vs. Y'	$\delta_2 = \delta_3 = +30$	lower surface 297
	n) C_p vs. X'	$\delta_2 = \delta_3 = +30$	lower surface 298
	o) C_p vs. Y'	$\delta_2 = \delta_3 = +30$	upper surface
	p) C_p vs. X'	$\delta_2 = \delta_3 = +30$	upper surface 299
	q) C_p vs. Y'	$\delta_2 = \delta_3 = +39$	lower surface 300
	r) C_p vs. X'	$\delta_2 = \delta_3 = +39$	lower surface 301
	s) C_p vs. Y'	$\delta_2 = \delta_3 = +39$	upper surface
	t) C_p vs. X'	$\delta_2 = \delta_3 = +39$	upper surface 302
36	Configuration IV	$\alpha = +30$	
	a) C_p vs. Y'	$\delta_2 = \delta_3 = -20$	lower surface
	b) C_p vs. X'	$\delta_2 = \delta_3 = -20$	lower surface 303
	c) C_p vs. Y'	$\delta_2 = \delta_3 = -20$	upper surface
	d) C_p vs. X'	$\delta_2 = \delta_3 = -20$	upper surface 304
	e) C_p vs. Y'	$\delta_2 = \delta_3 = -39$	lower surface
	f) C_p vs. X'	$\delta_2 = \delta_3 = -39$	lower surface 305
	g) C_p vs. Y'	$\delta_2 = \delta_3 = -39$	upper surface
	h) C_p vs. X'	$\delta_2 = \delta_3 = -39$	upper surface 306
37	Configuration IV	$\alpha = +40$	
	a) C_p vs. Y'	$\delta_2 = \delta_3 = 0$	lower surface 307
	b) C_p vs. X'	$\delta_2 = \delta_3 = 0$	lower surface 308
	c) C_p vs. Y'	$\delta_2 = \delta_3 = 0$	upper surface
	d) C_p vs. X'	$\delta_2 = \delta_3 = 0$	upper surface 309
	e) C_p vs. Y'	$\delta_2 = \delta_3 = +10$	lower surface 310
	f) C_p vs. X'	$\delta_2 = \delta_3 = +10$	lower surface 311
	g) C_p vs. Y'	$\delta_2 = \delta_3 = +10$	upper surface 312

Contrails

	b)	C_p vs. X'	$\delta_2 = \delta_3 = +10$	upper surface	312
	i)	C_p vs. Y'	$\delta_2 = \delta_3 = +20$	lower surface	
	j)	C_p vs. X'	$\delta_2 = \delta_3 = +20$	lower surface	313
	k)	C_p vs. Y'	$\delta_2 = \delta_3 = +20$	upper surface	
	l)	C_p vs. X'	$\delta_2 = \delta_3 = +20$	upper surface	314
	m)	C_p vs. Y'	$\delta_2 = \delta_3 = +30$	lower surface	315
	n)	C_p vs. X'	$\delta_2 = \delta_3 = +30$	lower surface	316
	o)	C_p vs. Y'	$\delta_2 = \delta_3 = +30$	upper surface	
	p)	C_p vs. X'	$\delta_2 = \delta_3 = +30$	upper surface	317
	q)	C_p vs. Y'	$\delta_2 = \delta_3 = +39$	lower surface	318
	r)	C_p vs. X'	$\delta_2 = \delta_3 = +39$	lower surface	319
	s)	C_p vs. Y'	$\delta_2 = \delta_3 = +39$	upper surface	
	t)	C_p vs. X'	$\delta_2 = \delta_3 = +39$	upper surface	320
38		Configuration IV	$\alpha = +40$		
	a)	C_p vs. Y'	$\delta_2 = \delta_3 = -20$	lower surface	321
	b)	C_p vs. X'	$\delta_2 = \delta_3 = -20$	lower surface	322
	c)	C_p vs. Y'	$\delta_2 = \delta_3 = -20$	upper surface	
	d)	C_p vs. X'	$\delta_2 = \delta_3 = -20$	upper surface	323
	e)	C_p vs. Y'	$\delta_2 = \delta_3 = -39$	lower surface	324
	f)	C_p vs. X'	$\delta_2 = \delta_3 = -39$	lower surface	325
	g)	C_p vs. Y'	$\delta_2 = \delta_3 = -39$	upper surface	
	h)	C_p vs. X'	$\delta_2 = \delta_3 = -39$	upper surface	326
39		Configuration IV	$\alpha = +50$		
	a)	C_p vs. Y'	$\delta_2 = \delta_3 = 0$	lower surface	327
	b)	C_p vs. X'	$\delta_2 = \delta_3 = 0$	lower surface	328
	c)	C_p vs. Y'	$\delta_2 = \delta_3 = 0$	upper surface	
	d)	C_p vs. X'	$\delta_2 = \delta_3 = 0$	upper surface	329
	e)	C_p vs. Y'	$\delta_2 = \delta_3 = +20$	lower surface	330
	f)	C_p vs. X'	$\delta_2 = \delta_3 = +20$	lower surface	331
	g)	C_p vs. Y'	$\delta_2 = \delta_3 = +20$	upper surface	
	h)	C_p vs. X'	$\delta_2 = \delta_3 = +20$	upper surface	332
	i)	C_p vs. Y'	$\delta_2 = \delta_3 = +39$	lower surface	333
	j)	C_p vs. X'	$\delta_2 = \delta_3 = +39$	lower surface	334
	k)	C_p vs. Y'	$\delta_2 = \delta_3 = +39$	upper surface	
	l)	C_p vs. X'	$\delta_2 = \delta_3 = +39$	upper surface	335
	m)	C_p vs. Y'	$\delta_2 = \delta_3 = -20$	lower surface	336
	n)	C_p vs. X'	$\delta_2 = \delta_3 = -20$	lower surface	337
	o)	C_p vs. Y'	$\delta_2 = \delta_3 = -20$	upper surface	338

Contrails

	p)	C_p vs. X'	$\delta_2 = \delta_3 = -20$	upper surface	338
	q)	C_p vs. Y'	$\delta_2 = \delta_3 = -39$	lower surface	339
	r)	C_p vs. X'	$\delta_2 = \delta_3 = -39$	lower surface	340
	s)	C_p vs. Y'	$\delta_2 = \delta_3 = -39$	upper surface	
	t)	C_p vs. X'	$\delta_2 = \delta_3 = -39$	upper surface	341
40		Configuration IV	$\alpha = -10$		
	a)	C_p vs. Y'	$\delta_2 = \delta_3 = 0$	lower surface	
	b)	C_p vs. Y'	$\delta_2 = \delta_3 = 0$	upper surface	
	c)	C_p vs. X'	$\delta_2 = \delta_3 = 0$	lower surface	
	d)	C_p vs. X'	$\delta_2 = \delta_3 = 0$	upper surface	342
	e)	C_p vs. Y'	$\delta_2 = \delta_3 = +10$	lower surface	
	f)	C_p vs. Y'	$\delta_2 = \delta_3 = +10$	upper surface	
	g)	C_p vs. X'	$\delta_2 = \delta_3 = +10$	lower surface	
	h)	C_p vs. X'	$\delta_2 = \delta_3 = +10$	upper surface	343
	i)	C_p vs. Y'	$\delta_2 = \delta_3 = +20$	lower surface	
	j)	C_p vs. Y'	$\delta_2 = \delta_3 = +20$	upper surface	
	k)	C_p vs. X'	$\delta_2 = \delta_3 = +20$	lower surface	
	l)	C_p vs. X'	$\delta_2 = \delta_3 = +20$	upper surface	344
	m)	C_p vs. Y'	$\delta_2 = \delta_3 = +30$	lower surface	
	n)	C_p vs. Y'	$\delta_2 = \delta_3 = +30$	upper surface	
	o)	C_p vs. X'	$\delta_2 = \delta_3 = +30$	lower surface	
	p)	C_p vs. X'	$\delta_2 = \delta_3 = +30$	upper surface	345
	q)	C_p vs. Y'	$\delta_2 = \delta_3 = +39$	lower surface	
	r)	C_p vs. X'	$\delta_2 = \delta_3 = +39$	lower surface	346
	s)	C_p vs. Y'	$\delta_2 = \delta_3 = +39$	upper surface	
	t)	C_p vs. X'	$\delta_2 = \delta_3 = +39$	upper surface	347
41		Configuration IV	$\alpha = -10$		
	a)	C_p vs. Y'	$\delta_2 = \delta_3 = -10$	lower surface	
	b)	C_p vs. X'	$\delta_2 = \delta_3 = -10$	lower surface	348
	c)	C_p vs. Y'	$\delta_2 = \delta_3 = -10$	upper surface	
	d)	C_p vs. X'	$\delta_2 = \delta_3 = -10$	upper surface	349
	e)	C_p vs. Y'	$\delta_2 = \delta_3 = -20$	lower surface	
	f)	C_p vs. X'	$\delta_2 = \delta_3 = -20$	lower surface	350
	g)	C_p vs. Y'	$\delta_2 = \delta_3 = -20$	upper surface	351
	h)	C_p vs. X'	$\delta_2 = \delta_3 = -20$	upper surface	352
	i)	C_p vs. Y'	$\delta_2 = \delta_3 = -30$	lower surface	
	j)	C_p vs. X'	$\delta_2 = \delta_3 = -30$	lower surface	353
	k)	C_p vs. Y'	$\delta_2 = \delta_3 = -30$	upper surface	354

Contrails

	1) C_p vs. X'	$\delta_2 = \delta_3 = -30$	upper surface	355
	m) C_p vs. Y'	$\delta_2 = \delta_3 = -39$	lower surface	
	n) C_p vs. X'	$\delta_2 = \delta_3 = -39$	lower surface	356
	o) C_p vs. Y'	$\delta_2 = \delta_3 = -39$	upper surface	357
	p) C_p vs. X'	$\delta_2 = \delta_3 = -39$	upper surface	358
42	Configuration IV $\alpha = -20$			
	a) C_p vs. Y'	$\delta_2 = \delta_3 = 0$	lower surface	
	b) C_p vs. X'	$\delta_2 = \delta_3 = 0$	lower surface	359
	c) C_p vs. Y'	$\delta_2 = \delta_3 = 0$	upper surface	
	d) C_p vs. X'	$\delta_2 = \delta_3 = 0$	upper surface	360
	e) C_p vs. Y'	$\delta_2 = \delta_3 = +10$	lower surface	
	f) C_p vs. Y'	$\delta_2 = \delta_3 = +10$	upper surface	
	g) C_p vs. X'	$\delta_2 = \delta_3 = +10$	lower surface	
	h) C_p vs. X'	$\delta_2 = \delta_3 = +10$	upper surface	361
	i) C_p vs. Y'	$\delta_2 = \delta_3 = +20$	lower surface	
	j) C_p vs. Y'	$\delta_2 = \delta_3 = +20$	upper surface	
	k) C_p vs. X'	$\delta_2 = \delta_3 = +20$	lower surface	
	l) C_p vs. X'	$\delta_2 = \delta_3 = +20$	upper surface	362
	m) C_p vs. Y'	$\delta_2 = \delta_3 = +30$	lower surface	
	n) C_p vs. Y'	$\delta_2 = \delta_3 = +30$	upper surface	
	o) C_p vs. X'	$\delta_2 = \delta_3 = +30$	lower surface	
	p) C_p vs. X'	$\delta_2 = \delta_3 = +30$	upper surface	363
	q) C_p vs. Y'	$\delta_2 = \delta_3 = +39$	lower surface	
	r) C_p vs. Y'	$\delta_2 = \delta_3 = +39$	upper surface	
	s) C_p vs. X'	$\delta_2 = \delta_3 = +39$	lower surface	
	t) C_p vs. X'	$\delta_2 = \delta_3 = +39$	upper surface	364
43	Configuration IV $\alpha = -20$			
	a) C_p vs. Y'	$\delta_2 = \delta_3 = -10$	lower surface	
	b) C_p vs. X'	$\delta_2 = \delta_3 = -10$	lower surface	365
	c) C_p vs. Y'	$\delta_2 = \delta_3 = -10$	upper surface	366
	d) C_p vs. X'	$\delta_2 = \delta_3 = -10$	upper surface	367
	e) C_p vs. Y'	$\delta_2 = \delta_3 = -20$	lower surface	
	f) C_p vs. X'	$\delta_2 = \delta_3 = -20$	lower surface	368
	g) C_p vs. Y'	$\delta_2 = \delta_3 = -20$	upper surface	369
	h) C_p vs. X'	$\delta_2 = \delta_3 = -20$	upper surface	370
	i) C_p vs. Y'	$\delta_2 = \delta_3 = -30$	lower surface	
	j) C_p vs. X'	$\delta_2 = \delta_3 = -30$	lower surface	371
	k) C_p vs. Y'	$\delta_2 = \delta_3 = -30$	upper surface	372
	l) C_p vs. X'	$\delta_2 = \delta_3 = -30$	upper surface	373

Contrails

	m)	C _p vs. Y'	$\delta_2 = \delta_3 = -39$	lower surface	374
	n)	C _p vs. X'	$\delta_2 = \delta_3 = -39$	lower surface	
	o)	C _p vs. Y'	$\delta_2 = \delta_3 = -39$	upper surface	375
	p)	C _p vs. X'	$\delta_2 = \delta_3 = -39$	upper surface	376
44	Configuration IV		$\alpha = -30$		
	a)	C _p vs. Y'	$\delta_2 = \delta_3 = 0$	lower surface	
	b)	C _p vs. X'	$\delta_2 = \delta_3 = 0$	lower surface	377
	c)	C _p vs. Y'	$\delta_2 = \delta_3 = 0$	upper surface	378
	d)	C _p vs. X'	$\delta_2 = \delta_3 = 0$	upper surface	379
	e)	C _p vs. Y'	$\delta_2 = \delta_3 = +20$	lower surface	
	f)	C _p vs. X'	$\delta_2 = \delta_3 = +20$	lower surface	380
	g)	C _p vs. Y'	$\delta_2 = \delta_3 = +20$	upper surface	
	h)	C _p vs. X'	$\delta_2 = \delta_3 = +20$	upper surface	381
	i)	C _p vs. Y'	$\delta_2 = \delta_3 = +39$	lower surface	
	j)	C _p vs. X'	$\delta_2 = \delta_3 = +39$	lower surface	382
	k)	C _p vs. Y'	$\delta_2 = \delta_3 = +39$	upper surface	
	l)	C _p vs. X'	$\delta_2 = \delta_3 = +39$	upper surface	383
45	Configuration IV		$\alpha = -30$		
	a)	C _p vs. Y'	$\delta_2 = \delta_3 = -10$	lower surface	
	b)	C _p vs. X'	$\delta_2 = \delta_3 = -10$	lower surface	384
	c)	C _p vs. Y'	$\delta_2 = \delta_3 = -10$	upper surface	385
	d)	C _p vs. X'	$\delta_2 = \delta_3 = -10$	upper surface	386
	e)	C _p vs. Y'	$\delta_2 = \delta_3 = -20$	lower surface	
	f)	C _p vs. X'	$\delta_2 = \delta_3 = -20$	lower surface	387
	g)	C _p vs. Y'	$\delta_2 = \delta_3 = -20$	upper surface	388
	h)	C _p vs. X'	$\delta_2 = \delta_3 = -20$	upper surface	389
	i)	C _p vs. Y'	$\delta_2 = \delta_3 = -30$	lower surface	
	j)	C _p vs. X'	$\delta_2 = \delta_3 = -30$	lower surface	390
	k)	C _p vs. Y'	$\delta_2 = \delta_3 = -30$	upper surface	391
	l)	C _p vs. X'	$\delta_2 = \delta_3 = -30$	upper surface	392
	m)	C _p vs. Y'	$\delta_2 = \delta_3 = -39$	lower surface	
	n)	C _p vs. X'	$\delta_2 = \delta_3 = -39$	lower surface	393
	o)	C _p vs. Y'	$\delta_2 = \delta_3 = -39$	upper surface	394
	p)	C _p vs. X'	$\delta_2 = \delta_3 = -39$	upper surface	395
46	Configuration IV		$\alpha = -40$		
	a)	C _p vs. Y'	$\delta_2 = \delta_3 = 0$	lower surface	
	b)	C _p vs. X'	$\delta_2 = \delta_3 = 0$	lower surface	396
	c)	C _p vs. Y'	$\delta_2 = \delta_3 = 0$	upper surface	397

Contrails

	d) C_p vs. X'	$\delta_2 = \delta_3 = 0$	upper surface	398
	e) C_p vs. Y'	$\delta_2 = \delta_3 = +20$	lower surface	
	f) C_p vs. X'	$\delta_2 = \delta_3 = +20$	lower surface	399
	g) C_p vs. Y'	$\delta_2 = \delta_3 = +20$	upper surface	400
	h) C_p vs. X'	$\delta_2 = \delta_3 = +20$	upper surface	401
	i) C_p vs. Y'	$\delta_2 = \delta_3 = +39$	lower surface	
	j) C_p vs. X'	$\delta_2 = \delta_3 = +39$	lower surface	402
	k) C_p vs. Y'	$\delta_2 = \delta_3 = +39$	upper surface	403
	l) C_p vs. X'	$\delta_2 = \delta_3 = +39$	upper surface	404
47	Configuration IV	$\alpha = -40$		
	a) C_p vs. Y'	$\delta_2 = \delta_3 = -10$	lower surface	
	b) C_p vs. X'	$\delta_2 = \delta_3 = -10$	lower surface	405
	c) C_p vs. Y'	$\delta_2 = \delta_3 = -10$	upper surface	406
	d) C_p vs. X'	$\delta_2 = \delta_3 = -10$	upper surface	407
	e) C_p vs. Y'	$\delta_2 = \delta_3 = -20$	lower surface	
	f) C_p vs. X'	$\delta_2 = \delta_3 = -20$	lower surface	408
	g) C_p vs. Y'	$\delta_2 = \delta_3 = -20$	upper surface	409
	h) C_p vs. X'	$\delta_2 = \delta_3 = -20$	upper surface	410
	i) C_p vs. Y'	$\delta_2 = \delta_3 = -30$	lower surface	
	j) C_p vs. X'	$\delta_2 = \delta_3 = -30$	lower surface	411
	k) C_p vs. Y'	$\delta_2 = \delta_3 = -30$	upper surface	412
	l) C_p vs. X'	$\delta_2 = \delta_3 = -30$	upper surface	413
	m) C_p vs. Y'	$\delta_2 = \delta_3 = -39$	lower surface	
	n) C_p vs. X'	$\delta_2 = \delta_3 = -39$	lower surface	414
	o) C_p vs. Y'	$\delta_2 = \delta_3 = -39$	upper surface	415
	p) C_p vs. X'	$\delta_2 = \delta_3 = -39$	upper surface	416
48	Configuration IV	$\alpha = -50$		
	a) C_p vs. Y'	$\delta_2 = \delta_3 = 0$	lower surface	
	b) C_p vs. X'	$\delta_2 = \delta_3 = 0$	lower surface	417
	c) C_p vs. Y'	$\delta_2 = \delta_3 = 0$	upper surface	418
	d) C_p vs. X'	$\delta_2 = \delta_3 = 0$	upper surface	419
	e) C_p vs. Y'	$\delta_2 = \delta_3 = +20$	lower surface	
	f) C_p vs. X'	$\delta_2 = \delta_3 = +20$	lower surface	420
	g) C_p vs. Y'	$\delta_2 = \delta_3 = +20$	upper surface	421
	h) C_p vs. X'	$\delta_2 = \delta_3 = +20$	upper surface	422
	i) C_p vs. Y'	$\delta_2 = \delta_3 = +39$	lower surface	
	j) C_p vs. X'	$\delta_2 = \delta_3 = +39$	lower surface	423
	k) C_p vs. Y'	$\delta_2 = \delta_3 = +39$	upper surface	424
	l) C_p vs. X'	$\delta_2 = \delta_3 = +39$	upper surface	425

Contrails

49	Configuration IV	$\alpha = -50$	
	a) C_p vs. Y'	$\delta_2 = \delta_3 = -10$	lower surface
	b) C_p vs. X'	$\delta_2 = \delta_3 = -10$	lower surface 426
	c) C_p vs. Y'	$\delta_2 = \delta_3 = -10$	upper surface 427
	d) C_p vs. X'	$\delta_2 = \delta_3 = -10$	upper surface 428
	e) C_p vs. Y'	$\delta_2 = \delta_3 = -20$	lower surface
	f) C_p vs. X'	$\delta_2 = \delta_3 = -20$	lower surface 429
	g) C_p vs. Y'	$\delta_2 = \delta_3 = -20$	upper surface 430
	h) C_p vs. X'	$\delta_2 = \delta_3 = -20$	upper surface 431
	i) C_p vs. Y'	$\delta_2 = \delta_3 = -30$	lower surface
	j) C_p vs. X'	$\delta_2 = \delta_3 = -30$	lower surface 432
	k) C_p vs. Y'	$\delta_2 = \delta_3 = -30$	upper surface 433
	l) C_p vs. X'	$\delta_2 = \delta_3 = -30$	upper surface 434
	m) C_p vs. Y'	$\delta_2 = \delta_3 = -39$	lower surface
	n) C_p vs. X'	$\delta_2 = \delta_3 = -39$	lower surface 435
	o) C_p vs. Y'	$\delta_2 = \delta_3 = -39$	upper surface 436
	p) C_p vs. X'	$\delta_2 = \delta_3 = -39$	upper surface 437
50	Configuration VII	Spoiler On	
	a) C_p vs. Y'	$\alpha = 0 \quad Re_x / ft \times 10^{-6} = 3.3$	lower surface
	b) C_p vs. X'	$\alpha = 0 \quad Re_x / ft \times 10^{-6} = 3.3$	lower surface 438
	c) C_p vs. Y'	$\alpha = 0 \quad Re_x / ft \times 10^{-6} = 3.3$	upper surface
	d) C_p vs. X'	$\alpha = 0 \quad Re_x / ft \times 10^{-6} = 3.3$	upper surface 439
	e) C_p vs. Y'	$\alpha = -10 \quad Re_x / ft \times 10^{-6} = 3.3$	lower surface
	f) C_p vs. X'	$\alpha = -10 \quad Re_x / ft \times 10^{-6} = 3.3$	lower surface 440
	g) C_p vs. Y'	$\alpha = -10 \quad Re_x / ft \times 10^{-6} = 3.3$	upper surface
	h) C_p vs. X'	$\alpha = -10 \quad Re_x / ft \times 10^{-6} = 3.3$	upper surface 441
	i) C_p vs. Y'	$\alpha = -20 \quad Re_x / ft \times 10^{-6} = 3.3$	lower surface
	j) C_p vs. X'	$\alpha = -20 \quad Re_x / ft \times 10^{-6} = 3.3$	lower surface 442
	k) C_p vs. Y'	$\alpha = -20 \quad Re_x / ft \times 10^{-6} = 3.3$	upper surface
	l) C_p vs. X'	$\alpha = -20 \quad Re_x / ft \times 10^{-6} = 3.3$	upper surface 443
	m) C_p vs. Y'	$\alpha = 0 \quad Re_x / ft \times 10^{-6} = 1.1$	lower surface
	n) C_p vs. X'	$\alpha = 0 \quad Re_x / ft \times 10^{-6} = 1.1$	lower surface 444
	o) C_p vs. Y'	$\alpha = 0 \quad Re_x / ft \times 10^{-6} = 1.1$	upper surface
	p) C_p vs. X'	$\alpha = 0 \quad Re_x / ft \times 10^{-6} = 1.1$	upper surface 445
51	Configuration VIII	Spoiler On, $Re_x / ft \times 10^{-6} = 3.3$	
	a) C_p vs. Y'	$\alpha = 0$	lower surface
	b) C_p vs. X'	$\alpha = 0$	lower surface 446
	c) C_p vs. Y'	$\alpha = 0$	upper surface

Contrails

d) C_p vs. X'	$\alpha = 0$	upper surface	447
e) C_p vs. Y'	$\alpha = -5$	lower surface	
f) C_p vs. X'	$\alpha = -5$	lower surface	448
g) C_p vs. Y'	$\alpha = -5$	upper surface	
h) C_p vs. X'	$\alpha = -5$	upper surface	449
i) C_p vs. Y'	$\alpha = -10$	lower surface	
j) C_p vs. X'	$\alpha = -10$	lower surface	450
k) C_p vs. Y'	$\alpha = -10$	upper surface	
l) C_p vs. X'	$\alpha = -10$	upper surface	451
m) C_p vs. Y'	$\alpha = -20$	lower surface	
n) C_p vs. X'	$\alpha = -20$	lower surface	452
o) C_p vs. X'	$\alpha = -20$	upper surface	
p) C_p vs. Y'	$\alpha = -20$	upper surface	453

LIST OF TABLES

		<u>Page</u>
I	Test Program	9
II	Geometric Characteristics of Models	11
III	Pressure Tap Location	13
IV	Description of Test Configurations	14

LIST OF SYMBOLS

b	Wing semi-span ~ inches
C_p	pressure coefficient = $\frac{P - P_\infty}{q_\infty}$
c_{root} (virtual)	virtual root chord of Wing ~ inches
M_∞	free stream Mach number
P	static pressure measured at pressure tap ~ psia
P_∞	free stream static pressure ~ psia
q_∞	free stream dynamic pressure = $\frac{\gamma}{2} P_\infty M_\infty^2 \sim \text{psia}$
Re_∞/ft	free stream unit Reynolds number = $\frac{\rho_\infty V_\infty}{\mu_\infty}$
V_∞	free stream velocity ~ ft/sec
x	chordwise distance measured from virtual apex of wing ~ inches
X'	non-dimensional chordwise coordinate = $\frac{x}{c_{\text{root}}}$ (measured from virtual apex of wing) (virtual)
y	spanwise distance measured from centerplane of model ~ inches
Y'	non-dimensional spanwise coordinate = $\frac{y}{b}$ (measured from vertical centerplane of model)
α	angle of attack ~ degrees

Contrails

γ	ratio of specific heats = 1.4
δ_2, δ_3	flap defection angles ~ degrees (δ_2 ~ left flap; δ_3 ~ right flap)
μ_∞	free stream viscosity ~ $\frac{\text{slugs}}{\text{ft sec}}$
ρ_∞	free stream density ~ $\frac{\text{slugs}}{\text{ft}^3}$

Contrails

INTRODUCTION

The Fluid Mechanics Section of the Grumman Research Department is currently engaged in a research program directed at determining flow separation phenomena and the effectiveness of aerodynamic controls on hypersonic flight vehicles. The program consists of theoretical and experimental research on "basic" configurations, flat plates with wedge-shaped flaps and fins, and "typical" hypersonic glide vehicles, a clipped delta wing-body combination, and a pyramidal body. The configurations under investigation in the over-all program are shown in Fig. 1a.

This report presents the results of one segment of the experimental program. It treats a winged hypersonic glider configuration consisting, in basic form, of a clipped delta wing with an overslung cone-cylinder body. This configuration was used for obtaining pressure and heat transfer data on various aerodynamic controls at hypersonic Mach numbers. The pressure data results are presented herein and the heat transfer results will be presented in a subsequent report (Ref. 1). The controls investigated were partial span trailing edge flaps, with deflection ranges of -39° to $+39^\circ$, a full span plug-type trailing edge spoiler and tip fins. An overslung hemisphere-cylinder body was also tested.

The experimental work was done at the AEDC 50-inch Mach 8 Hypersonic Wind Tunnel during July and August of 1963. Descriptions of these test facilities can be found in Ref. 2. Pressure data were obtained at a unit Reynolds number varying from 3.3×10^6 to 2.5×10^6 , depending on the angle of attack range, with selected points at a Reynolds number of 1.1×10^6 . The same model was used to obtain heat transfer data in the AEDC 50-inch Hypersonic Tunnel at $M_\infty = 8.0$ and pressure data in the AEDC 40" x 40" Supersonic Tunnel at $M = 5.0$ (Ref. 3). A geometrically similar model, instrumented to obtain force and moment data, was tested in both the 40" and 50" tunnels at an earlier date (Ref. 4). Another geometrically similar model, with limited pressure instrumentation, was tested in the AEDC Hotshot 2 Hypervelocity Tunnel (Ref. 5).

Manuscript released by the author May 1964 for publication as an RTD Technical Documentary Report.

Contrails

DESCRIPTION OF MODELS

Four test configurations were built up from a basic model that consisted of a clipped delta wing with an overslung body. The clipped delta wing had a spherically blunted apex, cylindrically blunted leading edges and a blunt base. Of the control surfaces to be tested, three partial span trailing edge flaps were built into the wing and attachments provided for mounting a full span spoiler. Only the outboard flaps were used in these tests. The flap-type control surfaces were remotely actuated from outside the tunnel. Three-view drawings of the four test configurations are presented in Fig. 1b through e. The dimensions of the basic configurations are shown in Fig. 1b and are the same for all other configurations. The other configuration drawings show dimensions only for the components added to the basic configuration. A summary of the geometric properties of the various model components is presented in Table 2.

The first major configuration consisted of a clipped delta wing with an overslung body. The body was composed of a half-cylindrical after-section and a half-hemispherical fore-section. A conical fairing, uninstrumented, was attached over the fore-section of the body to provide a body shape that was geometrically similar to that used in the force tests (Ref. 4). The half-conical foresection and half-cylindrical aftersection were joined together at the shoulder by a spherical fairing, this wing-body combination is referred to as Configuration I. The second major configuration was obtained by adding a set of tip fins to Configuration I and is referred to as Configuration IV. The tip fins were clipped deltas in elevation and were attached in such a way as not to alter the aspect ratio of the basic configuration. Configurations I and IV provided the pressure data needed to evaluate the force data previously obtained.

The conical forebody of the overslung body generates a weak shock wave on the upper surface. It was also desired to determine the effects of a strong shock generator on the pressure coefficients. With the conical forebody removed the basic, hemispherical-cylindrical overslung body remaining can be considered as a strong shock generator. It was also desired to compare the flow separation characteristics of the partial span trailing edge flaps with those of a trailing edge control that would be expected to induce strong separation effects. Thus, as for the force tests, it was decided to test a full span spoiler and compare the resulting pressure

Controls

distributions to those due to the partial span flaps deflected +20 degrees. The design condition for the full span, plug type, trailing edge spoiler was, therefore, that its height be equal to the vertical displacement of the trailing edge flaps when they are deflected +20 degrees. This spoiler was attached to the lower, flat plate surface at the trailing edge.

It was assumed that the effects of the blunt body and spoiler would be uncoupled because of their locations on opposite surfaces of the wing. Therefore, the hemispherical overslung body and the trailing edge spoiler were tested at the same time and referred to as Configuration VII.* Configuration VIII was obtained by adding the tip fins to Configuration VII.

The sign convention for denoting the angle of attack and the control deflection angle can be obtained from the basic model; namely, a flat plate clipped delta wing with an overslung body. This definition fixes the flat plate surface of the wing as the lower surface. Thus, the angle of attack is positive when the flat plate surface is the windward surface of the model. The control deflection angles are also defined with respect to the lower (flat-plate) surface of the model. If we consider our model at zero angle of attack (flow parallel to the lower flat-plate surface), then positive trailing edge flap deflections are obtained by deflecting the trailing edge down. The outboard partial span trailing edge flaps, designed to operate independently of each other, had a maximum travel angle of ± 40 degrees and could be calibrated to yield any deflection angle in this range.

Each flap-type control was driven by a 28 volt dc, gear reduced, electrical motor through a 1/2 inch-10 acme thread drive screw which was connected to the flap bell cranks by push-pull rods. Control deflection read-outs were obtained through calibrated linear potentiometers. The three motors with their attendant potentiometers and drive screws were located in a water-cooled housing immediately behind the model. The drive screws were connected to the flap bell cranks by push-pull rods that passed through the front of the actuator housing and into the base of the model. This type of actuation system produced a deflection rate of 1 degree/sec. The control surfaces were calibrated cold, that is, when the model was installed in the tunnel, and checked regularly. The calibrating was done with precut templates varying, in 5-degree increments, from 0 degrees to

*In the force tests a full span trailing edge flap and a full span spoiler were tested with the conical overslung body, with and without tip fins, and referred to as Configurations II, III, V, and VI.

Contrails

40 degrees. The potentiometer outputs were recorded visually from Leeds and Northrup Midget Model D indicators for use in setting flap angles during the test. This calibration was also recorded into the digital computing equipment at AEDC for use of the computer during the print-out procedure. The design provided for the independent operation of each control surface. We were thus capable of testing asymmetric, as well as symmetric, control configurations.

The wing of the model was fabricated of an internal stainless steel frame which served as the basic load supporting structure and instrumented surface panels which served as the data gathering units. The flaps were also fabricated the same way; i.e., an internal frame with attached, instrumented, panels. The flaps were connected to the wing structure by hinges and actuated from the actuator housing by a system of bell cranks and push-pull rods. All internal framework was made of 416 stainless steel and the surface panels were pressure relieved, silver braised honeycomb sections where the face sheets, core and frame were of 321 stainless steel. The body and the conical fairing were fabricated of 321 stainless steel sheet. The fins and spoiler were made of solid 321 stainless steel. The actuator housing which served as the connection between the model and the sting, as well as the housing for the actuation motors, was made of 17-4PH stainless steel.

The model was instrumented with 56 pressure taps distributed on the upper and lower surface of the wing and on the half-hemisphere cylinder body. The location of each pressure tap is listed in Table 3 and shown in Fig. 1f. When the conical forebody fairing was installed, seven pressure taps (178-184) were lost and when the spoiler was installed four pressure taps (28, 38, 48, 88) were lost. Installation of the fins did not block any instrumentation.

DESCRIPTION OF WIND TUNNELS AND EQUIPMENT

This segment of the over-all experimental program described in the Introduction was conducted in the 50 in. Mach 8 Hypersonic Wind Tunnel located at Arnold Engineering Development Center's von Karman Facility. A complete description of the wind tunnels and their associated measuring, recording, and tabulating equipment is given in Ref. 2.

Contrails

The angle of attack range was obtained by using two different pre-bend angles on the water-cooled split sting that is standard tunnel equipment. The two pre-bend angles used were 12 degrees and 39 degrees and between them provided an angle of attack range of 0 degrees to +50 degrees. The negative angles of attack were obtained by inverting the model.

TEST CONDITIONS

The test program was conducted at a nominal test section Mach number of 8.0 and test section unit Reynolds numbers ranging from 3.3×10^6 per foot to 1.1×10^6 per foot. Only selected data, to be used for comparative purposes, were obtained at the lowest unit Reynolds number. Most of the program was conducted at unit Reynolds numbers ranging from 3.3×10^6 per foot to 2.5×10^6 per foot. This variation in test section unit Reynolds number was caused by the necessity to reduce the free stream dynamic pressure in order to prevent overloading the control system. Thus the free stream unit Reynolds numbers and dynamic pressures were reduced as the magnitude of the angle of attack increased.

Due to tunnel operating conditions the actual test section Mach number ranged between 8.08 and 8.09. The nominal values of the free stream unit Reynolds number at which data were acquired were 3.3×10^6 , 2.9×10^6 , 2.5×10^6 , and 1.1×10^6 . The variation in Reynolds number, due to tunnel operating conditions, was $\pm 3\%$ maximum with most of the variations being within $\pm 2\%$ of the nominal values.

The two main configurations (I and IV) were tested most extensively while the tests on the other configurations were restricted and are used only to provide comparison data with the main configurations. Configurations I and IV were tested through an angle of attack range from -50 degrees to +50 degrees, for symmetric, partial span, flap deflections of -39 degrees to +39 degrees. Configurations VII and VIII were tested through an angle of attack range of -20 degrees to 0 degrees and provide information on the effect of a strong shock generator and plug type trailing edge spoiler on the pressure distributions and flow field about the delta wing.

A complete tabulation of the test program showing the angle of attack range, control deflection and flow conditions, is presented in Table 1.

DATA REDUCTION AND ACCURACY

All the pressure data were reduced to standard coefficient form using the equation $C_p = \frac{p - p_\infty}{q_\infty}$. The inaccuracy in the measured pressure data varied from ± 0.003 psia, for pressures below 0.40 psia, to 0.26 psia for pressures above 15 psia. Because of this, pressure coefficient uncertainties varied from 0.004 for $C_p < 0.3$ and $Re_\infty/ft = 1.1$ million to 0.13 for $C_p = 2.0$ and $Re_\infty/ft = 3.3$ million.

The automatic plotting machines, used in presenting the data herein, introduce additional errors. The discrepancies in the plotted pressure coefficients due to these machine errors should not exceed ± 0.01 . Nevertheless, there is always the possibility that a point will be completely misplotted. Each graph has been inspected and any questionable points were checked with the tabulated pressure coefficients.

RESULTS AND DISCUSSION

This portion of the over-all test program was designed to provide the pressure data needed to fully exploit the controls information previously obtained (Refs. 1 and 4) on a basic type of hypersonic flight vehicle and to assess the importance of separated flow effects. Data are presented at positive and negative angles of attack for the case of an overslung body mounted on a clipped delta wing.

The model was tested with tip fins on and off, with partial span trailing edge flaps, with a full span trailing edge spoiler, and with a blunt instrumented body as well as the conical body used in the force tests. The experiments were conducted at a nominal Mach number of 8 and with limited Reynolds number comparisons.

The basic wing-body combination was designed to provide pressure data for configurations having either overslung or underslung bodies. For convenience we have chosen the overslung body configuration as our reference, and we have defined the coordinate system and control deflection angles with reference to this basic configuration. Thus the positive angle of attack regime for the overslung body provides the aerodynamic data for the underslung

Contrails

body at negative angles of attack. The sign of the flap deflection angles, for the underslung body case, must be reversed in order that both cases be viewed in the same reference system.

The data are presented in the form of pressure coefficients plotted as functions of nondimensionalized chordwise (streamwise), and spanwise, coordinates. The chordwise coordinate is measured from the virtual apex of the model and the spanwise coordinate from the vertical centerplane of the model. The data obtained on the upper and lower surfaces of the test configuration are presented separately for each set. Thus, for each test configuration, all the data are presented in four graphs (two graphs for the chordwise plots and two graphs for the spanwise plots).

The data for Configuration I are presented in Figs. 3 to 28; for Configuration IV in Figs. 29 to 49; for Configuration VII in Fig. 50 and for Configuration VIII in Fig. 51. The complete test program is tabulated in Table 1 and the specific conditions presented in each figure are noted in the list of illustrations on page VIII.

REFERENCES

1. Meckler, Lawrence, Heat Transfer Measurements at Mach 8 on an Aerodynamically Controllable Winged Re-entry Configuration, to be published.
2. Arnold Center Test Facilities Handbook, AEDC, Arnold Air Force Station, Tennessee, January 1961.
3. Kaufman, Louis II, Pressure Measurements for Mach 5 Flows Over a Winged Re-entry Configuration with Aerodynamic Controls, Part I: Blunt Cabin, Part II: Conical Cabin, RTD-TDR-63-4179, February 1964.
4. Meckler, Lawrence, Static Aerodynamic Characteristics at Mach 5 and 8 of an Aerodynamically Controllable Winged Re-entry Configuration, FDL-TDR-64-10, to be published.
5. Hartofilis, Stavros A., Pressure Measurements at Mach 19 for a Winged Re-entry Configuration, ASD-TDR-63-319, March 1963.

Contrails

TABLE I
TEST PROGRAM
50" HYPERSONIC WIND TUNNEL
MACH 8.08

CONFIGURATION	TRAILING EDGE CONTROL		FOREBODY SHAPE	α RANGE ~ DEGREES	$Re_{\infty} / ft \times 10^{-6}$	
	PARTIAL SPAN FLAPS					SPOILER
	δ_2	δ_3				
I	0	0	OFF	CONICAL	-50 → +20 3.3	
					+30 → +50 2.5	
	+10	+10			-20 → +20 3.3	
					+30 → +50 2.5	
	+20	+20			-50 → -30 2.875	
					-20 → +20 3.3	
					+30 → +50 2.5	
	+30	+30			-50 → -30 2.875	
					-20 → +20 3.3	
					+30 → +40 2.5	
	+39	+39			-50 → -30 2.875	
					-20 → +20 3.3	
					+30 → +50 2.5	
	-10	-10			-50 → -30 2.875	
					-20 → +20 3.3	
	-20	-20			-50 → -30 2.875	
					-20 → +20 3.3	
					+30 → +50 2.5	
-30	-30			-50 → -30 2.875		
				-20 → +20 3.3		
-39	-39			-50 → -30 2.875		
				-20 → +20 3.3		
				+30 → +50 2.5		
IV	0	0	OFF	CONICAL	-50 → +20 3.3	
					+30 → +50 2.5	
	+10	+10			-20 → +20 3.3	
					+30 → +40 2.5	
	+20	+20			-50 → -30 2.875	
					-20 → +20 3.3	
					+30 → +50 2.5	
	+39	+39			-50 → -30 2.875	
					-20 → +20 3.3	
					+30 → +50 2.5	

Contrails

TABLE I (CONT'D)
TEST PROGRAM
50' HYPERSONIC WIND TUNNEL
MACH 8.08

CONFIGURATION	TRAILING EDGE CONTROL		FOREBODY SHAPE	α RANGE ~ DEGREES	$Re_{\infty}/ft \times 10^{-6}$	
	PARTIAL SPAN FLAPS					SPOILER
	δ_2	δ_3				
IV	-10	-10	OFF	-50 → -30	2.875	
				-20 → +20	3.3	
	-20	-20		-50 → -30	2.875	
				-20 → +20	3.3	
				+30 → +50	2.5	
	-30	-30		-50 → -30	2.875	
				-20 → +20	3.3	
				+30 → +50	2.5	
VII	0	0	ON	BLUNT	-20 → 0	3.3
					0	1.1
VIII	0	0	ON	BLUNT	-20 → 0	3.3

TABLE II

GEOMETRIC CHARACTERISTICS OF MODELS

Wing:Clipped Delta Wing with Blunt Apex,
Leading Edges, and Base

Root Chord	12.350 13.00	inches actual inches virtual
Tip Chord	2.608	inches
Span	12.00	inches
Apex Radius	0.650	inches
Leading Edge Sweep	60	degrees
Leading Edge Radius	0.650	inches
Wing Thickness (Constant)	1.30	inches
Planform Area	93.3 97.6	inches ² actual, inches ² virtual
Aspect Ratio	1.542	
Taper Ratio	0.211	
Thickness Ratio (Root)	0.1052	
Control Area - Partial Span Flaps	12.75	inches ²

Body:Half Cone - Cylinder
(Base Mounted Flush with Wing Trailing Edge)

Cone Angle	13	degrees
Cone Length	5.49	inches
Cone Radius (Maximum at Tangency Point)	1.269	inches
Cylinder Length	4.415	inches
Cylinder Radius	1.30	inches
Fairing (Cone to Cylinder)		
Length	0.292	inches
Radius	1.30	inches
Included Angle	13	degrees
Total Body Length (Half-Cone Cylinder)	10.20	inches
Planform Area (Half-Cone Cylinder)	17.81	inches ²
Hemisphere Radius	1.30	inches
Total Body Length (Half-Hemisphere Cylinder)	5.715	inches
Planform Area (Half-Hemisphere Cylinder)	14.145	inches ²

Tip Fin:

Clipped Delta Wing with Blunt Leading Edge

Root Chord	3.275	inches
------------	-------	--------

TABLE II
GEOMETRIC CHARACTERISTICS OF MODELS

Tip Chord	0.990	inches
Span	4.160	inches
Leading Edge Sweep	50	degrees
Leading Edge Radius	0.325	inches
Thickness (Constant)	0.650	inches
Area	9.27	inches ²
Aspect Ratio	1.862	
Taper Ratio	0.3025	
Thickness Ratio (Fin Root-Wing Center Plane)	0.199	

Spoiler:

Full Span, Plug Type with Cylindrical Lower Edge

Chord (Constant)	0.650	inches
Span	10.70	inches
Height	0.611	inches
Planform Area	6.96	inches ²
Bottom Cylinder Radius	0.325	inches

PRESSURE TAP LOCATION

TAP NUMBER	X'	Y'
78	0.050	0
79	0.10	↓
80	0.2596	↓
81	0.4038	↓
82	0.5481	↓
84	0.6923	↓
86	0.8077	0
87	0.9173	0.0313
88	0.9750	0.0313
42	0.5481	0.3125
43	0.6347	↓
44	0.6923	↓
45	0.7500	↓
46	0.8077	↓
47	0.9173	↓
48	0.9750	0.3125
31	0.4423	0.5625
32	0.5481	↓
33	0.6347	↓
34	0.6923	↓
35	0.7500	↓
36	0.8077	↓
37	0.9173	↓
38	0.9750	0.5625
26	0.8077	0.8020
27	0.9173	↓
28	0.9750	0.8020

TAP NUMBER	X'	Y'
177	0.1000	0
178	0.2654	↓
179	0.3346	↓
180	0.4038	↓
181	0.4731	↓
182	0.5481	↓
183	0.5851	↓
184	0.6274	0
164	0.6923	0.1083
166	0.7846	0.1083
167	0.9173	0.1083
154	0.6923	0.1877
156	0.7846	0.1877
157	0.9173	0.1877
141	0.4904	0.3125
142	0.5481	0.4375
143	0.6058	0.3125
146	0.7846	↓
147	0.9173	↓
148	0.9750	0.3125
131	0.4423	0.5625
132	0.5481	↓
134	0.6923	↓
136	0.7846	↓
137	0.9173	↓
138	0.9750	0.5625
126	0.7846	0.8020
127	0.9173	0.8020
128	0.9750	0.8020

All pressure taps are located with respect to the virtual apex, and the vertical center plane, of the model. Pressure taps 26 → 88 are on the lower (flat-plate) surface and taps 126 → 184 are on the upper surface of the model.

TABLE IV

DESCRIPTION OF TEST CONFIGURATIONS

CONFIGURATION	DESCRIPTION
I	<p>Basic Configuration (Wing-Body)</p> <p>Wing - Clipped delta wing, spherically blunted apex, cylindrically blunted leading edges, blunt base</p> <p>+ Body - Overslung, half conical forebody and half-cylindrical afterbody</p>
IV	<p>Basic + Tip Fins</p> <p>(I)</p>
VII	<p>Wing - Clipped delta wing, spherically blunted apex, cylindrically blunted leading edges, blunt base</p> <p>+ Body - Overslung, half-hemispherical forebody and half-cylindrical afterbody</p> <p>+ Spoiler - Plug type, trailing edge spoiler</p>
VIII	<p>VII + Tip Fins</p>

Contrails

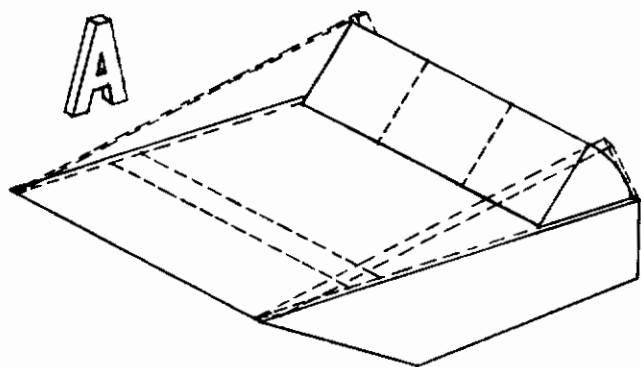

Separated Flows ahead of a Ramp
Fore and aft flaps, end plates
3 separate models:

- 1) Pressure and heat transfer, AEDC Tunnels A & B, $M = 5$ & 8
- 2) Controlled wall temperature, pressure, AEDC Tunnel B, $M = 8$
- 3) Pressure and heat transfer, Grumman Shock Tunnel, $M \approx 13$ & 19

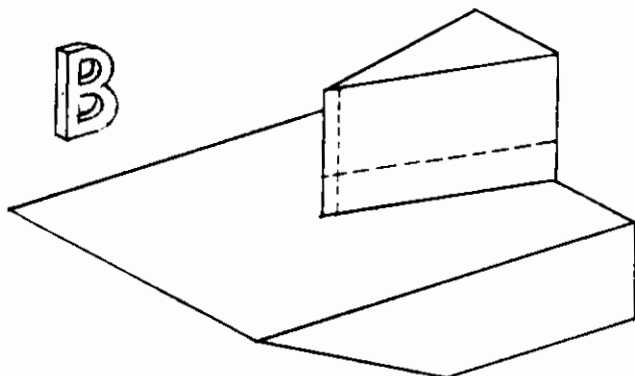

Wedge - Plate Interaction
Small and large fins with sharp and blunt leading edges
2 separate models:

- 1) Pressure and heat transfer, AEDC Tunnels A & B, $M = 5$ & 8
- 2) Pressure and heat transfer, Grumman Shock Tunnel, $M \approx 13$ & 19

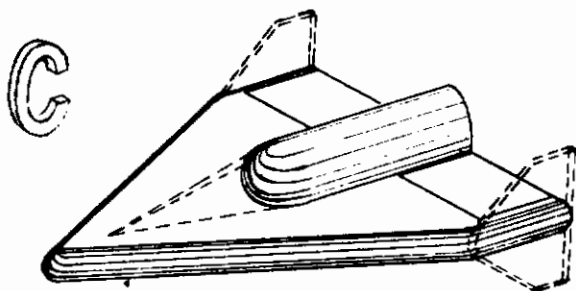

Clipped Delta, Blunt L.E.
Center body, T.E. flaps, drooped nose, spoiler, tip fins
3 separate models:

- 1) Pressure and heat transfer, AEDC Tunnels A & B, $M = 5$ & 8
- 2) Pressure, AEDC Hotshot 2, $M \approx 19$
- 3) Six component force, AEDC Tunnels A & B, $M = 5$ & 8

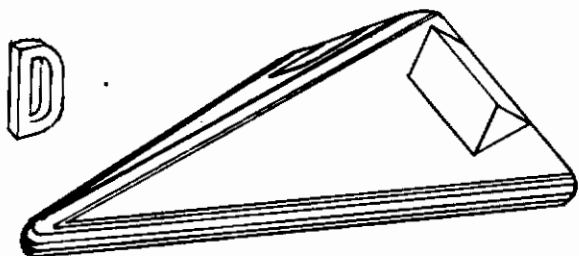

Delta, Blunt L.E., Dihedral
T.E. flaps, canard, ventral fin
3 separate models:

- 1) Pressure and heat transfer, AEDC Tunnels A & B, $M = 5$ & 8
- 2) Pressure and heat transfer, Grumman Shock Tunnel, $M \approx 19$
- 3) Six component force, AEDC Tunnels A & B, $M = 5$ & 8

Fig. 1a General Outline of Models and Remarks for Over-all Program

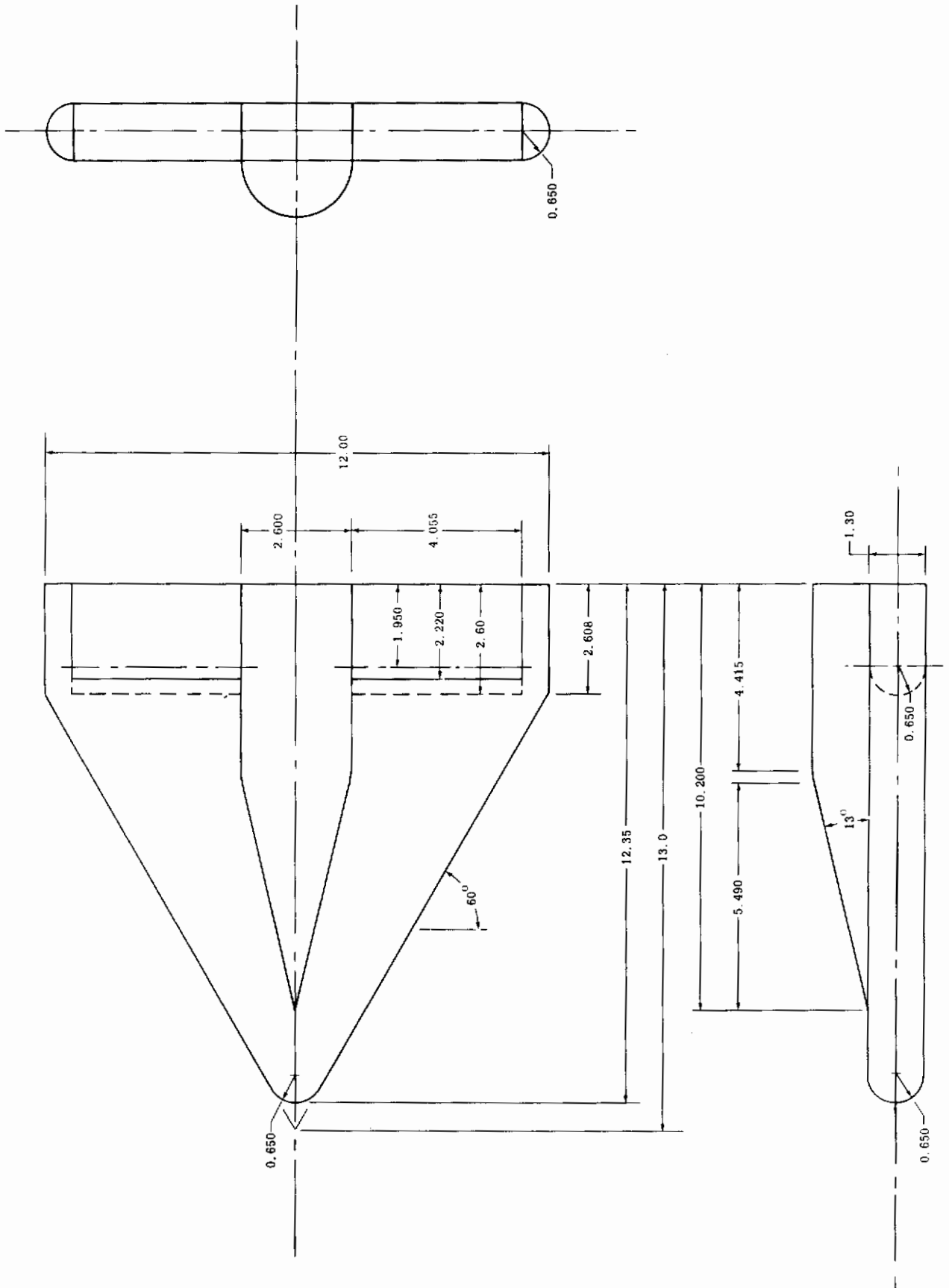

Fig. 1b Configuration I - Basic Wing-Body

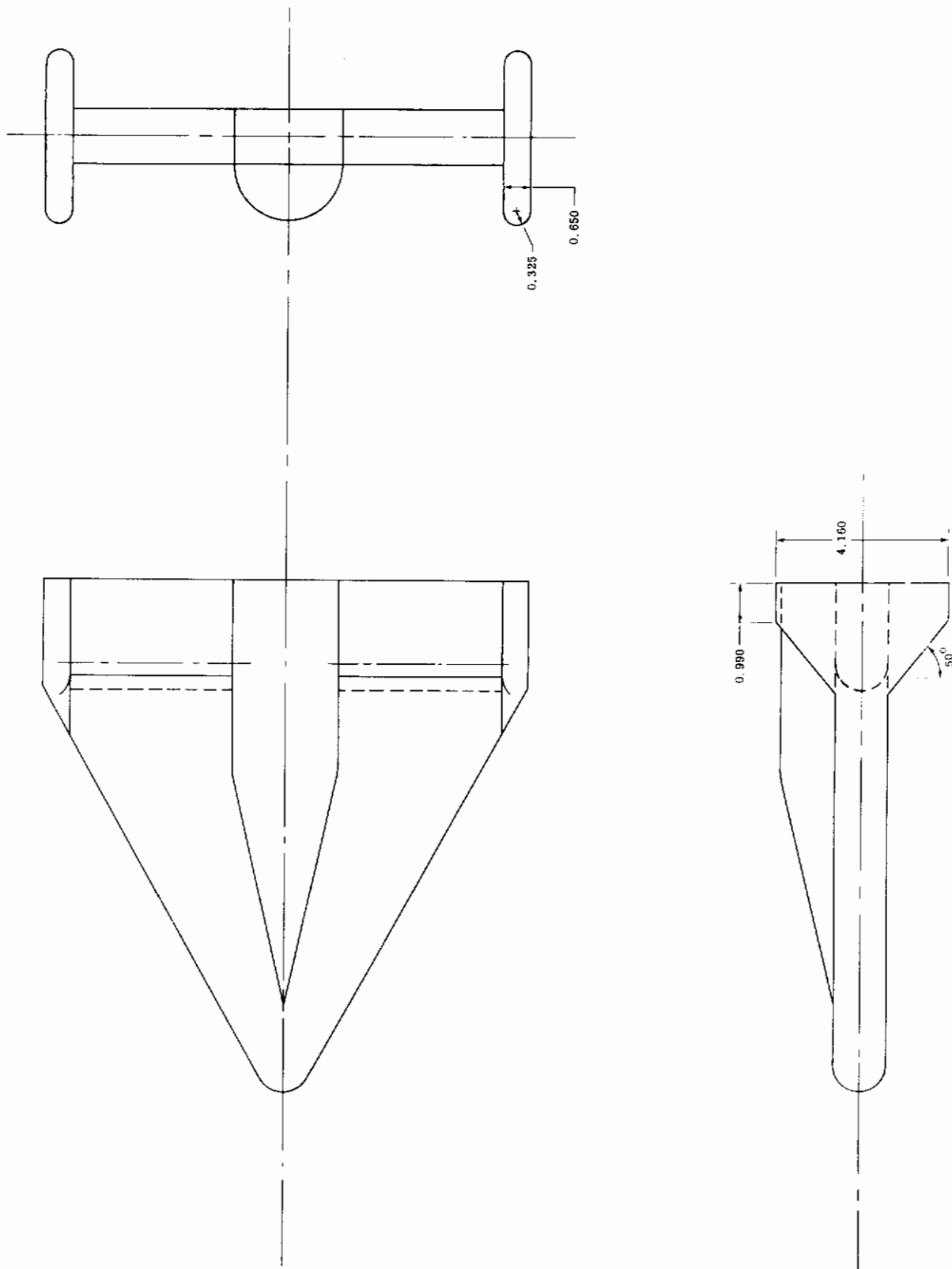

Fig. 1c Configuration IV - Basic Wing-Body + Tip Fins
(for dimensions see Figure 1b)

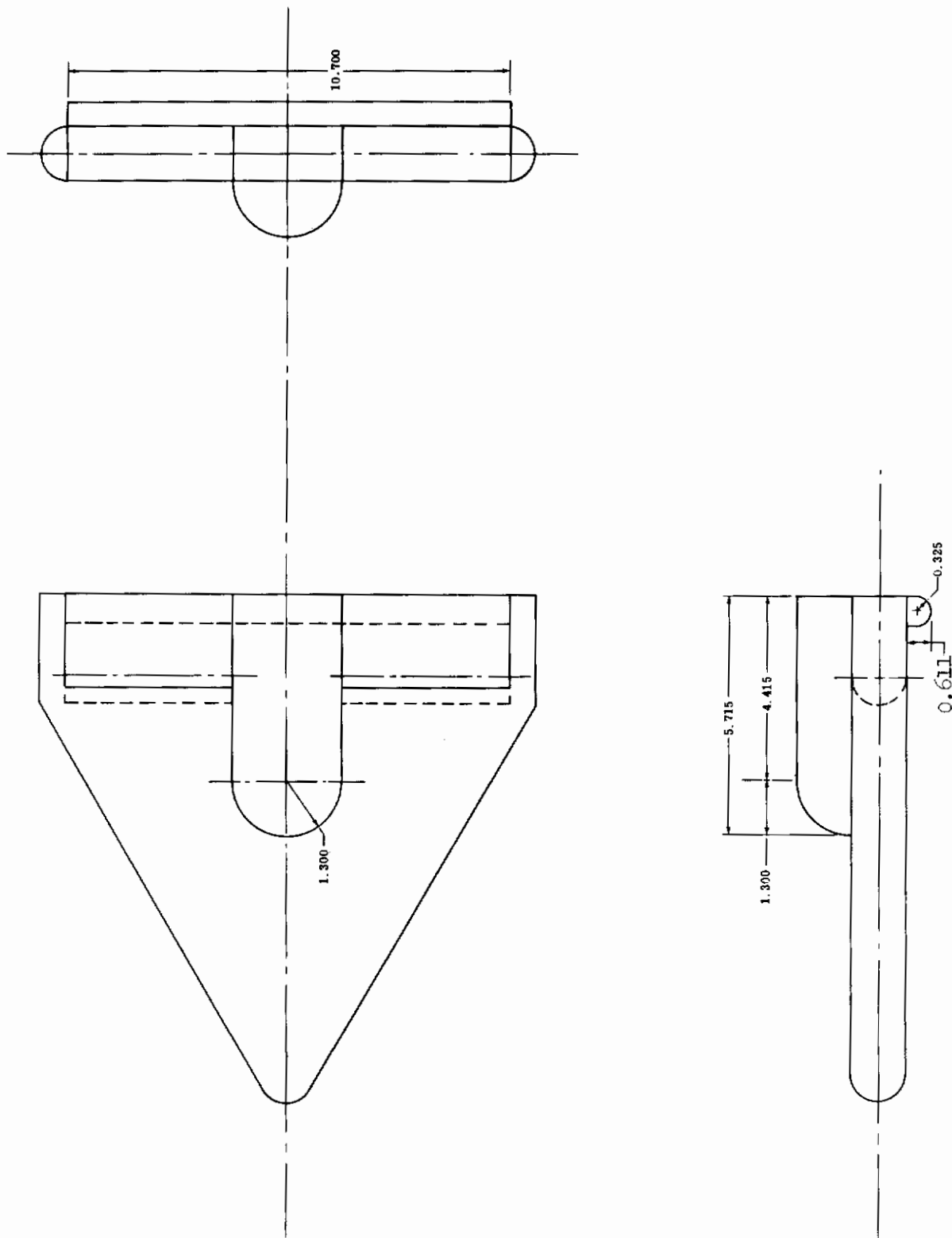

Fig. 1d Configuration VII - Wing - Blunt Body + Full Span Plug Spoiler
(for dimensions see Figure 1b)

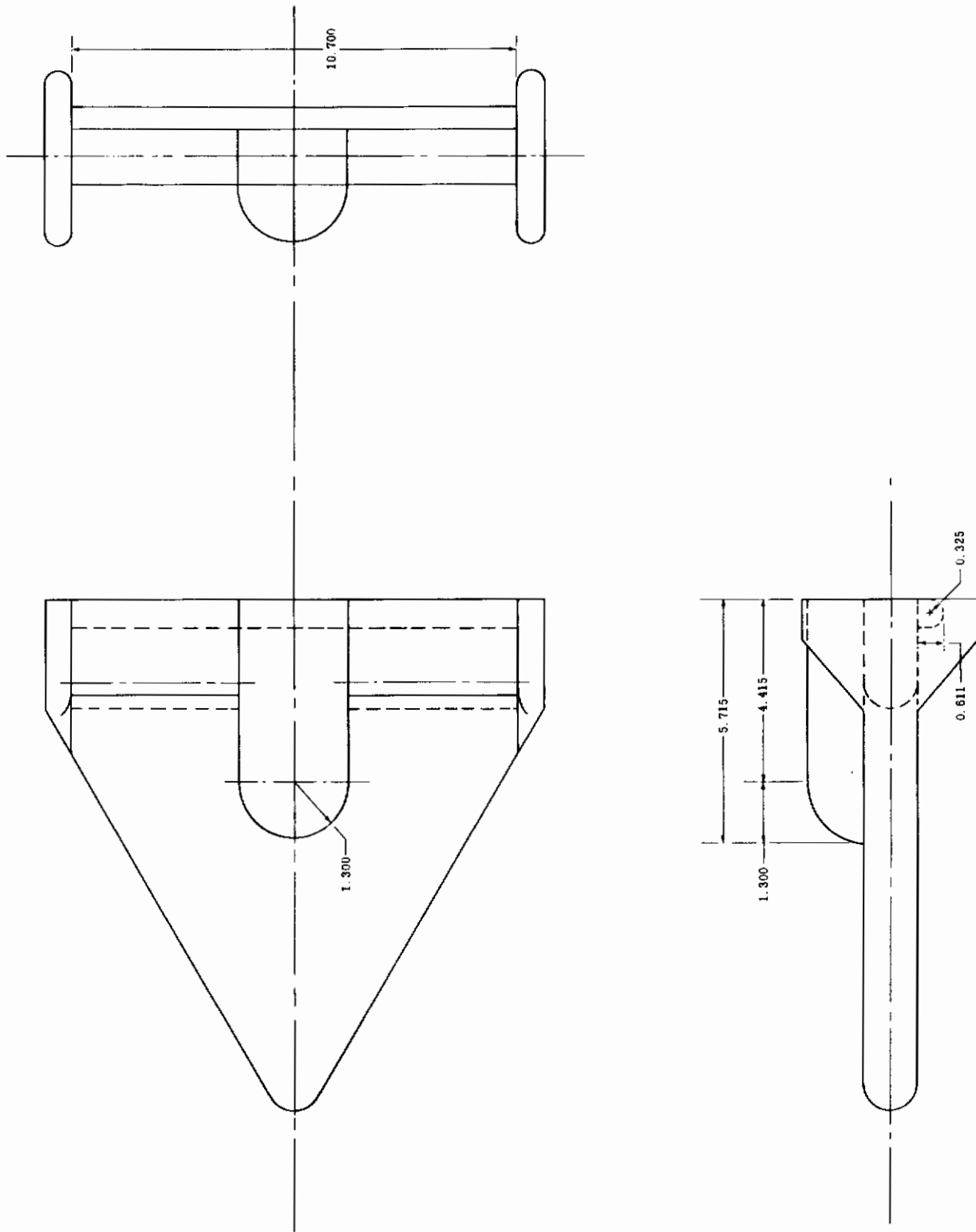

Fig. 1e Configuration VIII - Wing - Blunt Body + Full Span Plug Spoiler + Tip Fins
(for dimensions see Figures 1b, 1c, 1d)

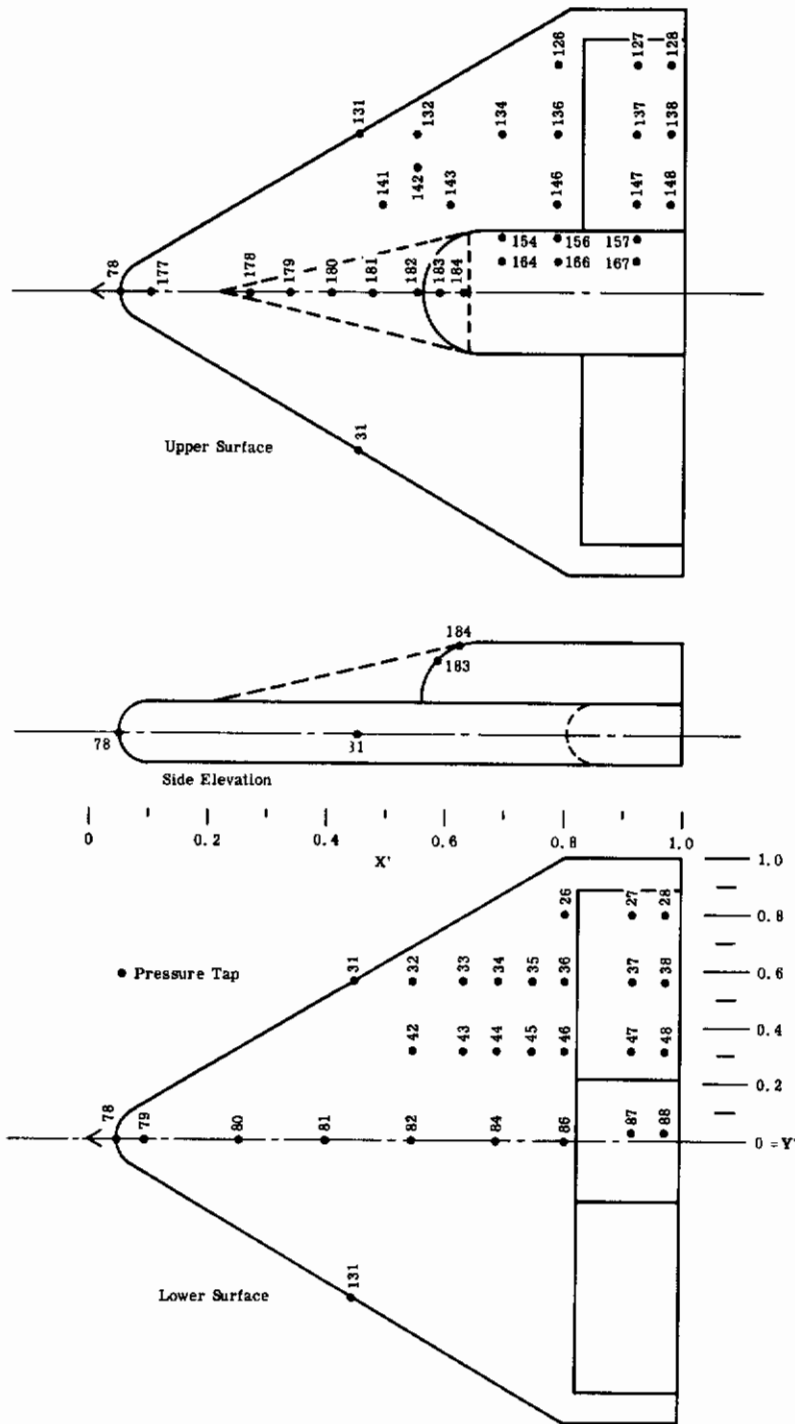

Fig. 1f Pressure Tap Location and Model Coordinate System

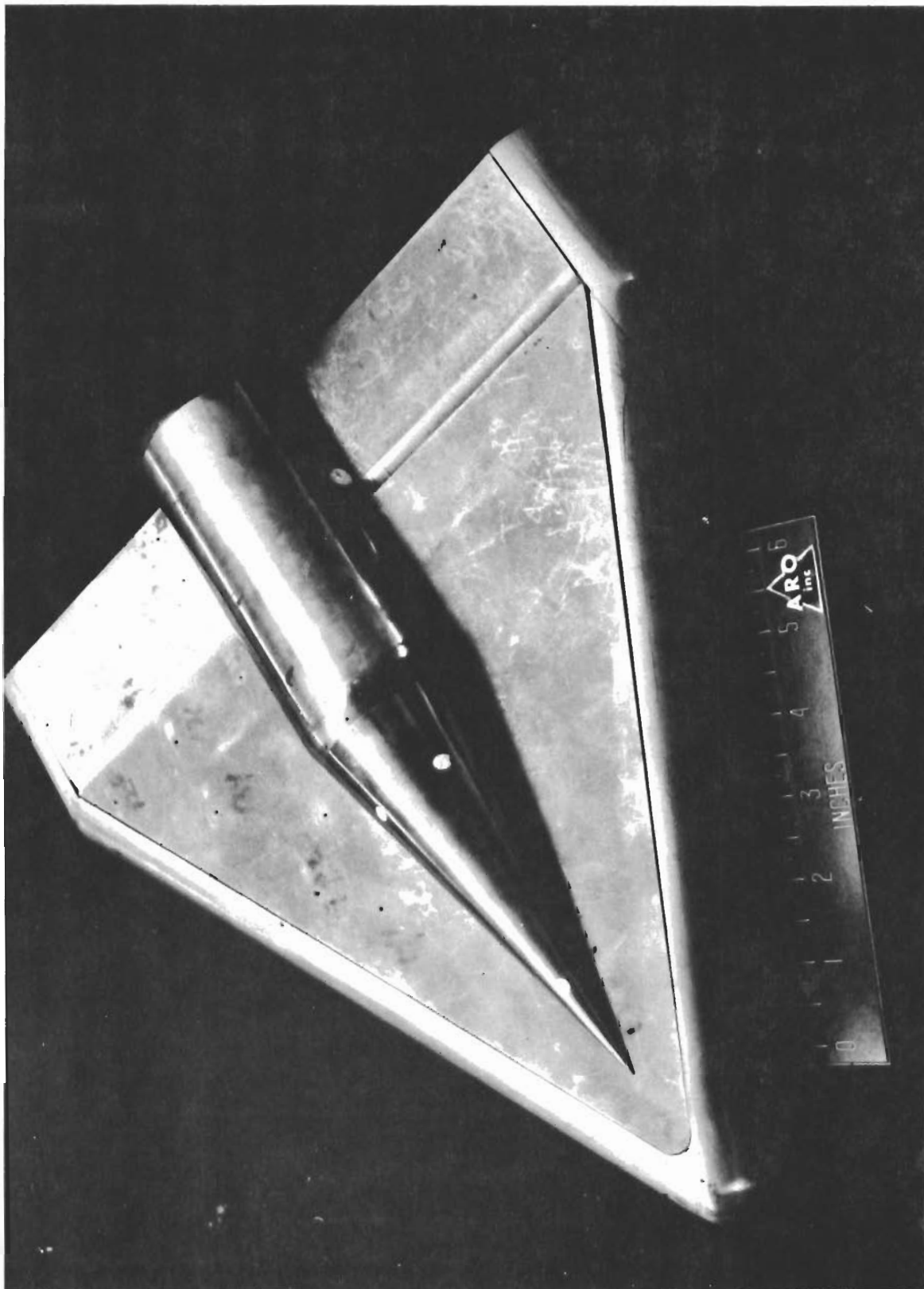

Figure 1g Top View Photograph - Configuration I

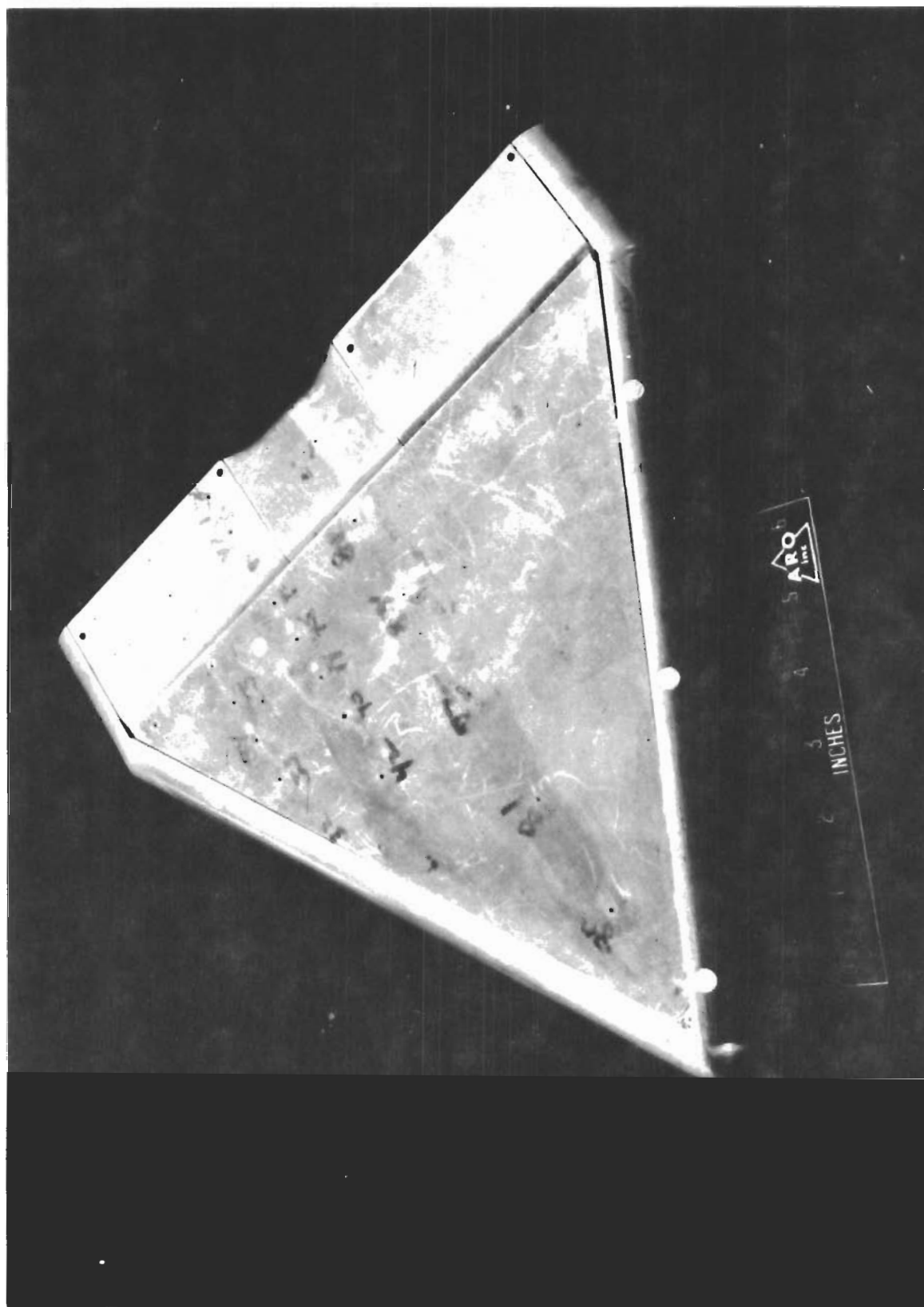

Figure 1h Bottom View Photograph - Configuration I

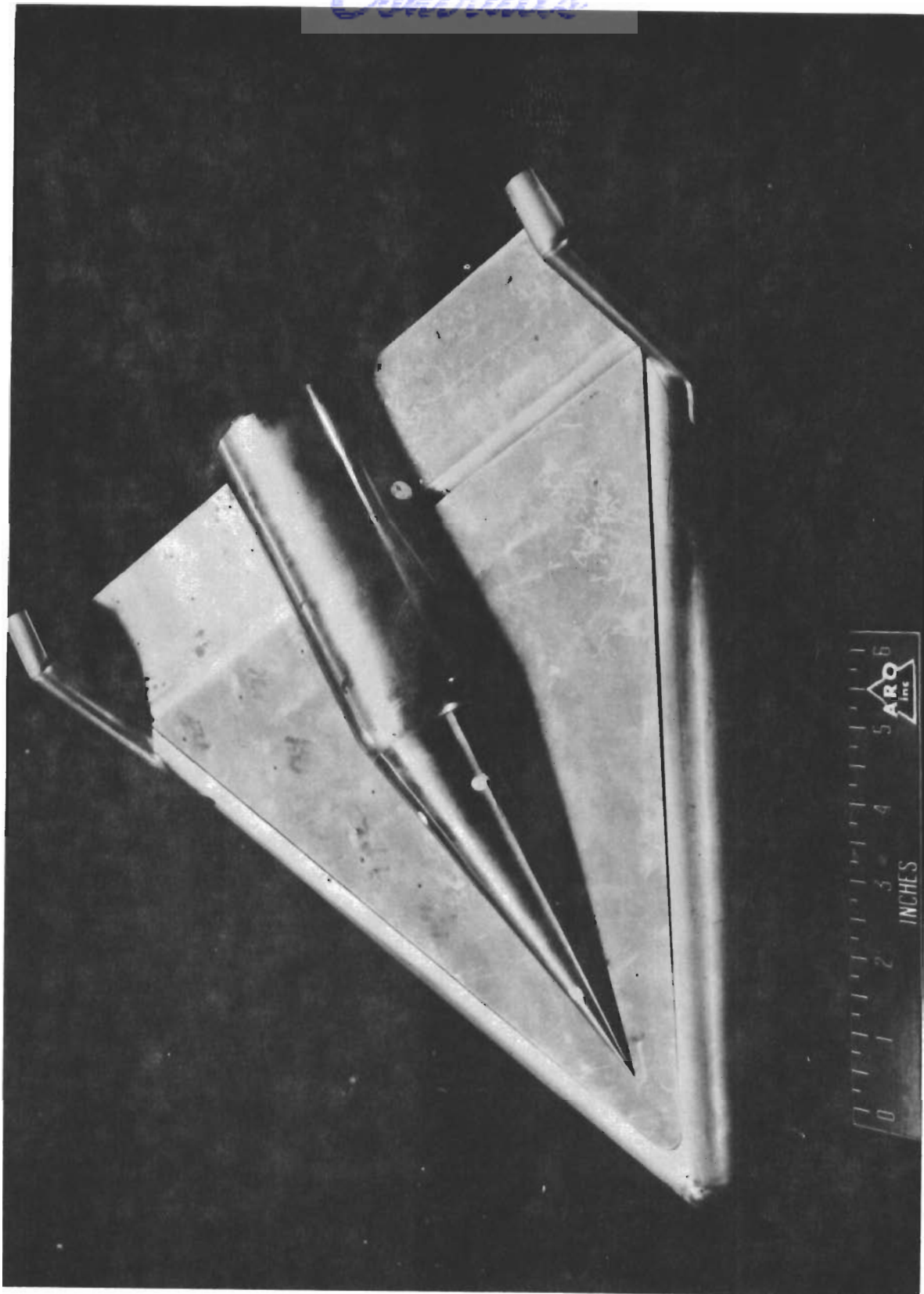

Figure 11 Top View Photograph - Configuration IV

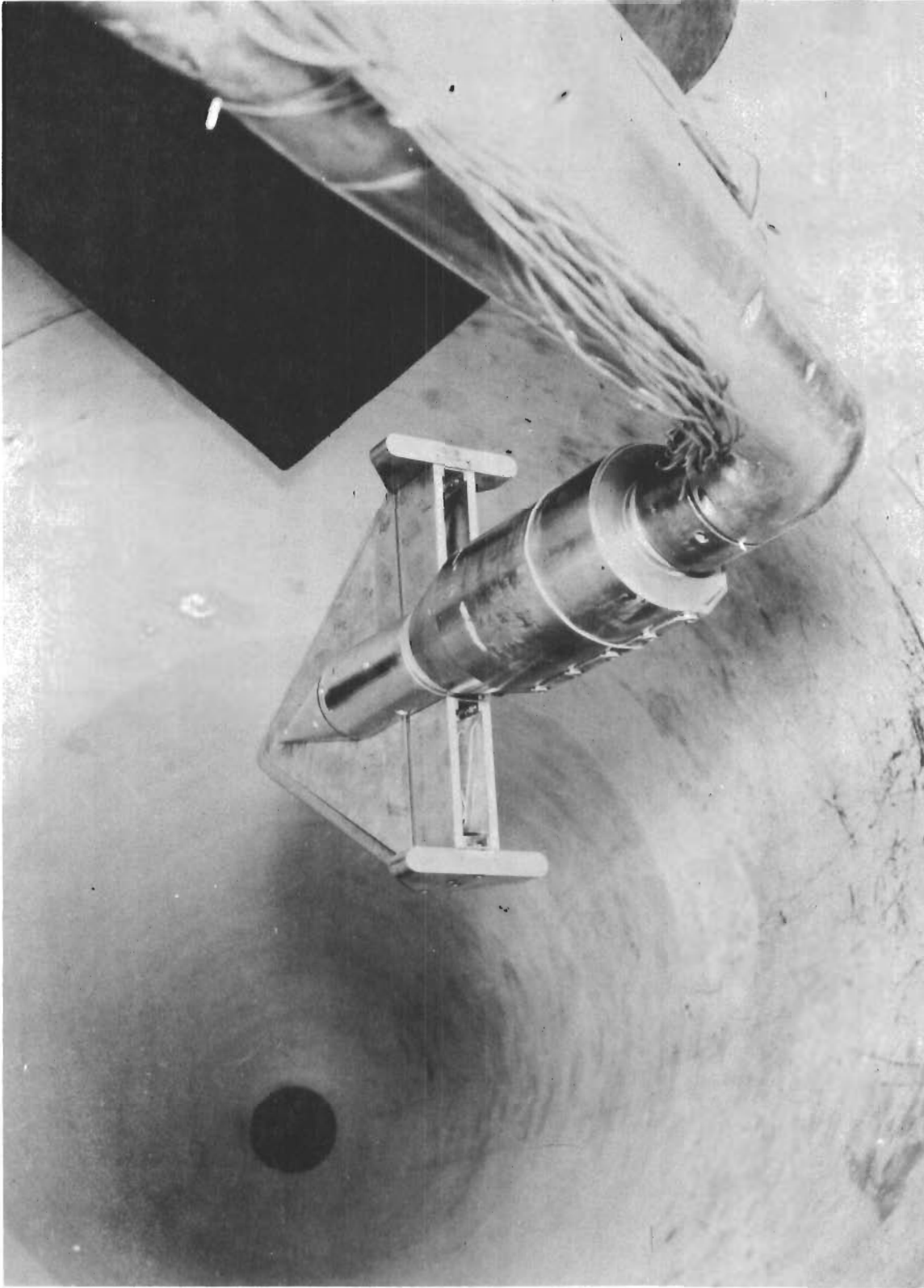

Figure 1j Photograph - Configuration IV, Mounted on Actuator Housing
in the 50" Hypersonic Mach 8 Wind Tunnel



Figure 1k Photograph - Actuator Housing Components
(1) Actuator Housing Cover, (2) Actuator Assembly,
(3) Water Jacket, (4) Actuator Housing

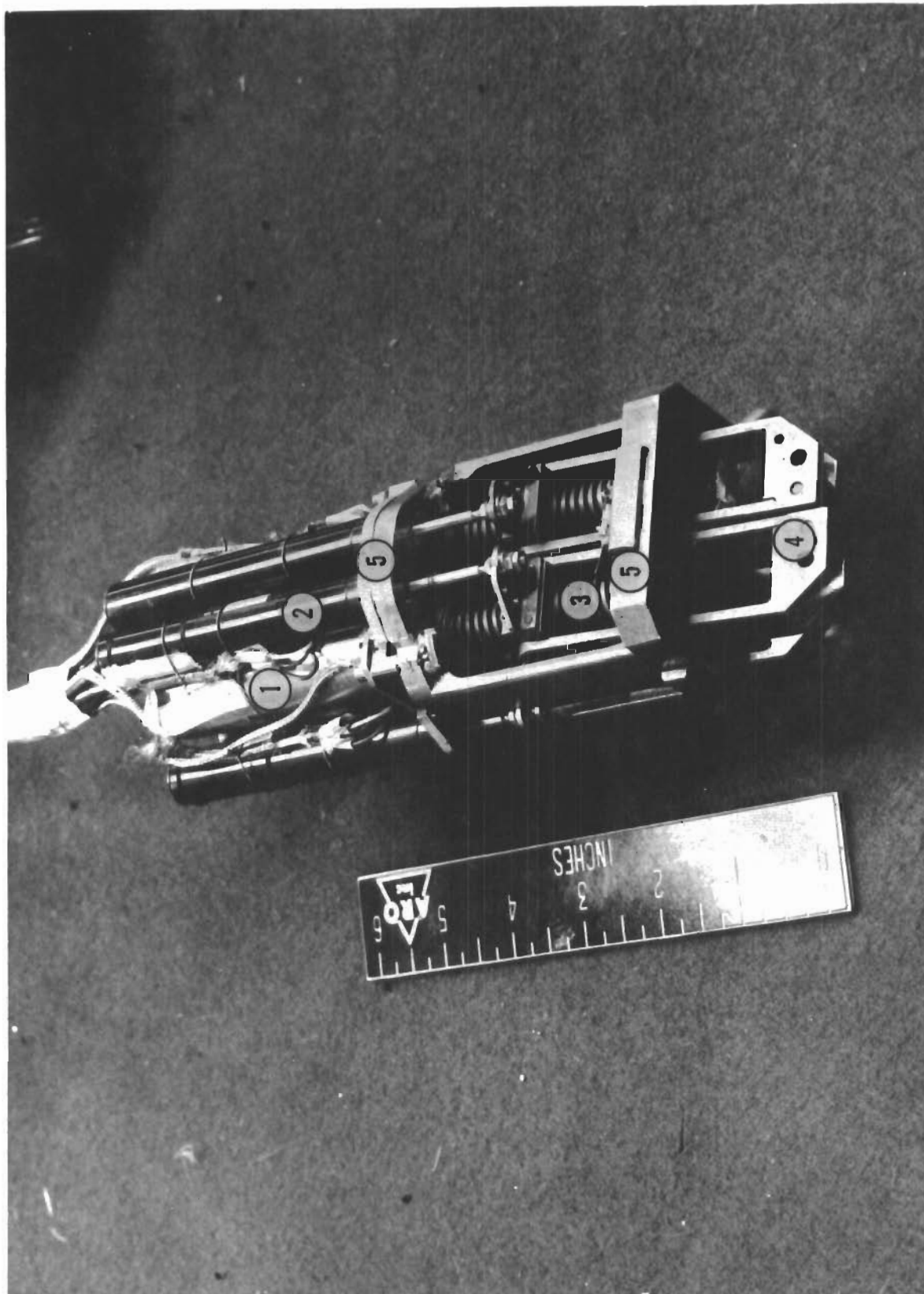

Figure 12 Photograph - Actuator Assembly
(1) Electric Motors, (2) Potentiometers,
(3) Lead Screws, (4) Control Rods
(5) Water Cooled Bulkheads

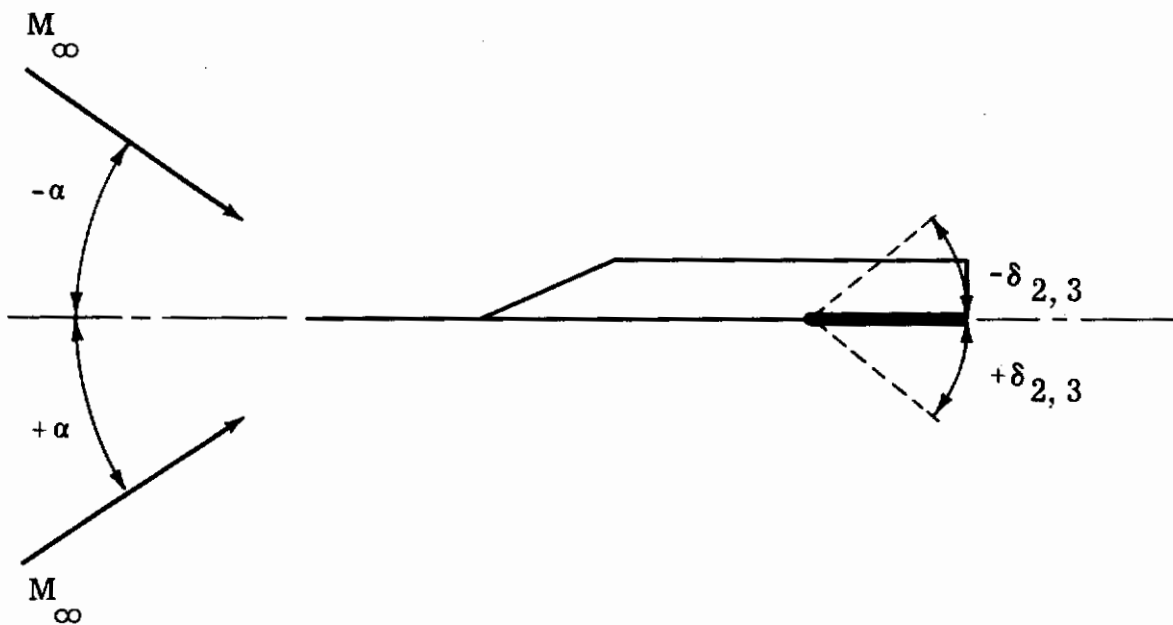

Fig. 2 Sign Convention for Model Angles and Control Deflection Angles

Contrails

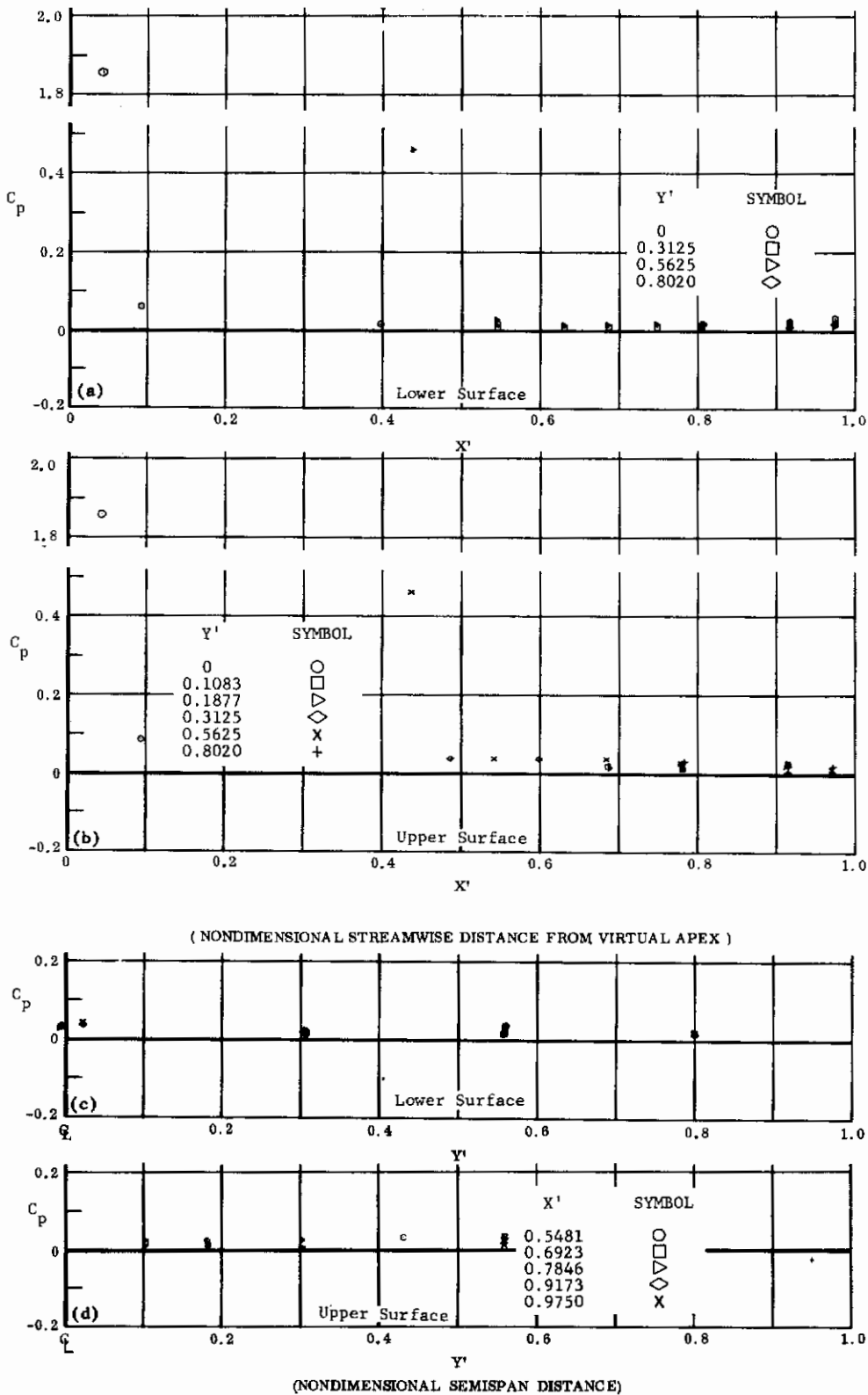

Fig. 3 Configuration I, $\alpha = 0$, $\delta_2 = \delta_3 = 0$

- a) C_p vs. X' , lower surface
- b) C_p vs. X' , upper surface
- c) C_p vs. Y' , lower surface
- d) C_p vs. Y' , upper surface

Contrails

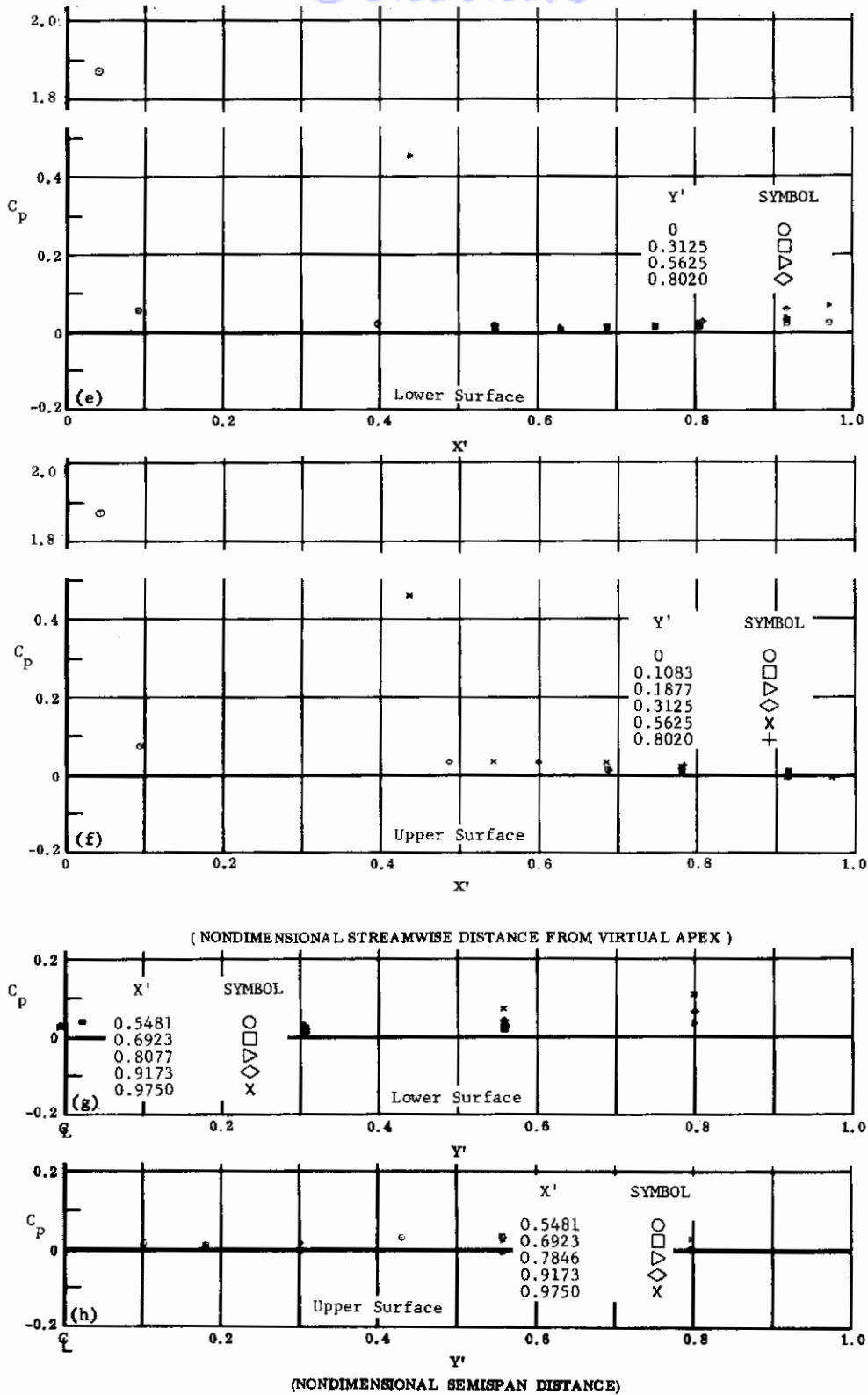
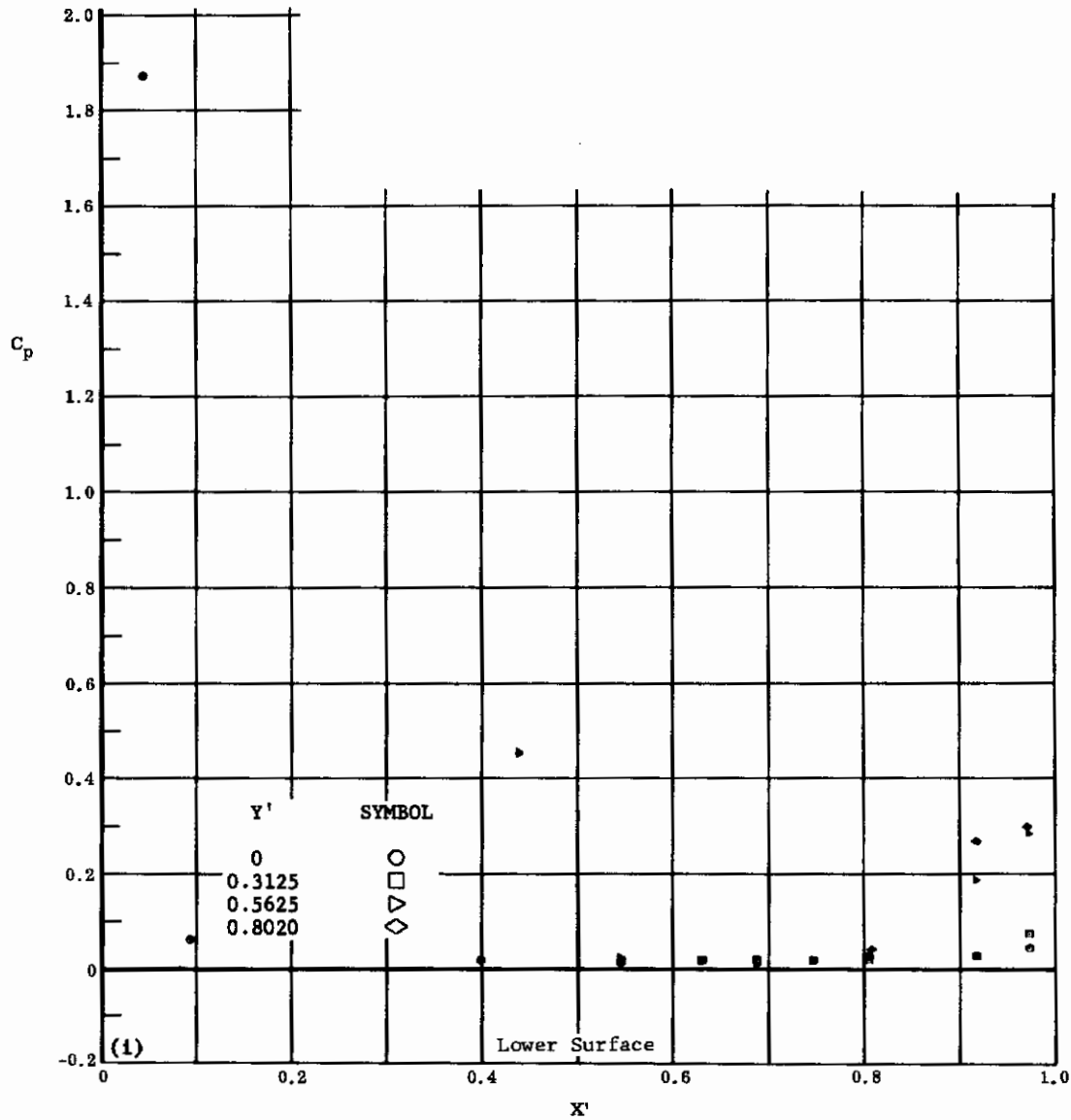

Fig. 3 Configuration I, $\alpha = 0$, $\delta_2 = \delta_3 = +10$

- e) C_p vs. X' , lower surface
- f) C_p vs. X' , upper surface
- g) C_p vs. Y' , lower surface
- h) C_p vs. Y' , upper surface

Contrails



(NONDIMENSIONAL STREAMWISE DISTANCE FROM VIRTUAL APEX)

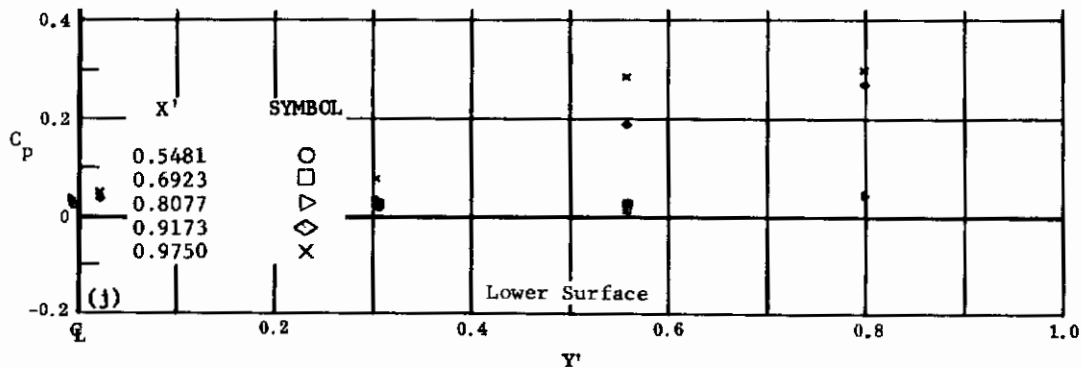

(NONDIMENSIONAL SEMISPAN DISTANCE)

Fig. 3 Configuration I, $\alpha = 0$, $\delta_2 = \delta_3 = +20$

- i) C_p vs. X' , lower surface
- j) C_p vs. Y' , lower surface

Contrails

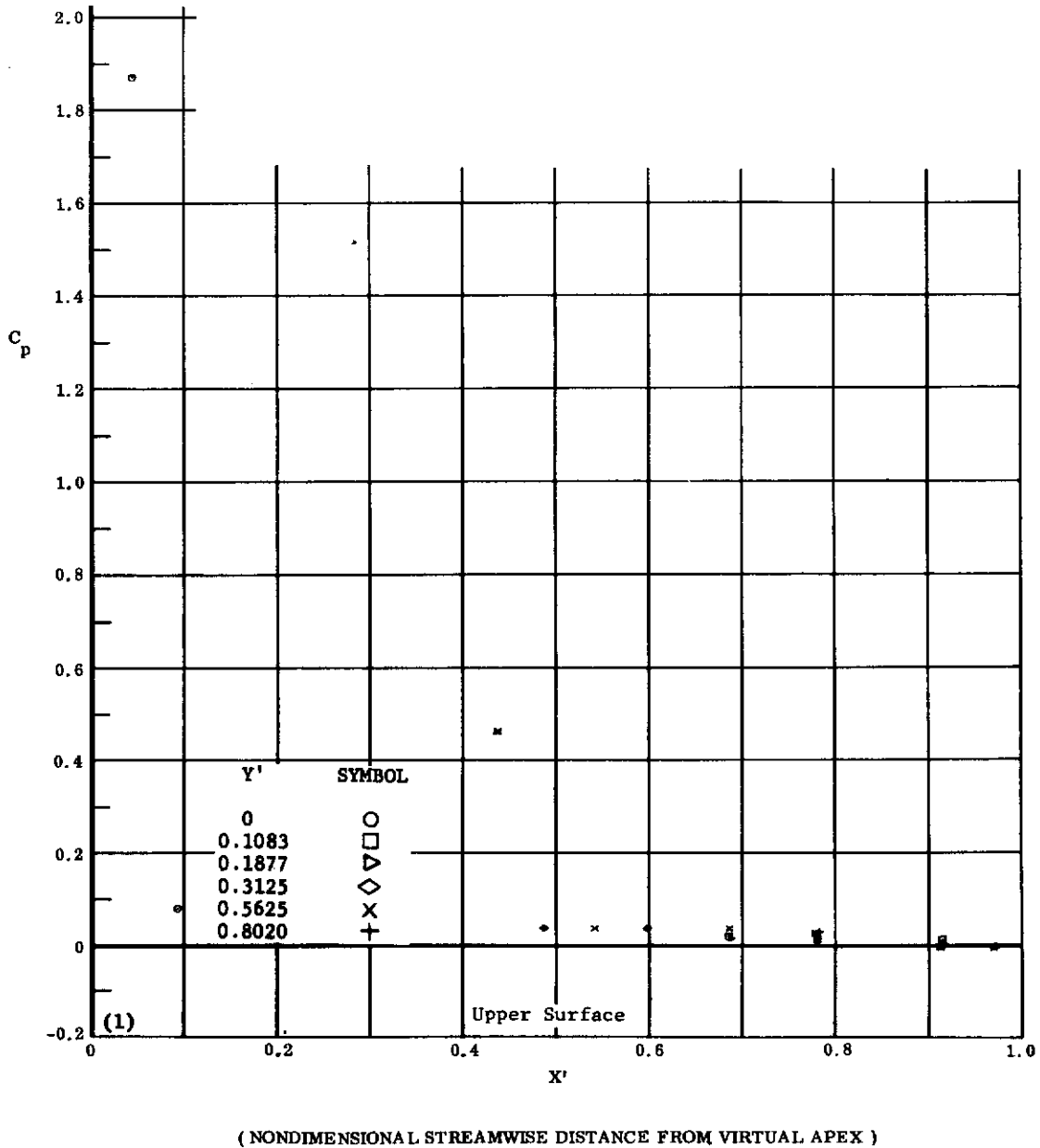
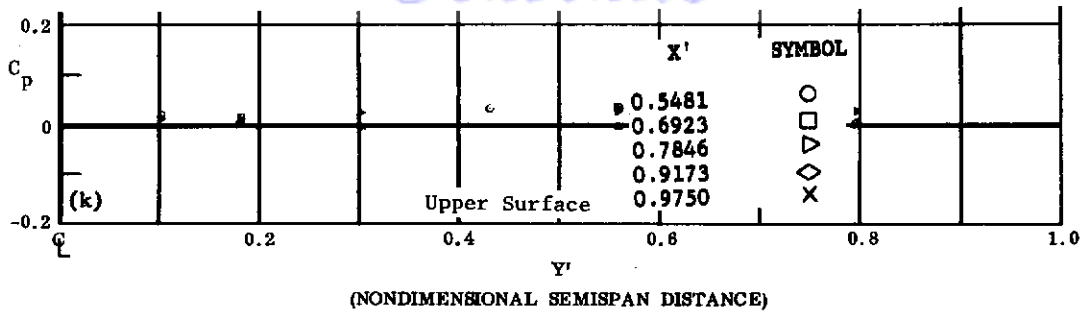
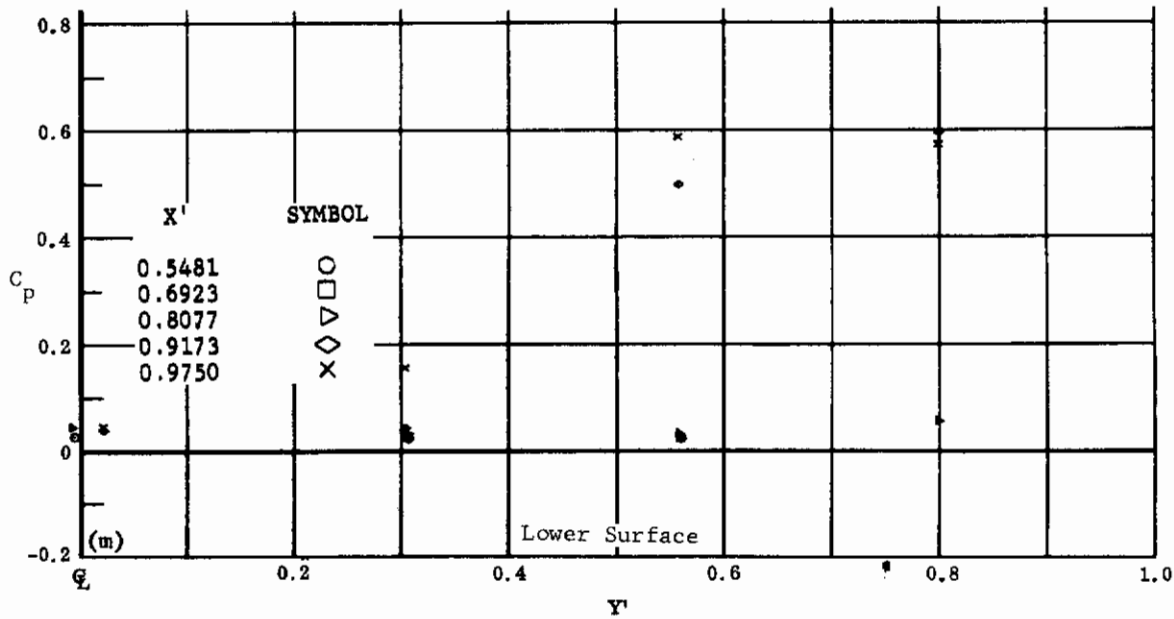

Fig. 3 Configuration I, $\alpha = 0$, $\delta_2 = \delta_3 = +20$

k) C_p vs. Y' , upper surface

l) C_p vs. X' , upper surface

Contrails



(NONDIMENSIONAL SEMISPAN DISTANCE)

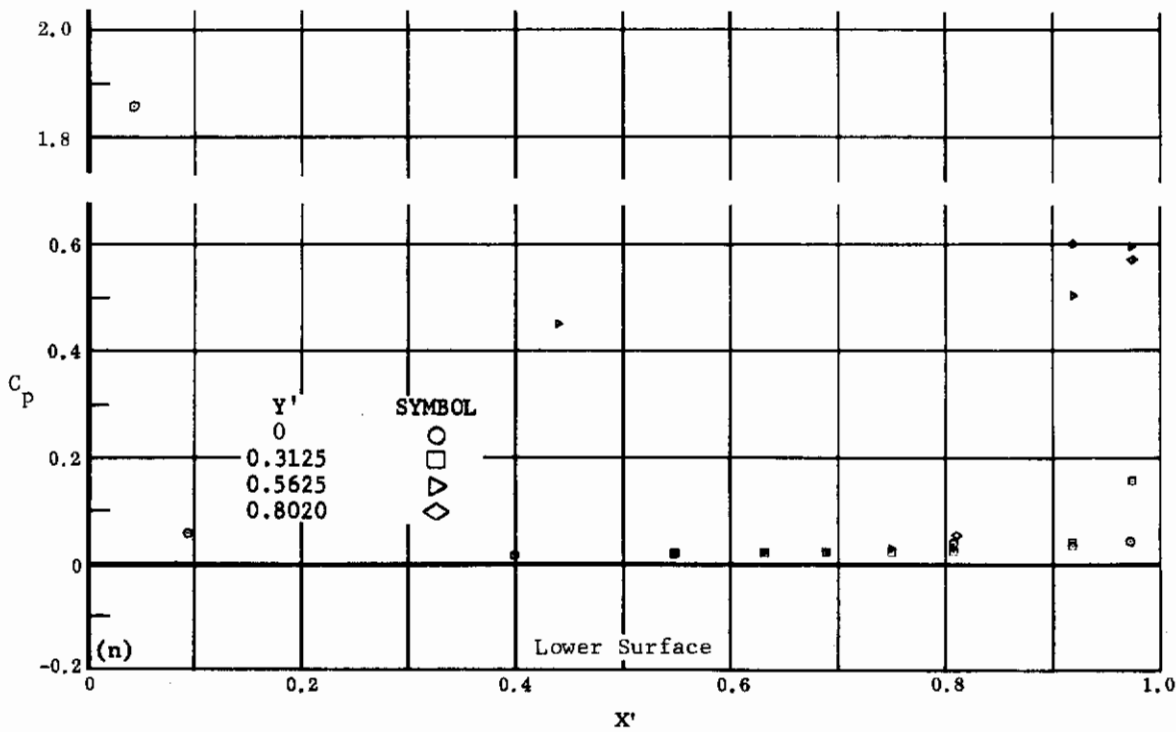

(NONDIMENSIONAL STREAMWISE DISTANCE FROM VIRTUAL APEX)

Fig. 3 Configuration I, $\alpha = 0$, $\delta_2 = \delta_3 = +30$

m) C_p vs. Y' , lower surface

n) C_p vs. X' , lower surface

Contrails

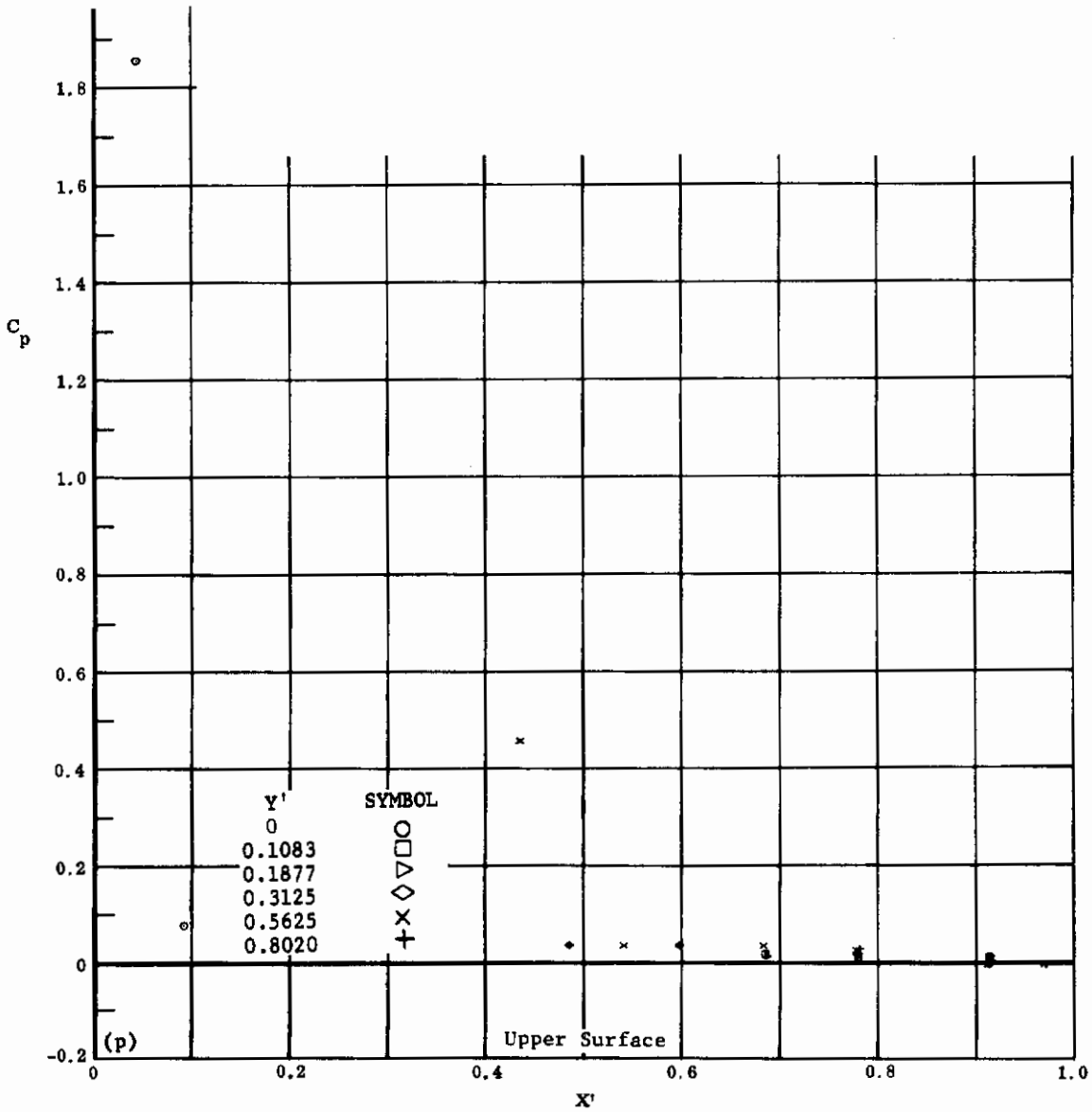
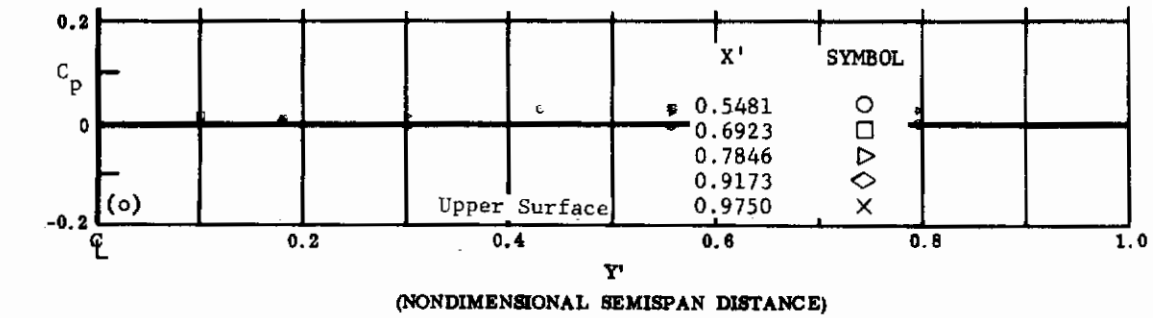
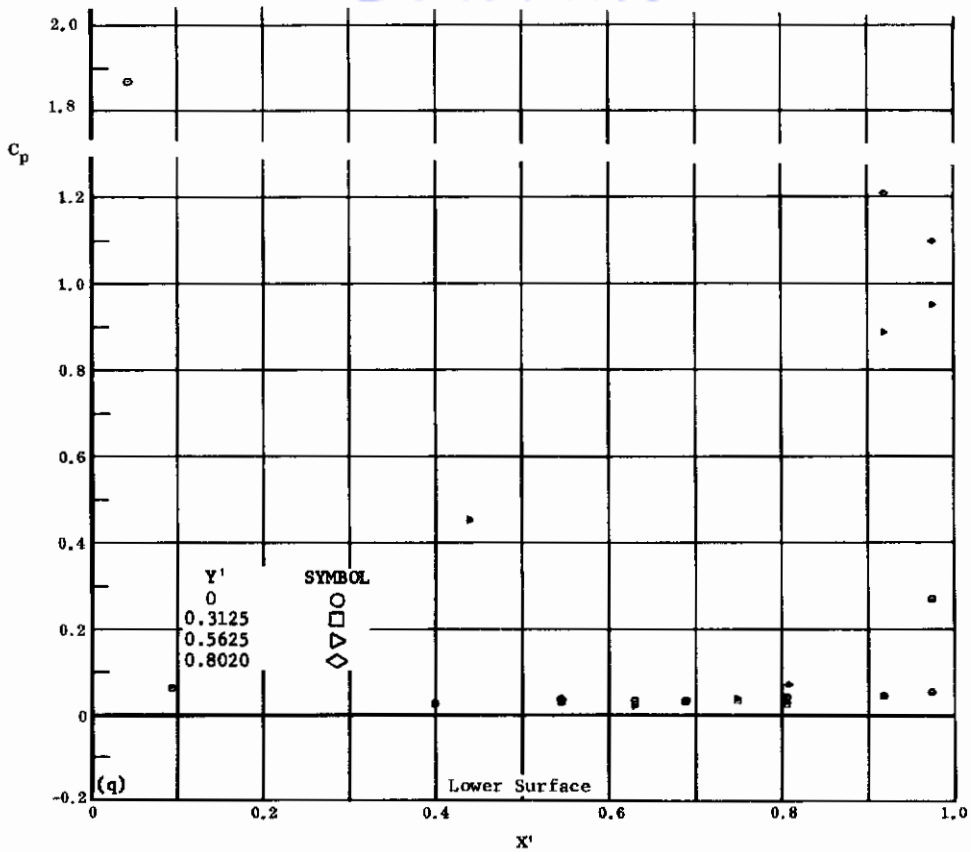

Fig. 3 Configuration I, $\alpha = 0$, $\delta_2 = \delta_3 = +30$

o) C_p vs. Y' , upper surface

p) C_p vs. X' , upper surface

Contrails



(NONDIMENSIONAL STREAMWISE DISTANCE FROM VIRTUAL APEX)

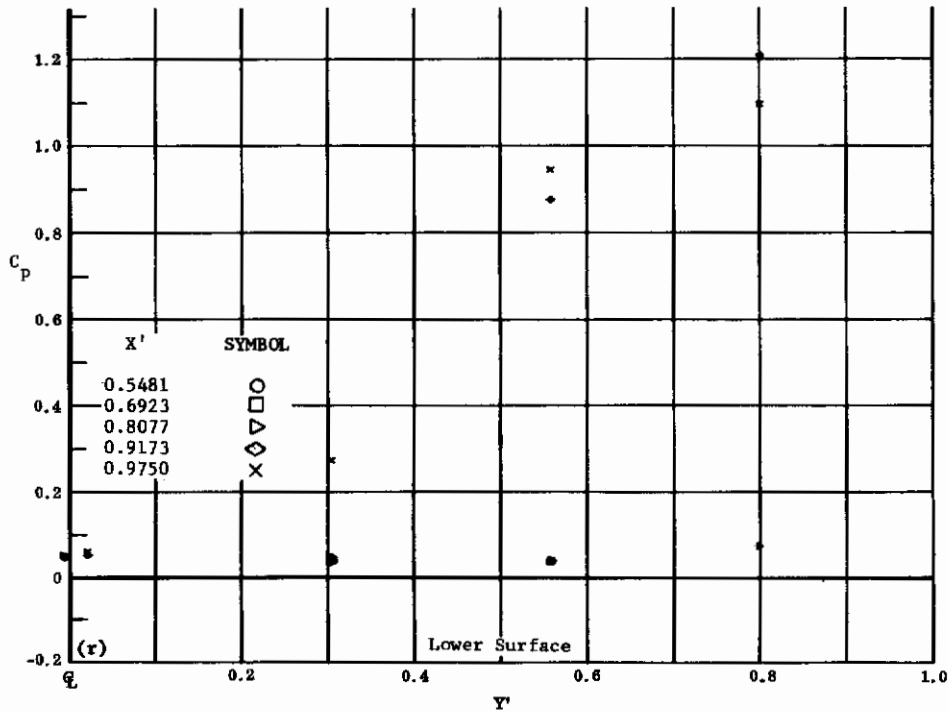

(NONDIMENSIONAL SEMISPAN DISTANCE)

Fig. 3 Configuration I, $\alpha = 0$, $\delta_2 = \delta_3 = +39$

q) C_p vs. X' , lower surface

r) C_p vs. Y' , lower surface

Contrails

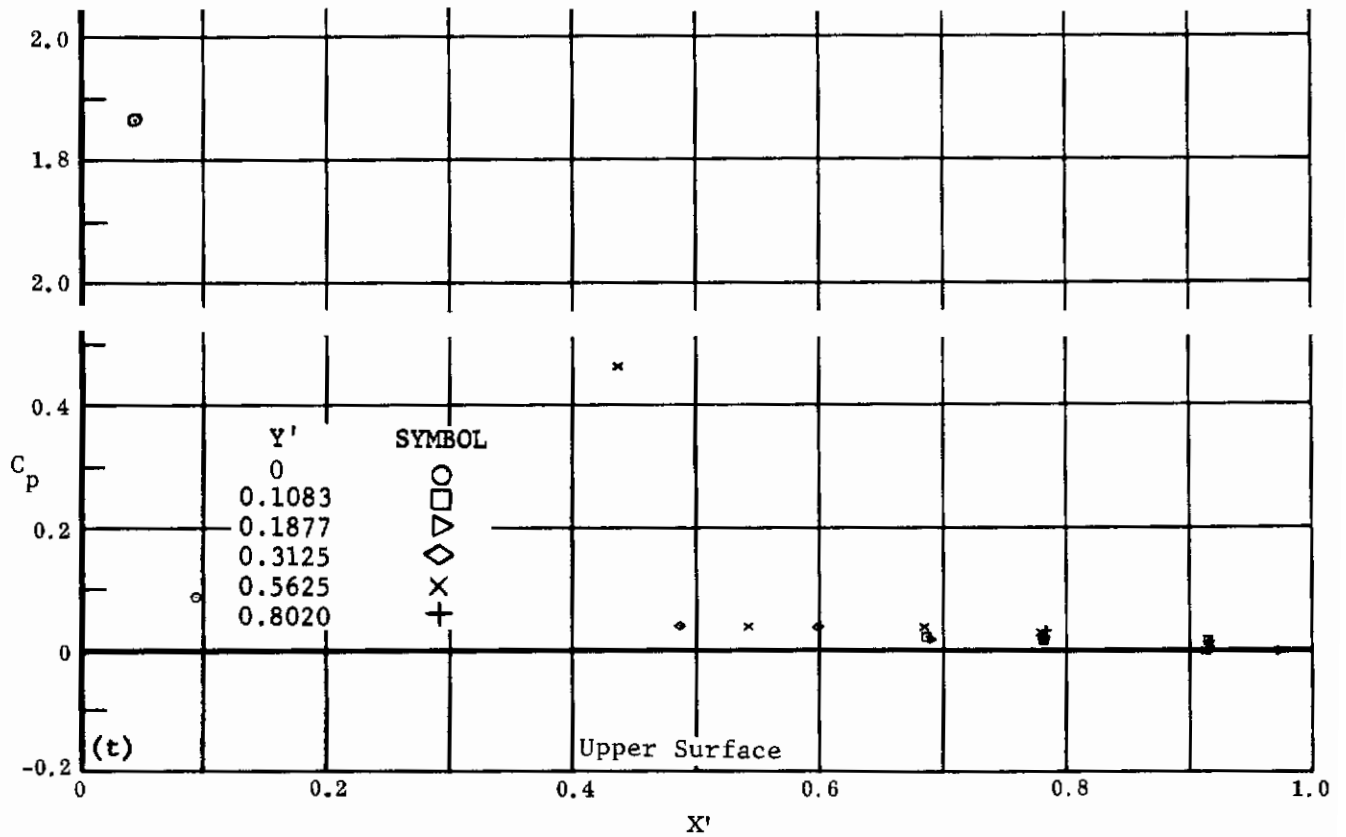
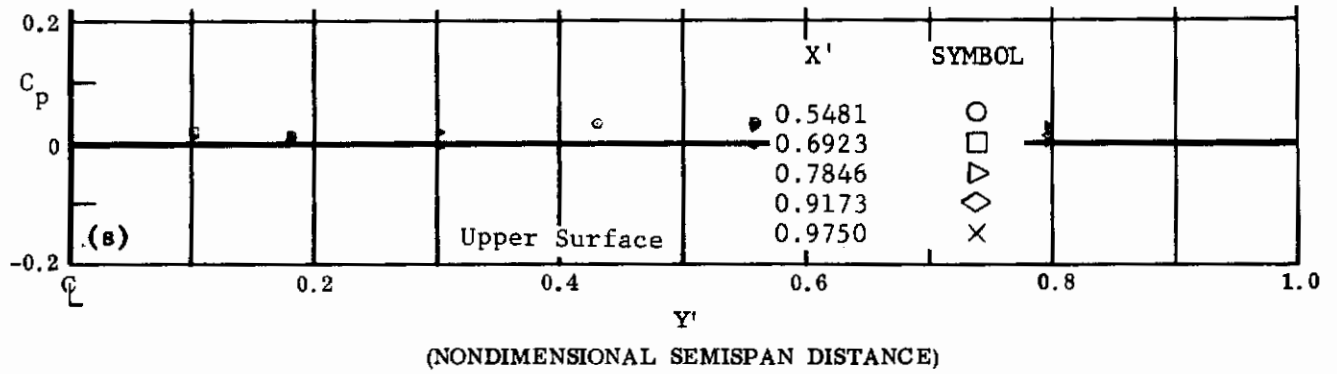

Fig. 3 Configuration I, $\alpha = 0$, $\delta_2 = \delta_3 = +39$

s) C_p vs. Y' , upper surface

t) C_p vs. X' , upper surface

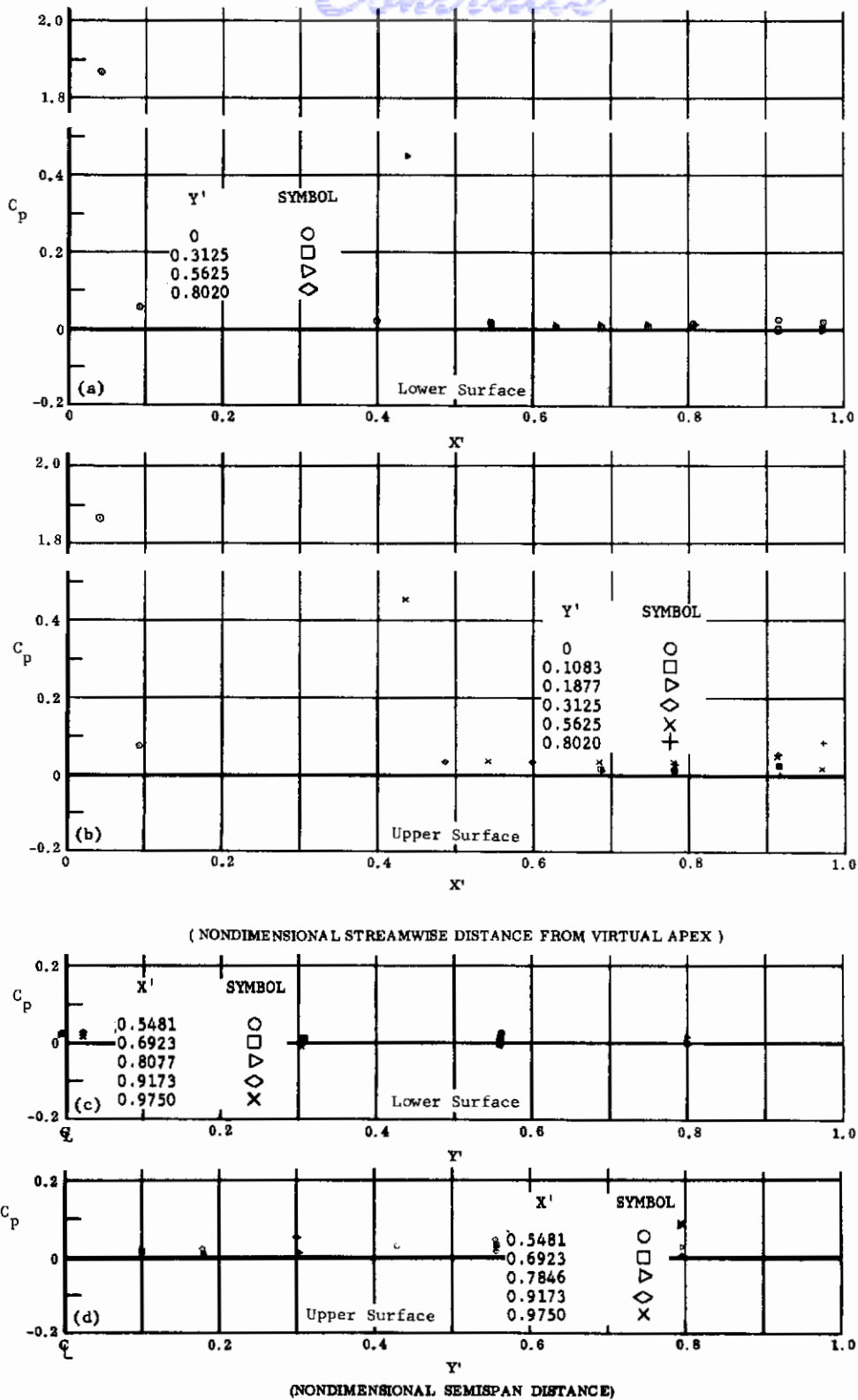
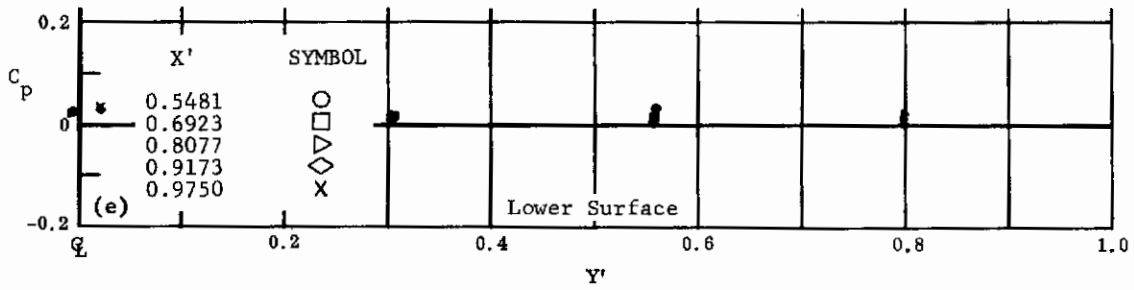

Fig. 4 Configuration I, $\alpha = 0$, $\delta_2 = \delta_3 = -10$

- a) C_p vs. X' , lower surface
- b) C_p vs. X' , upper surface
- c) C_p vs. Y' , lower surface
- d) C_p vs. Y' , upper surface

Contrails



(NONDIMENSIONAL SEMISPAN DISTANCE)

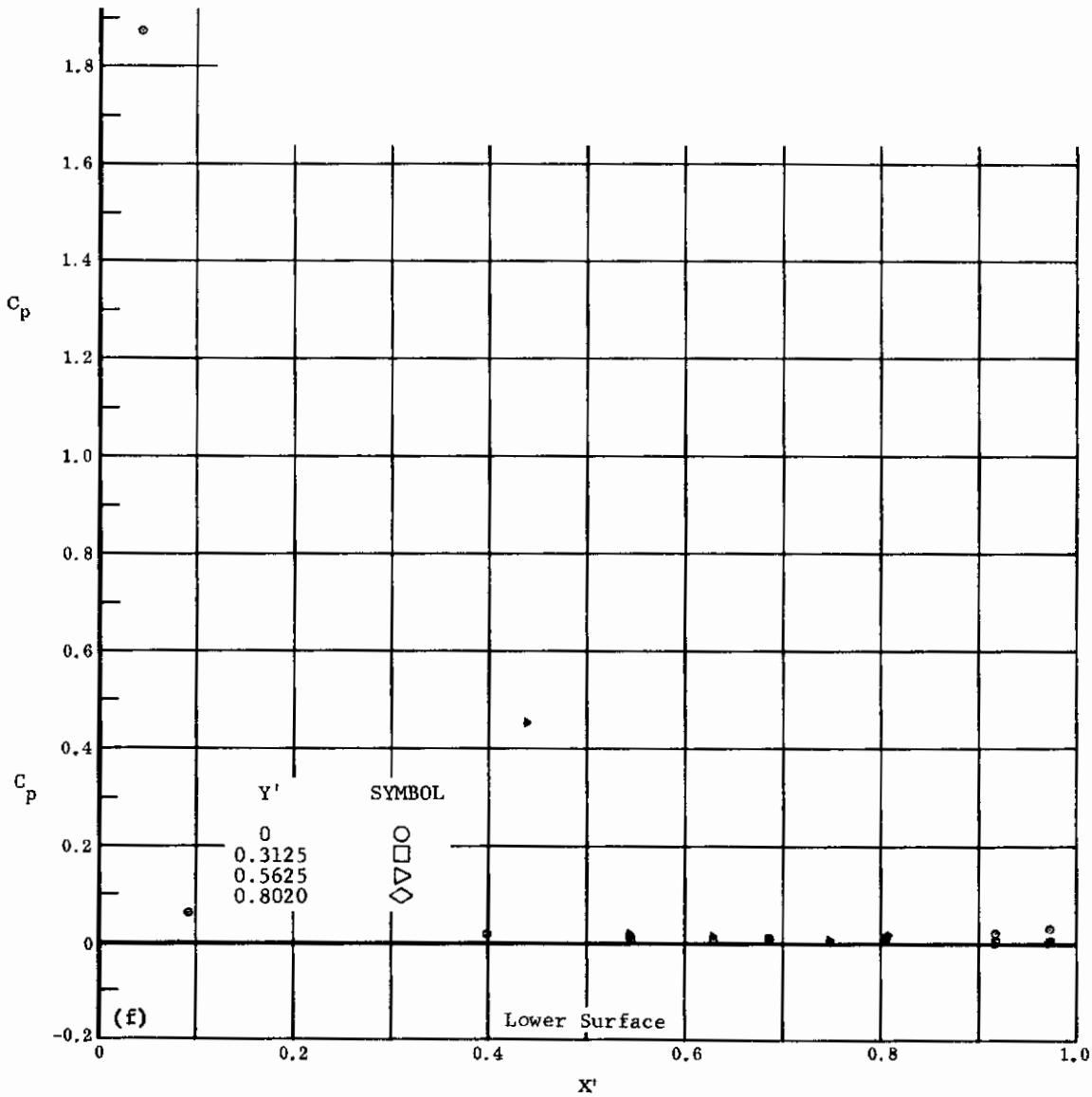

(NONDIMENSIONAL STREAMWISE DISTANCE FROM VIRTUAL APEX)

Fig. 4 Configuration I, $\alpha = 0$, $\delta_2 = \delta_3 = -20$

e) C_p vs. Y' , lower surface

f) C_p vs. X' , lower surface

Contrails

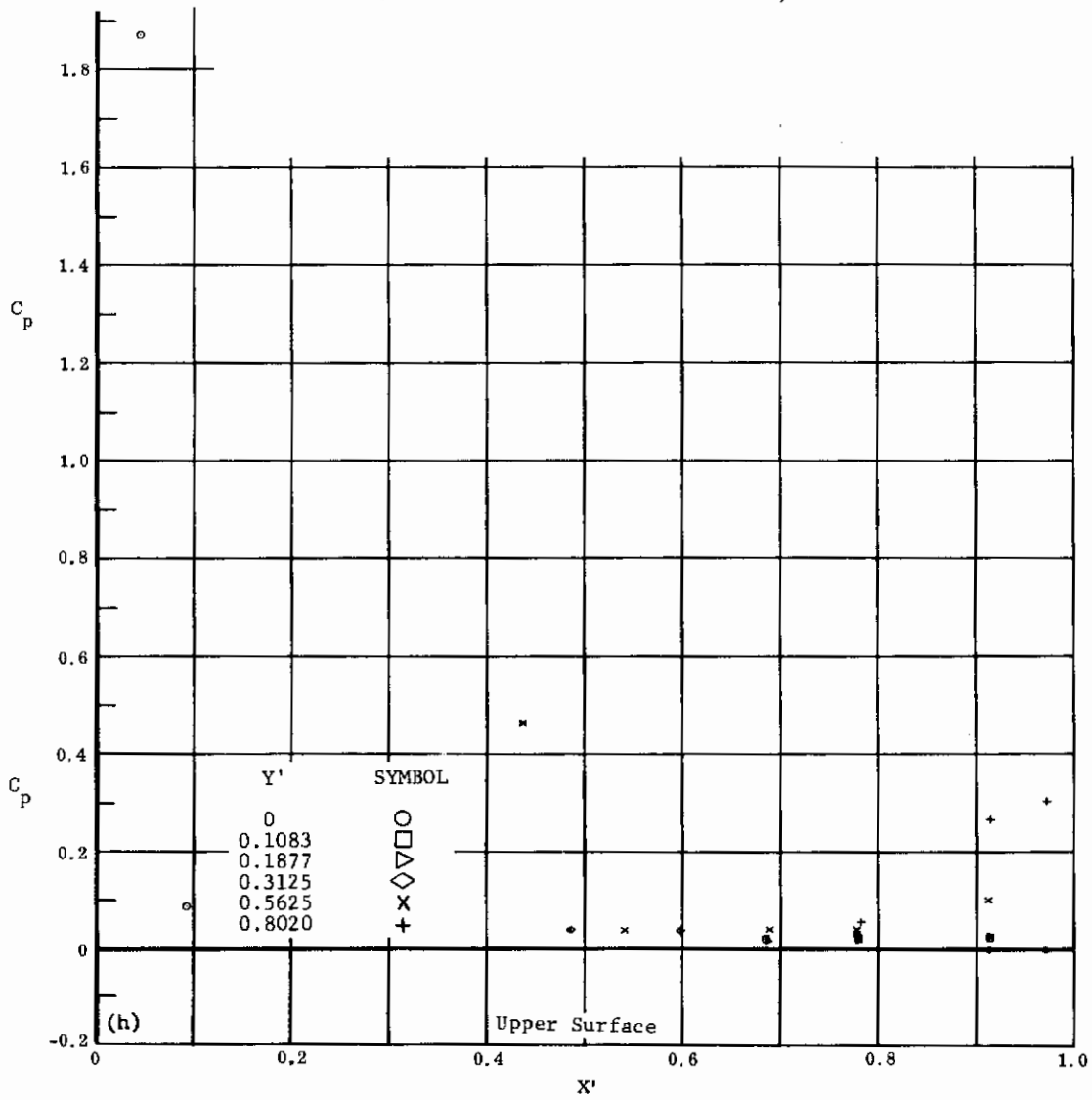
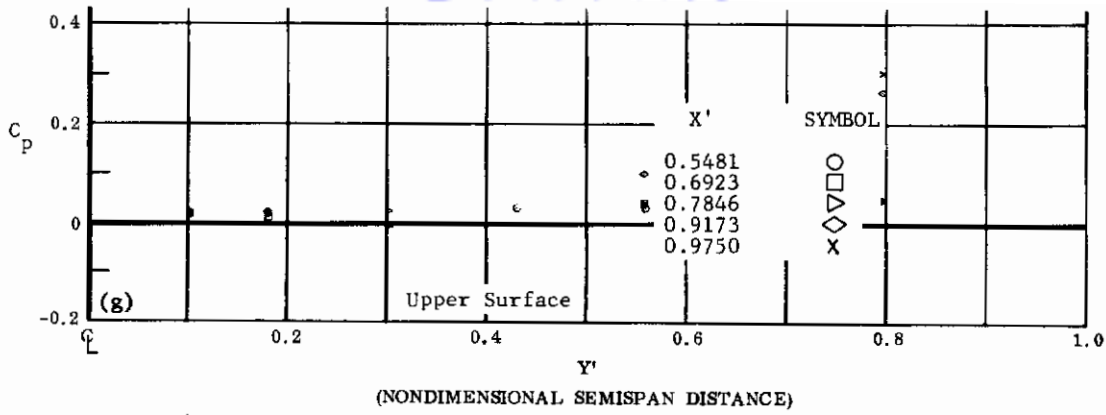

(NONDIMENSIONAL STREAMWISE DISTANCE FROM VIRTUAL APEX)

Fig. 4 Configuration I, $\alpha = 0$, $\delta_2 = \delta_3 = -20$

g) C_p vs. Y' , upper surface

h) C_p vs. X' , upper surface

Contrails

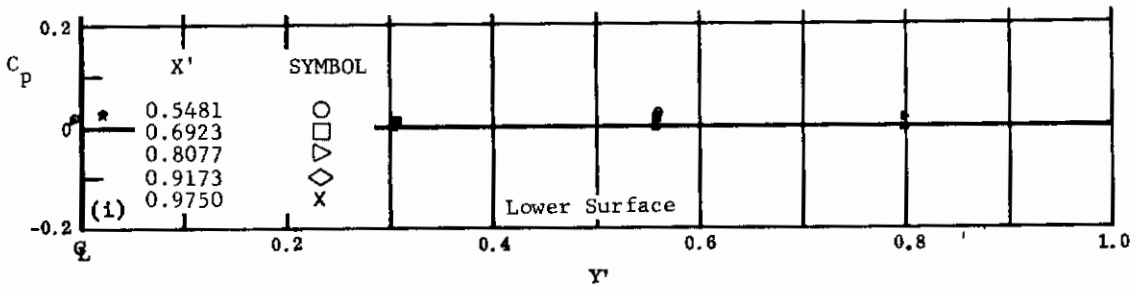

(NONDIMENSIONAL SEMISPAN DISTANCE)

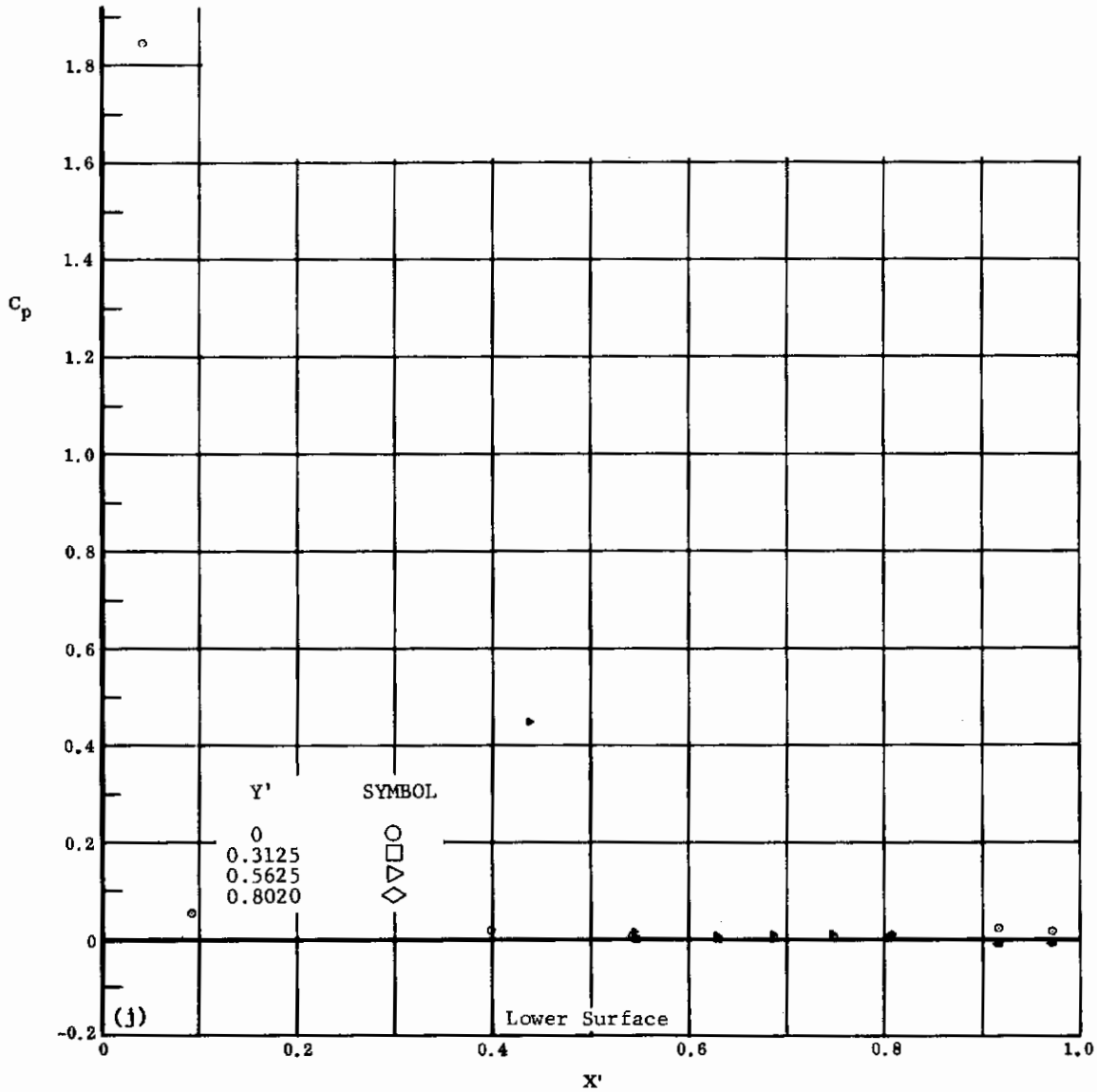

(NONDIMENSIONAL STREAMWISE DISTANCE FROM VIRTUAL APEX)

Fig. 4 Configuration I, $\alpha = 0$, $\delta_2 = \delta_3 = -30$

i) C_p vs. Y' , lower surface

j) C_p vs. X' , lower surface

Contrails

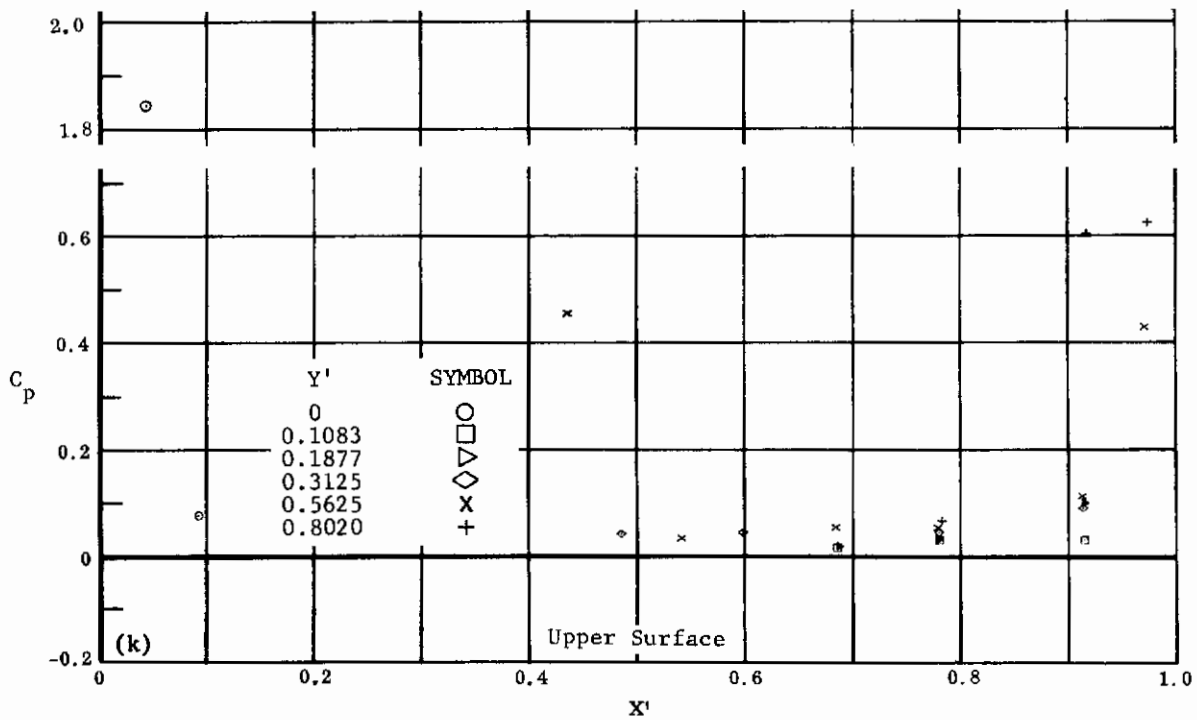

(NONDIMENSIONAL STREAMWISE DISTANCE FROM VIRTUAL APEX)

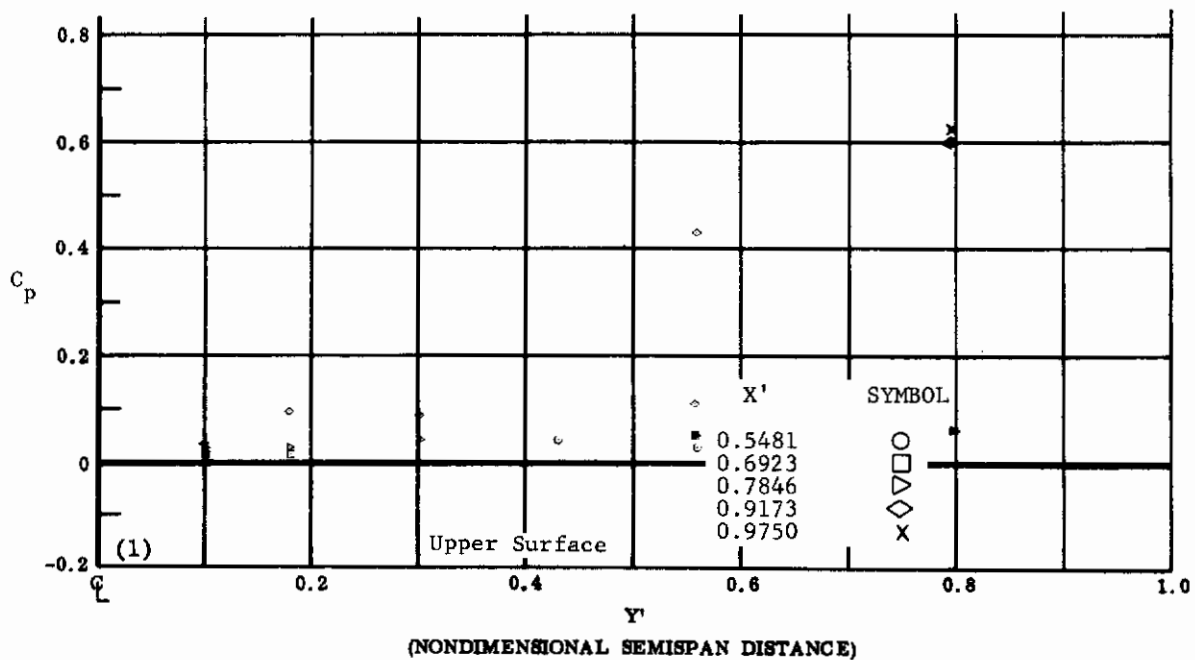
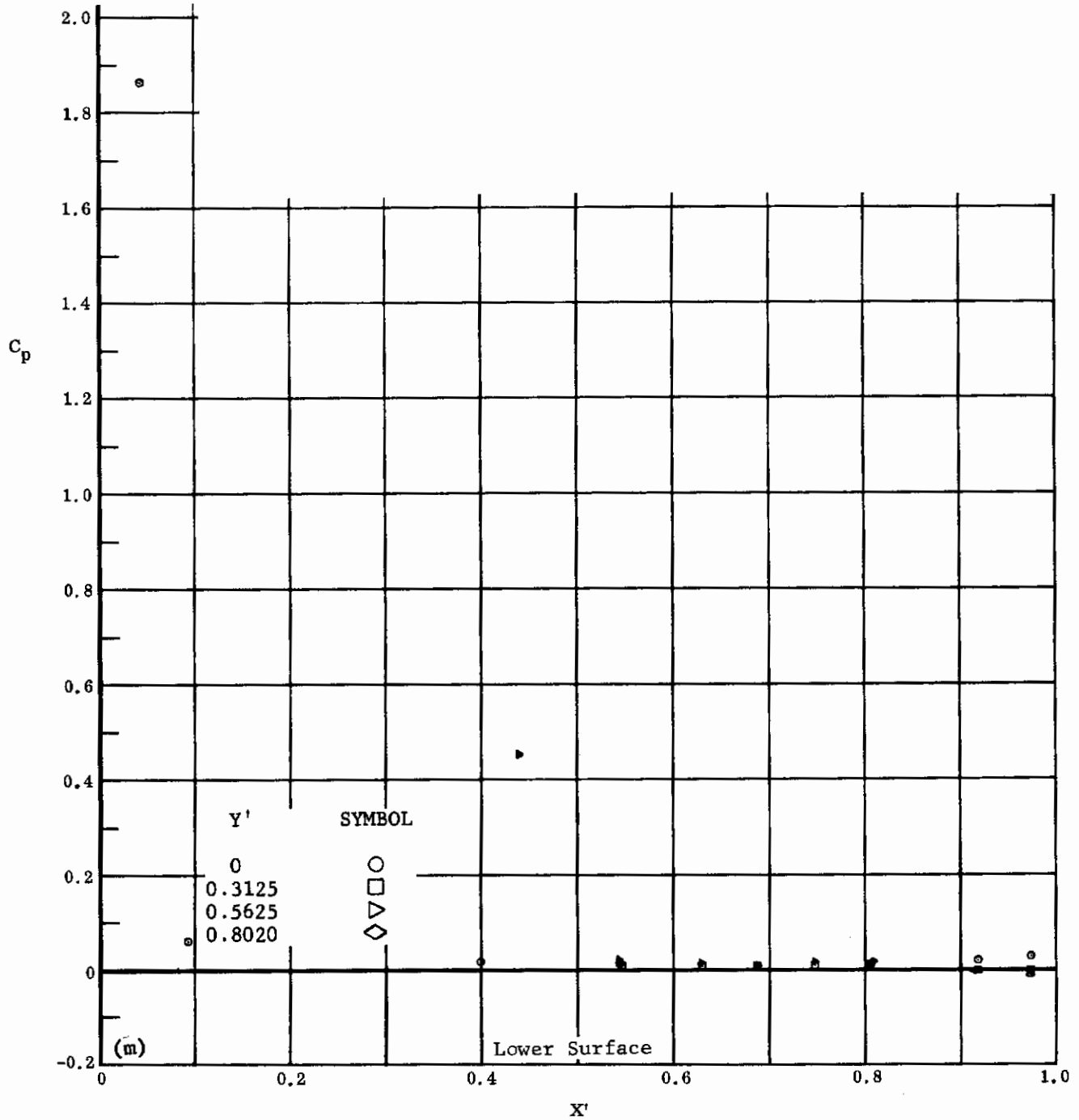

Fig. 4 Configuration I, $\alpha = 0$, $\delta_2 = \delta_3 = -30$

k) C_p vs. X' , upper surface

l) C_p vs. Y' , upper surface



(NONDIMENSIONAL STREAMWISE DISTANCE FROM VIRTUAL APEX)

Fig. 4m Configuration I, $\alpha = 0$, $\delta_2 = \delta_3 = -39$

C_p vs. X' , lower surface

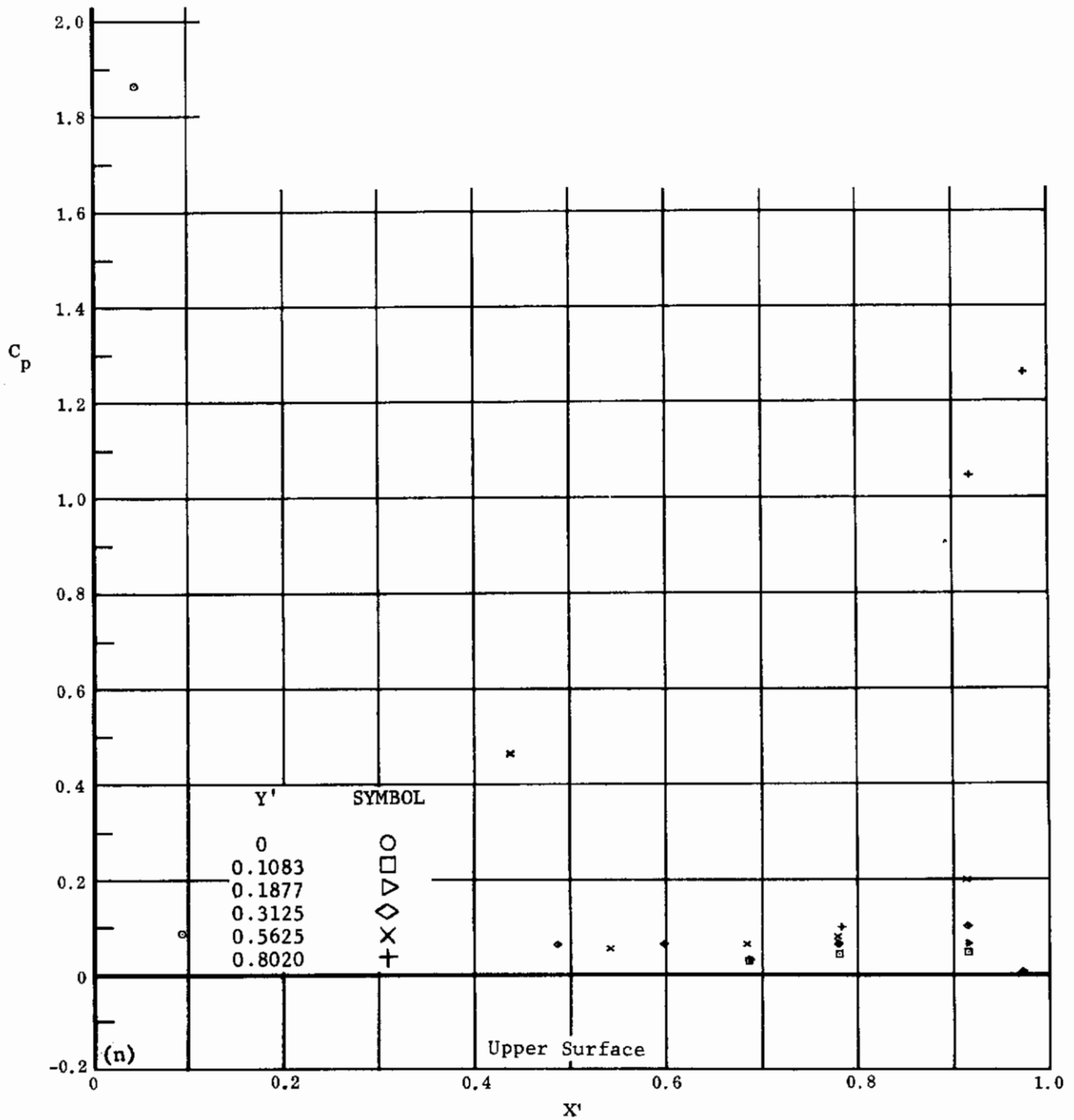

(NONDIMENSIONAL STREAMWISE DISTANCE FROM VIRTUAL APEX)

Fig. 4n Configuration I, $a = 0$, $\delta_2 = \delta_3 = -39$

C_p vs. X' , upper surface

Contrails

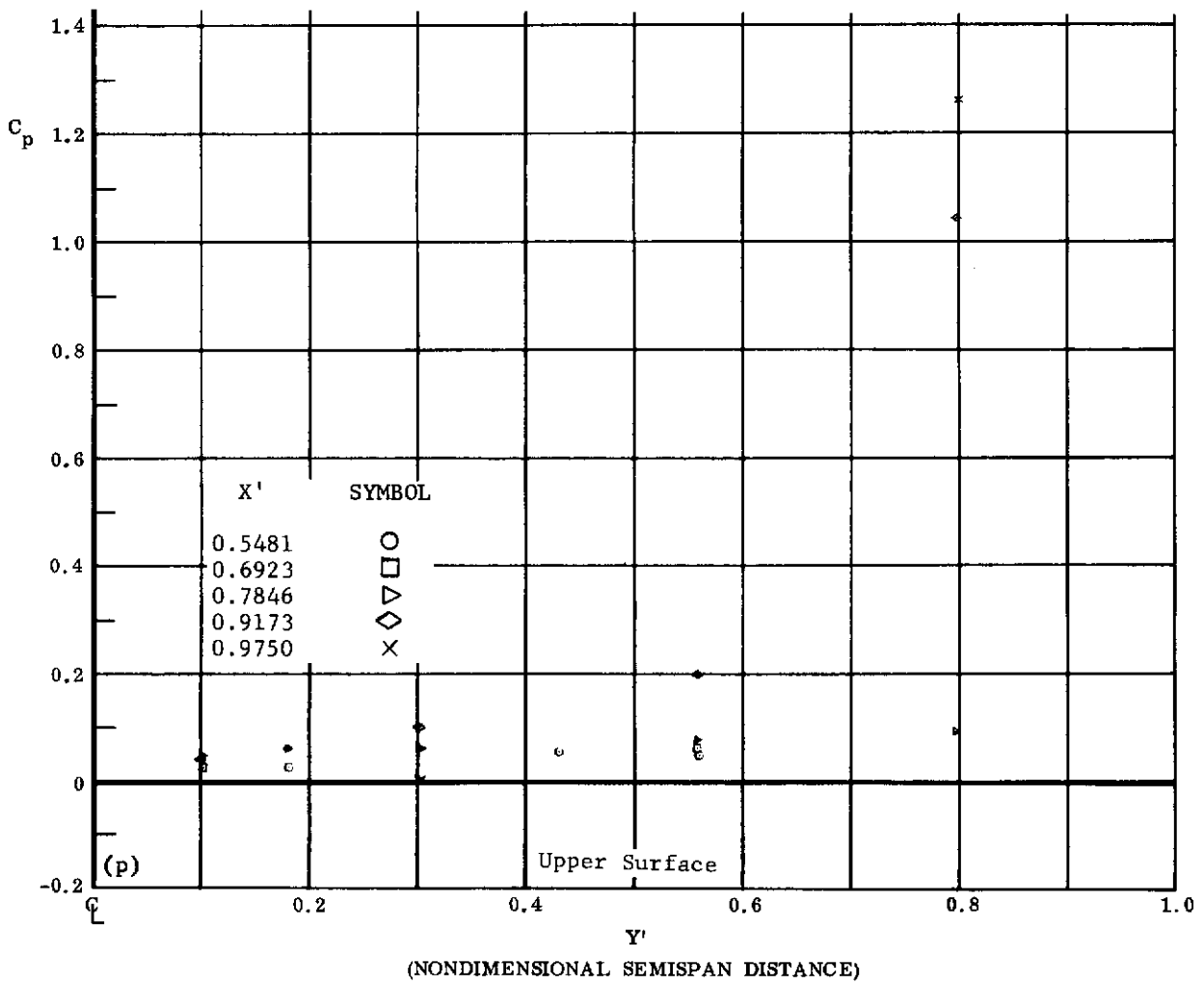
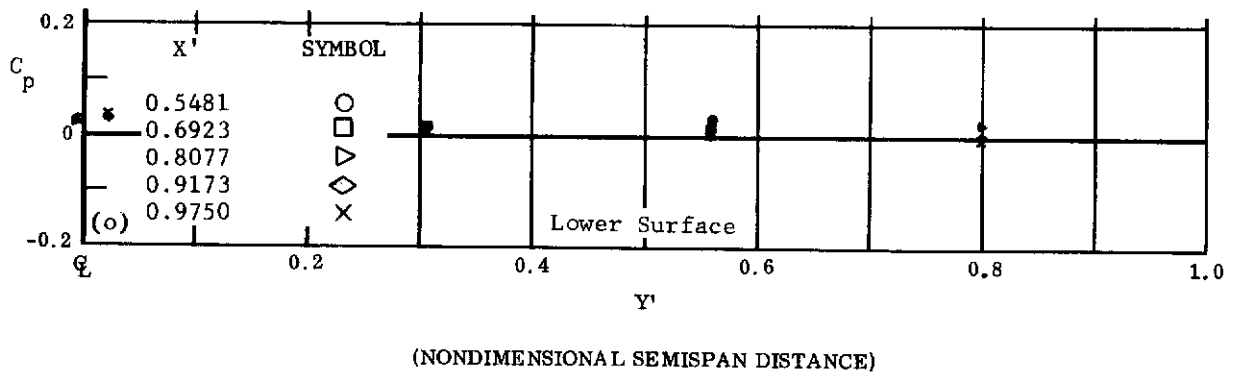

Fig. 4 Configuration I, $\alpha = 0$, $\delta_2 = \delta_3 = -39$

- o) C_p vs. Y' , lower surface
- p) C_p vs. Y' , upper surface

Contrails

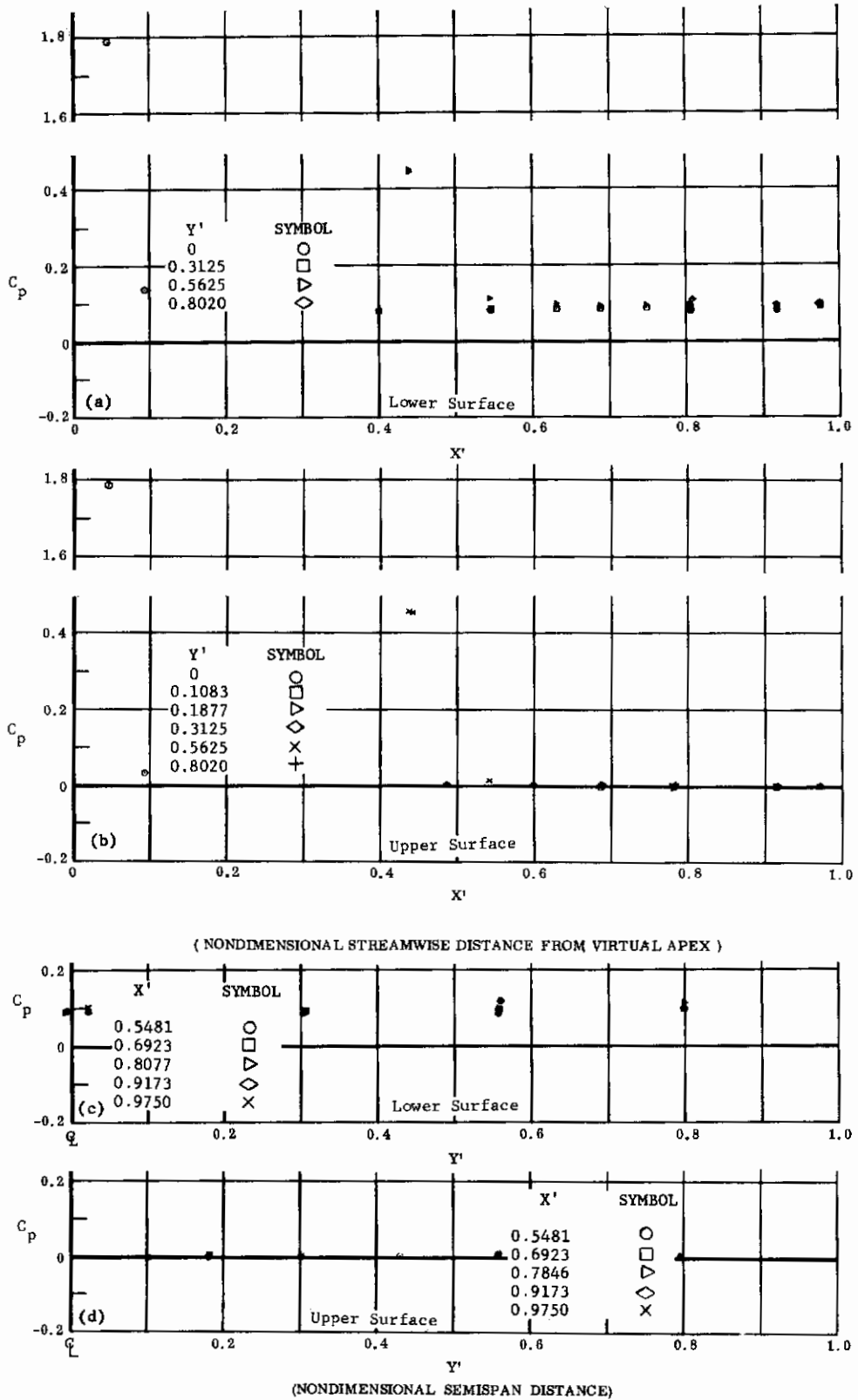
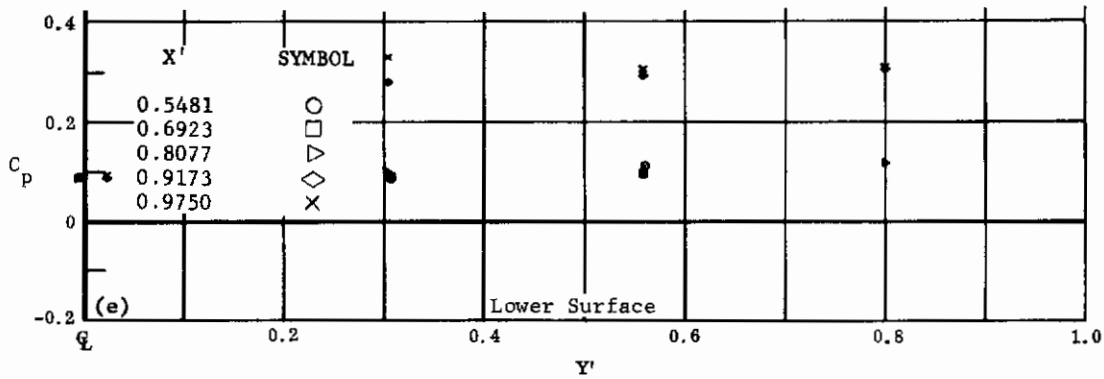

Fig. 5 Configuration I, $\alpha = +10$, $\delta_2 = \delta_3 = 0$

- a) C_p vs. X' , lower surface
- b) C_p vs. X' , upper surface
- c) C_p vs. Y' , lower surface
- d) C_p vs. Y' , upper surface

Contrails



(NONDIMENSIONAL SEMISPAN DISTANCE)

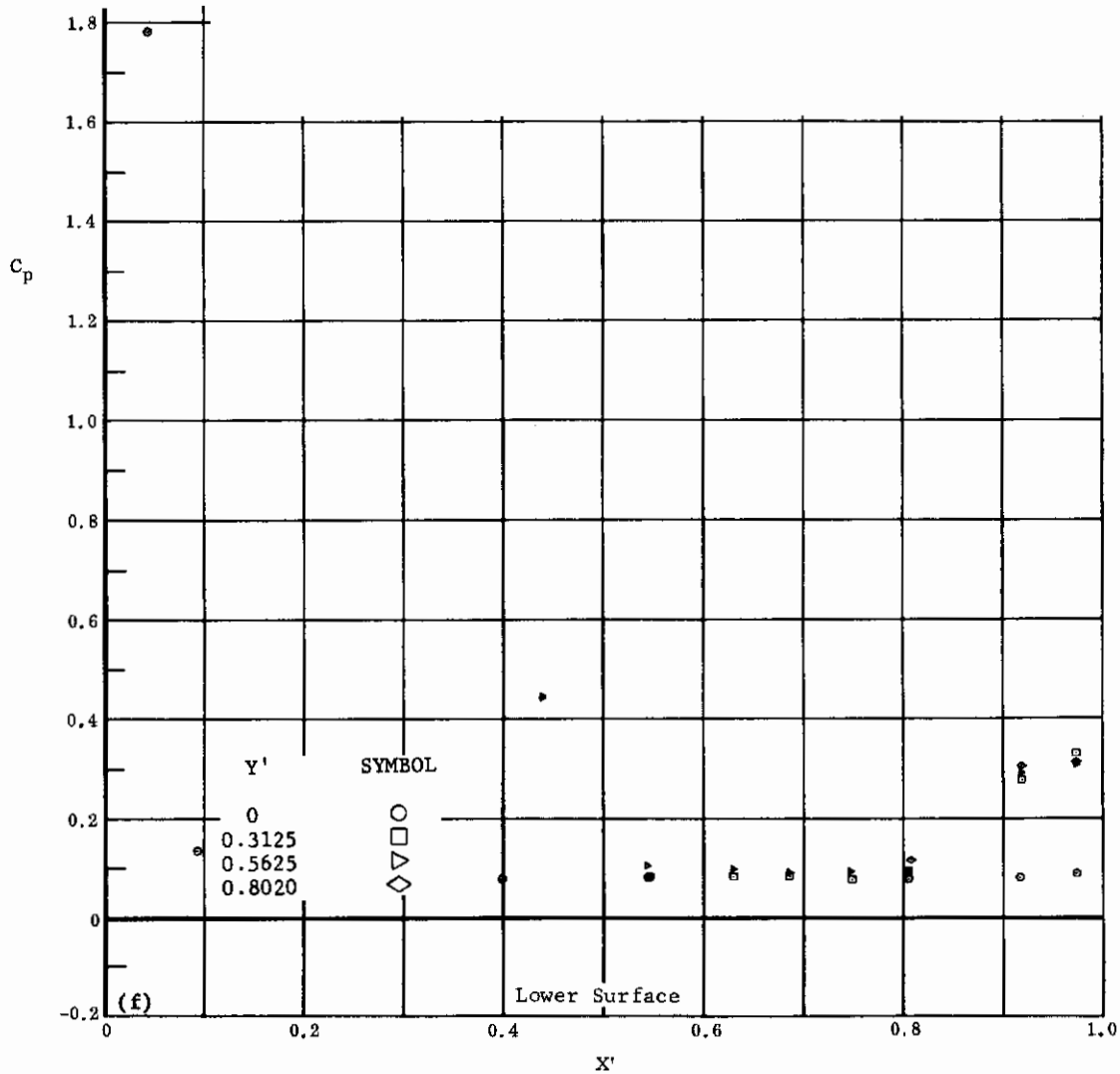

(NONDIMENSIONAL STREAMWISE DISTANCE FROM VIRTUAL APEX)

Fig. 5 Configuration I, $\alpha = +10$, $\delta_2 = \delta_3 = +10$

e) C_p vs. Y' , lower surface

f) C_p vs. X' , lower surface

Contrails

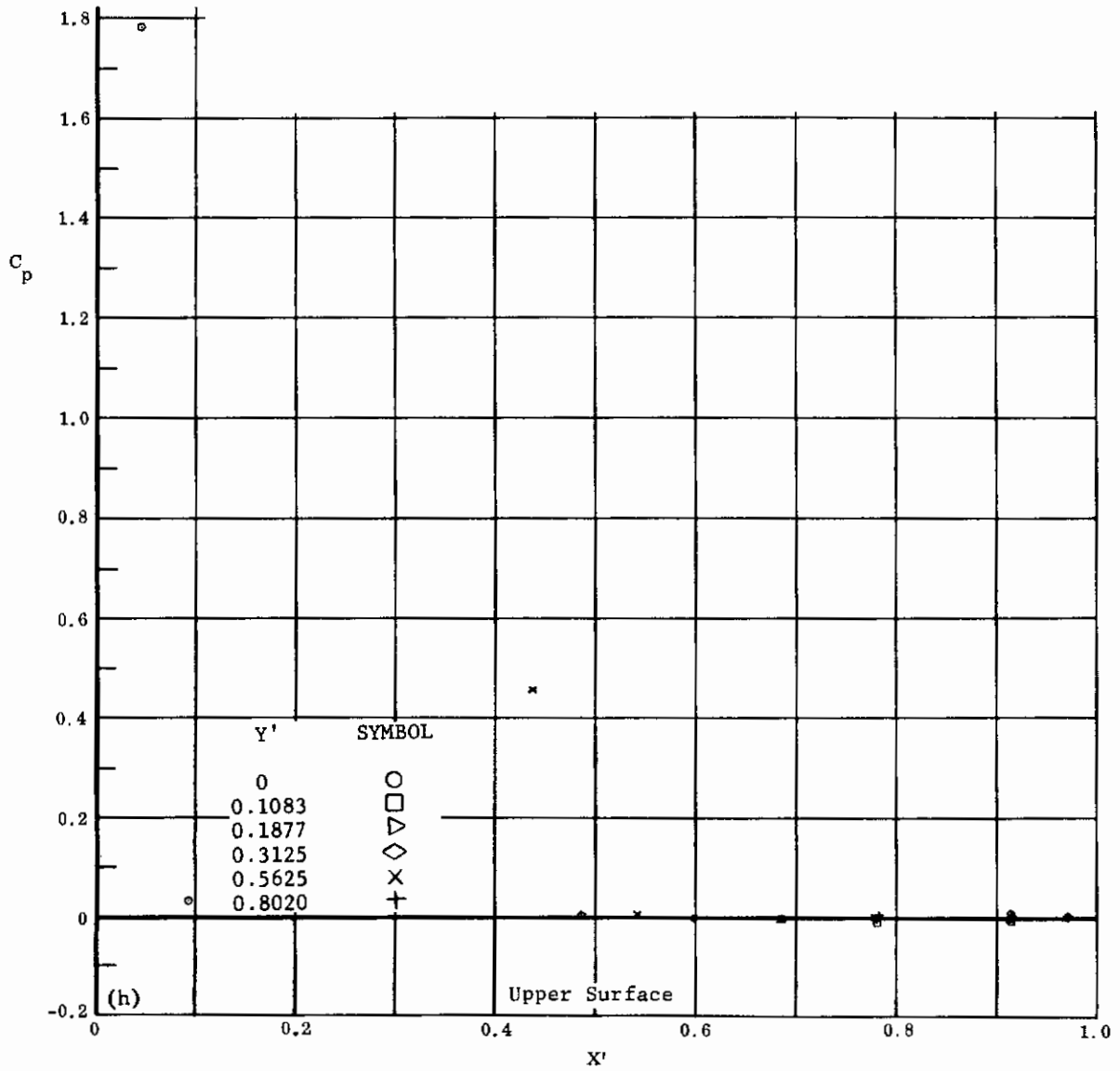
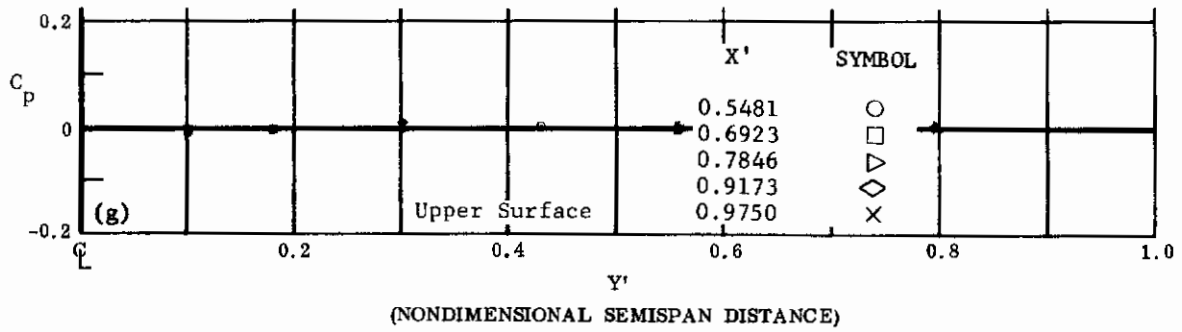

Fig. 5 Configuration I, $\alpha = +10$, $\delta_2 = \delta_3 = +10$

g) C_p vs. Y' , upper surface

h) C_p vs. X' , upper surface

Contrails

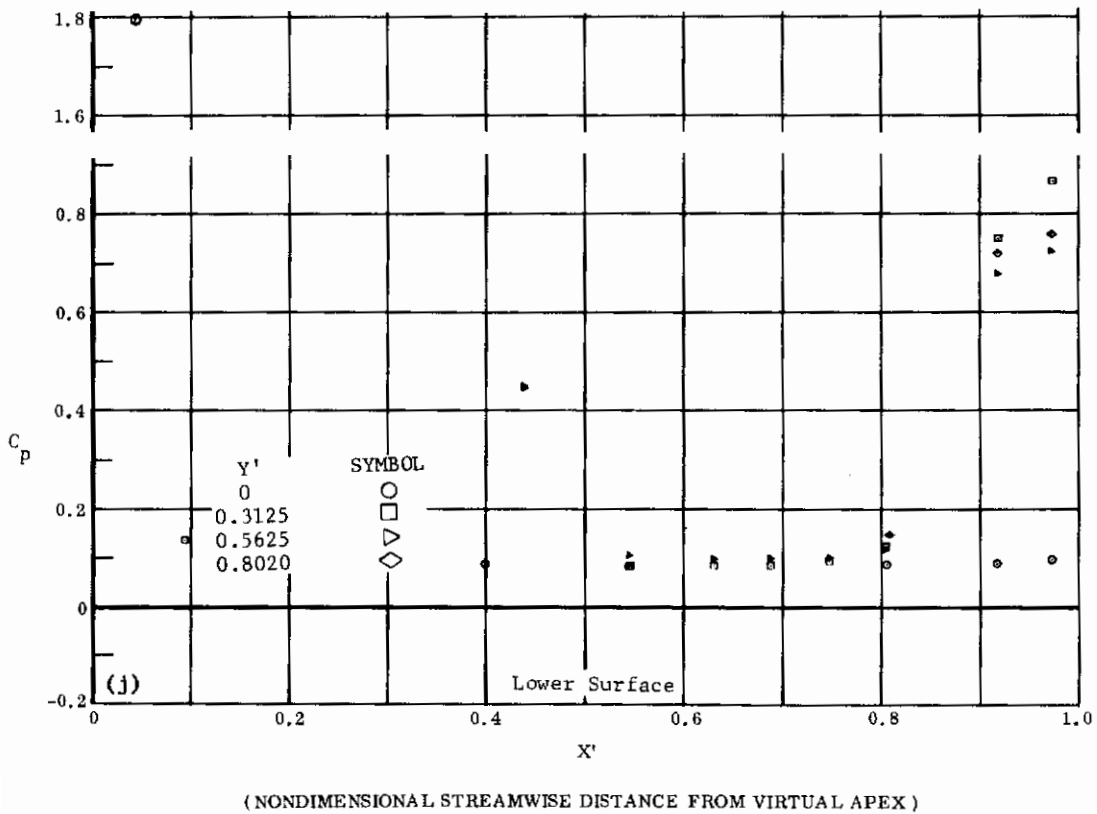
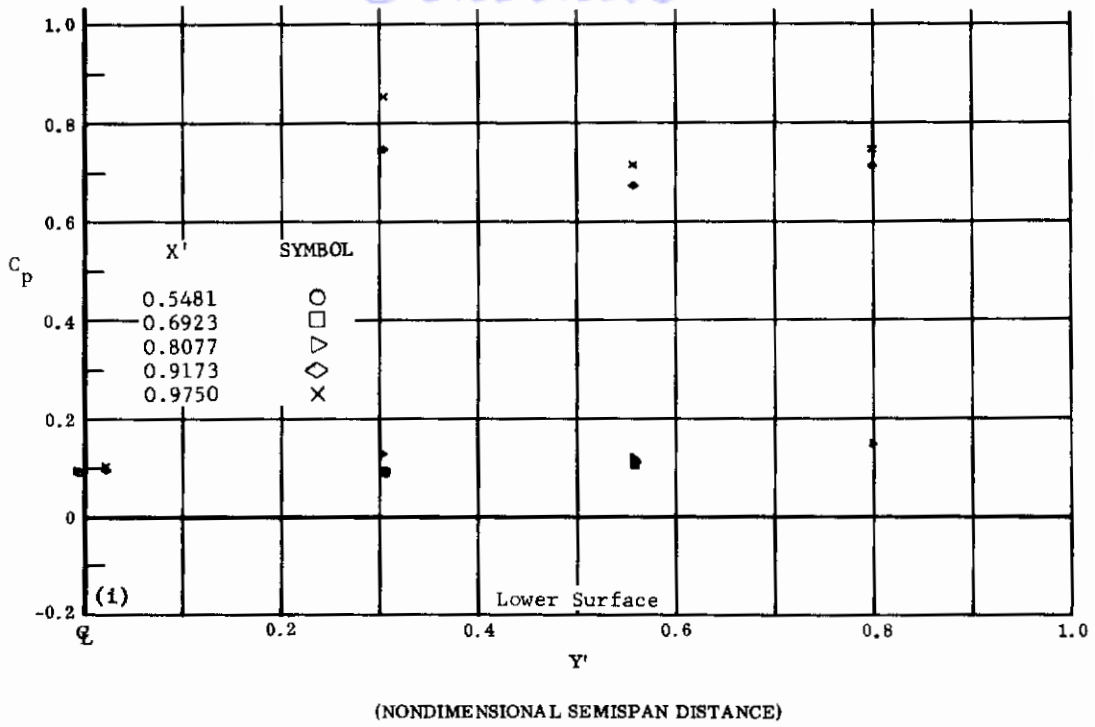

Fig. 5 Configuration I, $\alpha = +10$, $\delta_2 = \delta_3 = +20$

- i) C_p vs. Y' , lower surface
- j) C_p vs. X' , lower surface

Contrails

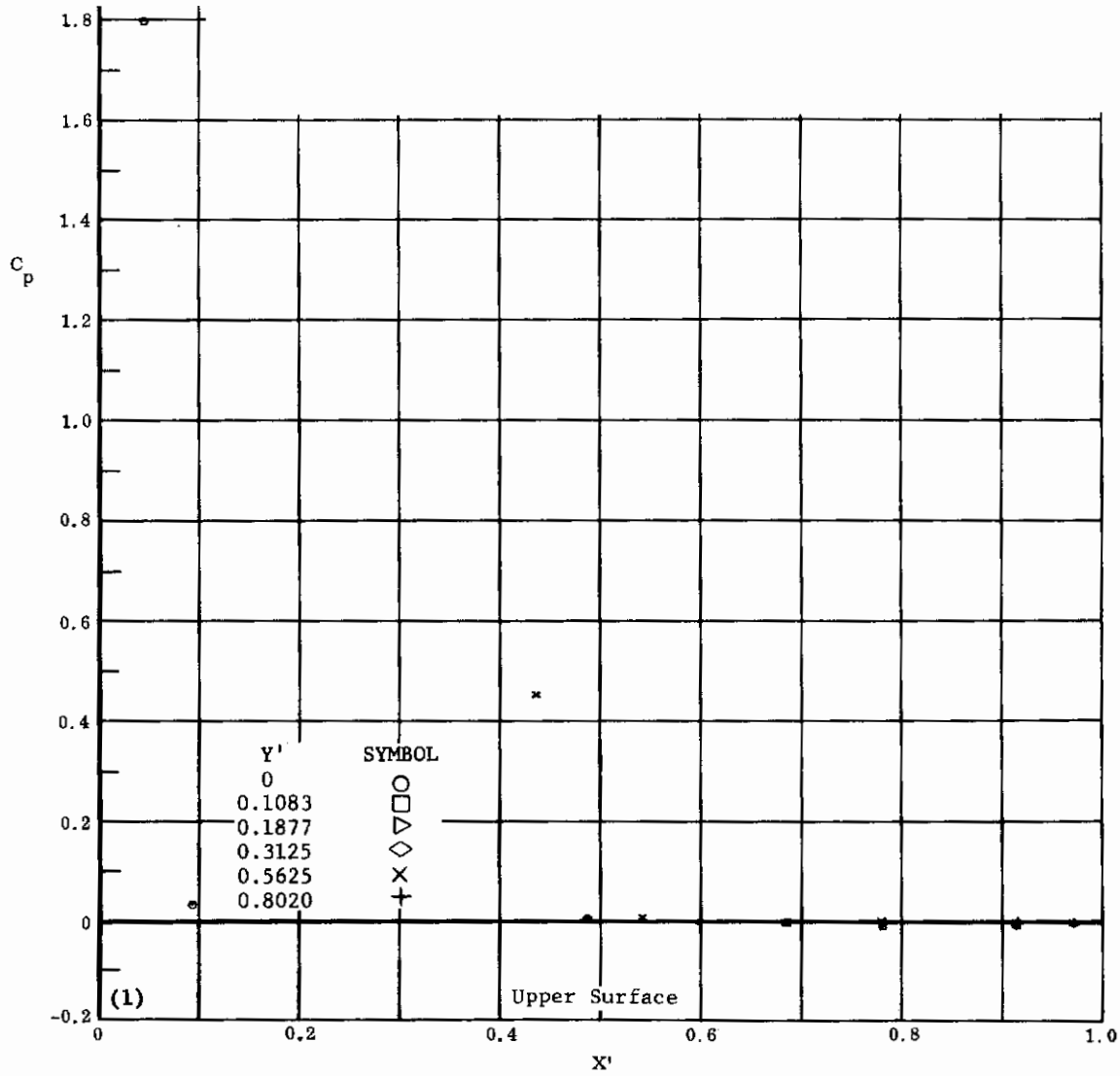
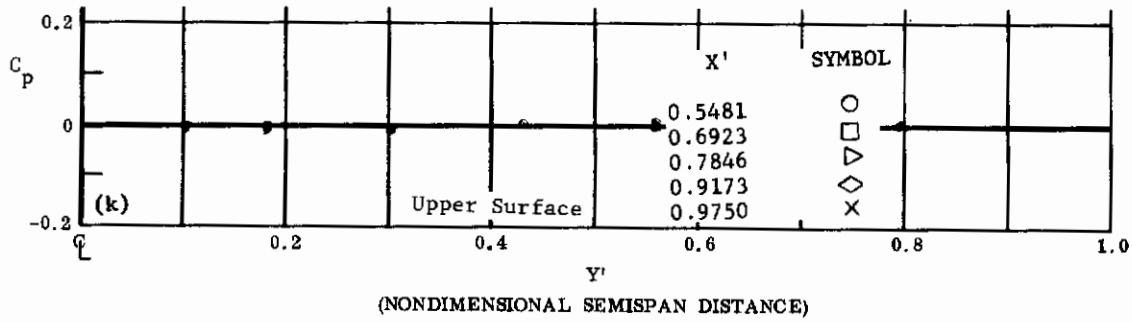
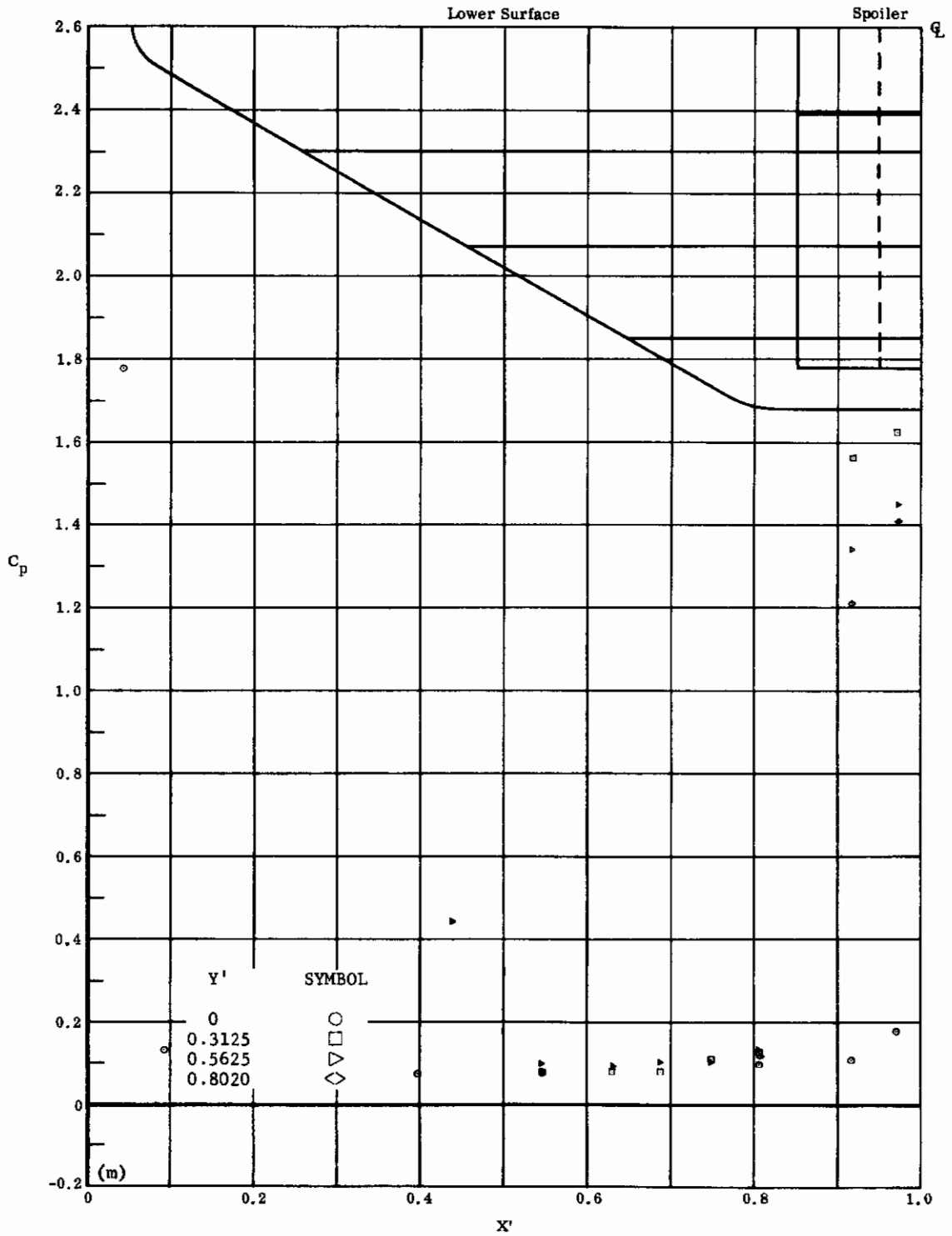

Fig. 5 Configuration I, $\alpha = +10$, $\delta_2 = \delta_3 = +20$

k) C_p vs. Y' , upper surface

1) C_p vs. X' , upper surface



(NONDIMENSIONAL STREAMWISE DISTANCE FROM VIRTUAL APEX)

Fig. 5m Configuration I, $\alpha = +10$, $\delta_2 = \delta_3 = +30$

C_p vs X' , lower surface

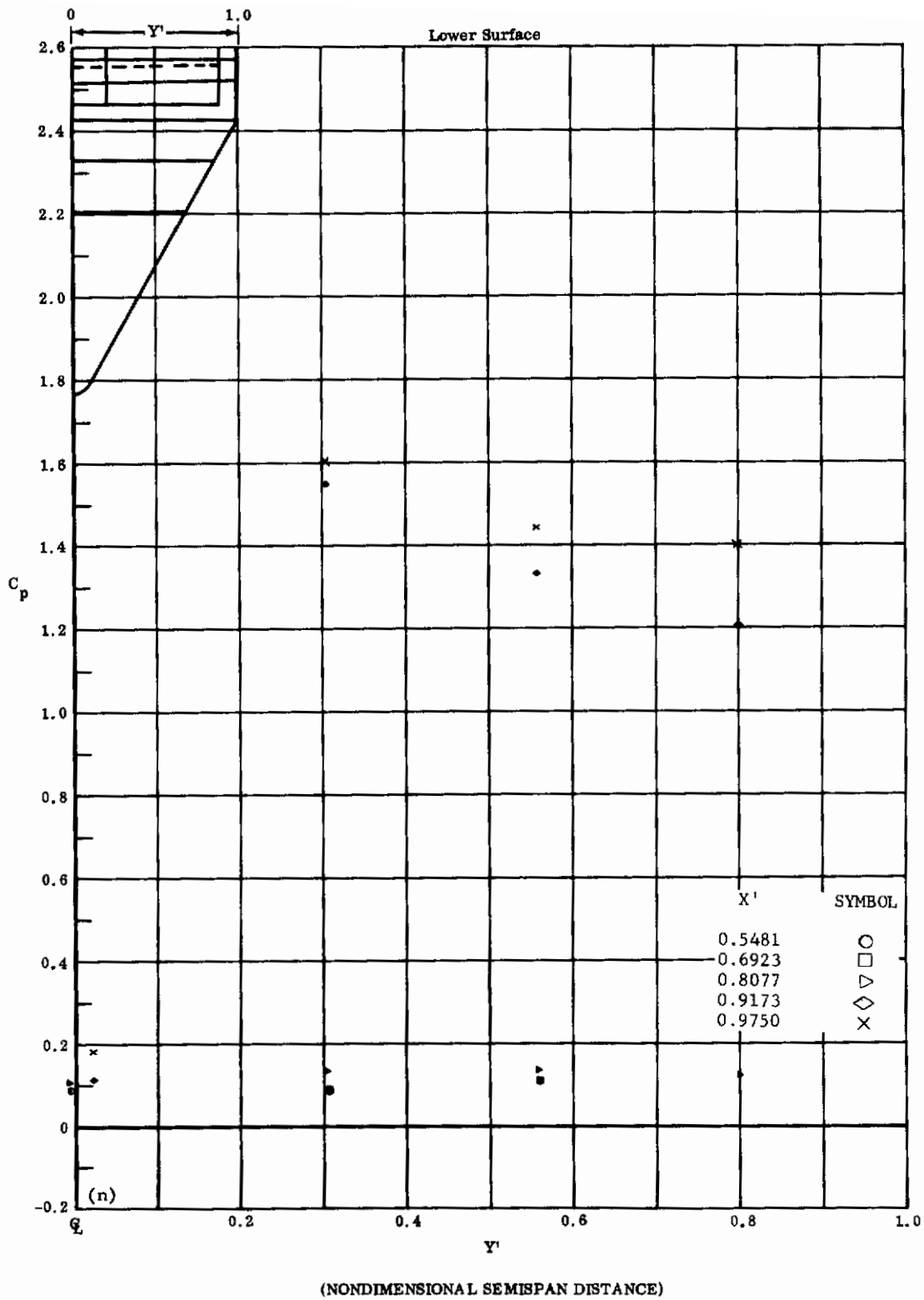
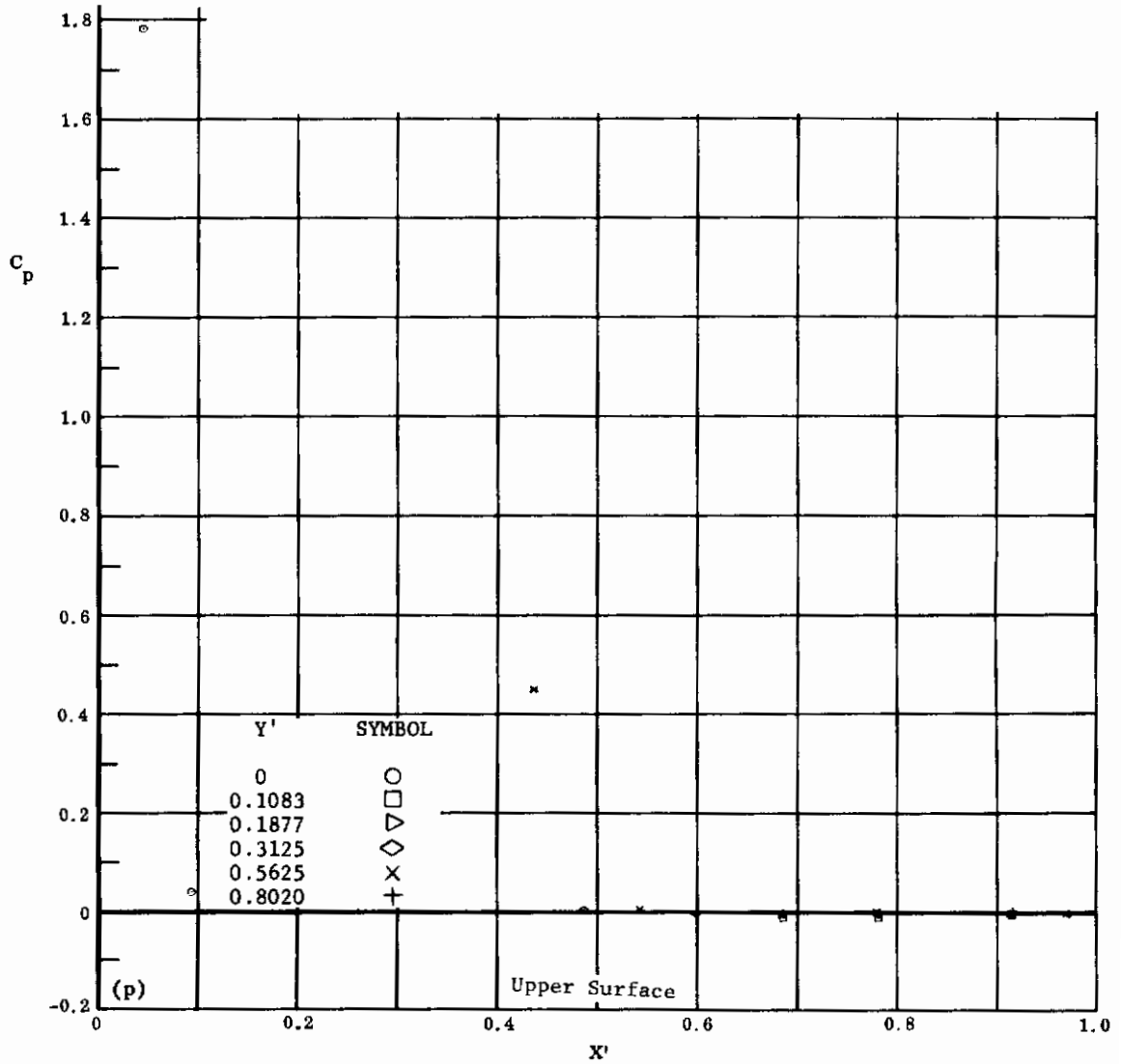
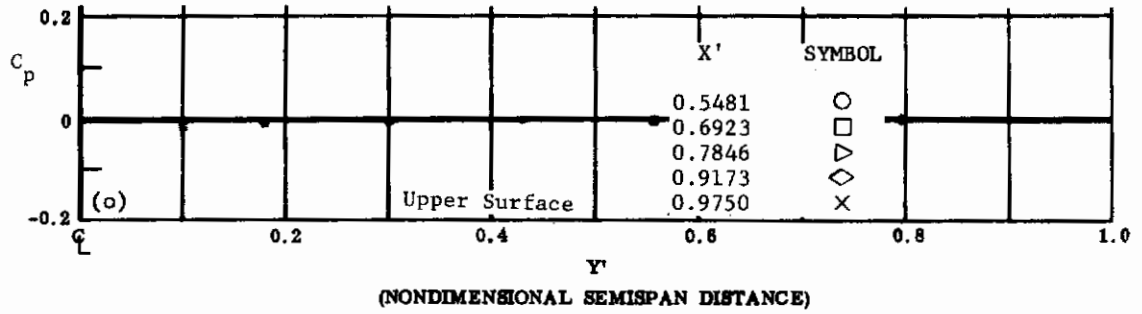

Fig. 5n Configuration I, $\alpha = +10$, $\delta_2 = \delta_3 = +30$

C_p vs. Y' , lower surface

Contrails



(NONDIMENSIONAL STREAMWISE DISTANCE FROM VIRTUAL APEX)

Fig. 5 Configuration I, $\alpha = +10$, $\delta_2 = \delta_3 = +30$

- o) C_p vs. Y' , upper surface
- p) C_p vs. X' , upper surface

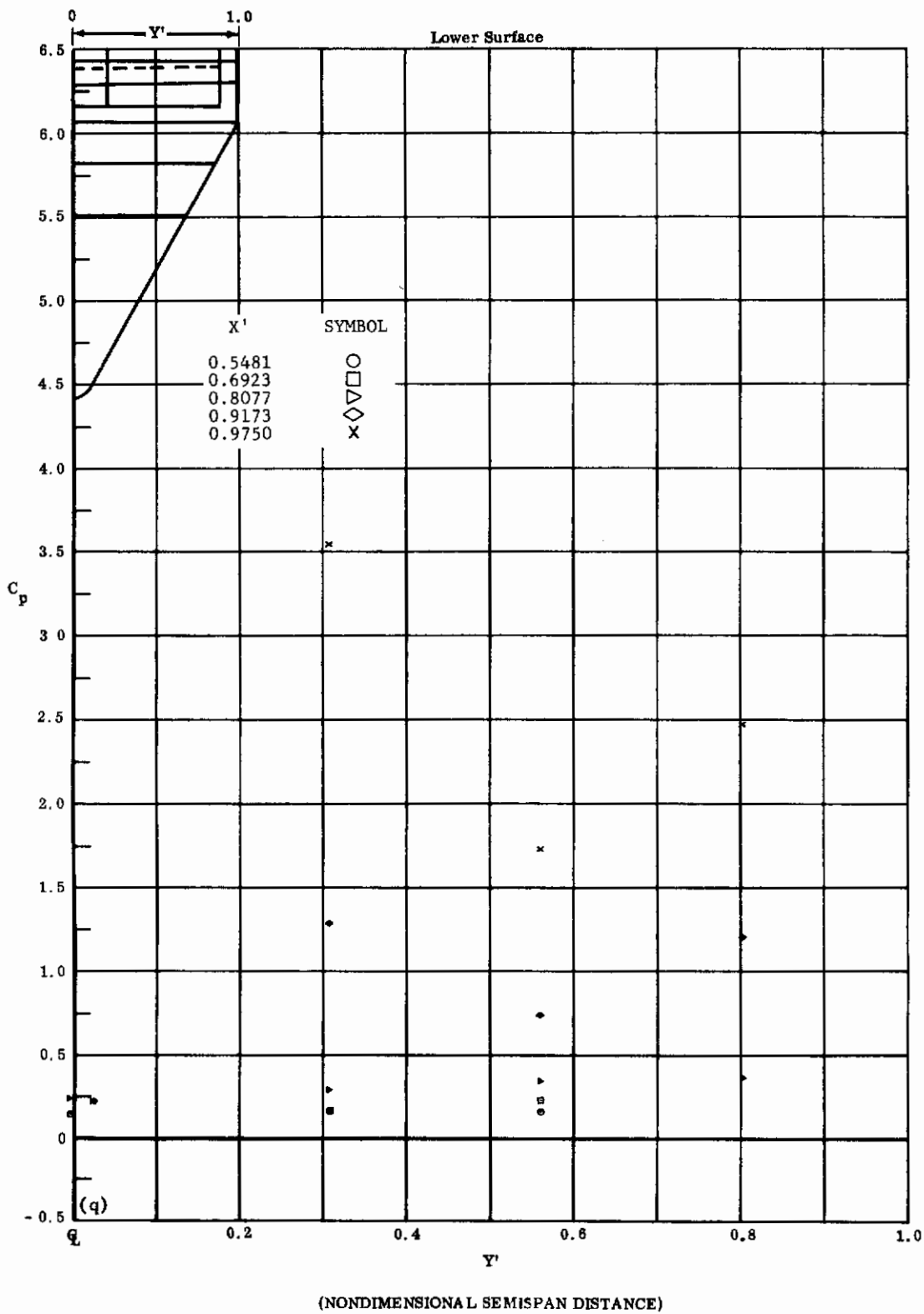
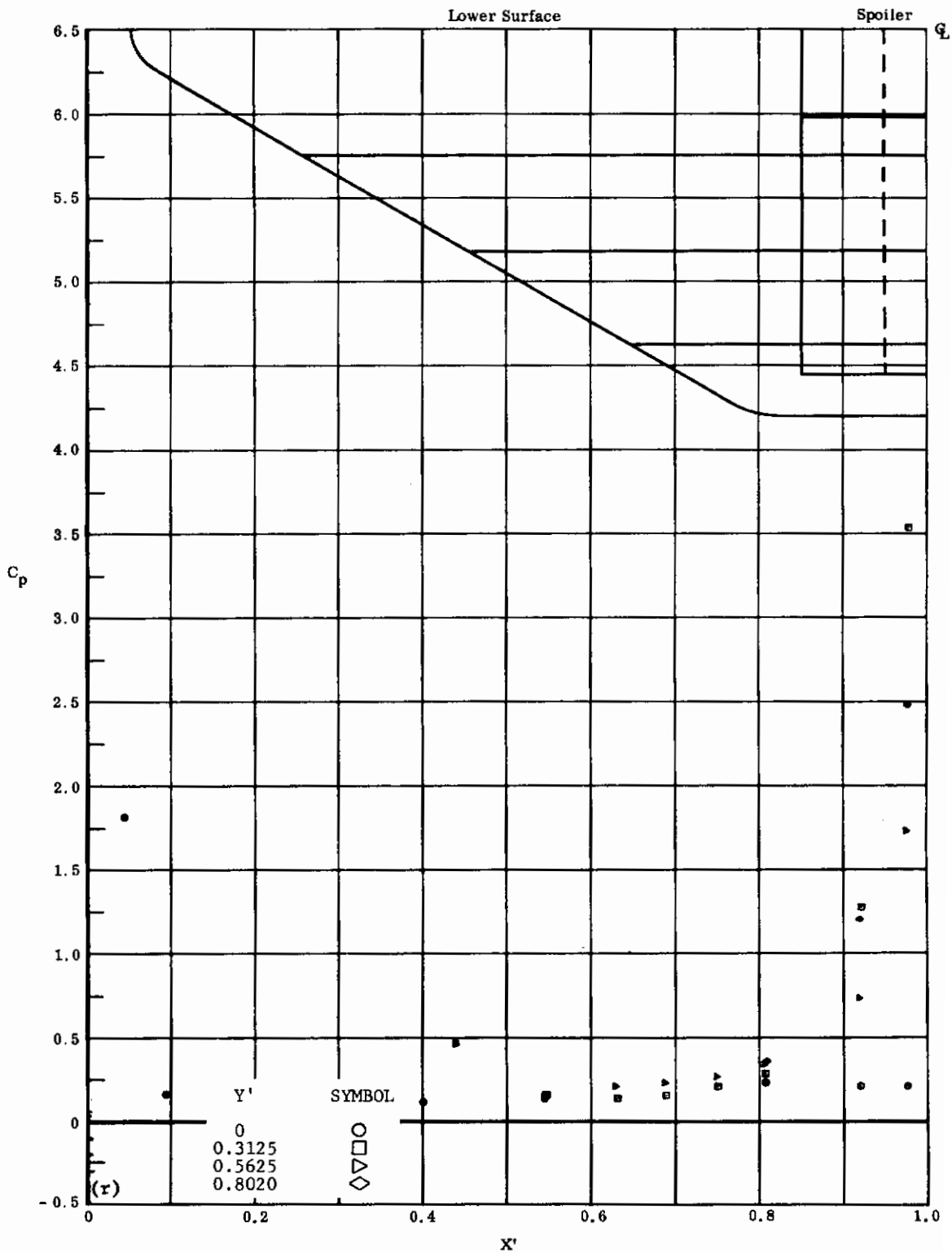

Fig. 5q Configuration I, $\alpha = +10$, $\delta_2 = \delta_3 = +39$

C_p vs. Y' , lower surface

Contrails



(NONDIMENSIONAL STREAMWISE DISTANCE FROM VIRTUAL APEX)

Fig. 5r Configuration I, $\alpha = +10$, $\delta_2 = \delta_3 = +39$

C_p vs. X' , lower surface

Contrails

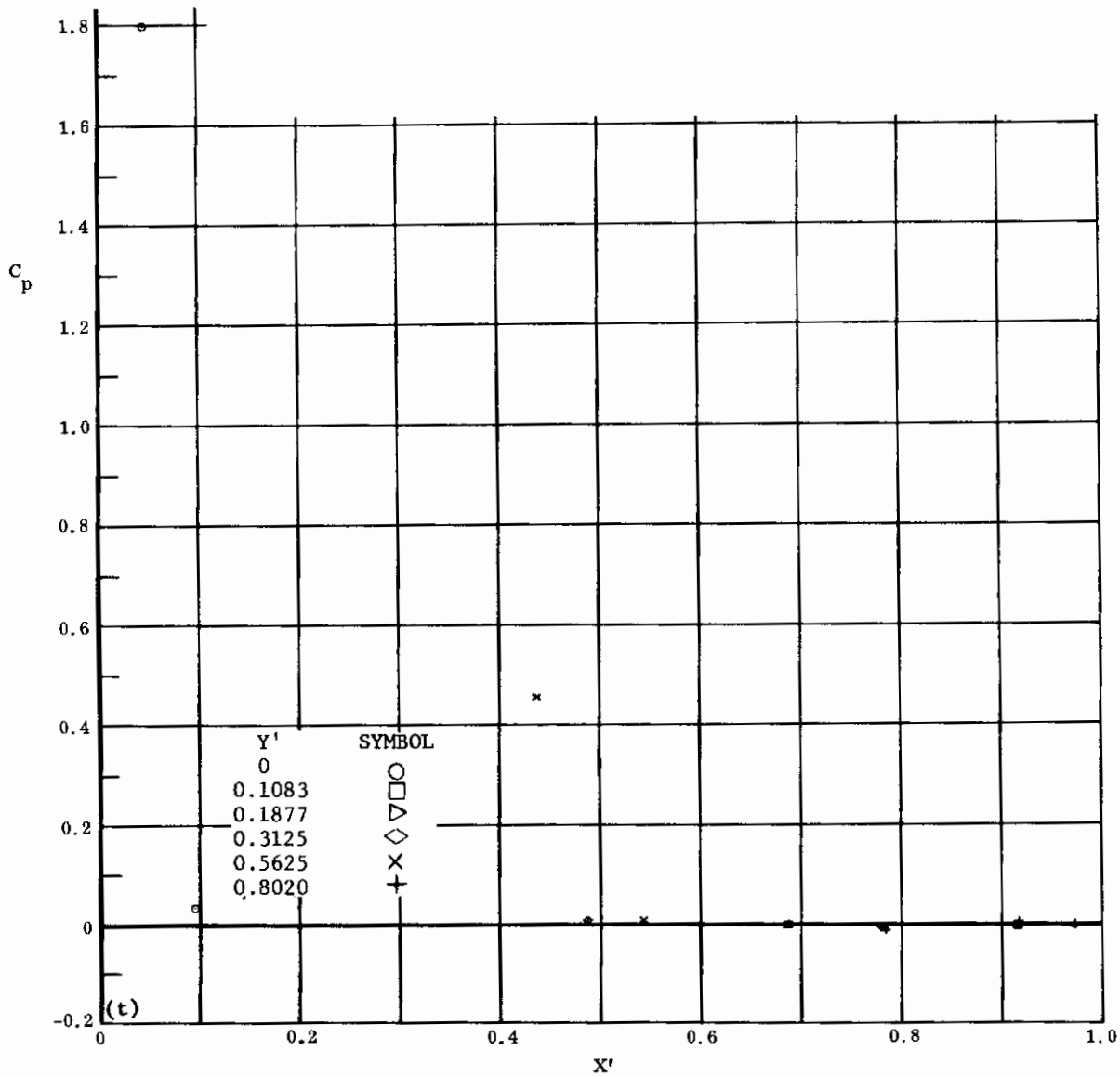
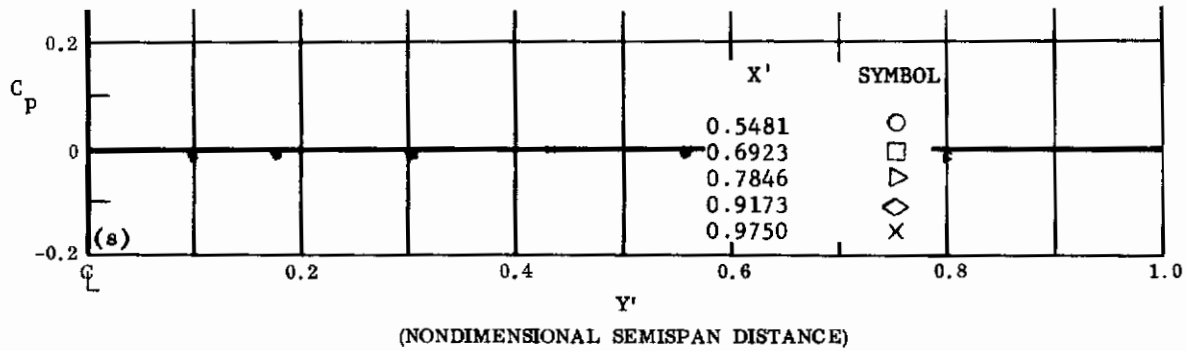

Fig. 5 Configuration I, $\alpha = +10$, $\delta_2 = \delta_3 = +39$

s) C_p vs. Y' , upper surface

t) C_p vs. X' , upper surface

Contrails

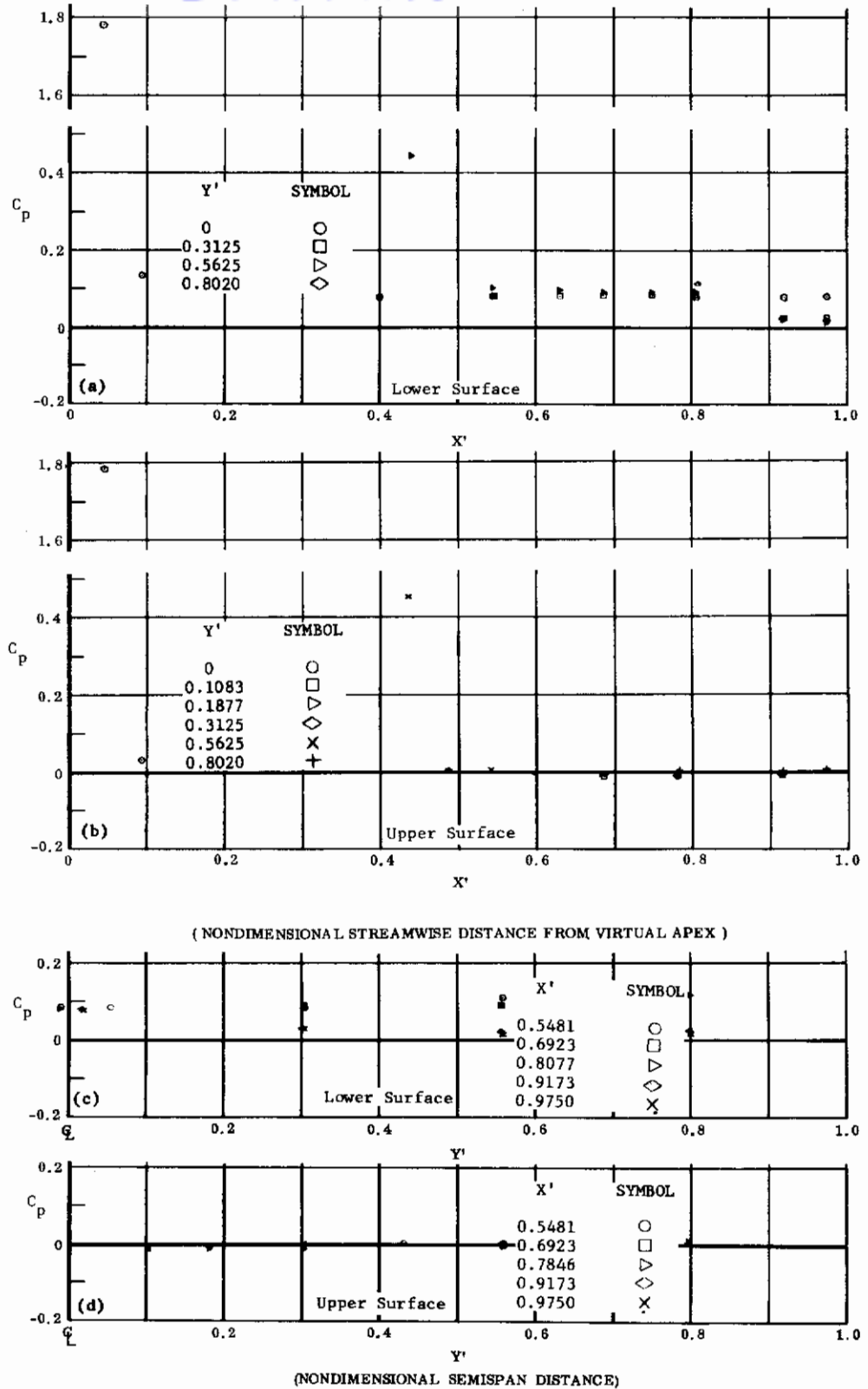

Fig. 6 Configuration I, $\alpha = +10$, $\delta_2 = \delta_3 = -10$

- a) C_p vs. X' , lower surface
- b) C_p vs. X' , upper surface
- c) C_p vs. Y' , lower surface
- d) C_p vs. Y' , upper surface

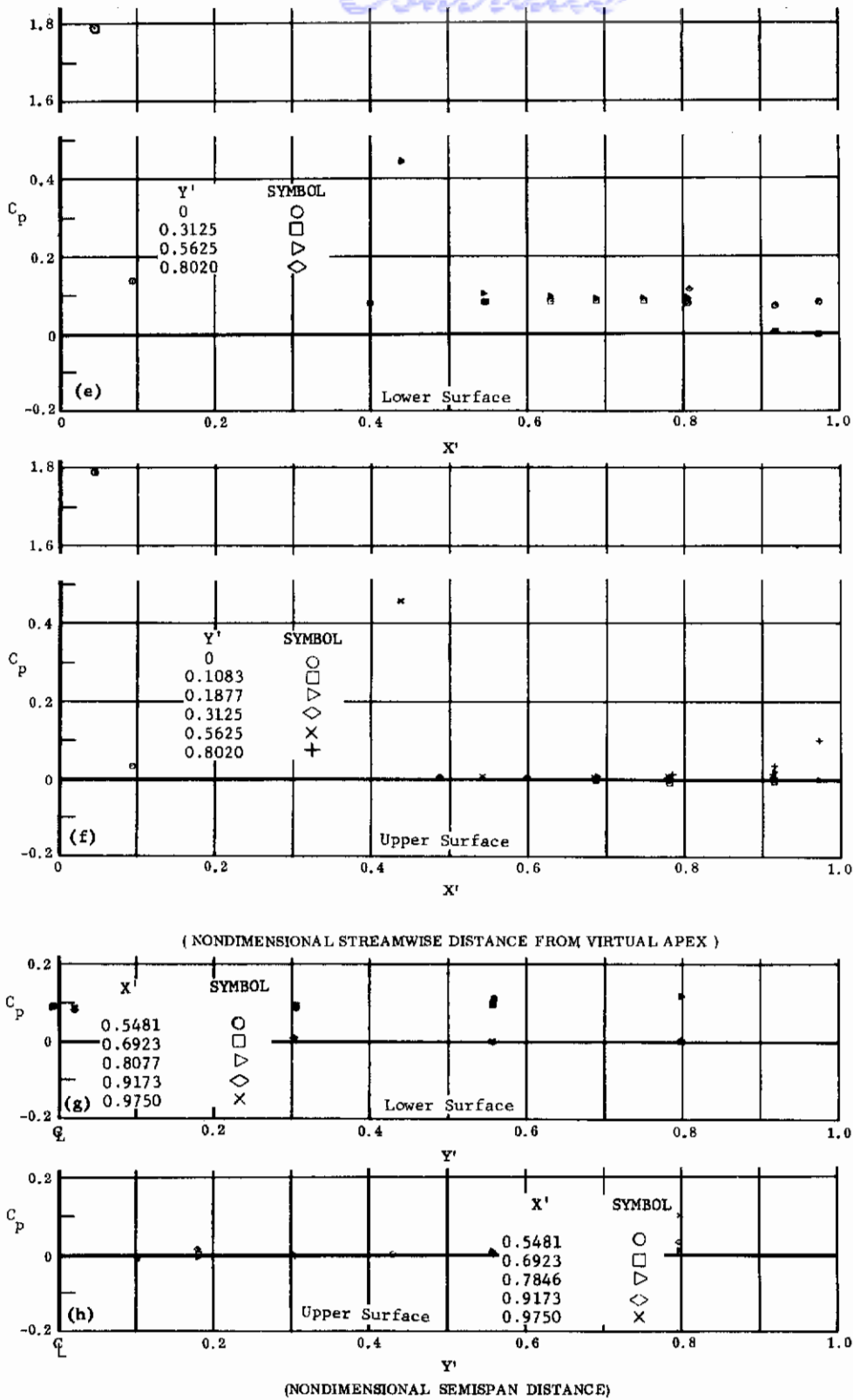

Fig. 6 Configuration I, $\alpha = +10$, $\delta_2 = \delta_3 = -20$

- e) C_p vs. X' , lower surface
- f) C_p vs. X' , upper surface
- g) C_p vs. Y' , lower surface
- h) C_p vs. Y' , upper surface

Contrails

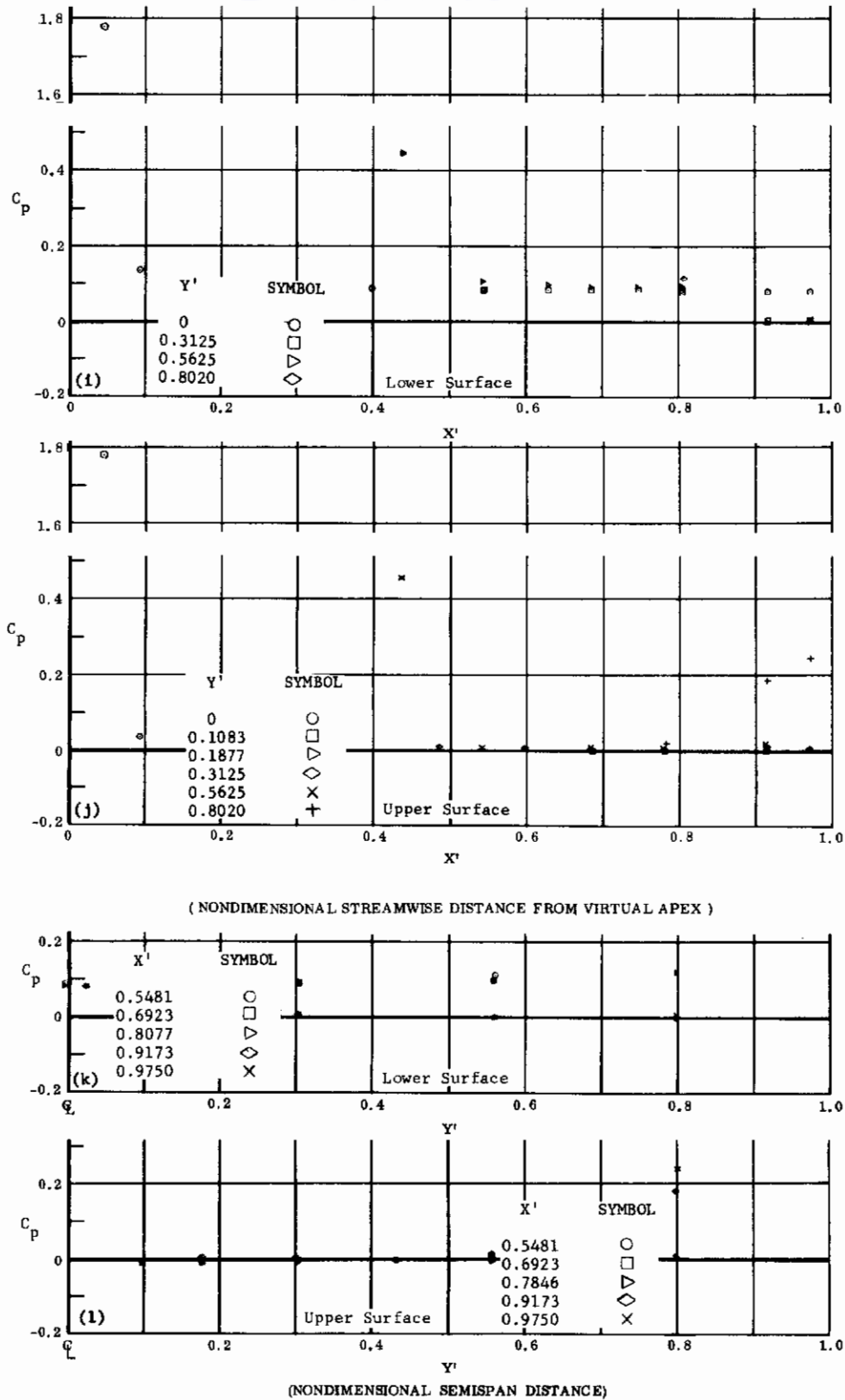
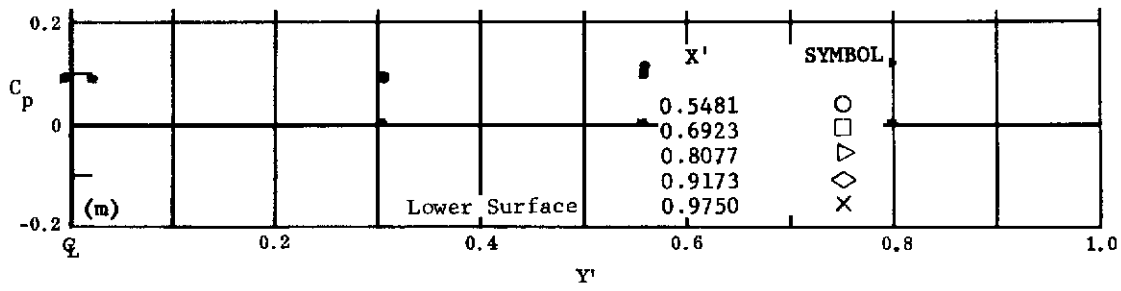

Fig. 6 Configuration I, $\alpha = +10^\circ$, $\delta_2 = \delta_3 = -30^\circ$

- i) C_p vs. X' , lower surface
- j) C_p vs. X' , upper surface
- k) C_p vs. Y' , lower surface
- l) C_p vs. Y' , upper surface

Contrails



(NONDIMENSIONAL SEMISPAN DISTANCE)

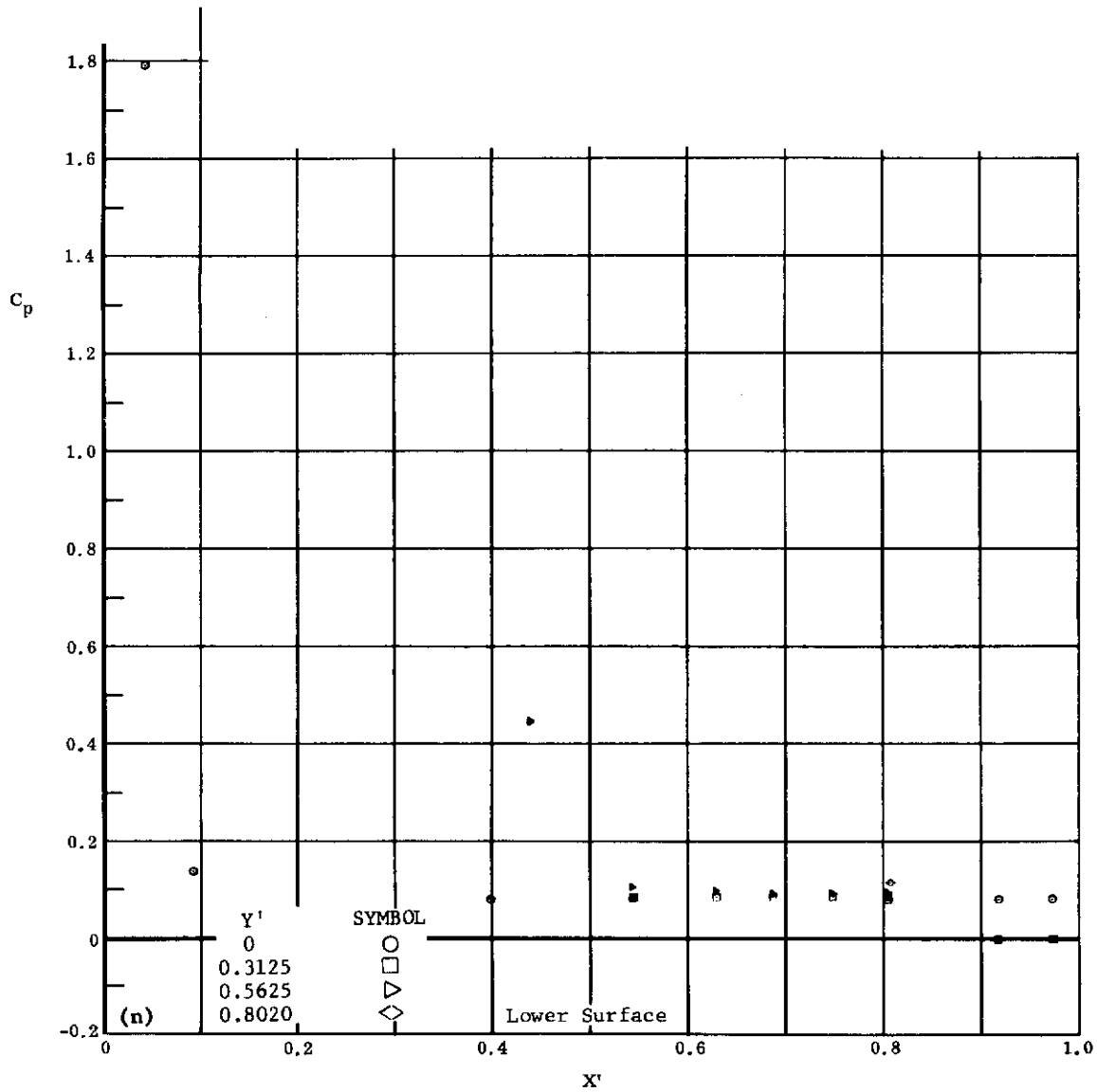

(NONDIMENSIONAL STREAMWISE DISTANCE FROM VIRTUAL APEX)

Fig. 6 Configuration I, $\alpha = +10$, $\delta_2 = \delta_3 = -39$

m) C_p vs. Y' , lower surface

n) C_p vs. X' , lower surface

Contrails

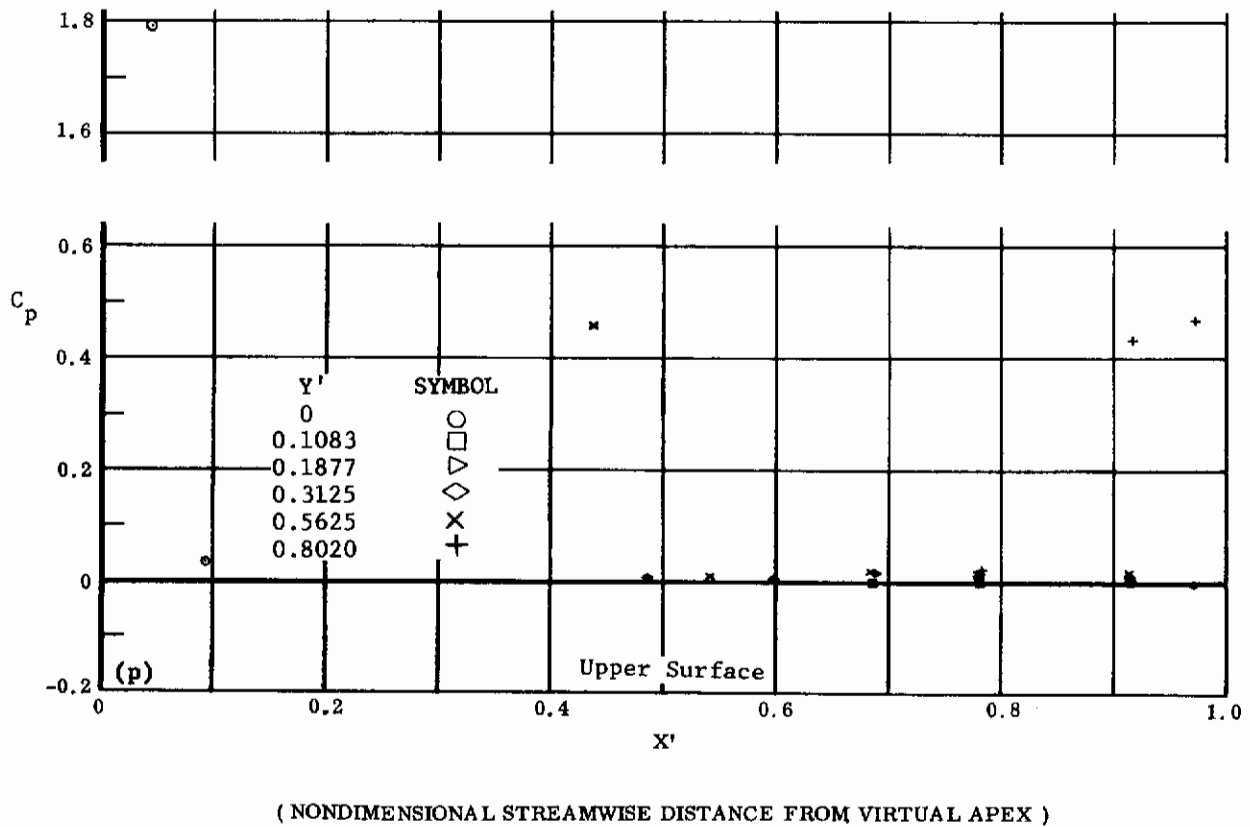
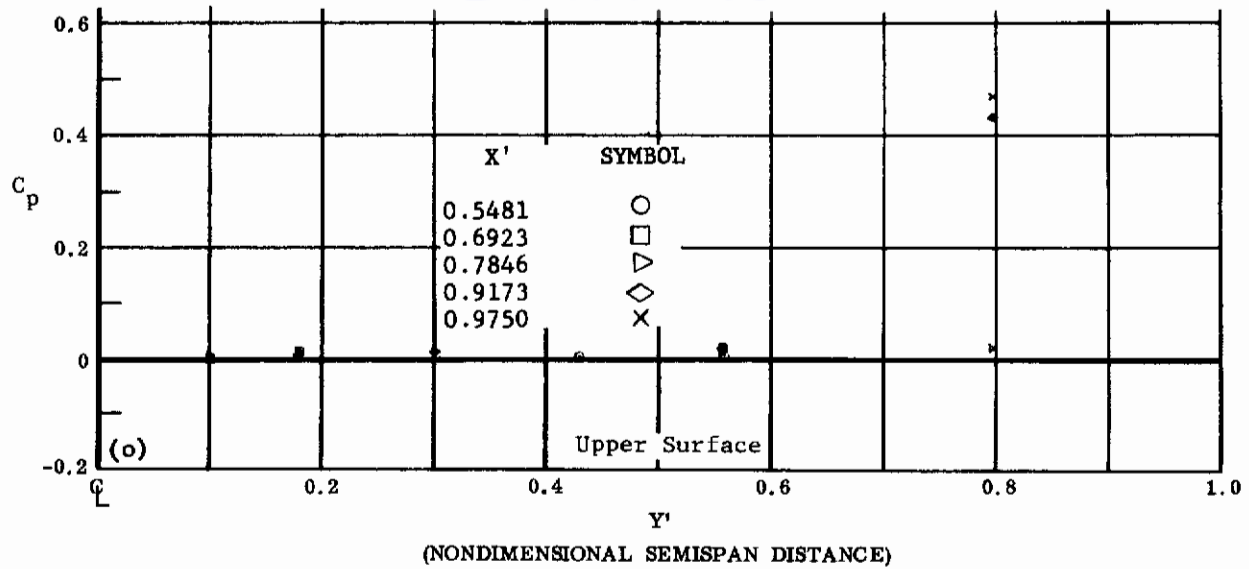

Fig. 6 Configuration I, $\alpha = +10$, $\delta_2 = \delta_3 = -39$

o) C_p vs. Y' , upper surface

p) C_p vs. X' , upper surface

Contrails

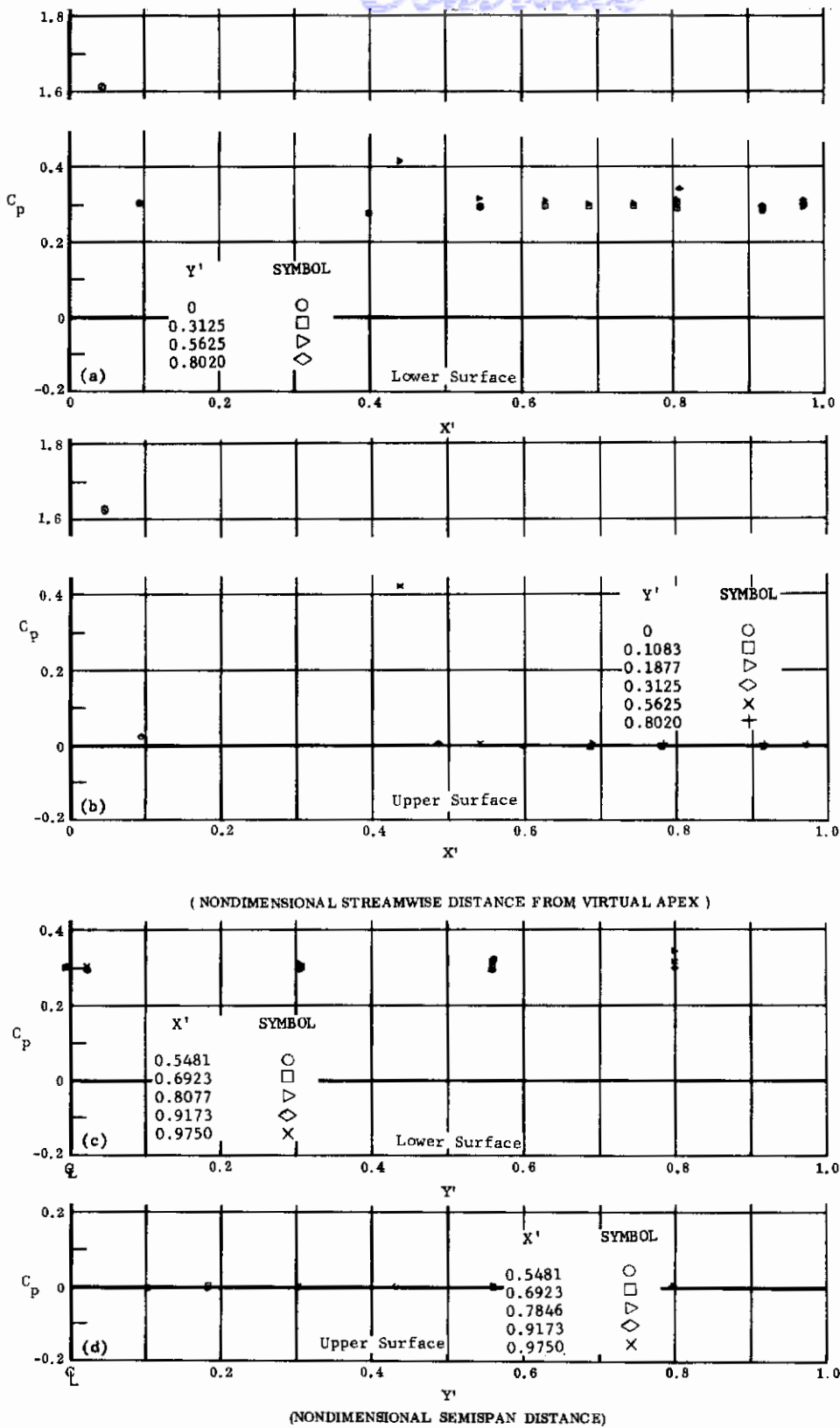
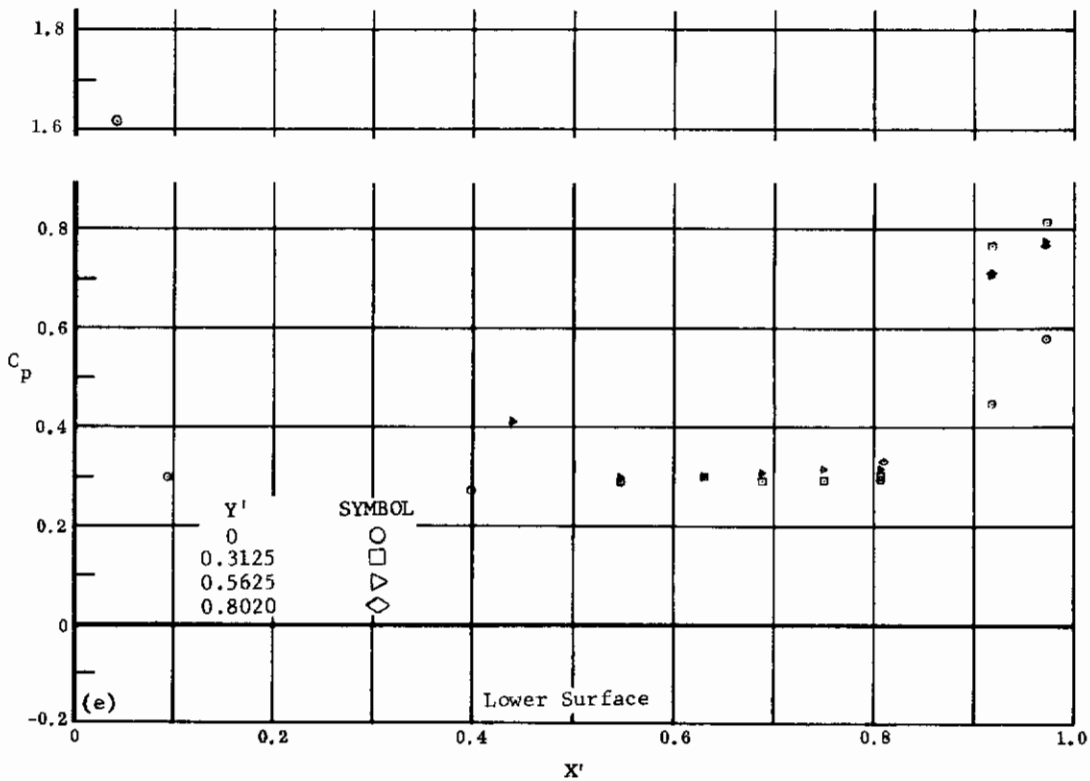

Fig. 7 Configuration I, $\alpha = +20$, $b_2 = b_3 = 0$

- a) C_p vs. X' , lower surface
- b) C_p vs. X' , upper surface
- c) C_p vs. Y' , lower surface
- d) C_p vs. Y' , upper surface

Contrails



(NONDIMENSIONAL STREAMWISE DISTANCE FROM VIRTUAL APEX)

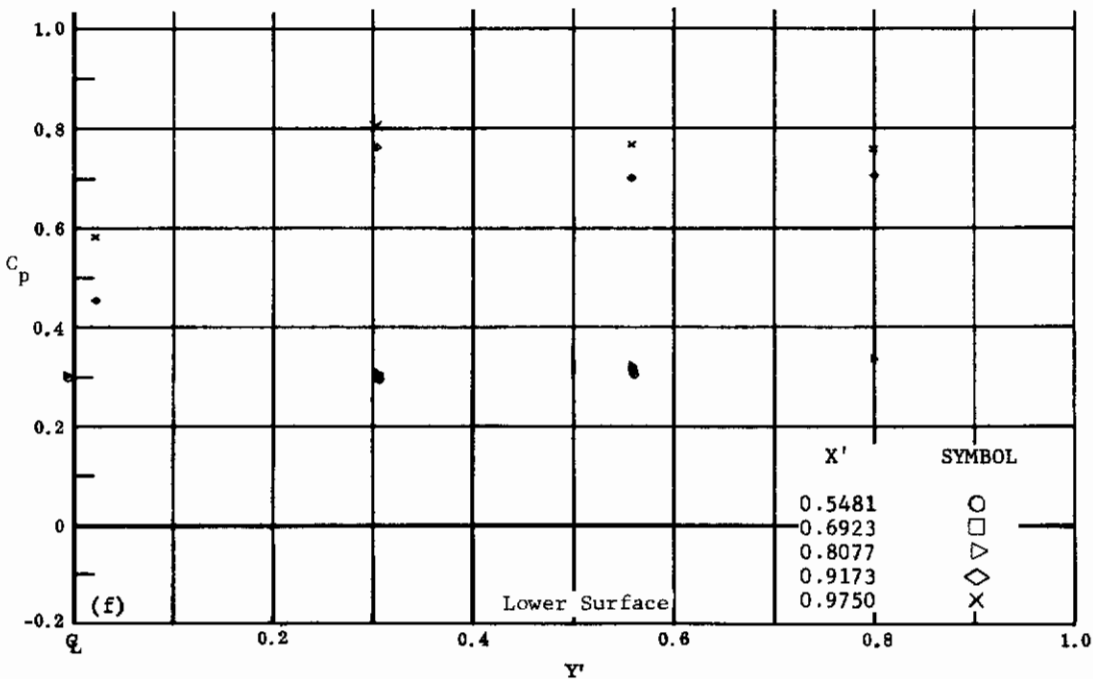

(NONDIMENSIONAL SEMISPAN DISTANCE)

Fig. 7 Configuration I, $\alpha = +20$, $\delta_2 = \delta_3 = +10$

e) C_p vs. X' , lower surface

f) C_p vs. Y' , lower surface

Contrails

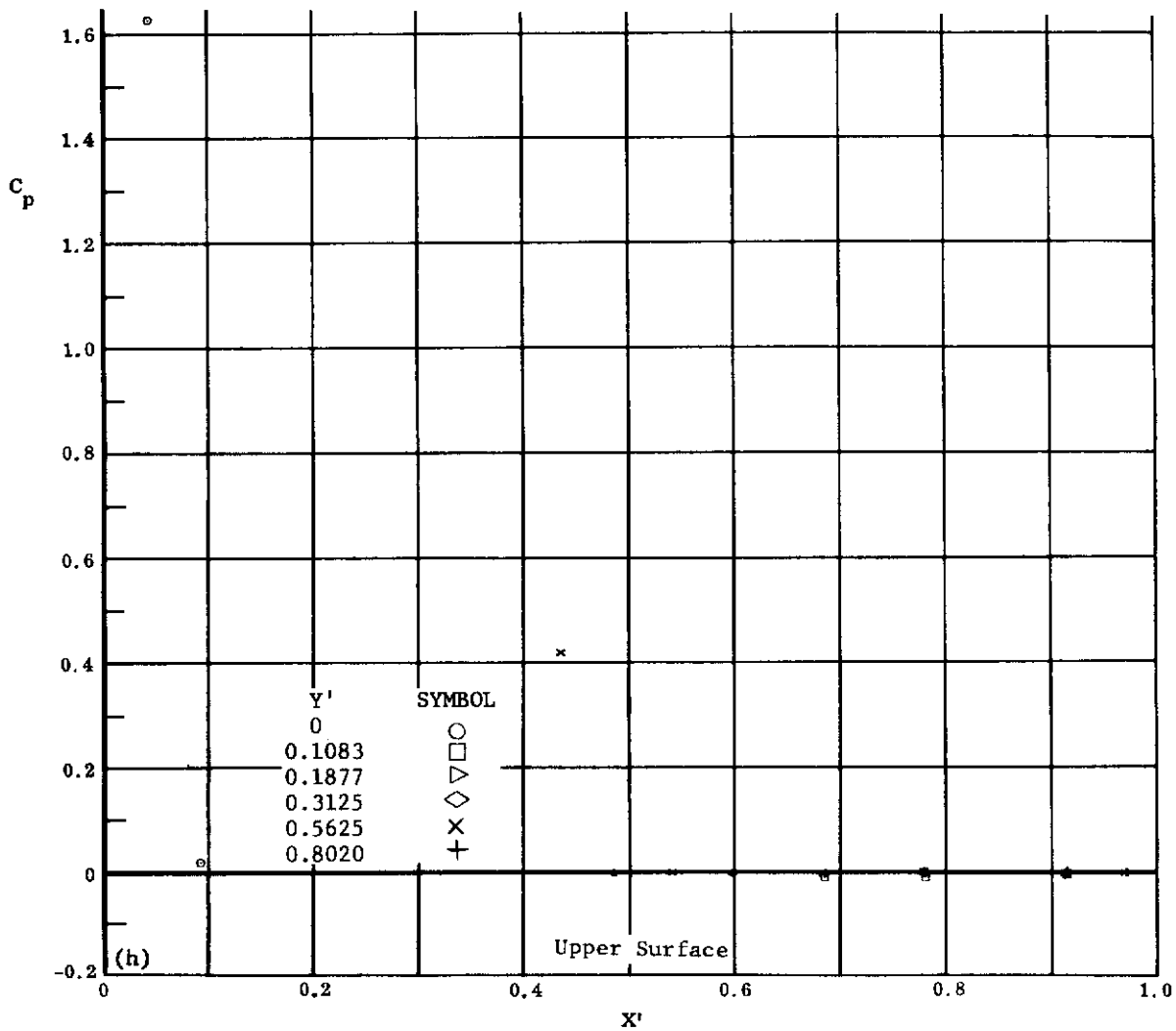
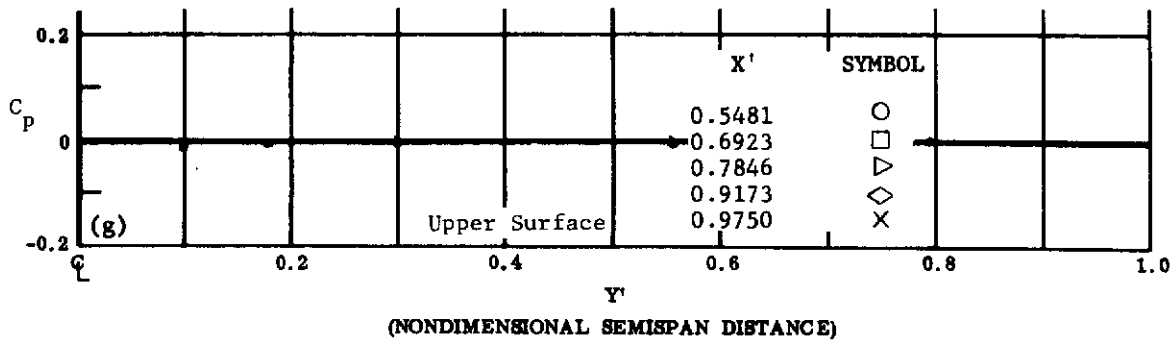
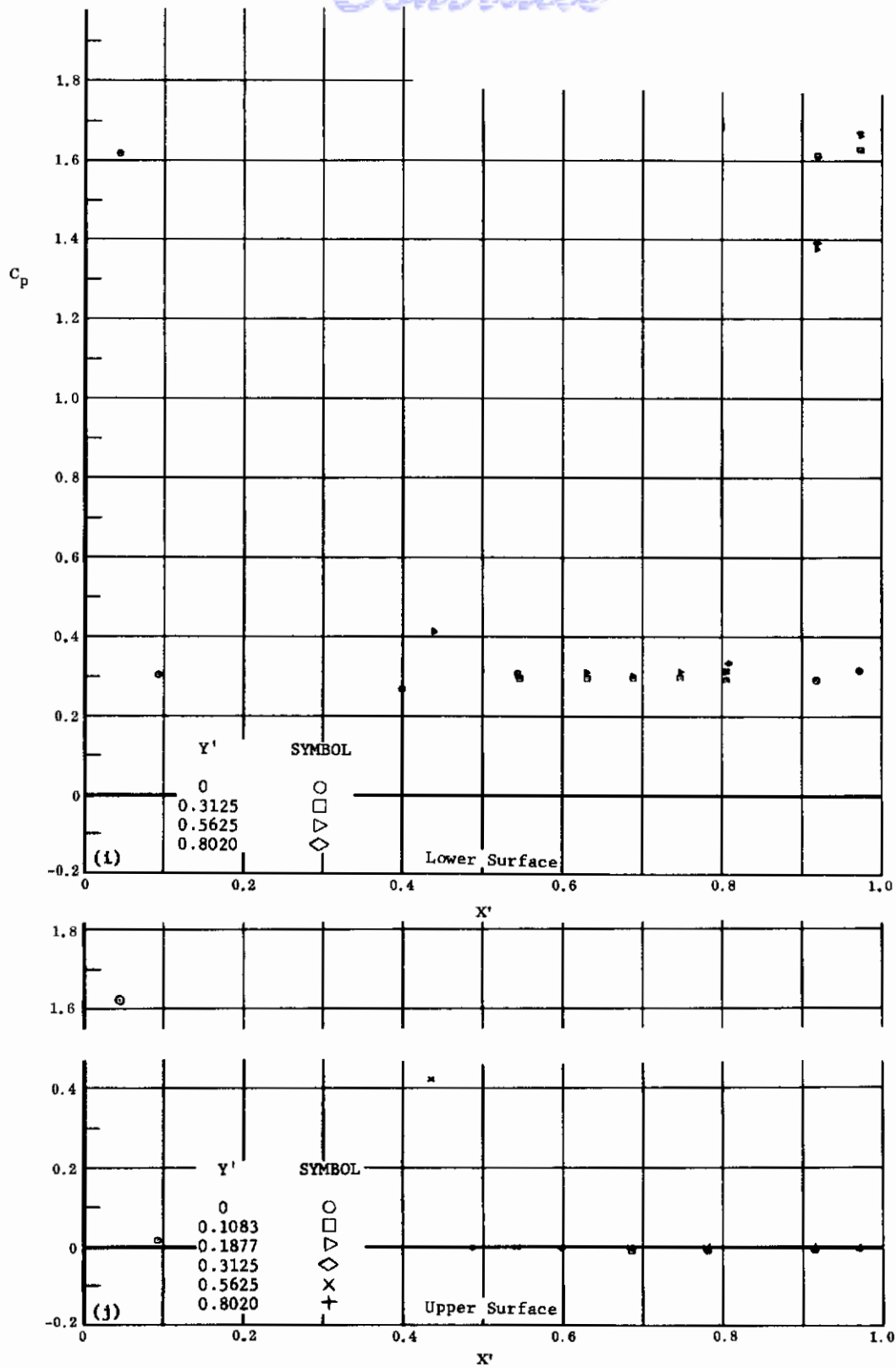

Fig. 7 Configuration I, $\alpha = +20$, $\delta_2 = \delta_3 = +10$

g) C_p vs. Y' , upper surface

h) C_p vs. X' , upper surface



(NONDIMENSIONAL STREAMWISE DISTANCE FROM VIRTUAL APEX)

Fig. 7 Configuration I, $\alpha = +20$, $\delta_2 = \delta_3 = +20$

i) C_p vs. X' , lower surface

j) C_p vs. X' , upper surface

Contrails

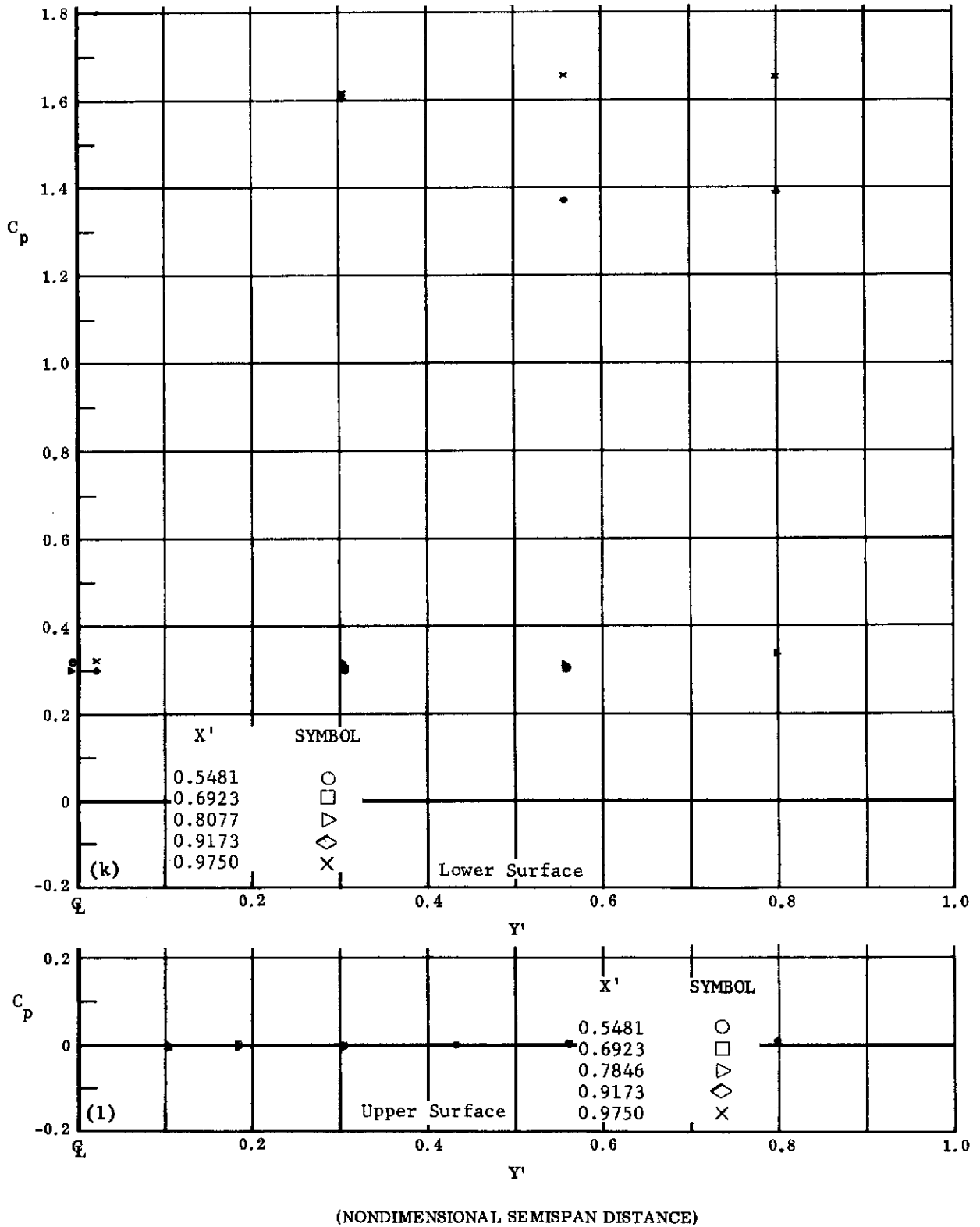

Fig. 7 Configuration I, $\alpha = +20$, $\delta_2 = \delta_3 = +20$

k) C_p vs. Y' , lower surface

l) C_p vs. Y' , upper surface

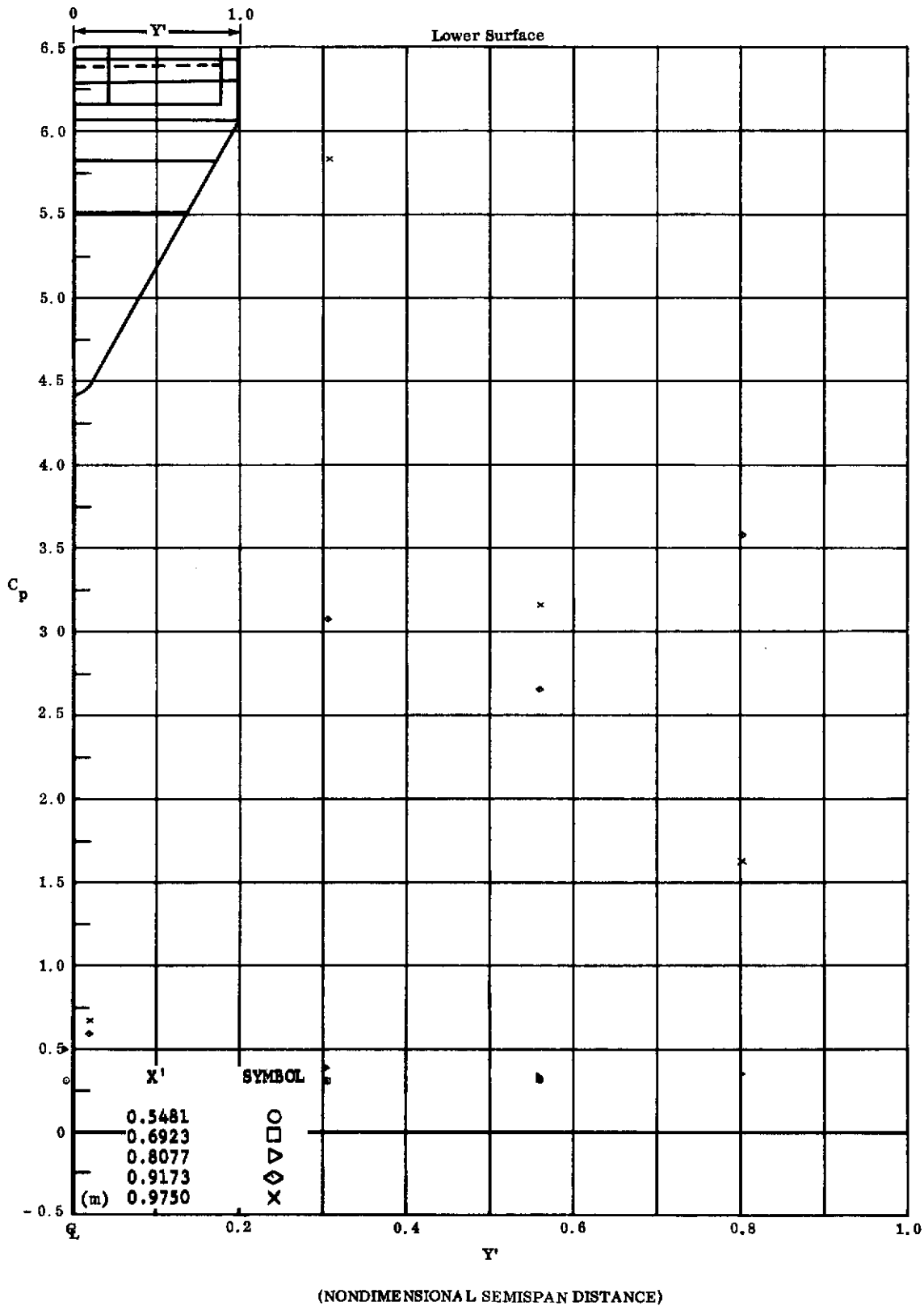
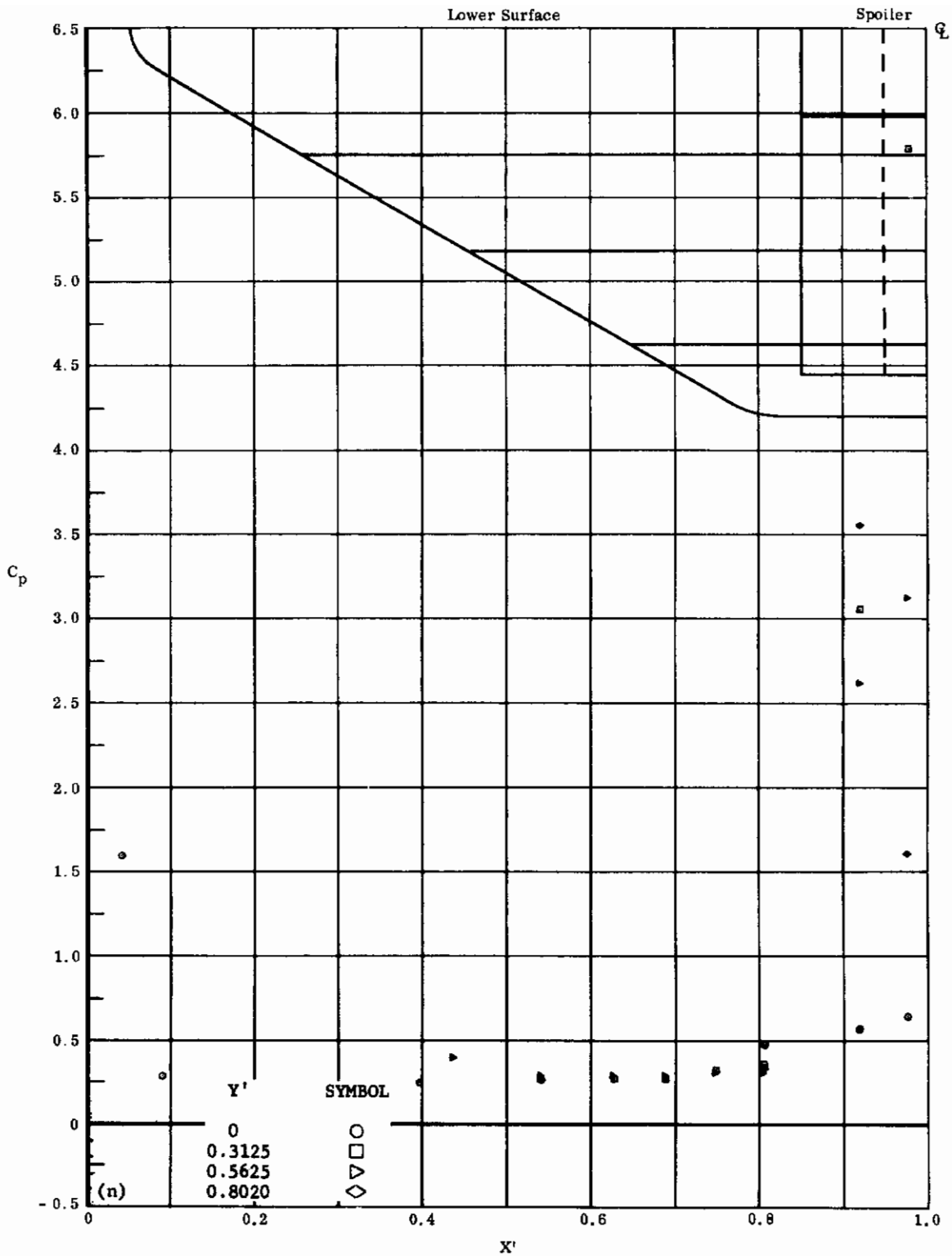

Fig. 7m Configuration I, $\alpha = +20$, $\delta_2 = \delta_3 = +30$

C_p vs. Y' , lower surface



(NONDIMENSIONAL STREAMWISE DISTANCE FROM VIRTUAL APEX)

Fig. 7n Configuration I, $\alpha = +20$, $\delta_2 = \delta_3 = +30$

C_p vs. X' , lower surface

Contrails

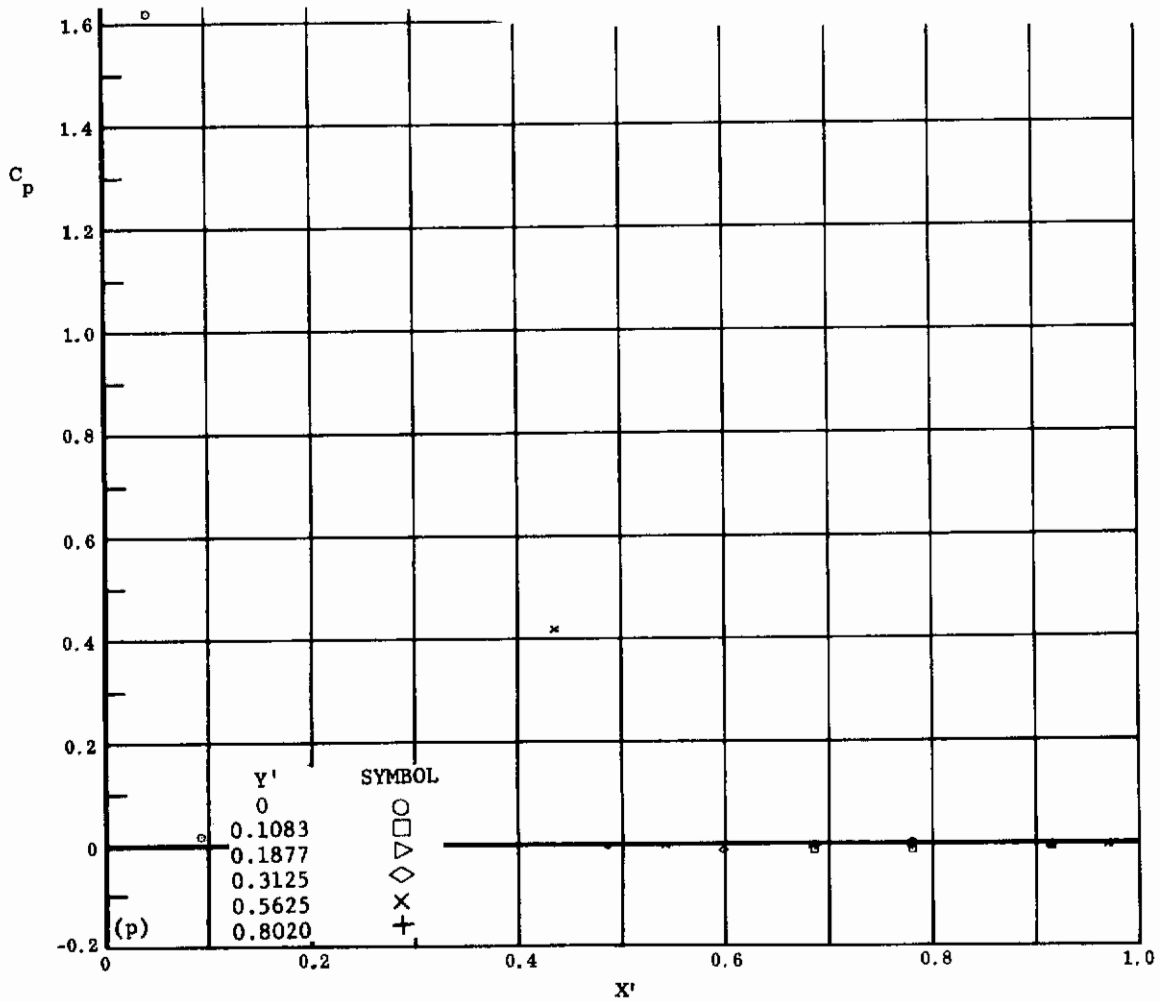
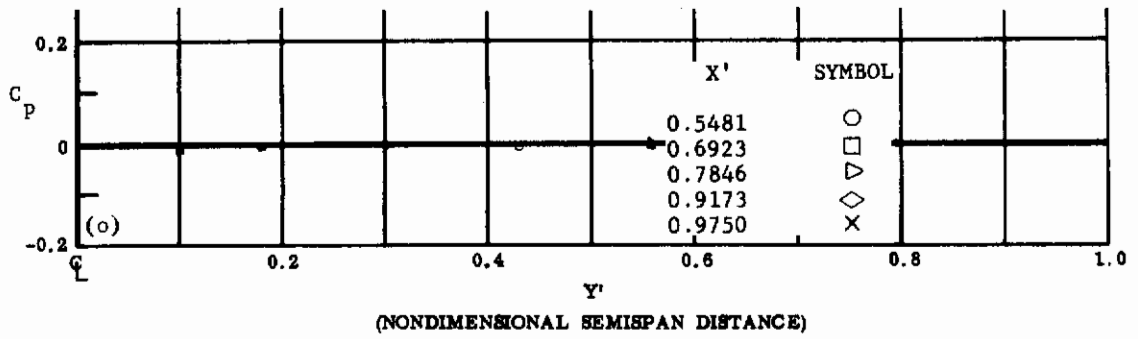

Fig. 7 Configuration I, $\alpha = +20$, $\delta_2 = \delta_3 = +30$

- o) C_p vs. Y' , upper surface
- p) C_p vs. X' , upper surface

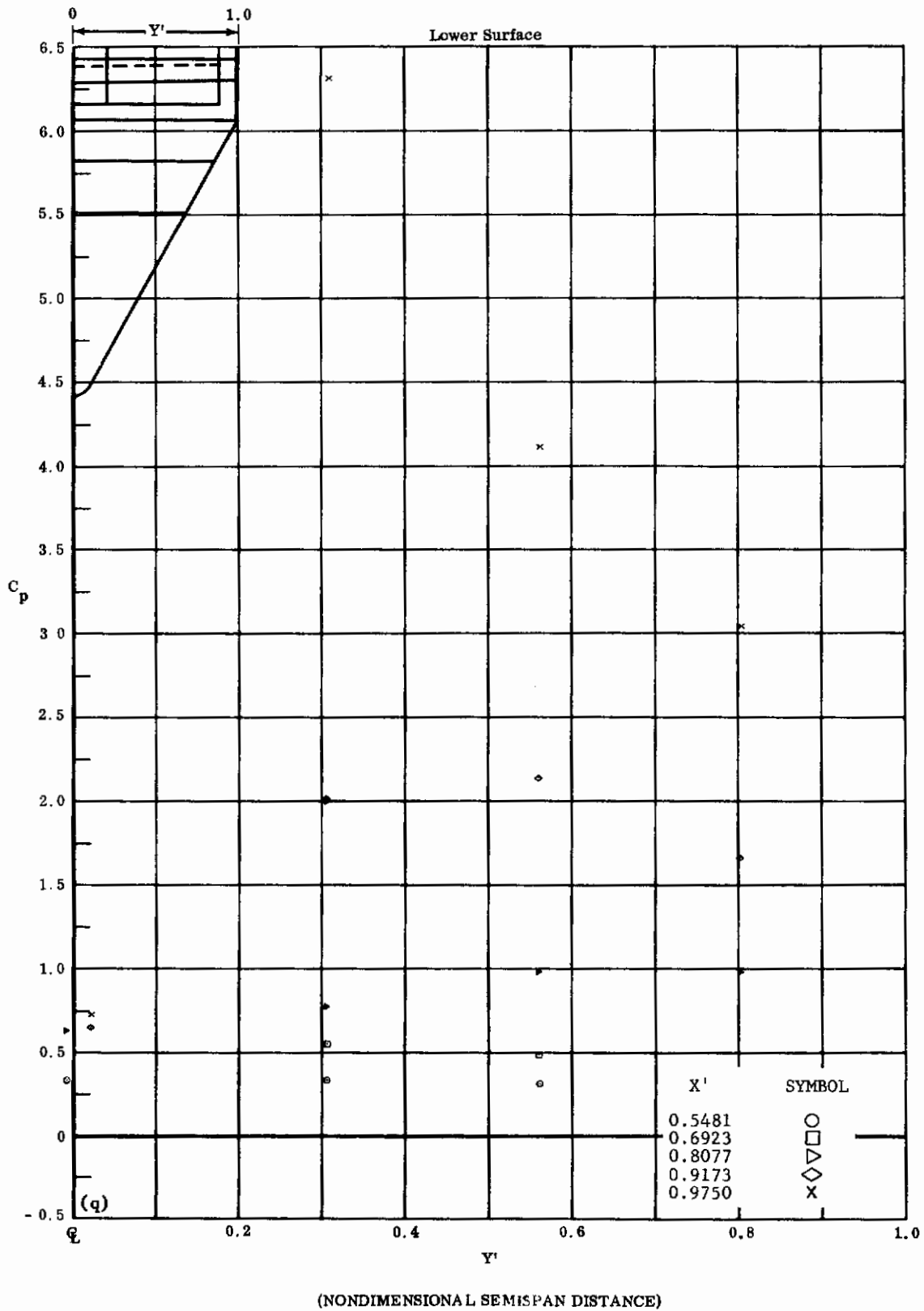
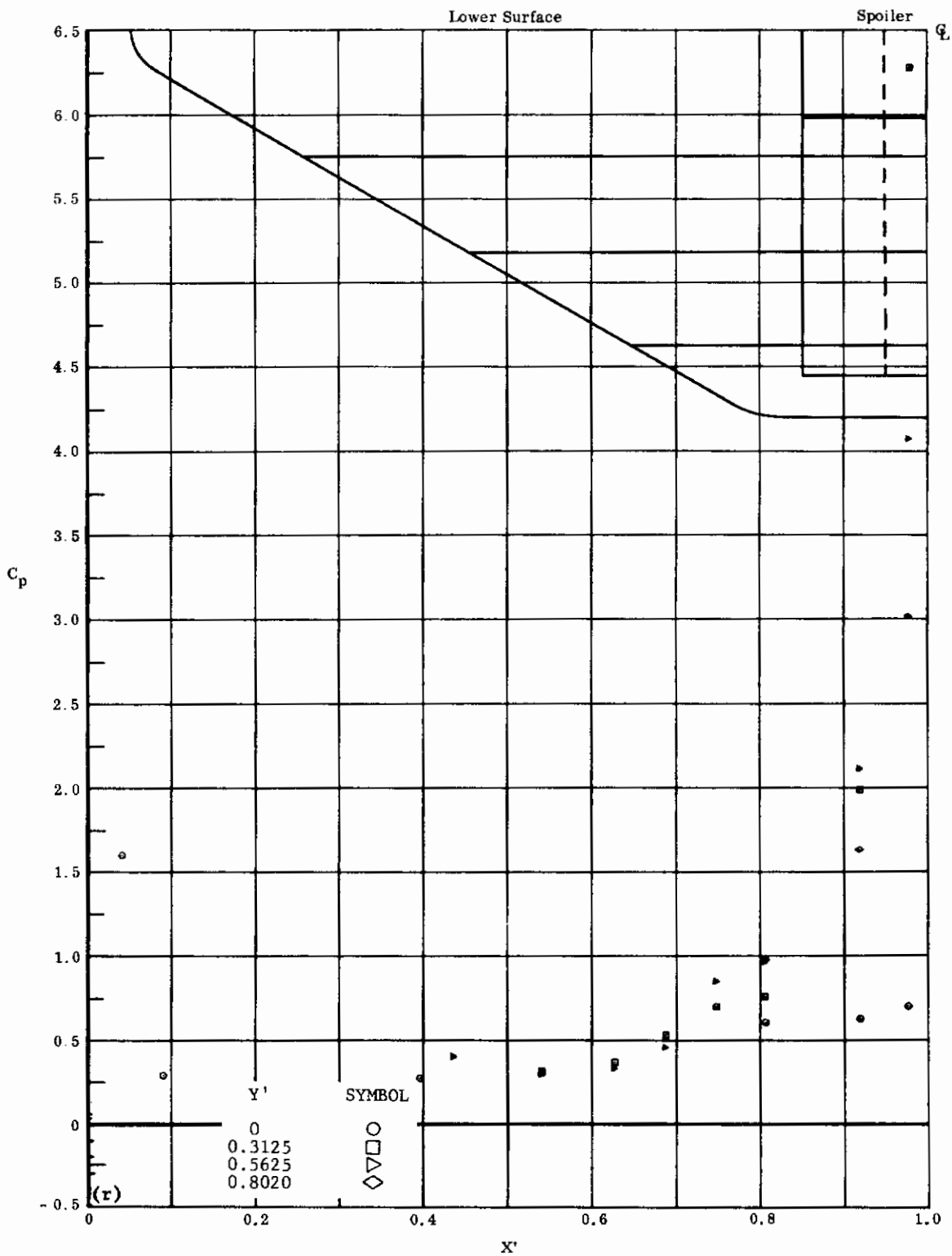

Fig. 7q Configuration I, $\alpha = +20$, $\delta_2 = \delta_3 = +39$

C_p vs. Y' , lower surface



(NONDIMENSIONAL STREAMWISE DISTANCE FROM VIRTUAL APEX)

Fig. 7r Configuration I, $\alpha = +20$, $\delta_2 = \delta_3 = +39$

C_p vs. X' , lower surface

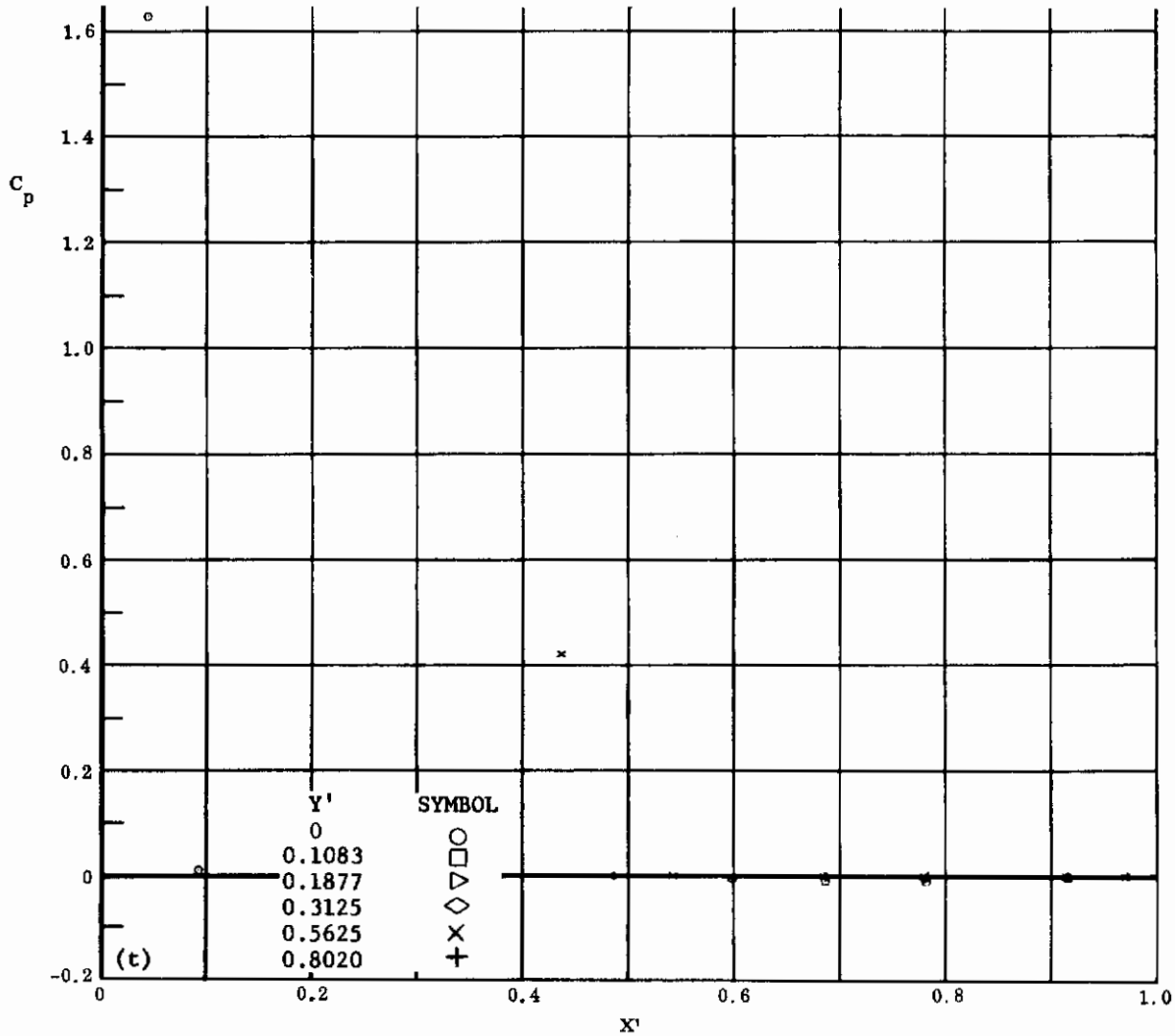
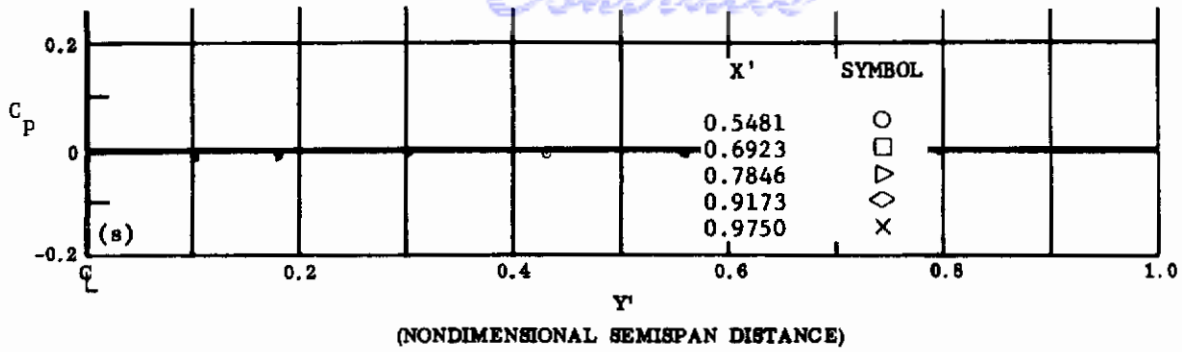

(NONDIMENSIONAL STREAMWISE DISTANCE FROM VIRTUAL APEX)

Fig. 7 Configuration I, $\alpha = +20$, $\delta_2 = \delta_3 = +39$

s) C_p vs. Y' , upper surface

t) C_p vs. X' , upper surface

Contrails

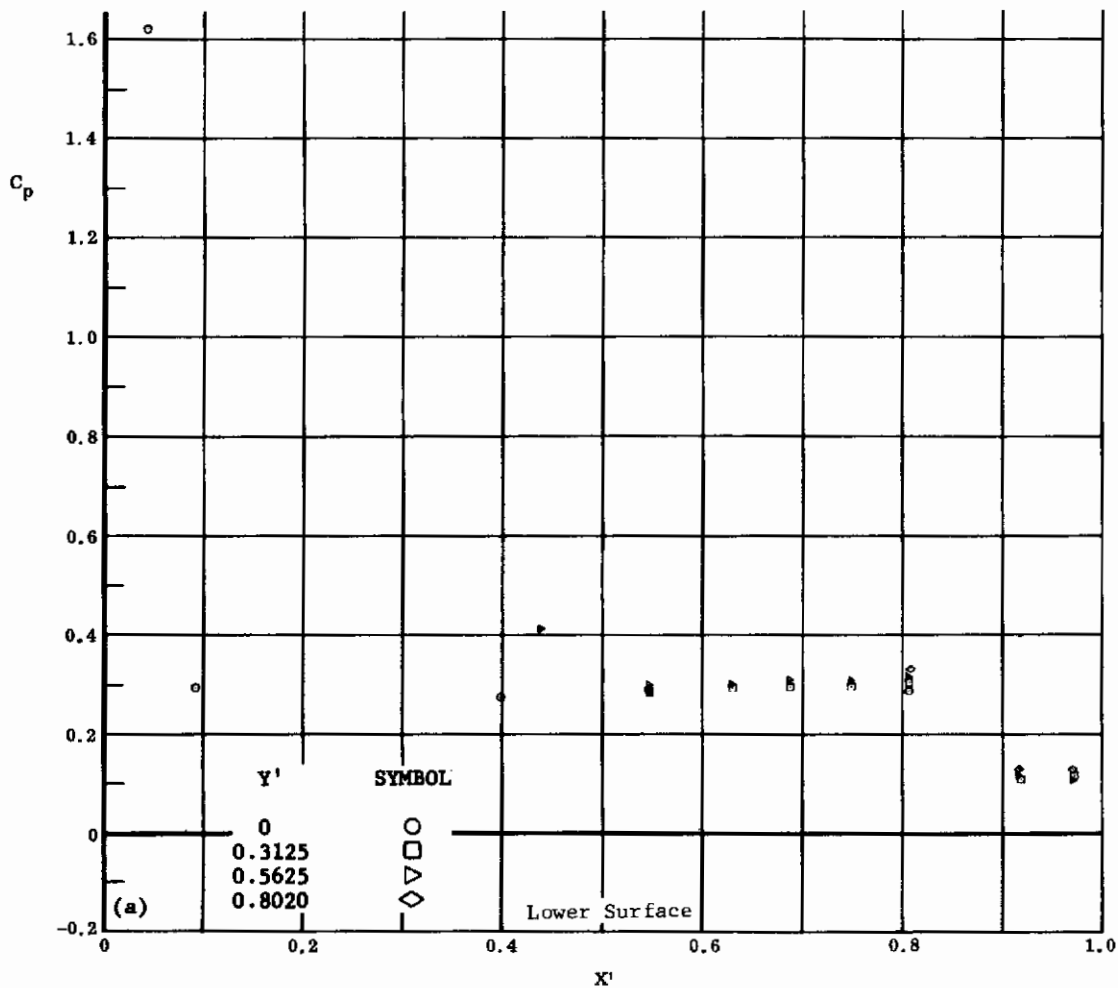

(NONDIMENSIONAL STREAMWISE DISTANCE FROM VIRTUAL APEX)

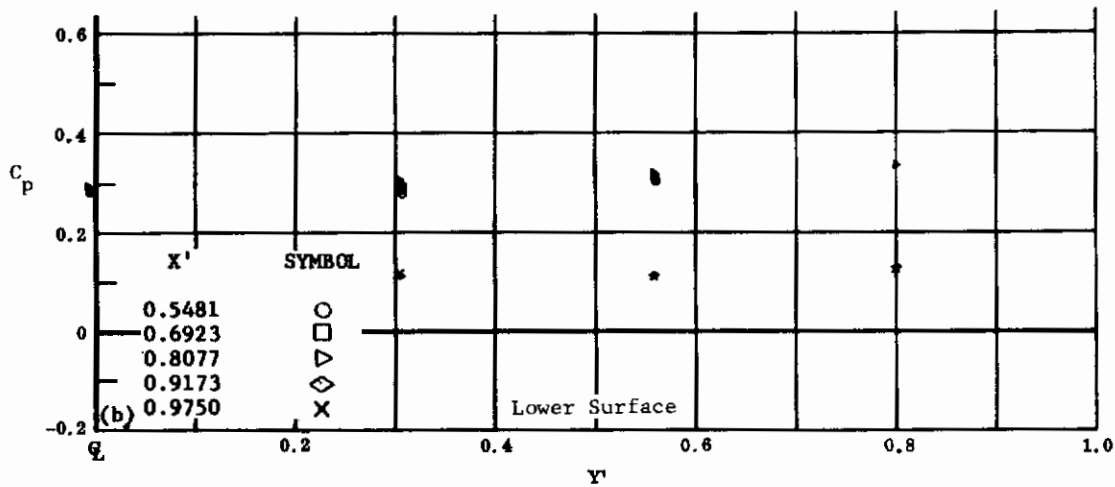

(NONDIMENSIONAL SEMISPAN DISTANCE)

Fig. 8 Configuration I, $\alpha = +20$, $\delta_2 = \delta_3 = -10$

a) C_p vs. X' , lower surface

b) C_p vs. Y' , lower surface

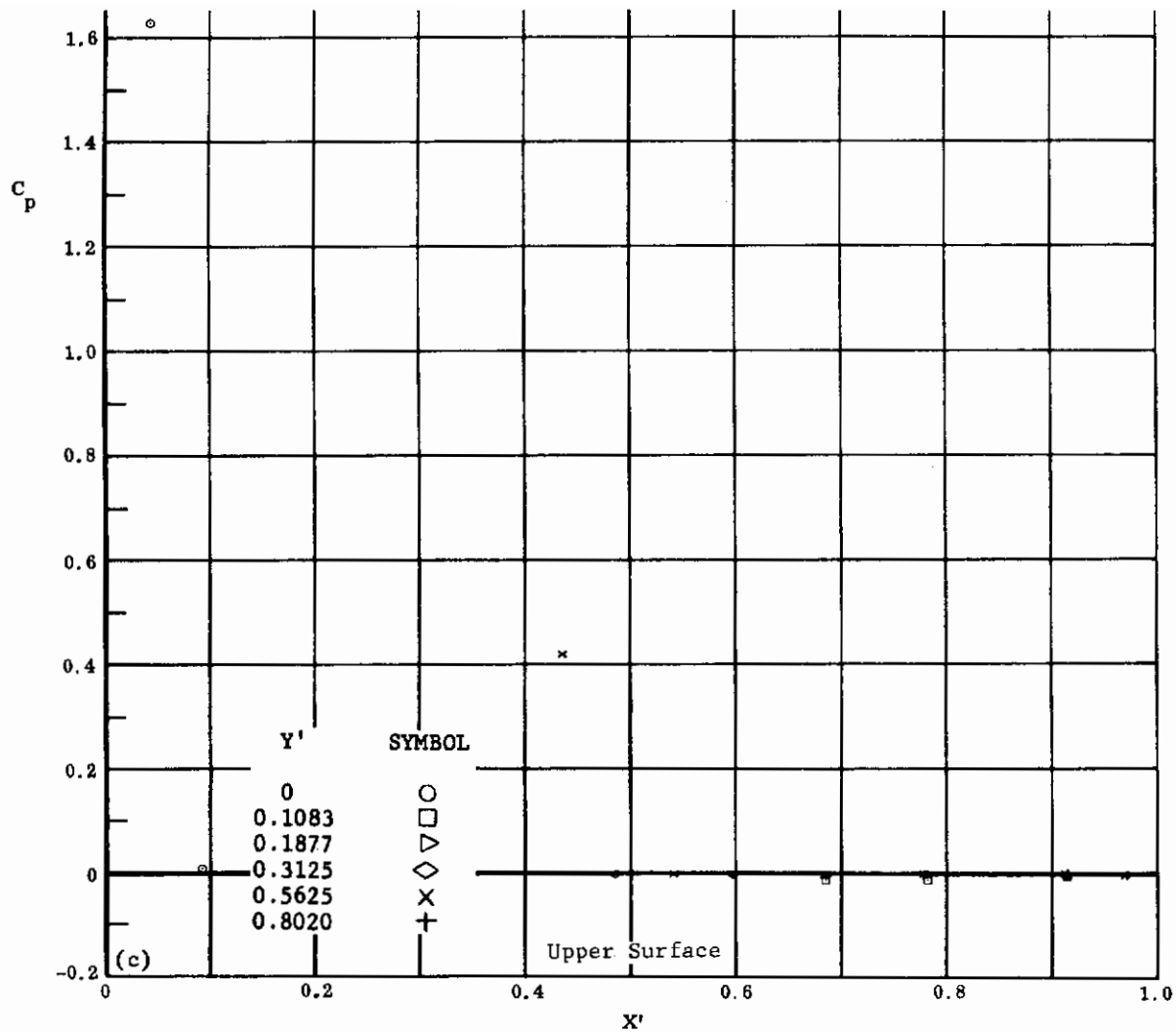

(NONDIMENSIONAL STREAMWISE DISTANCE FROM VIRTUAL APEX)

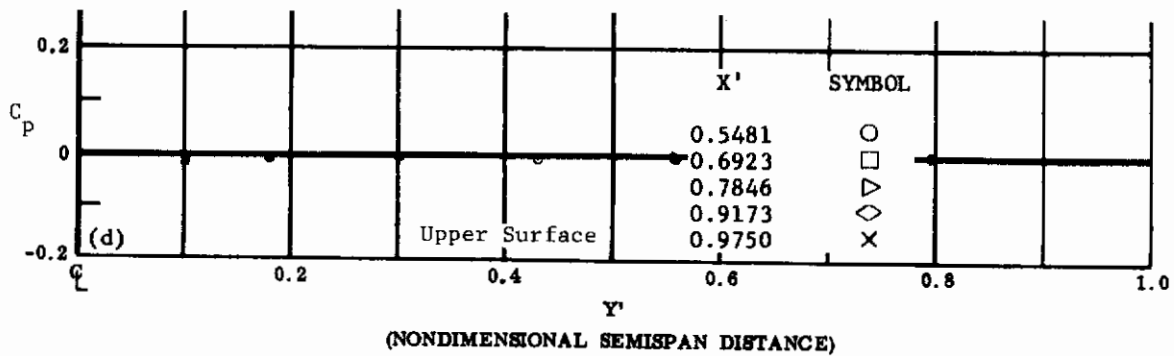

(NONDIMENSIONAL SEMISPAN DISTANCE)

Fig. 8 Configuration I, $\alpha = +20$, $\delta_2 = \delta_3 = -10$

c) C_p vs. X' , upper surface

d) C_p vs. Y' , upper surface

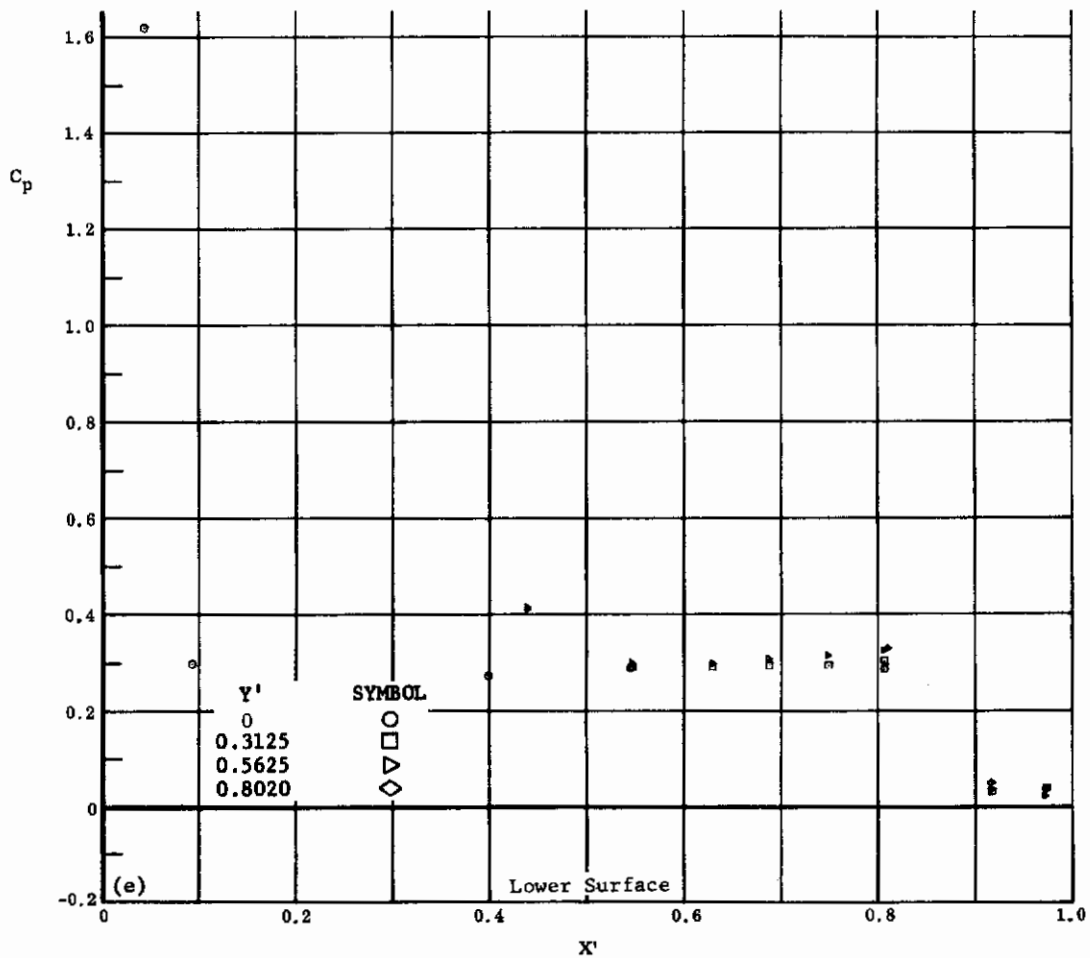

(NONDIMENSIONAL STREAMWISE DISTANCE FROM VIRTUAL APEX)

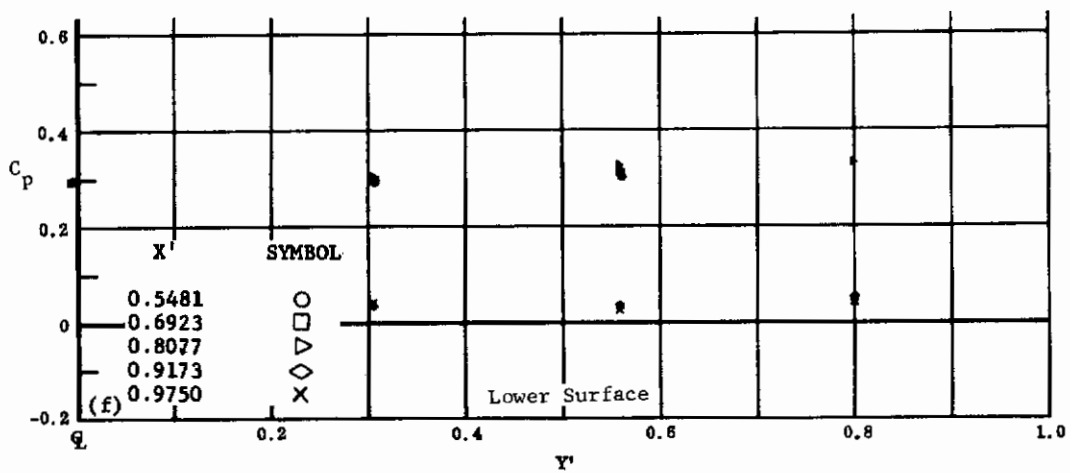

(NONDIMENSIONAL SEMISPAN DISTANCE)

Fig. 8 Configuration I, $\alpha = +20$, $\delta_2 = \delta_3 = -20$

e) C_p vs. X' , lower surface

f) C_p vs. Y' , lower surface

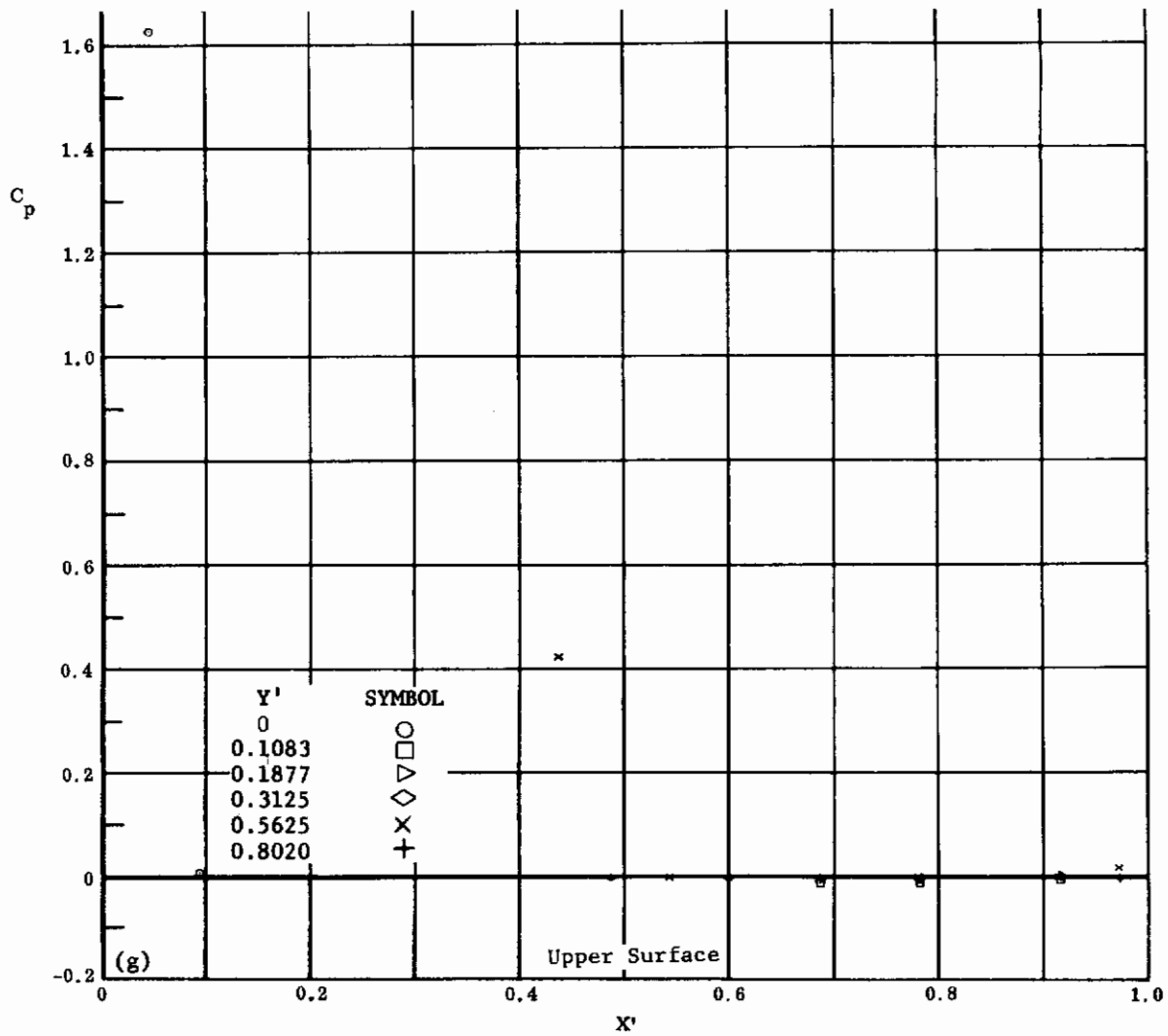

(NONDIMENSIONAL STREAMWISE DISTANCE FROM VIRTUAL APEX)

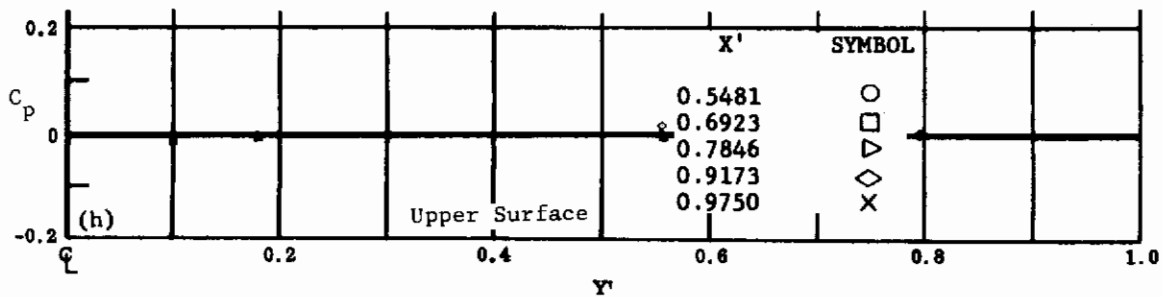

(NONDIMENSIONAL SEMISPAN DISTANCE)

Fig. 8 Configuration I, $\alpha = +20$, $\delta_2 = \delta_3 = -20$

g) C_p vs. X', upper surface

h) C_p vs. Y', upper surface

Contrails

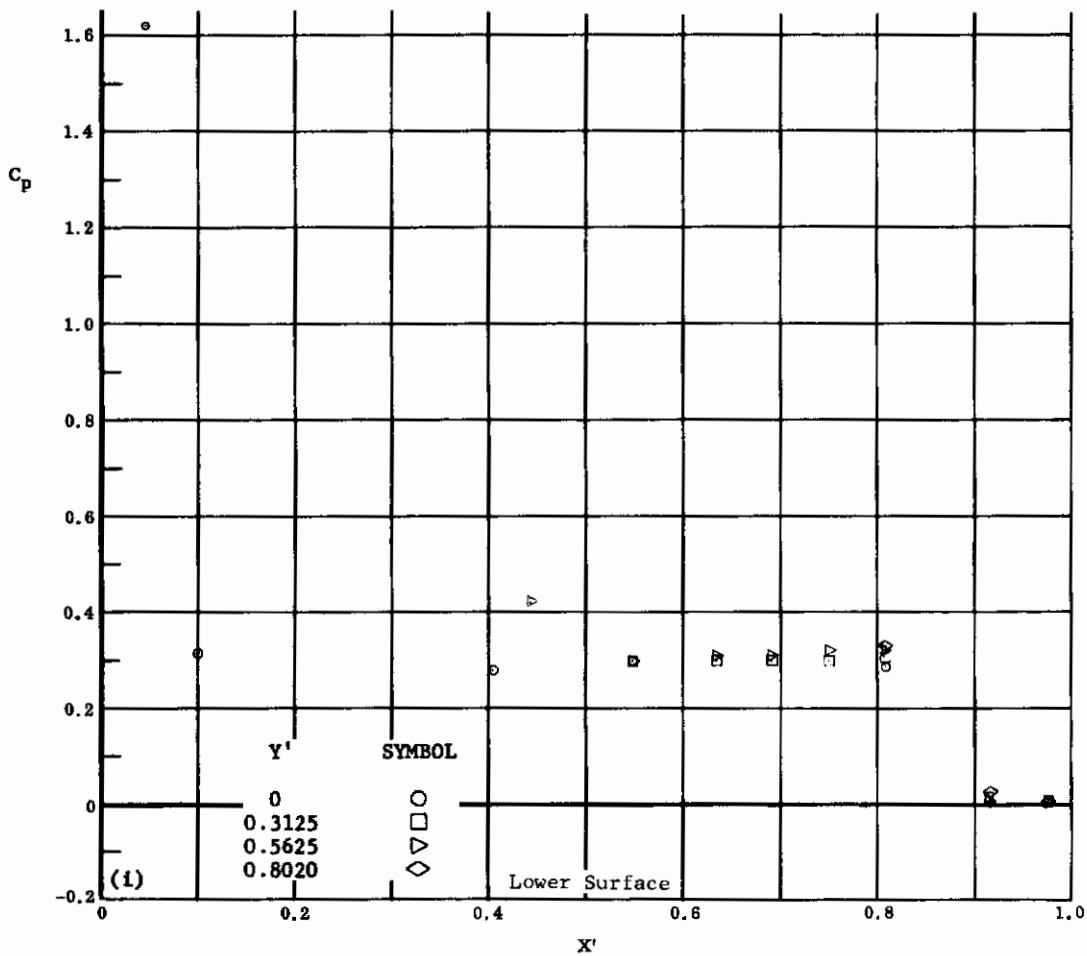

(NONDIMENSIONAL STREAMWISE DISTANCE FROM VIRTUAL APEX)

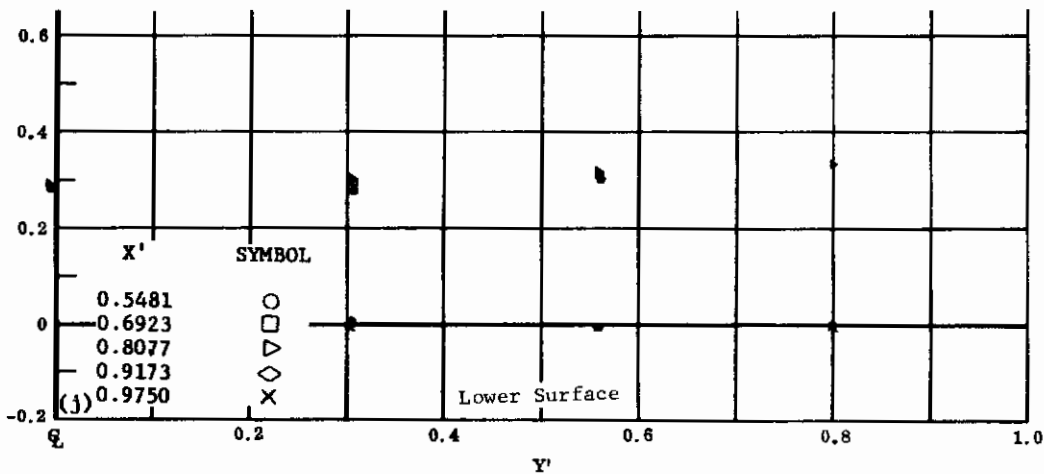

(NONDIMENSIONAL SEMISPAN DISTANCE)

Fig. 8 Configuration I, $\alpha = +20$, $\delta_2 = \delta_3 = -30$

i) C_p vs. X' , lower surface

j) C_p vs. Y' , lower surface

Contrails

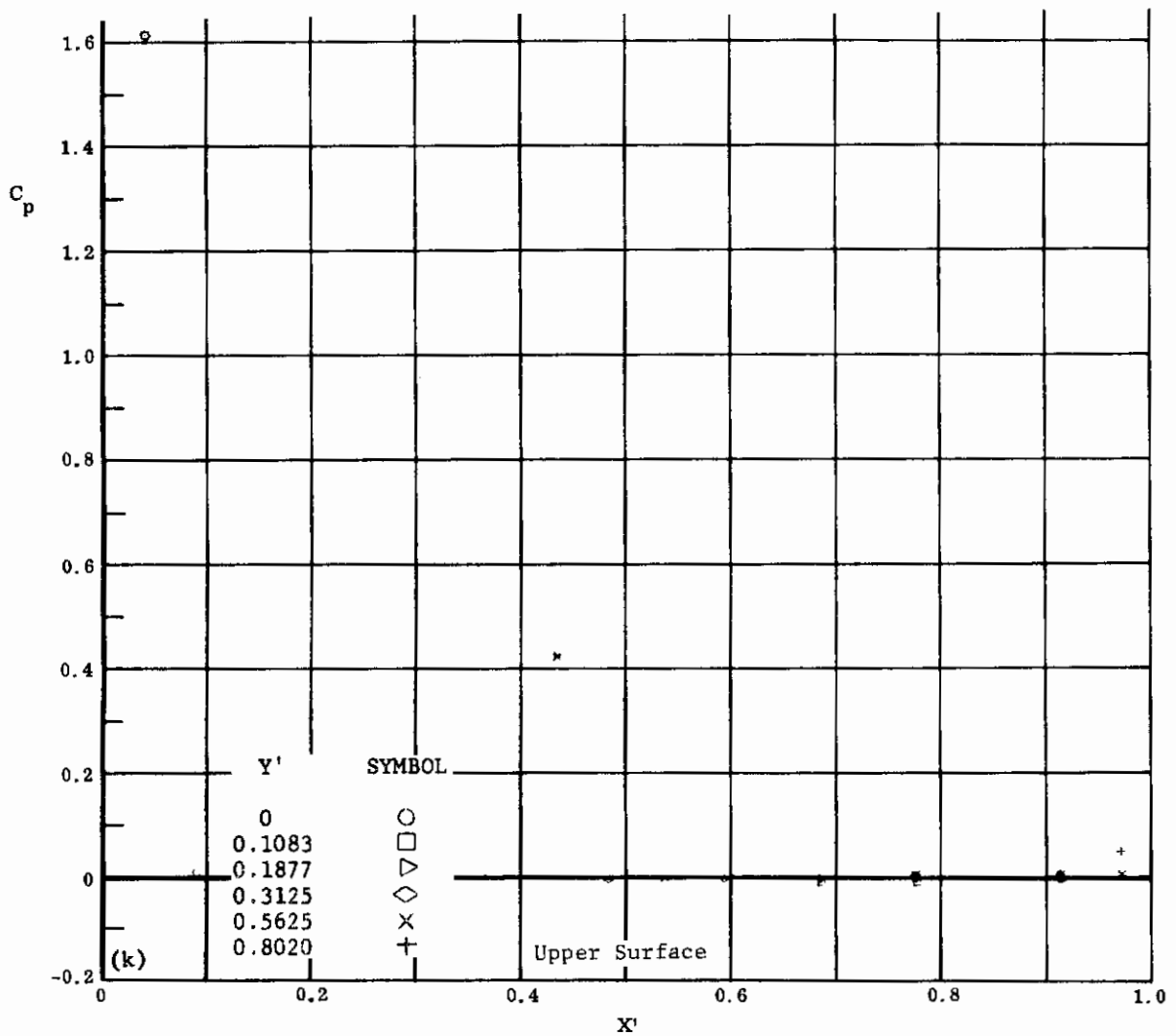

(NONDIMENSIONAL STREAMWISE DISTANCE FROM VIRTUAL APEX)

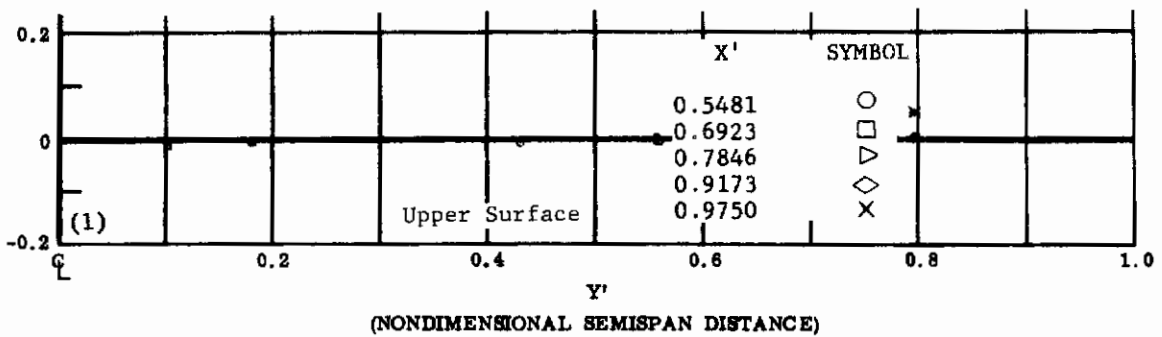

(NONDIMENSIONAL SEMISPAN DISTANCE)

Fig. 8 Configuration I, $\alpha = +20$, $\delta_2 = \delta_3 = -30$

k) C_p vs. X' , upper surface

l) C_p vs. Y' , upper surface

Contrails

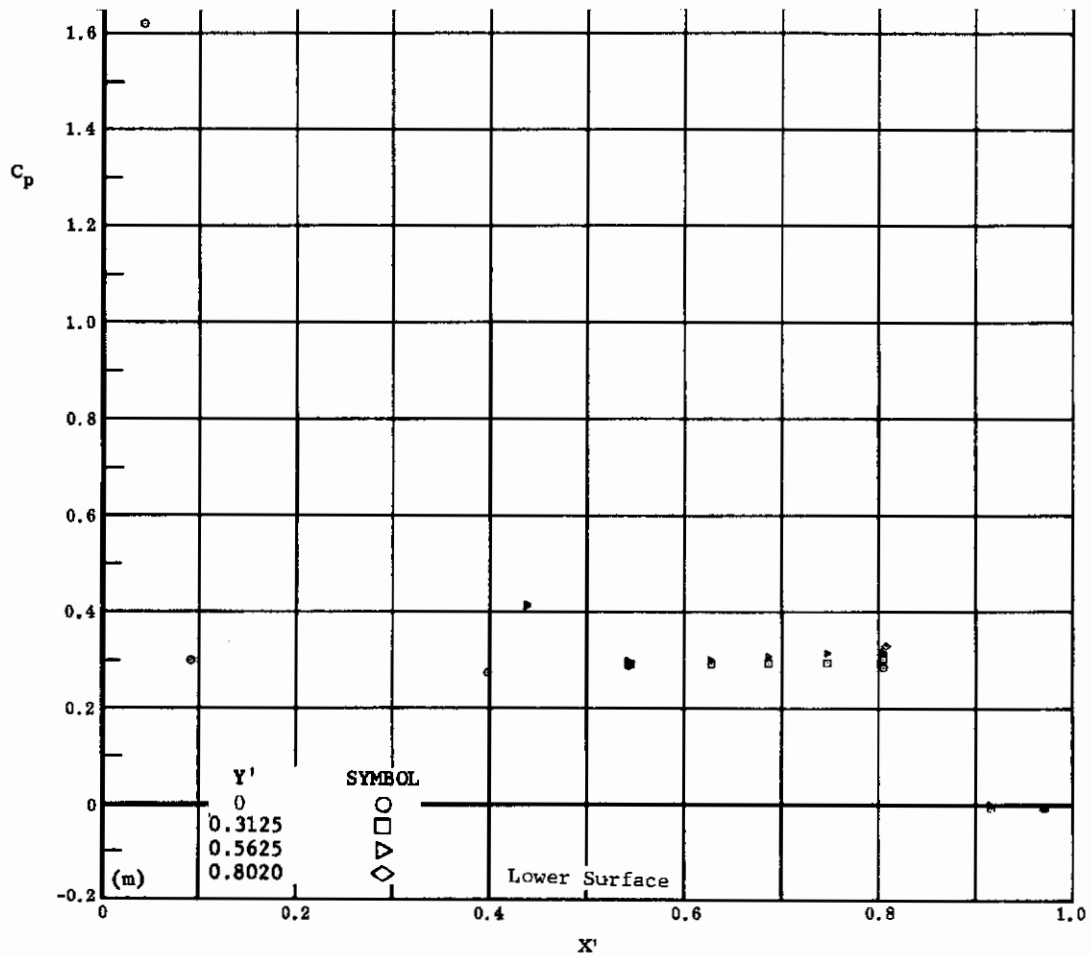

(NONDIMENSIONAL STREAMWISE DISTANCE FROM VIRTUAL APEX)

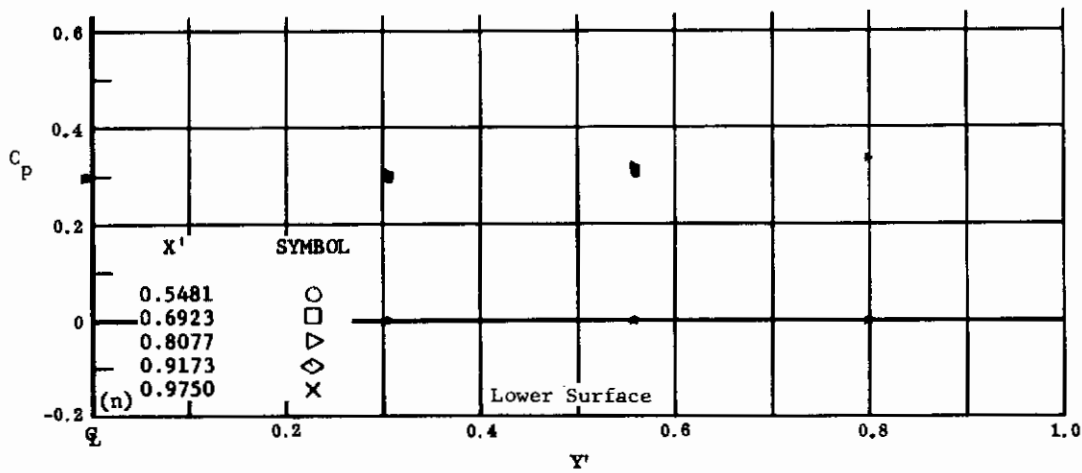

(NONDIMENSIONAL SEMISPAN DISTANCE)

Fig. 8 Configuration I, $\alpha = +20$, $\delta_2 = \delta_3 = -39$

m) C_p vs. X' , lower surface

n) C_p vs. Y' , lower surface

Contrails

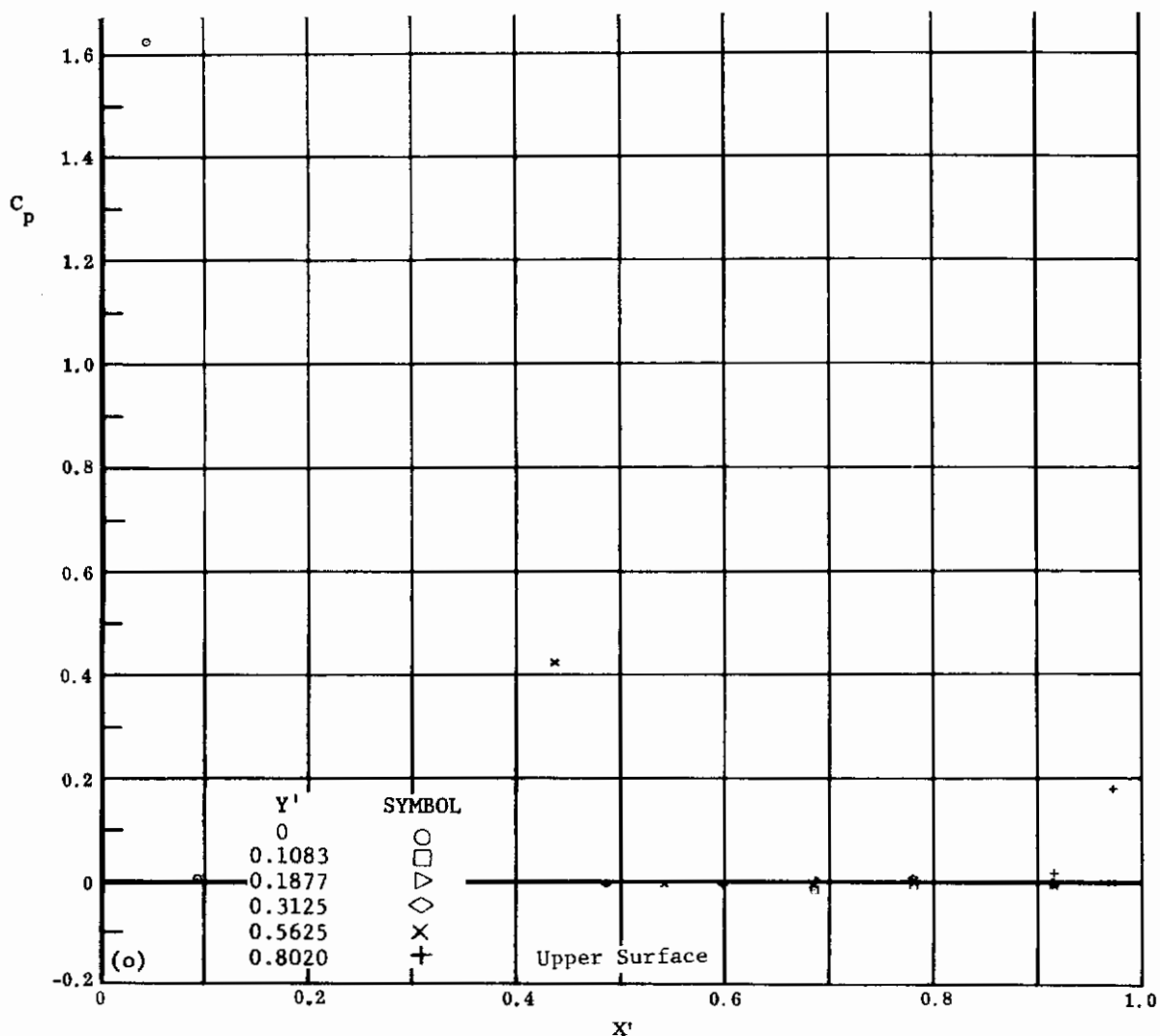

(NONDIMENSIONAL STREAMWISE DISTANCE FROM VIRTUAL APEX)

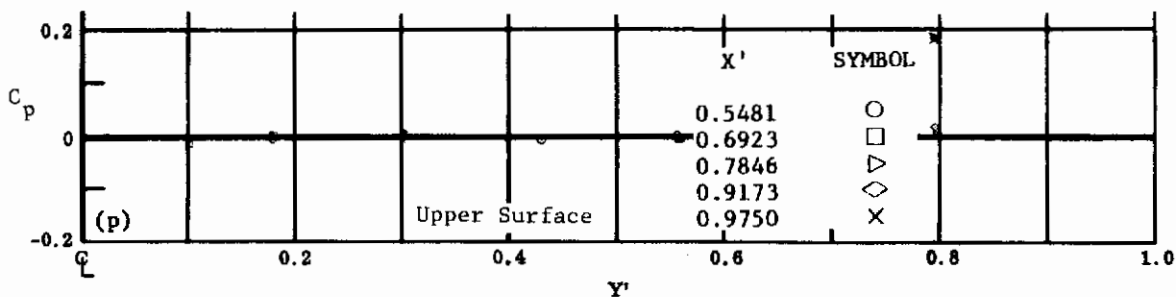

(NONDIMENSIONAL SEMISPAN DISTANCE)

Fig. 8 Configuration I, $\alpha = +20$, $\delta_2 = \delta_3 = -39$

o) C_p vs. X' , upper surface

p) C_p vs. Y' , upper surface

Contrails

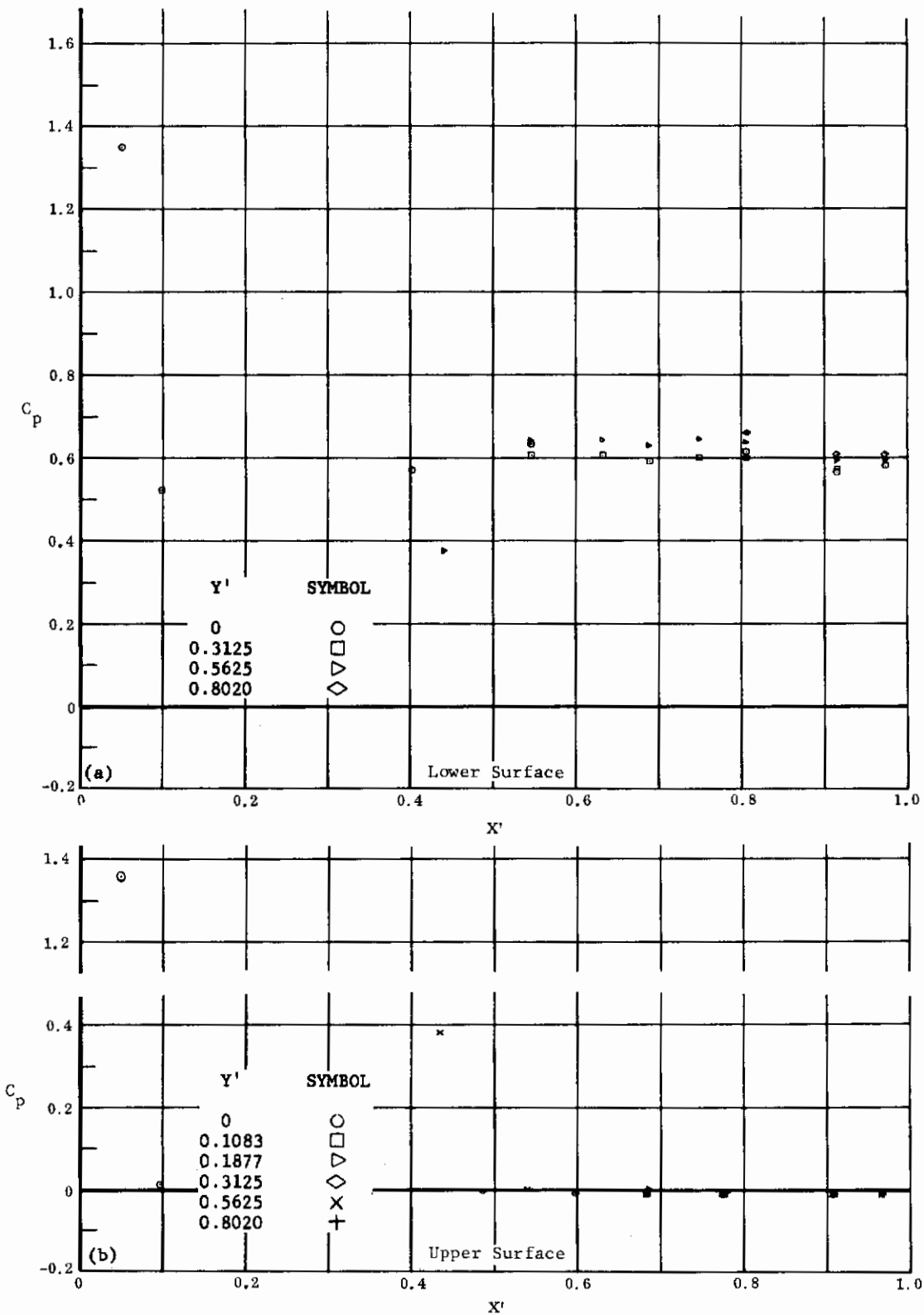

(NONDIMENSIONAL STREAMWISE DISTANCE FROM VIRTUAL APEX)

Fig. 9 Configuration I, $\alpha = +30$, $\delta_2 = \delta_3 = 0$

a) C_p vs. X' , lower surface

b) C_p vs. X' , upper surface

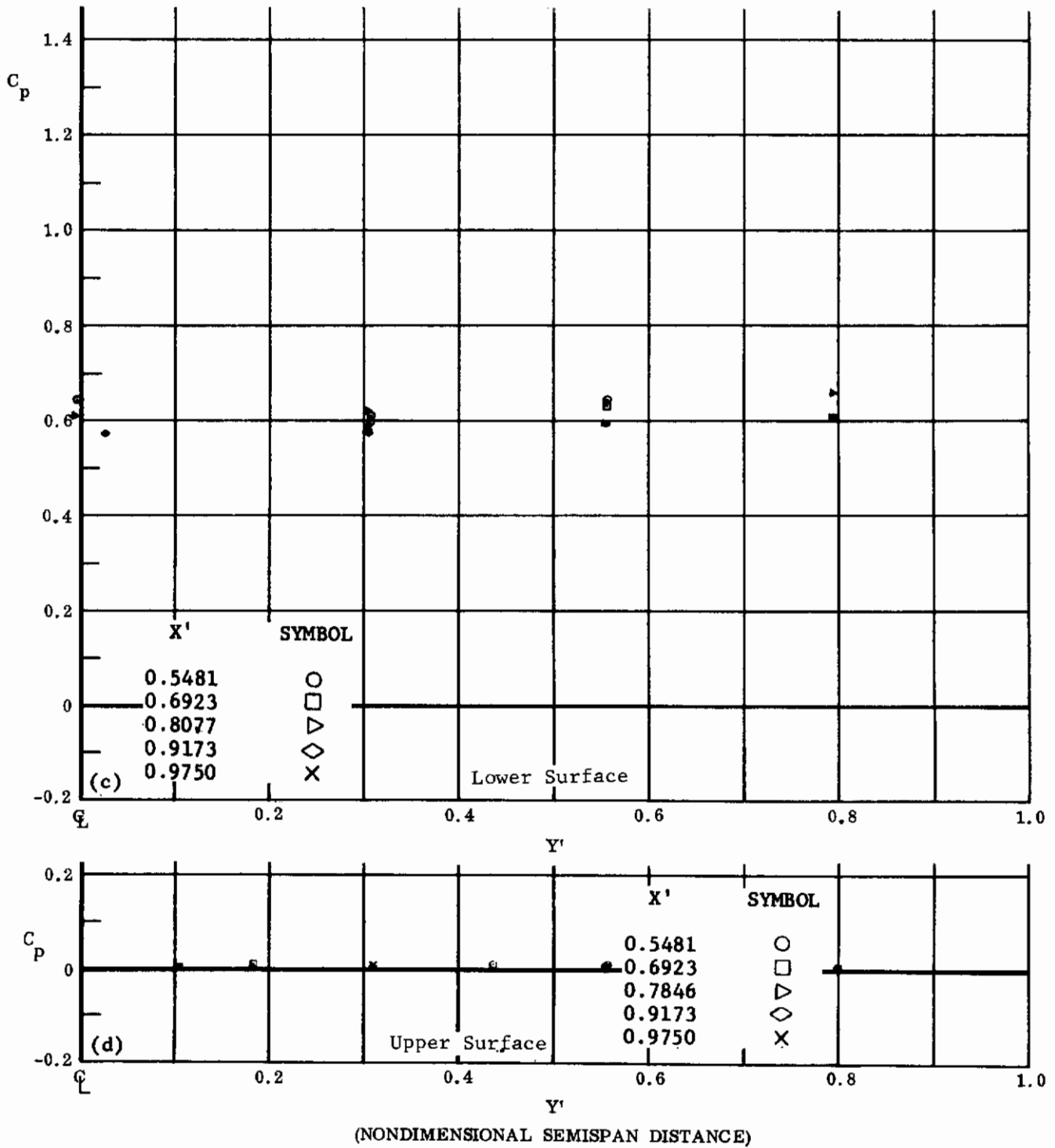
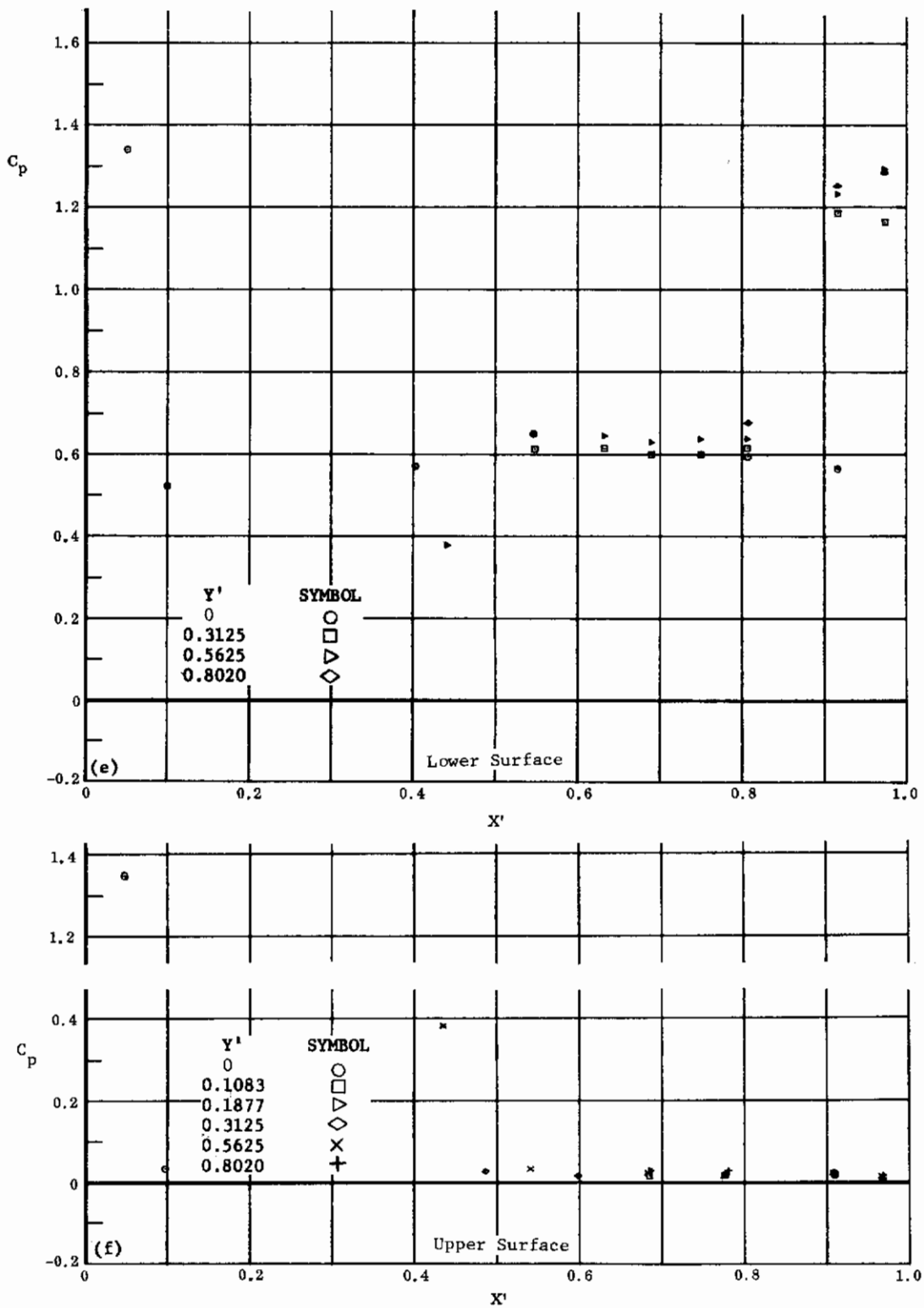

Fig. 9 Configuration I, $\alpha = +30$, $\delta_2 = \delta_3 = 0$

c) C_p vs. Y' , lower surface

d) C_p vs. Y' , upper surface

Contrails



(NONDIMENSIONAL STREAMWISE DISTANCE FROM VIRTUAL APEX)

Fig. 9 Configuration I, $\alpha = +30$, $\delta_2 = \delta_3 = +10$

e) C_p vs. X' , lower surface

f) C_p vs. X' , upper surface

Contrails

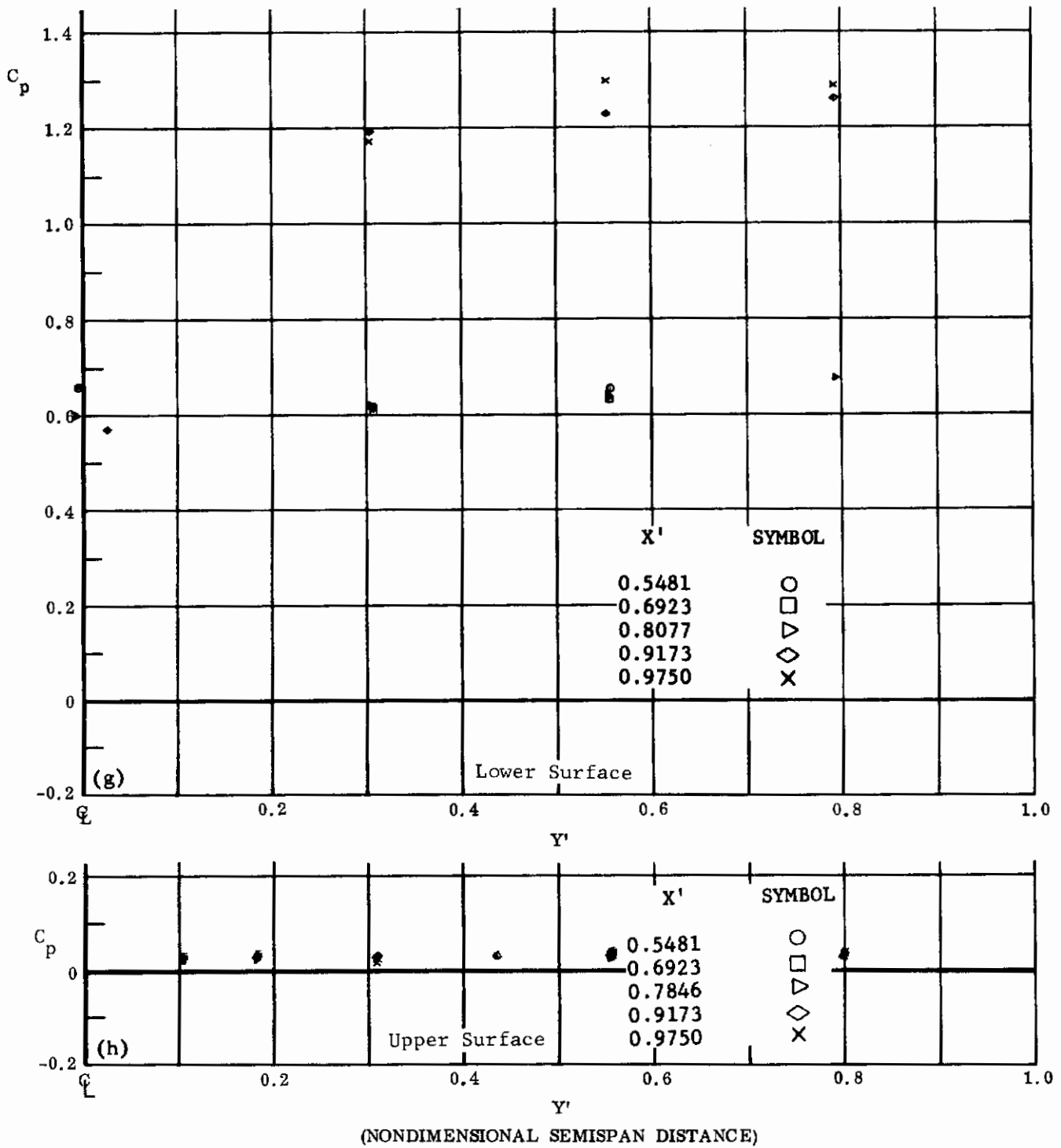
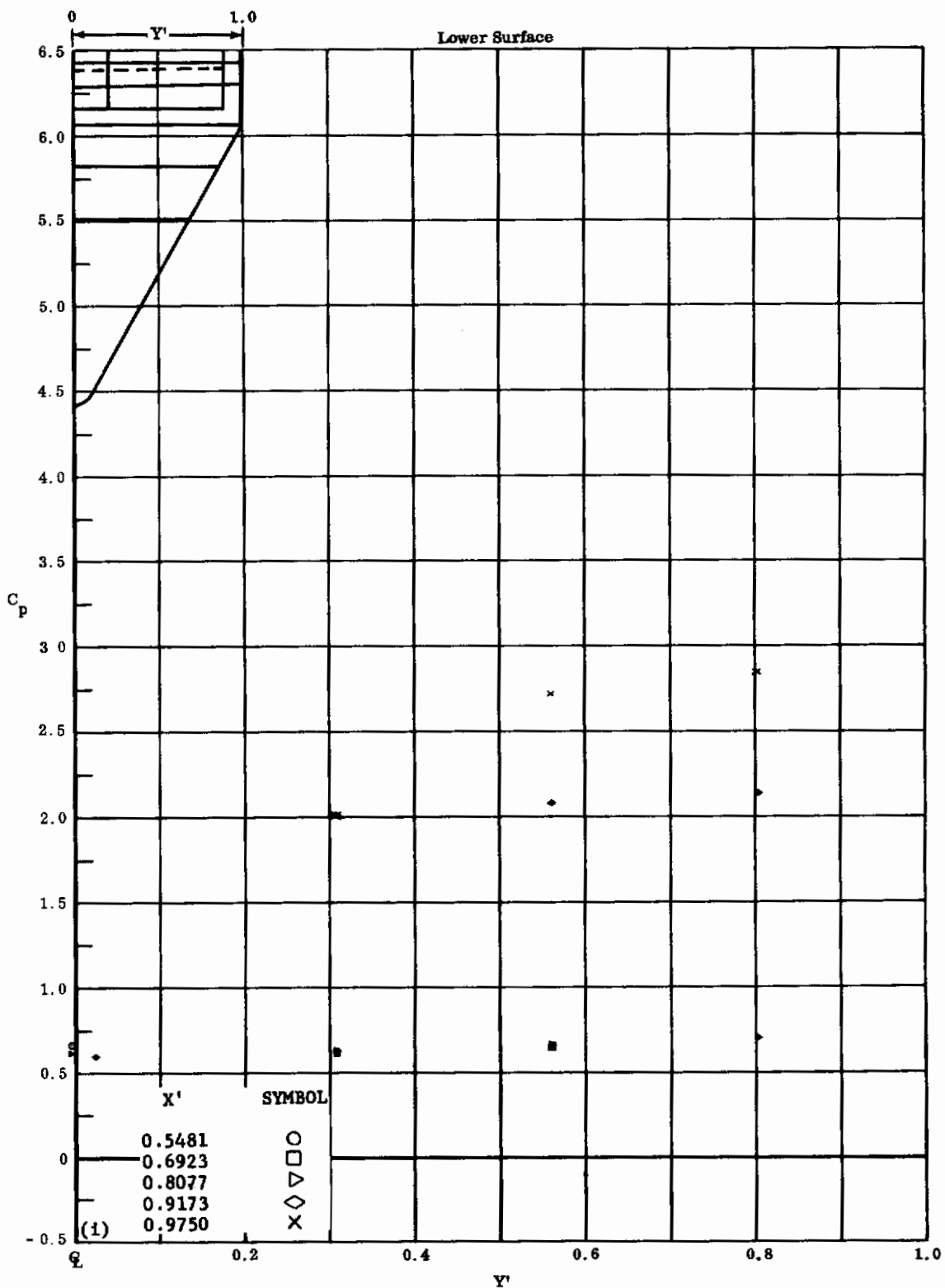

Fig. 9 Configuration I, $\alpha = +30$, $\delta_2 = \delta_3 = +10$

g) C_p vs. Y' , lower surface

h) C_p vs. Y' , upper surface



(NONDIMENSIONAL SEMISPAN DISTANCE)

Fig. 91 Configuration I, $\alpha = +30$, $\delta_2 = \delta_3 = +20$

C_p vs. Y' , lower surface

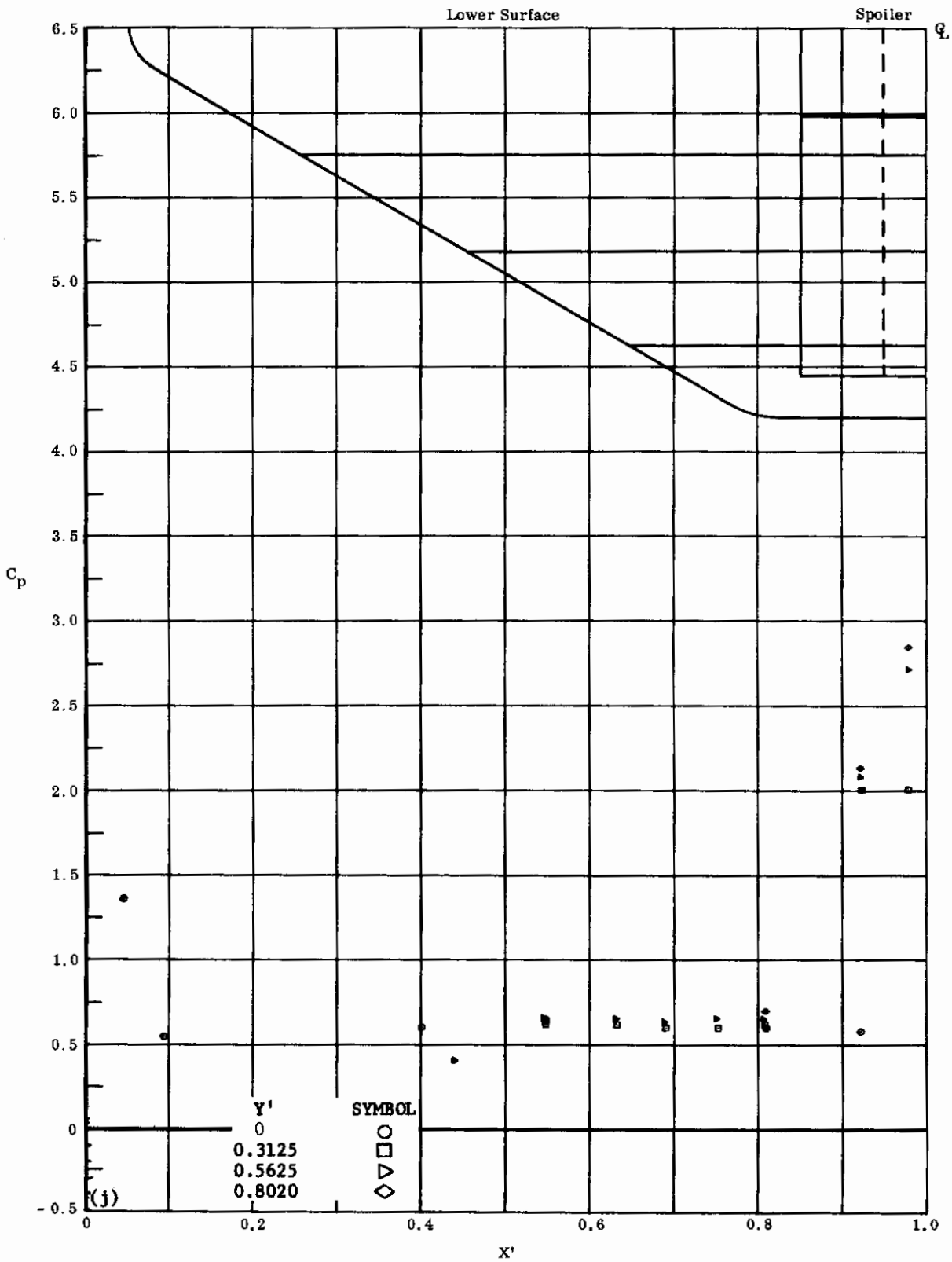

(NONDIMENSIONAL STREAMWISE DISTANCE FROM VIRTUAL APEX)

Fig. 9j Configuration I, $\alpha = +30$, $\delta_2 = \delta_3 = +20$

C_p vs. X' , lower surface

Contrails

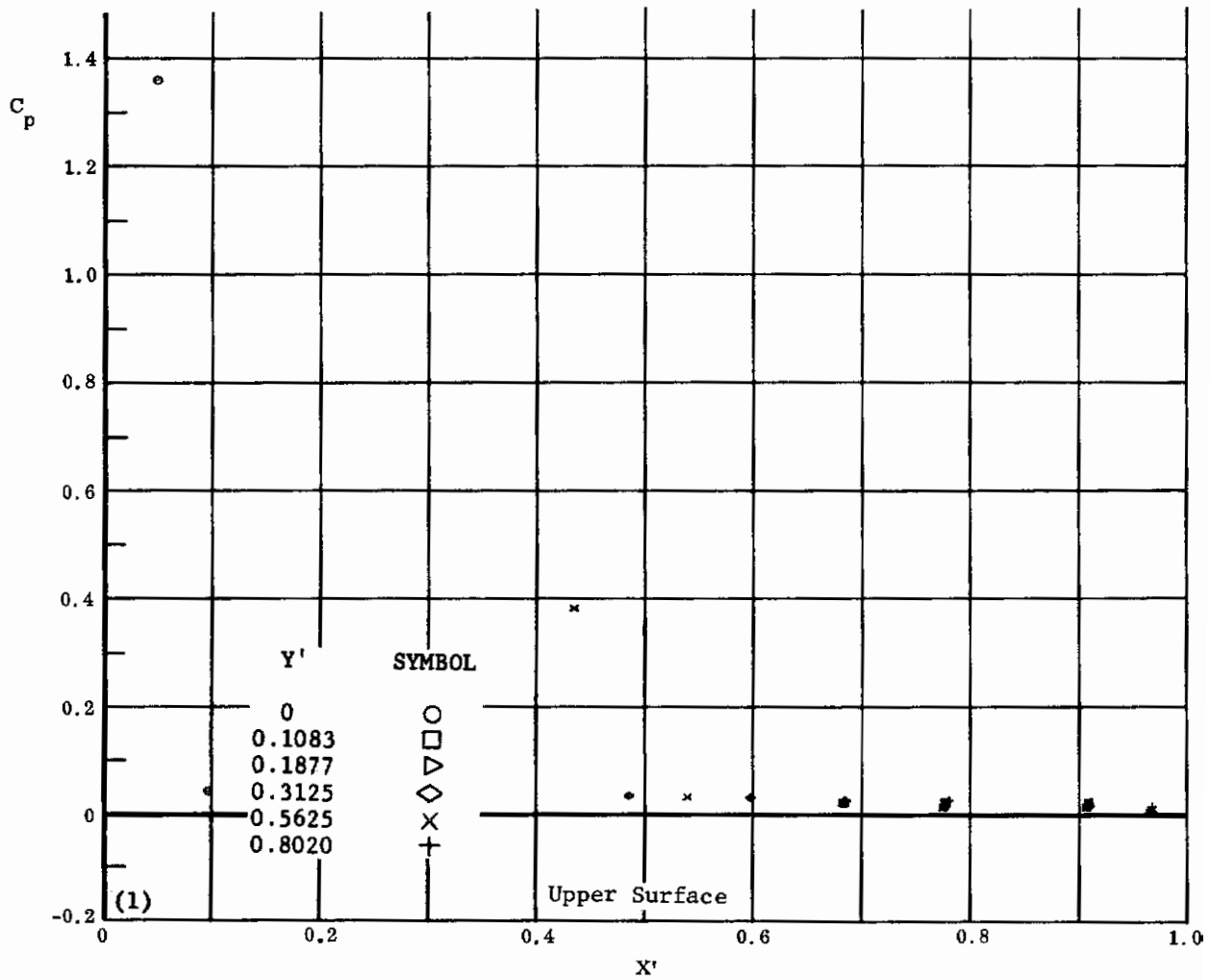
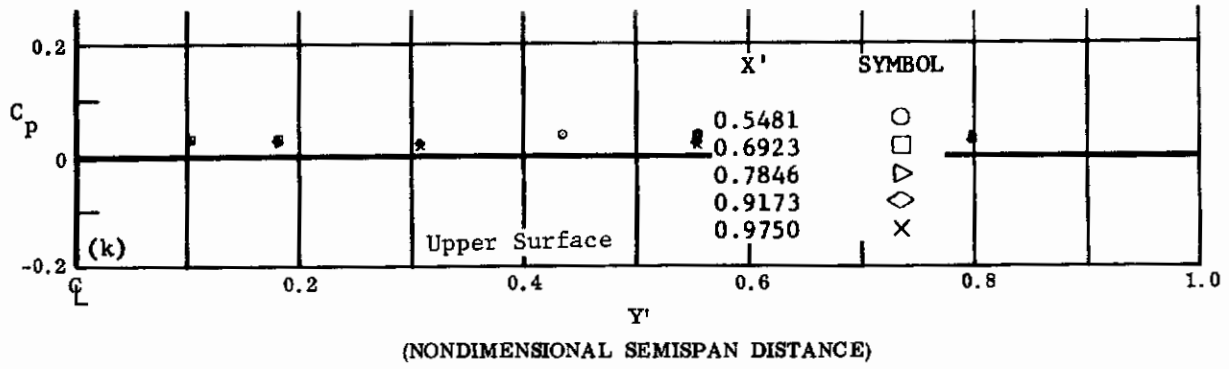

(NONDIMENSIONAL STREAMWISE DISTANCE FROM VIRTUAL APEX)

Fig. 9 Configuration I, $\alpha = +30$, $\delta_2 = \delta_3 = +20$

k) C_p vs. Y' , upper surface

l) C_p vs. X' , upper surface

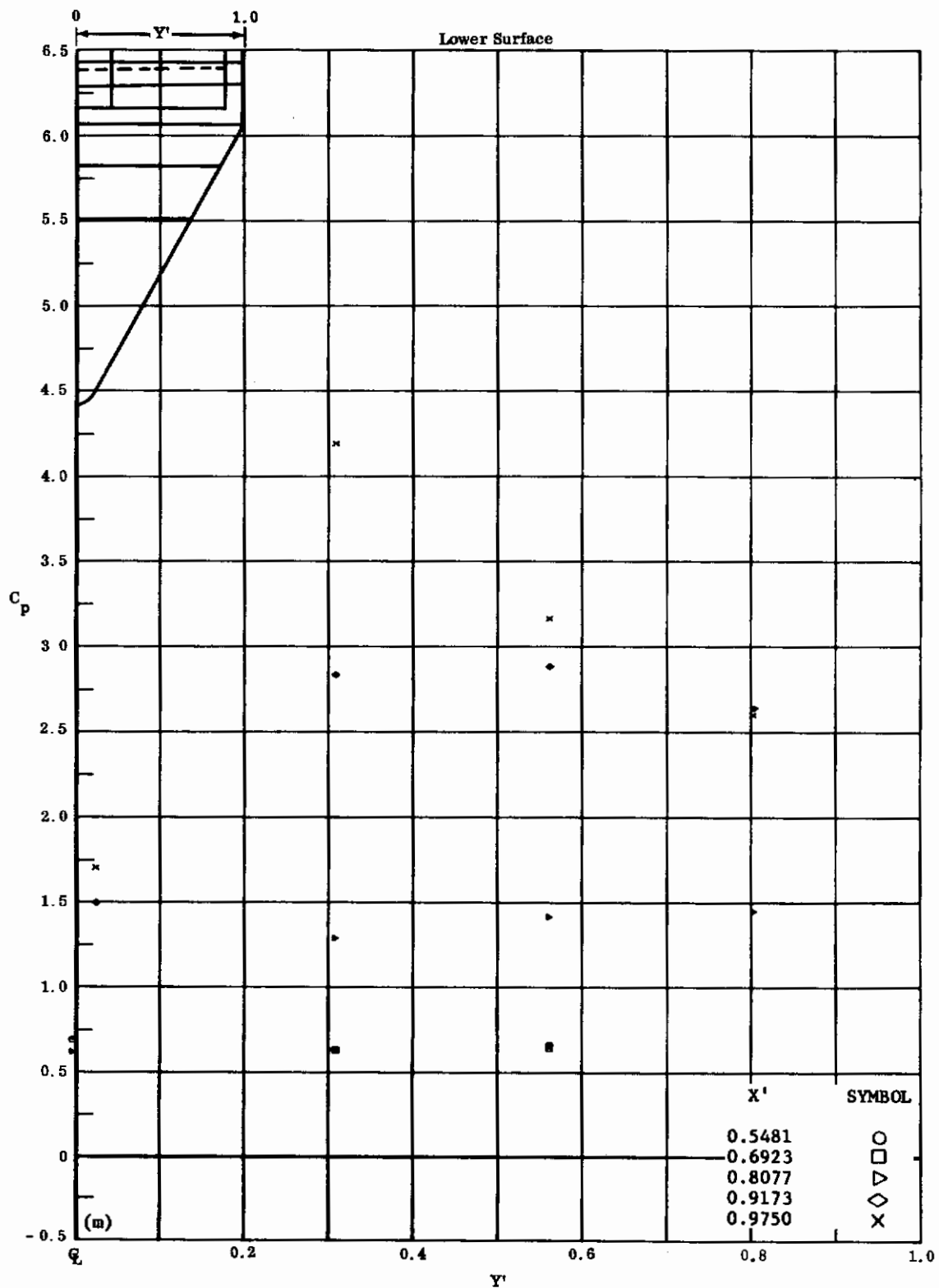

(NONDIMENSIONAL SEMISPAN DISTANCE)

Fig. 9m Configuration I, $\alpha = +30$, $\delta_2 = \delta_3 = +30$

C_p vs. Y' , lower surface

Contrails

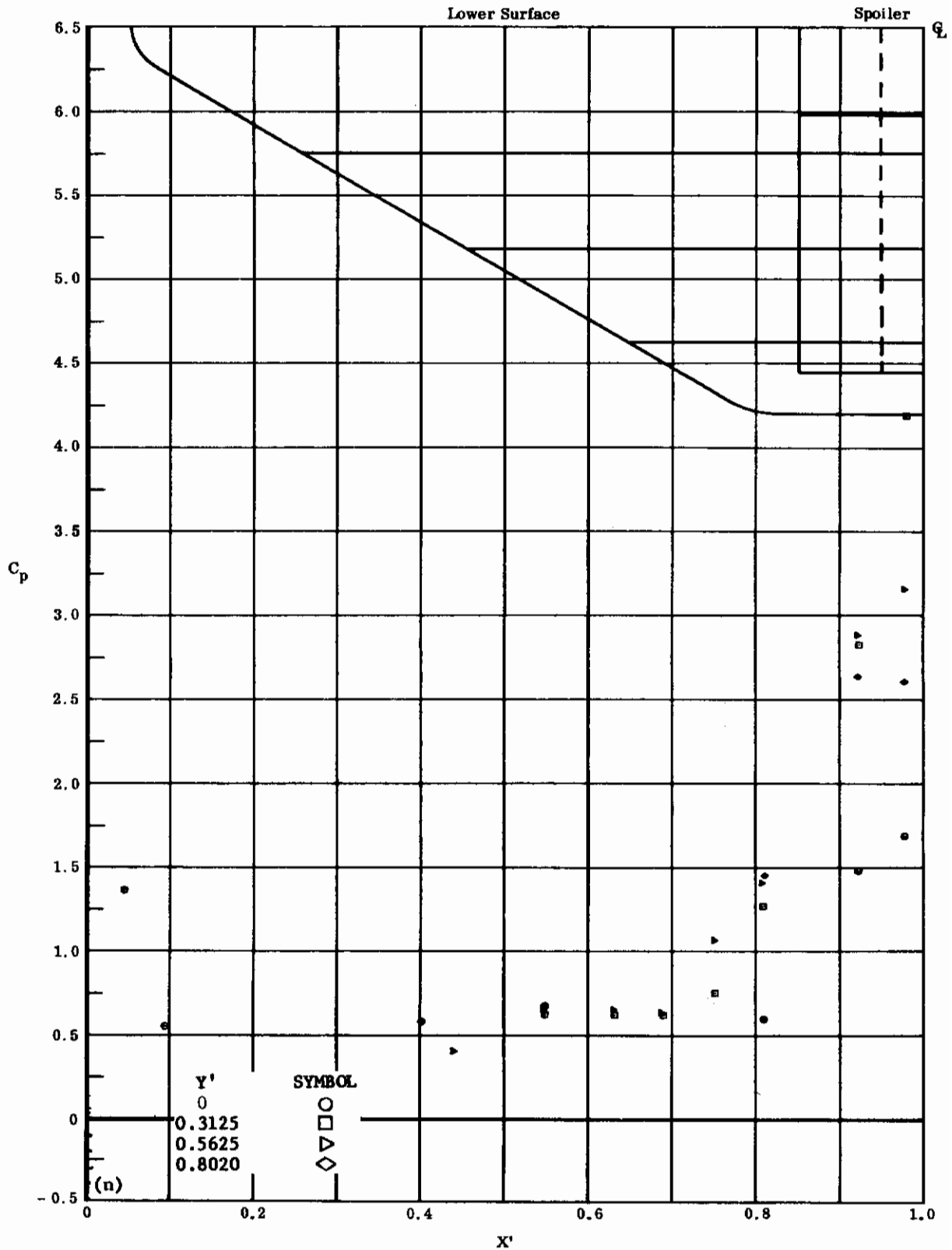

(NONDIMENSIONAL STREAMWISE DISTANCE FROM VIRTUAL APEX)

Fig. 9n Configuration I, $\alpha = +30$, $\delta_2 = \delta_3 = +30$

C_p vs. X' , lower surface

Contrails

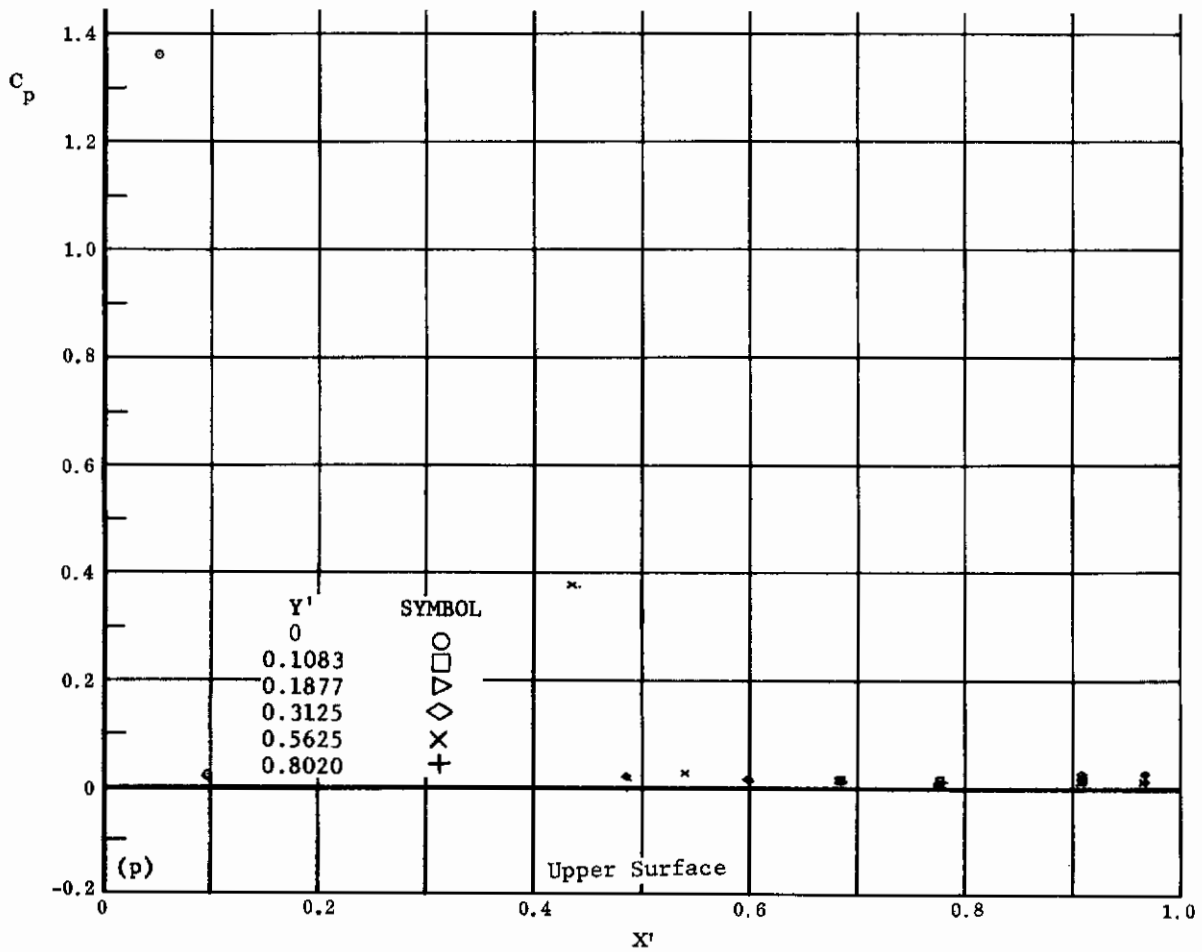
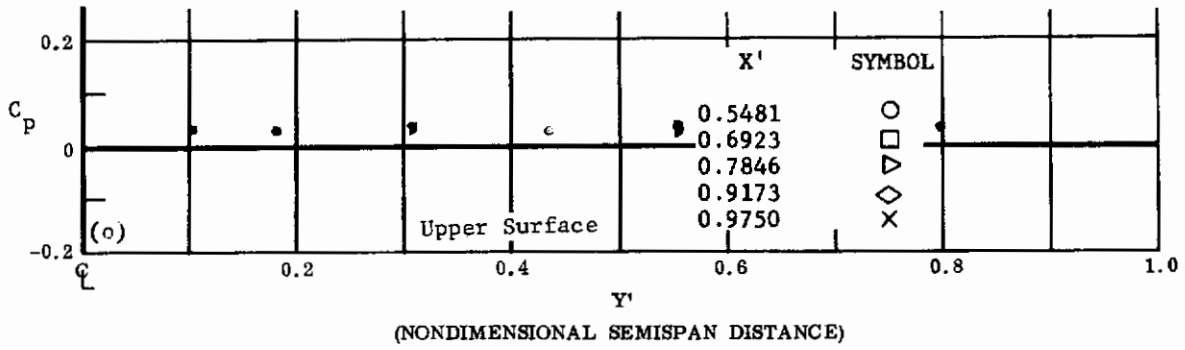
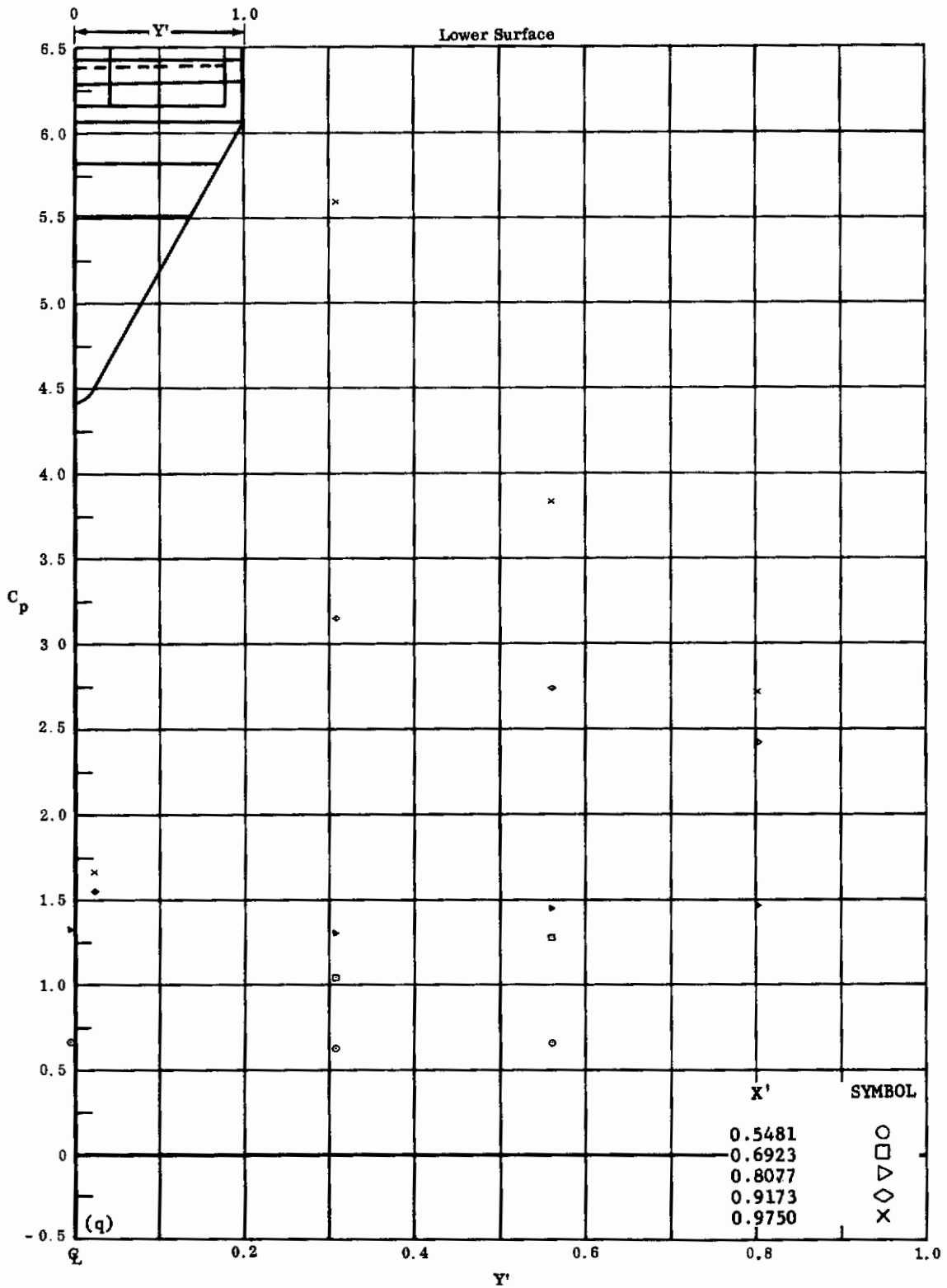

Fig. 9 Configuration I, $\alpha = +30$, $\delta_2 = \delta_3 = +30$

o) C_p vs. Y' , upper surface

p) C_p vs. X' , upper surface

Contrails



(NONDIMENSIONAL SEMISPAN DISTANCE)

Fig. 9q Configuration I, $\alpha = +30$, $\delta_2 = \delta_3 = +39$

C_p vs. Y' , lower surface

Contrails

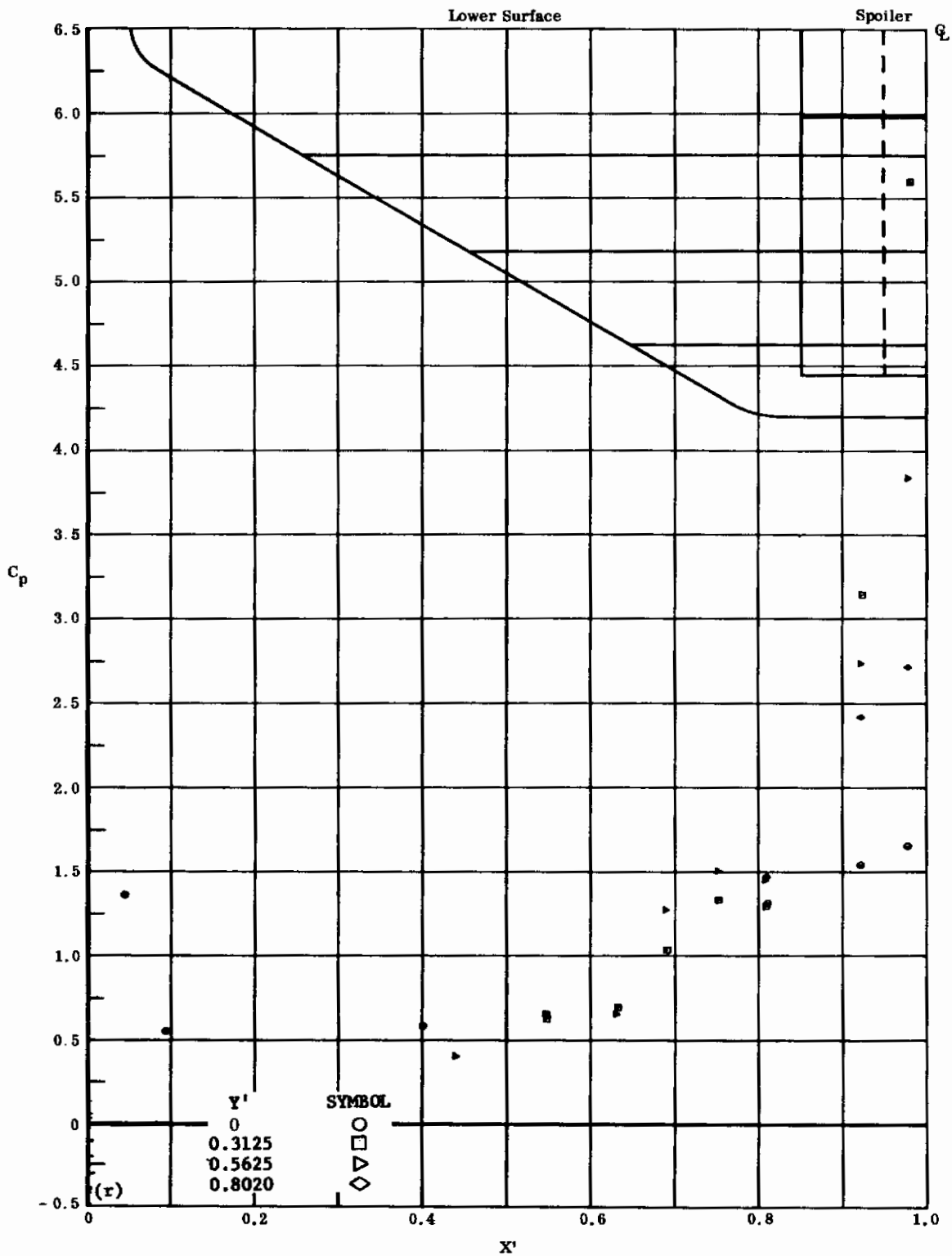

(NONDIMENSIONAL STREAMWISE DISTANCE FROM VIRTUAL APEX)

Fig 9r Configuration I, $\alpha = +30$, $\delta_2 = \delta_3 = +39$

C_p vs. X' , lower surface

Contrails

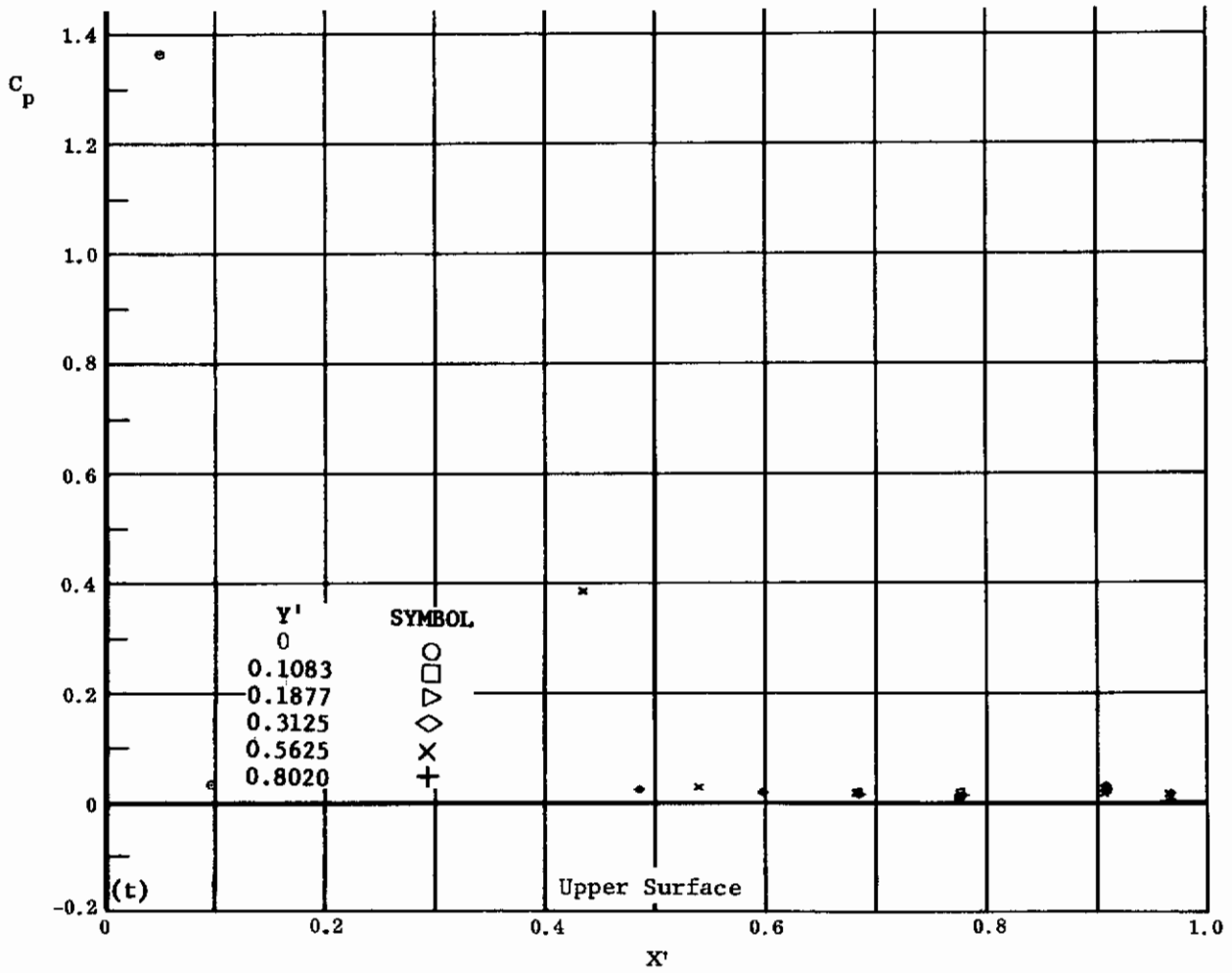
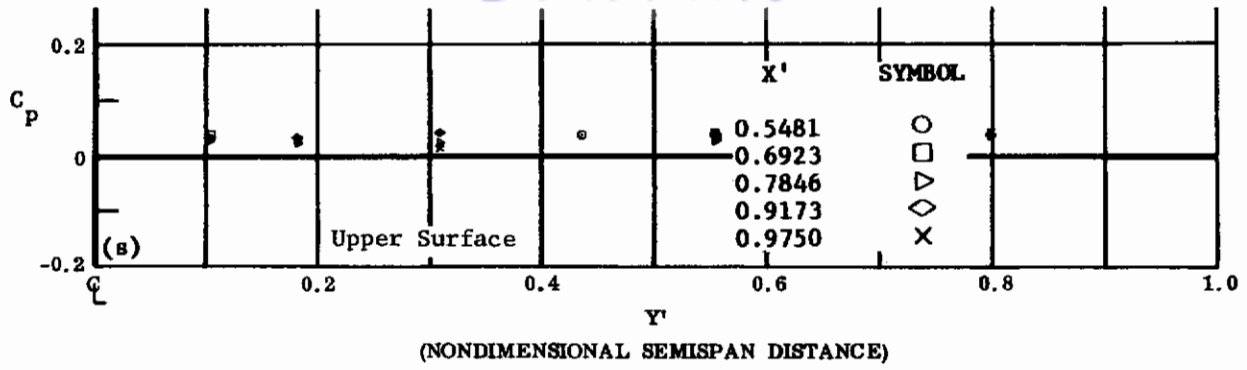

(NONDIMENSIONAL STREAMWISE DISTANCE FROM VIRTUAL APEX)

Fig. 9 Configuration I, $\alpha = +30$, $\delta_2 = \delta_3 = +39$

s) C_p vs. Y' , upper surface

t) C_p vs. X' , upper surface

Contrails

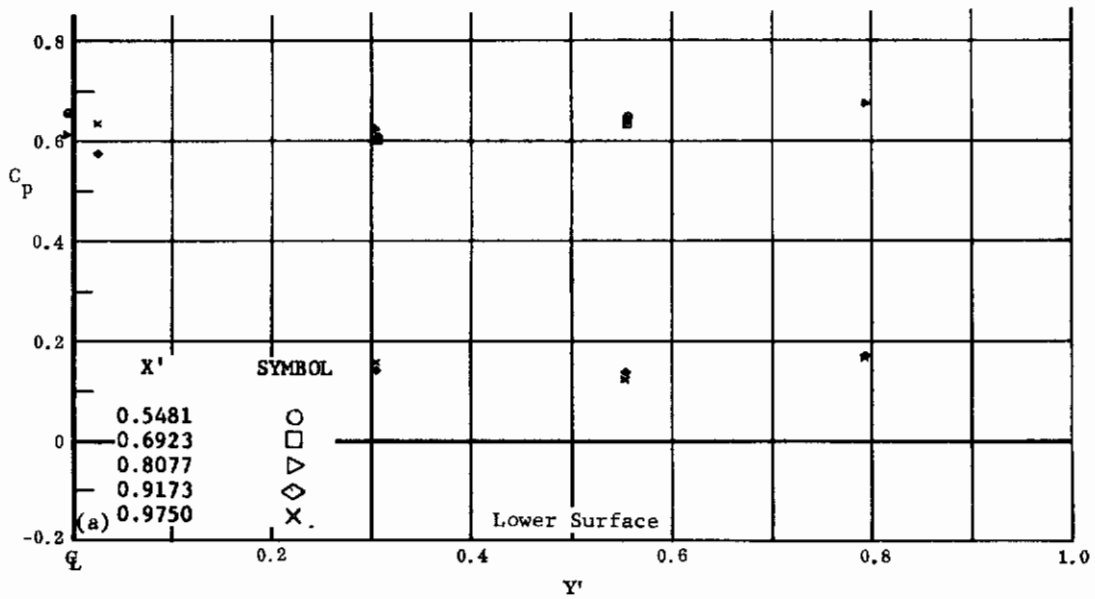

(NONDIMENSIONAL SEMISPAN DISTANCE)

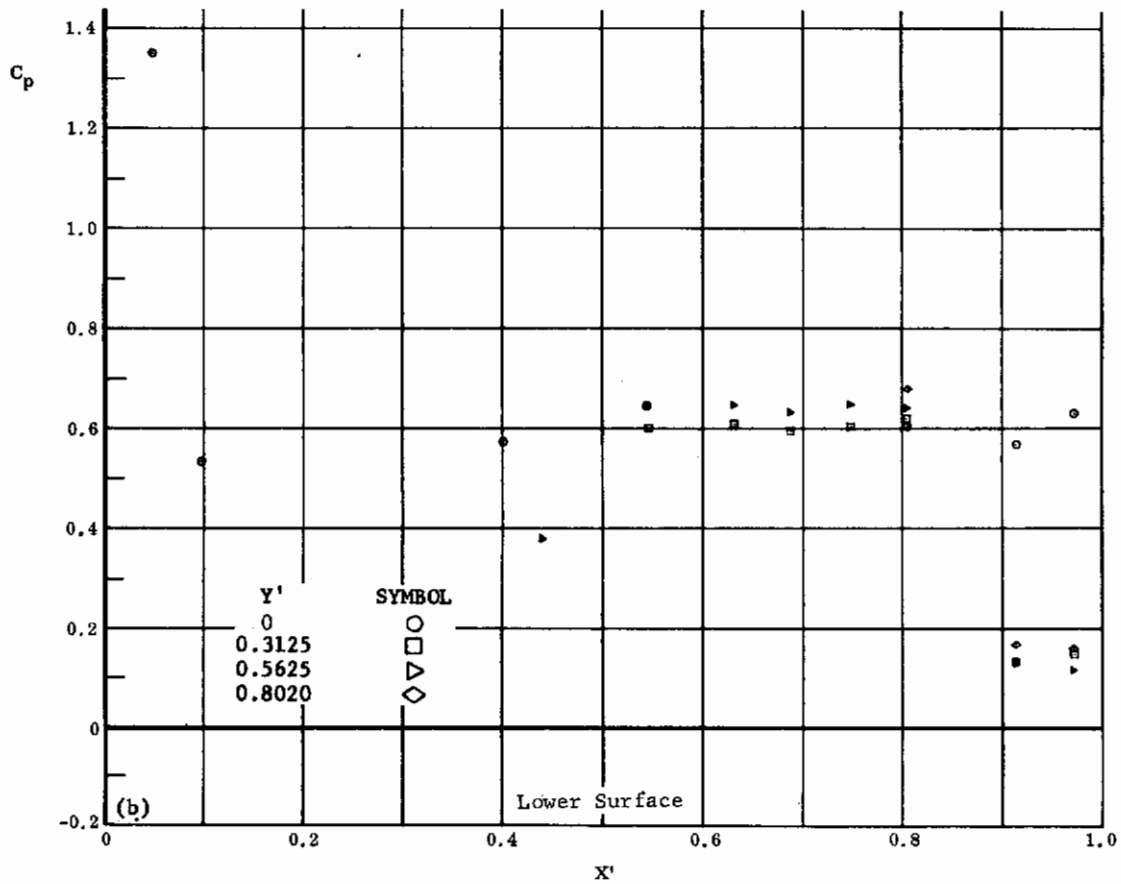

(NONDIMENSIONAL STREAMWISE DISTANCE FROM VIRTUAL APEX)

Fig. 10 Configuration I, $\alpha = +30$, $\delta_2 = \delta_3 = -20$

a) C_p vs. Y' , lower surface

b) C_p vs. X' , lower surface

Contrails

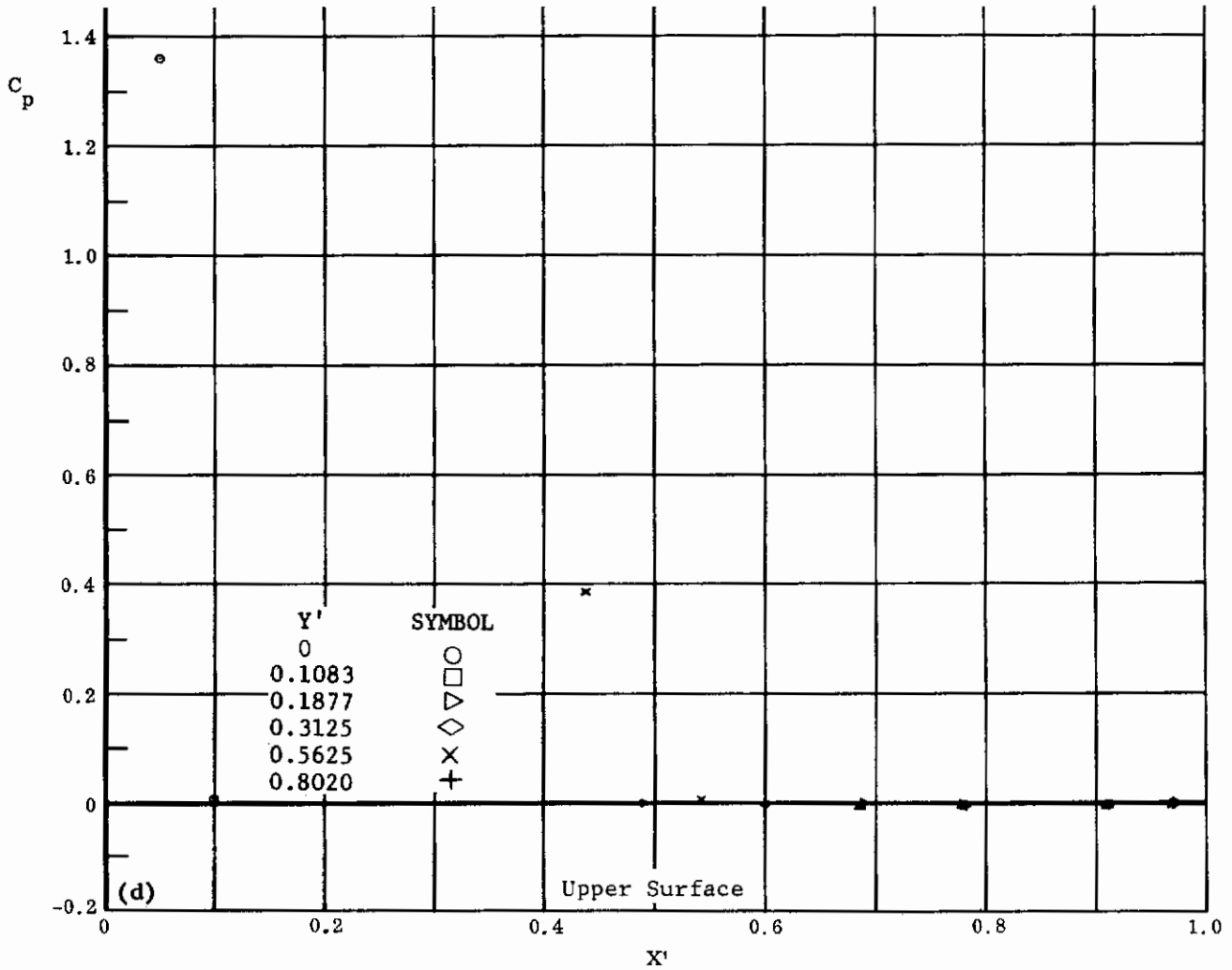
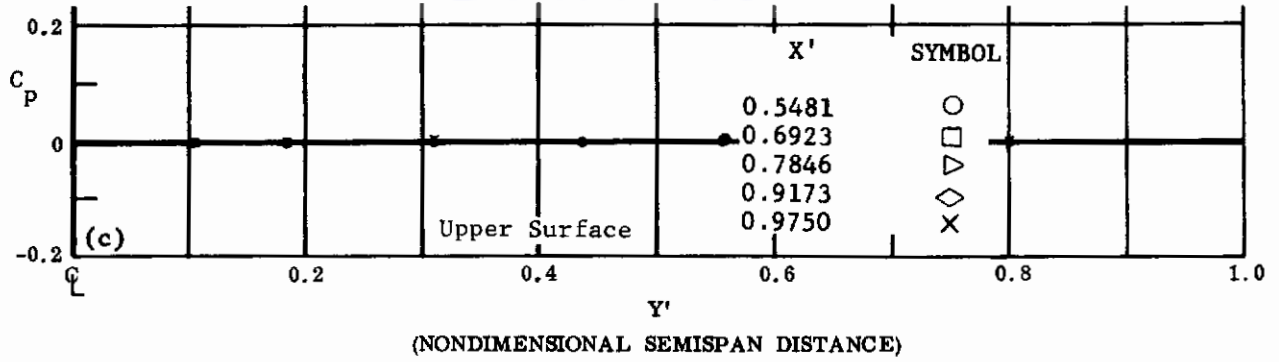

(NONDIMENSIONAL STREAMWISE DISTANCE FROM VIRTUAL APEX)

Fig. 10 Configuration I, $\alpha = +30$, $\delta_2 = \delta_3 = -20$

c) C_p vs. Y' , upper surface

d) C_p vs. X' , upper surface

Contrails

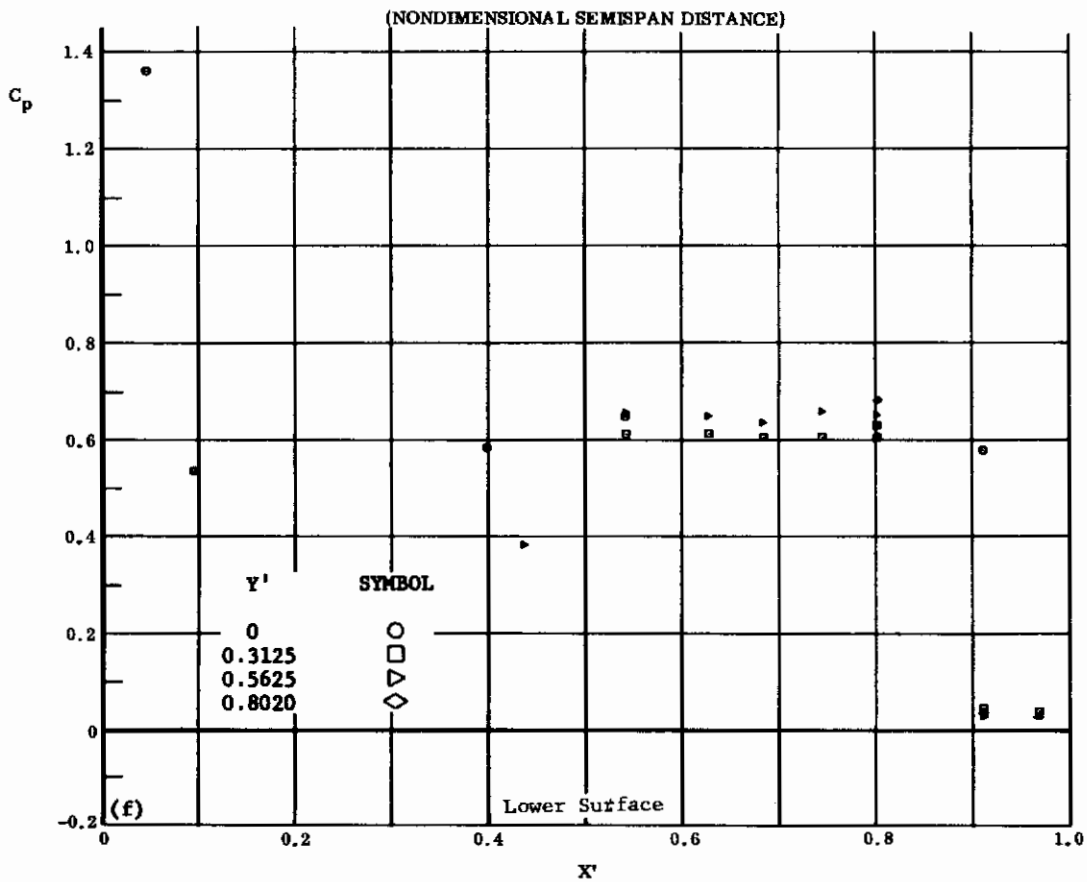
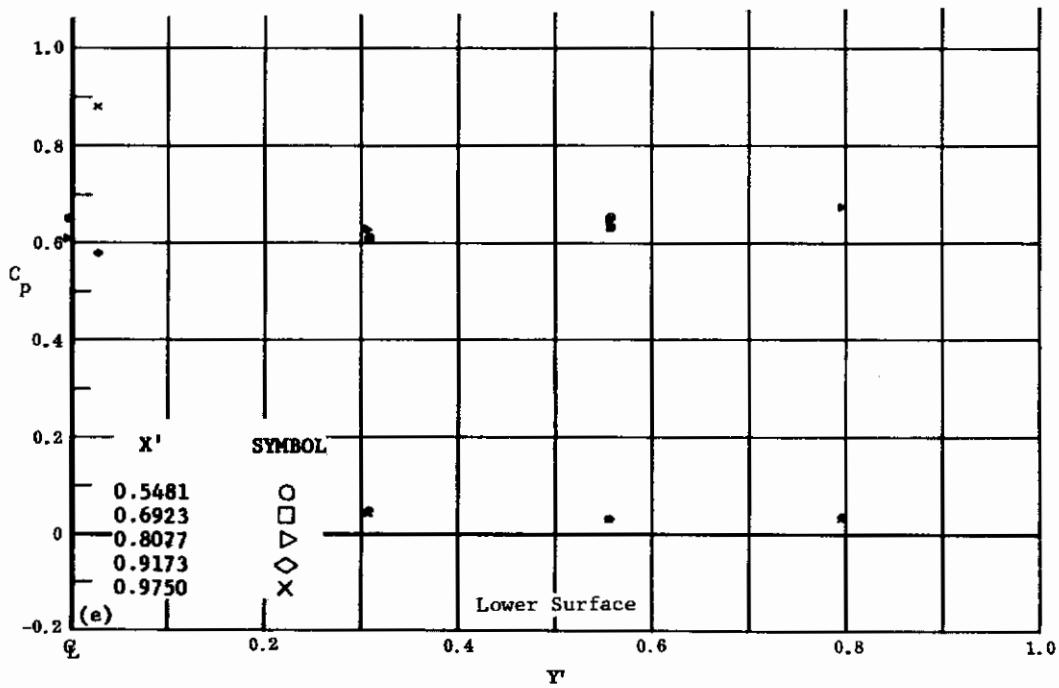

(NONDIMENSIONAL STREAMWISE DISTANCE FROM VIRTUAL APEX)

Fig. 10 Configuration I, $\alpha = +30$, $\delta_2 = \delta_3 = -39$

e) C_p vs. Y' , lower surface

f) C_p vs. X' , lower surface

Contrails

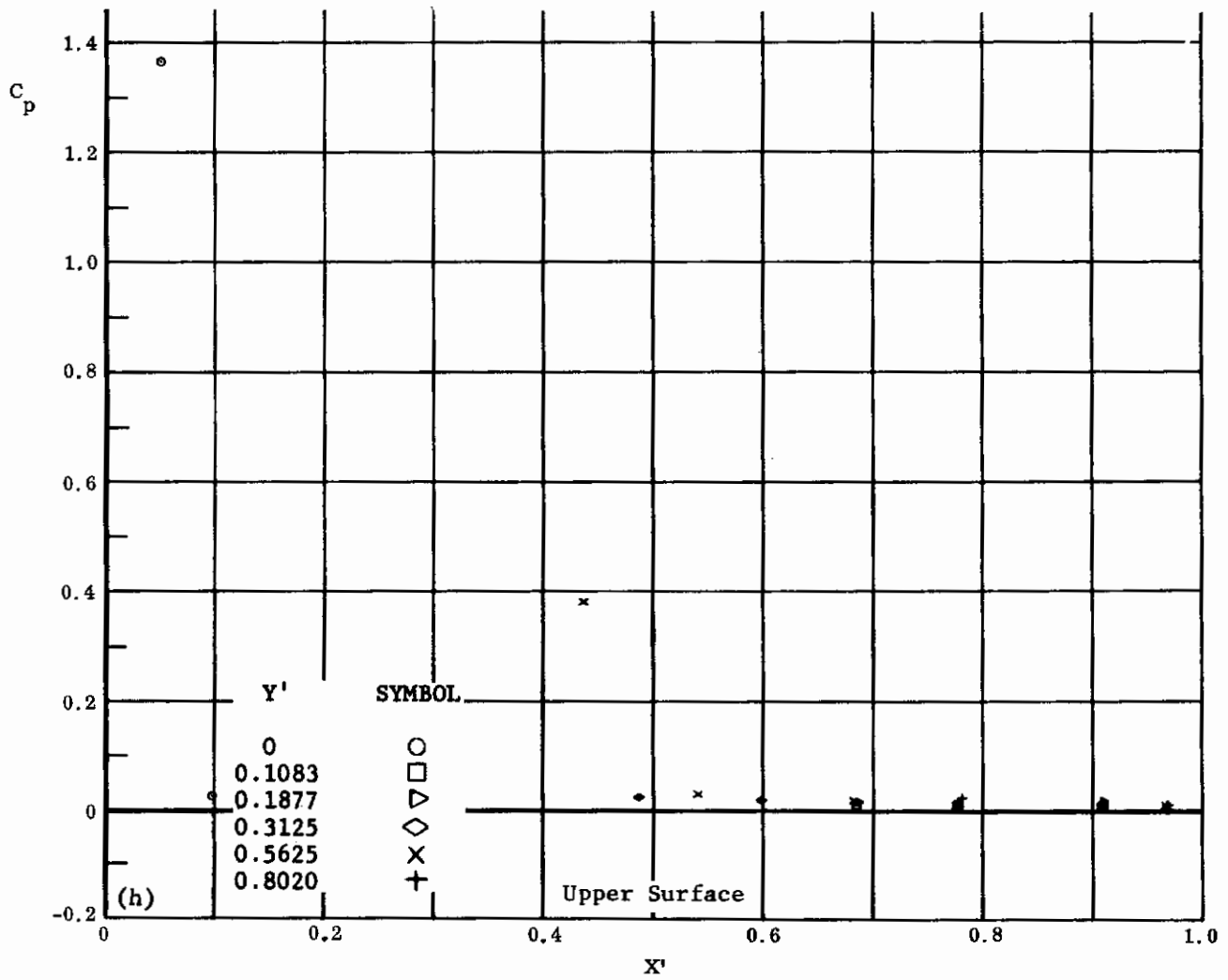
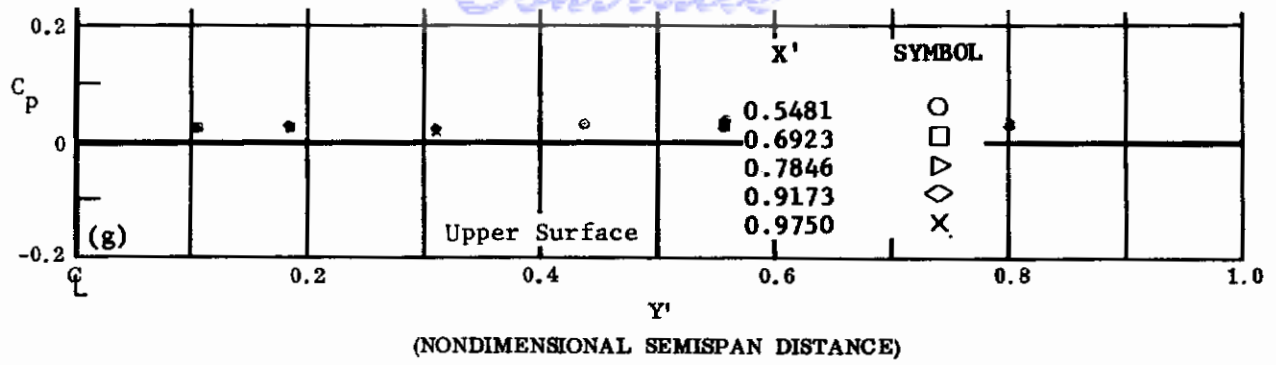

(NONDIMENSIONAL STREAMWISE DISTANCE FROM VIRTUAL APEX)

Fig. 10 Configuration I, $\alpha = +30$, $\delta_2 = \delta_3 = -39$

g) C_p vs. Y', upper surface

h) C_p vs. X', upper surface

Contrails

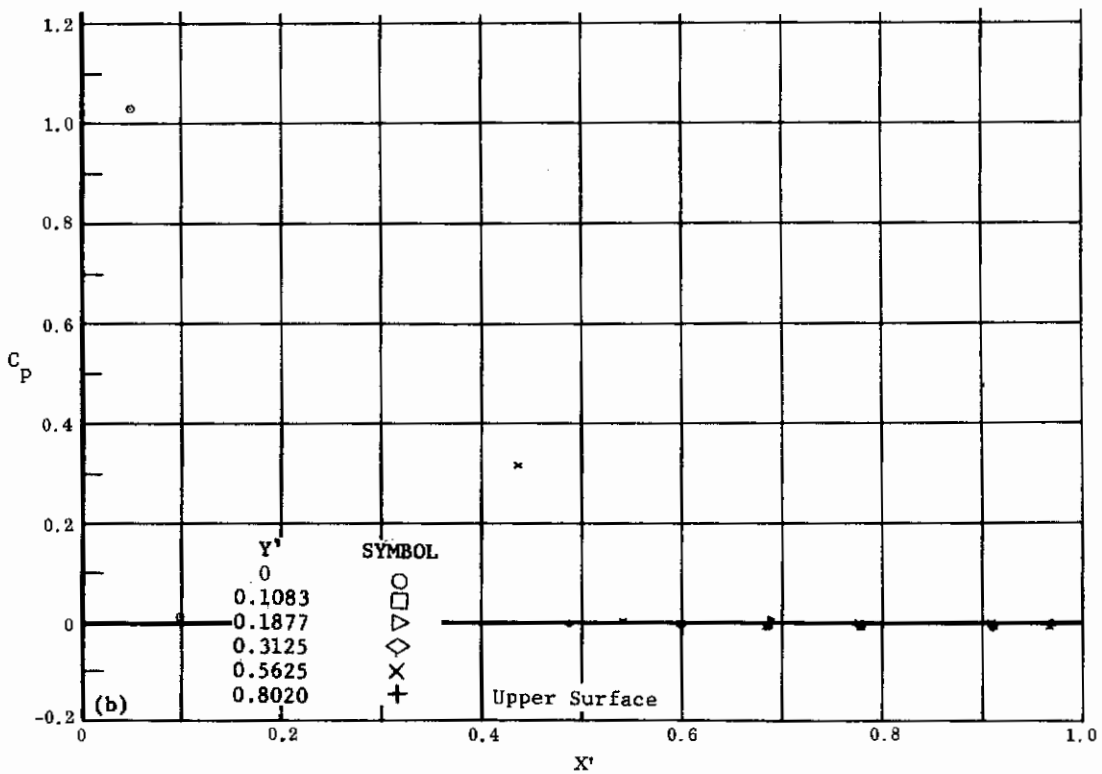
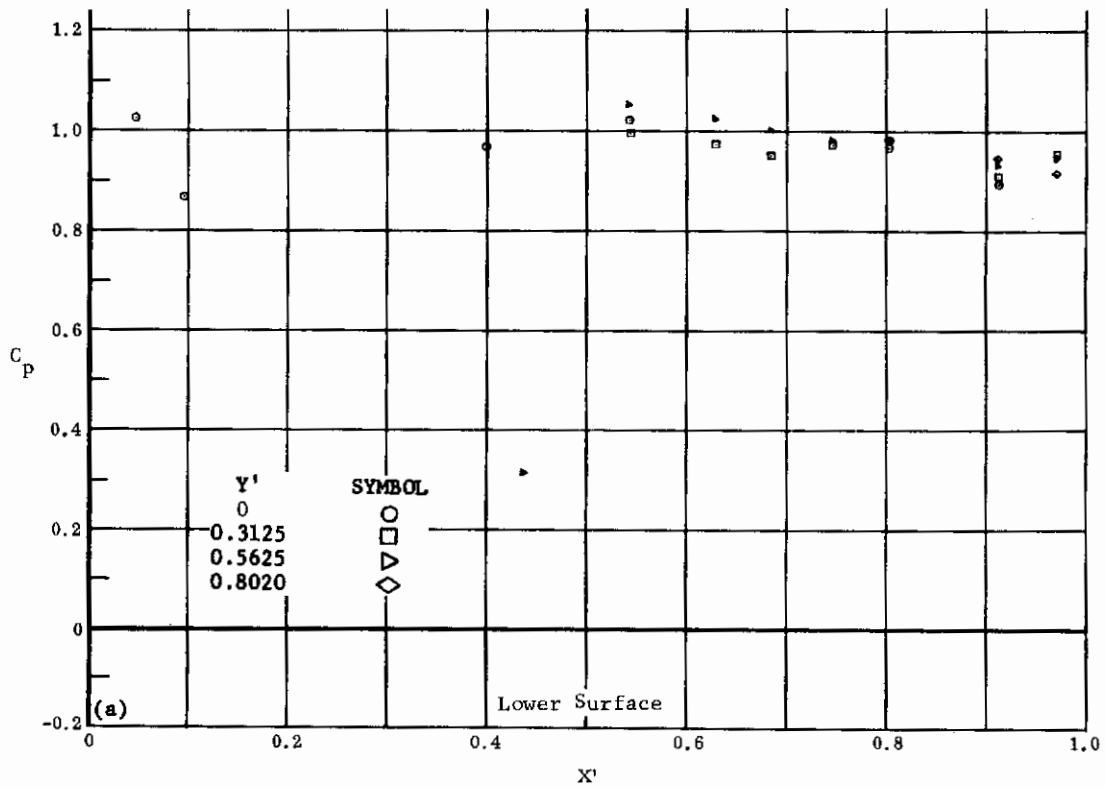

(NONDIMENSIONAL STREAMWISE DISTANCE FROM VIRTUAL APEX)

Fig. 11 Configuration I, $\alpha = +40$, $\delta_2 = \delta_3 = 0$

a) C_p vs. X' , lower surface

b) C_p vs. X' , upper surface

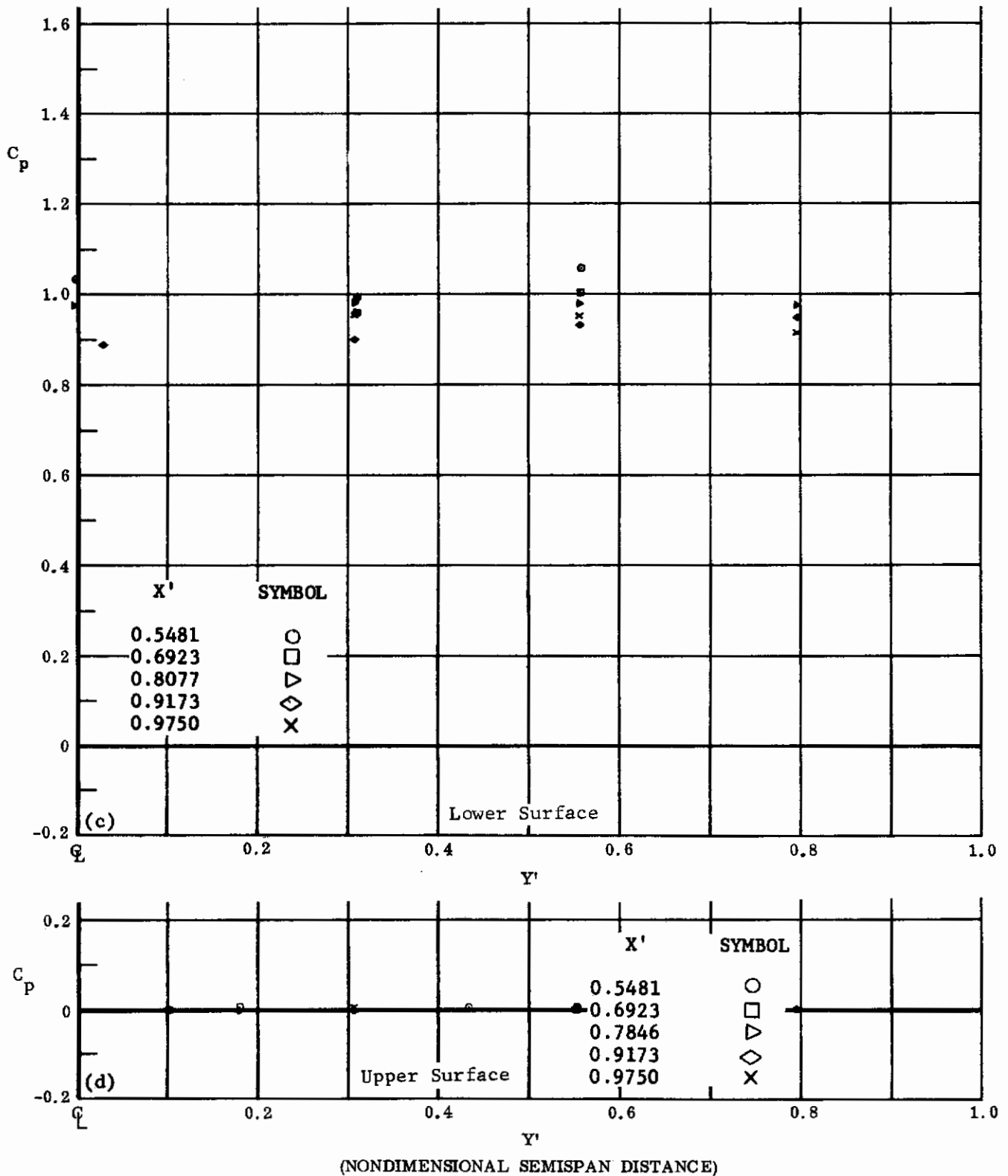
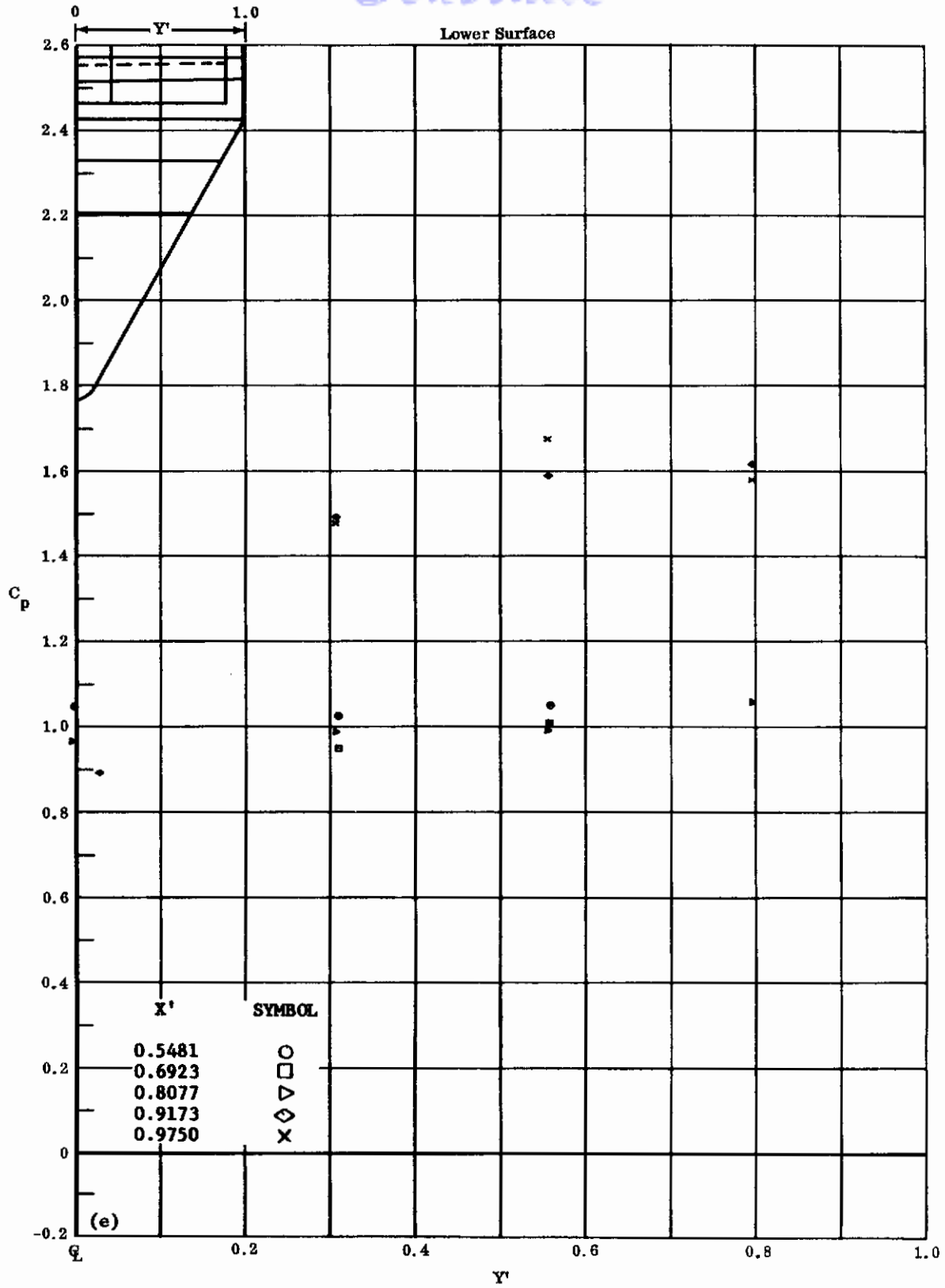

Fig. 11 Configuration I, $\alpha = +40$, $\delta_2 = \delta_3 = 0$

c) C_p vs. Y' , lower surface

d) C_p vs. Y' , upper surface



(NONDIMENSIONAL SEMISPAN DISTANCE)

Fig. 11e Configuration I, $\alpha = +40$, $\delta_2 = \delta_3 = +10$

C_p vs. Y' , lower surface

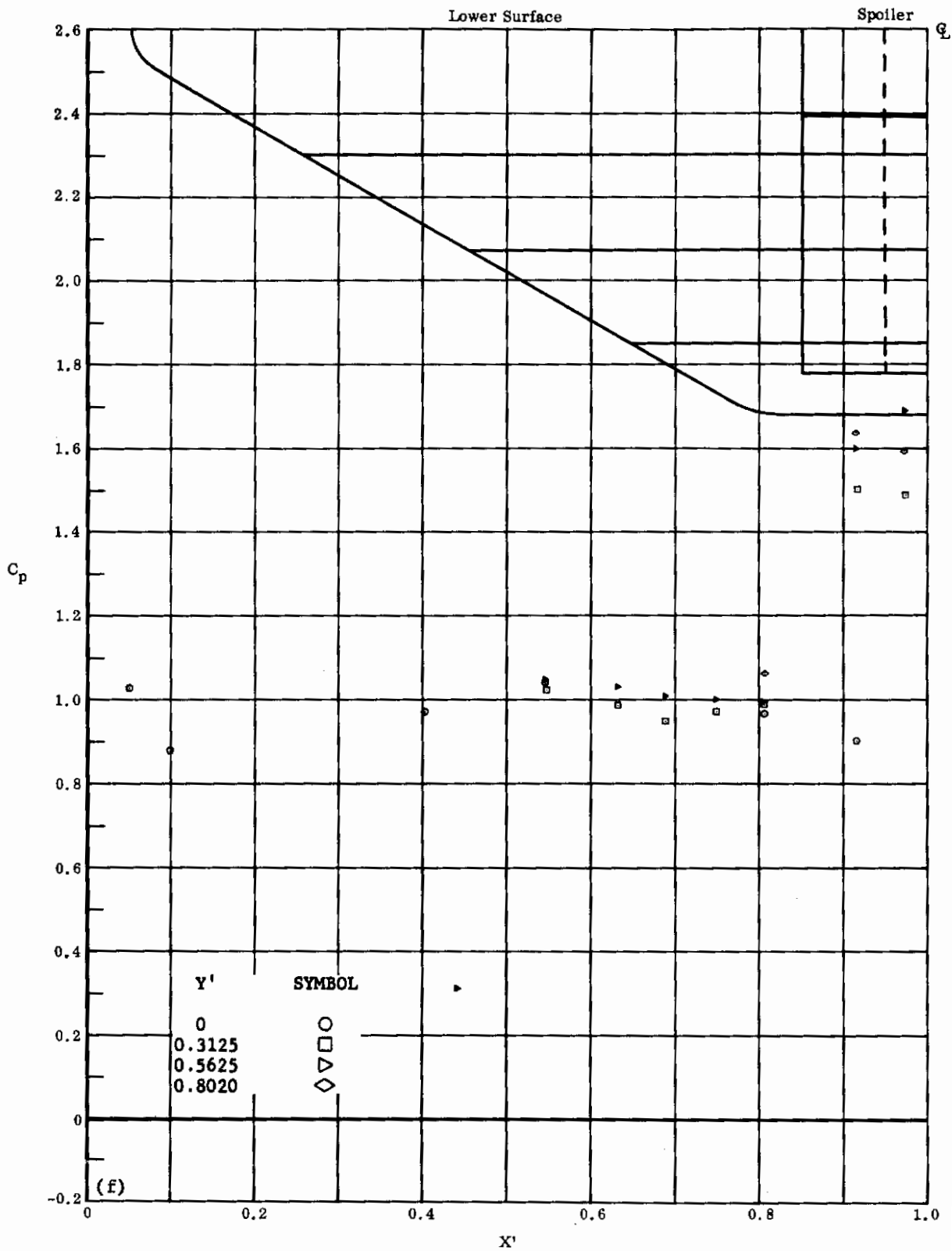

(NONDIMENSIONAL STREAMWISE DISTANCE FROM VIRTUAL APEX)

Fig. 11f Configuration I, $\alpha = +40$, $\delta_2 = \delta_3 = +10$

C_p vs. X' , lower surface

Contrails

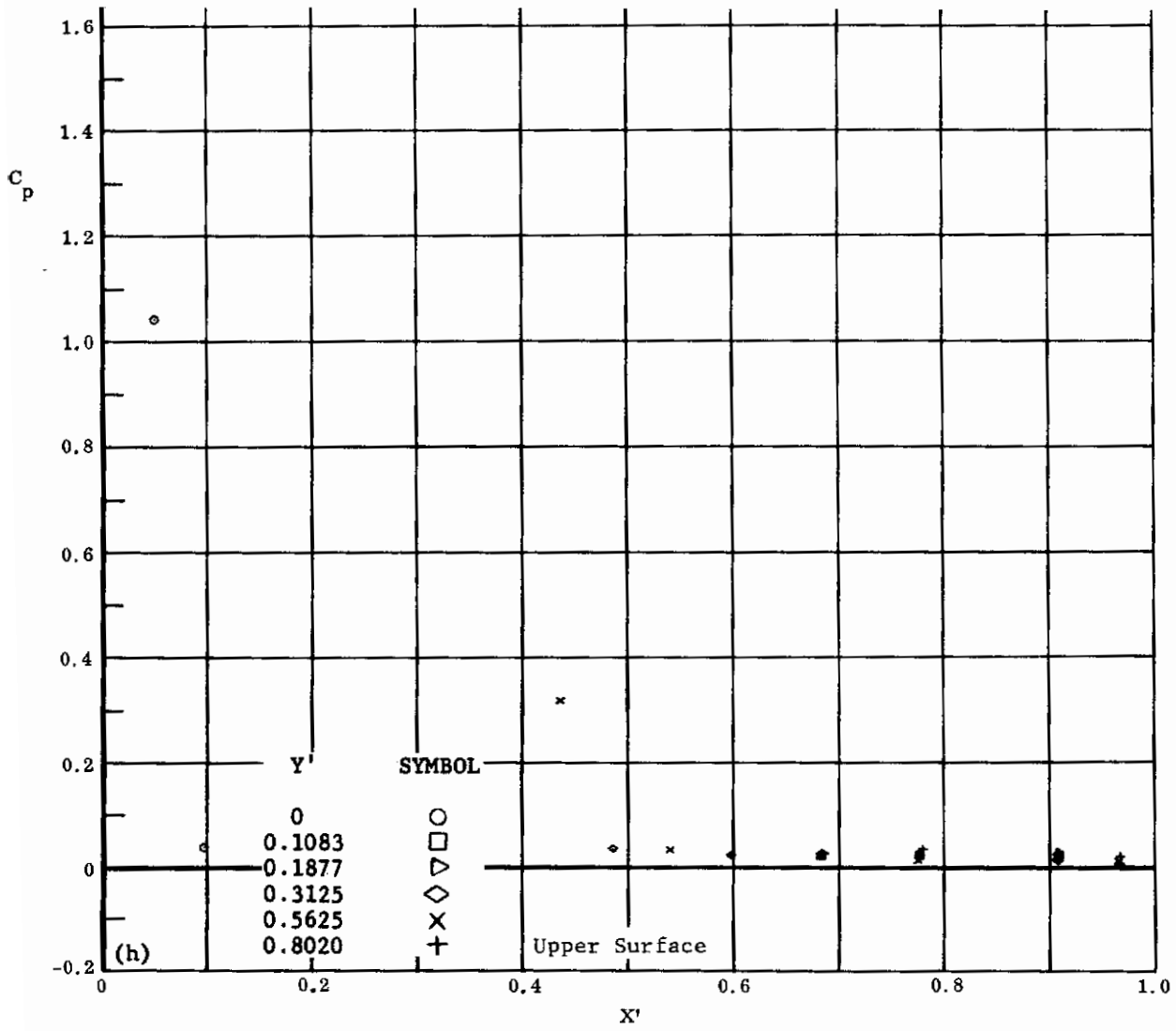
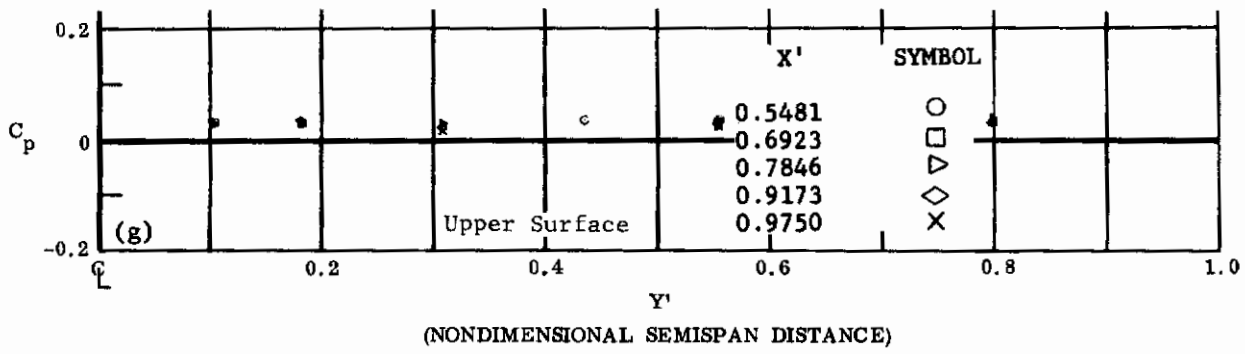

(NONDIMENSIONAL STREAMWISE DISTANCE FROM VIRTUAL APEX)

Fig. 11 Configuration I, $\alpha = +40$, $\delta_2 = \delta_3 = +10$

g) C_p vs. Y' , upper surface

h) C_p vs. X' , upper surface

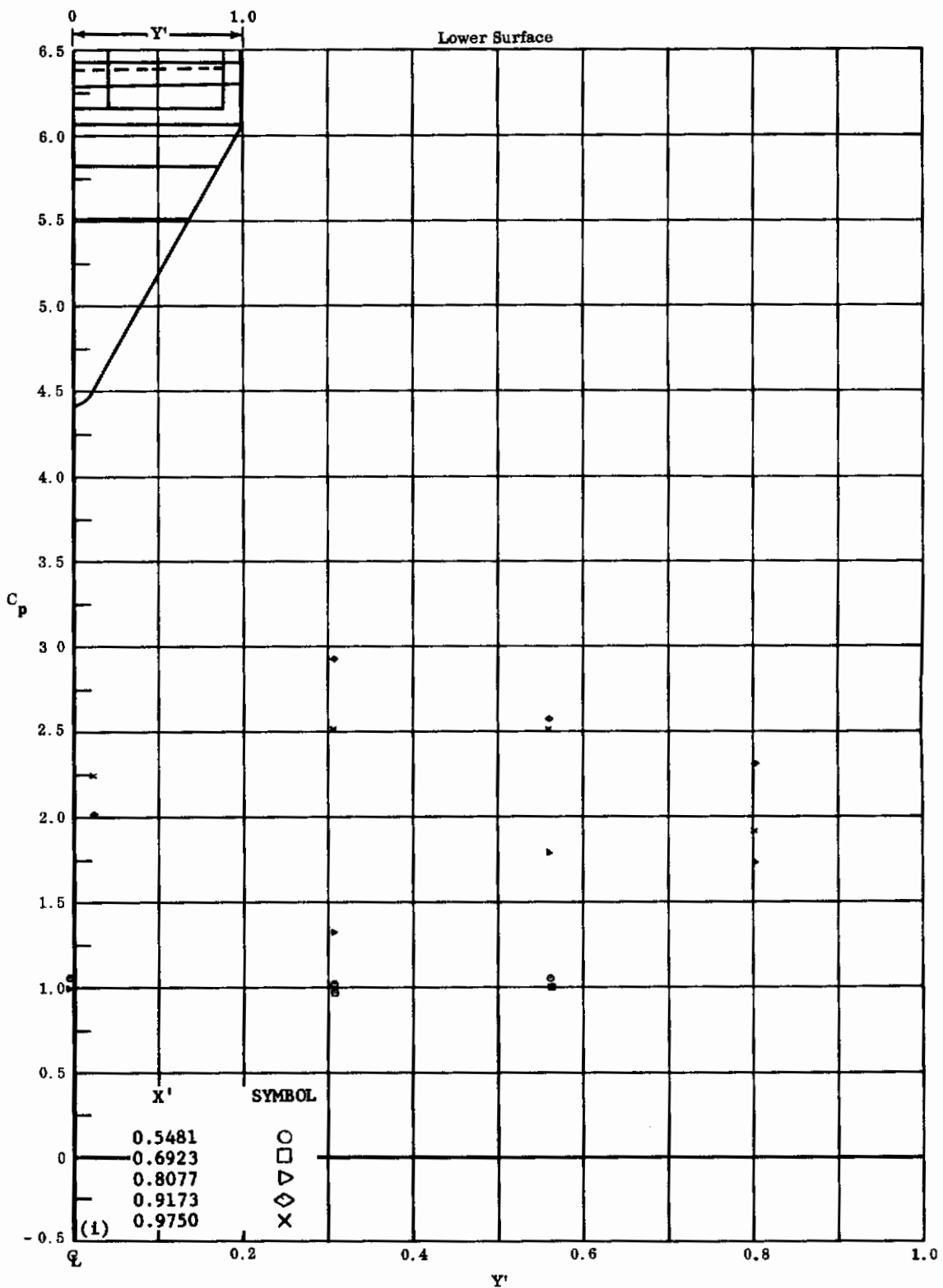

(NONDIMENSIONAL SEMISPAN DISTANCE)

Fig. 111 Configuration I, $\alpha = +40^\circ$, $\delta_2 = \delta_3 = +20$
 C_p vs. Y' , lower surface

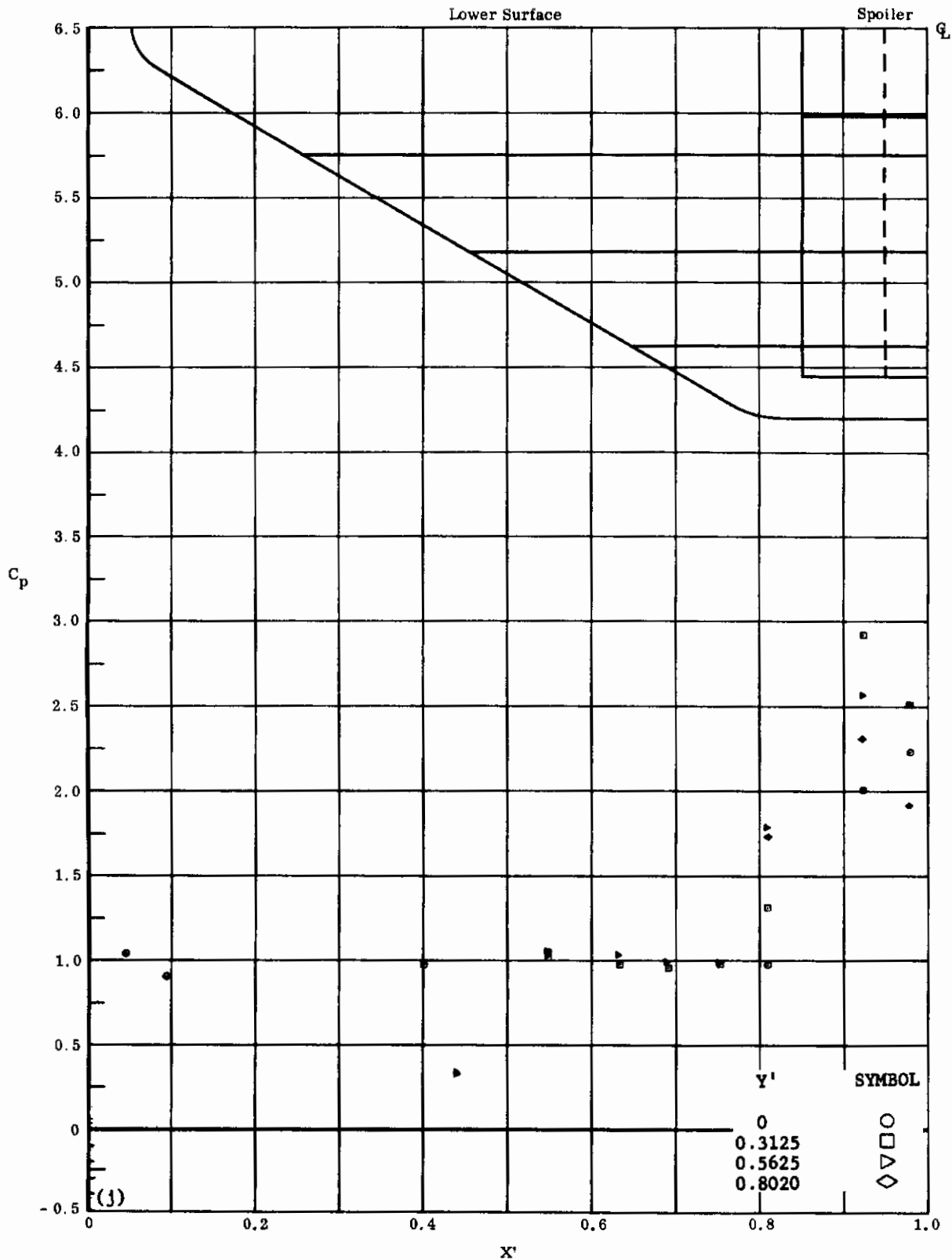

(NONDIMENSIONAL STREAMWISE DISTANCE FROM VIRTUAL APEX)

Fig. 11j Configuration I, $\alpha = +40$, $\delta_2 = \delta_3 = +20$

C_p vs. X' , lower surface

Contrails

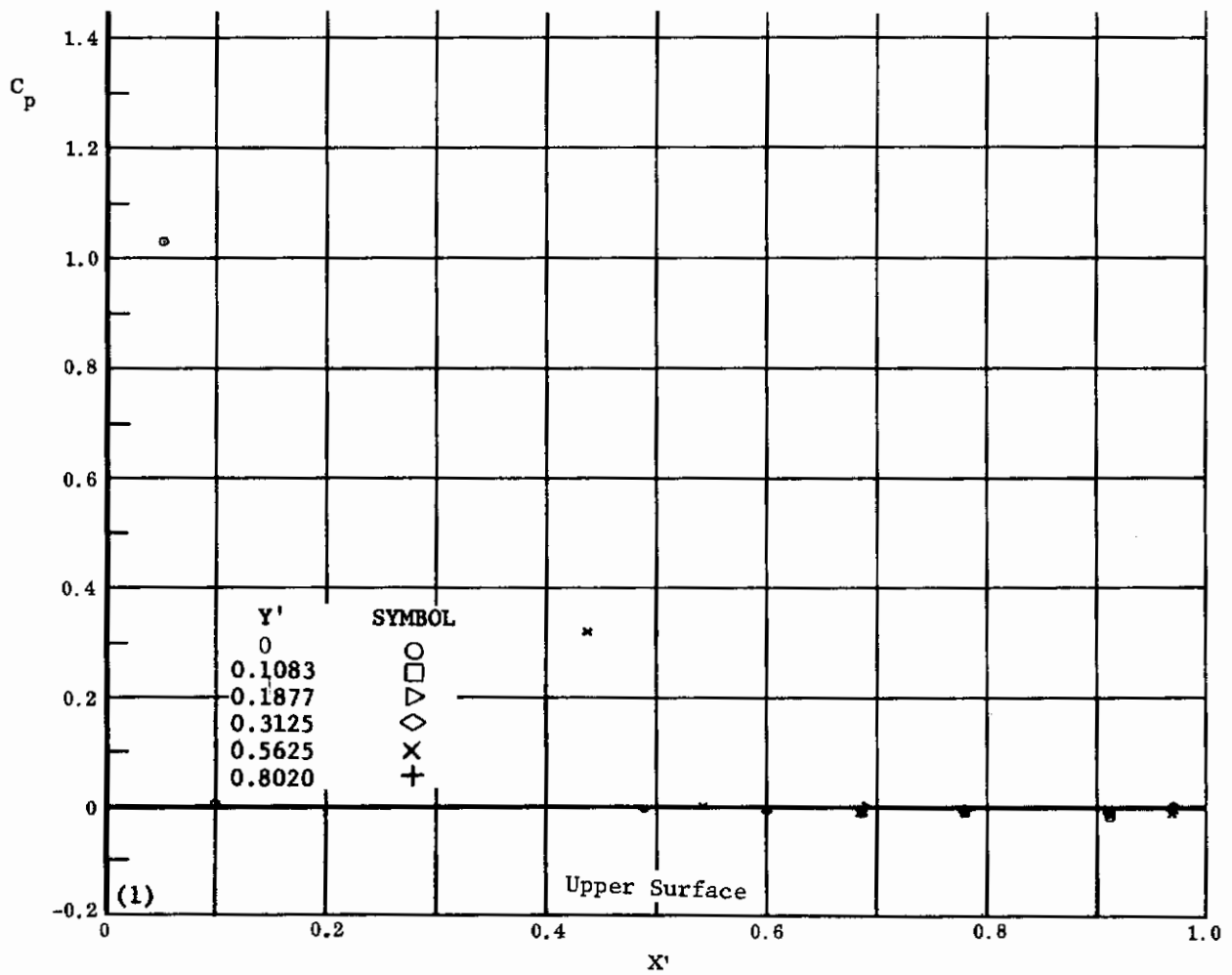
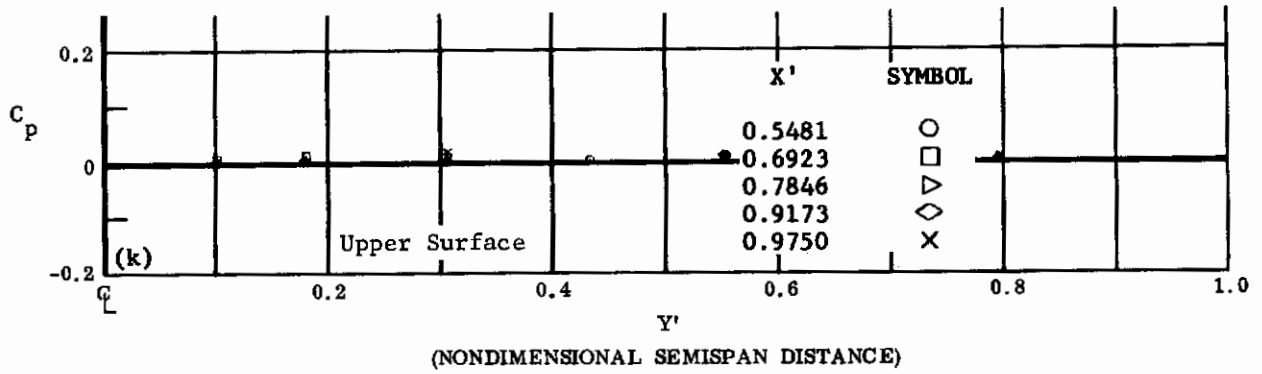

(NONDIMENSIONAL STREAMWISE DISTANCE FROM VIRTUAL APEX)

Fig. 11 Configuration I, $\alpha = +40$, $\delta_2 = \delta_3 = +20$

k) C_p vs. Y' , upper surface

l) C_p vs. X' , upper surface

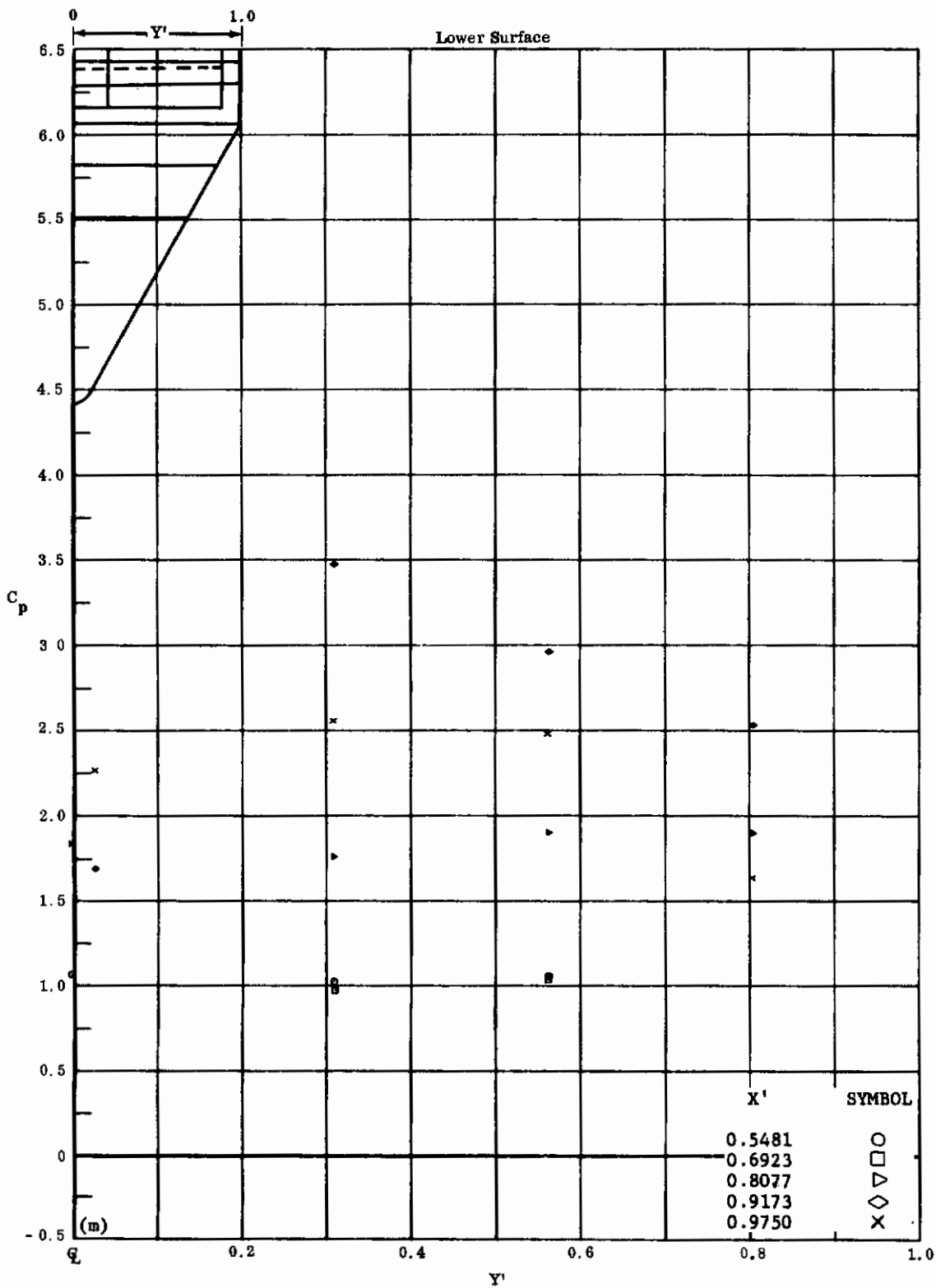

(NONDIMENSIONAL SEMISPAN DISTANCE)

Fig. 11m Configuration I, $\alpha = +40$, $\delta_2 = \delta_3 = +30$

C_p vs. Y' , lower surface

Contrails

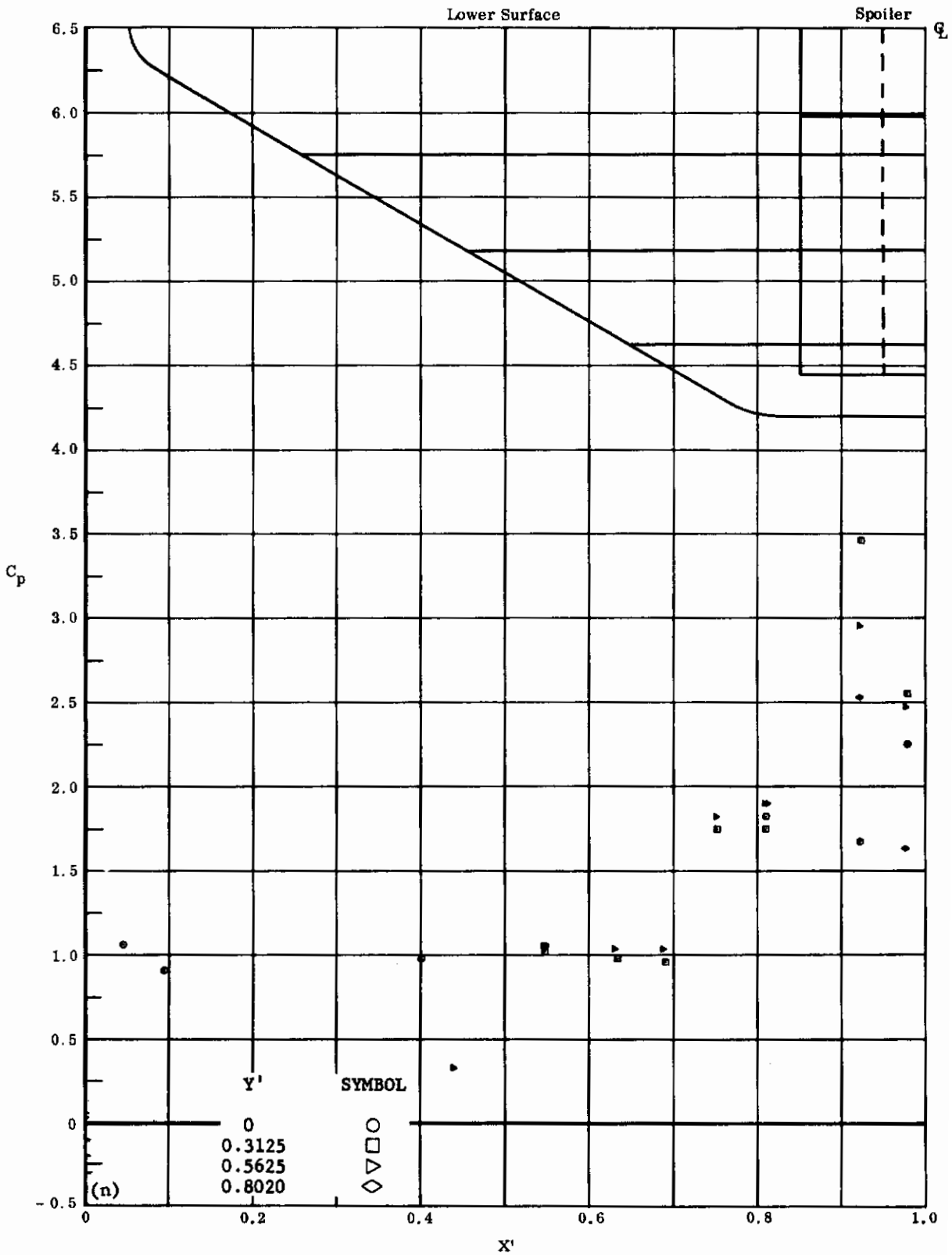

(NONDIMENSIONAL STREAMWISE DISTANCE FROM VIRTUAL APEX)

Fig. 11n Configuration I, $\alpha = +40$, $\delta_2 = \delta_3 = +30$

C_p vs. X' , lower surface

Contrails

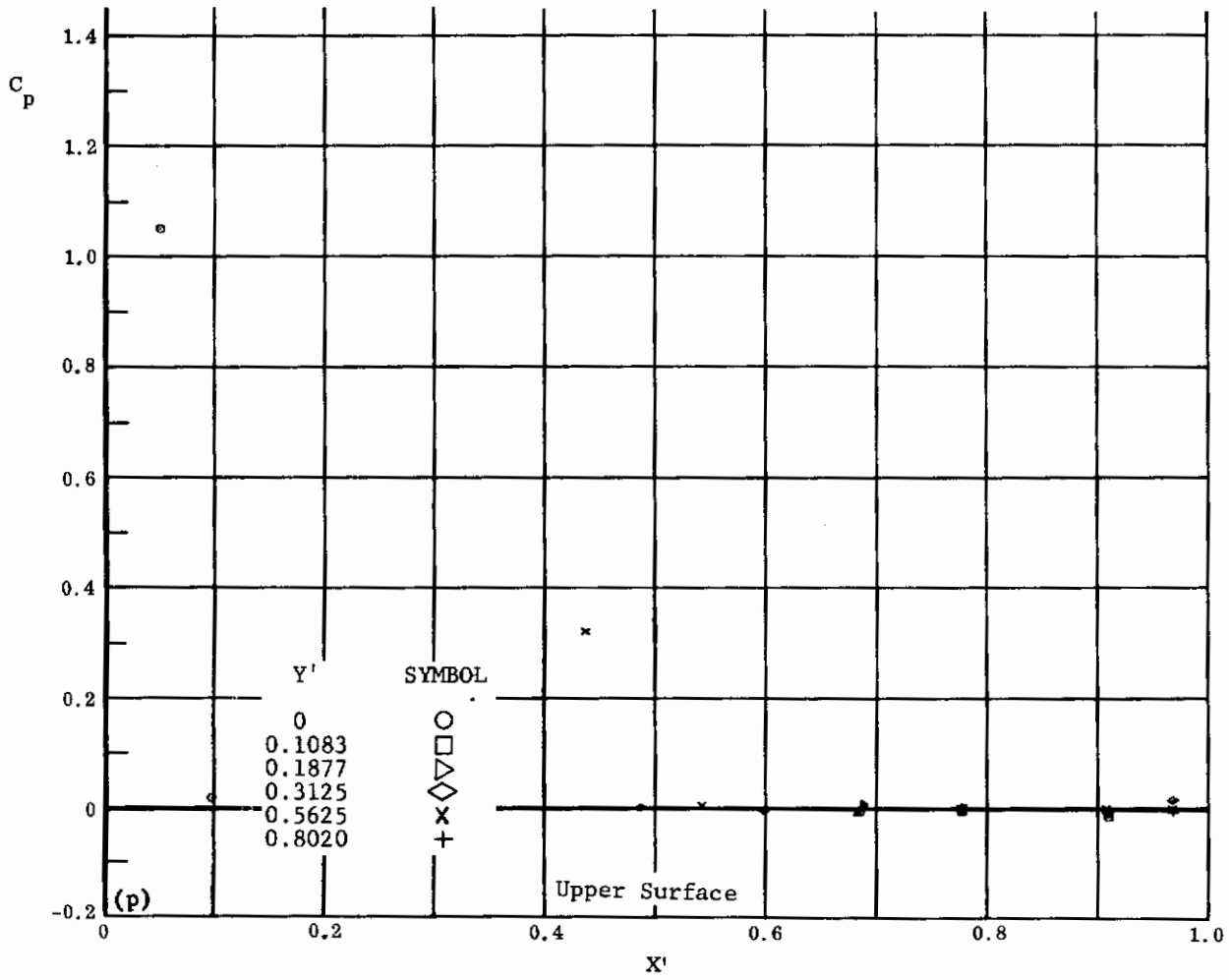
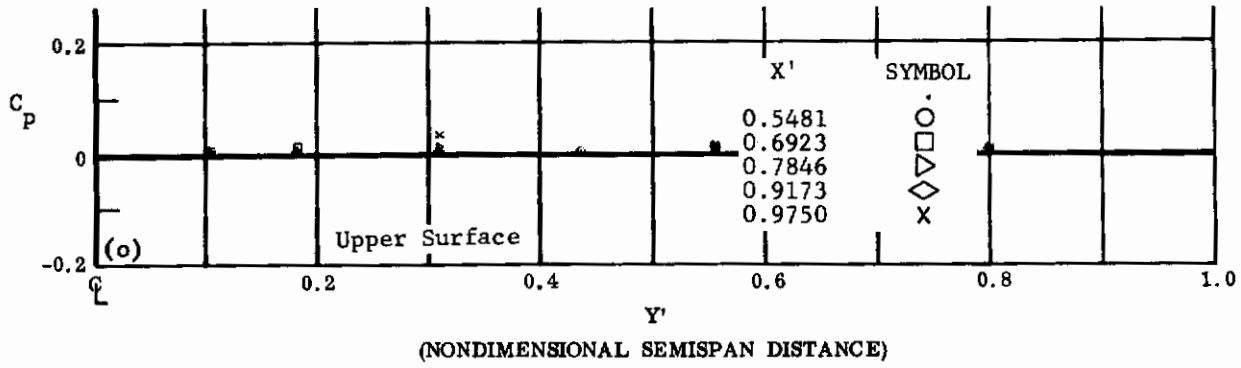

(NONDIMENSIONAL STREAMWISE DISTANCE FROM VIRTUAL APEX)

Fig. 11 Configuration I $\alpha = +40$, $\delta_2 = \delta_3 = +30$

o) C_p vs. Y' , upper surface

p) C_p vs. X' , upper surface

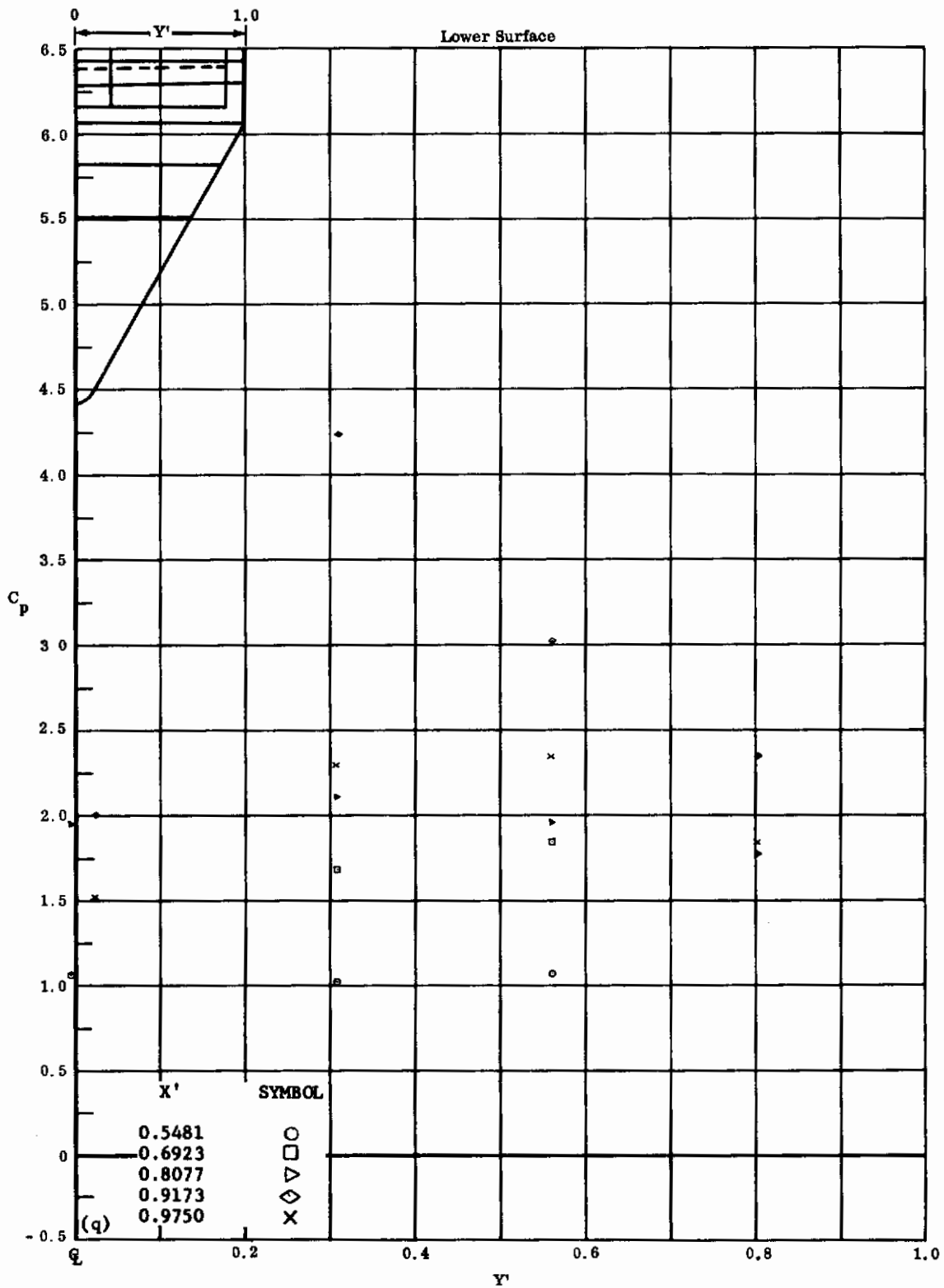

(NONDIMENSIONAL SEMISPAN DISTANCE)

Fig. 11q Configuration I, $\alpha = +40$, $\delta_2 = \delta_3 = +39$

C_p vs. Y' , lower surface

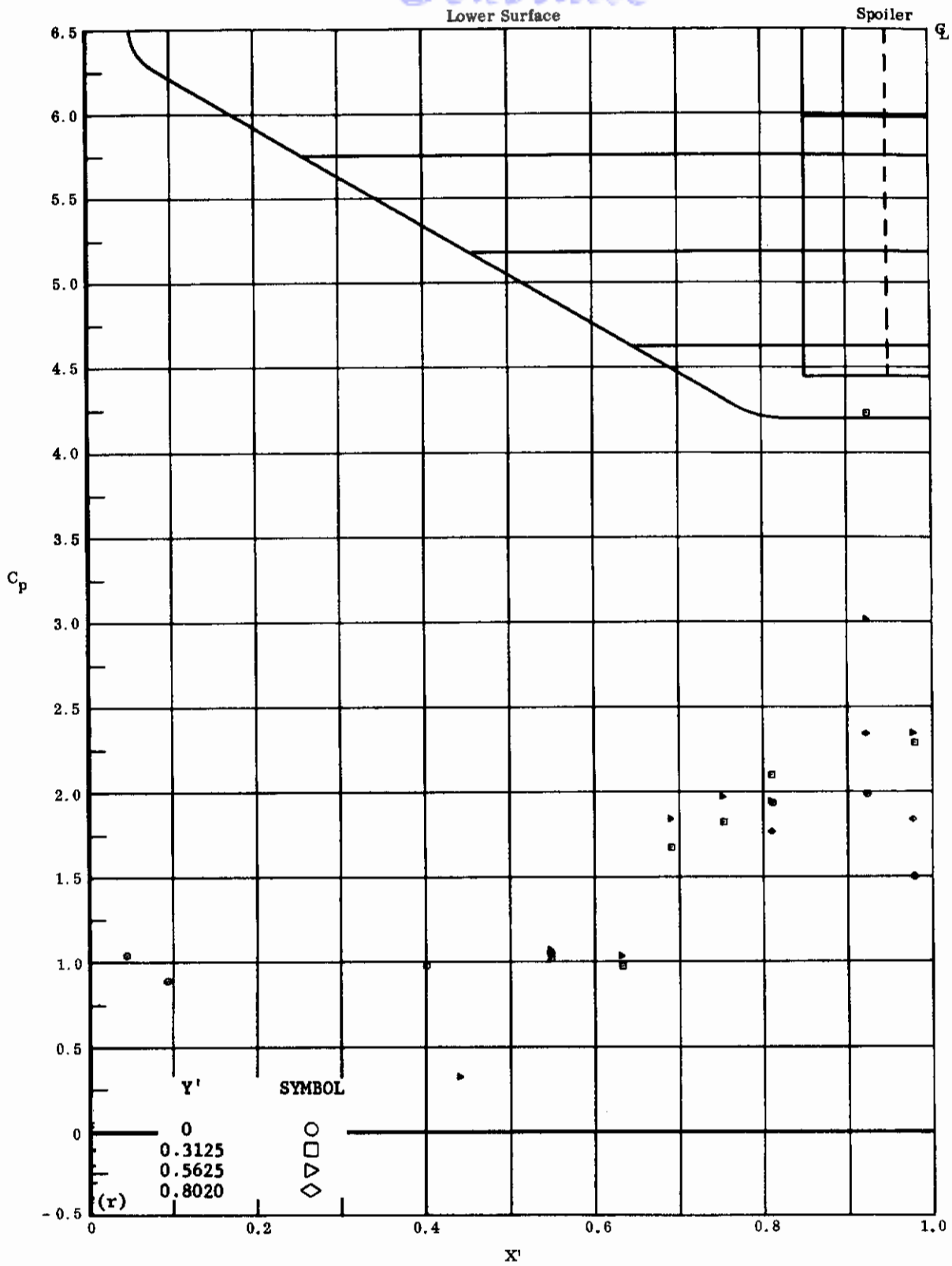

(NONDIMENSIONAL STREAMWISE DISTANCE FROM VIRTUAL APEX)

Fig. 11r Configuration I, $\alpha = +40$, $\delta_2 = \delta_3 = +39$

C_p vs. X' , lower surface

Contrails

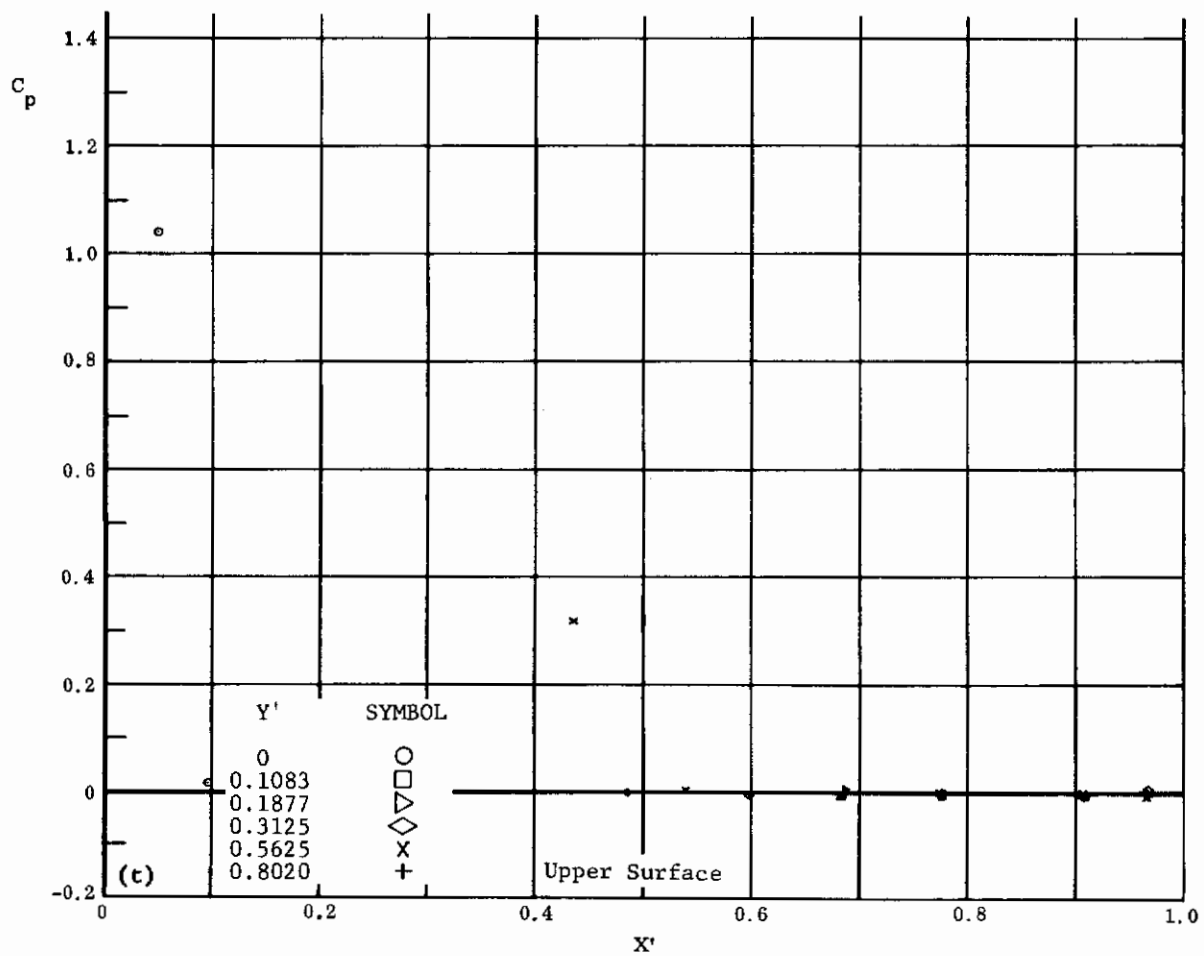
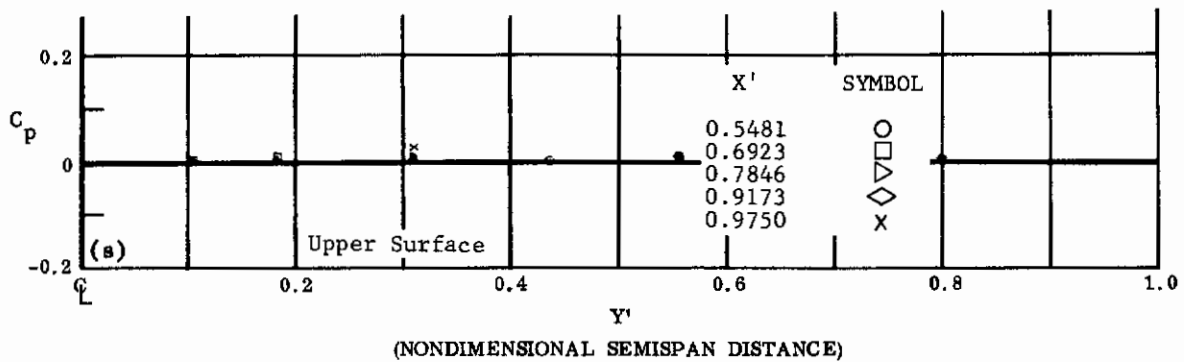

(NONDIMENSIONAL STREAMWISE DISTANCE FROM VIRTUAL APEX)

Fig. 11 Configuration I, $\alpha = +40$, $\delta_2 = \delta_3 = +39$

s) C_p vs. Y', upper surface

t) C_p vs. X', upper surface

Contrails

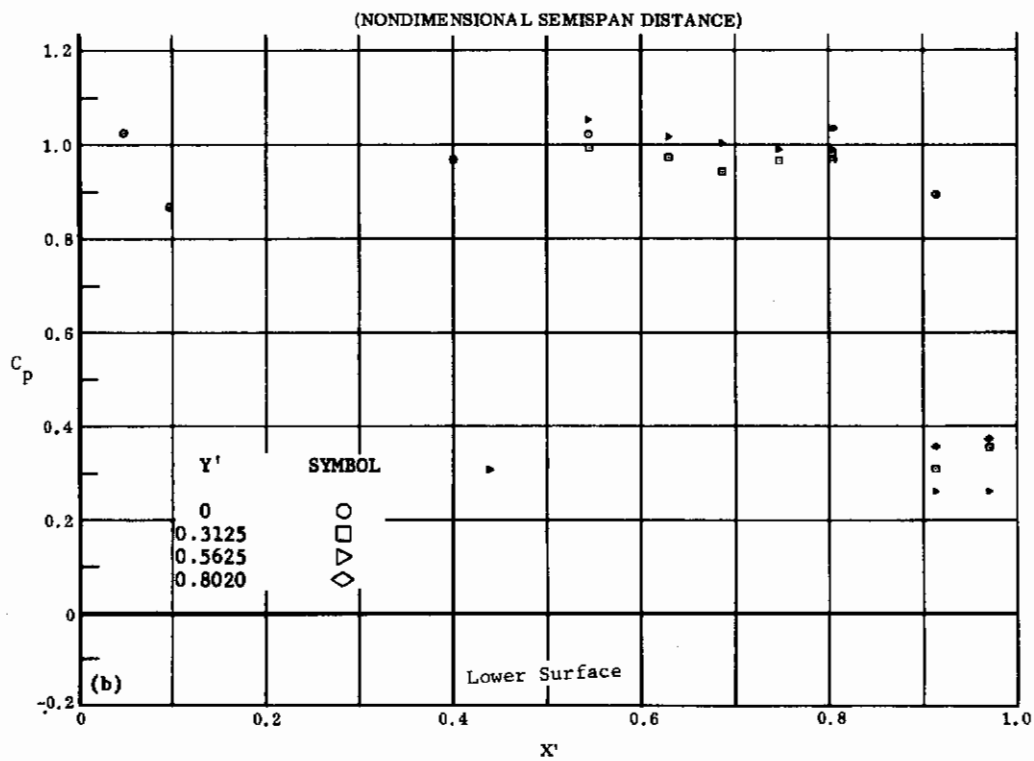
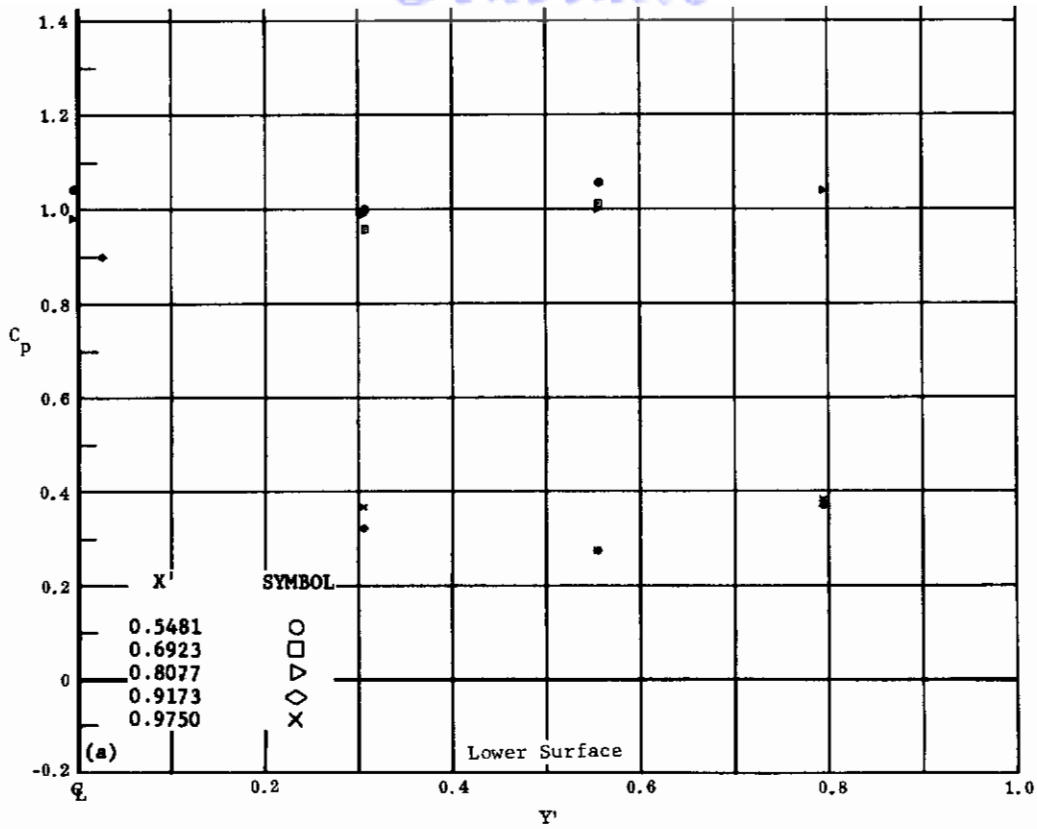

(NONDIMENSIONAL STREAMWISE DISTANCE FROM VIRTUAL APEX)

Fig. 12 Configuration I, $\alpha = +40$, $\delta_2 = \delta_3 = -20$

a) C_p vs. Y' , lower surface

b) C_p vs. X' , lower surface

Contrails

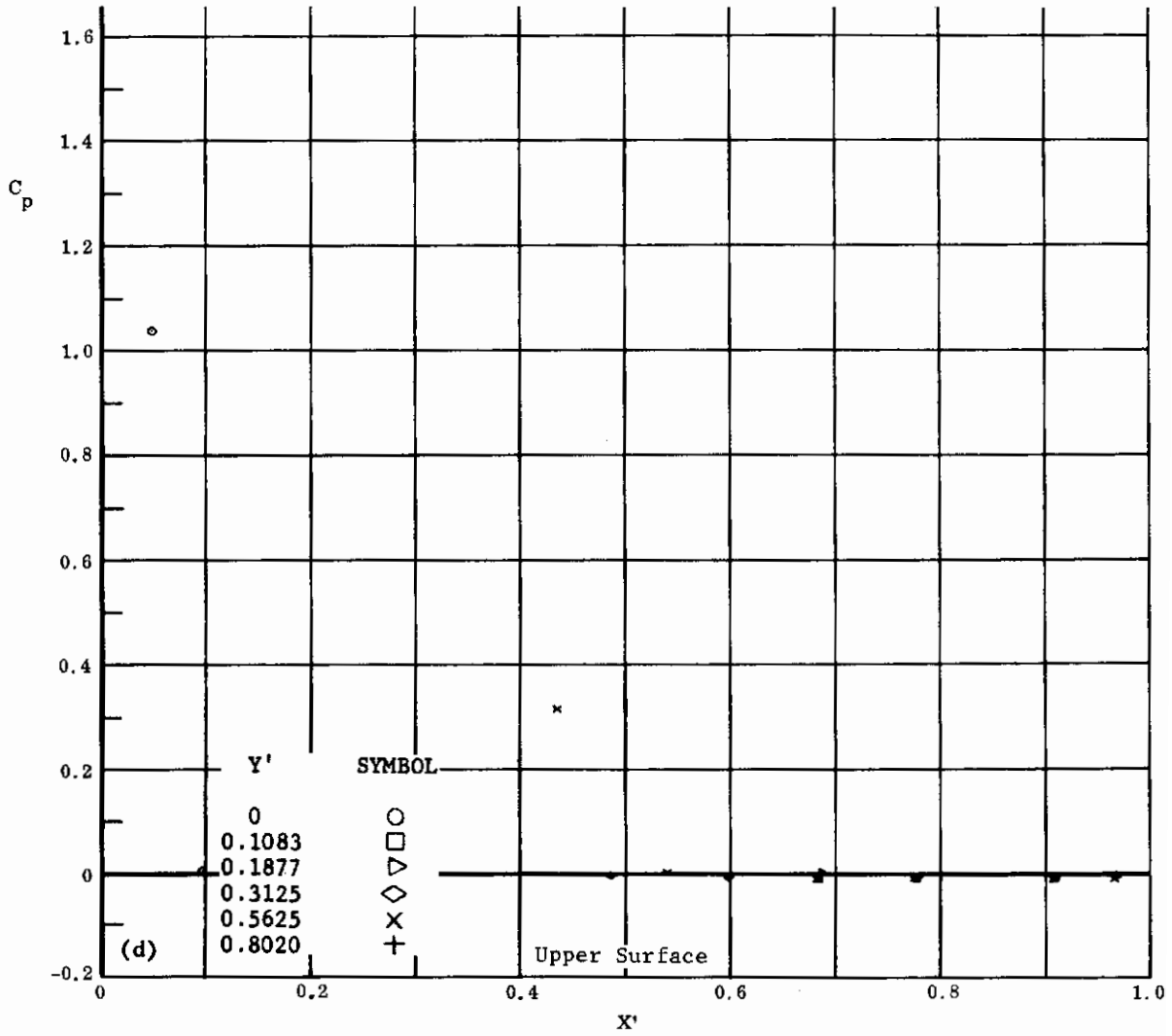
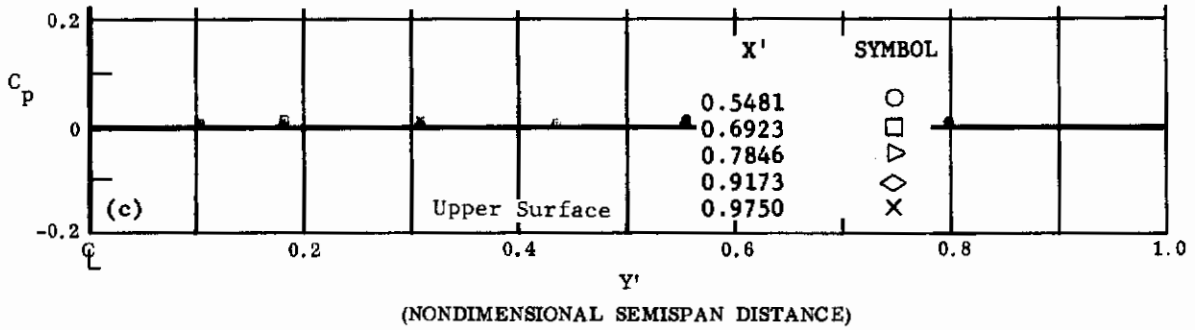

(NONDIMENSIONAL STREAMWISE DISTANCE FROM VIRTUAL APEX)

Fig. 12 Configuration I, $\alpha = +40$, $\delta_2 = \delta_3 = -20$

c) C_p vs. Y' , upper surface

d) C_p vs. X' , upper surface

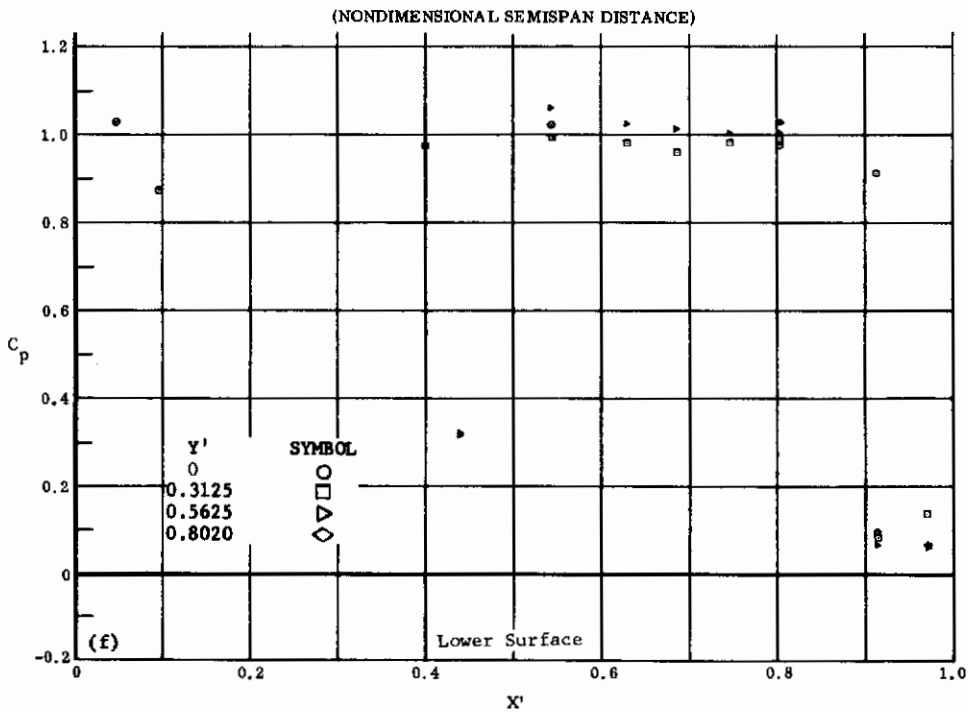
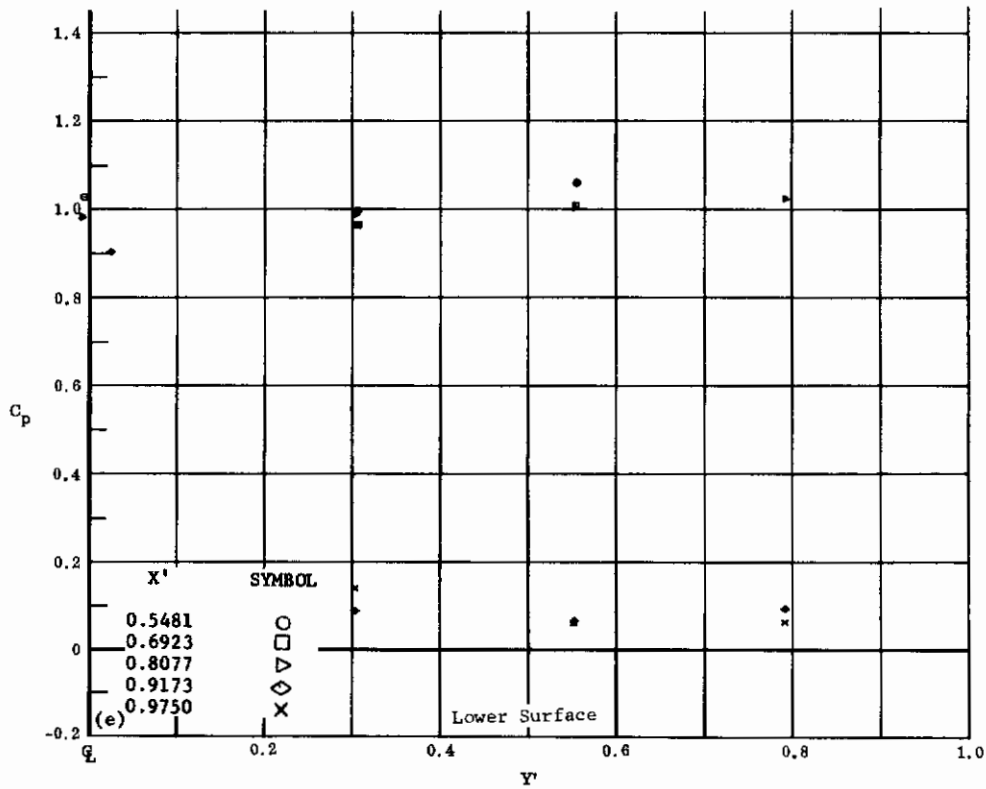

(NONDIMENSIONAL STREAMWISE DISTANCE FROM VIRTUAL APEX)

Fig. 12 Configuration I, $\alpha = +40$, $\delta_2 = \delta_3 = -39$

e) C_p vs. Y' , lower surface

f) C_p vs. X' , lower surface

Contrails

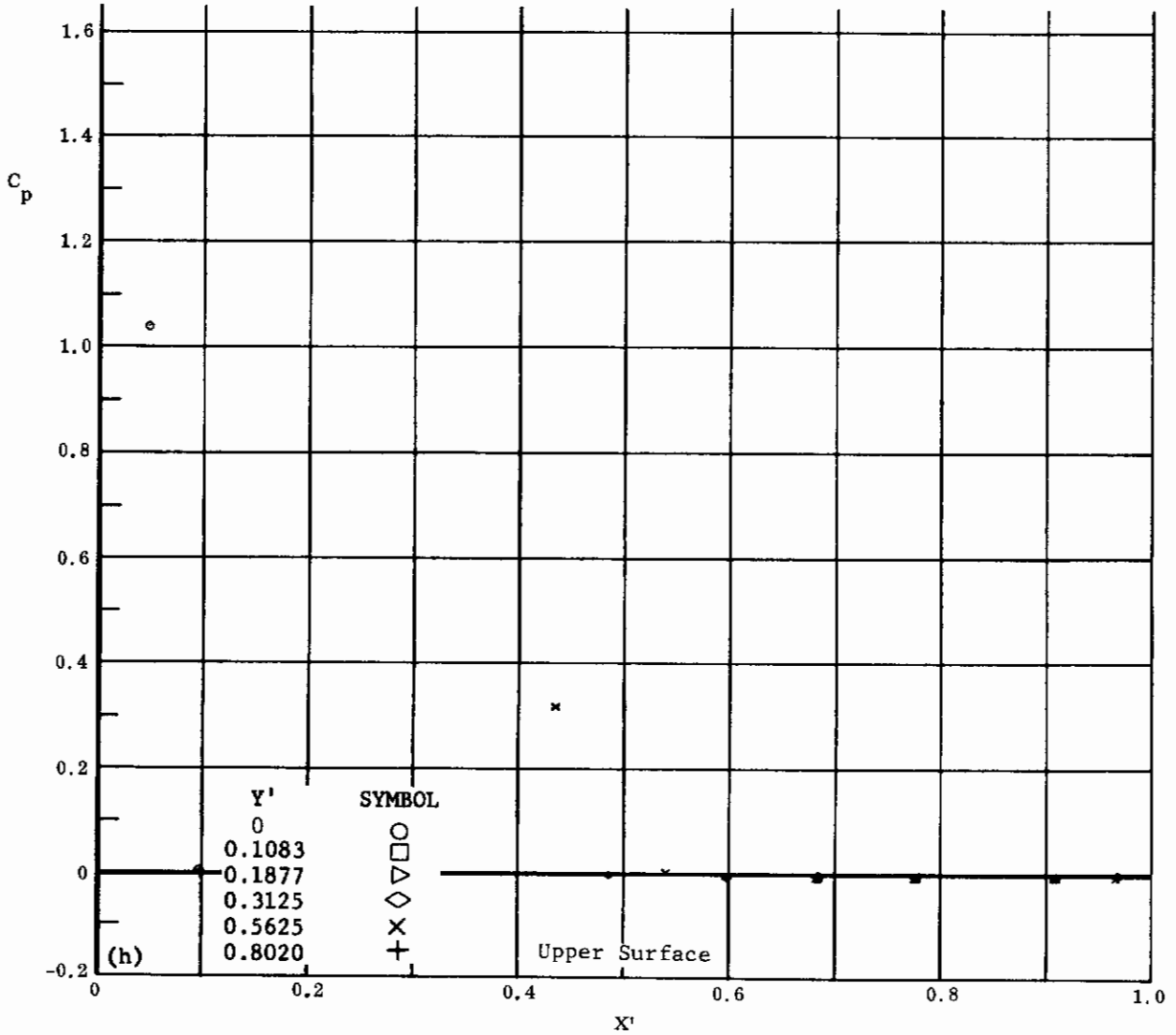
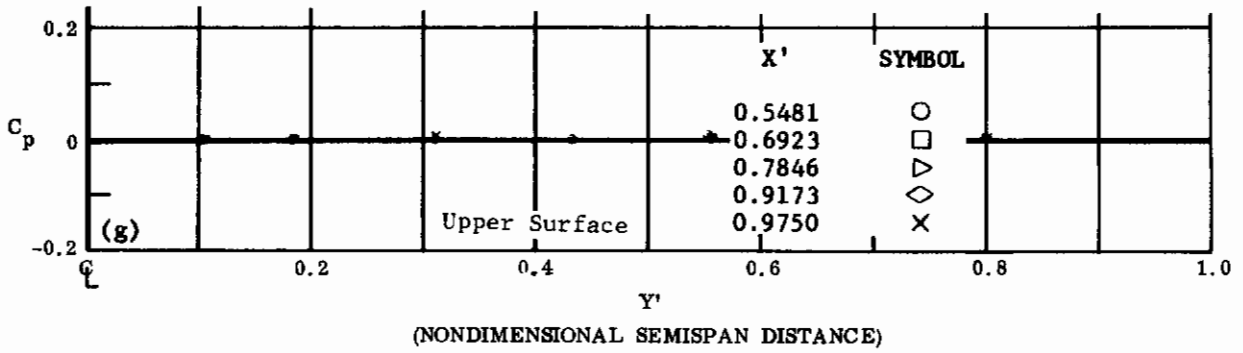

(NONDIMENSIONAL STREAMWISE DISTANCE FROM VIRTUAL APEX)

Fig. 12 Configuration I, $\alpha = +40$, $\delta_2 = \delta_3 = -39$

g) C_p vs. Y' , upper surface

h) C_p vs. X' , upper surface

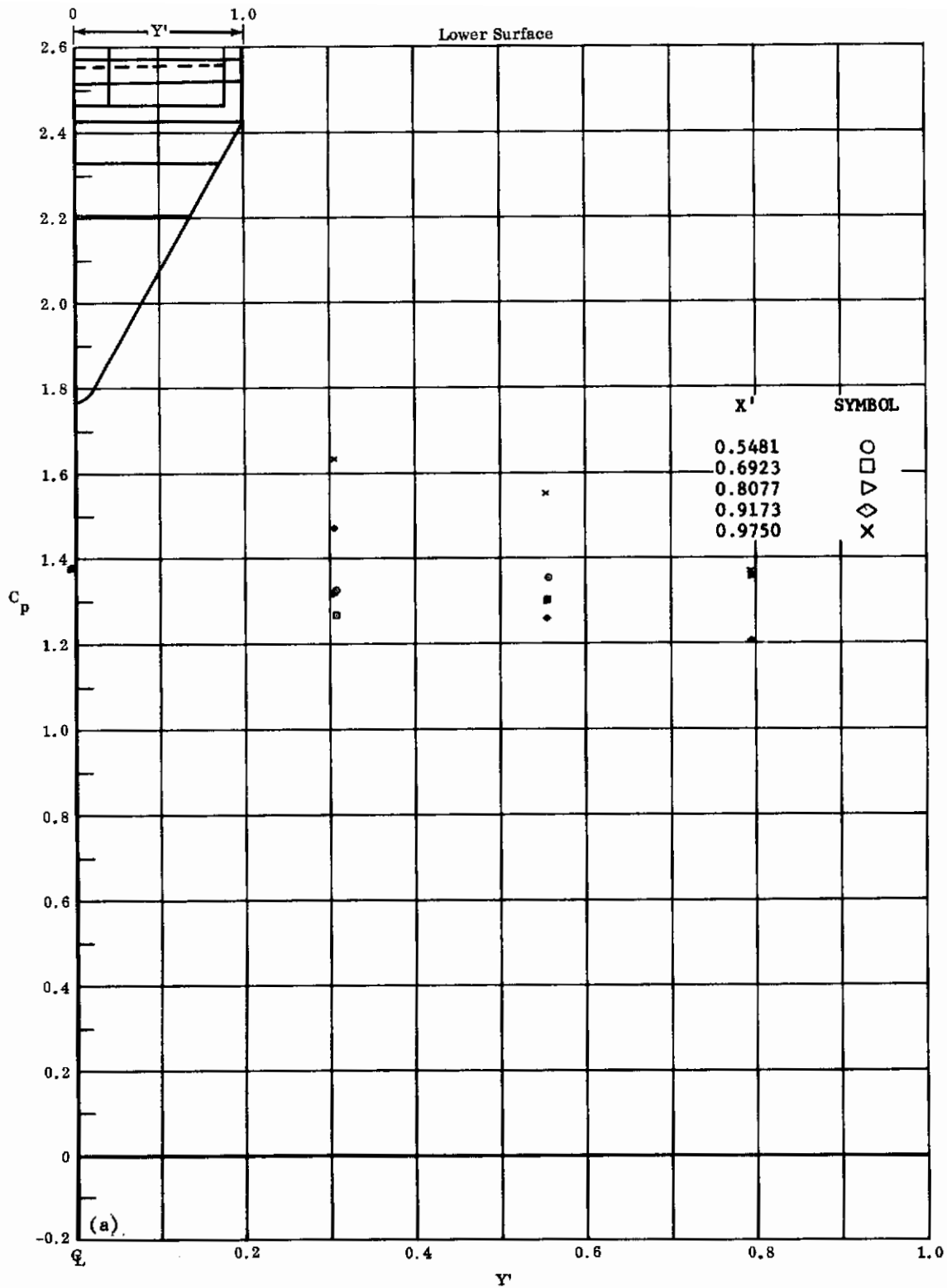
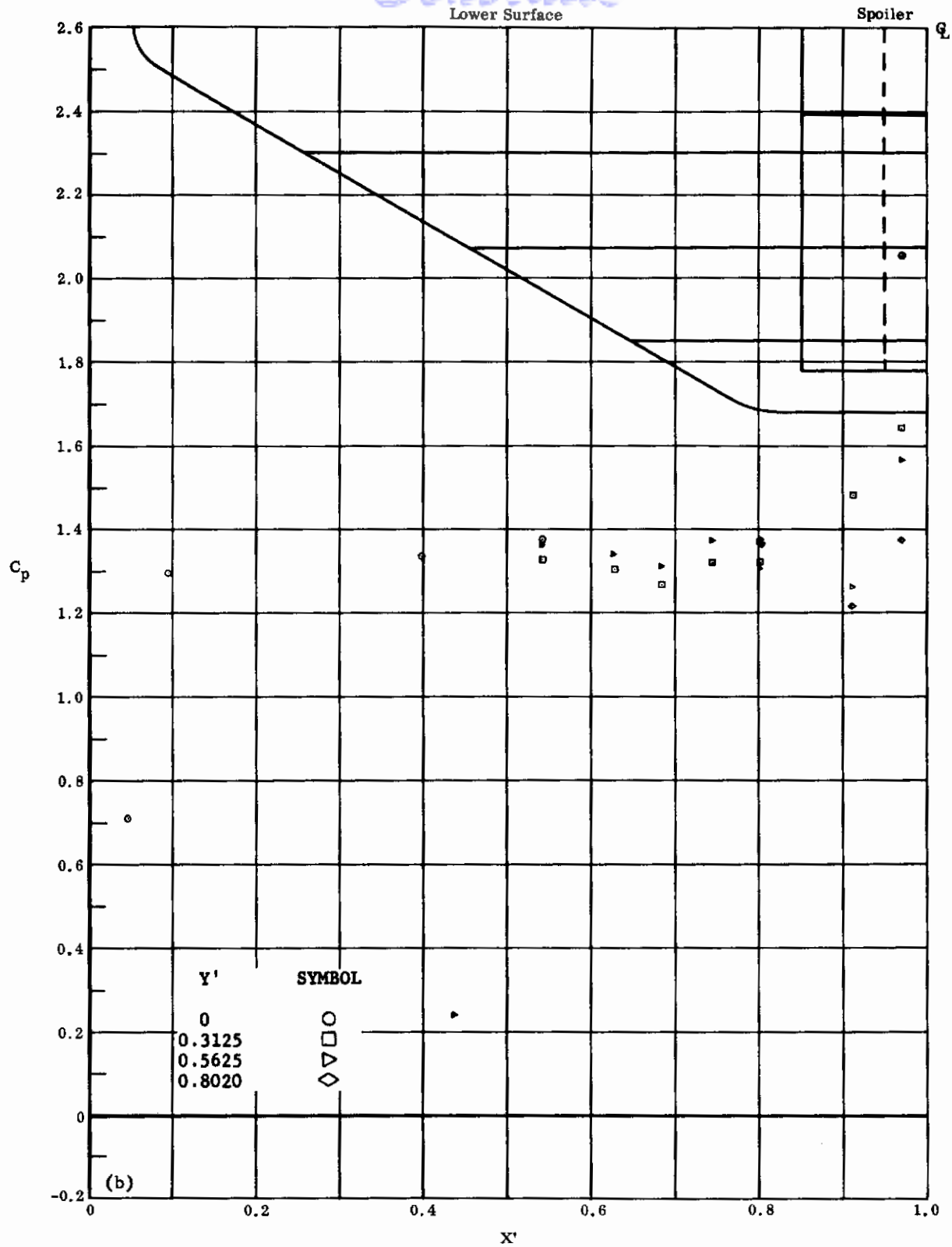

Fig. 13a Configuration I, $\alpha = +50$, $\delta_2 = \delta_3 = 0$

C_p vs. Y' , lower surface



(NONDIMENSIONAL STREAMWISE DISTANCE FROM VIRTUAL APEX)

Fig. 13b Configuration I, $\alpha = +50$, $\delta_2 = \delta_3 = 0$

C_p vs. X' , lower surface

Contrails

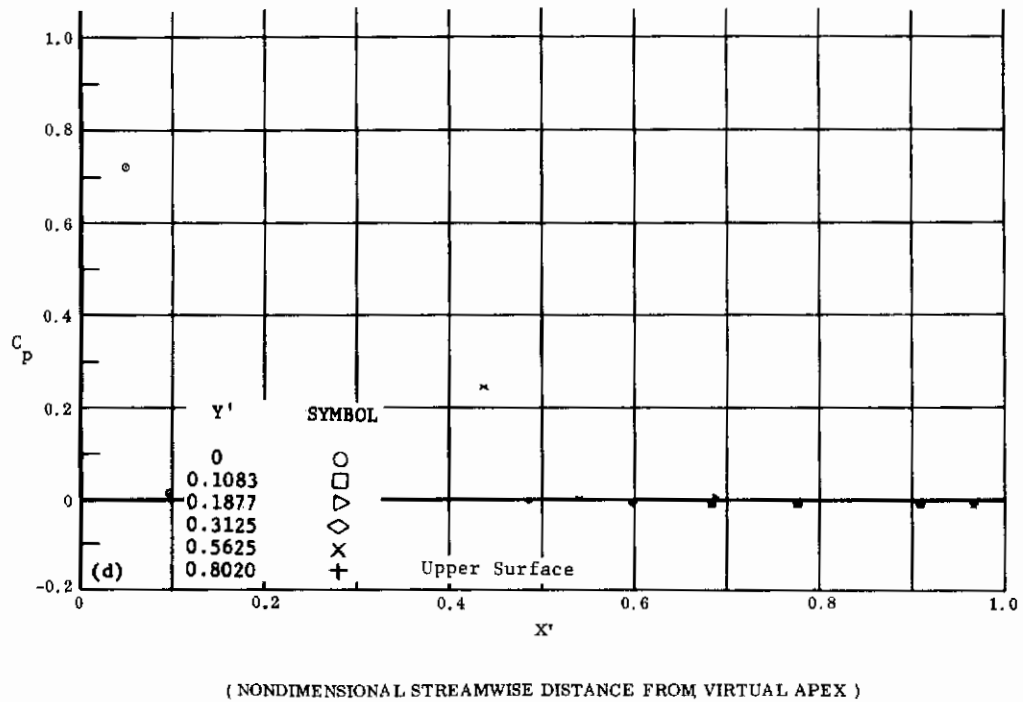
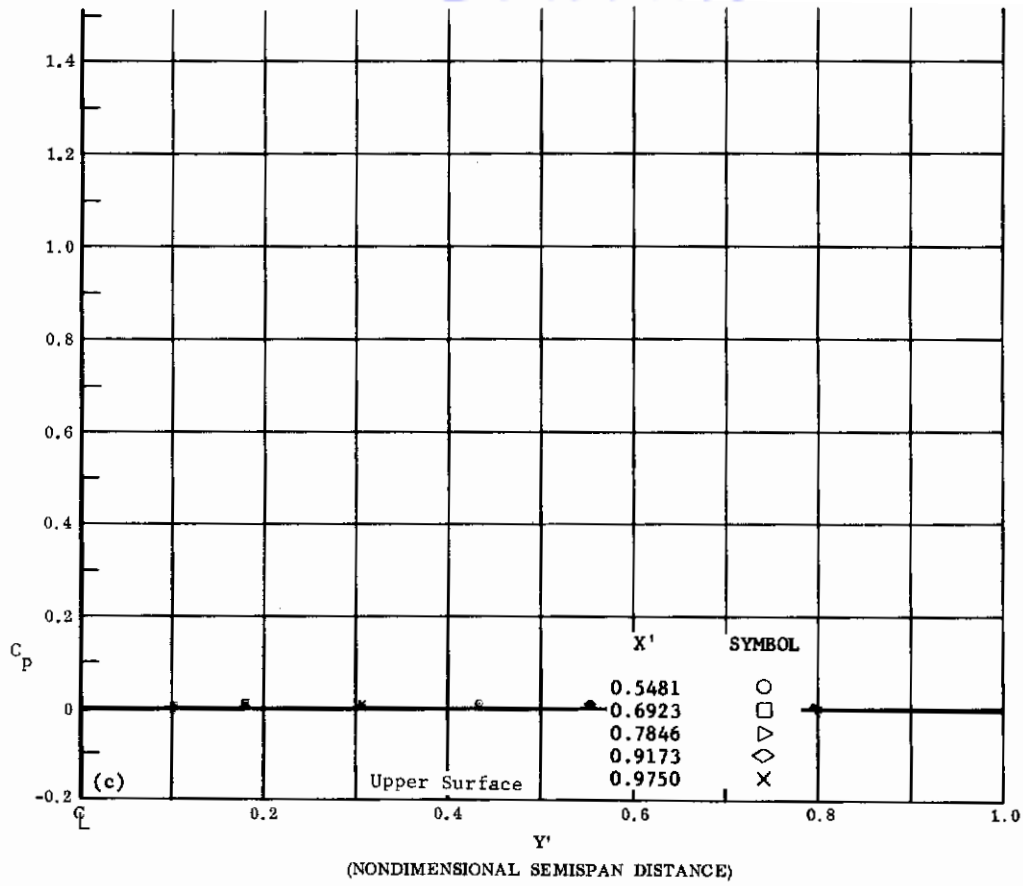
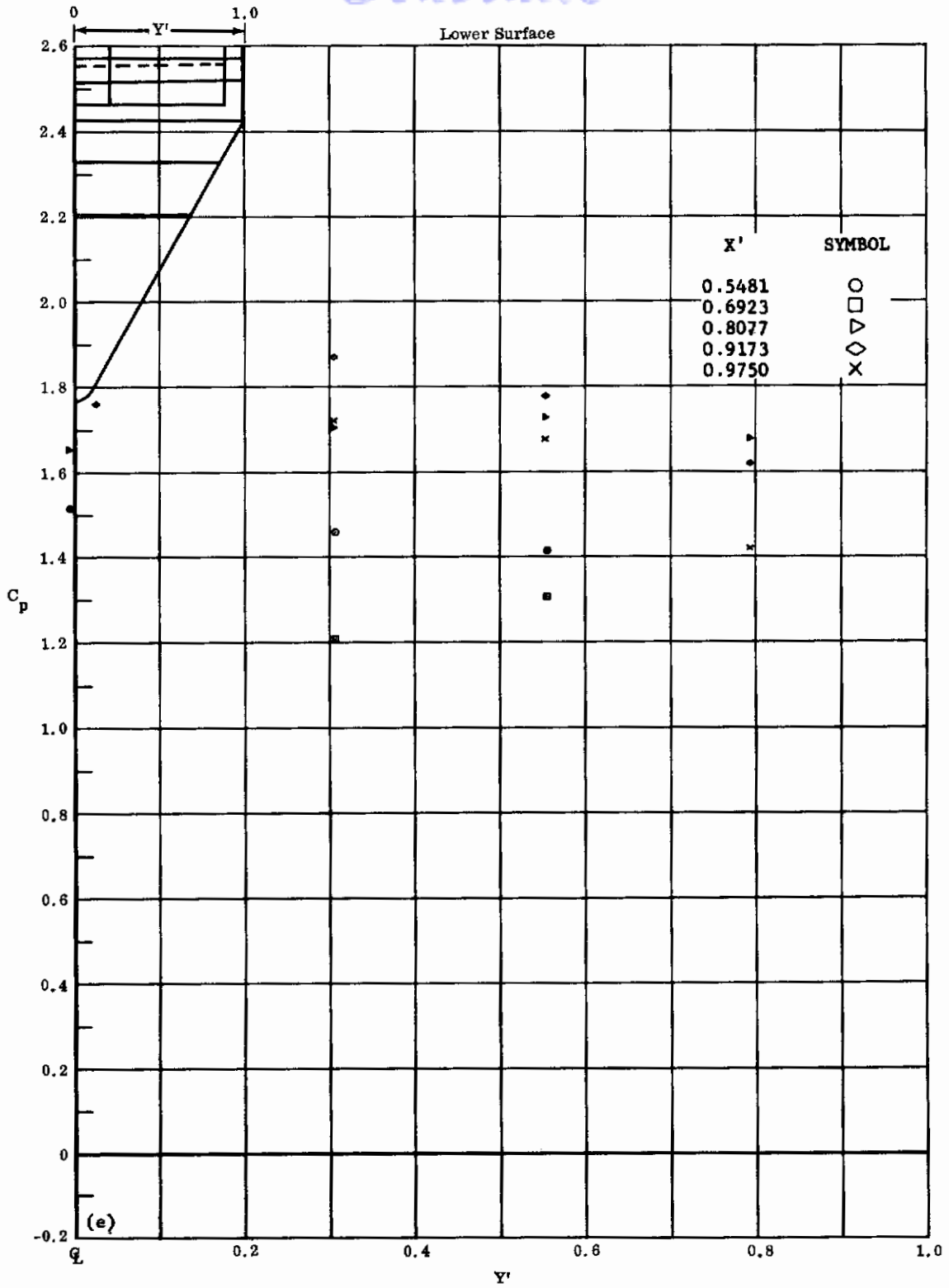

Fig. 13 Configuration I, $\alpha = +50$, $\delta_2 = \delta_3 = 0$

- c) C_p vs. Y' , upper surface
- d) C_p vs. X' , upper surface



(NONDIMENSIONAL SEMISPAN DISTANCE)

Fig. 13e Configuration I, $\alpha = +50$, $\delta_2 = \delta_3 = +10$

C_p vs. Y' , lower surface

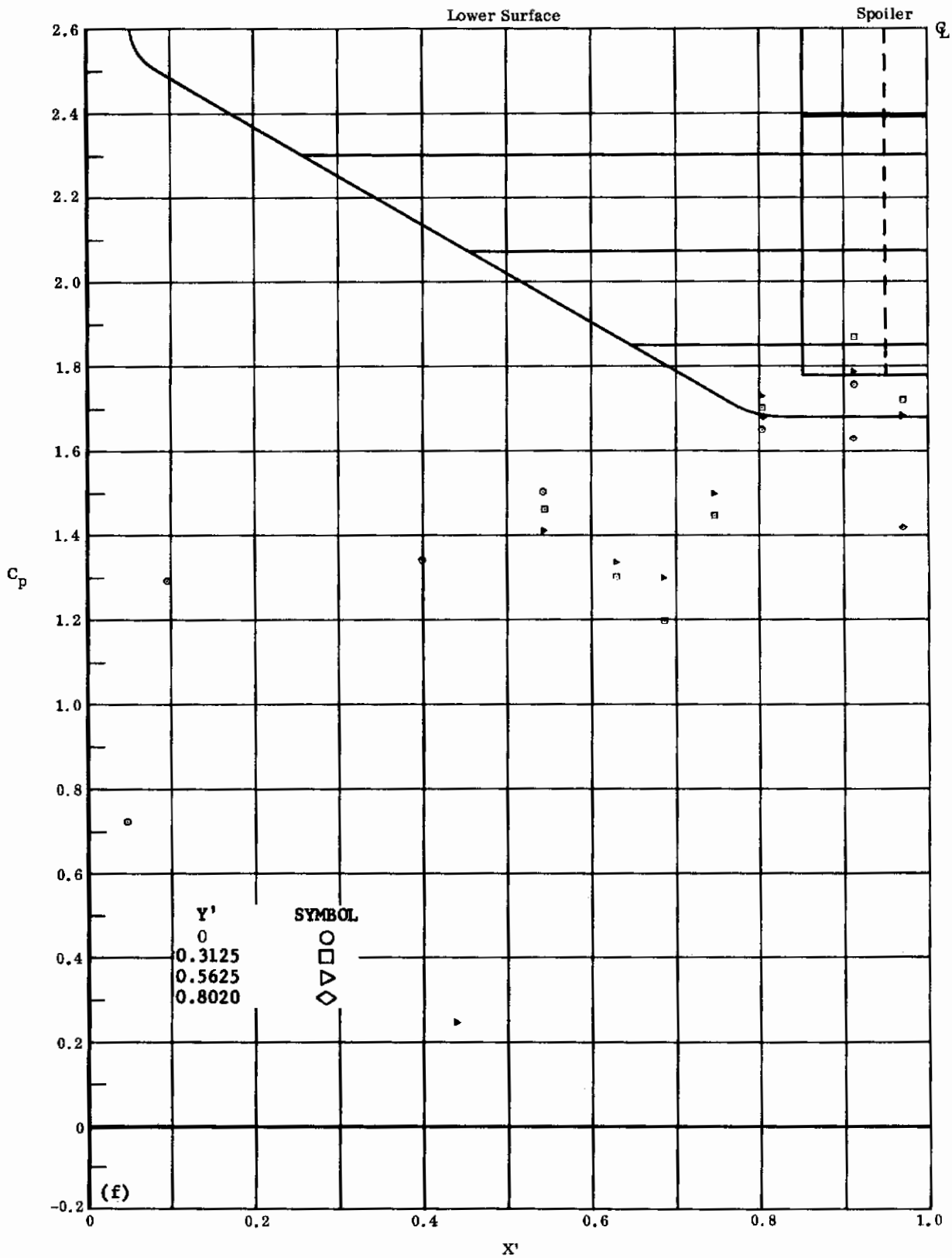

(NONDIMENSIONAL STREAMWISE DISTANCE FROM VIRTUAL APEX)

Fig. 13f Configuration I, $\alpha = +50$, $\delta_2 = \delta_3 = +10$

C_p vs. X' , lower surface

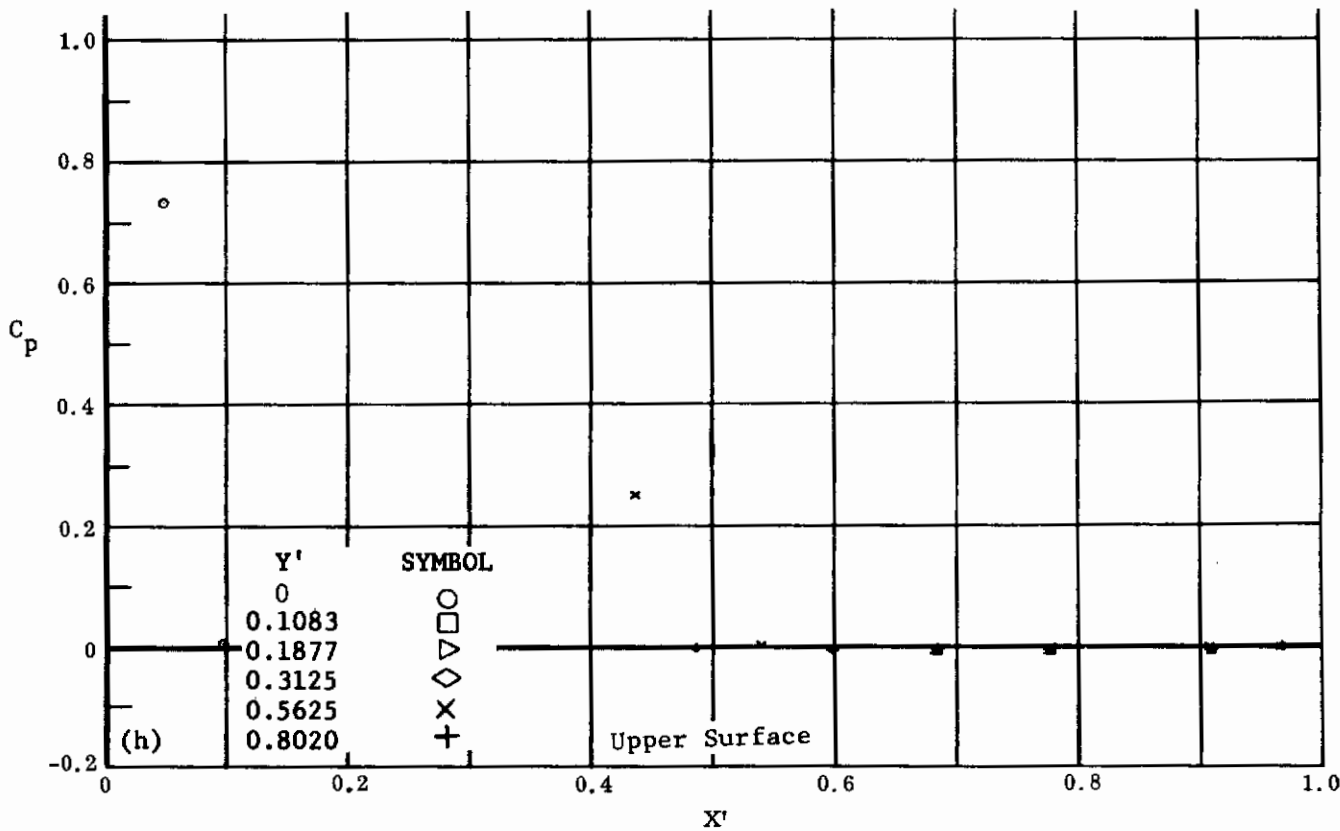
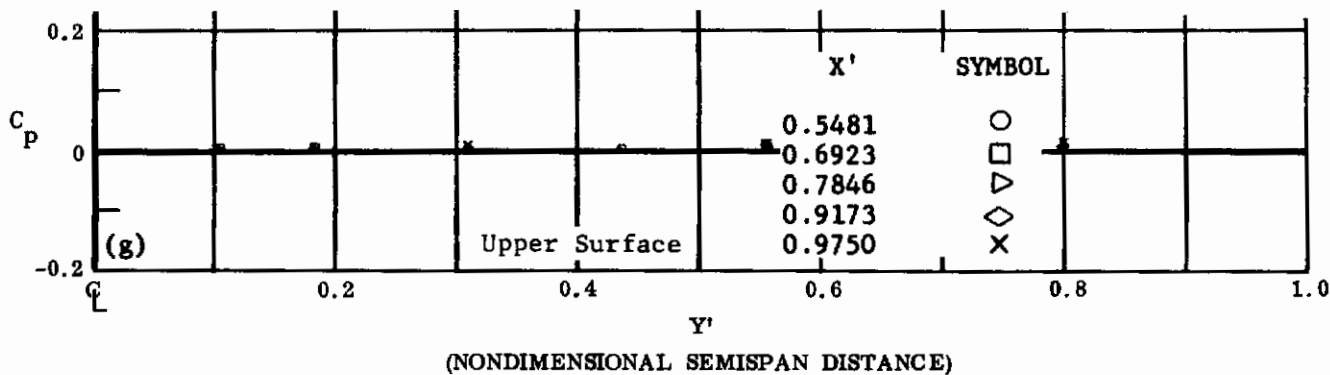

(NONDIMENSIONAL STREAMWISE DISTANCE FROM VIRTUAL APEX)

Fig. 13 Configuration I, $\alpha = +50$, $\delta_2 = \delta_3 = +10$

g) C_p vs. Y' , upper surface

h) C_p vs. X' , upper surface

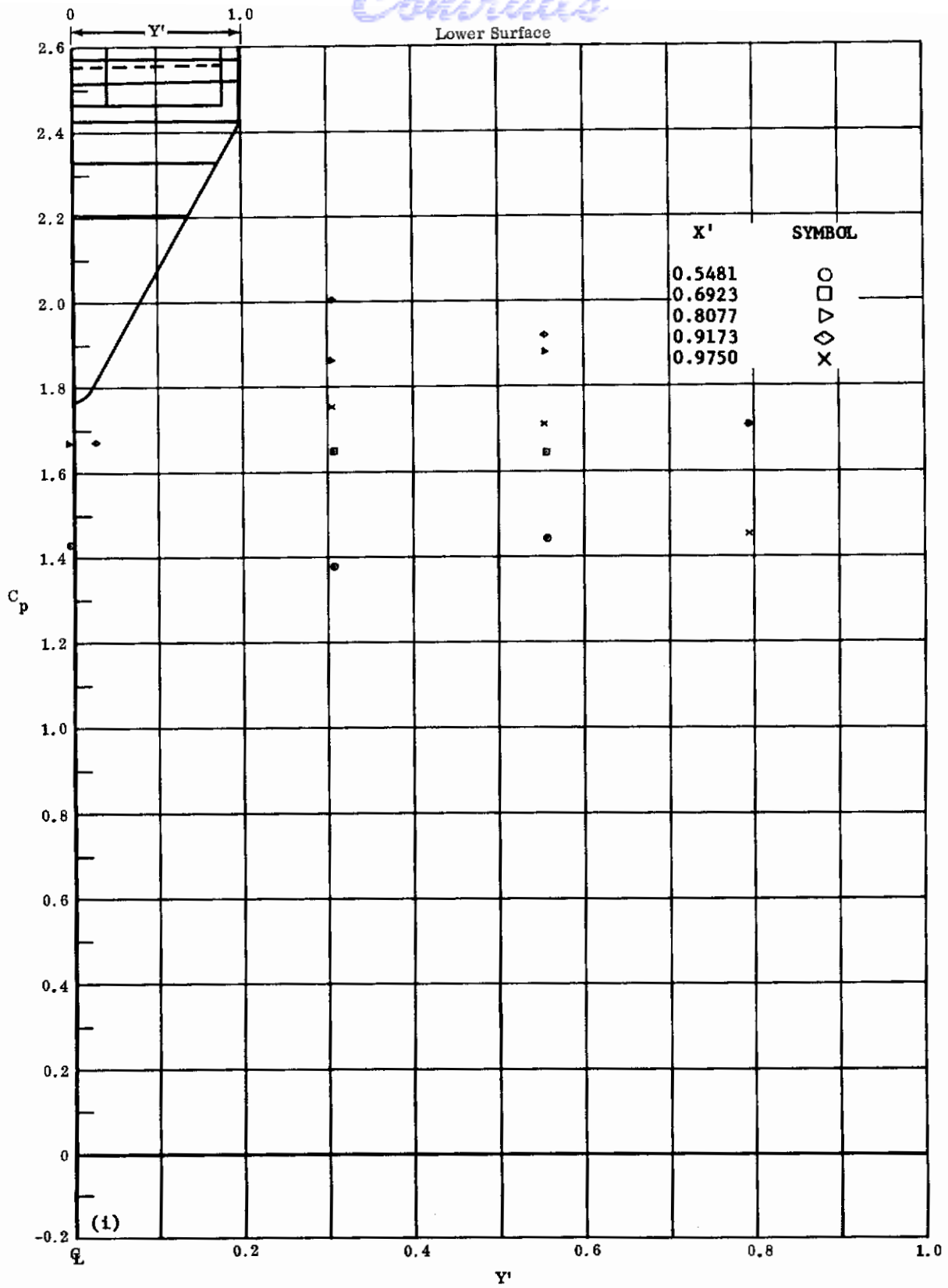

(NONDIMENSIONAL SEMISPAN DISTANCE)

Fig. 13i Configuration I, $\alpha = +50$, $\delta_2 = \delta_3 = +20$

C_p vs. Y' , lower surface

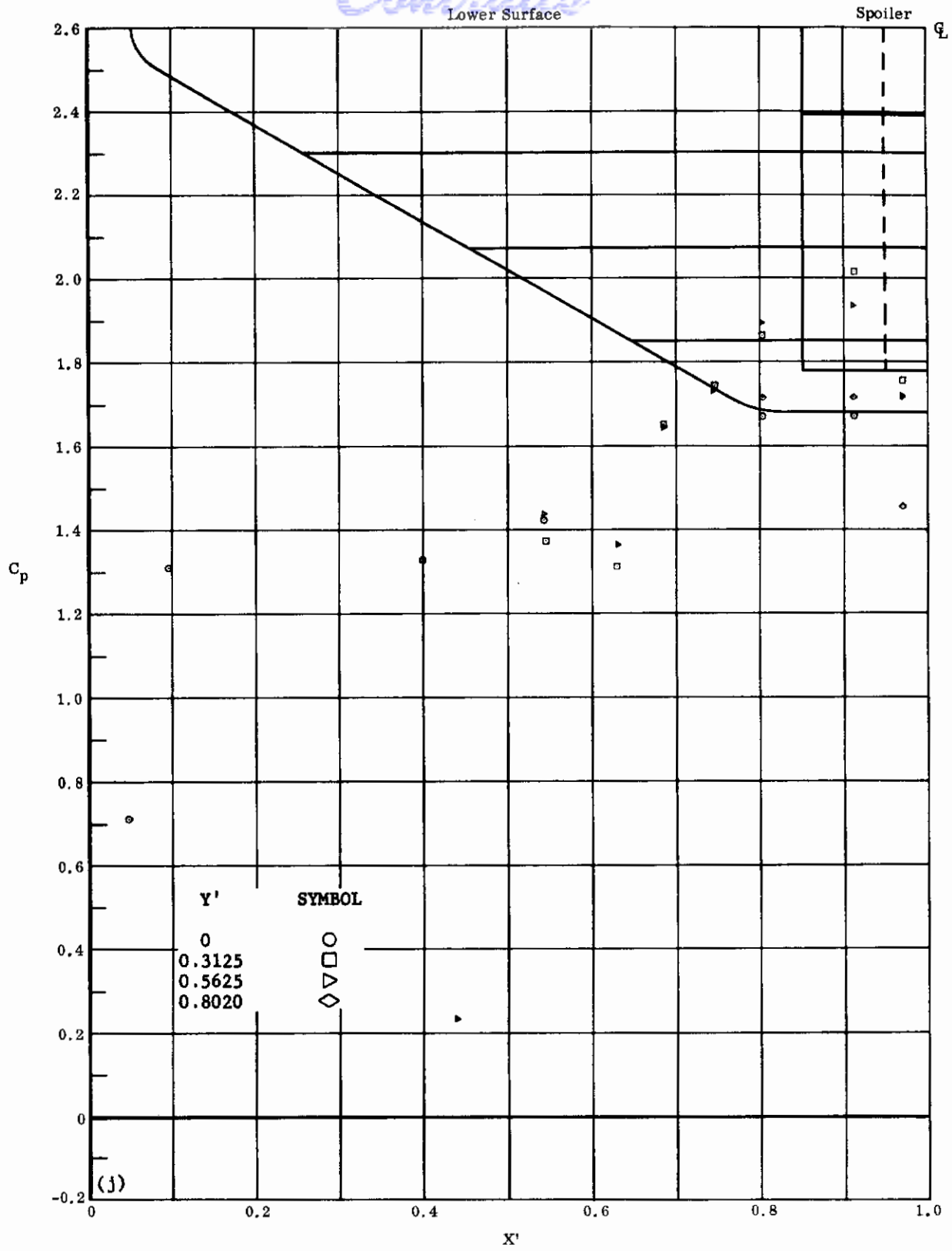

(NONDIMENSIONAL STREAMWISE DISTANCE FROM VIRTUAL APEX)

Fig. 13j Configuration I, $\alpha = +50$, $\delta_2 = \delta_3 = +20$

C_p vs. X' , lower surface

Contrails

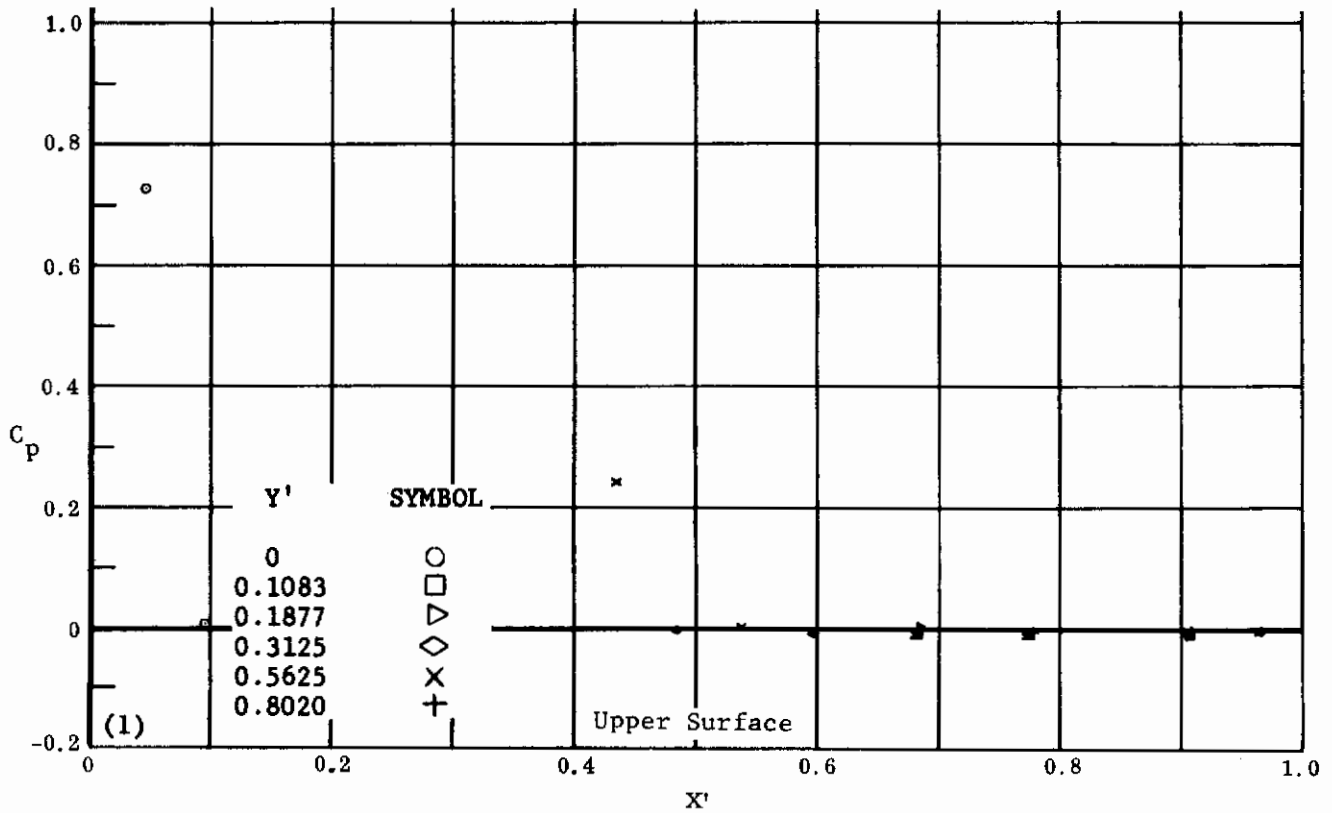
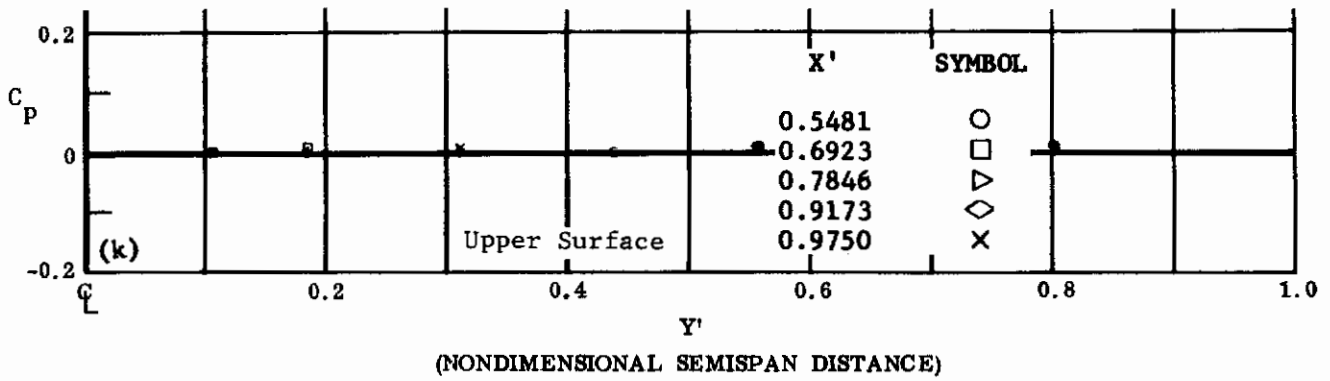

(NONDIMENSIONAL STREAMWISE DISTANCE FROM VIRTUAL APEX)

Fig. 13 Configuration I, $\alpha = +50$, $\delta_2 = \delta_3 = +20$

k) C_p vs. Y' , upper surface

1) C_p vs. X' , upper surface

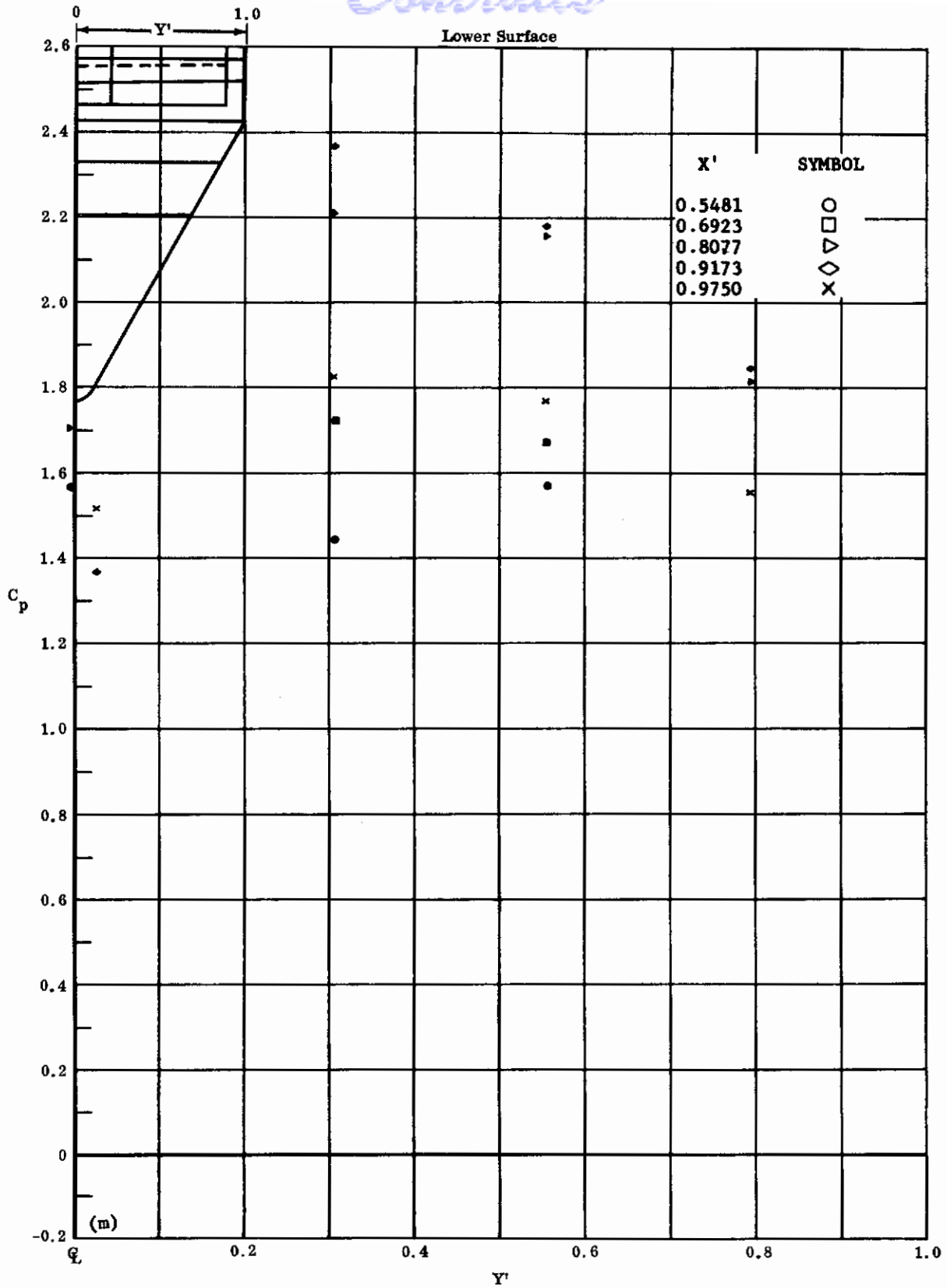

(NONDIMENSIONAL SEMISPAN DISTANCE)

Fig. 13m Configuration I, $\alpha = +50^\circ$, $\delta_2 = \delta_3 = +39^\circ$

C_p vs. Y' , lower surface

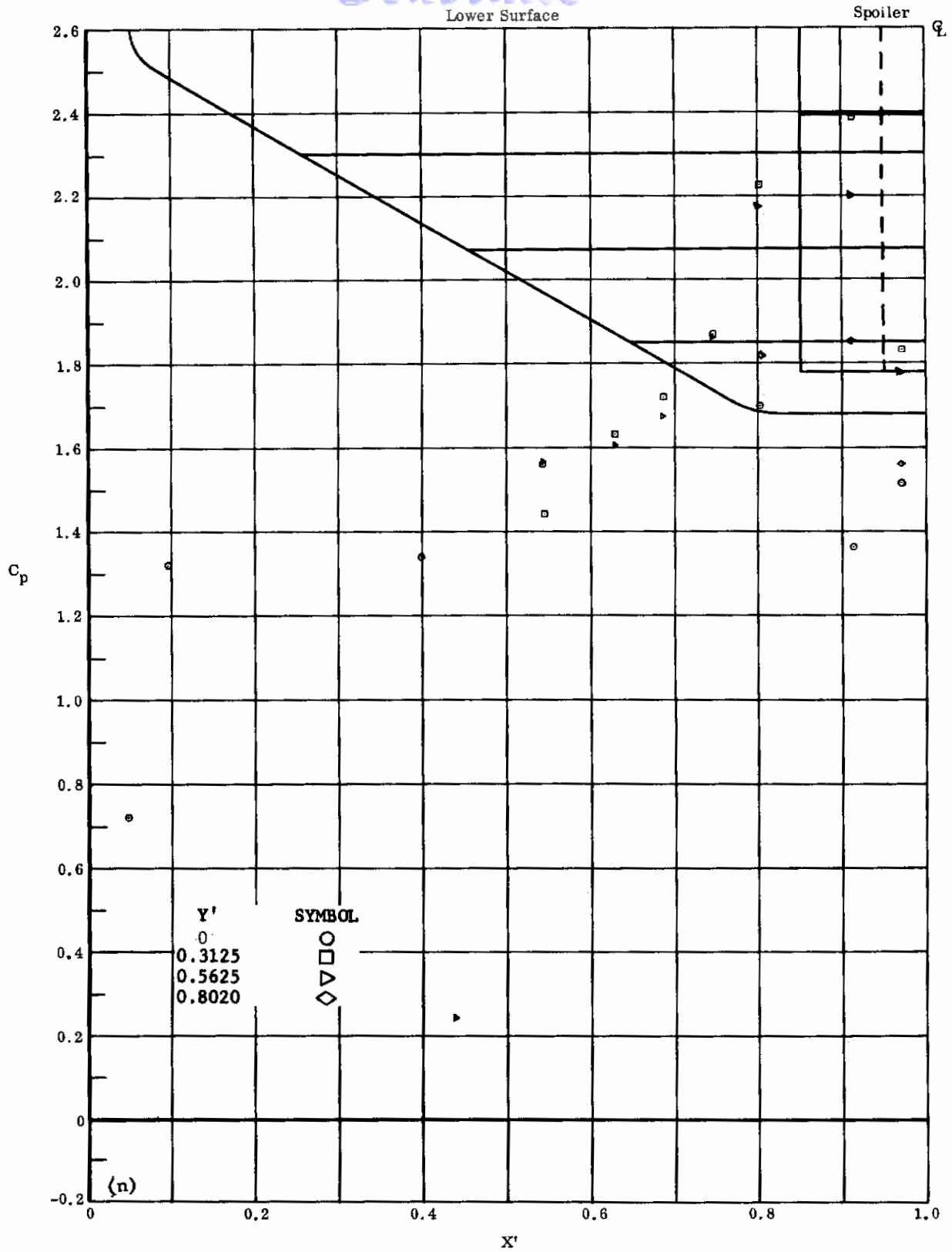

(NONDIMENSIONAL STREAMWISE DISTANCE FROM VIRTUAL APEX)

Fig. 13n Configuration I, $\alpha = +50$, $\delta_2 = \delta_3 = +39$

C_p vs. X' , lower surface

Contrails

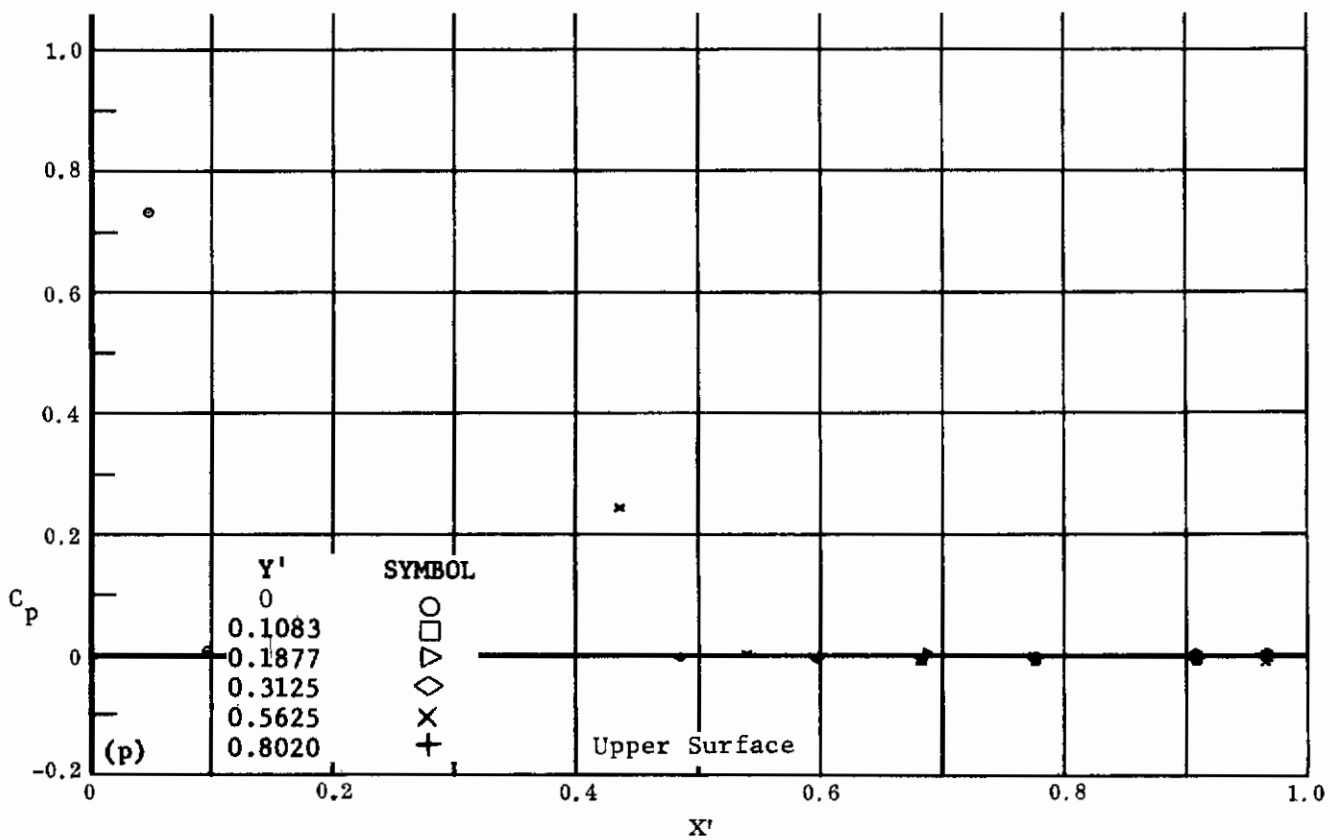
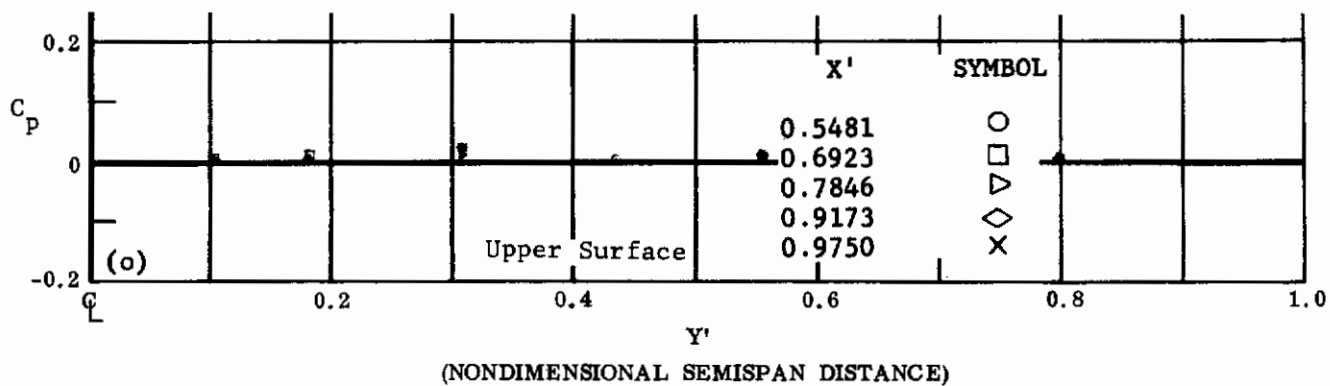

(NONDIMENSIONAL STREAMWISE DISTANCE FROM VIRTUAL APEX)

Fig. 13 Configuration I, $\alpha = +50$, $\delta_2 = \delta_3 = +39$

o) C_p vs. Y' , upper surface

p) C_p vs. X' , upper surface

Contrails

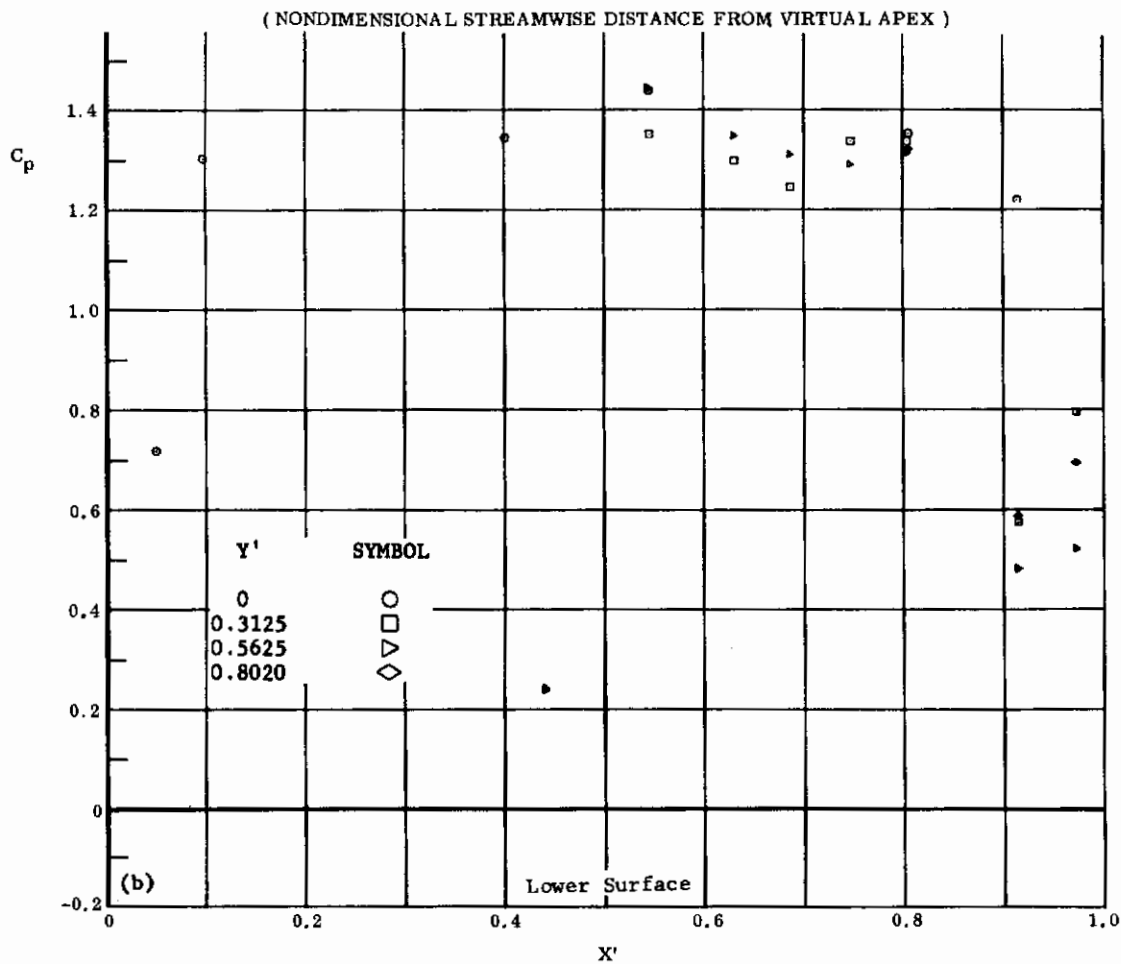
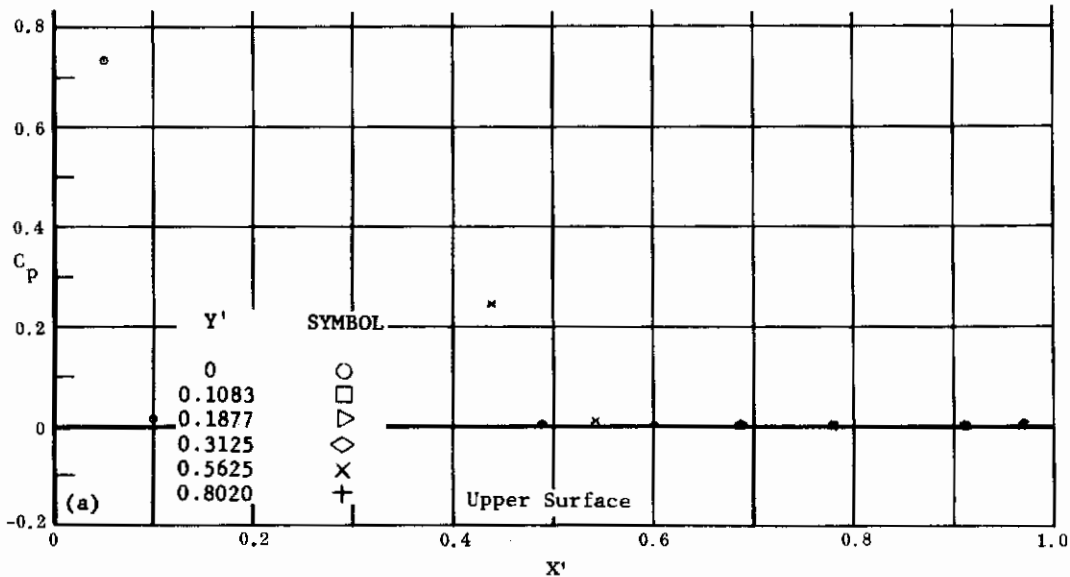

(NONDIMENSIONAL STREAMWISE DISTANCE FROM VIRTUAL APEX)

Fig. 14 Configuration I, $\alpha = +50$, $\delta_2 = \delta_3 = -20$

a) C_p vs. X' , upper surface

b) C_p vs. X' , lower surface

Contrails

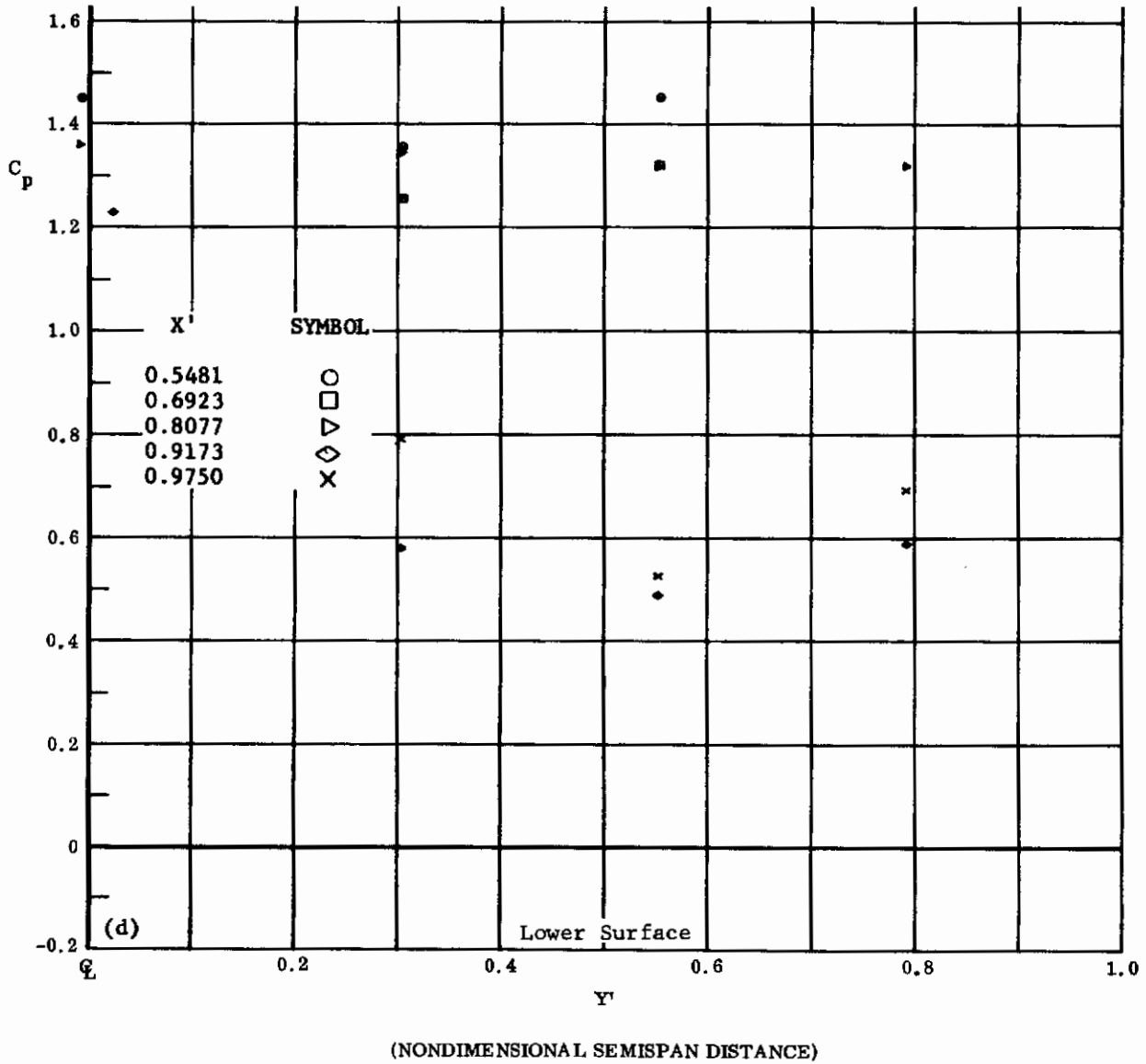
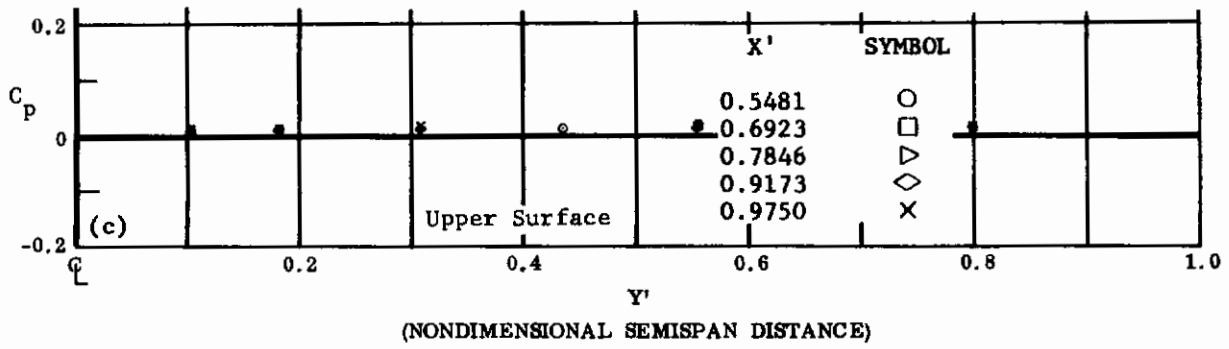
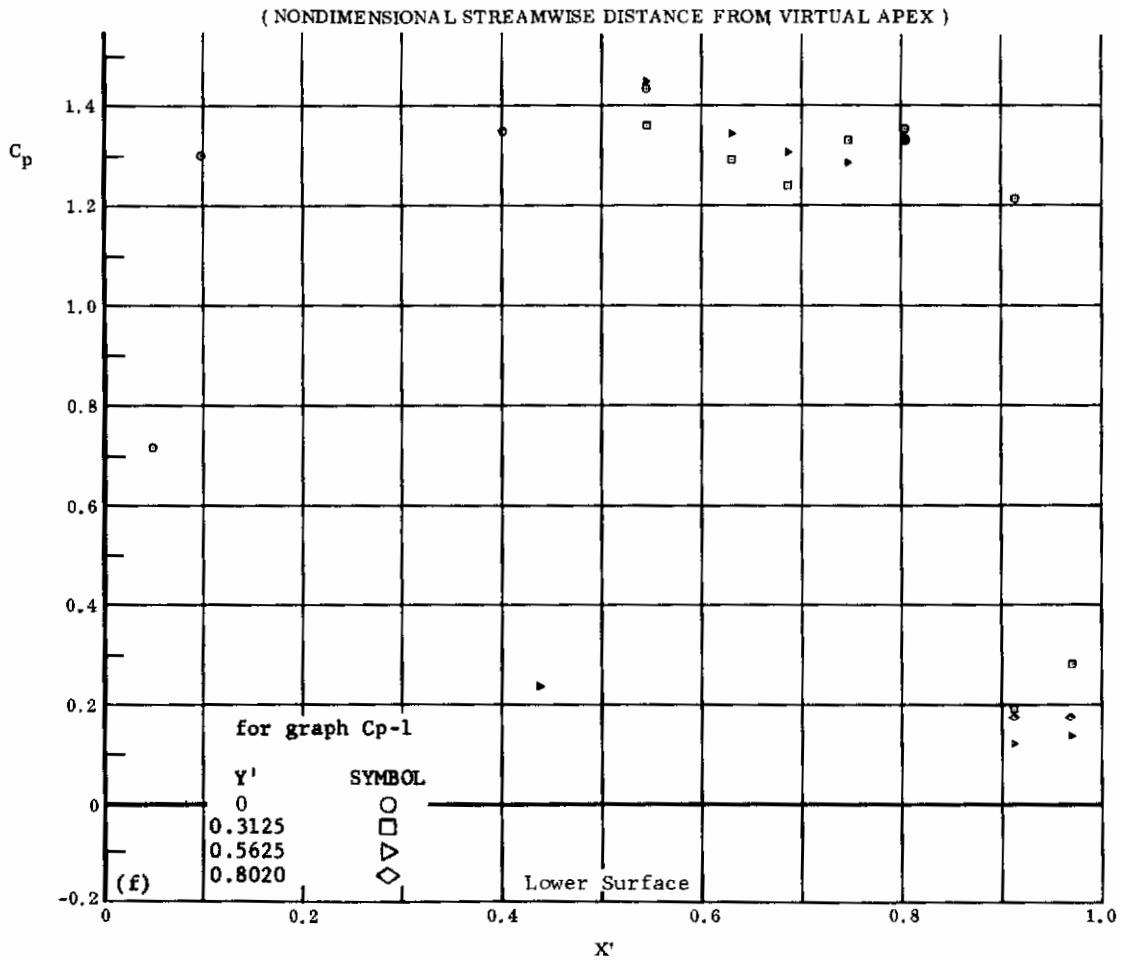
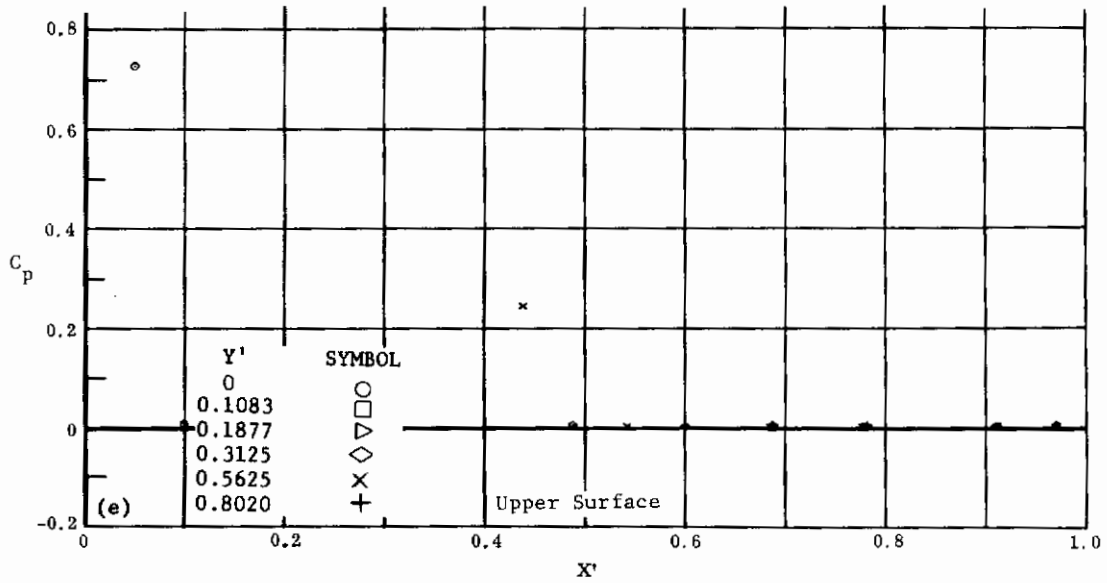

Fig. 14 Configuration I, $\alpha = +50$, $\delta_2 = \delta_3 = -20'$

c) C_p vs. Y' , upper surface

d) C_p vs. Y' , lower surface

Contrails



(NONDIMENSIONAL STREAMWISE DISTANCE FROM VIRTUAL APEX)

Fig. 14 Configuration I, $\alpha = +50$, $\delta_2 = \delta_3 = -39$

e) C_p vs. X' , upper surface

f) C_p vs. X' , lower surface

Contrails

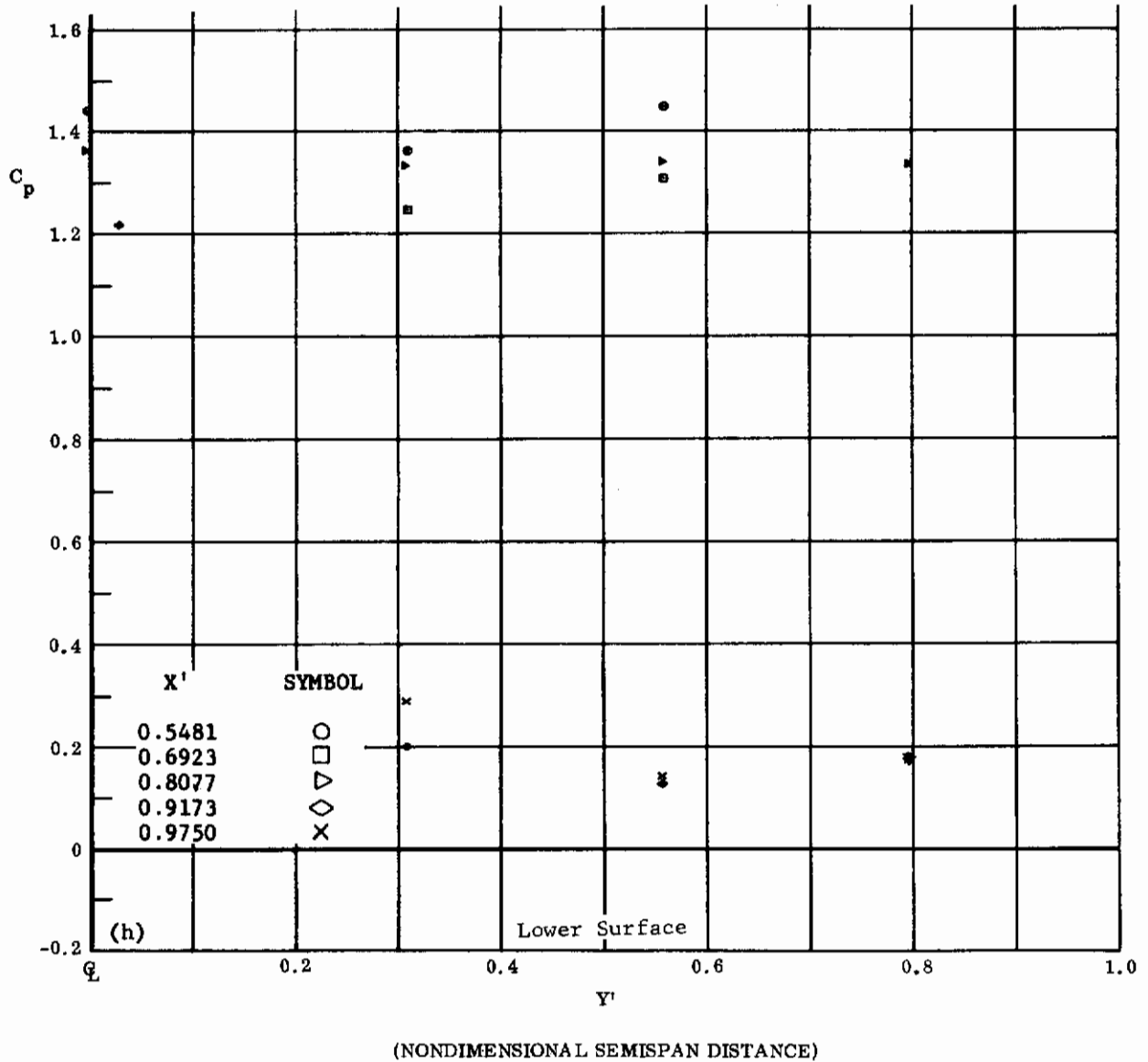
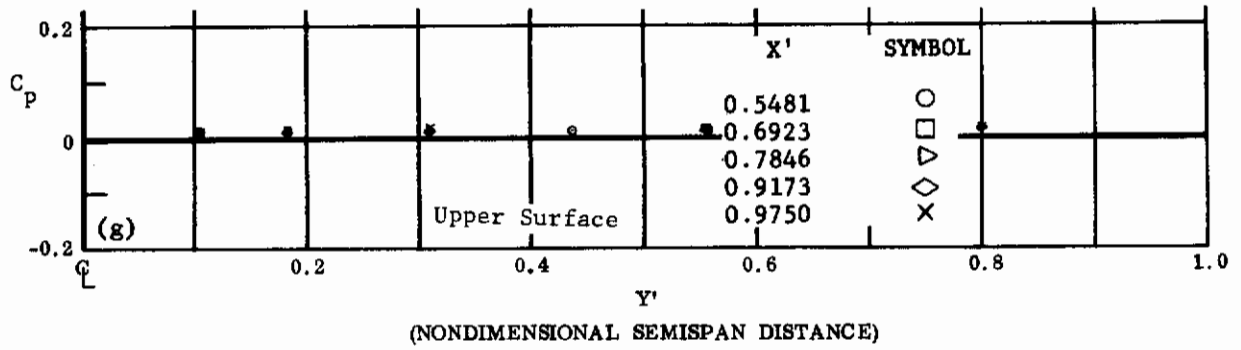

Fig. 14 Configuration I, $\alpha = +50$, $\delta_2 = \delta_3 = -39$

g) C_p vs. Y' , upper surface

h) C_p vs. Y' , lower surface

Contract

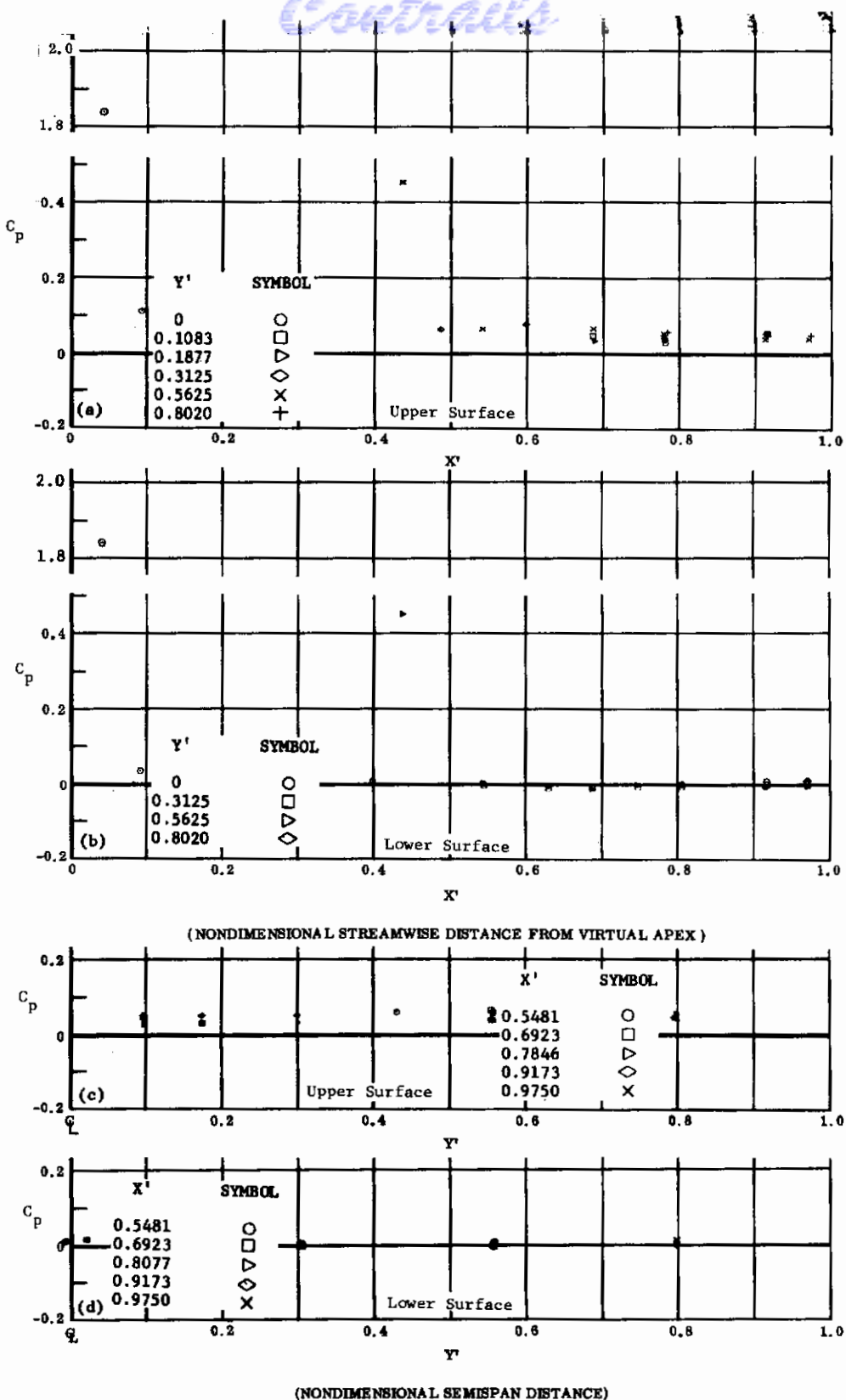

Fig. 15 Configuration I, $\alpha = -5$, $\delta_2 = \delta_3 = 0$

- a) C_p vs. X' , upper surface
- b) C_p vs. X' , lower surface
- c) C_p vs. Y' , upper surface
- d) C_p vs. Y' , lower surface

Contrails

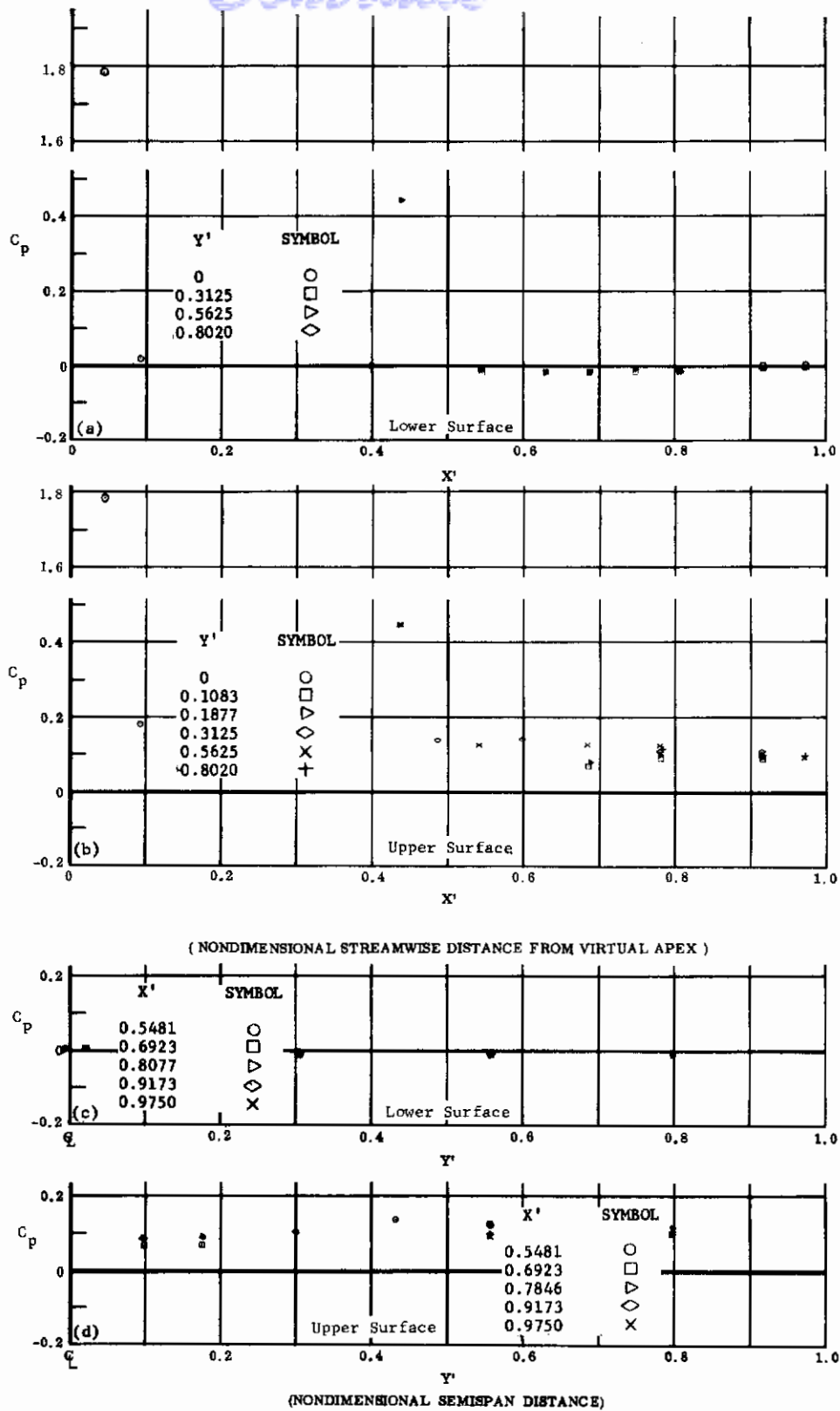

Fig. 16 Configuration I, $\alpha = -10$, $\delta_2 = \delta_3 = 0$

- a) C_p vs. X' , lower surface
- b) C_p vs. X' , upper surface
- c) C_p vs. Y' , lower surface
- d) C_p vs. Y' , upper surface

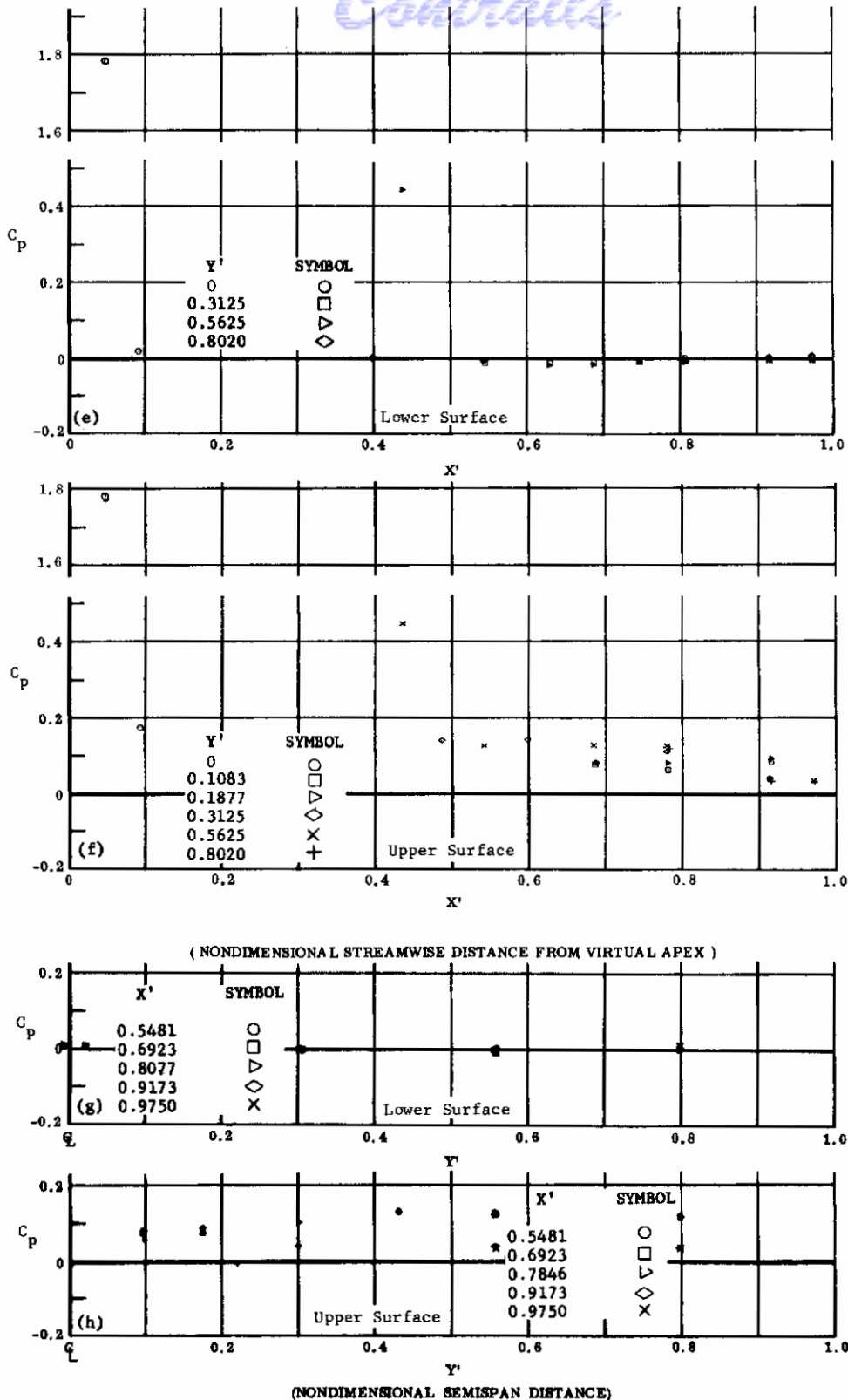
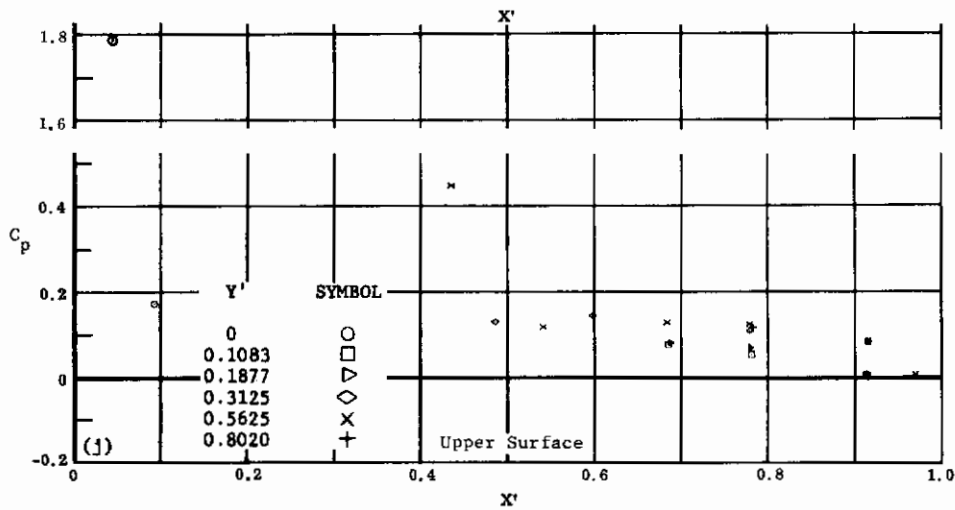
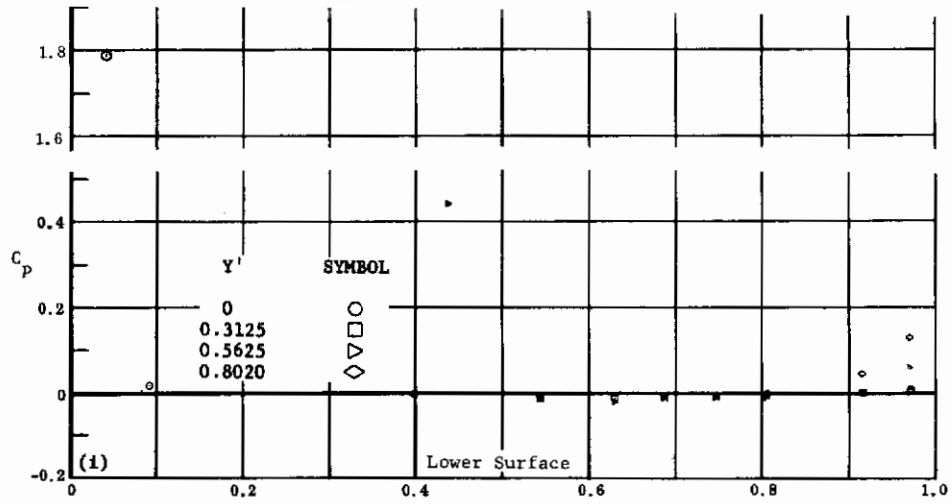

Fig. 16 Configuration I, $\alpha = -10$, $\delta_2 = \delta_3 = +10$

- e) C_p vs. X' , lower surface
- f) C_p vs. X' , upper surface
- g) C_p vs. Y' , lower surface
- h) C_p vs. Y' , upper surface

Contrails



(NONDIMENSIONAL STREAMWISE DISTANCE FROM VIRTUAL APEX)

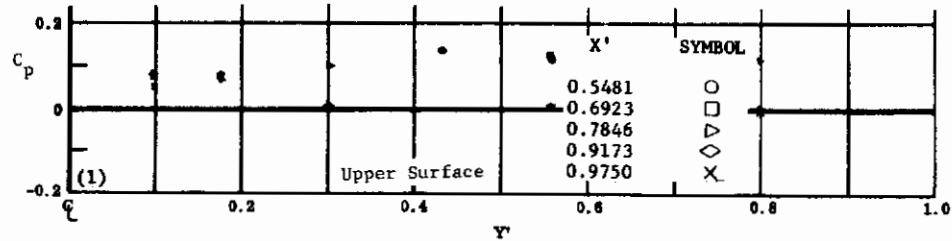
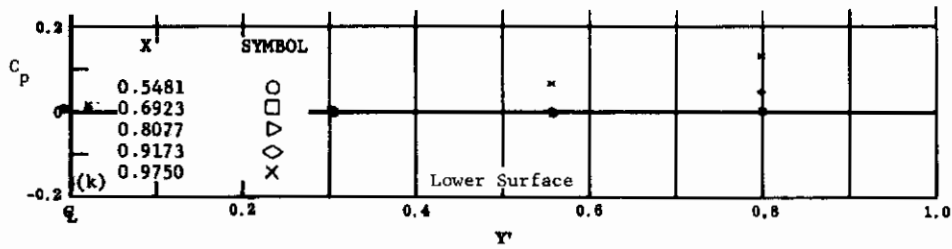

(NONDIMENSIONAL SEMISPAN DISTANCE)

Fig. 16 Configuration I, $\alpha = -10$, $\delta_2 = \delta_3 = +20$

- i) C_p vs. X' , lower surface
- j) C_p vs. X' , upper surface
- k) C_p vs. Y' , lower surface
- l) C_p vs. Y' , upper surface

Contrails

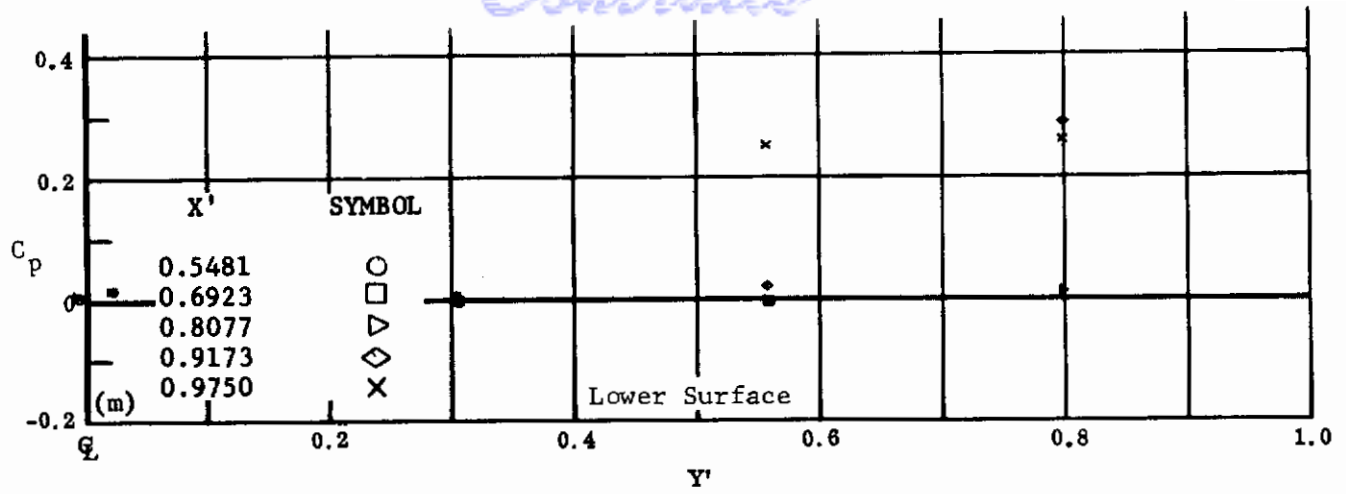

(NONDIMENSIONAL SEMISPAN DISTANCE)

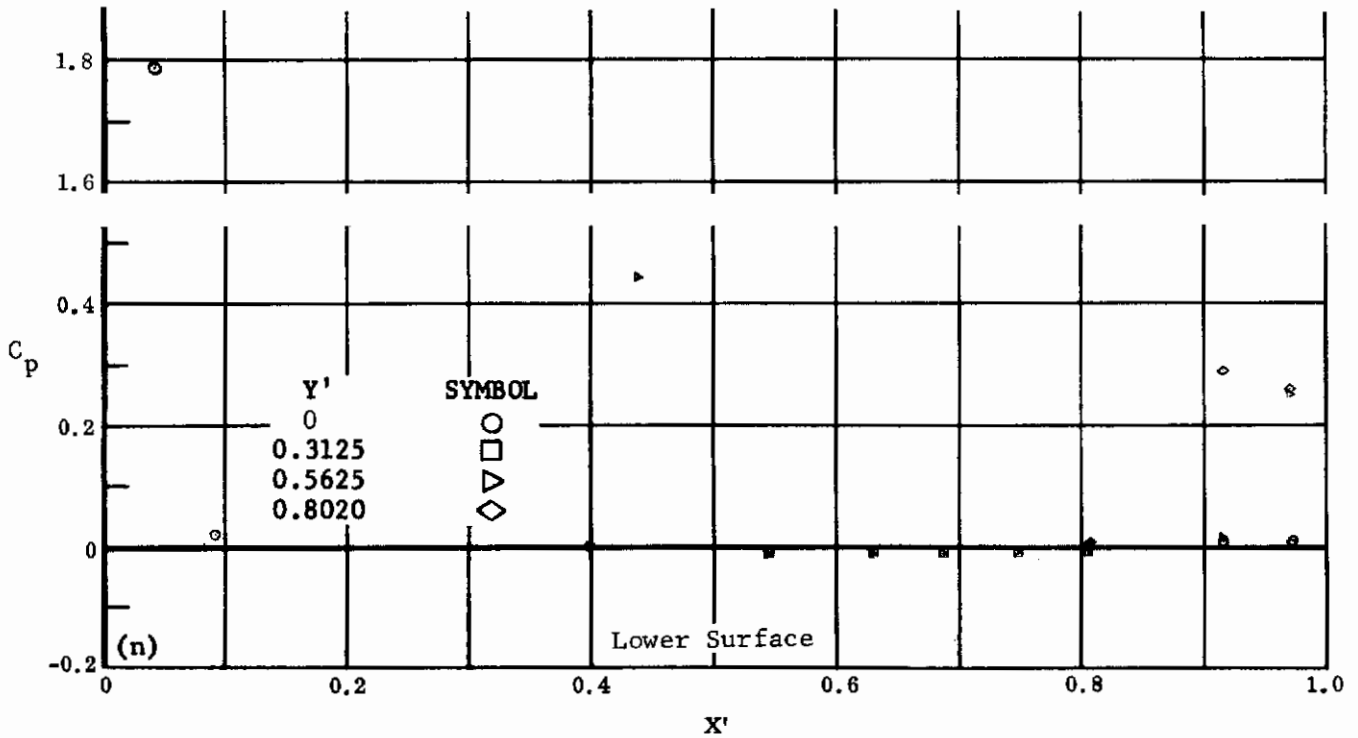

(NONDIMENSIONAL STREAMWISE DISTANCE FROM VIRTUAL APEX)

Fig. 16 Configuration I, $\alpha = -10$, $\delta_2 = \delta_3 = +30$

m) C_p vs. Y' , lower surface

n) C_p vs. X' , lower surface

Contrails

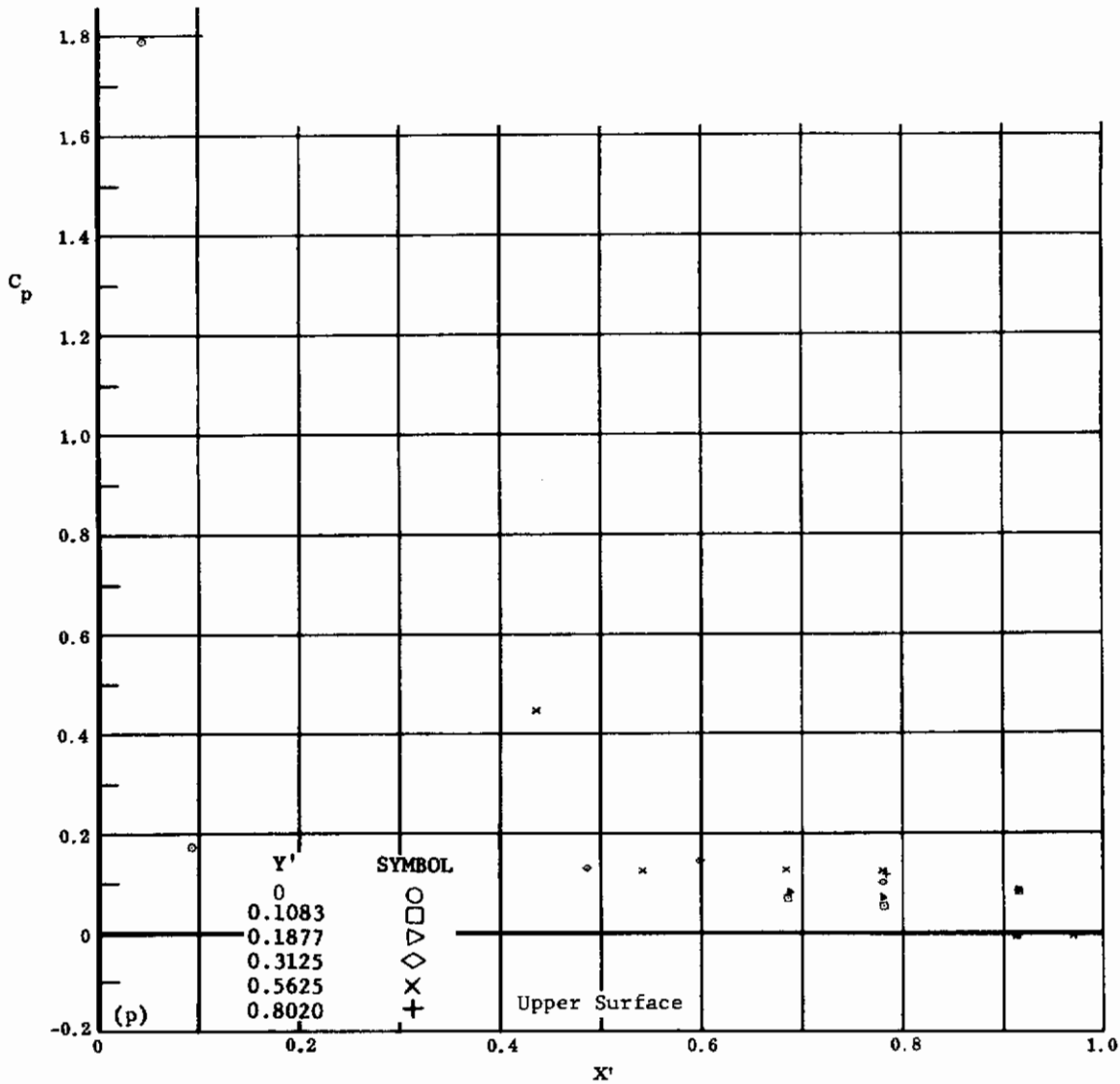
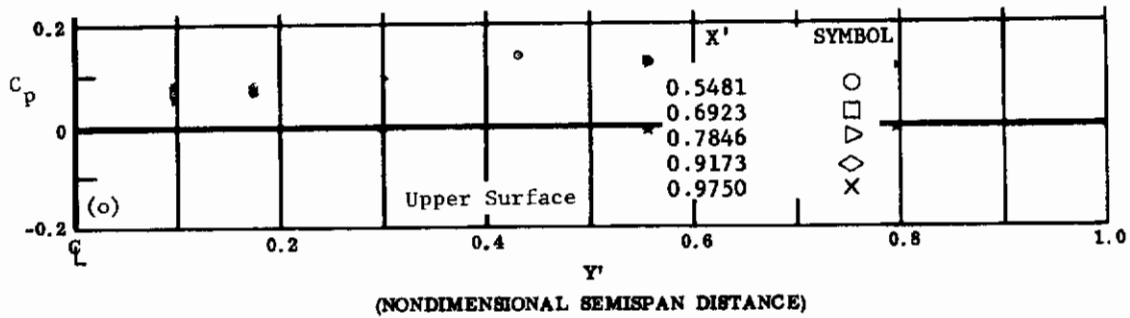

(NONDIMENSIONAL STREAMWISE DISTANCE FROM VIRTUAL APEX)

Fig. 16 Configuration I, $\alpha = -10$, $\delta_2 = \delta_3 = +30$

o) C_p vs. Y' , upper surface

p) C_p vs. X' , upper surface

Contrails

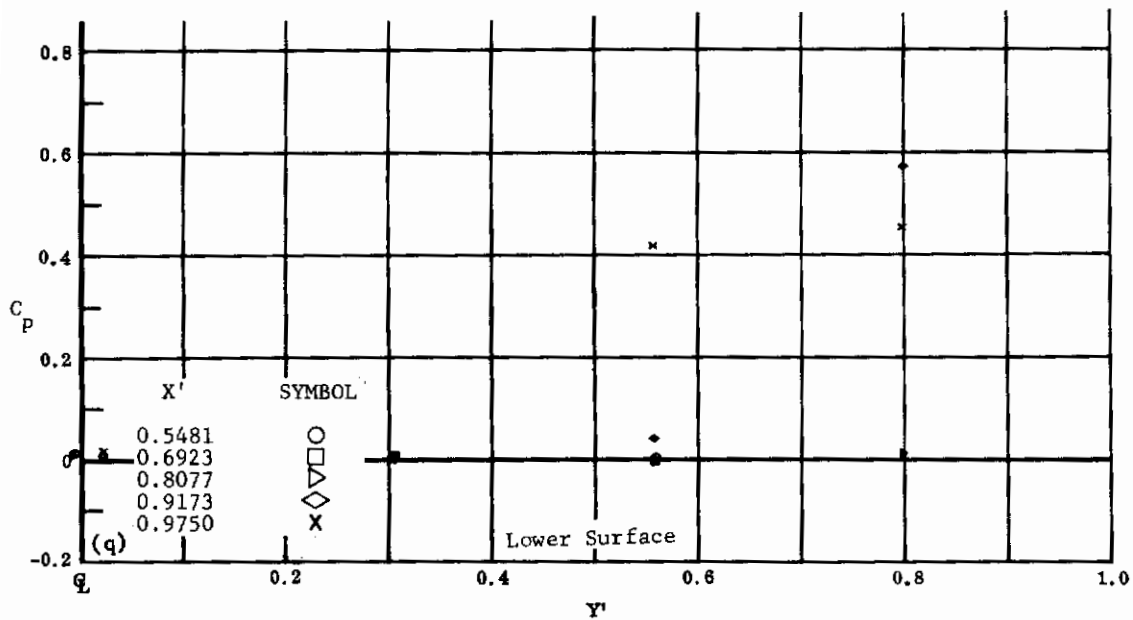

(NONDIMENSIONAL SEMISPAN DISTANCE)

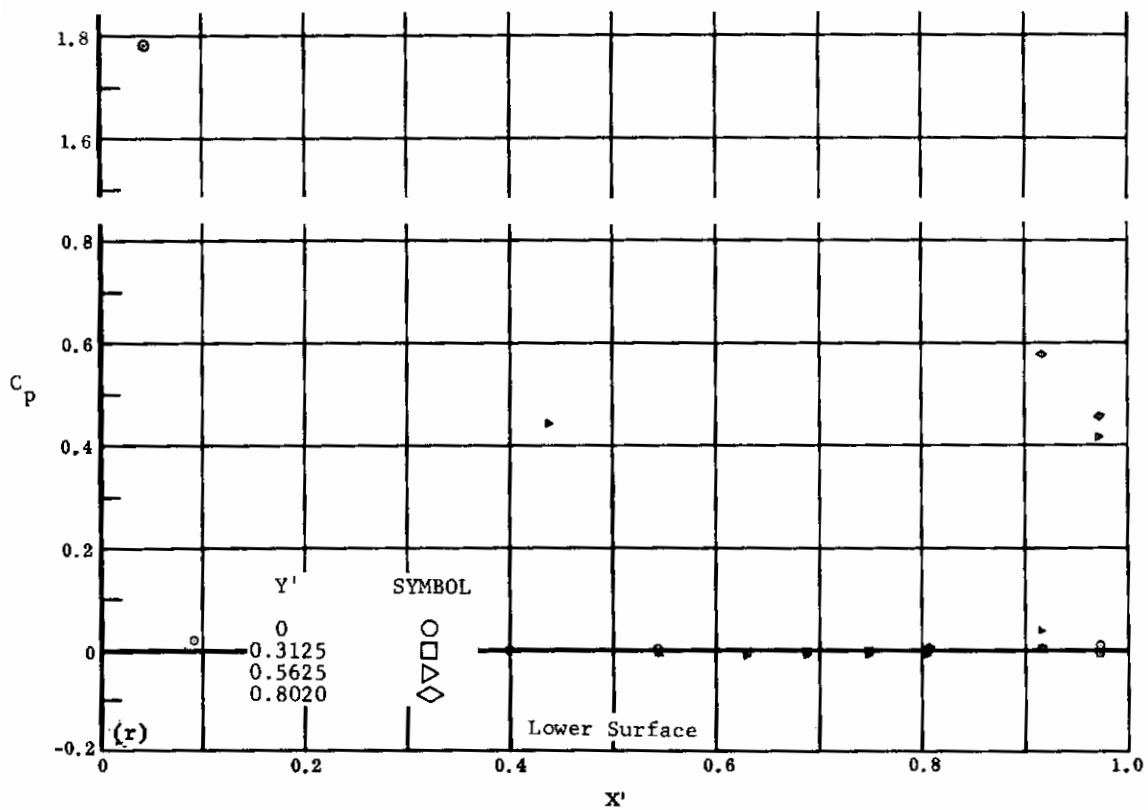

(NONDIMENSIONAL STREAMWISE DISTANCE FROM VIRTUAL APEX)

Fig. 16 Configuration I, $\alpha = -10$, $\delta_2 = \delta_3 = +39$

q) C_p vs. Y' , lower surface

r) C_p vs. X' , lower surface

Contrails

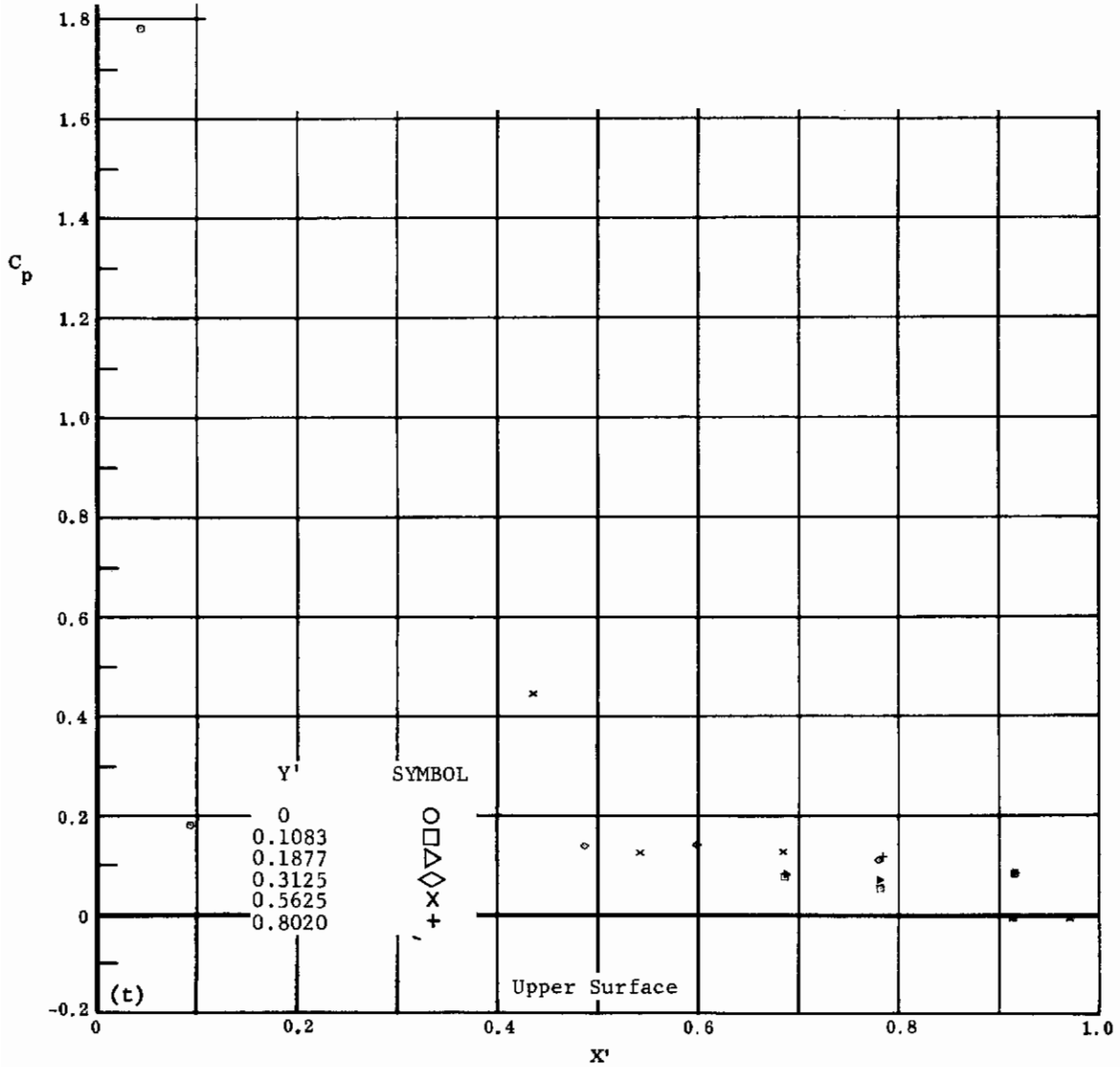
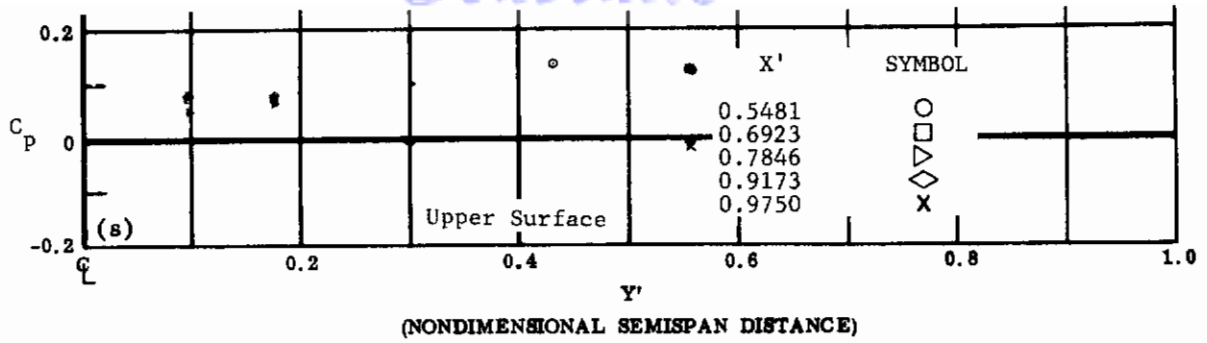

(NONDIMENSIONAL STREAMWISE DISTANCE FROM VIRTUAL APEX)

Fig. 16 Configuration I, $\alpha = -10$, $\delta_2 = \delta_3 = +39$

s) C_p vs. Y' , upper surface

t) C_p vs. X' , upper surface

Contrails

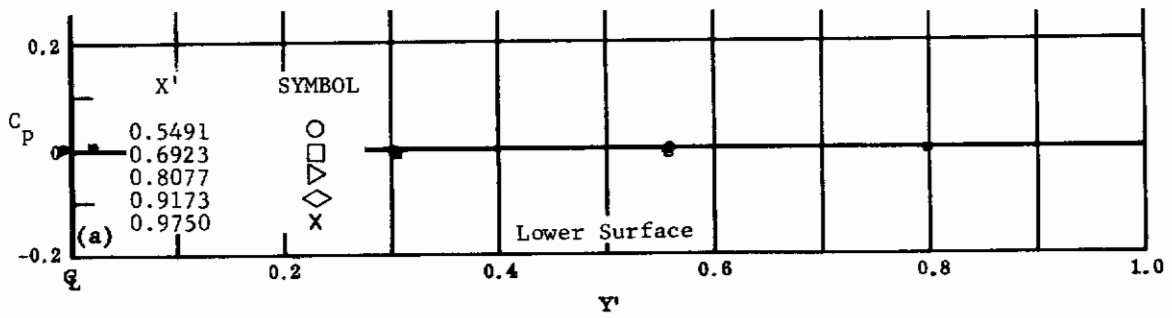

(NONDIMENSIONAL SEMISPAN DISTANCE)

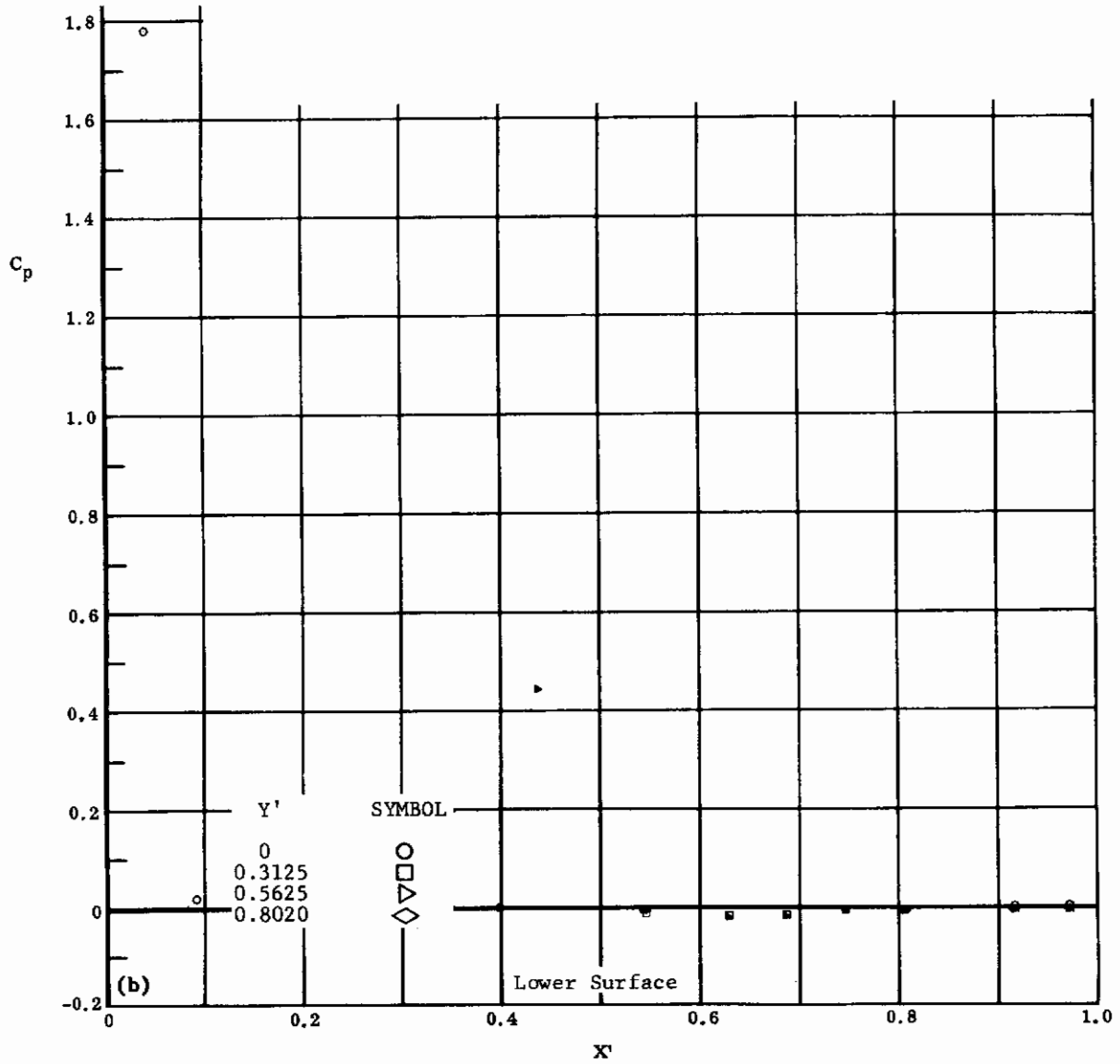

(NONDIMENSIONAL STREAMWISE DISTANCE FROM VIRTUAL APEX)

Fig. 17 Configuration I, $\alpha = -10$, $\delta_2 = \delta_3 = -10$

a) C_p vs. Y' , lower surface

b) C_p vs. X' , lower surface

Contrails

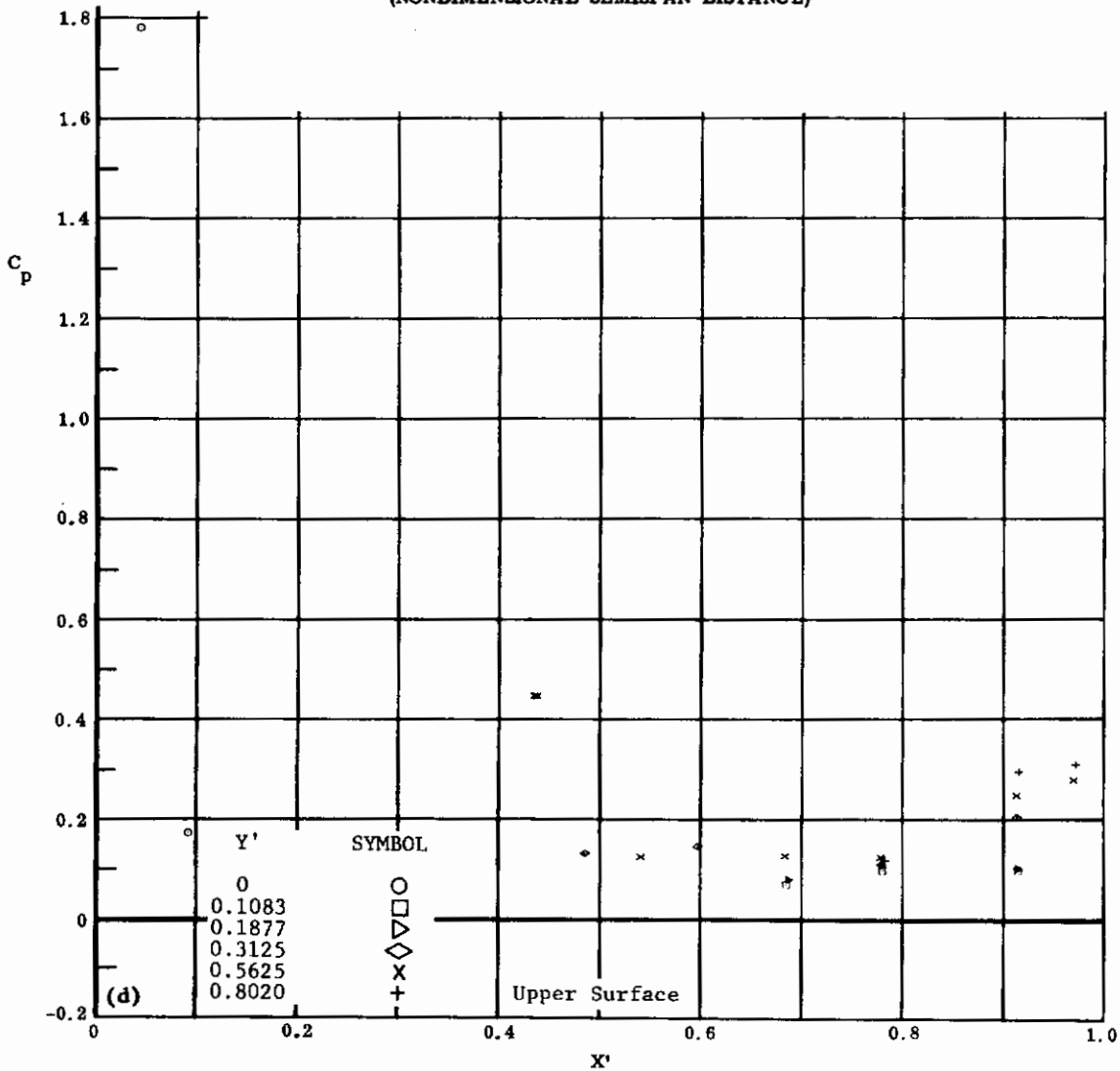
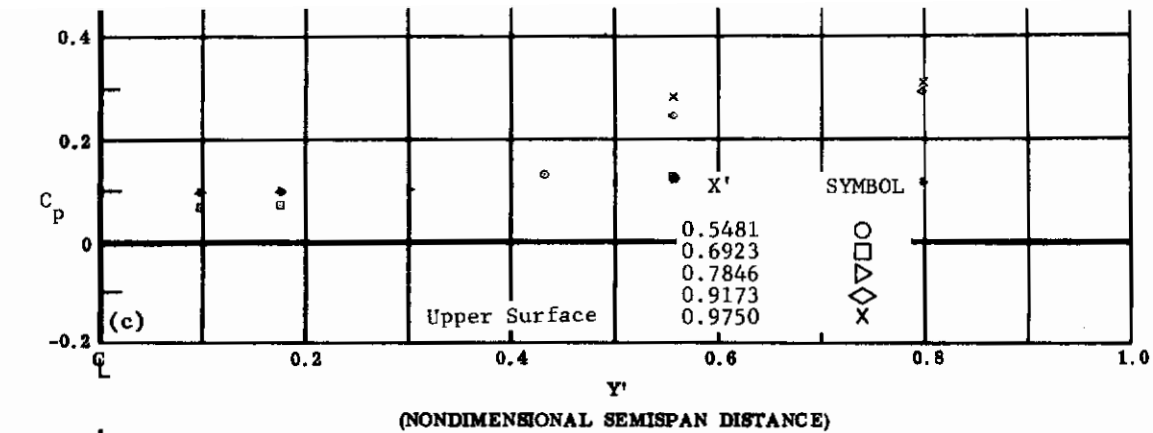

(NONDIMENSIONAL STREAMWISE DISTANCE FROM VIRTUAL APEX)

Fig. 17 Configuration I, $\alpha = -10$, $\delta_2 = \delta_3 = -10$

- c) C_p vs. Y' , upper surface
- d) C_p vs. X' , upper surface

Contrails

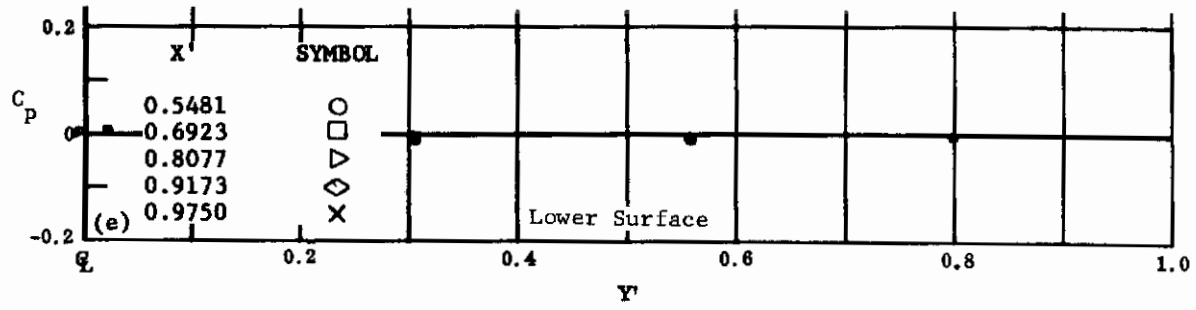

(NONDIMENSIONAL SEMISPAN DISTANCE)

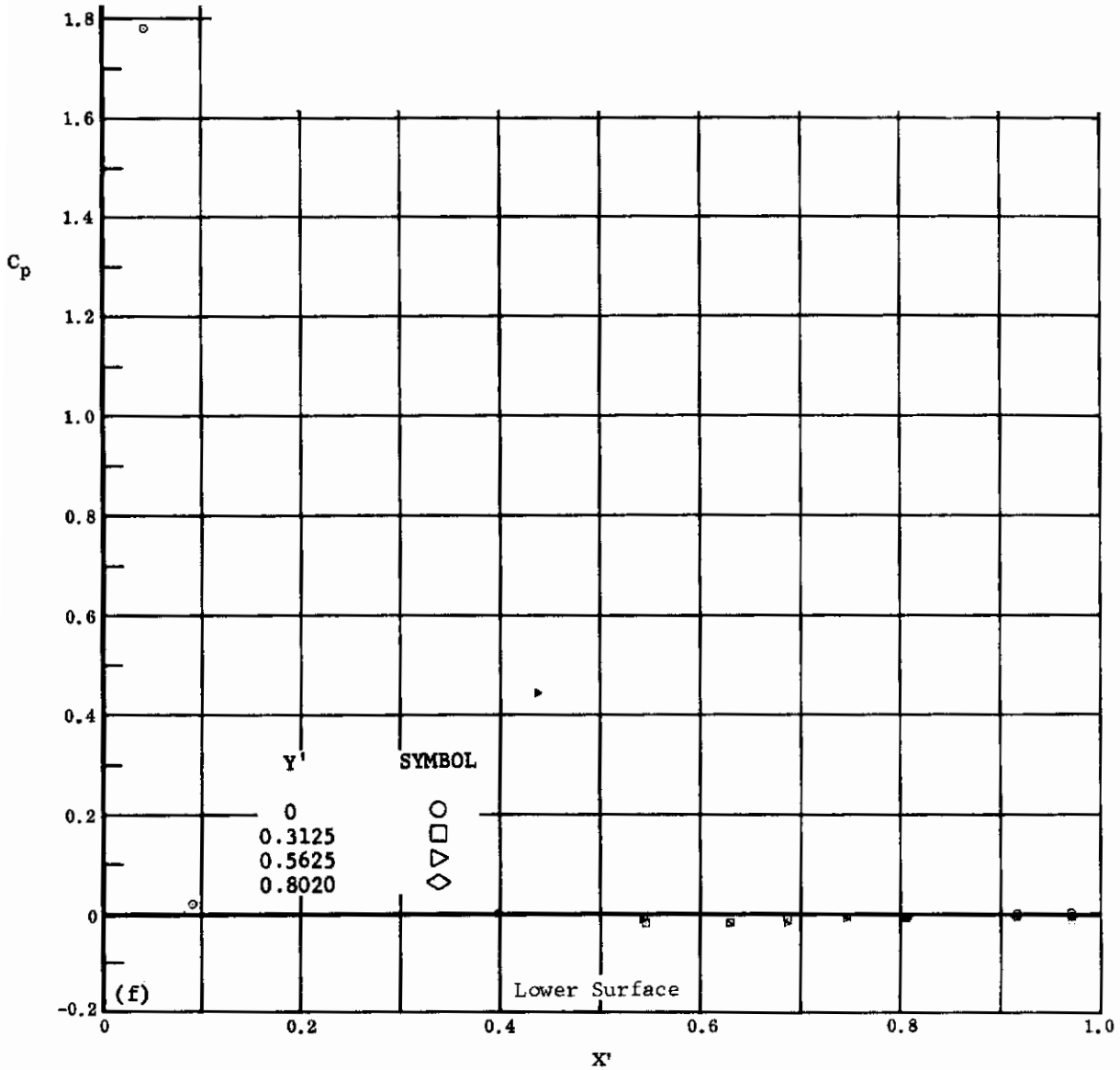

(NONDIMENSIONAL STREAMWISE DISTANCE FROM VIRTUAL APEX)

Fig. 17 Configuration I, $\alpha = -10$, $\delta_2 = \delta_3 = -20$

e) C_p vs. Y' , lower surface

f) C_p vs. X' , lower surface

Contrails

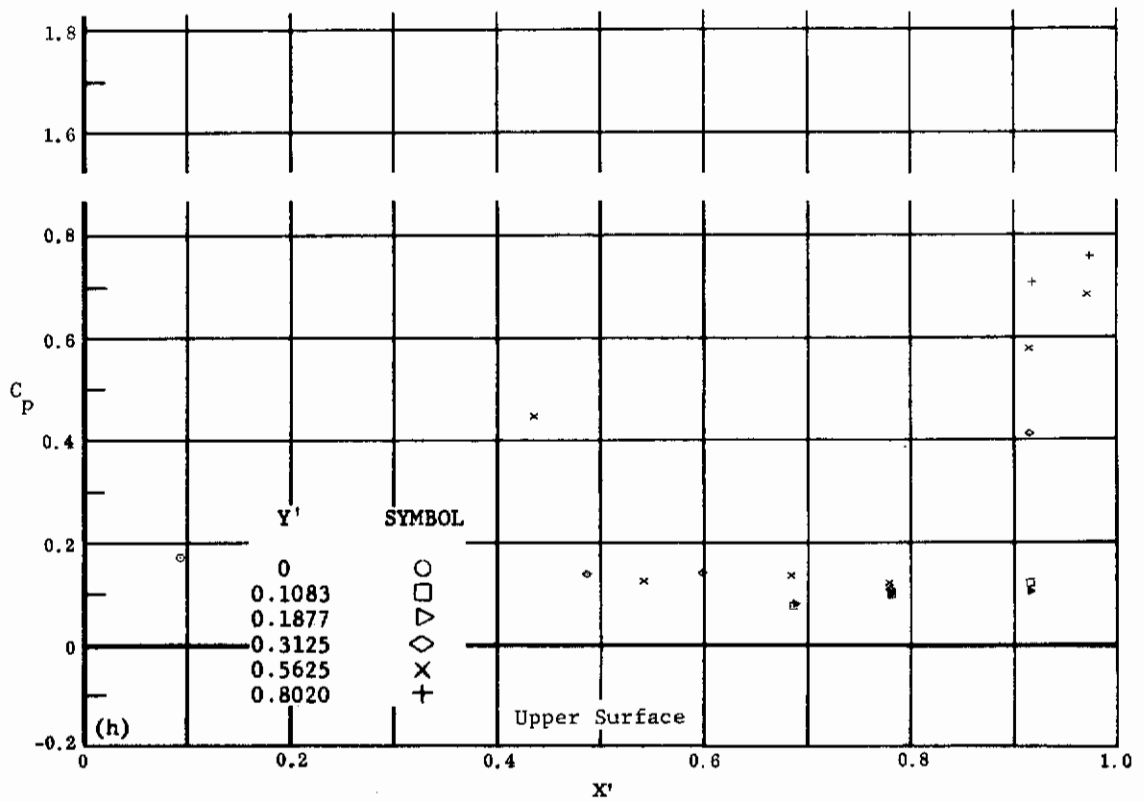
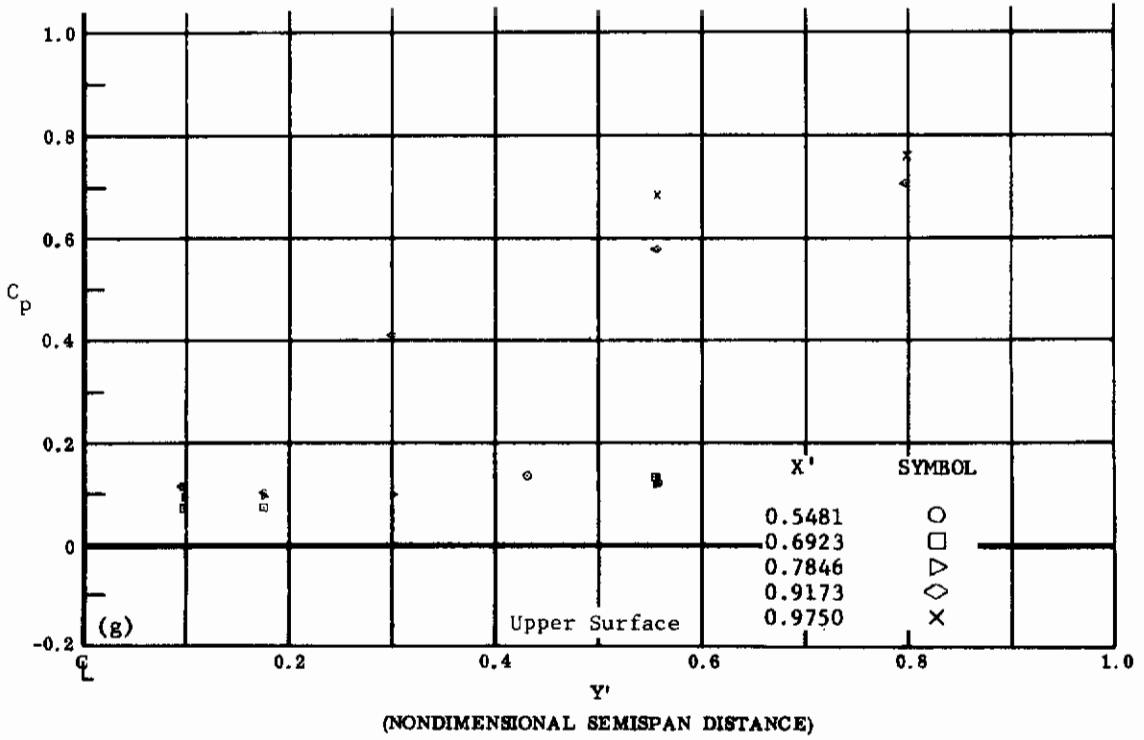

(NONDIMENSIONAL STREAMWISE DISTANCE FROM VIRTUAL APEX)

Fig. 17 Configuration I, $\alpha = -10$, $\delta_2 = \delta_3 = -20$

g) C_p vs. Y' , upper surface

h) C_p vs. X' , upper surface

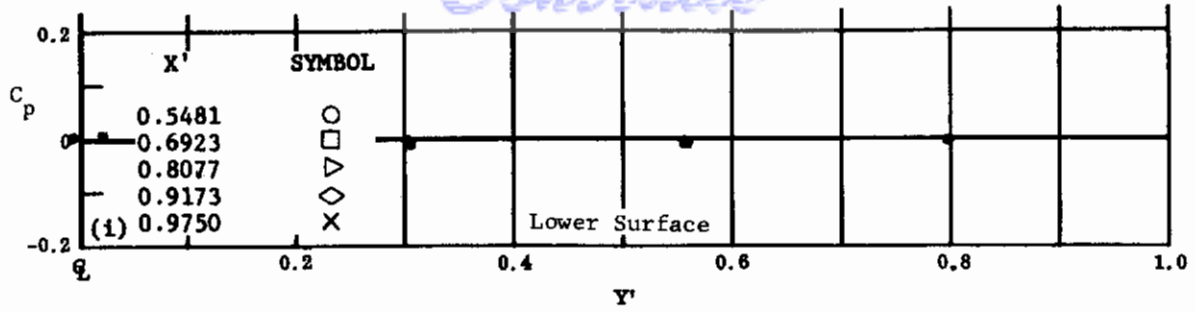

(NONDIMENSIONAL SEMISPAN DISTANCE)

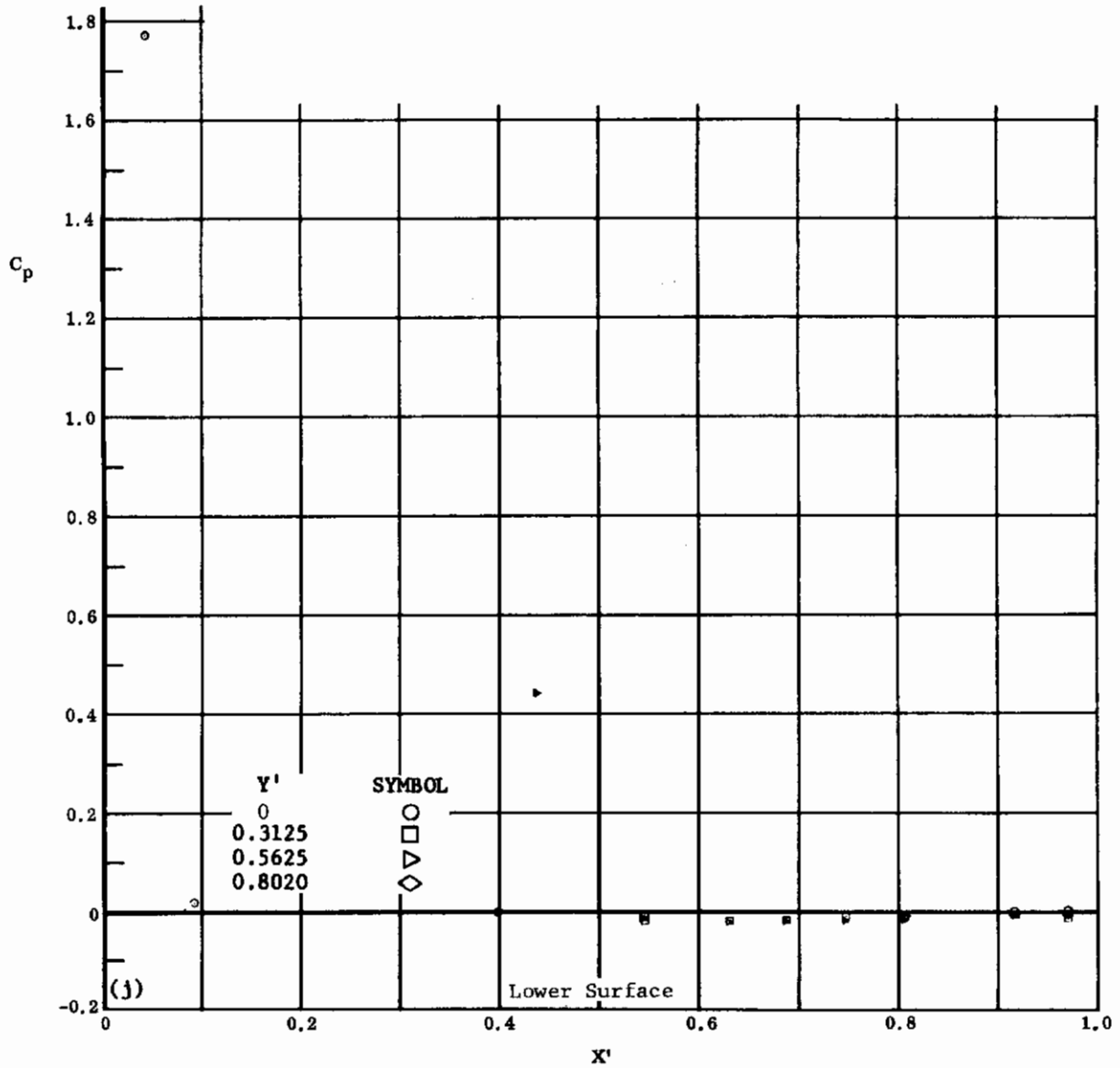

(NONDIMENSIONAL STREAMWISE DISTANCE FROM VIRTUAL APEX)

Fig. 17 Configuration I, $\alpha = -10$, $\delta_2 = \delta_3 = -30$

- i) C_p vs. Y', lower surface
- j) C_p vs. X', lower surface

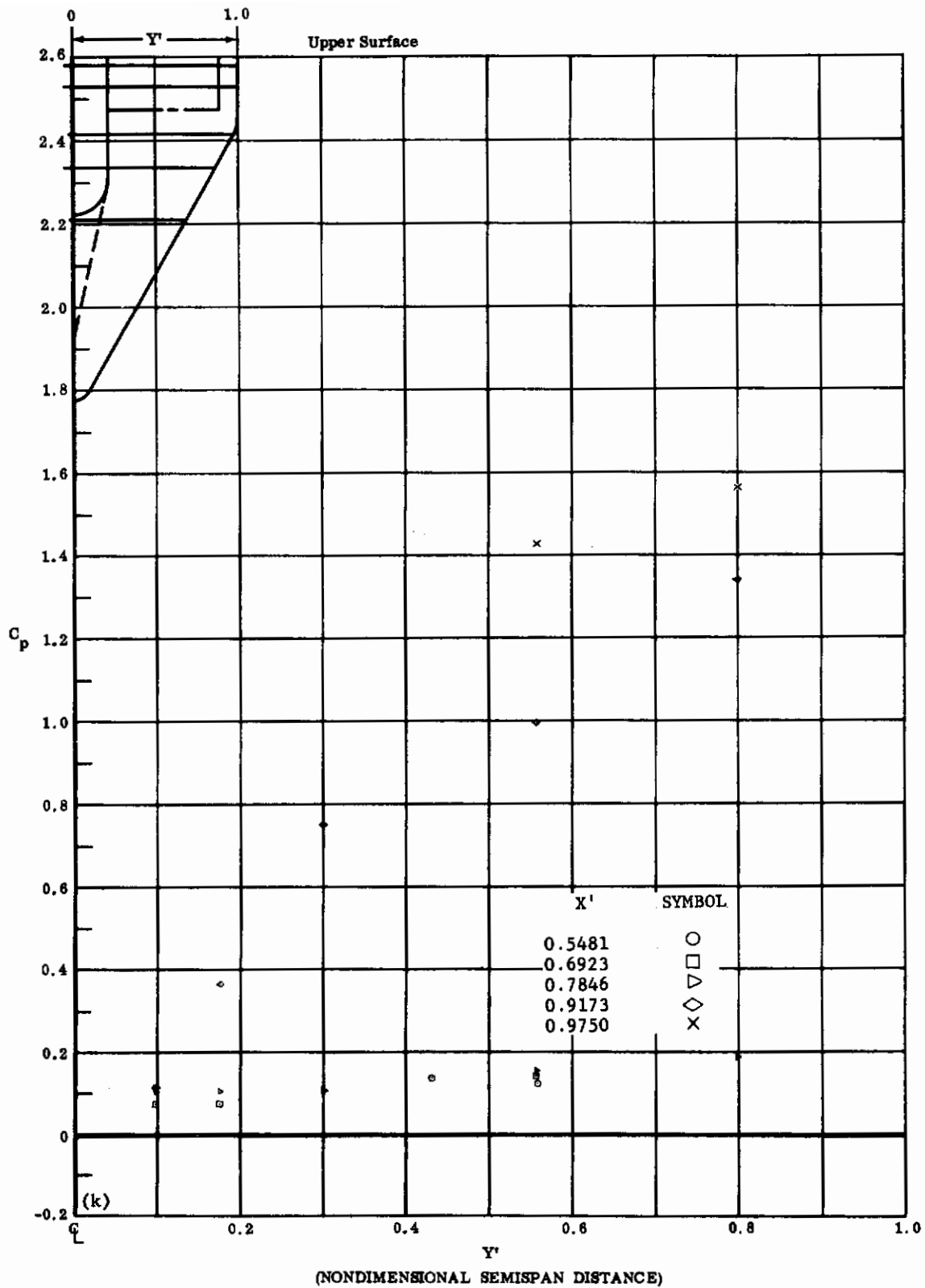
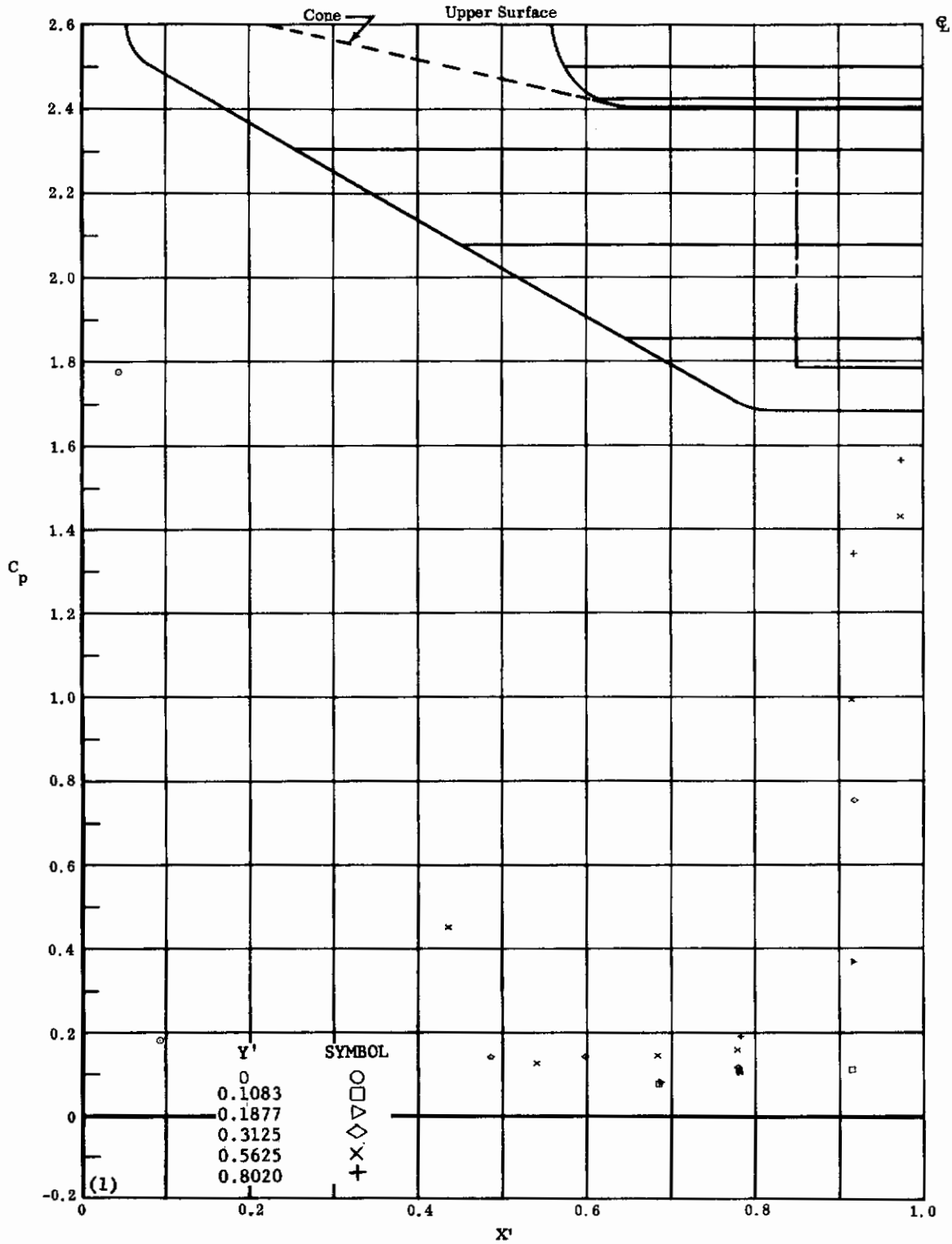

Fig. 17k Configuration I, $\alpha = -10$, $\delta_2 = \delta_3 = -30$

C_p vs. Y' , upper surface

Contraails



(NONDIMENSIONAL STREAMWISE DISTANCE FROM VIRTUAL APEX)

Fig. 171 Configuration I, $\alpha = -10$, $\delta_2 = \delta_3 = -30$

C_p vs. X' , upper surface

Contrails

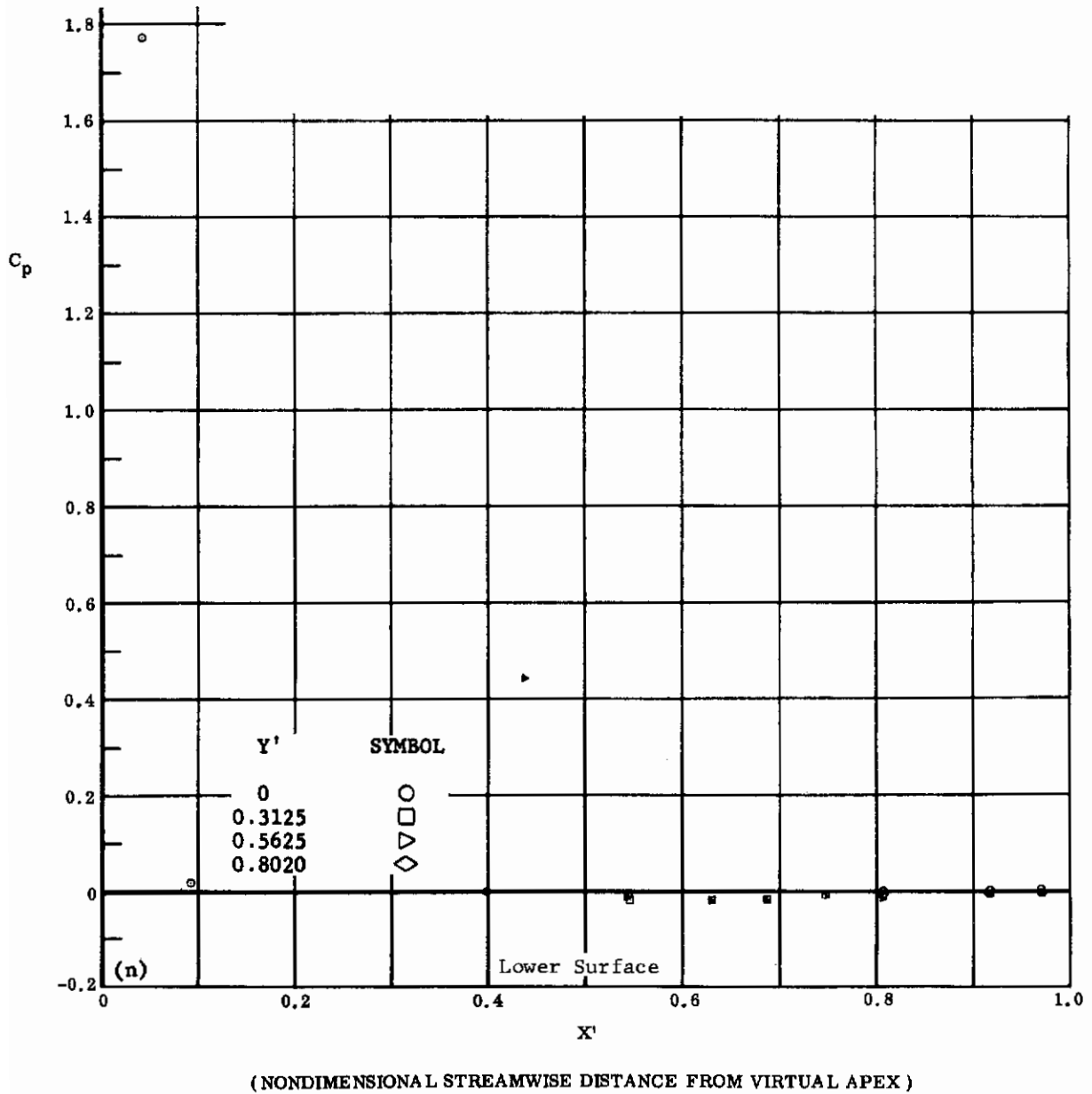
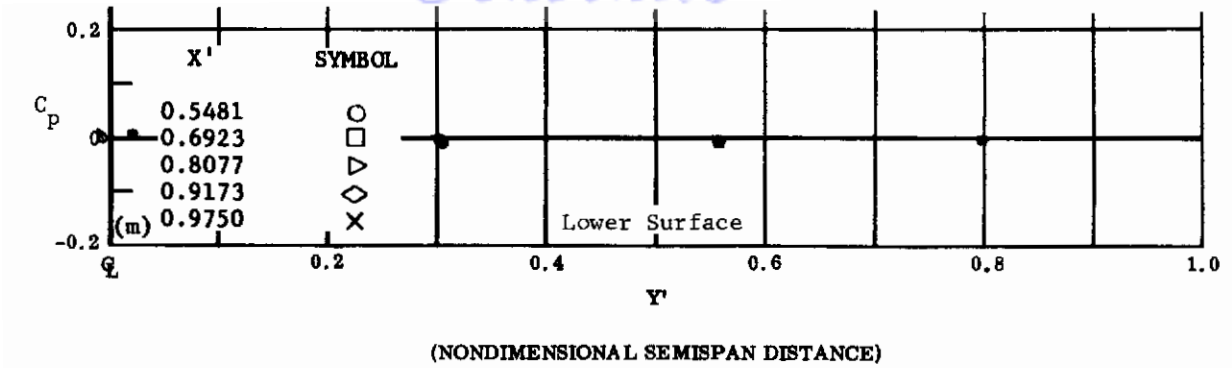

Fig. 17 Configuration I, $\alpha = -10$, $\delta_2 = \delta_3 = -39$

- m) C_p vs. Y' , lower surface
- n) C_p vs. X' , lower surface

Contrails

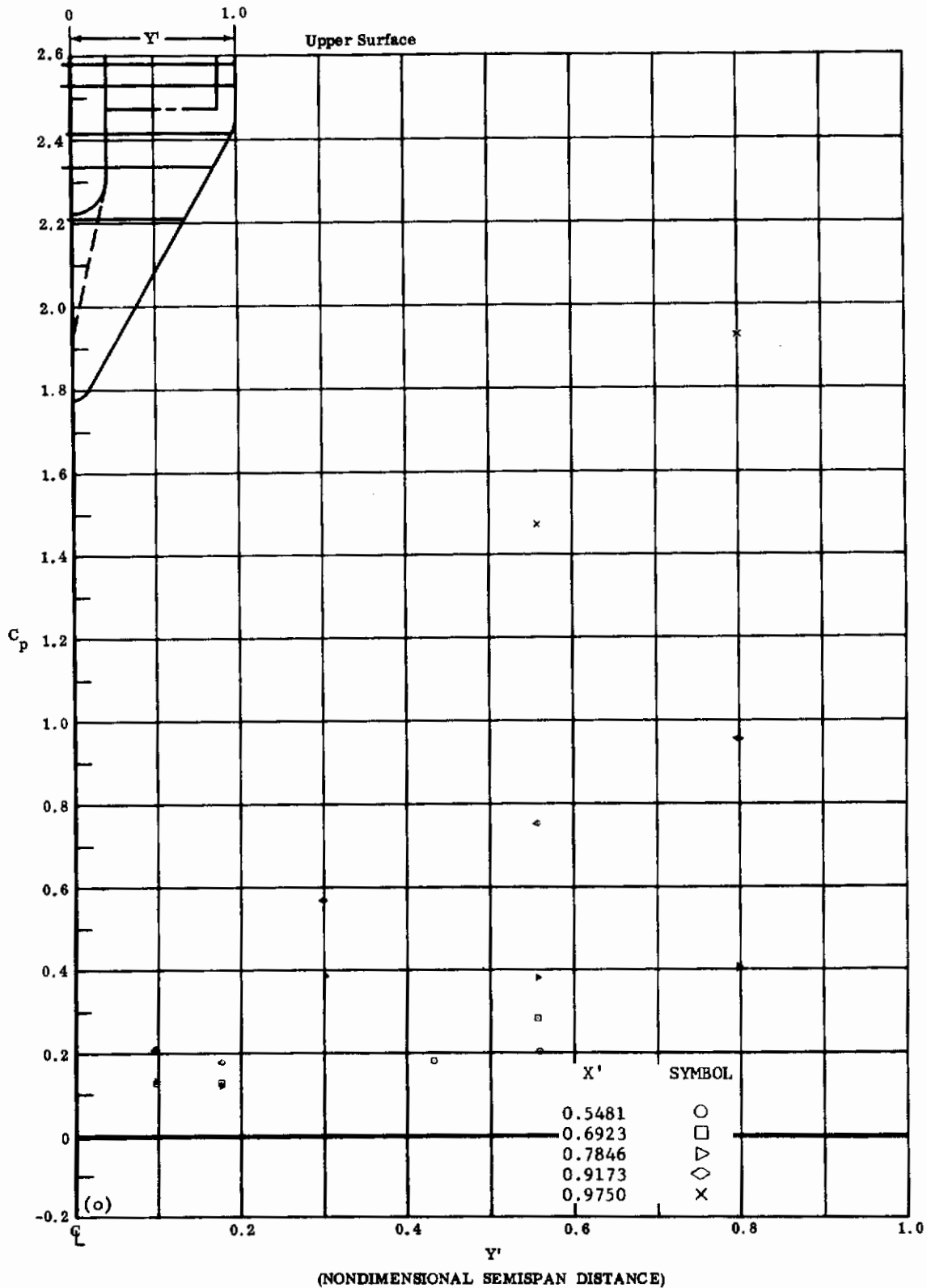
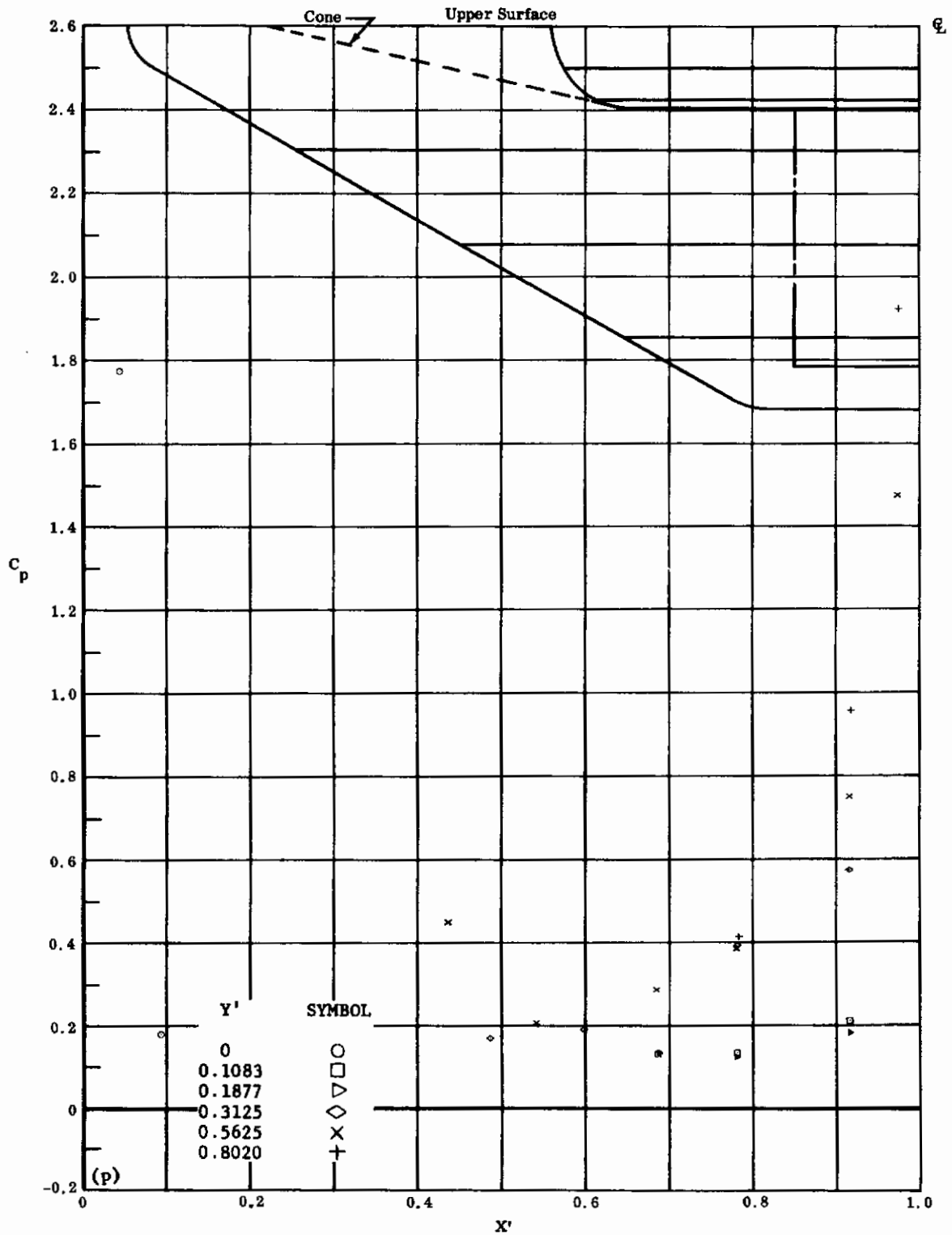

Fig. 170 Configuration I, $\alpha = -10$, $\delta_2 = \delta_3 = -39$

C_p vs. Y' , upper surface

Contrails



(NONDIMENSIONAL STREAMWISE DISTANCE FROM VIRTUAL APEX)

Fig. 17p Configuration I, $\alpha = -10$, $\delta_2 = \delta_3 = -39$

C_p vs. X' , upper surface

Contrails

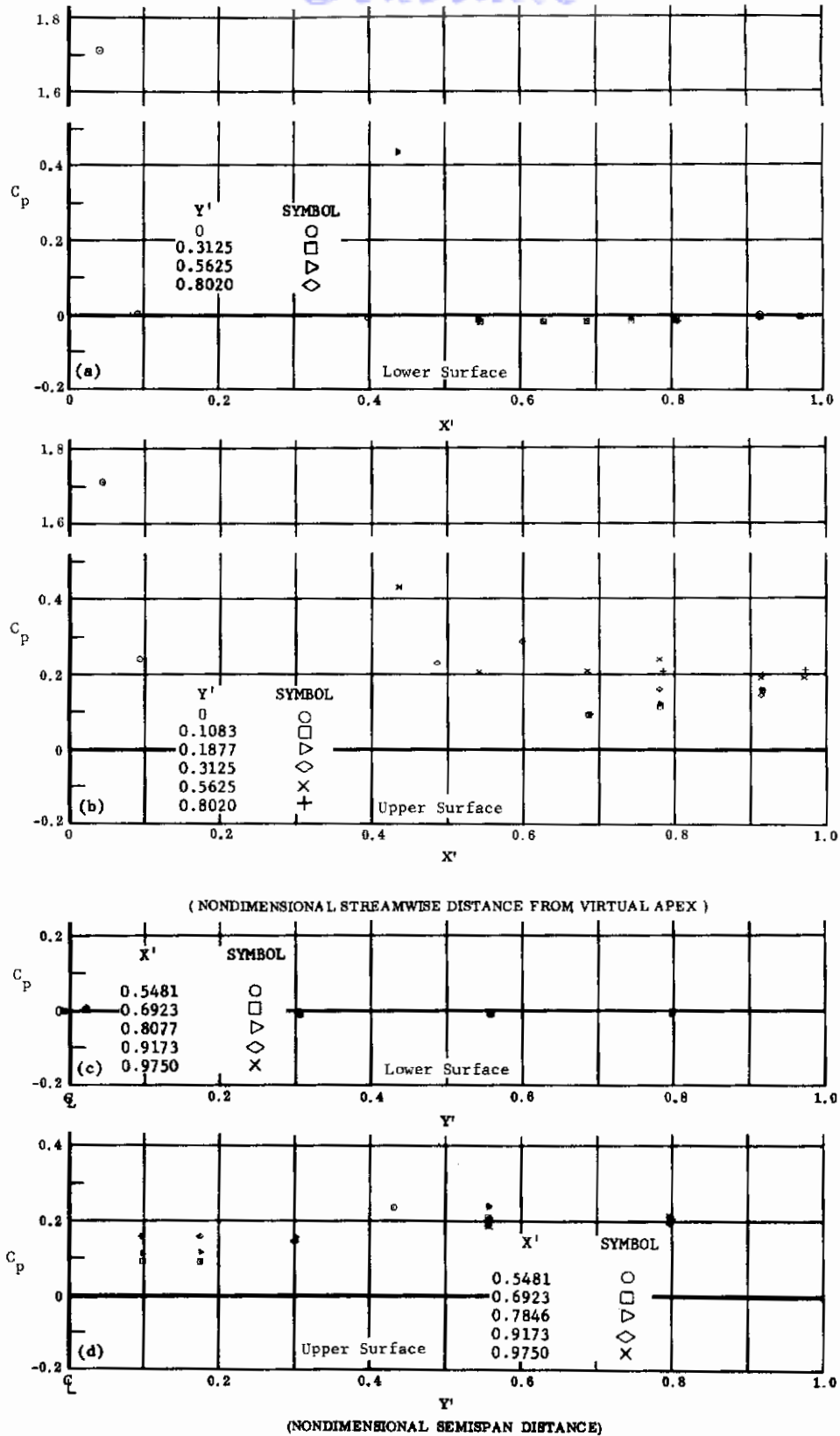

Fig. 18 Configuration I, $\alpha = -15$, $\delta_2 = \delta_3 = 0$

- a) C_p vs. X' , lower surface
- b) C_p vs. X' , upper surface
- c) C_p vs. Y' , lower surface
- d) C_p vs. Y' , upper surface

Contrails

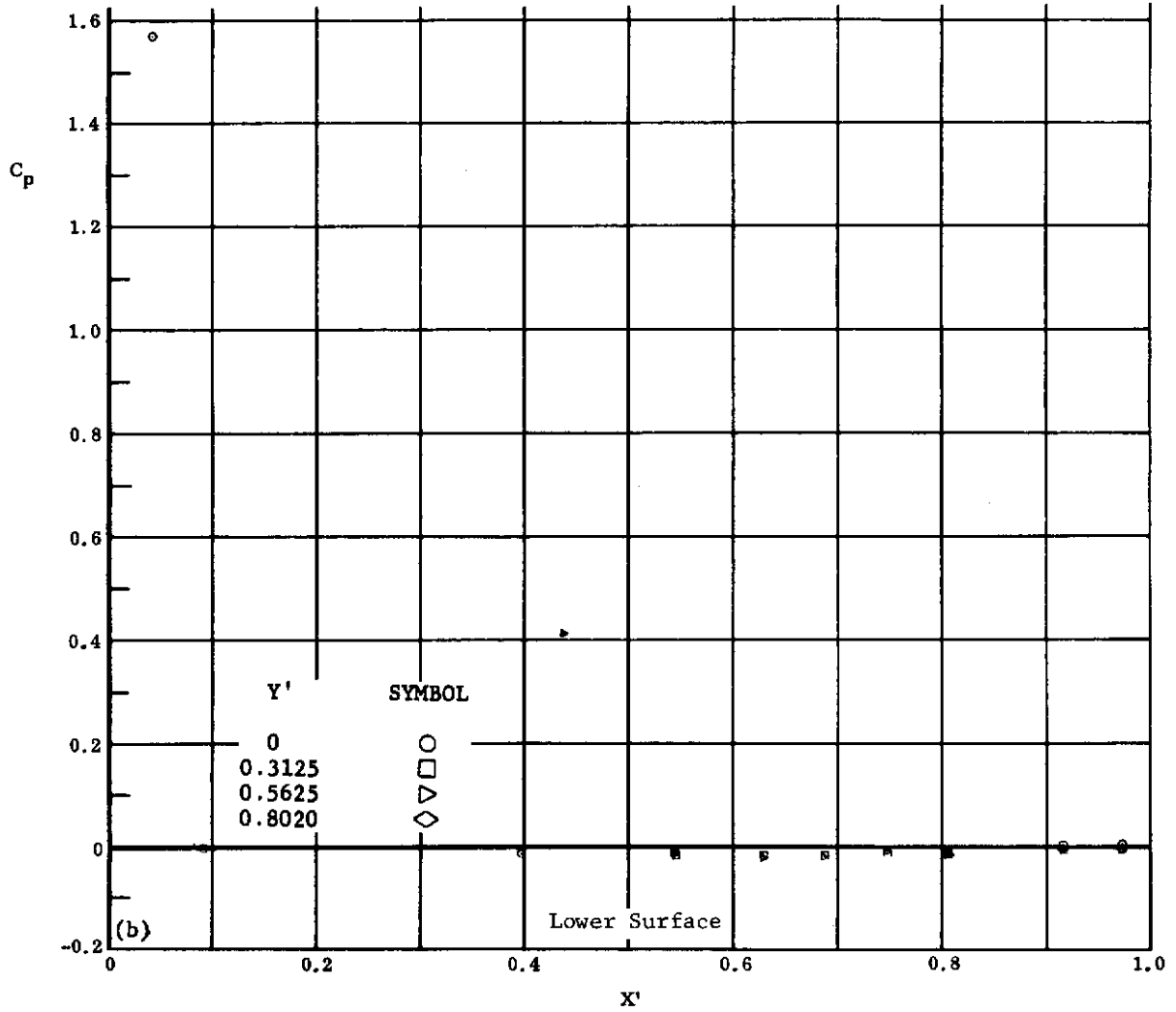
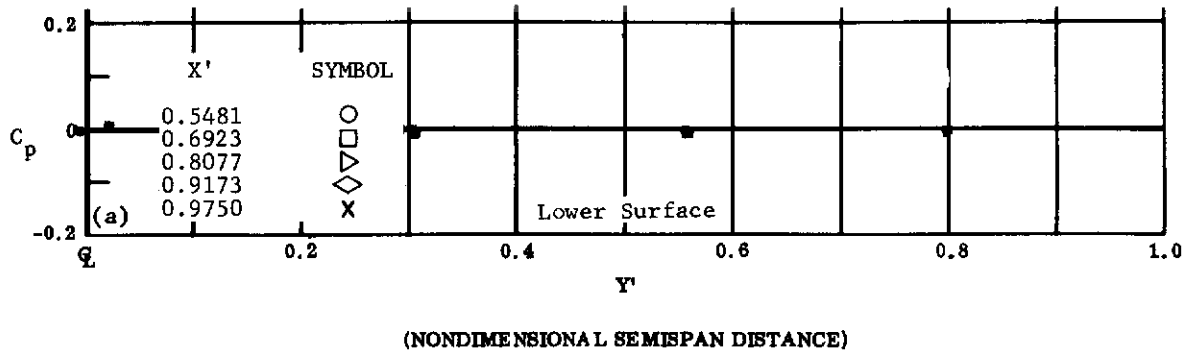
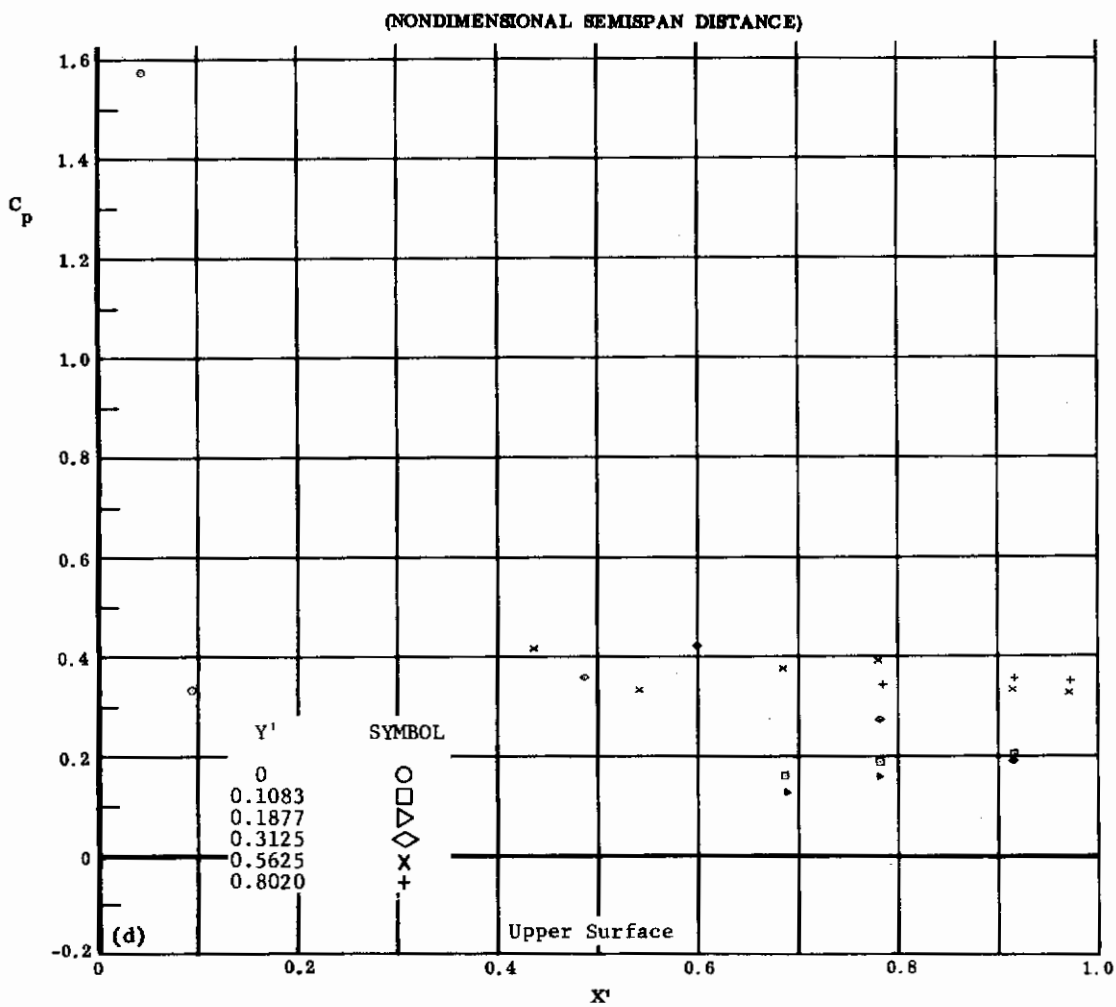
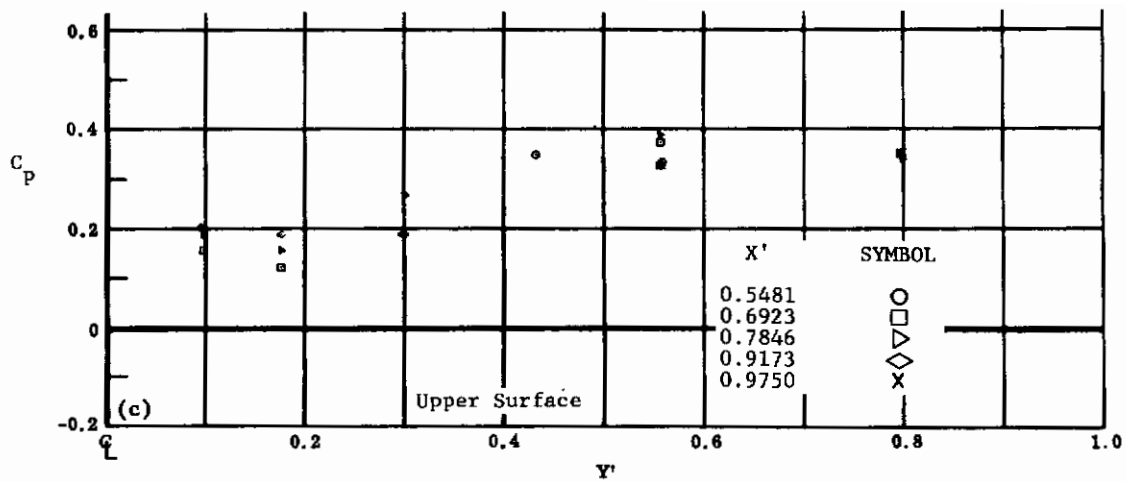

Fig. 19 Configuration I, $\alpha = -20$, $\delta_2 = \delta_3 = 0$

a) C_p vs. Y', lower surface

b) C_p vs. X', lower surface

Contrails



(NONDIMENSIONAL STREAMWISE DISTANCE FROM VIRTUAL APEX)

Fig. 19 Configuration I, $\alpha = -20$, $\delta_2 = \delta_3 = 0$

c) C_p vs. Y' , upper surface

d) C_p vs. X' , upper surface

Contrails

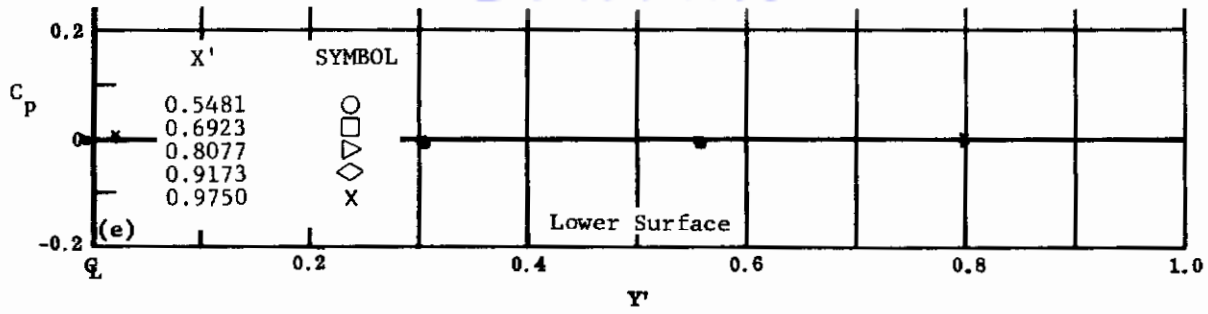

(NONDIMENSIONAL SEMISPAN DISTANCE)

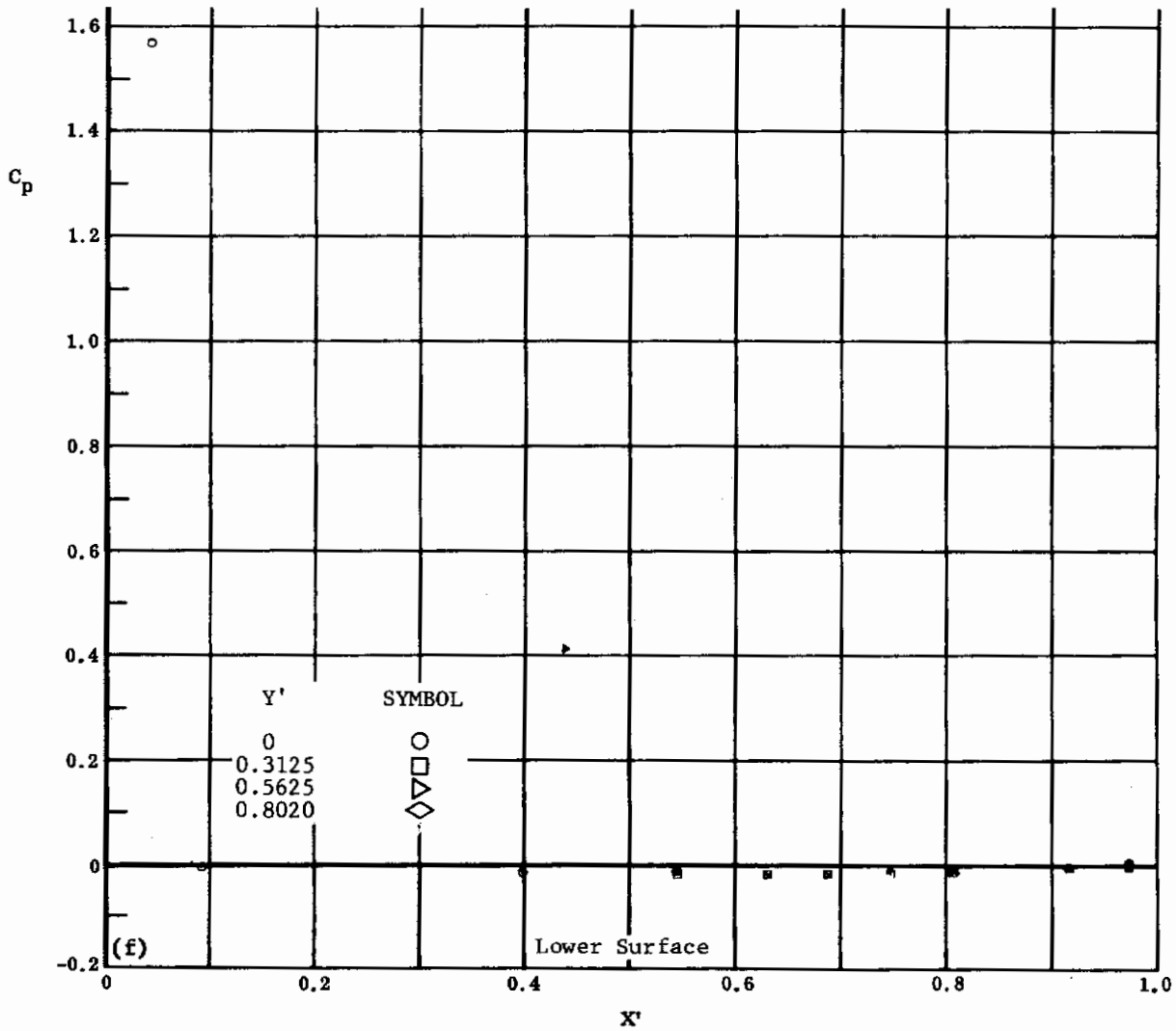

(NONDIMENSIONAL STREAMWISE DISTANCE FROM VIRTUAL APEX)

Fig. 19 Configuration I, $\alpha = -20$, $\delta_2 = \delta_3 = +10$

e) C_p vs. Y' , lower surface

f) C_p vs. X' , lower surface

Contrails

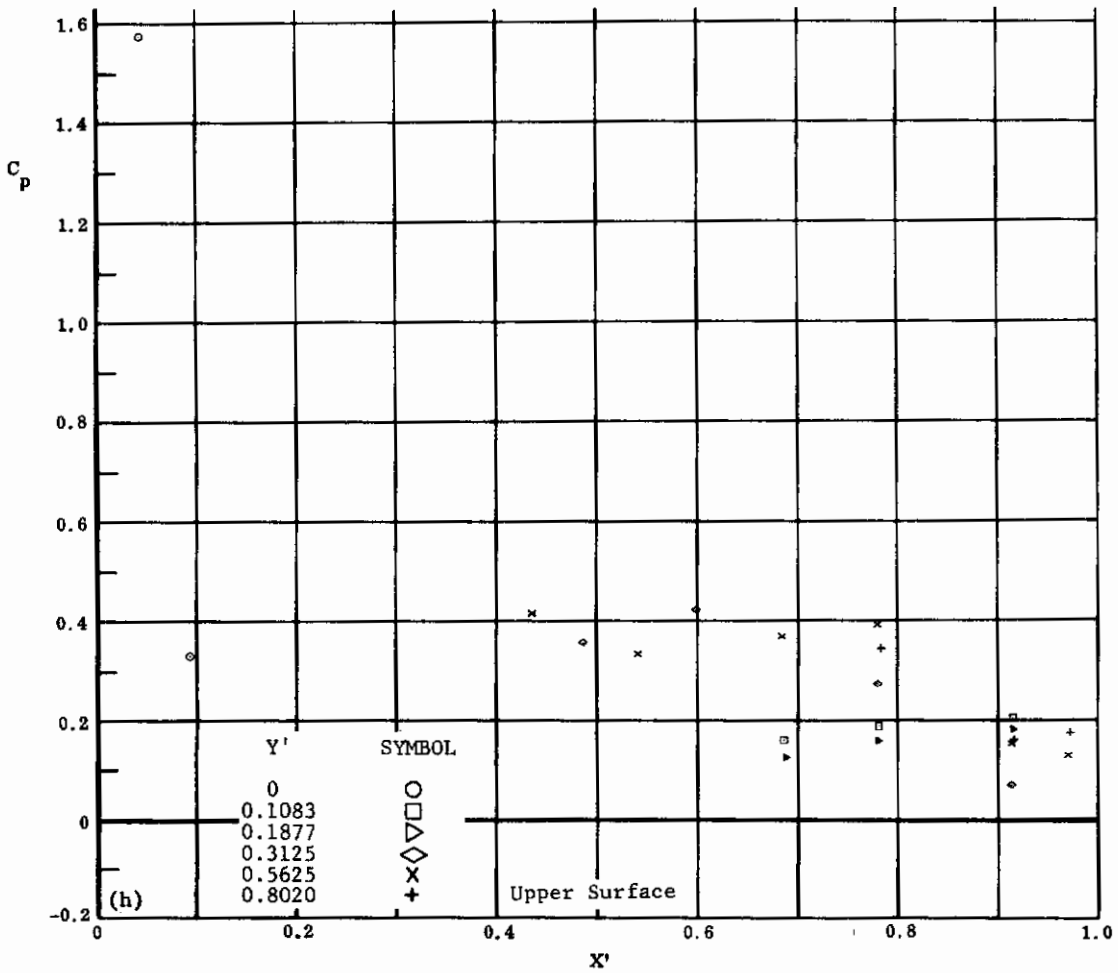
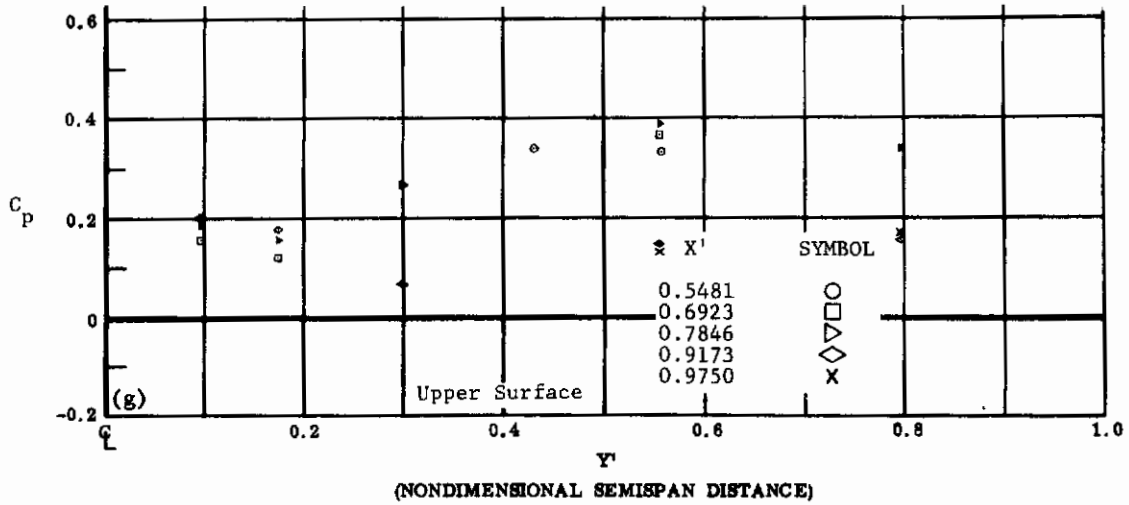

(NONDIMENSIONAL STREAMWISE DISTANCE FROM VIRTUAL APEX)

Fig. 19 Configuration I, $\alpha = -20$, $\delta_2 = \delta_3 = +10$

g) C_p vs. Y' , upper surface

h) C_p vs. X' , upper surface

Contrails

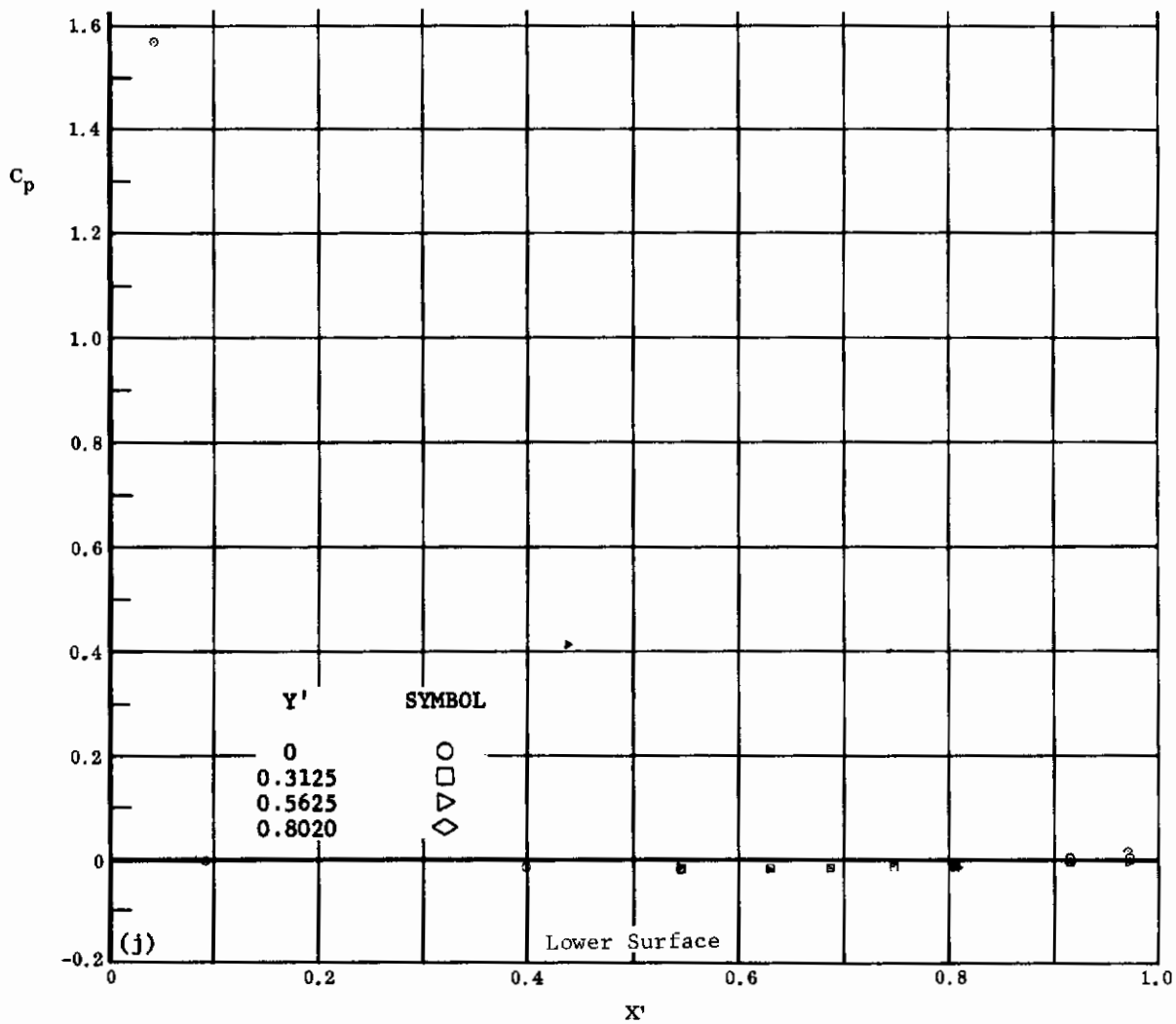
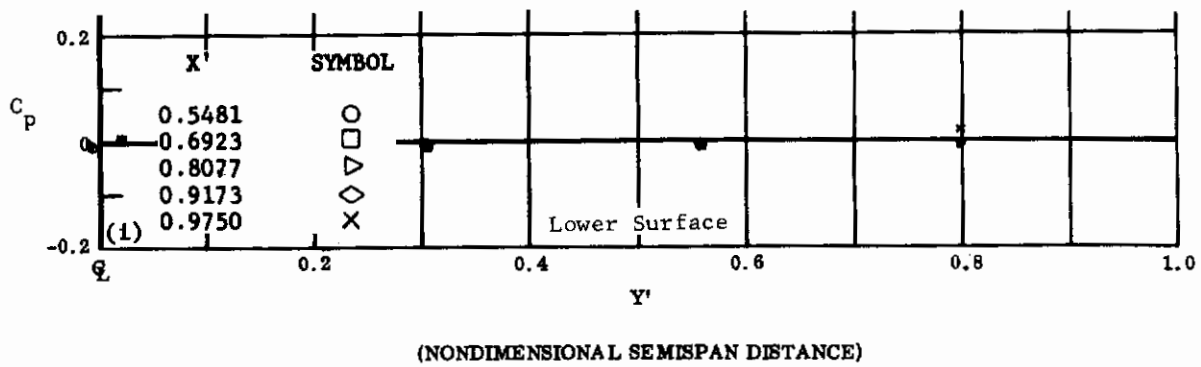
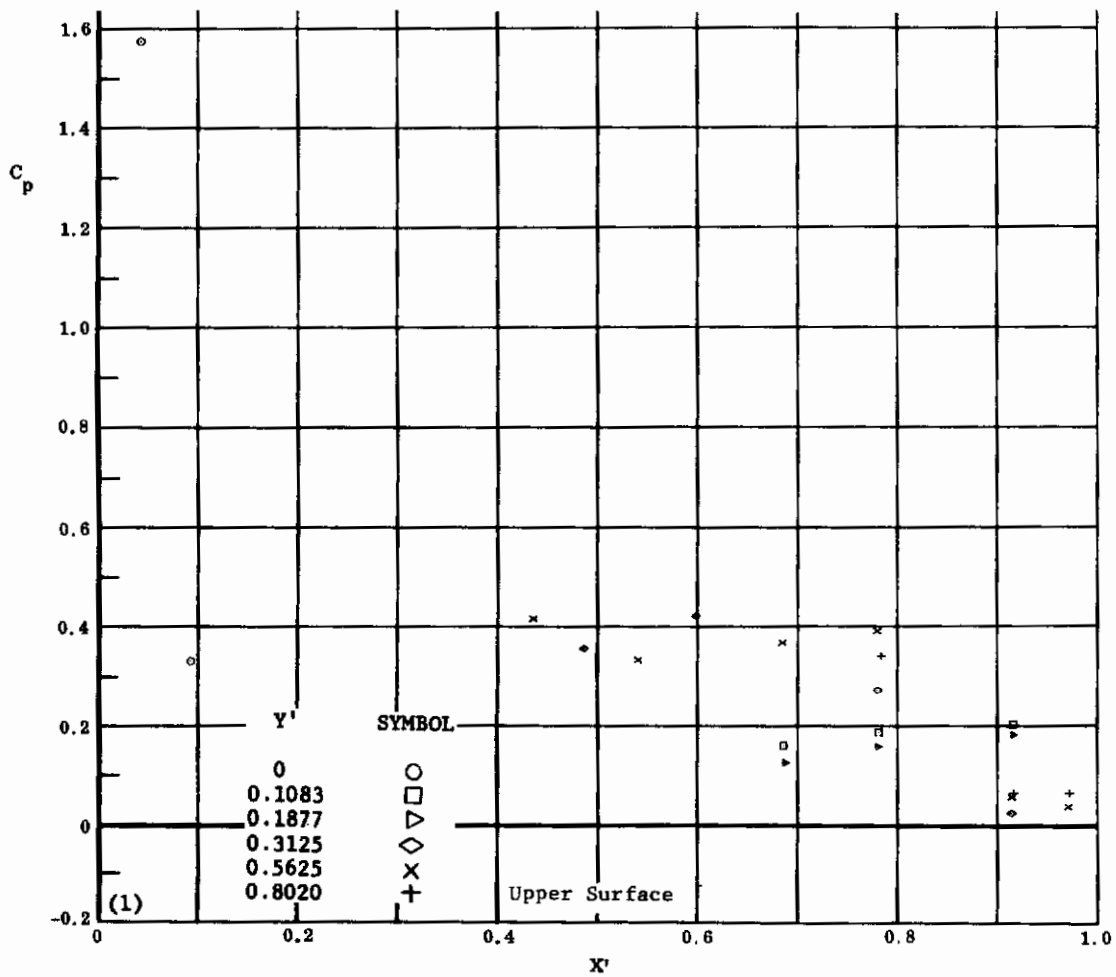
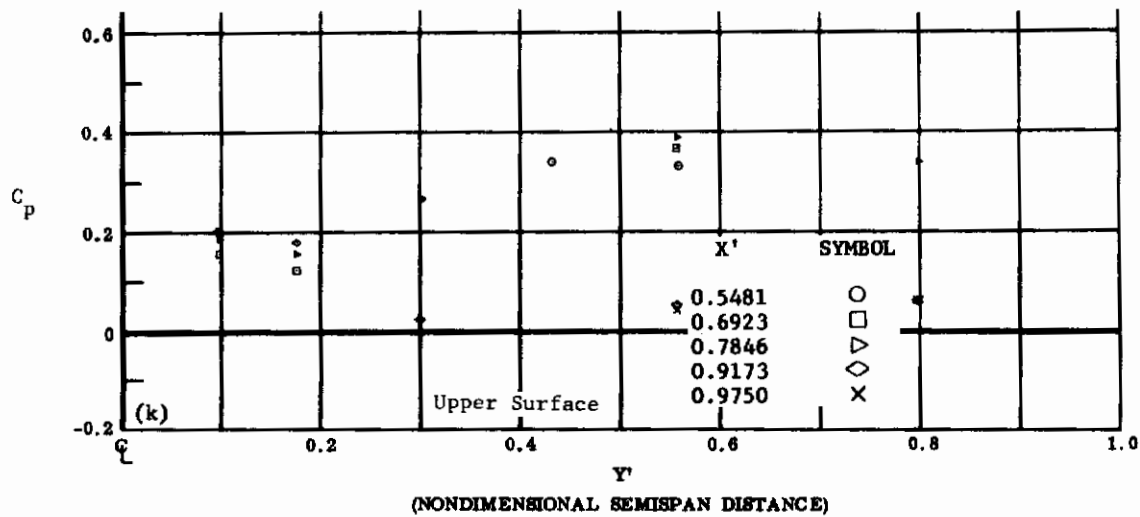

Fig. 19 Configuration I, $\alpha = -20$, $\delta_2 = \delta_3 = +20$

i) C_p vs. Y' , lower surface

j) C_p vs. X' , lower surface

Contrails



(NONDIMENSIONAL STREAMWISE DISTANCE FROM VIRTUAL APEX)

Fig. 19 Configuration I, $\alpha = -20$, $\delta_2 = \delta_3 = +20$

k) C_p vs. Y' , upper surface

l) C_p vs. X' , upper surface

Contrails

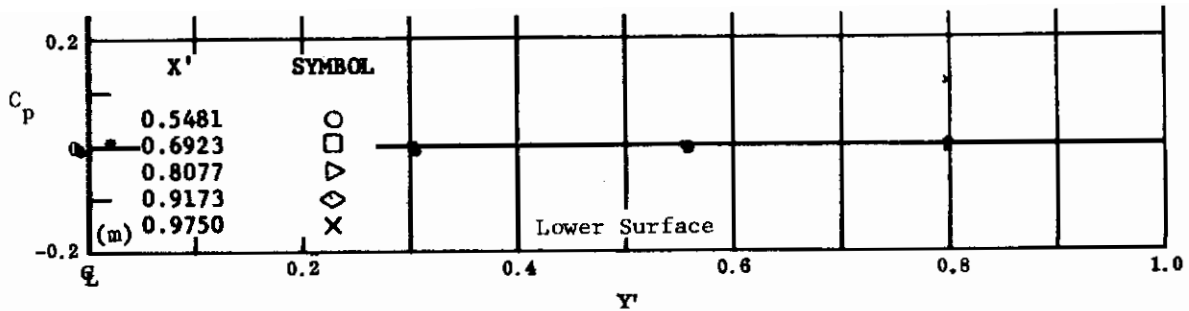

(NONDIMENSIONAL SEMISPAN DISTANCE)

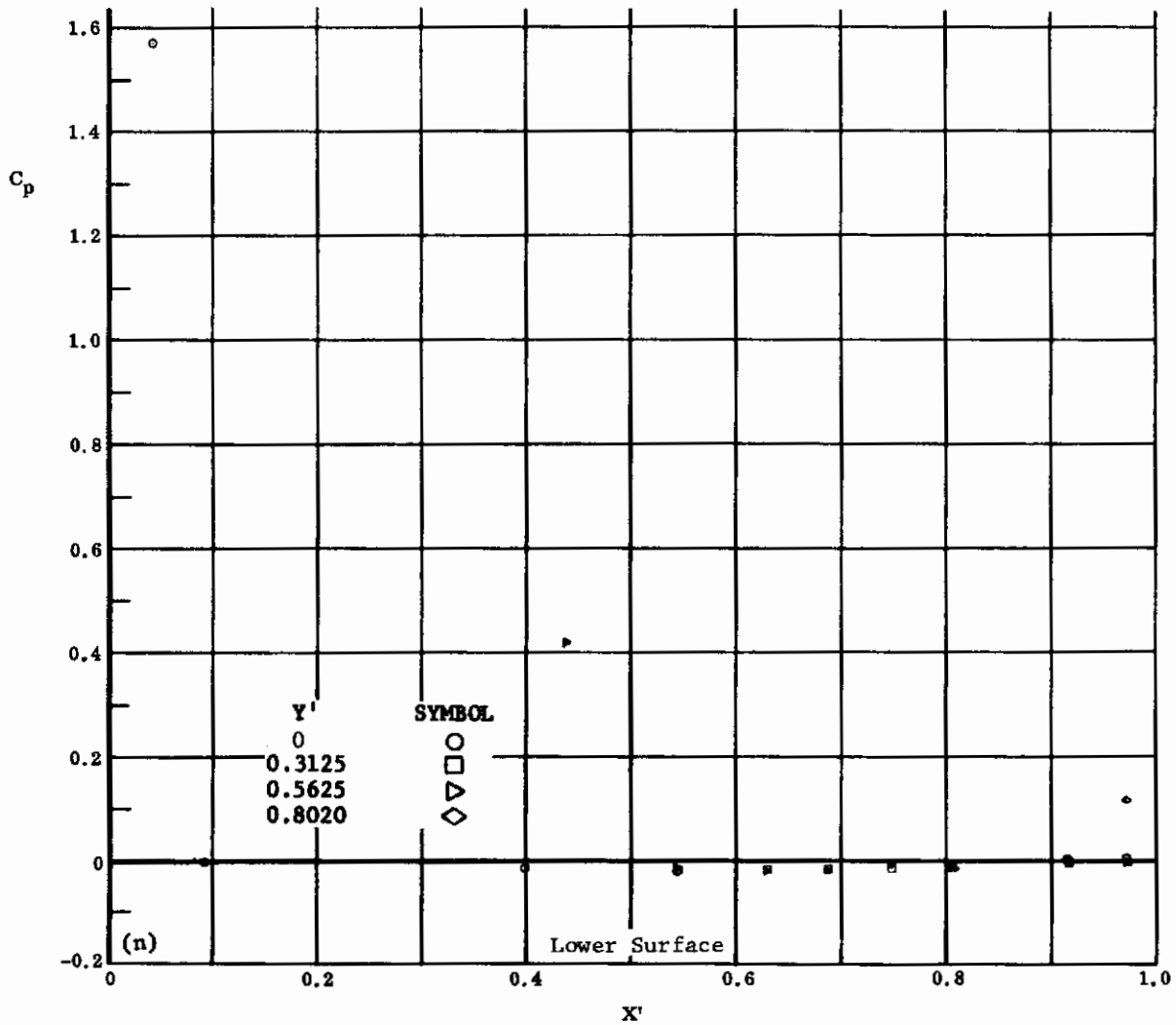

(NONDIMENSIONAL STREAMWISE DISTANCE FROM VIRTUAL APEX)

Fig. 19 Configuration I, $\alpha = -20$, $\delta_2 = \delta_3 = +30$

m) C_p vs. Y' , lower surface

n) C_p vs. X' , lower surface

Contrails

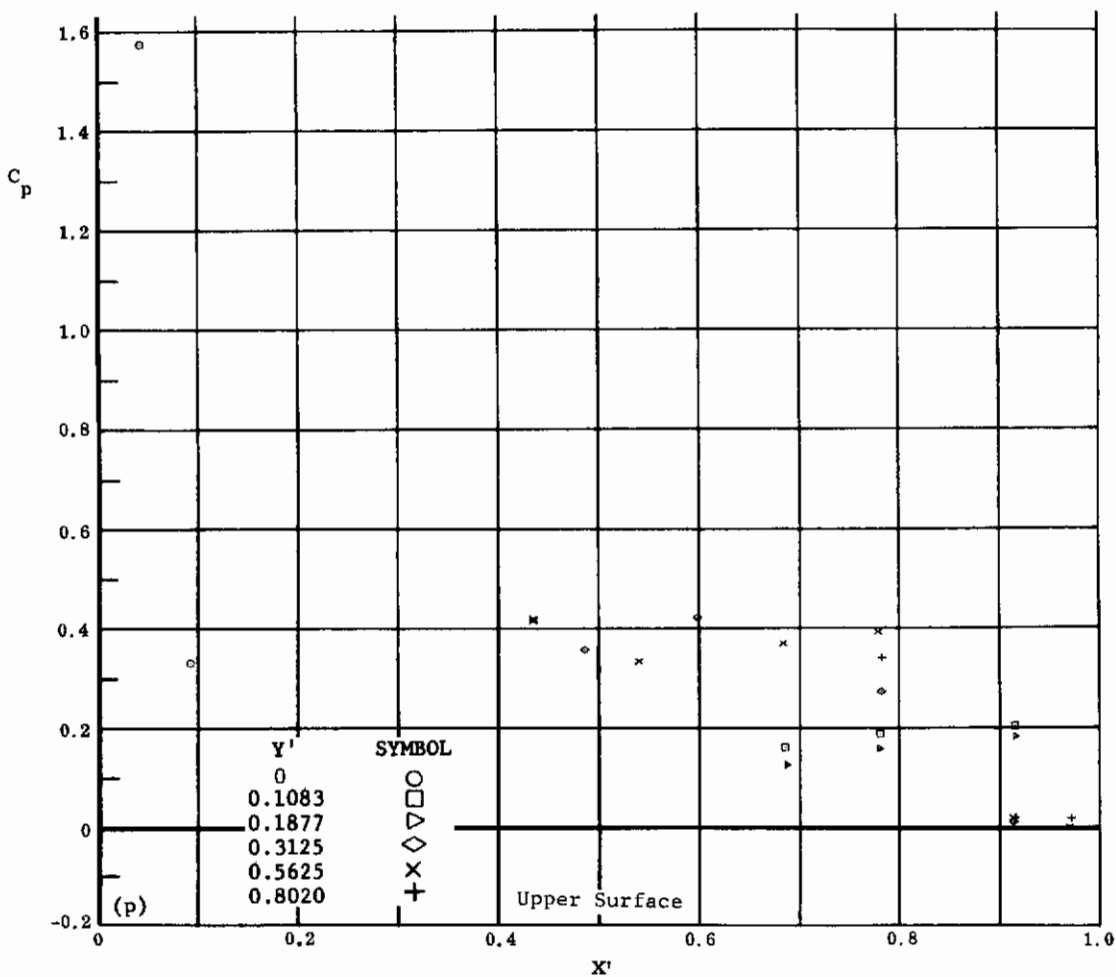
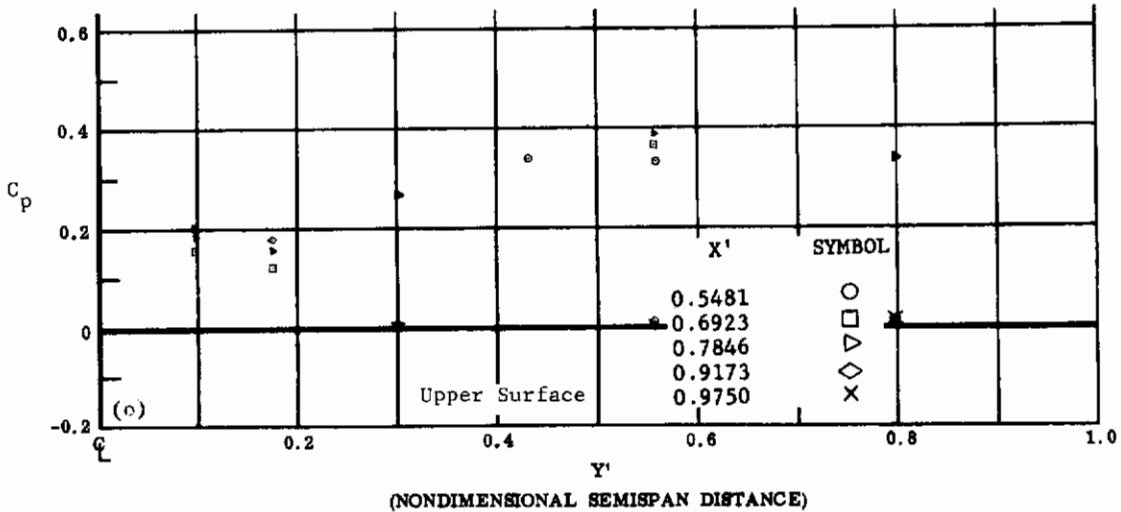

(NONDIMENSIONAL STREAMWISE DISTANCE FROM VIRTUAL APEX)

Fig. 19 Configuration I, $\alpha = -20$, $\delta_2 = \delta_3 = +30$

o) C_p vs. Y' , upper surface

p) C_p vs. X' , upper surface

Contrails

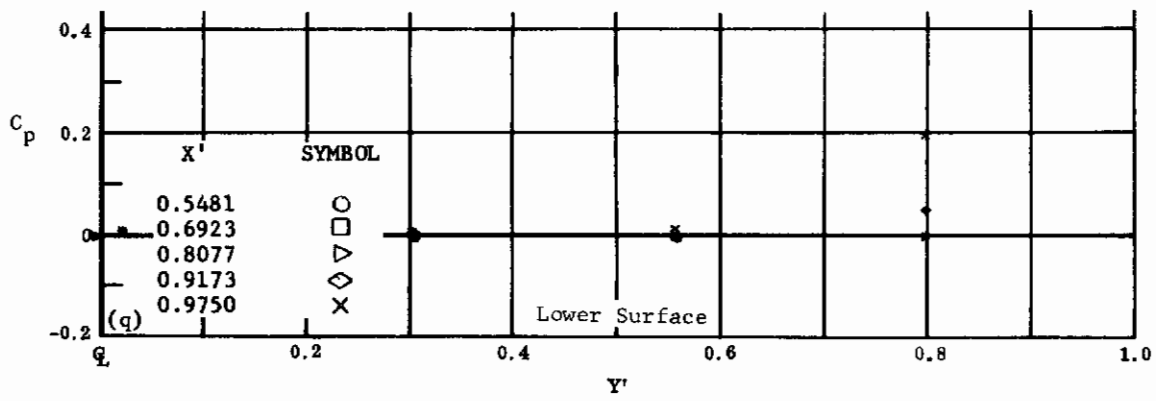

(NONDIMENSIONAL SEMISPAN DISTANCE)

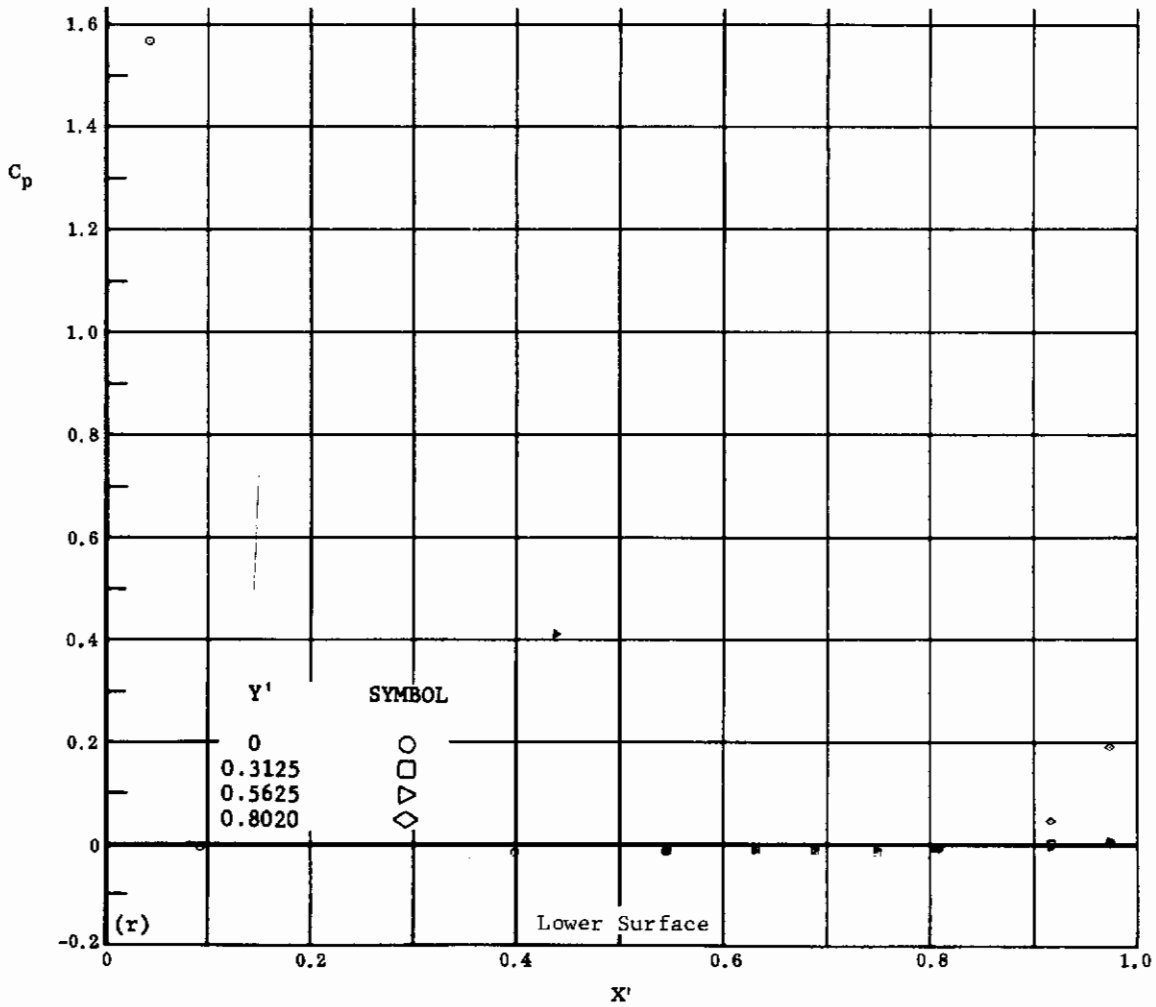

(NONDIMENSIONAL STREAMWISE DISTANCE FROM VIRTUAL APEX)

Fig. 19 Configuration I, $\alpha = -20$, $\delta_2 = \delta_3 = +39$

q) C_p vs. Y' , lower surface

r) C_p vs. X' , lower surface

Contrails

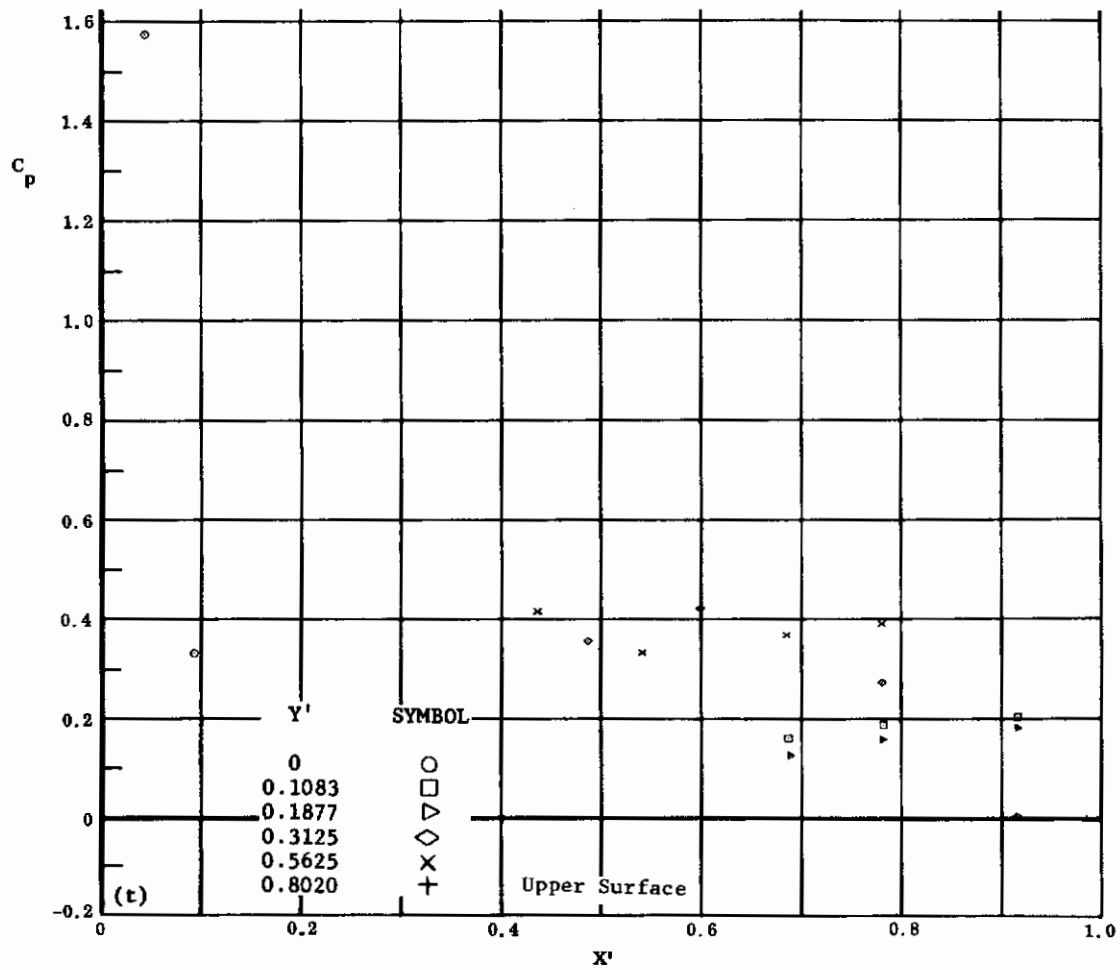
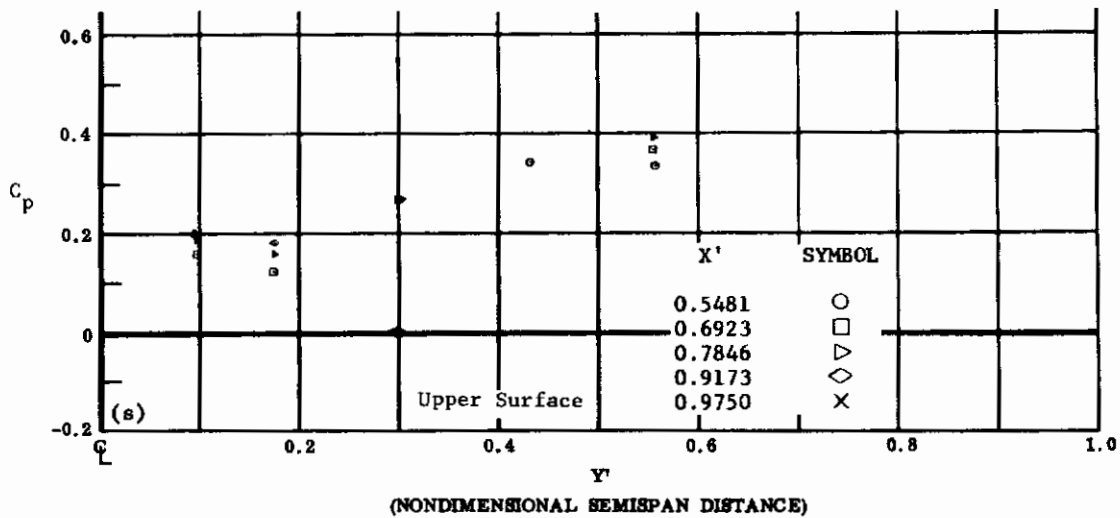

(NONDIMENSIONAL STREAMWISE DISTANCE FROM VIRTUAL APEX)

Fig. 19 Configuration I, $\alpha = -20$, $\delta_2 = \delta_3 = +39$

s) C_p vs. Y' , upper surface

t) C_p vs. X' , upper surface

Contrails

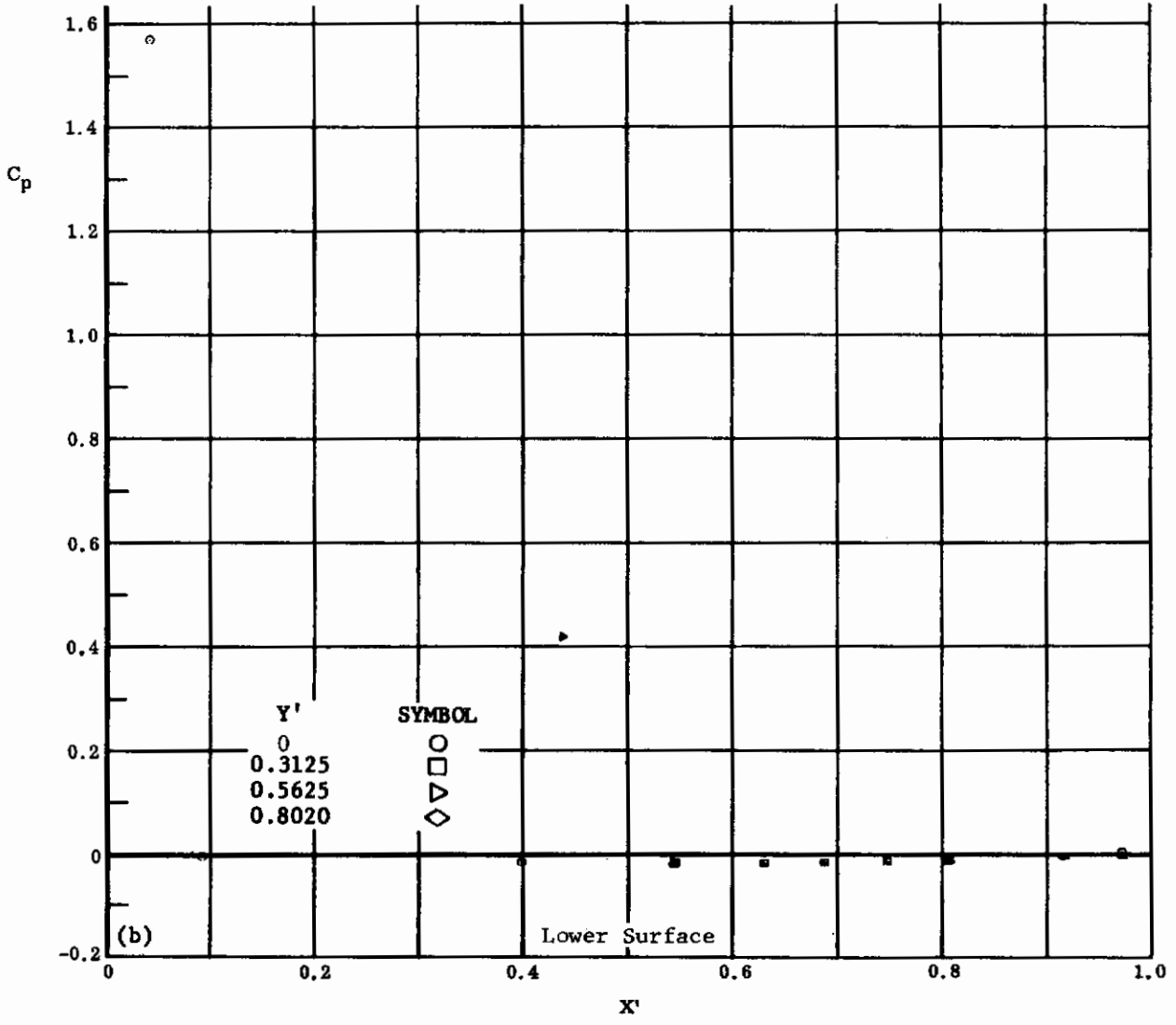
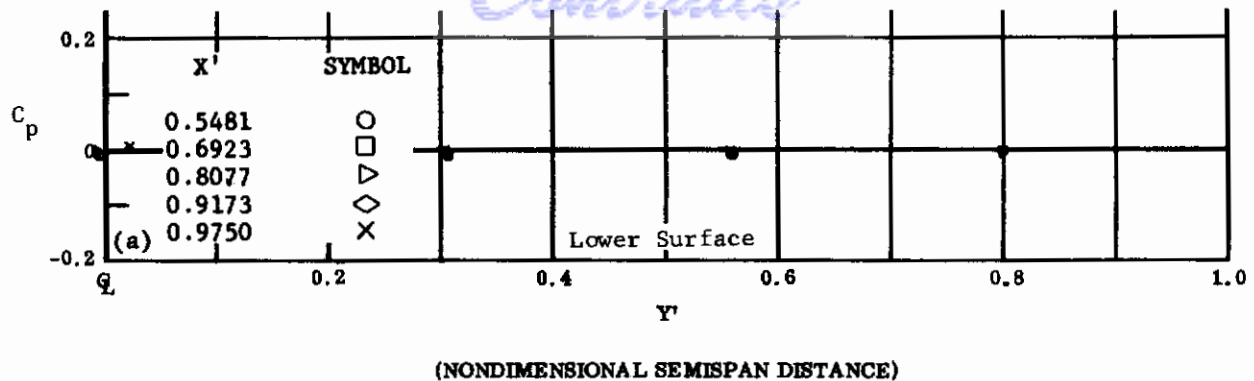

(NONDIMENSIONAL STREAMWISE DISTANCE FROM VIRTUAL APEX)

Fig. 20 Configuration I, $\alpha = -20$, $\delta_2 = \delta_3 = -10$

- a) C_p vs. Y' , lower surface
- b) C_p vs. X' , lower surface

Contrails

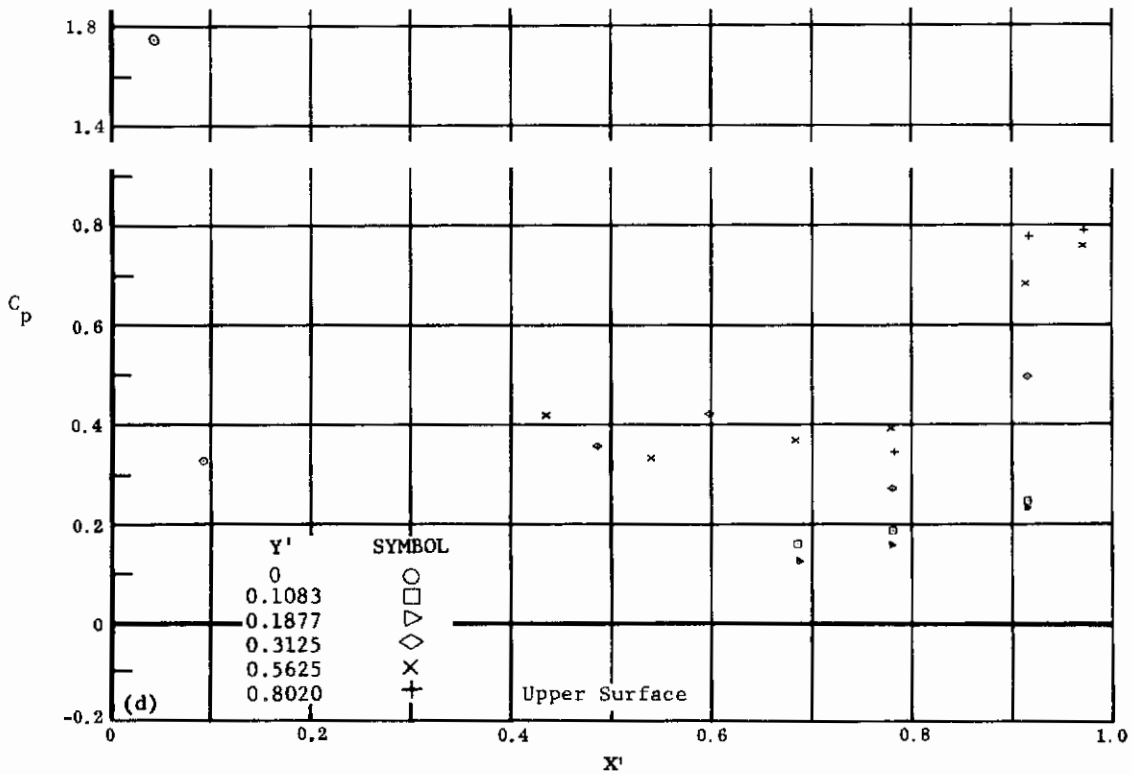
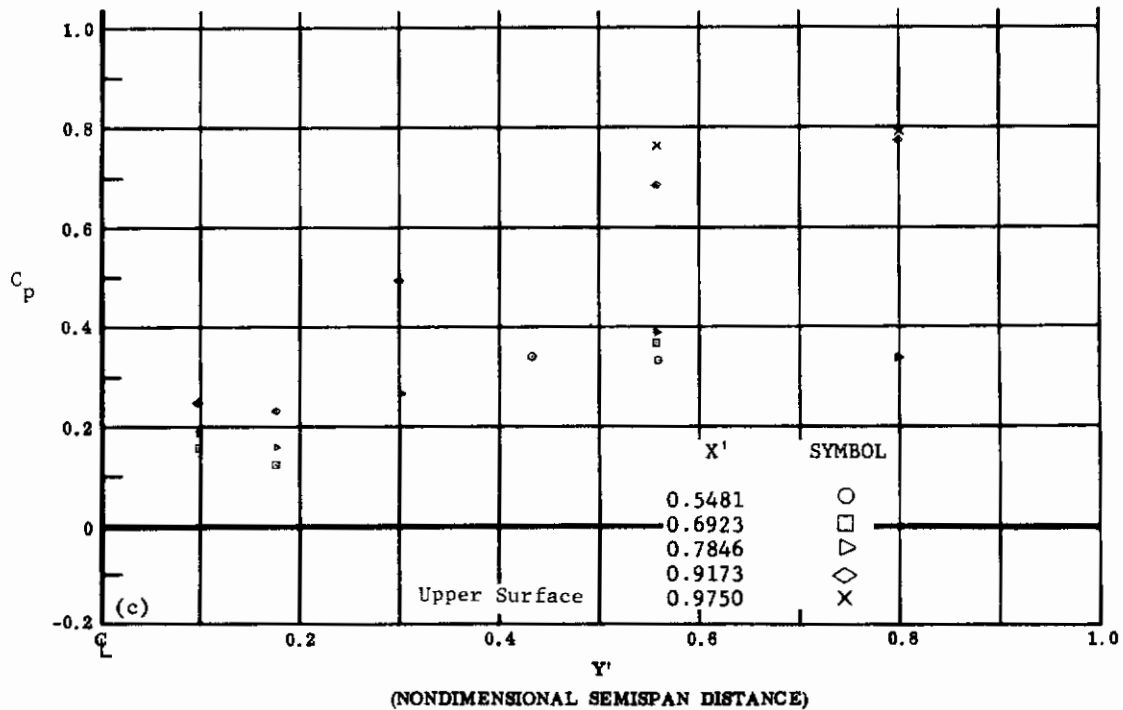

(NONDIMENSIONAL STREAMWISE DISTANCE FROM VIRTUAL APEX)

Fig. 20 Configuration I, $\alpha = -20$, $\delta_2 = \delta_3 = -10$

c) C_p vs. Y' , upper surface

d) C_p vs. X' , upper surface

Contrails

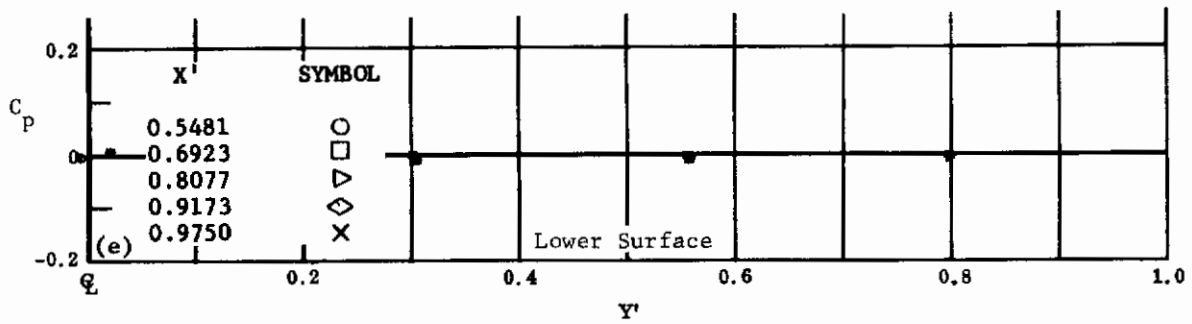

(NONDIMENSIONAL SEMISPAN DISTANCE)

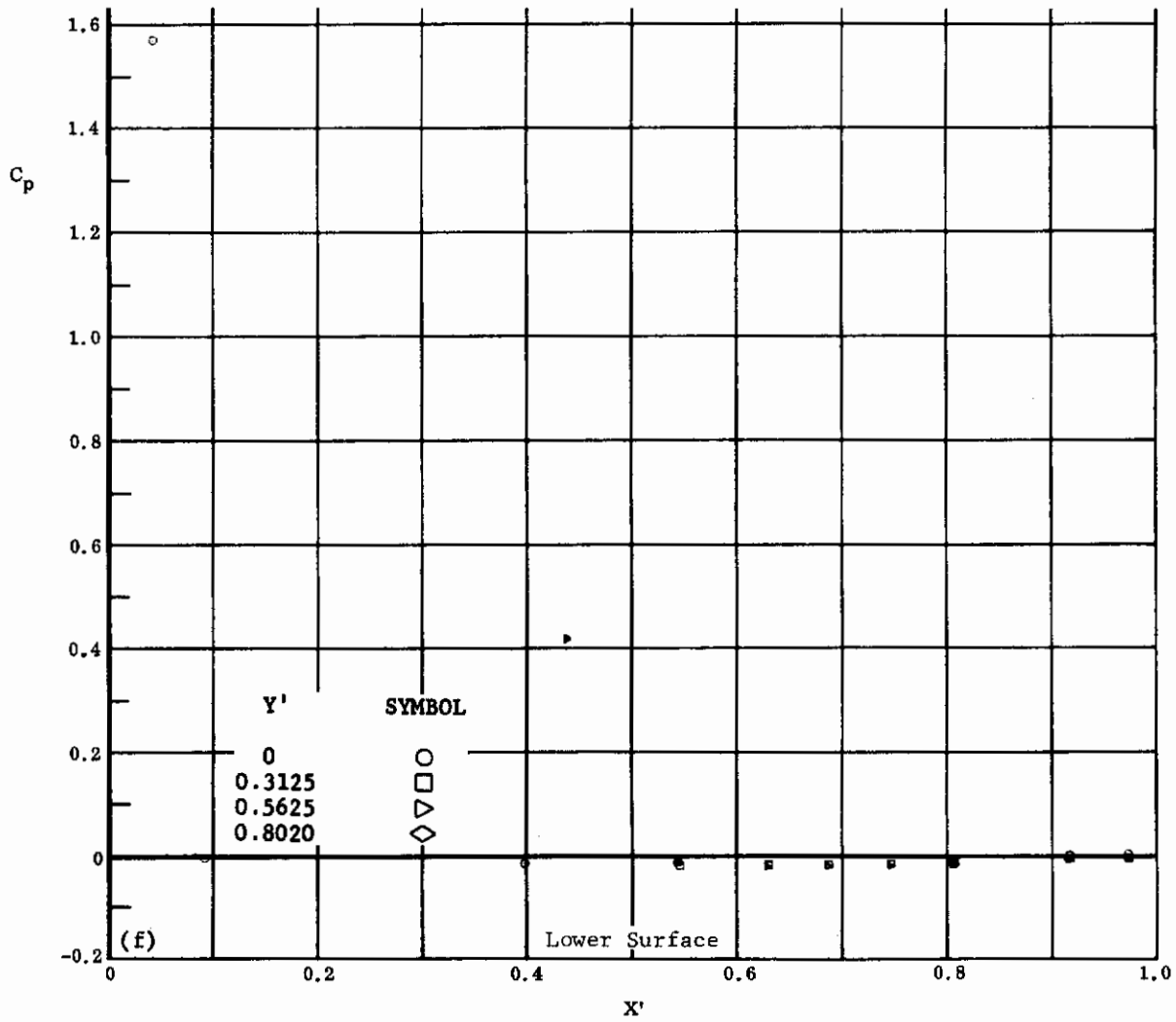

(NONDIMENSIONAL STREAMWISE DISTANCE FROM VIRTUAL APEX)

Fig. 20 Configuration I, $\alpha = -20$, $\delta_2 = \delta_3 = -20$

e) C_p vs. Y' , lower surface

f) C_p vs. X' , lower surface

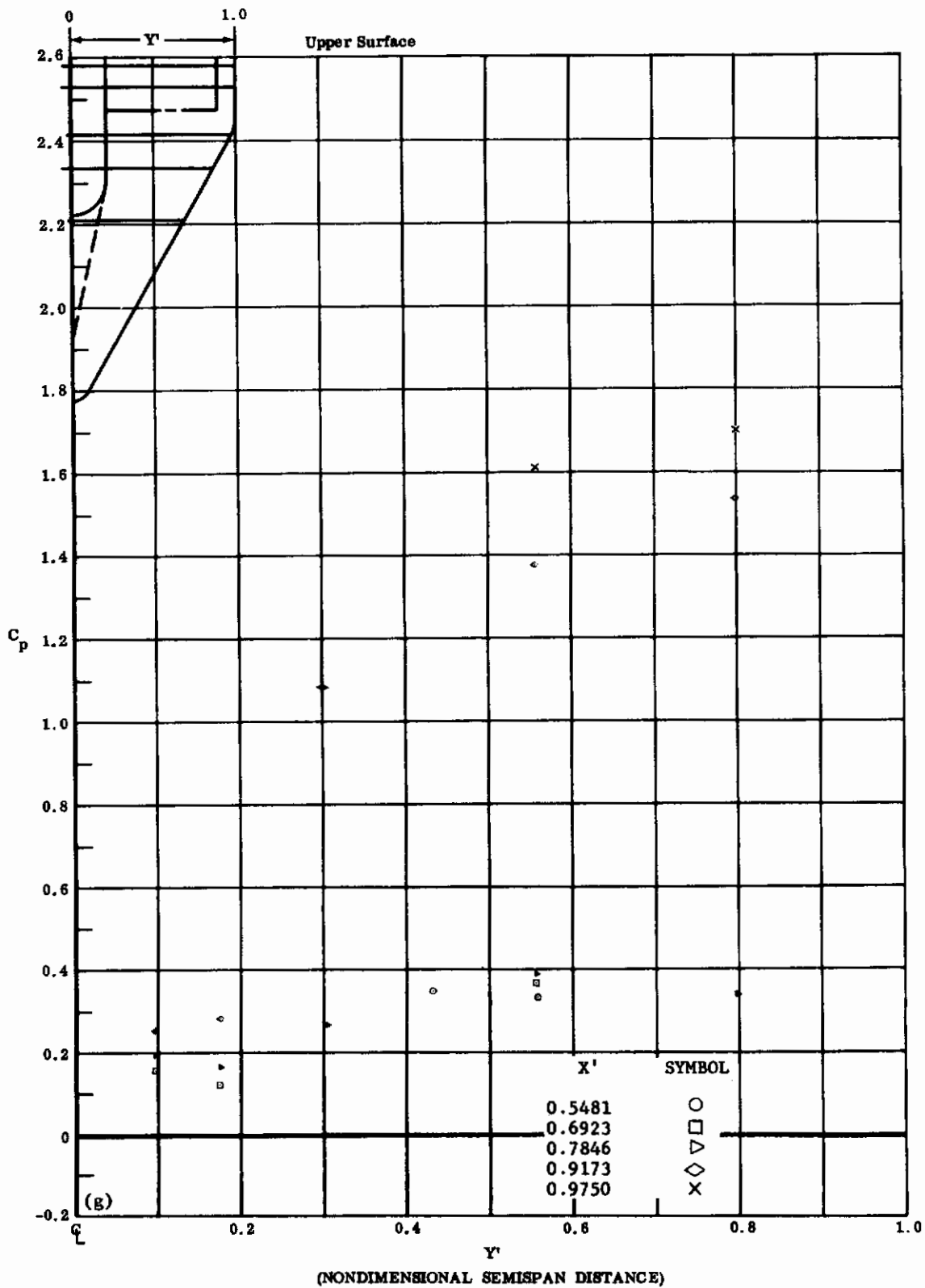
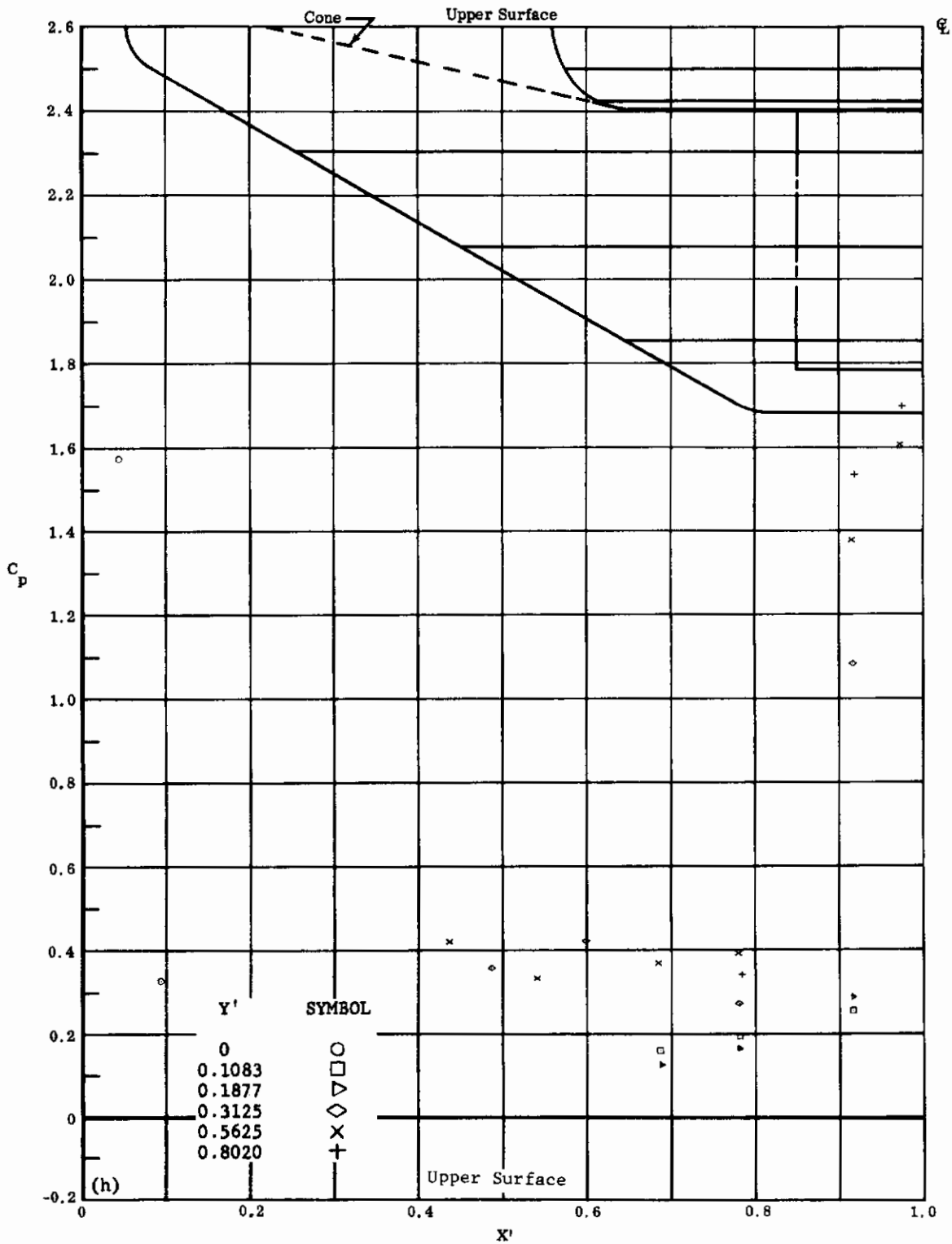

Fig. 20g Configuration I, $\alpha = -20$, $\delta_2 = \delta_3 = -20$

C_p vs. Y' , upper surface



(NONDIMENSIONAL STREAMWISE DISTANCE FROM VIRTUAL APEX)

Fig. 20h Configuration I, $\alpha = -20$, $\delta_2 = \delta_3 = -20$

C_p vs. X' , upper surface

Contrails

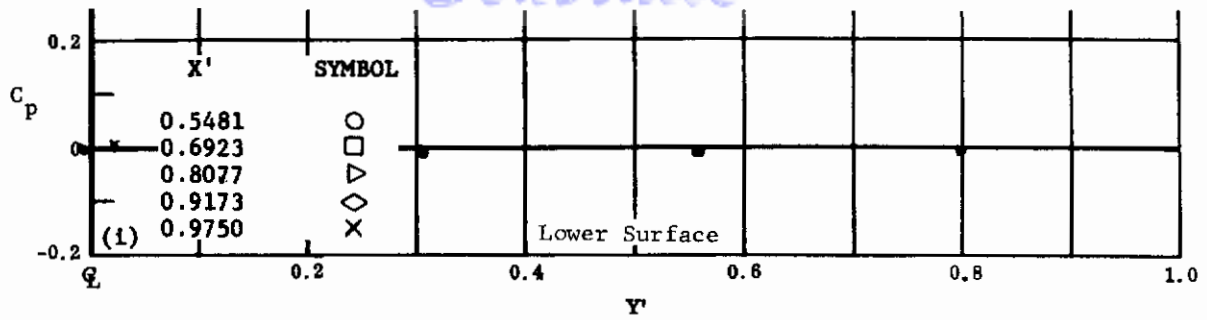

(NONDIMENSIONAL SEMISPAN DISTANCE)

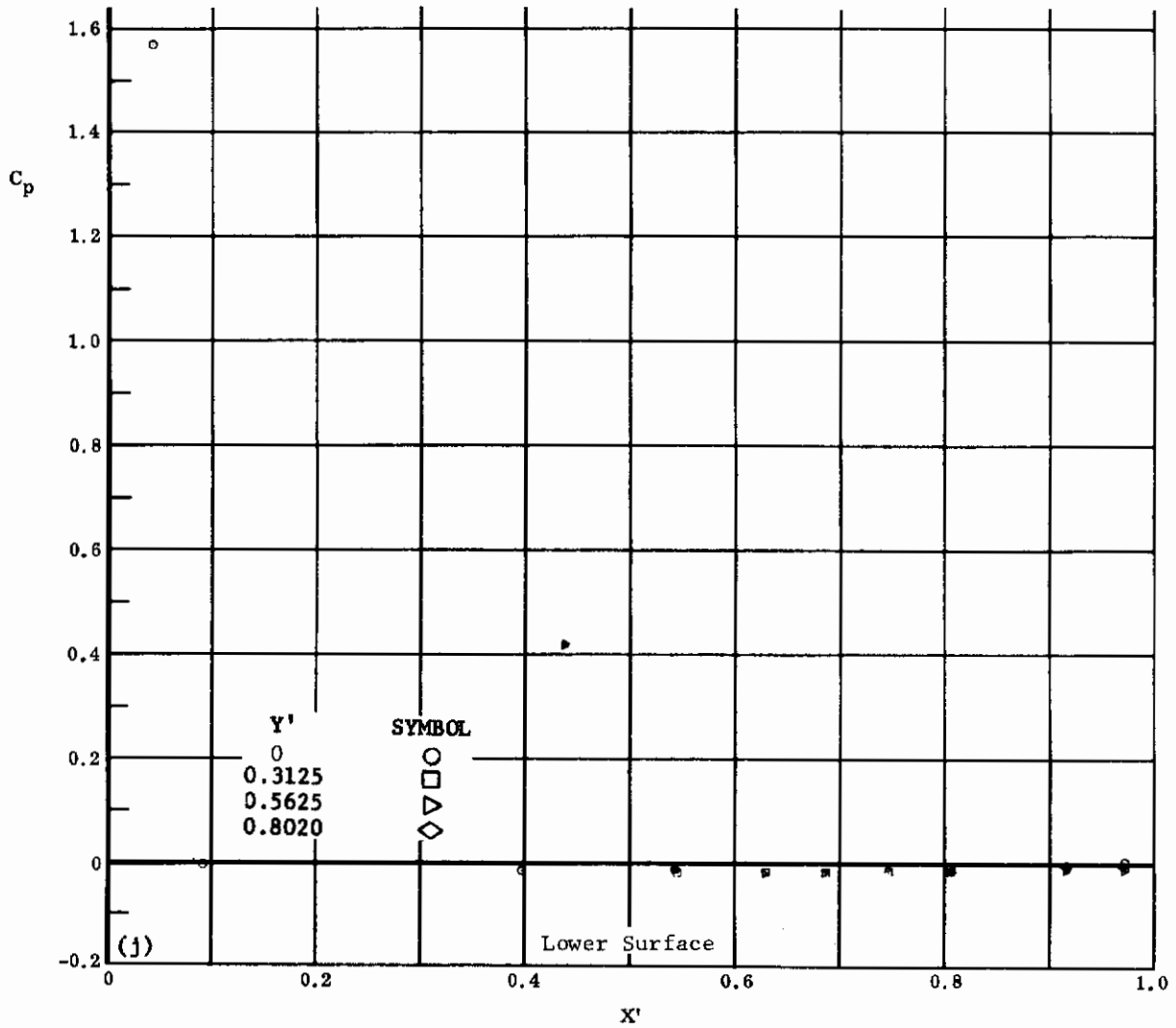

(NONDIMENSIONAL STREAMWISE DISTANCE FROM VIRTUAL APEX)

Fig. 20 Configuration I, $\alpha = -20$, $\delta_2 = \delta_3 = -30$

i) C_p vs. Y' , lower surface

j) C_p vs. X' , lower surface

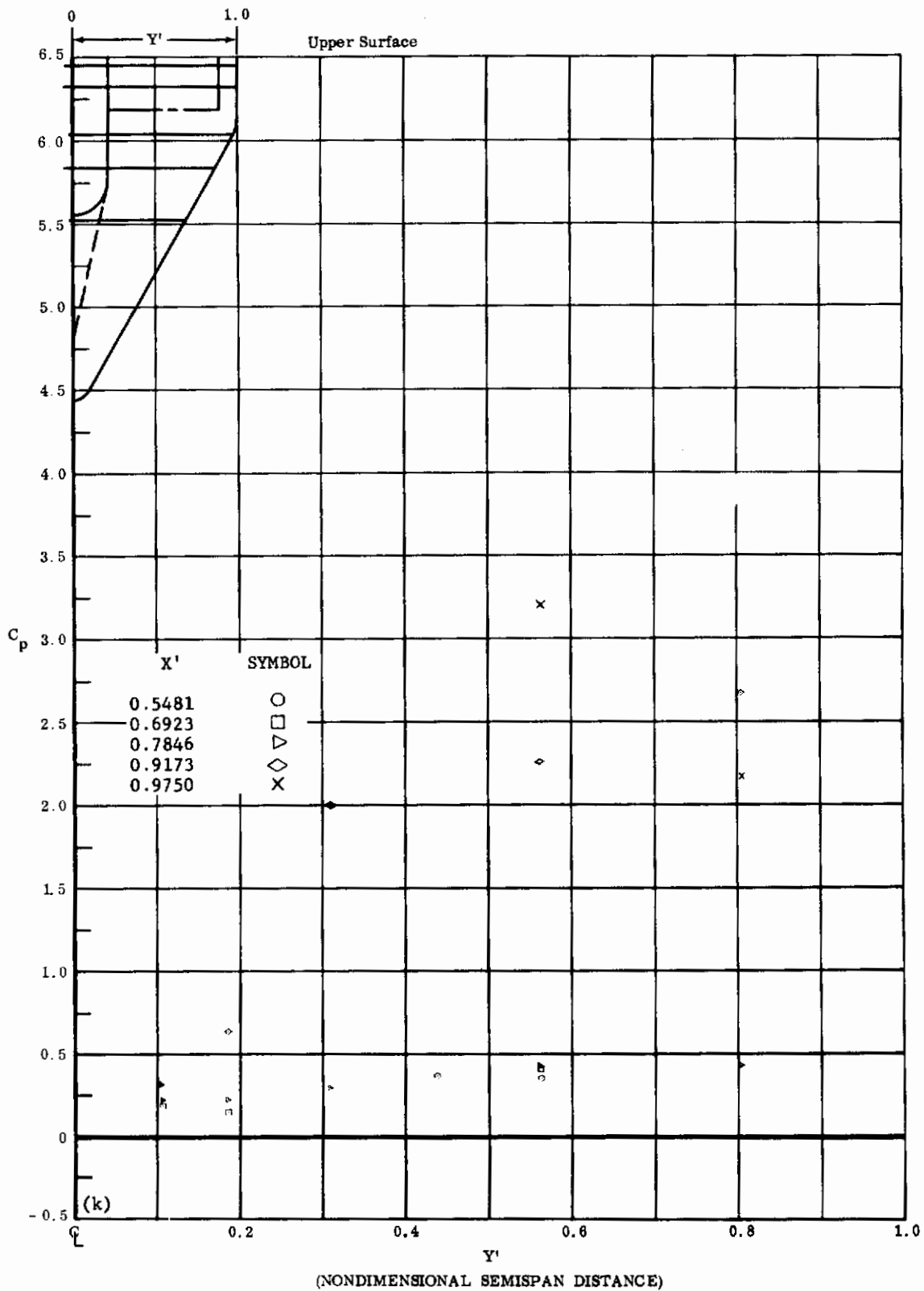
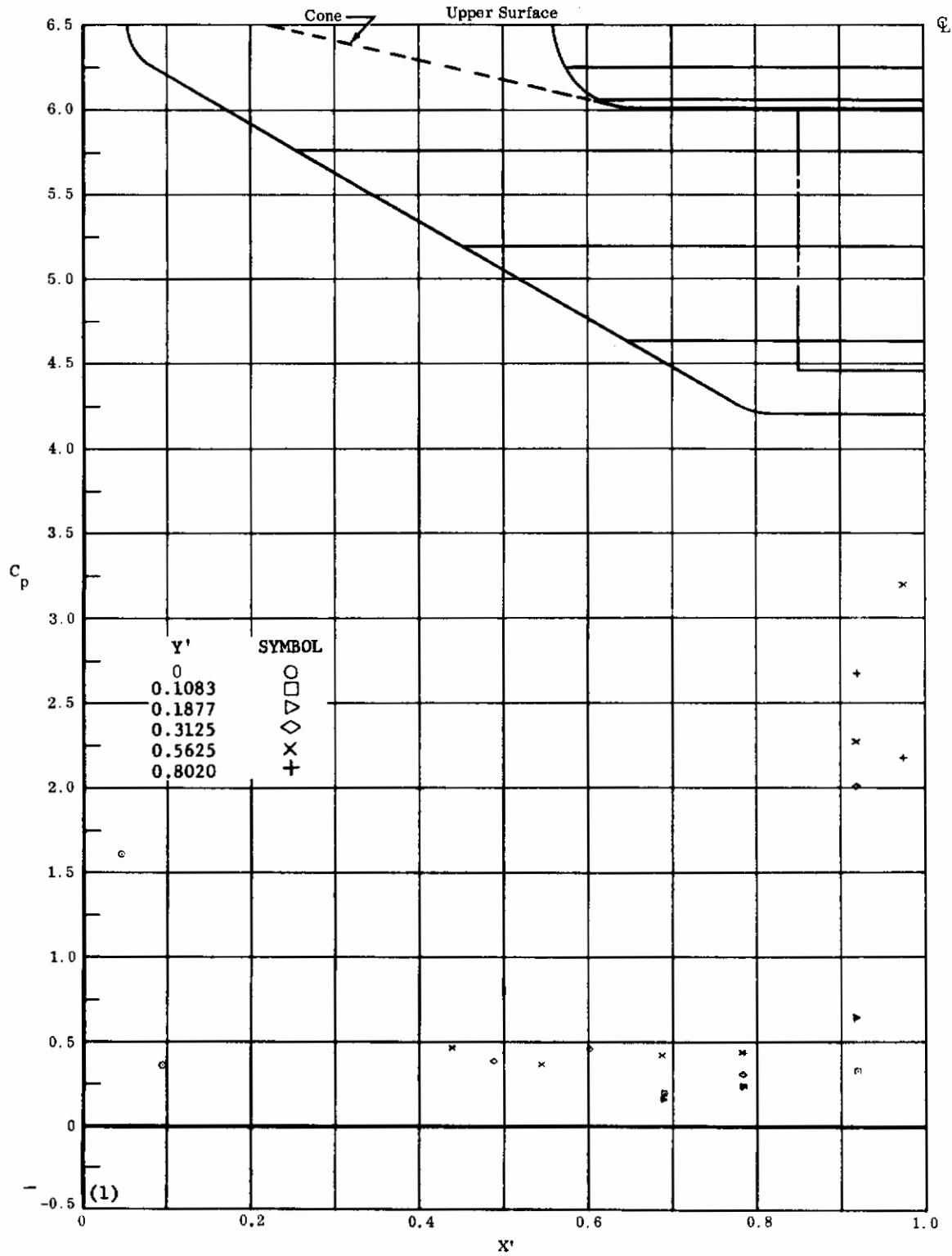

Fig. 20k Configuration I, $\alpha = -20$, $\delta_2 = \delta_3 = -30$

C_p vs. Y' , upper surface

Contraails



(NONDIMENSIONAL STREAMWISE DISTANCE FROM VIRTUAL APEX)

Fig. 201 Configuration I, $\alpha = -20$, $\delta_2 = \delta_3 = -30$

C_p vs. X' , upper surface

Contrails

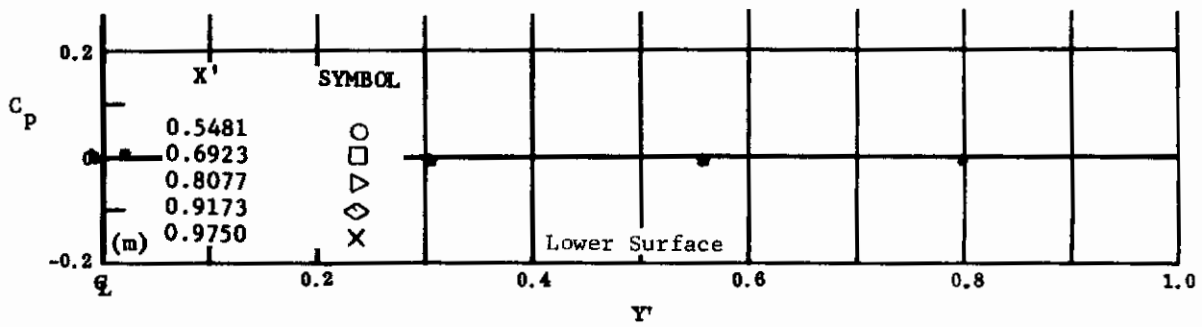

(NONDIMENSIONAL SEMISPAN DISTANCE)

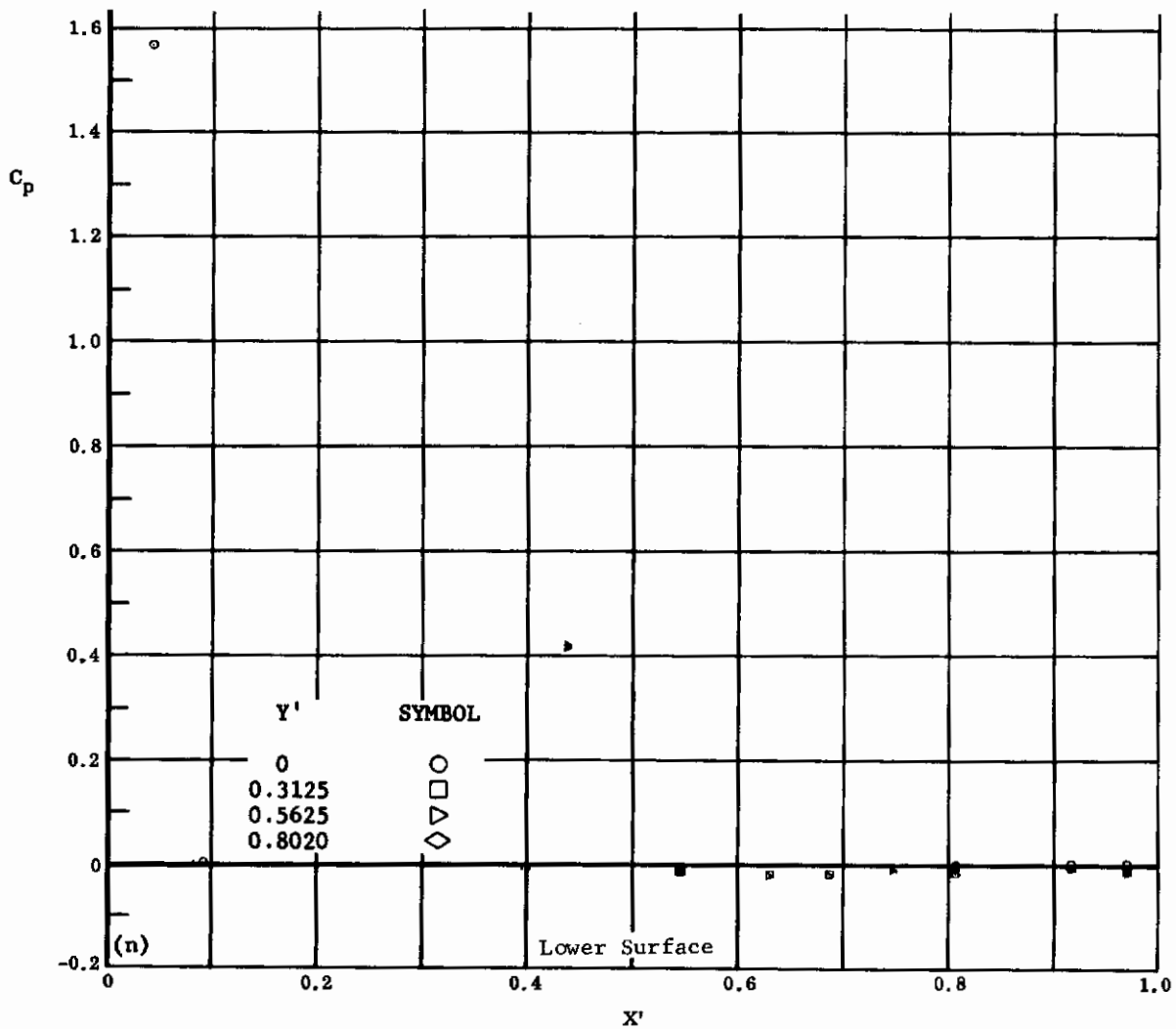

(NONDIMENSIONAL STREAMWISE DISTANCE FROM VIRTUAL APEX)

Fig. 20 Configuration I, $\alpha = -20$, $\delta_2 = \delta_3 = -39$

m) C_p vs. Y' , lower surface

n) C_p vs. X' , lower surface

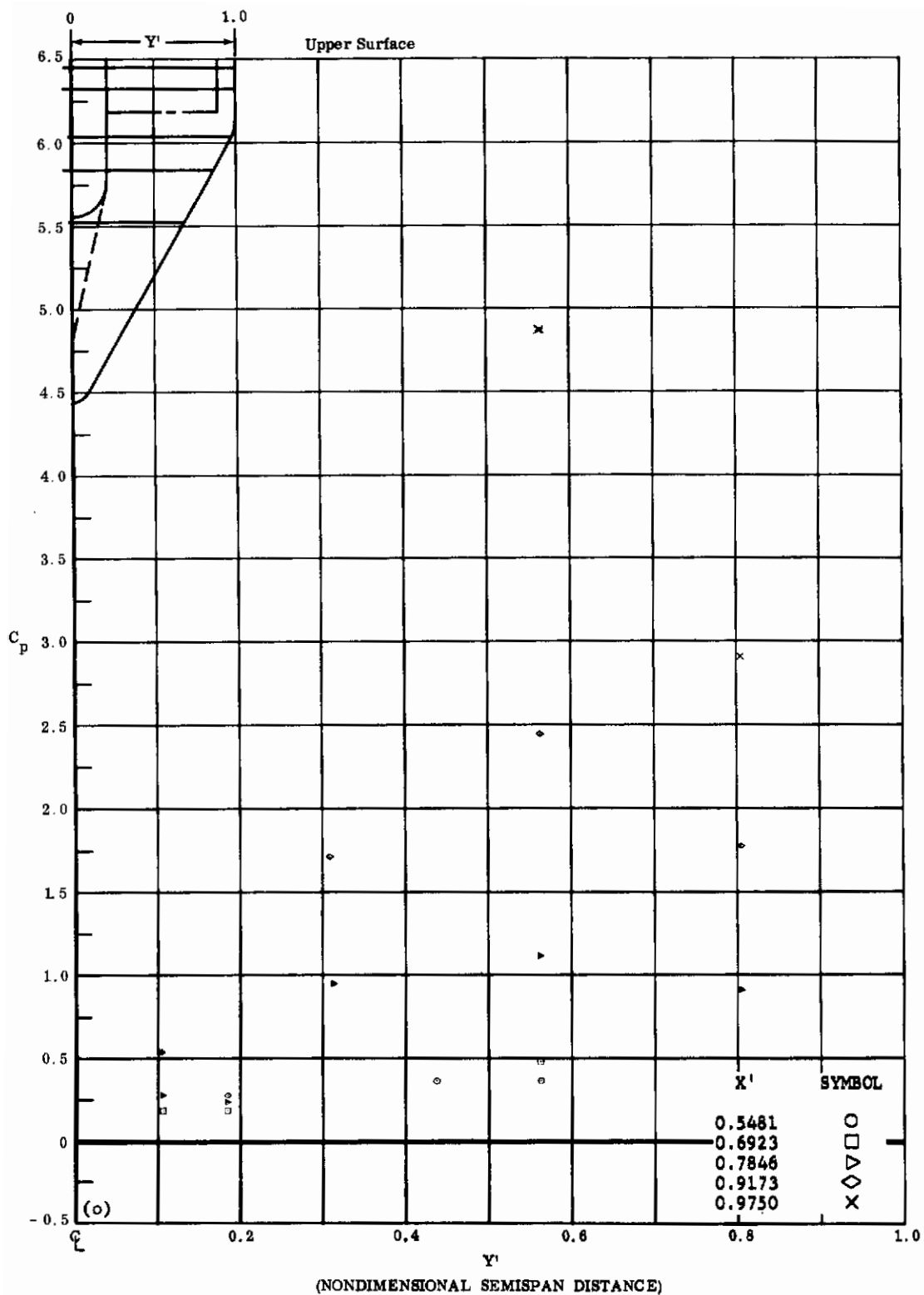
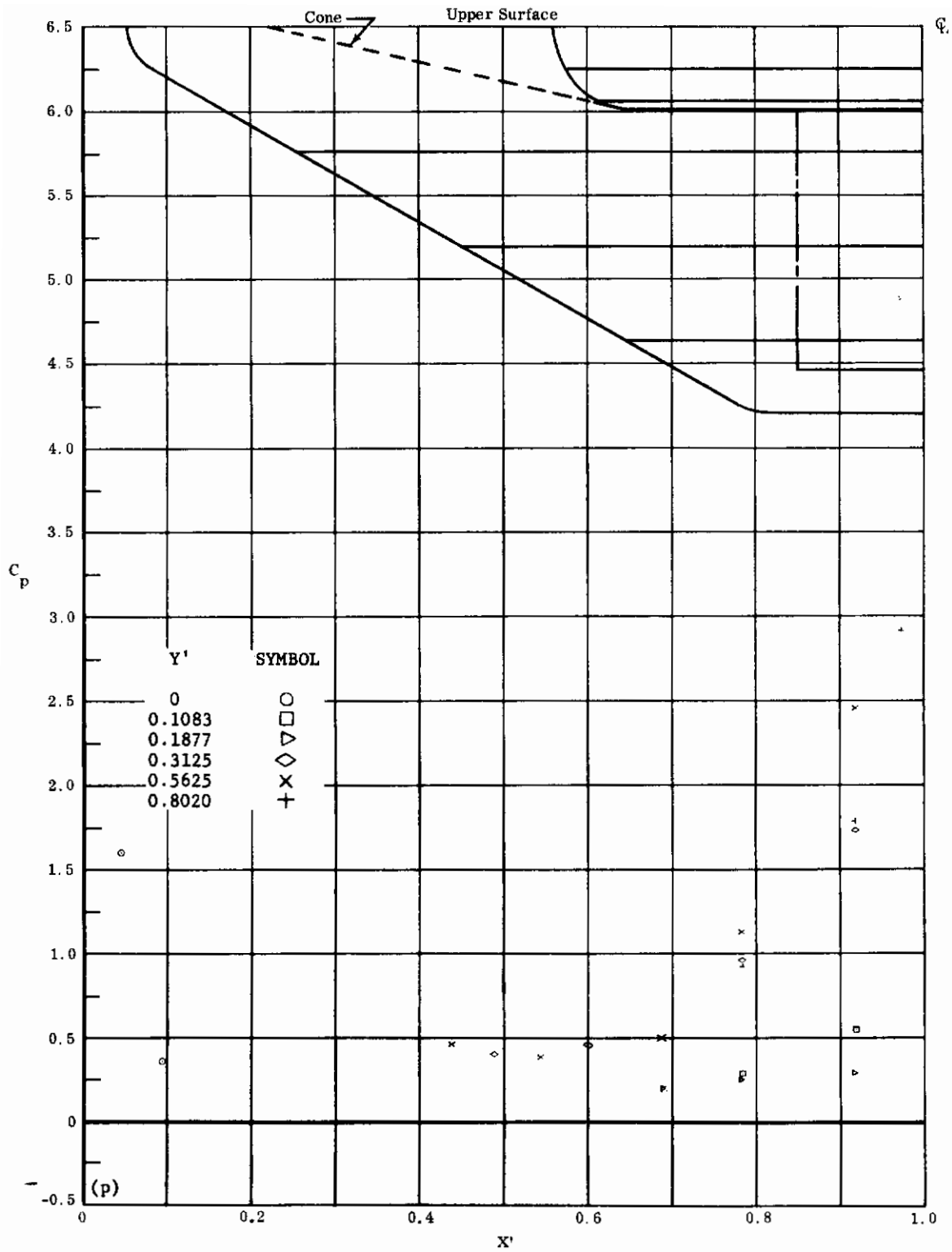

Fig. 20c Configuration I, $\alpha = -20$, $\delta_2 = \delta_3 = -39$
 C_p vs. Y' , upper surface

Contrails



(NONDIMENSIONAL STREAMWISE DISTANCE FROM VIRTUAL APEX)

Fig. 20p Configuration I, $\alpha = -20$, $\delta_2 = \delta_3 = -39$

C_p vs. X' , upper surface

Contrails

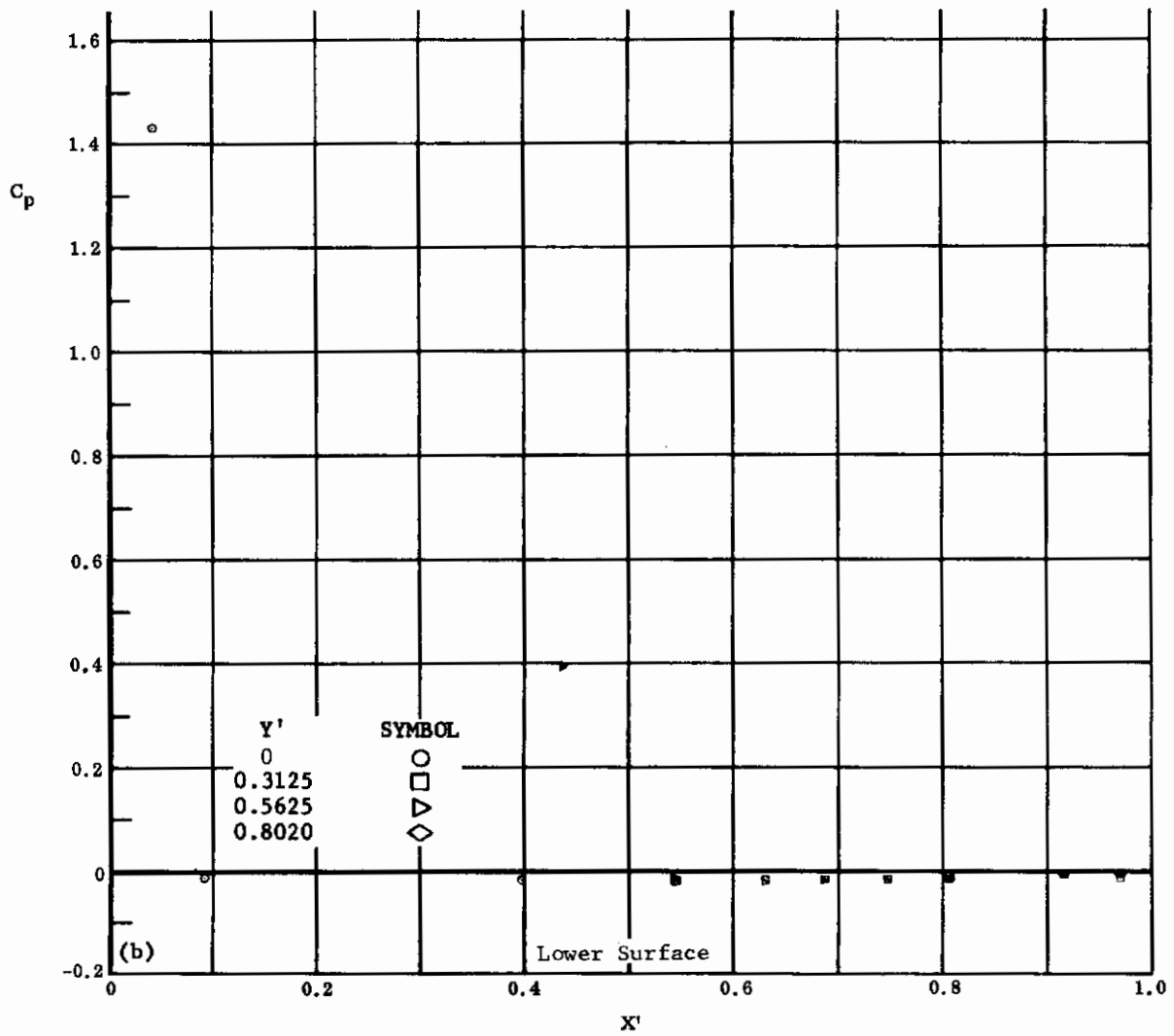
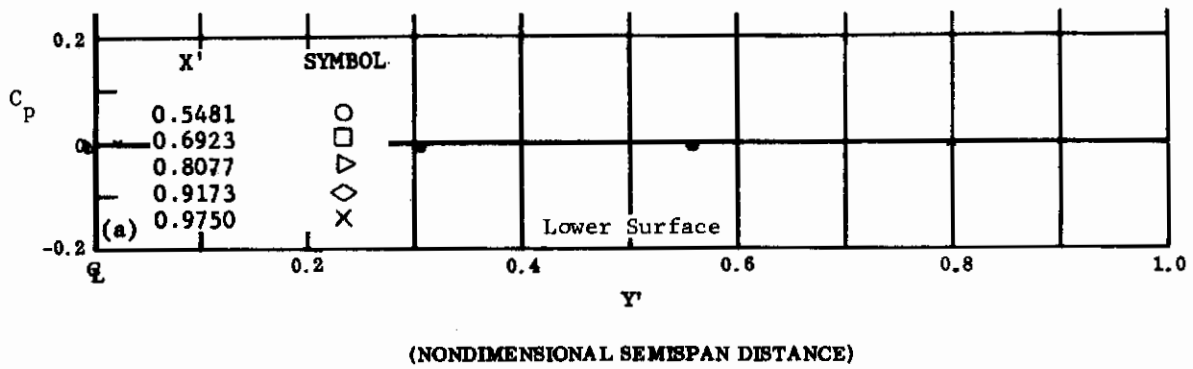
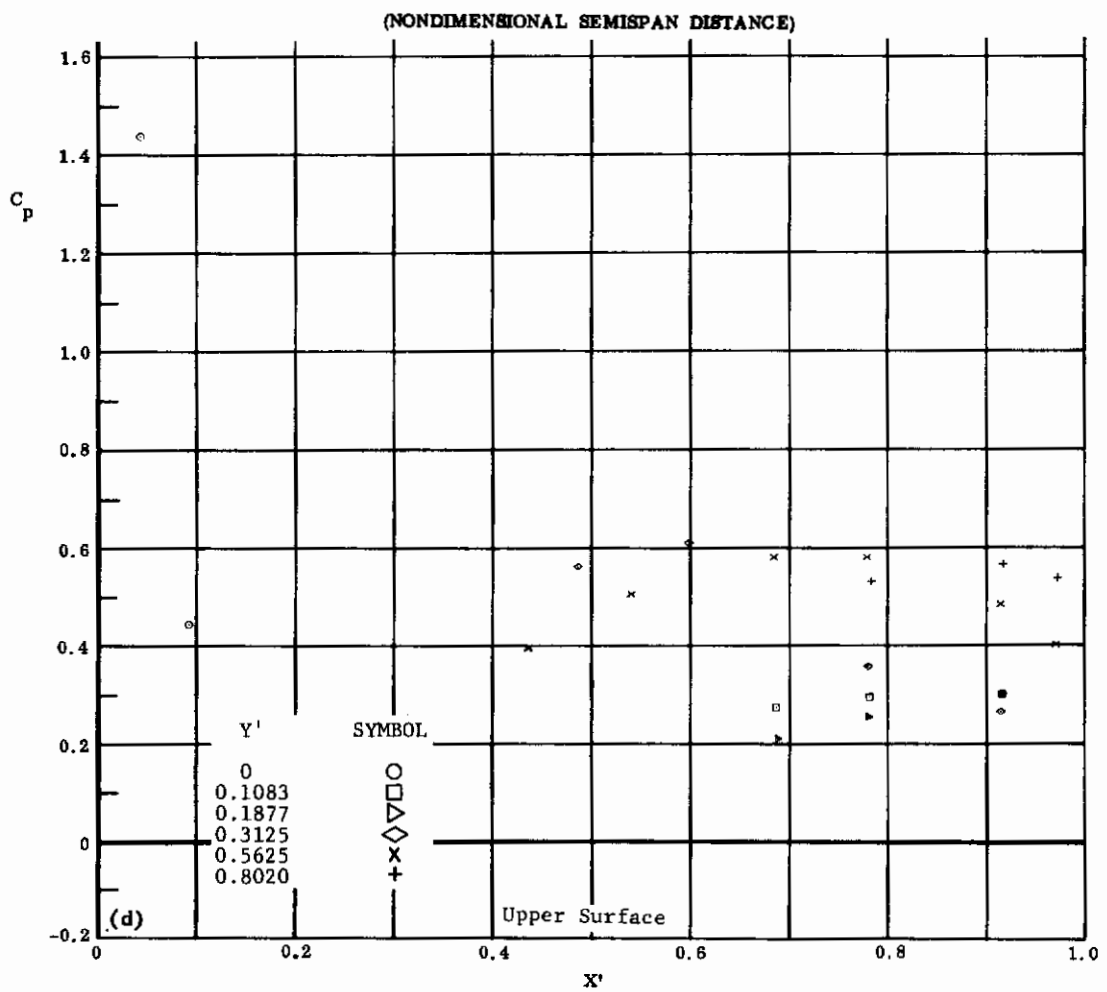
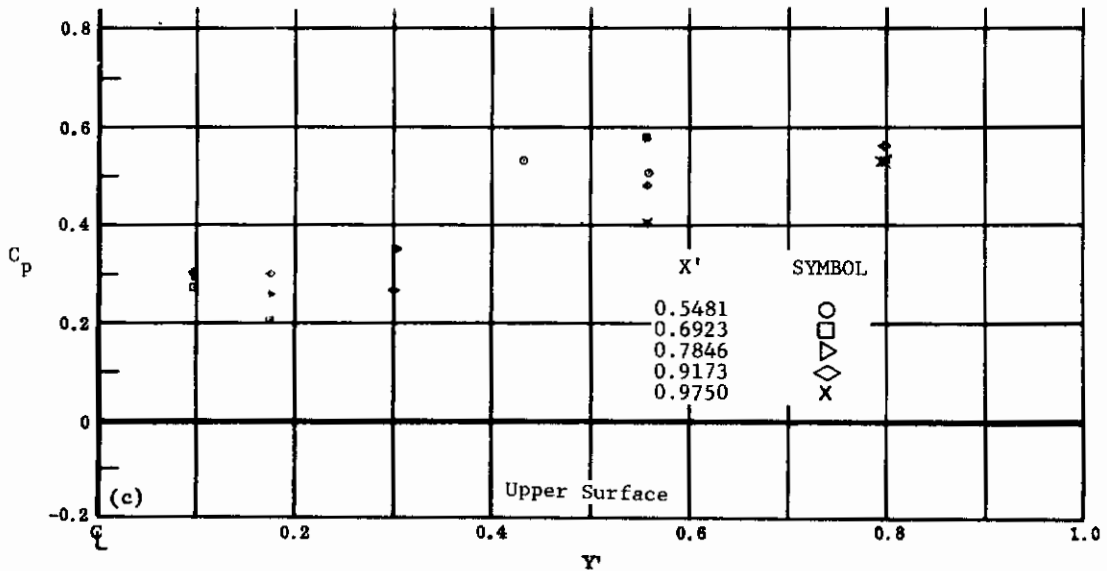

Fig. 21 Configuration I, $\alpha = -25$, $\delta_2 = \delta_3 = 0$

a) C_p vs. Y' , lower surface

b) C_p vs. X' , lower surface

Contrails



(NONDIMENSIONAL STREAMWISE DISTANCE FROM VIRTUAL APEX)

Fig. 21 Configuration I, $\alpha = -25$, $\delta_2 = \delta_3 = 0$

c) C_p vs. Y' , upper surface

d) C_p vs. X' , upper surface

Contrails

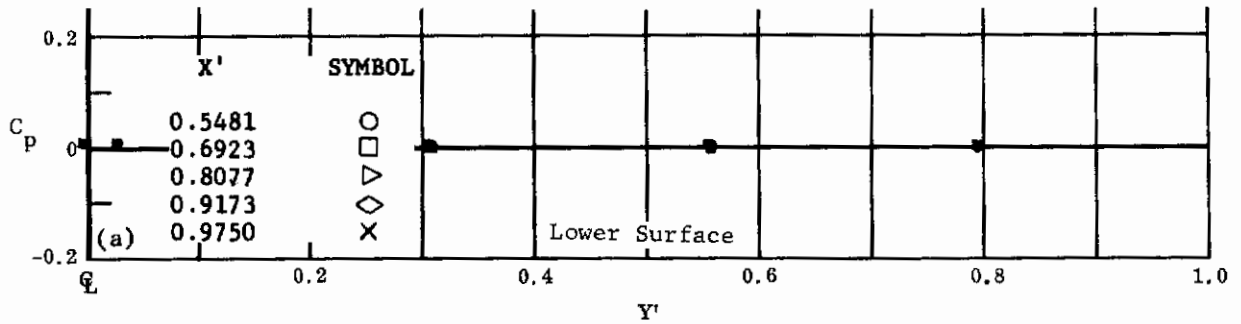

(NONDIMENSIONAL SEMISPAN DISTANCE)

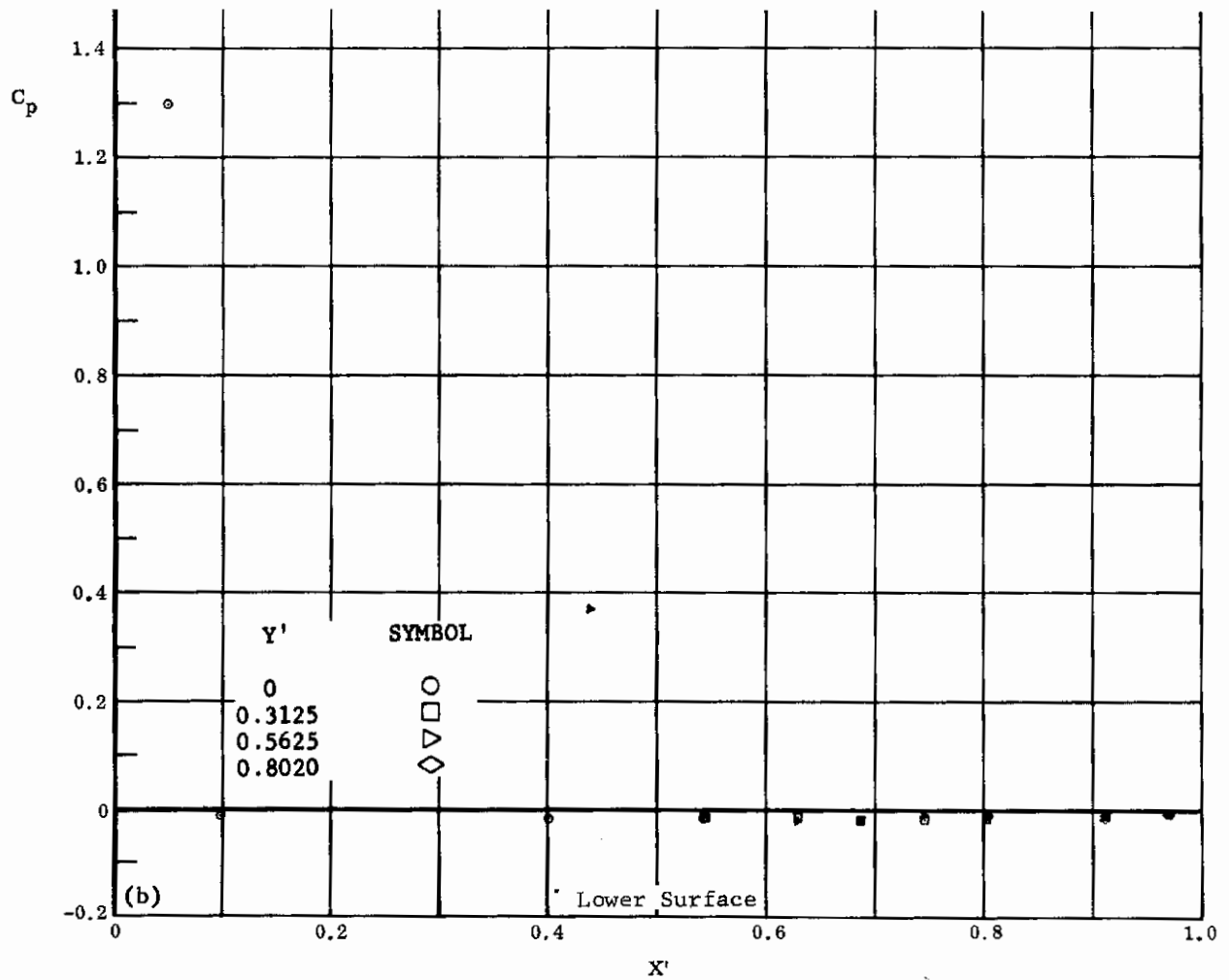

(NONDIMENSIONAL STREAMWISE DISTANCE FROM VIRTUAL APEX)

Fig. 22 Configuration I, $\alpha = -30$, $\delta_2 = \delta_3 = 0$

a) C_p vs. Y' , lower surface

b) C_p vs. X' , lower surface

Contrails

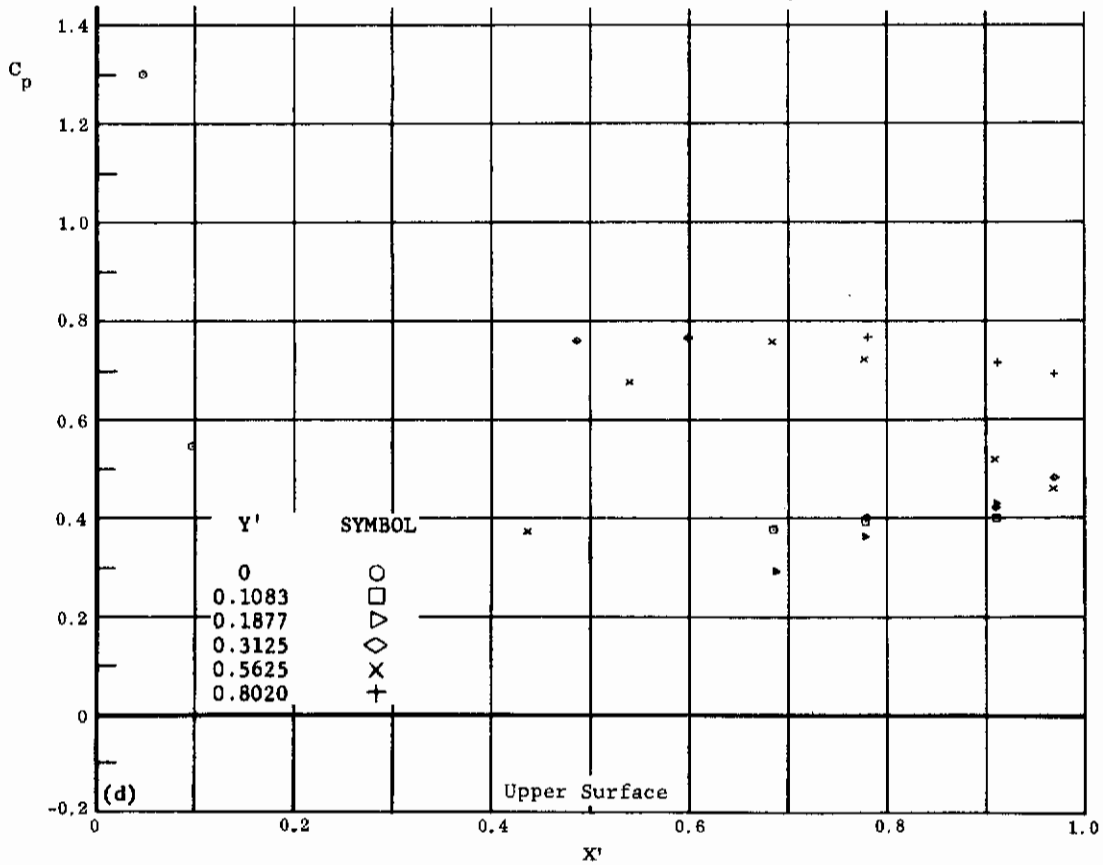
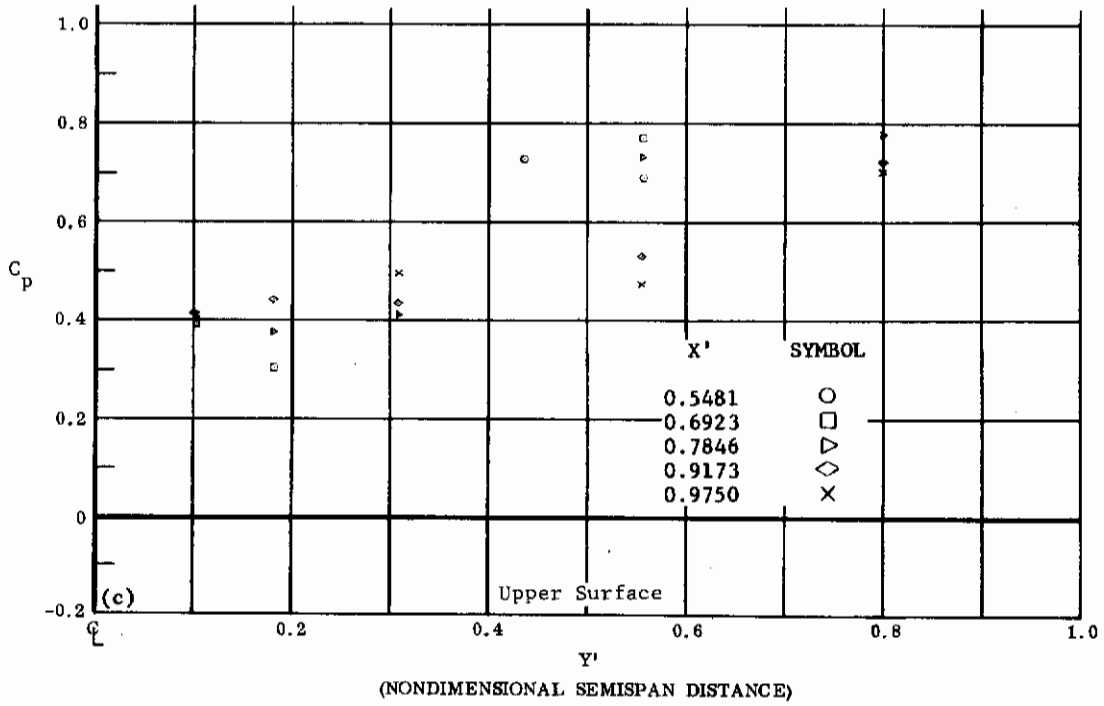

(NONDIMENSIONAL STREAMWISE DISTANCE FROM VIRTUAL APEX)

Fig. 22 Configuration I, $\alpha = -30$, $\delta_2 = \delta_3 = 0$

c) C_p vs. Y' , upper surface

d) C_p vs. X' , upper surface

Contrails

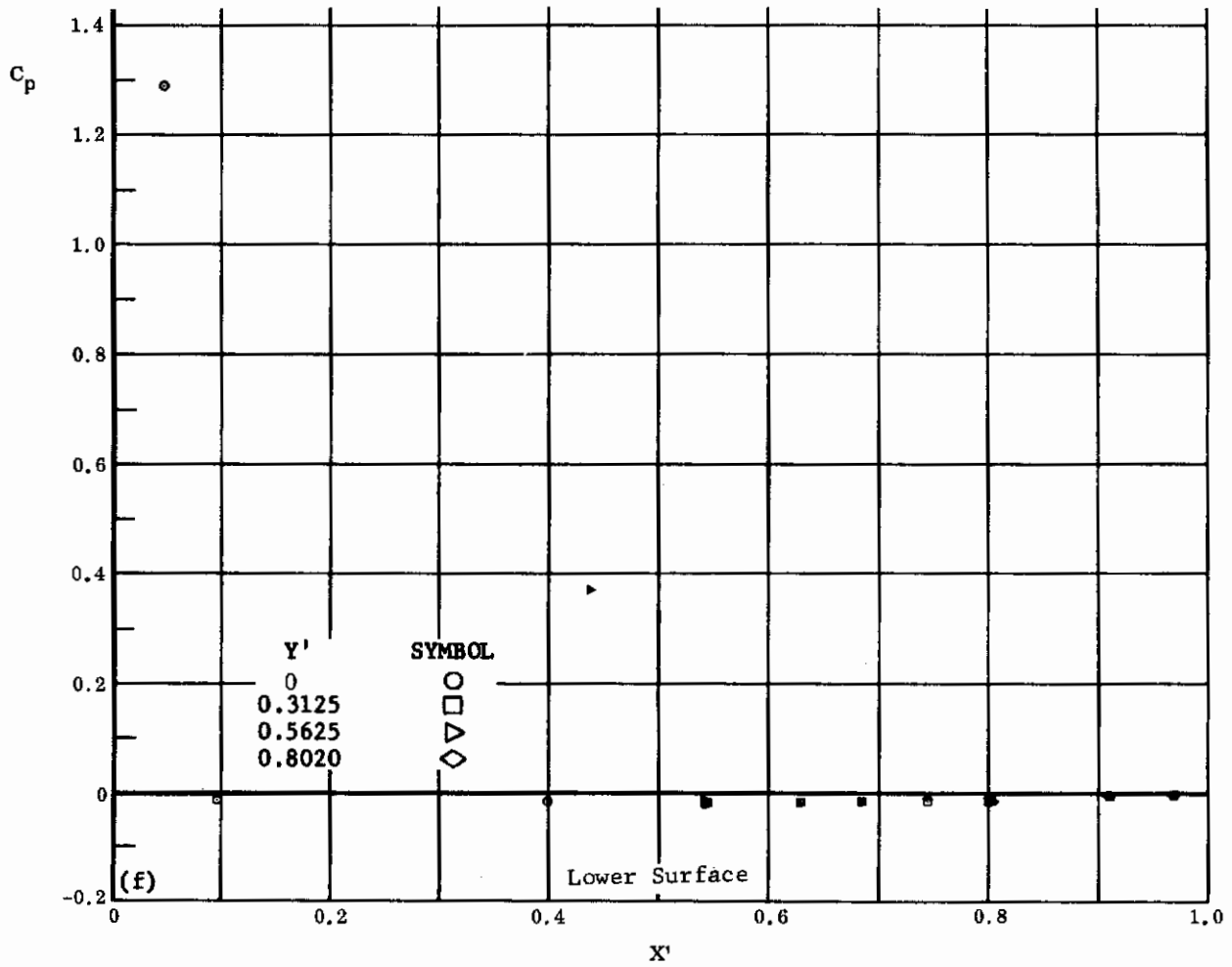
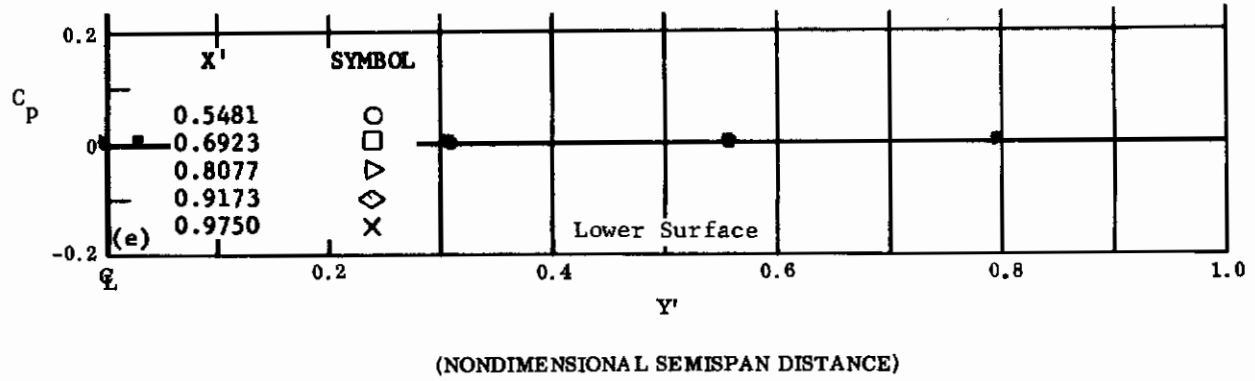

(NONDIMENSIONAL STREAMWISE DISTANCE FROM VIRTUAL APEX)

Fig. 22 Configuration I, $\alpha = -30$, $\delta_2 = \delta_3 = +20$

e) C_p vs. Y' , lower surface

f) C_p vs. X' , lower surface

Contrails

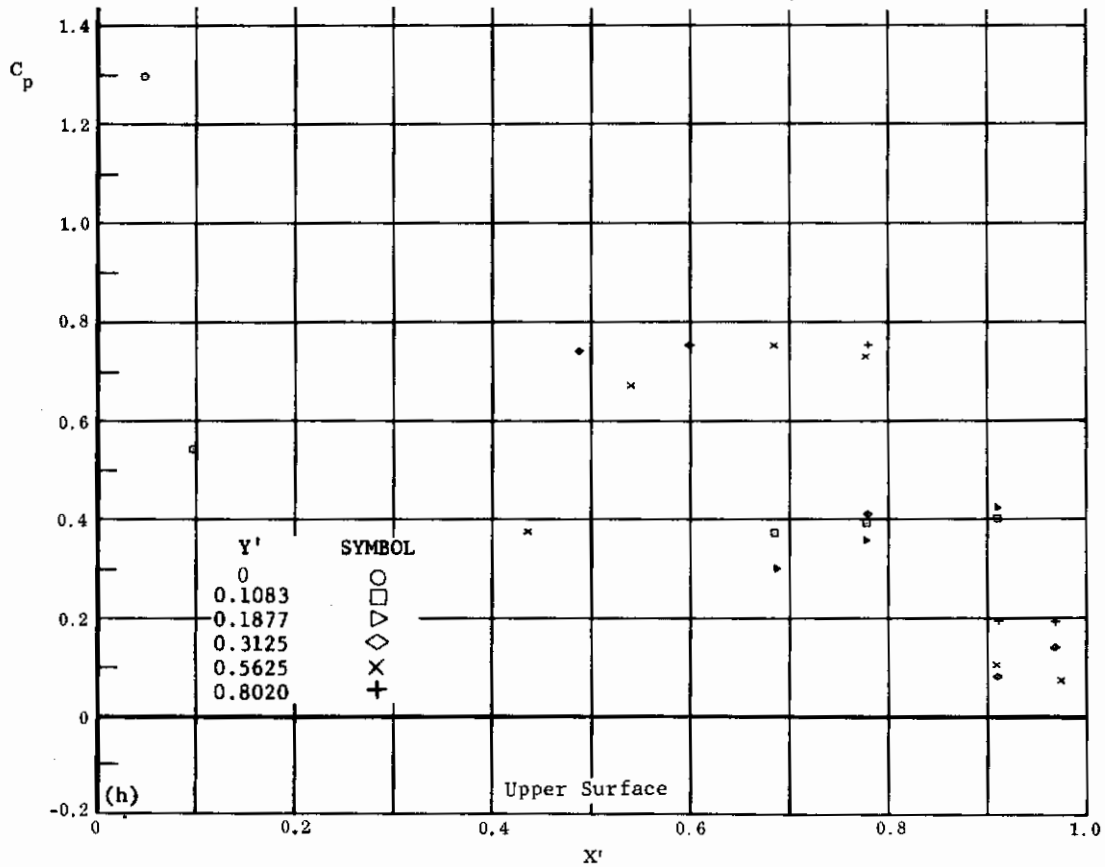
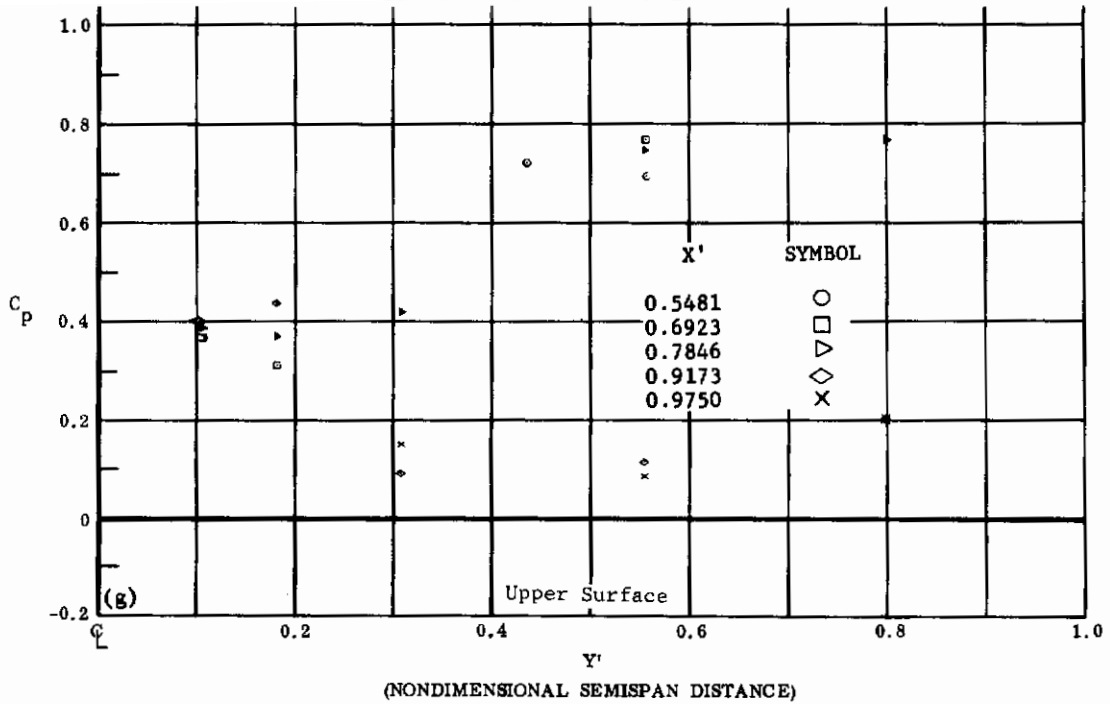

(NONDIMENSIONAL STREAMWISE DISTANCE FROM VIRTUAL APEX)

Fig. 22 Configuration I, $\alpha = -30$, $\delta_2 = \delta_3 = +20$

g) C_p vs. Y' , upper surface

h) C_p vs. X' , upper surface

Contrails

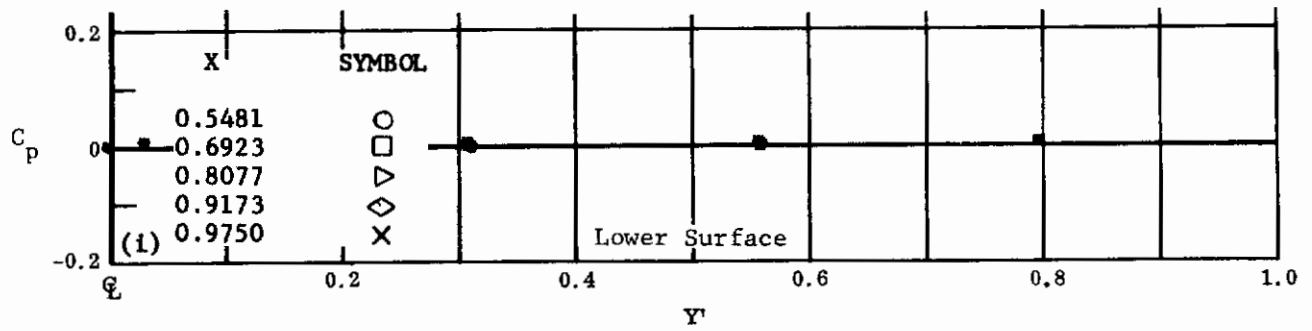

(NONDIMENSIONAL SEMISPAN DISTANCE)

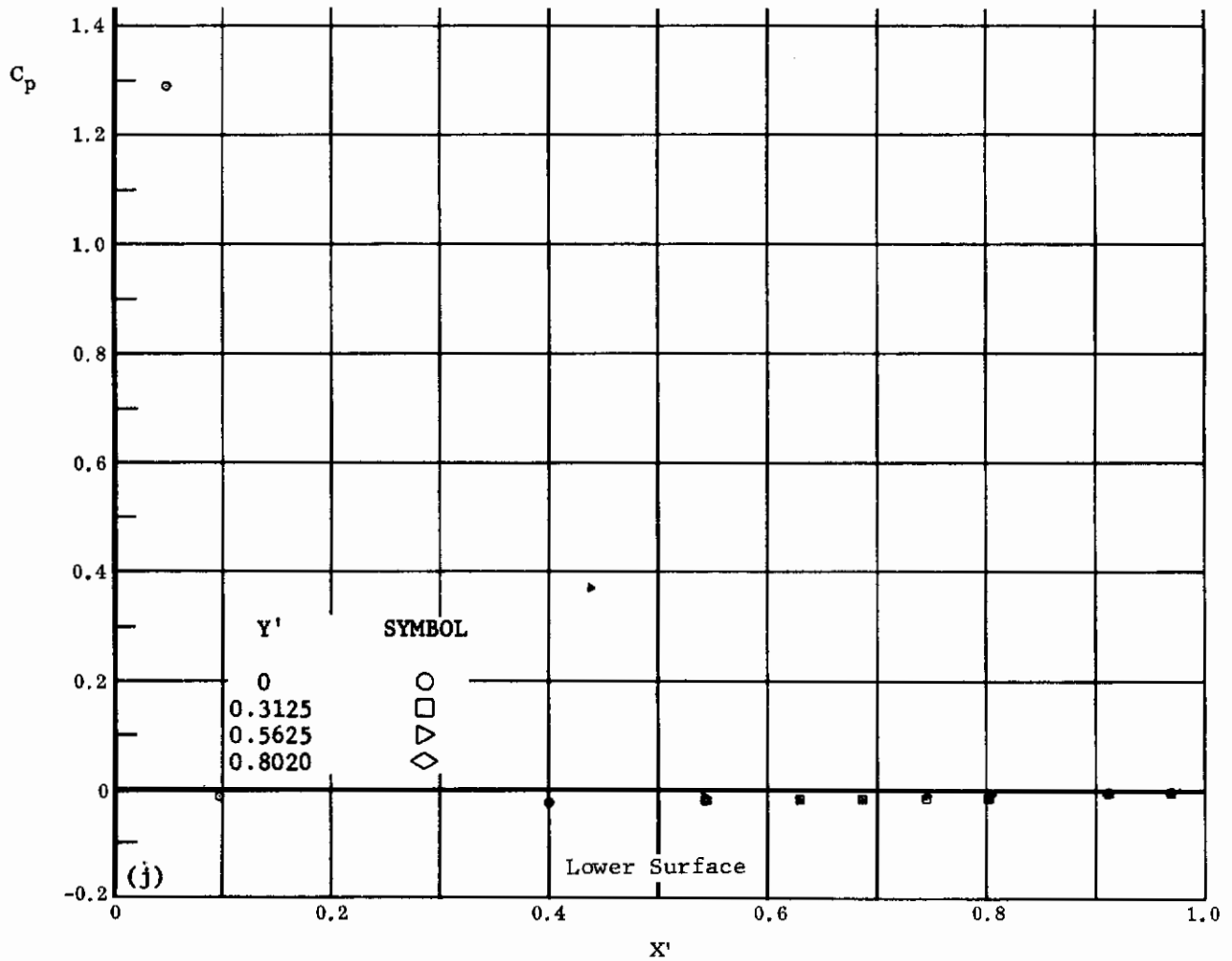

(NONDIMENSIONAL STREAMWISE DISTANCE FROM VIRTUAL APEX)

Fig. 22 Configuration I, $\alpha = -30$, $\delta_2 = \delta_3 = +30$

i) C_p vs. Y' , lower surface

j) C_p vs. X' , lower surface

Contrails

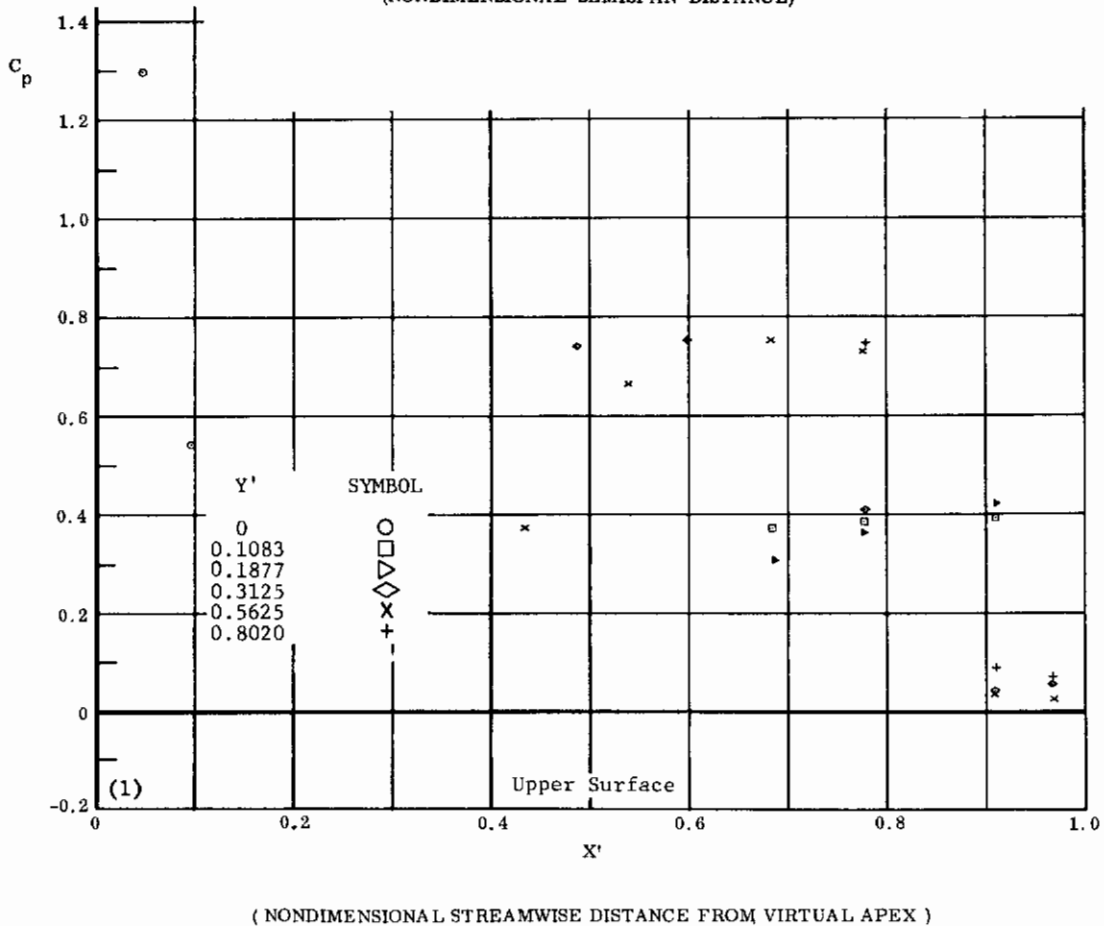
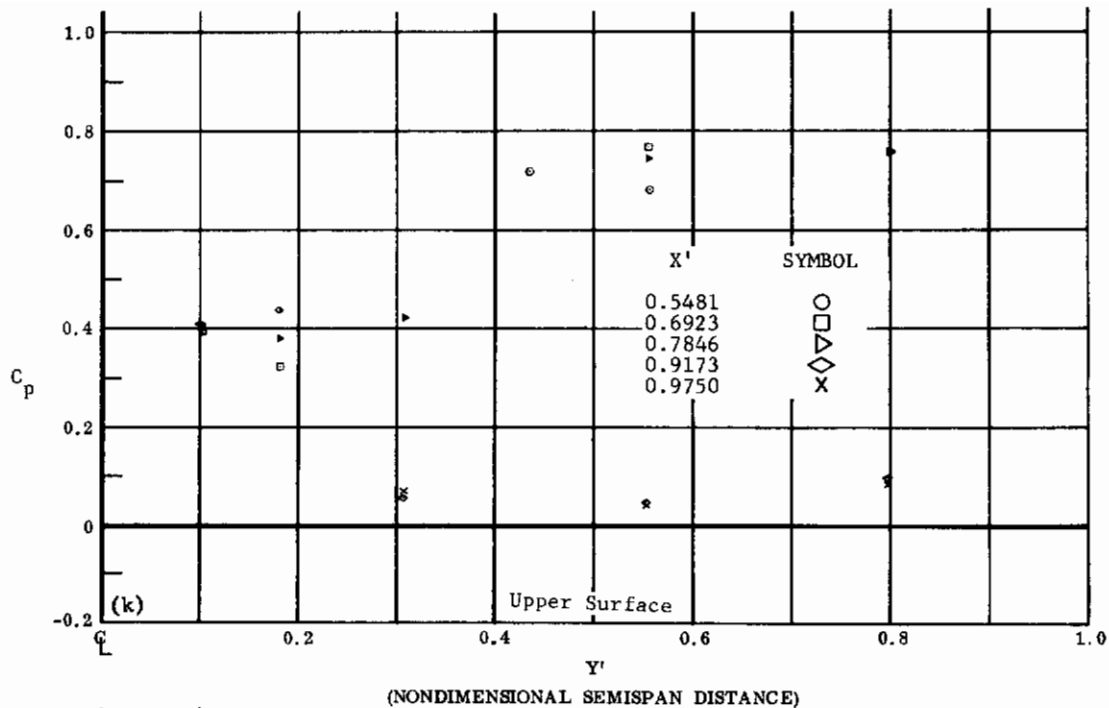

(NONDIMENSIONAL STREAMWISE DISTANCE FROM VIRTUAL APEX)

Fig. 22 Configuration I, $\alpha = -30$, $\delta_2 = \delta_3 = +30$

- k) C_p vs. Y' , upper surface
- 1) C_p vs. X' , upper surface

Contrails

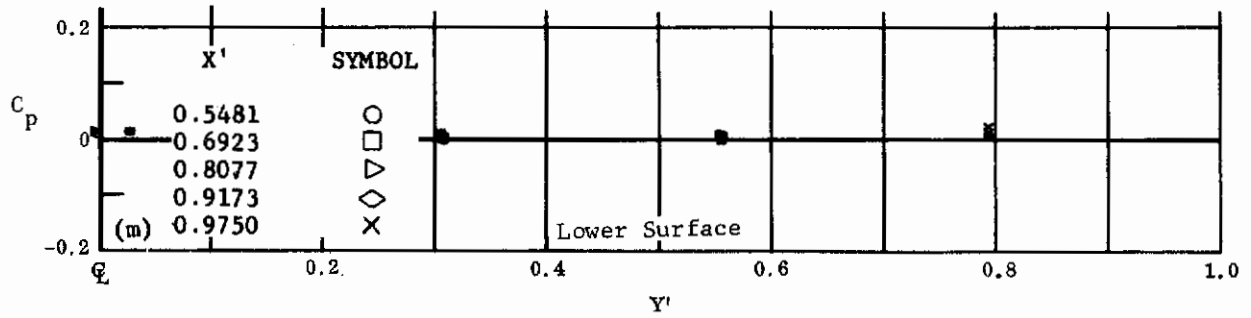

(NONDIMENSIONAL SEMISPAN DISTANCE)

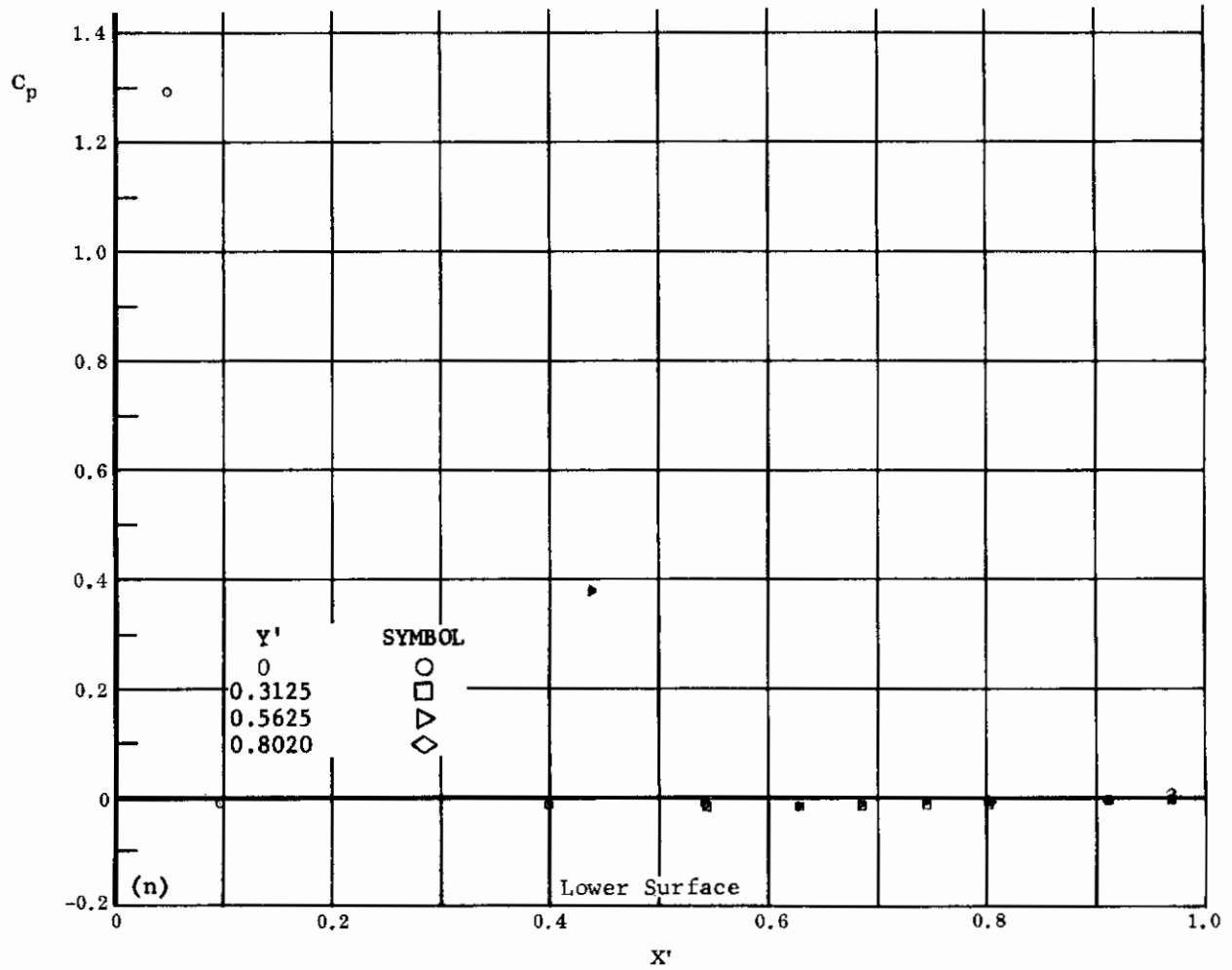

(NONDIMENSIONAL STREAMWISE DISTANCE FROM VIRTUAL APEX)

Fig. 22 Configuration I, $\alpha = -30$, $\delta_2 = \delta_3 = +39$

m) C_p vs. Y' , lower surface

n) C_p vs. X' , lower surface

Contrails

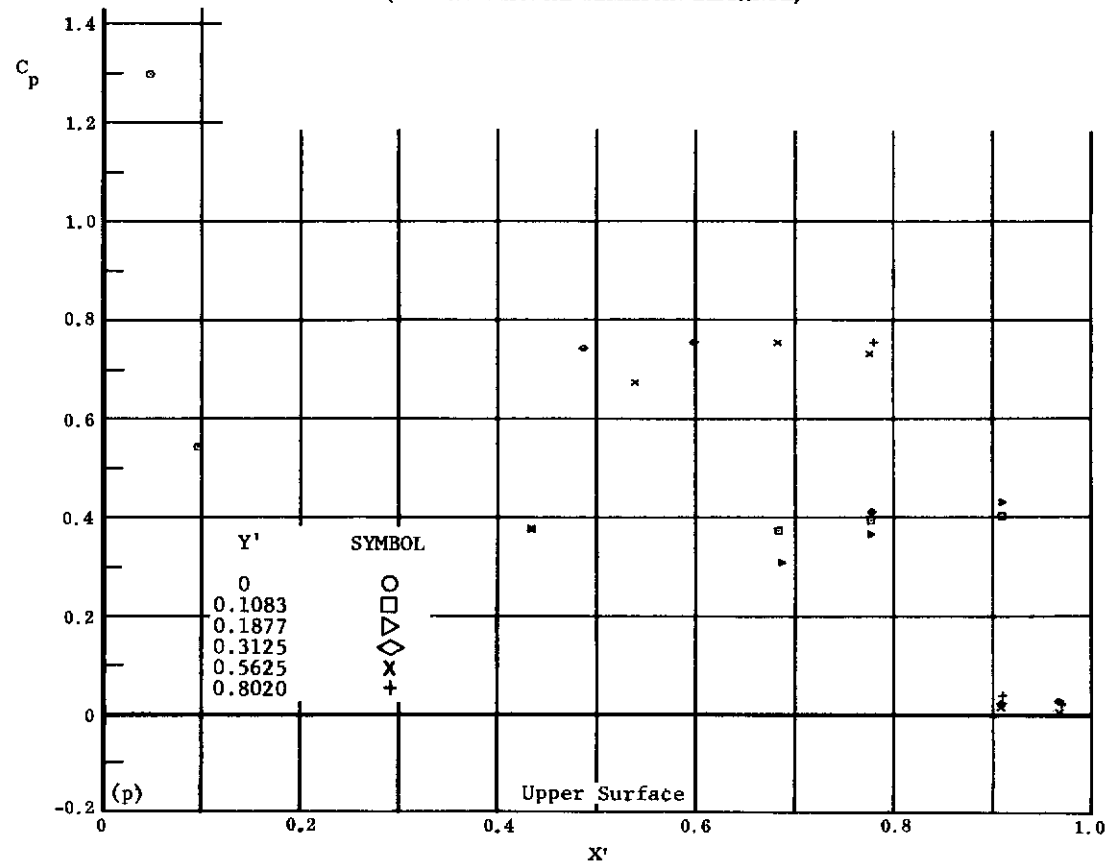
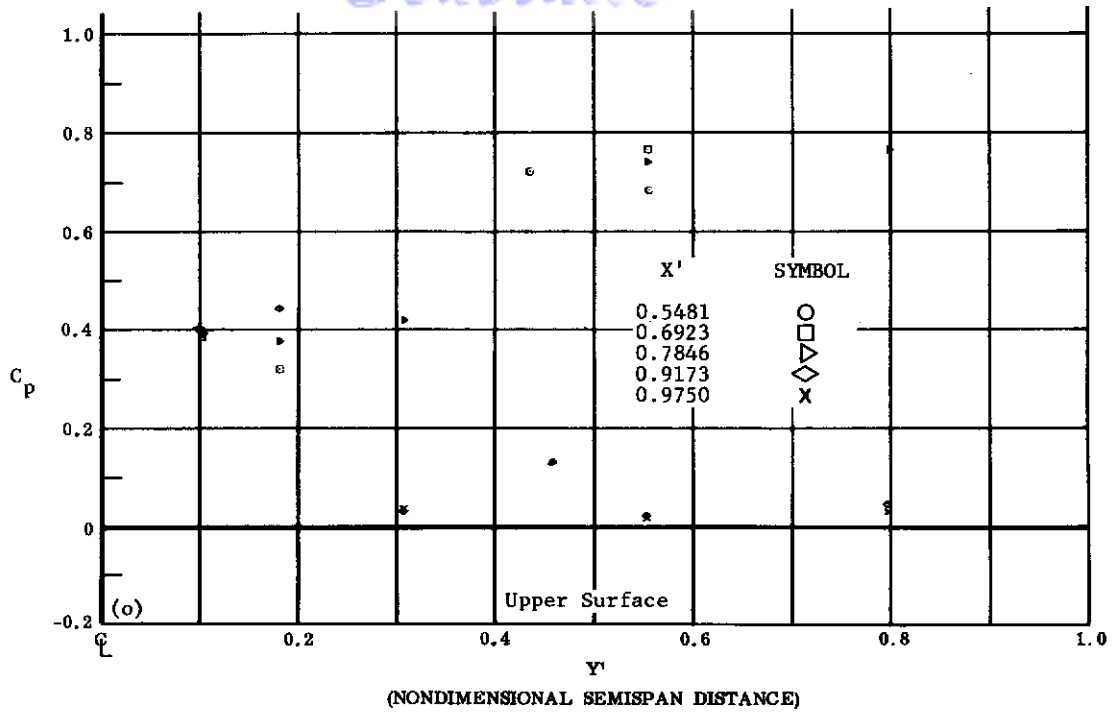

(NONDIMENSIONAL STREAMWISE DISTANCE FROM VIRTUAL APEX)

Fig. 22 Configuration I, $\alpha = -30$, $\delta_2 = \delta_3 = +39$

o) C_p vs. Y' , upper surface

p) C_p vs. X' , upper surface

Contrails

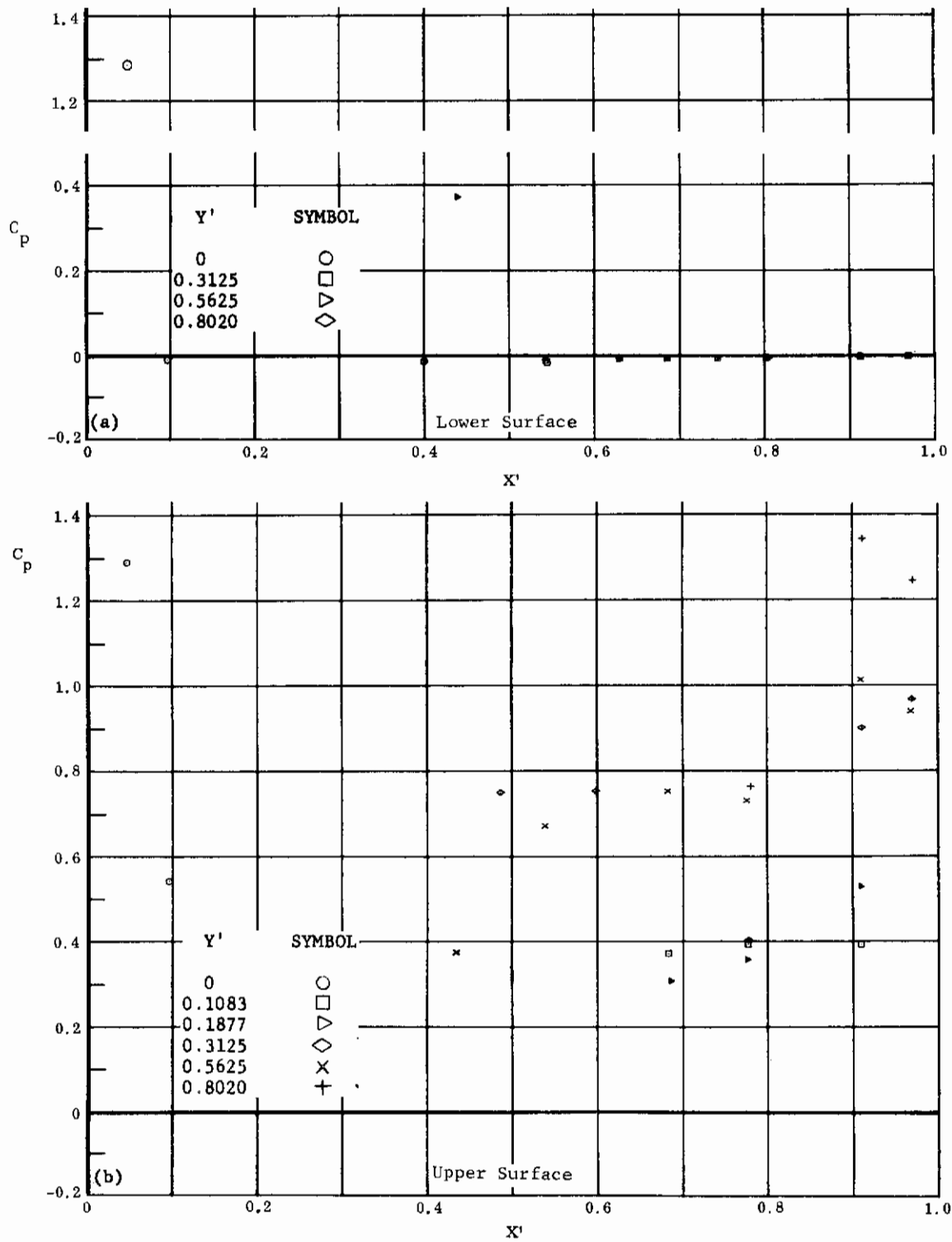

(NONDIMENSIONAL STREAMWISE DISTANCE FROM VIRTUAL APEX)

Fig. 23 Configuration I, $\alpha = -30$, $\delta_2 = \delta_3 = -10$

a) C_p vs. X' , lower surface

b) C_p vs. X' , upper surface

Contrails

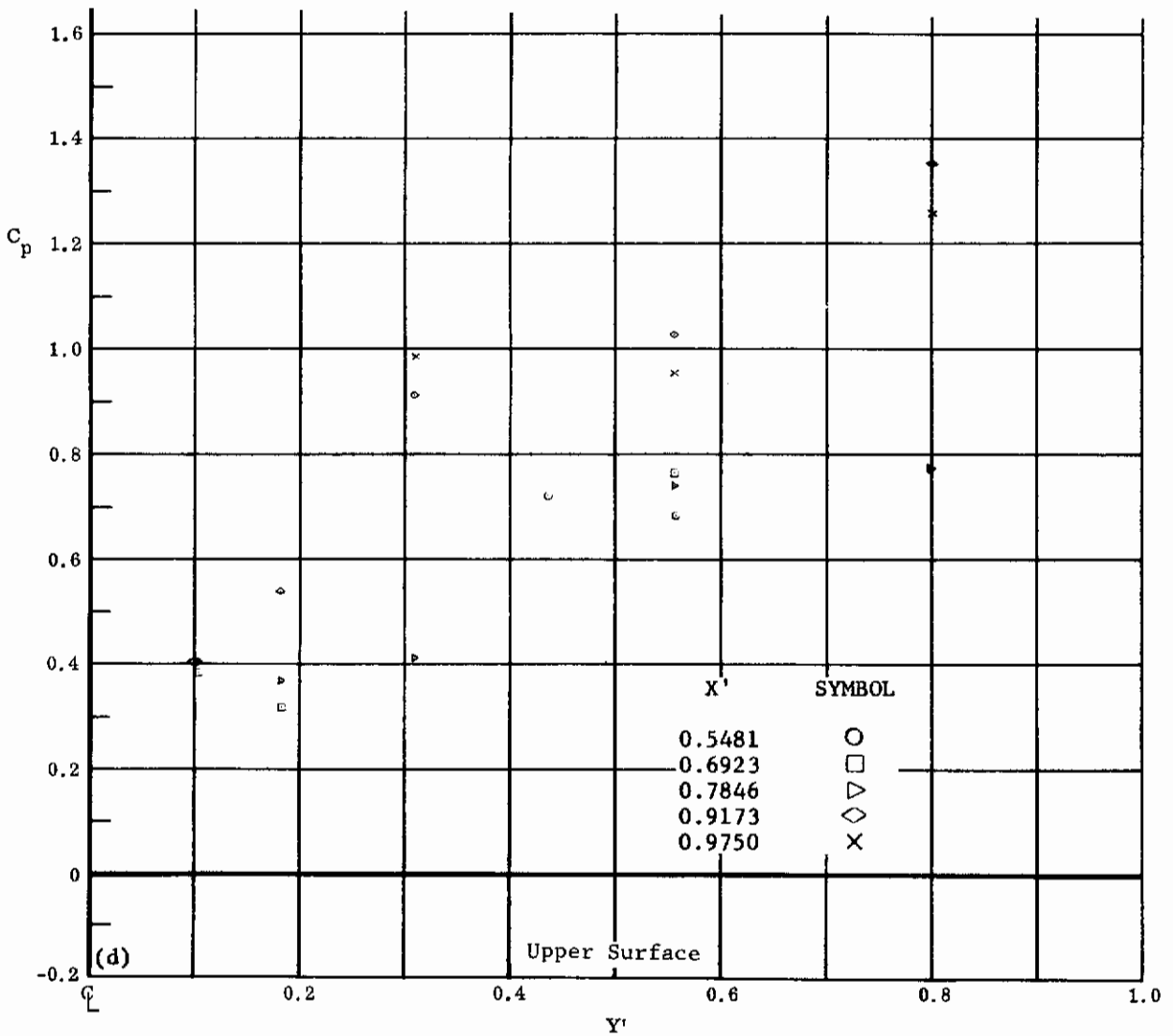
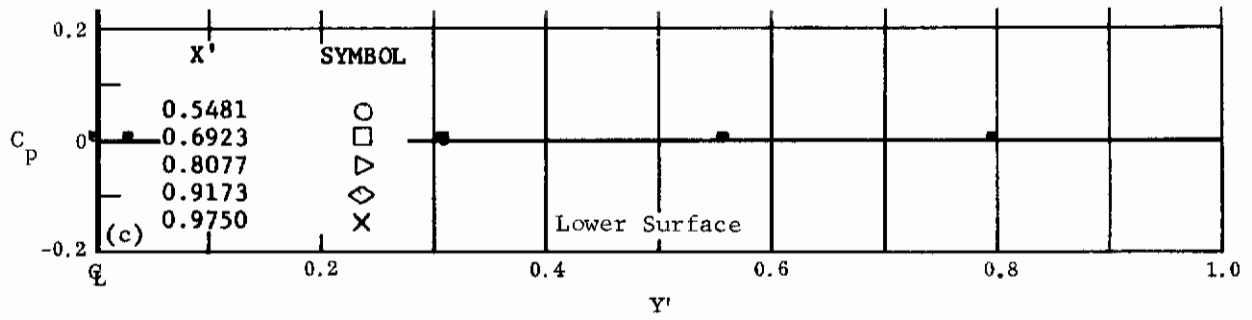

(NONDIMENSIONAL SEMISPAN DISTANCE)

Fig. 23 Configuration I, $\alpha = -30$, $\delta_2 = \delta_3 = -10$

c) C_p vs. Y', lower surface

d) C_p vs. Y', upper surface

Contrails

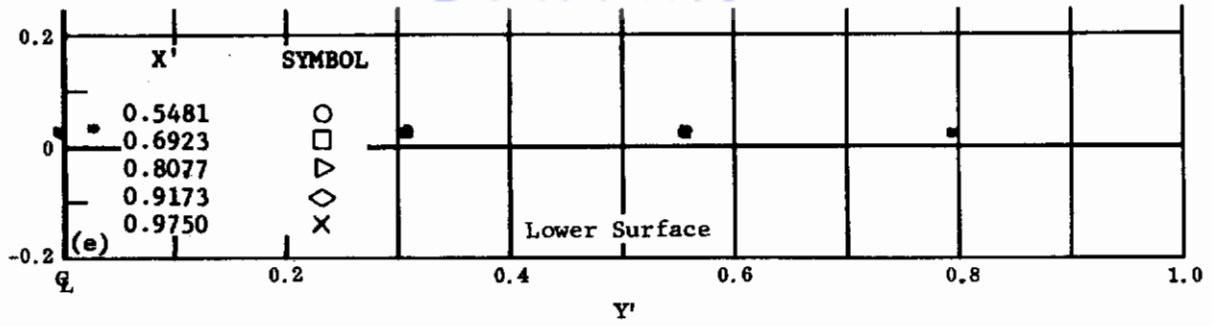

(NONDIMENSIONAL SEMISPAN DISTANCE)

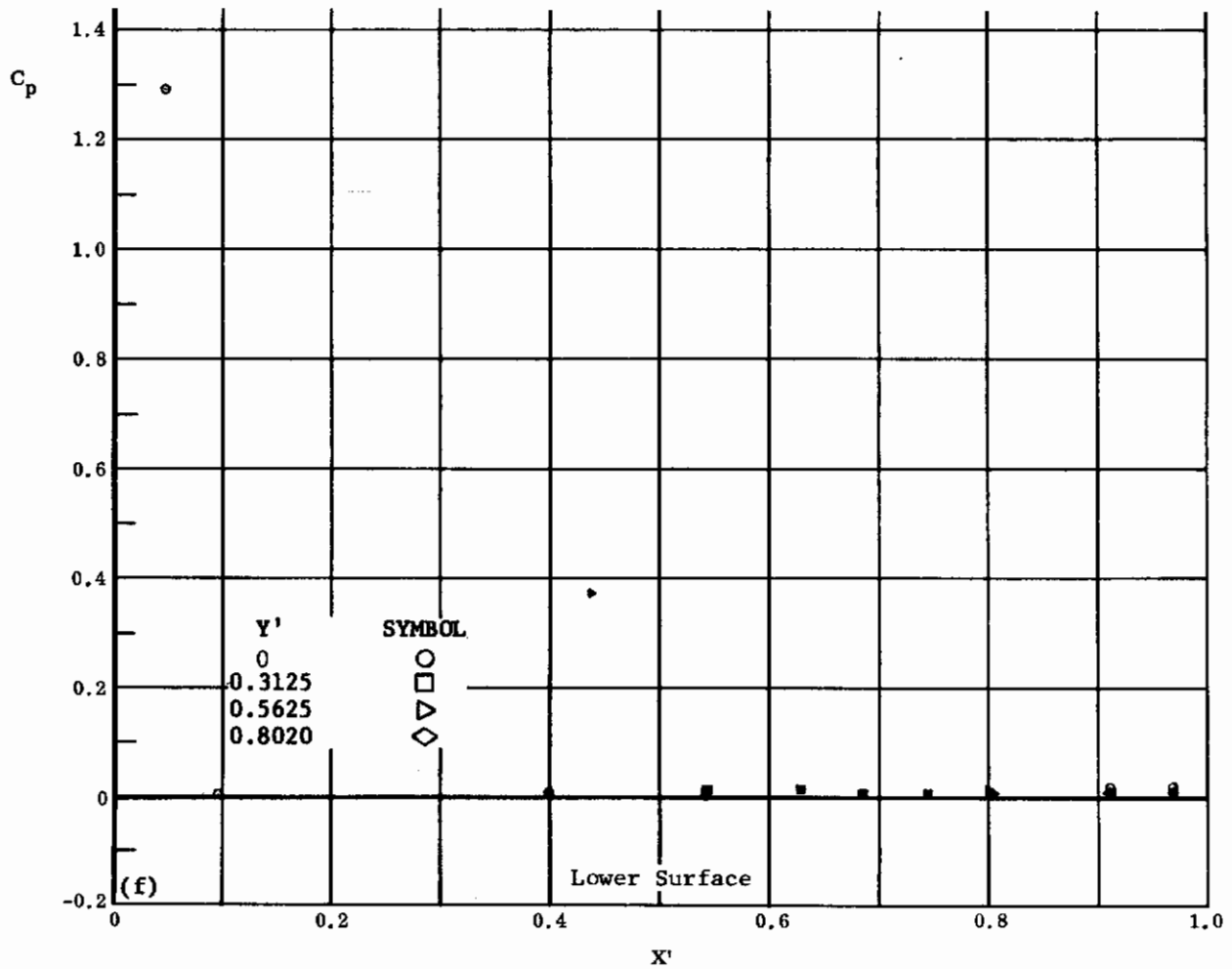

(NONDIMENSIONAL STREAMWISE DISTANCE FROM VIRTUAL APEX)

Fig. 23 Configuration I, $\alpha = -30$, $\delta_2 = \delta_3 = -20$

e) C_p vs. Y' , lower surface

f) C_p vs. X' , lower surface

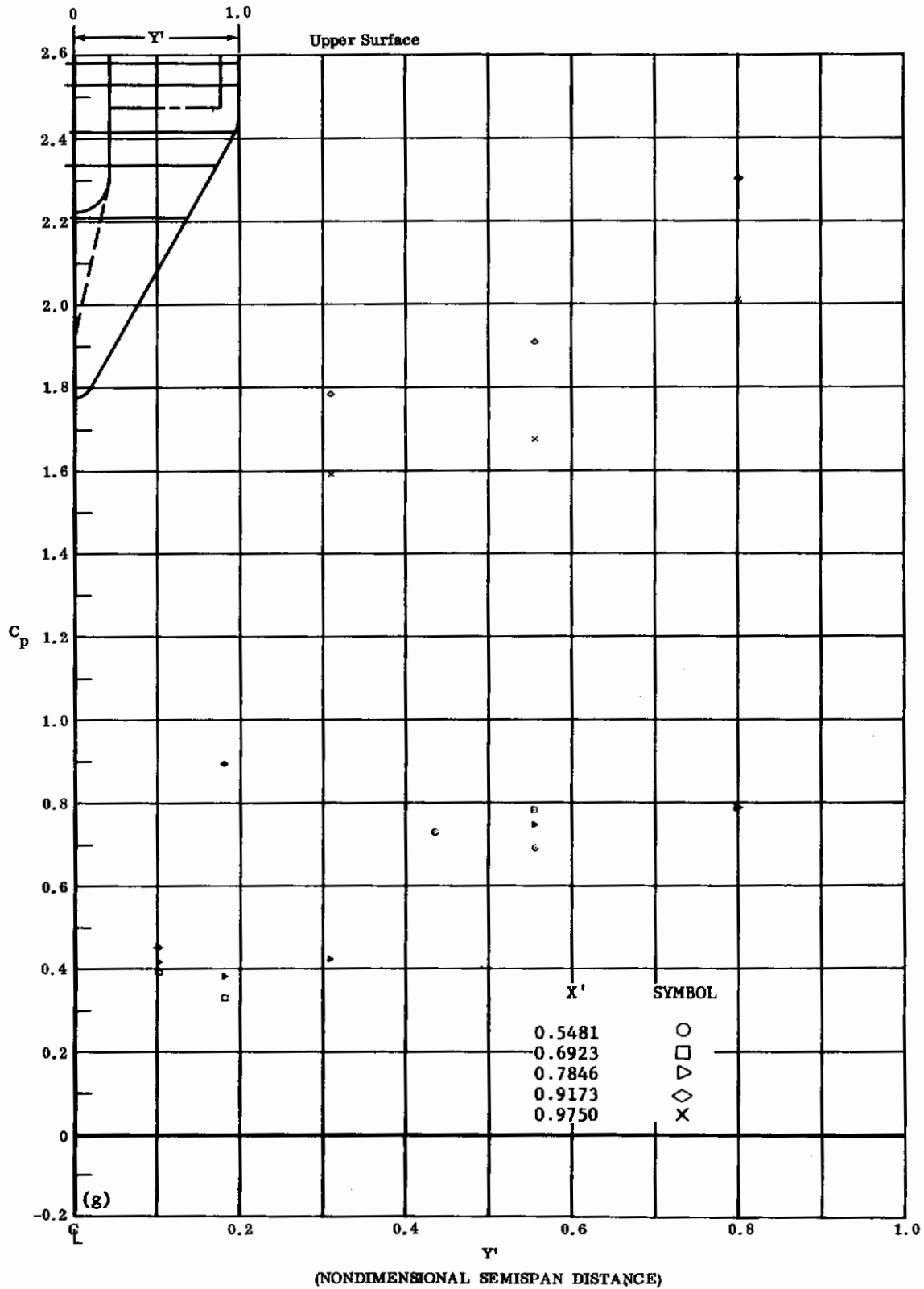
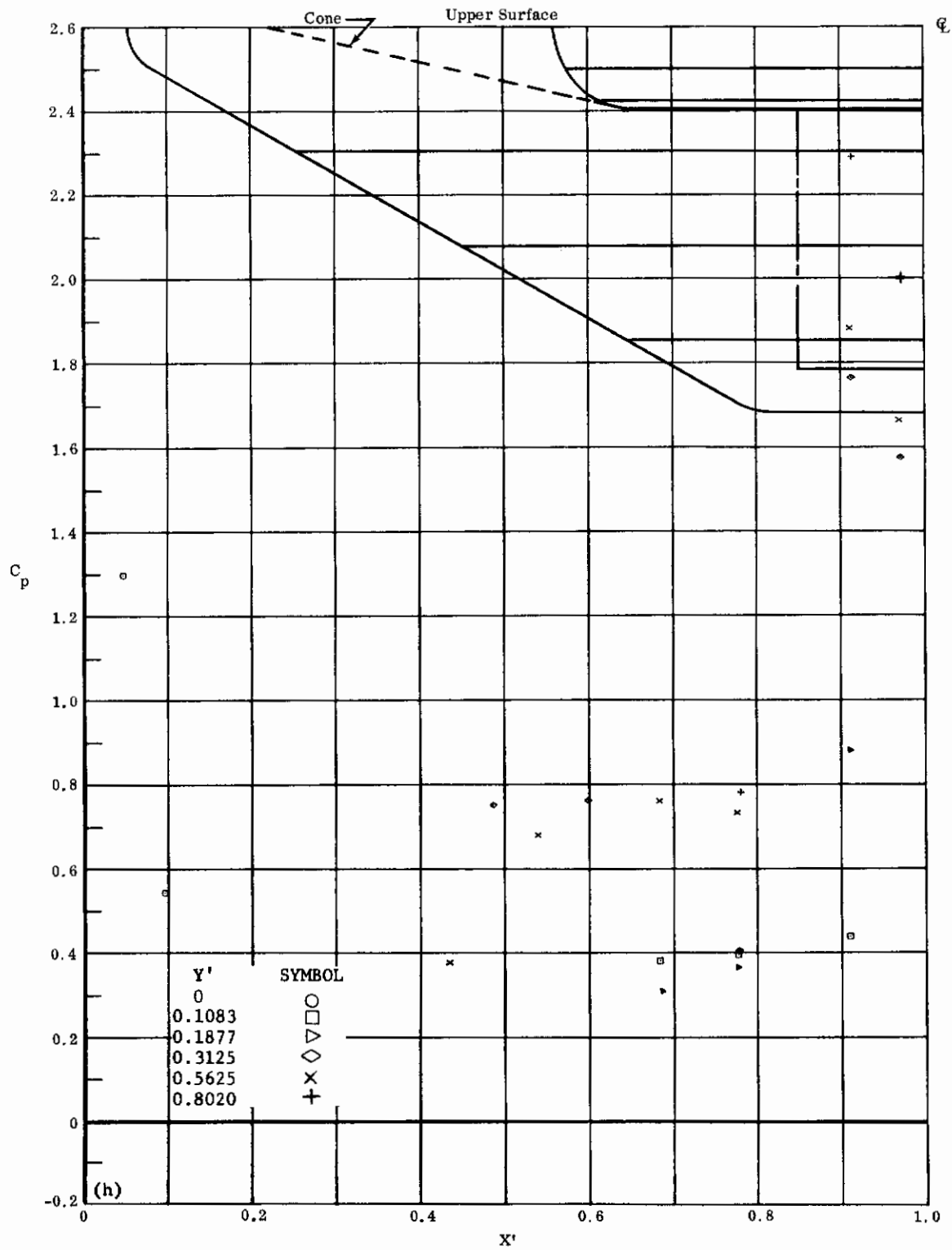

Fig. 23g Configuration I, $\alpha = -30$, $\delta_2 = \delta_3 = -20$

C_p vs. Y' , upper surface

Contraails



(NONDIMENSIONAL STREAMWISE DISTANCE FROM VIRTUAL APEX)

Fig. 23h Configuration I, $\alpha = -30$, $\delta_2 = \delta_3 = -20$

C_p vs. X' , upper surface

Contrails

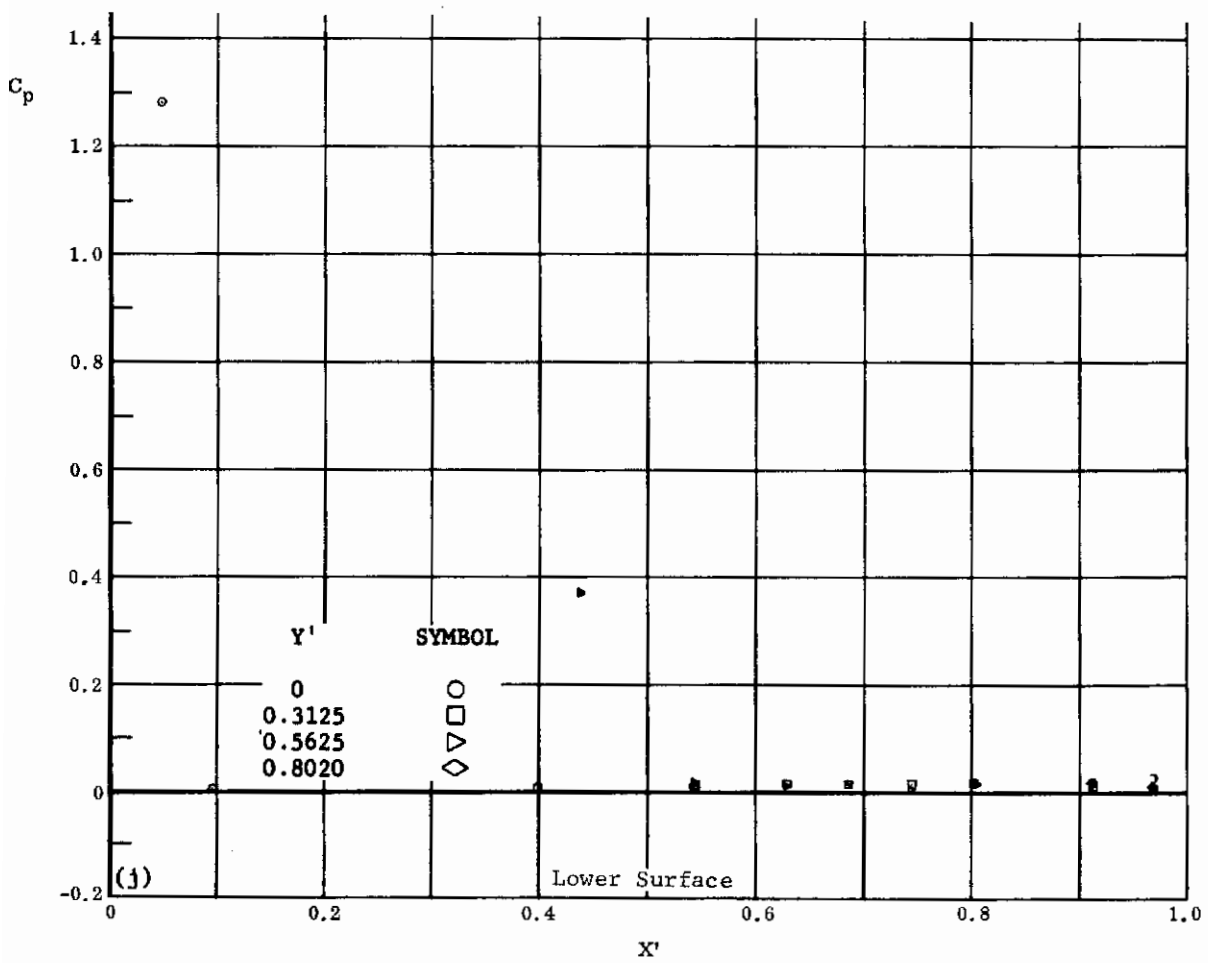
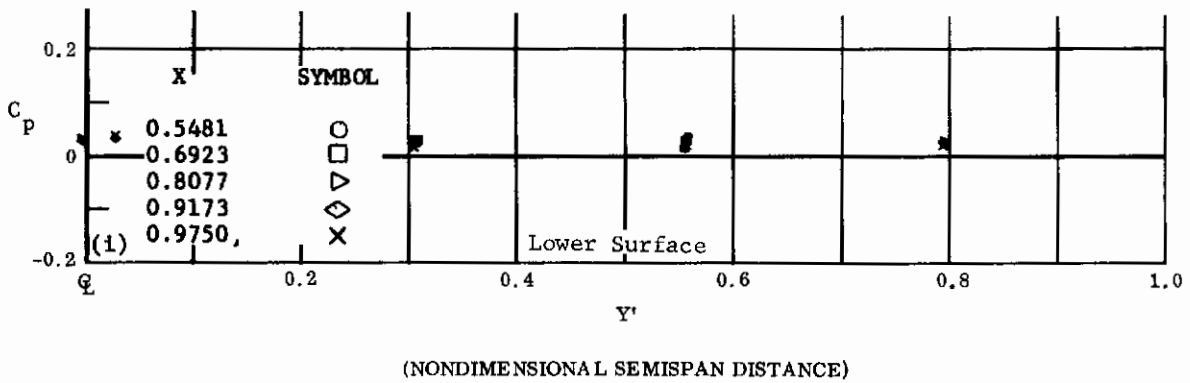

Fig. 23 Configuration I, $\alpha = -30$, $\delta_2 = \delta_3 = -30$

- i) C_p vs. Y' , lower surface
- j) C_p vs. X' , lower surface

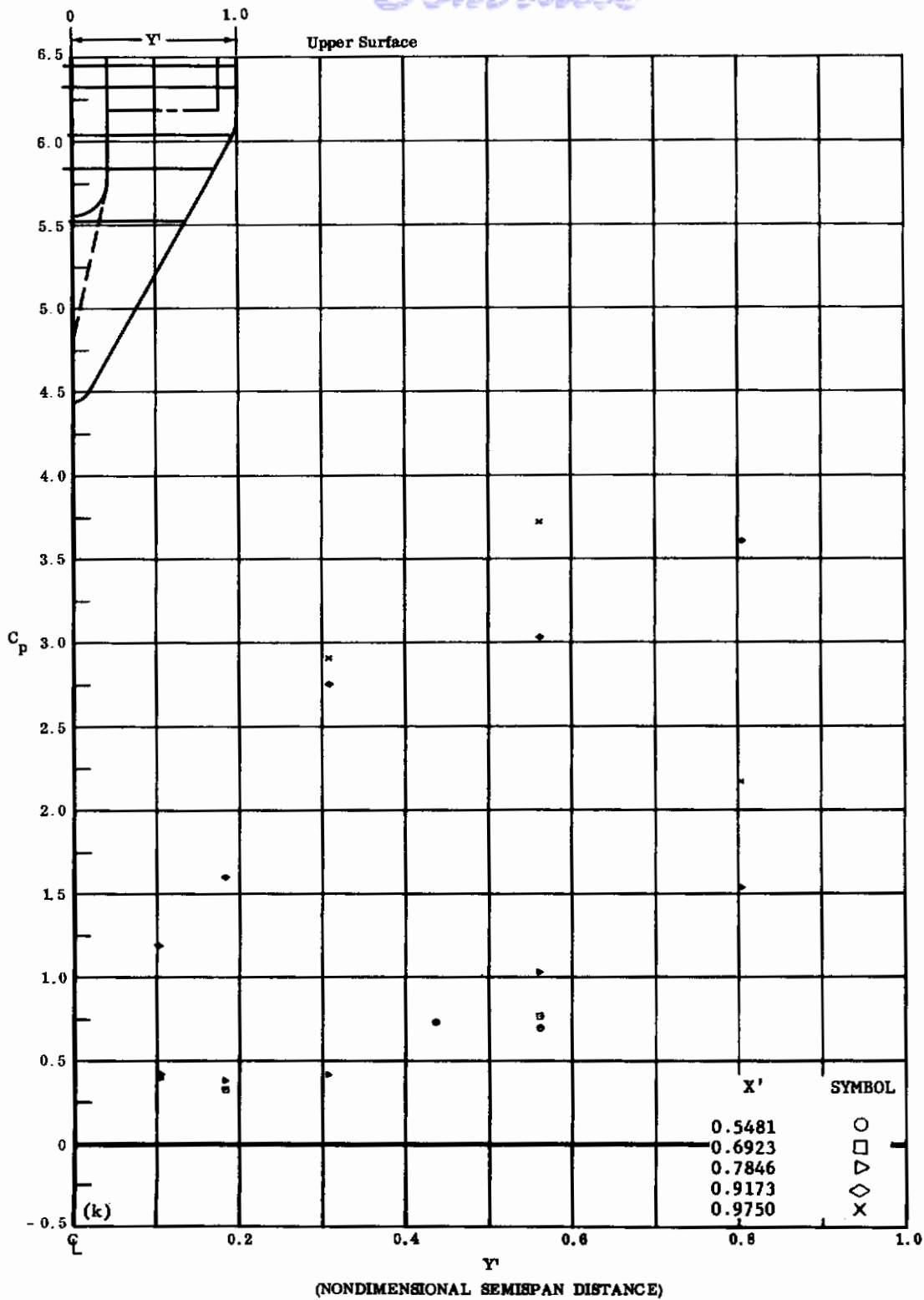
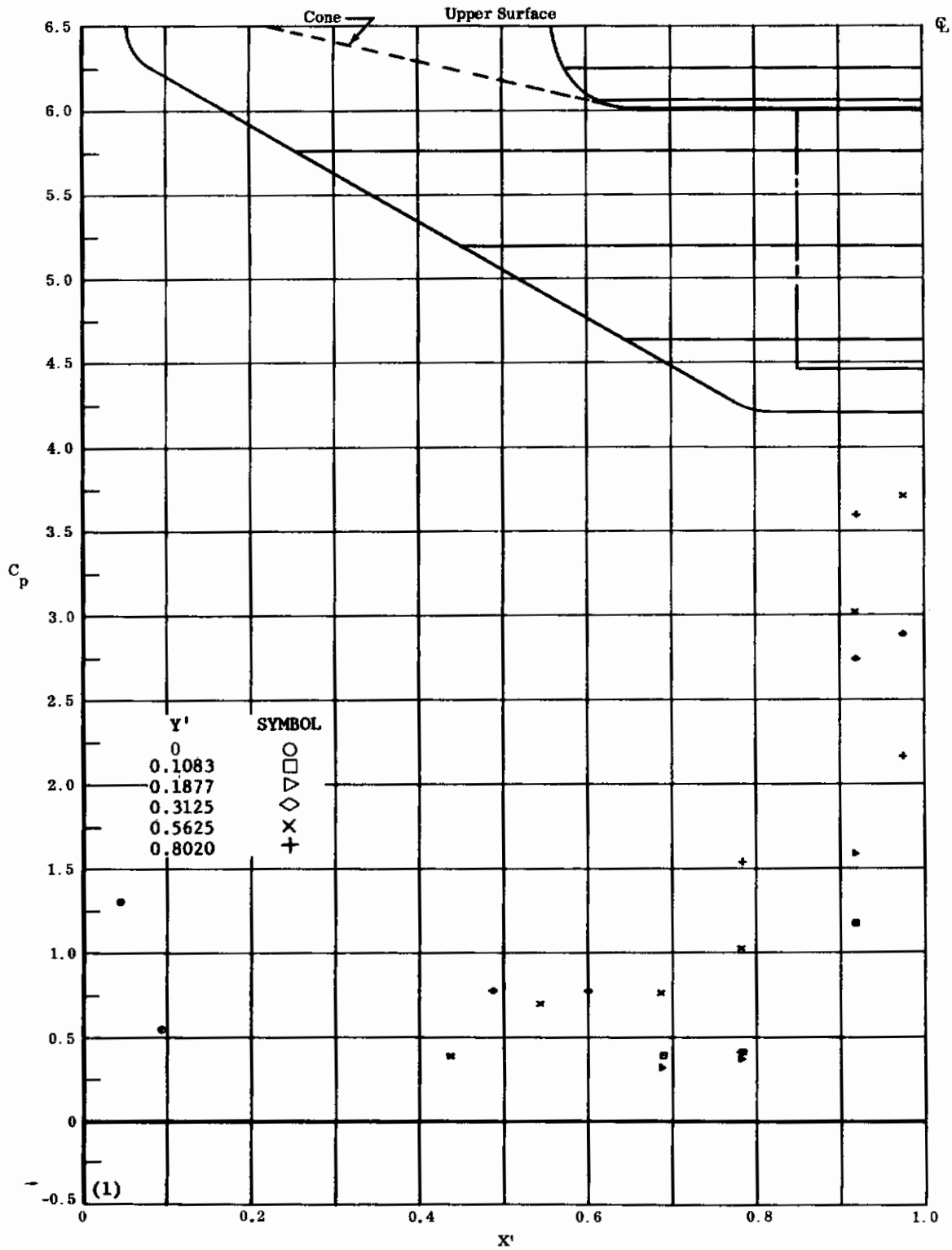

Fig. 23k Configuration I, $\alpha = -30$, $\delta_2 = \delta_3 = -30$

C_p vs. Y' , upper surface

Contrails



(NONDIMENSIONAL STREAMWISE DISTANCE FROM VIRTUAL APEX)

Fig. 231 Configuration I, $\alpha = -30$, $\delta_2 = \delta_3 = -30$

C_p vs. X' , upper surface

Contrails

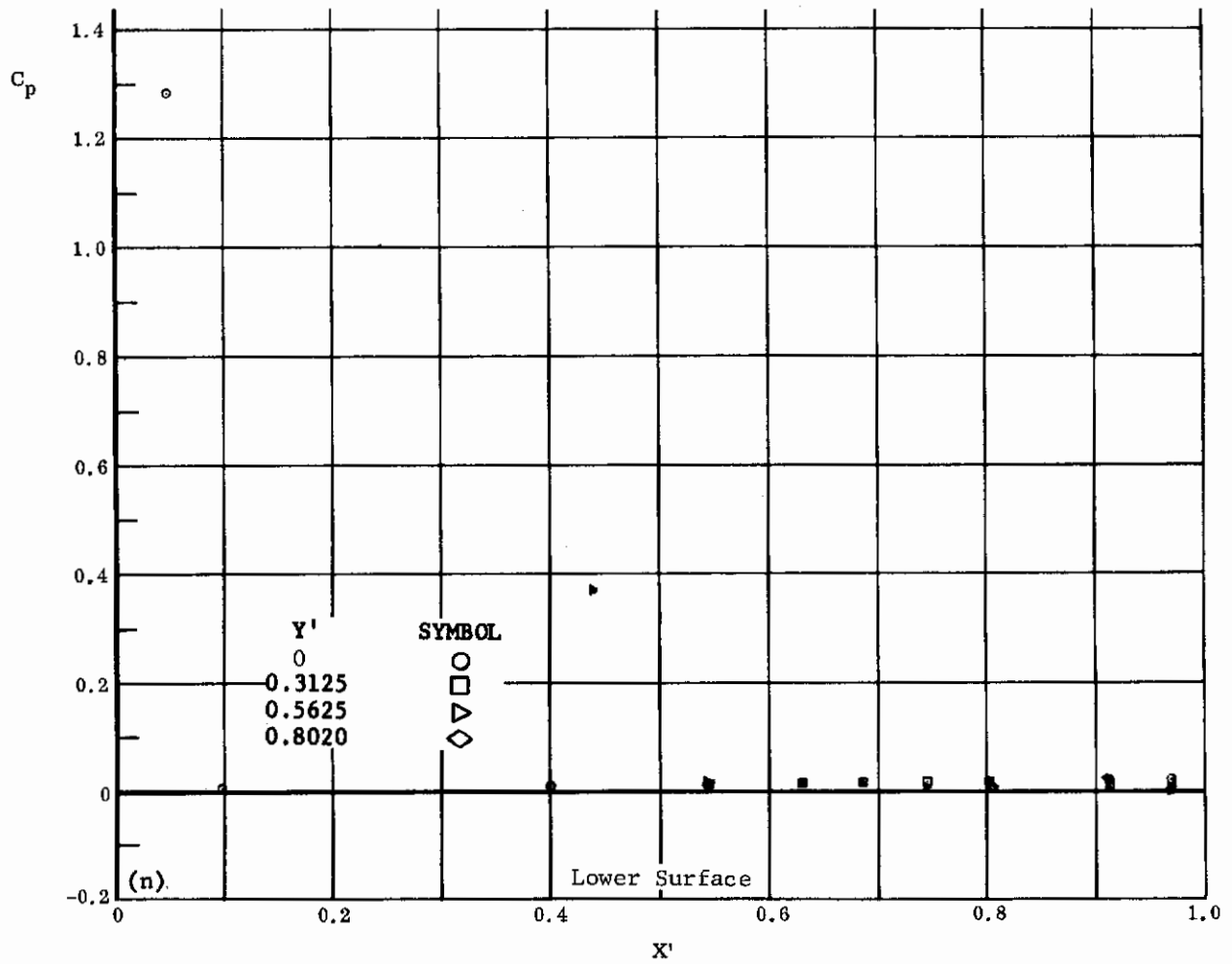
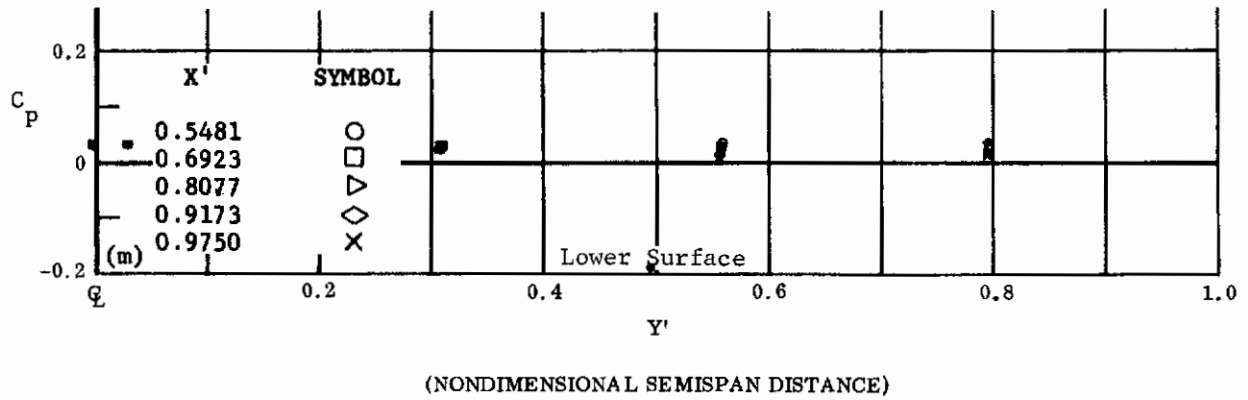

Fig. 23 Configuration I, $\alpha = -30^\circ$, $\delta_2 = \delta_3 = -39^\circ$

m) C_p vs. Y' , lower surface

n) C_p vs. X' , lower surface

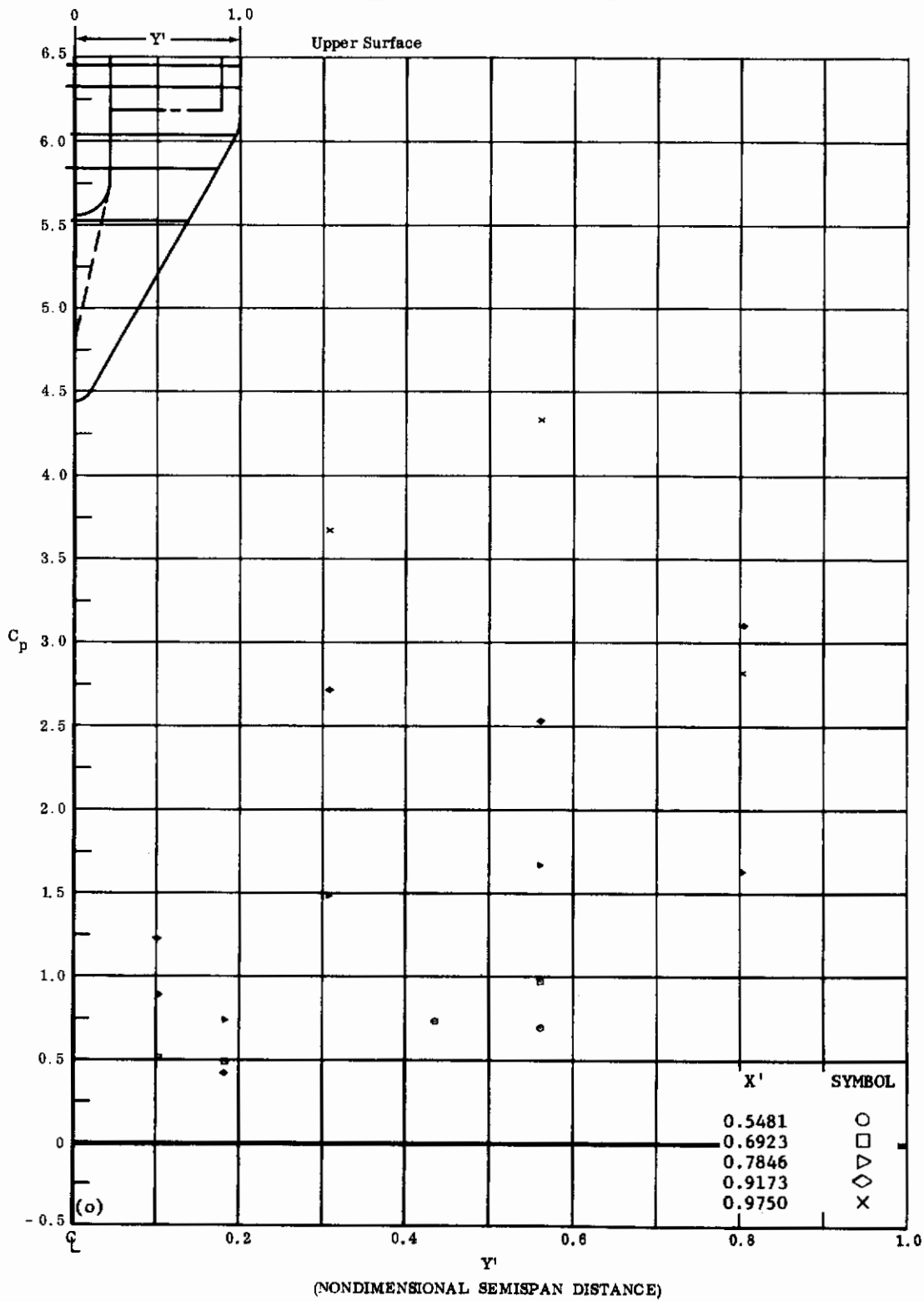
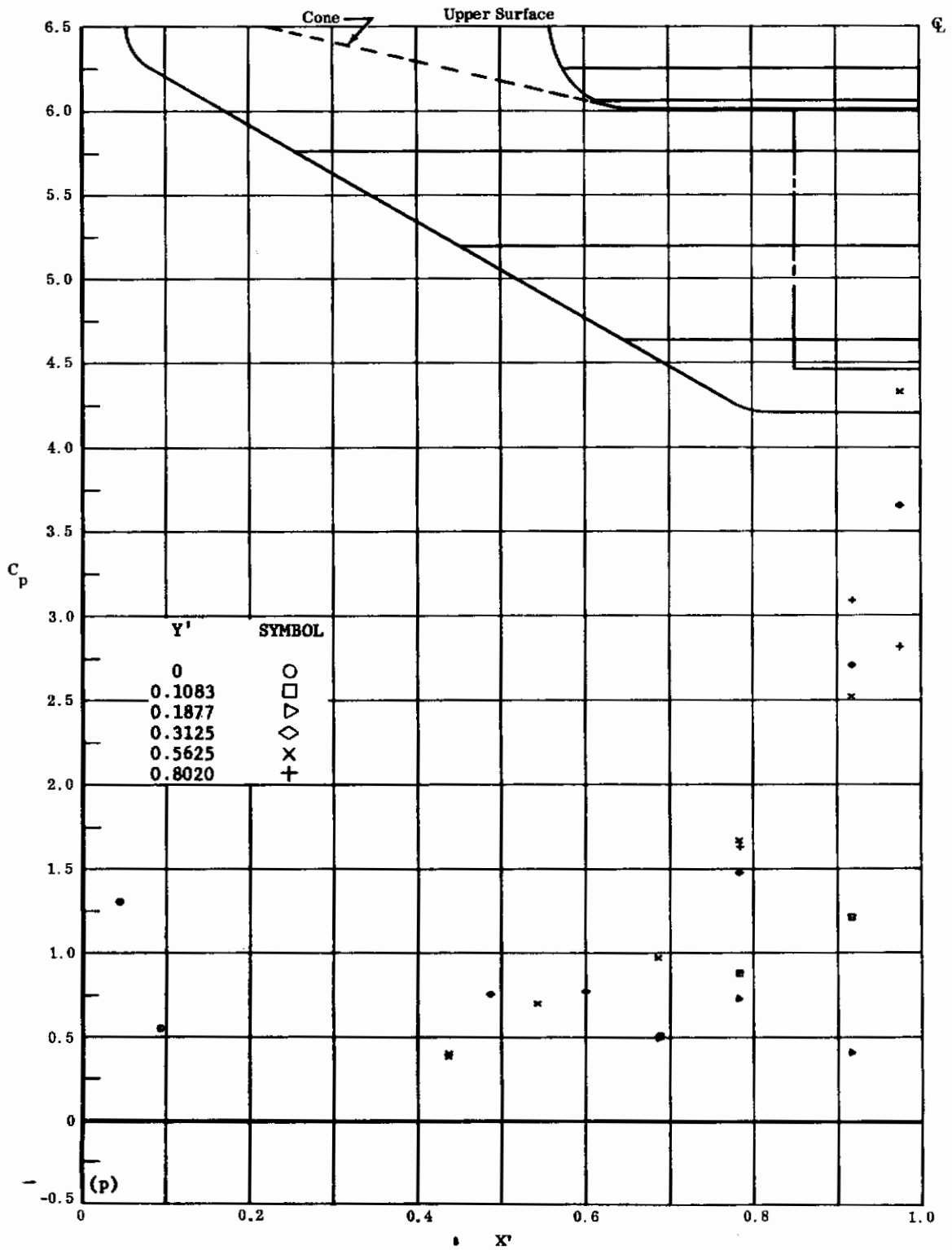

Fig. 23o Configuration I, $\alpha = -30$, $\delta_2 = \delta_3 = -39$

C_p vs. Y' , upper surface



(NONDIMENSIONAL STREAMWISE DISTANCE FROM VIRTUAL APEX)

Fig. 23p Configuration I, $\alpha = -30$, $\delta_2 = \delta_3 = -39$

C_p vs. X' , upper surface

Contrails

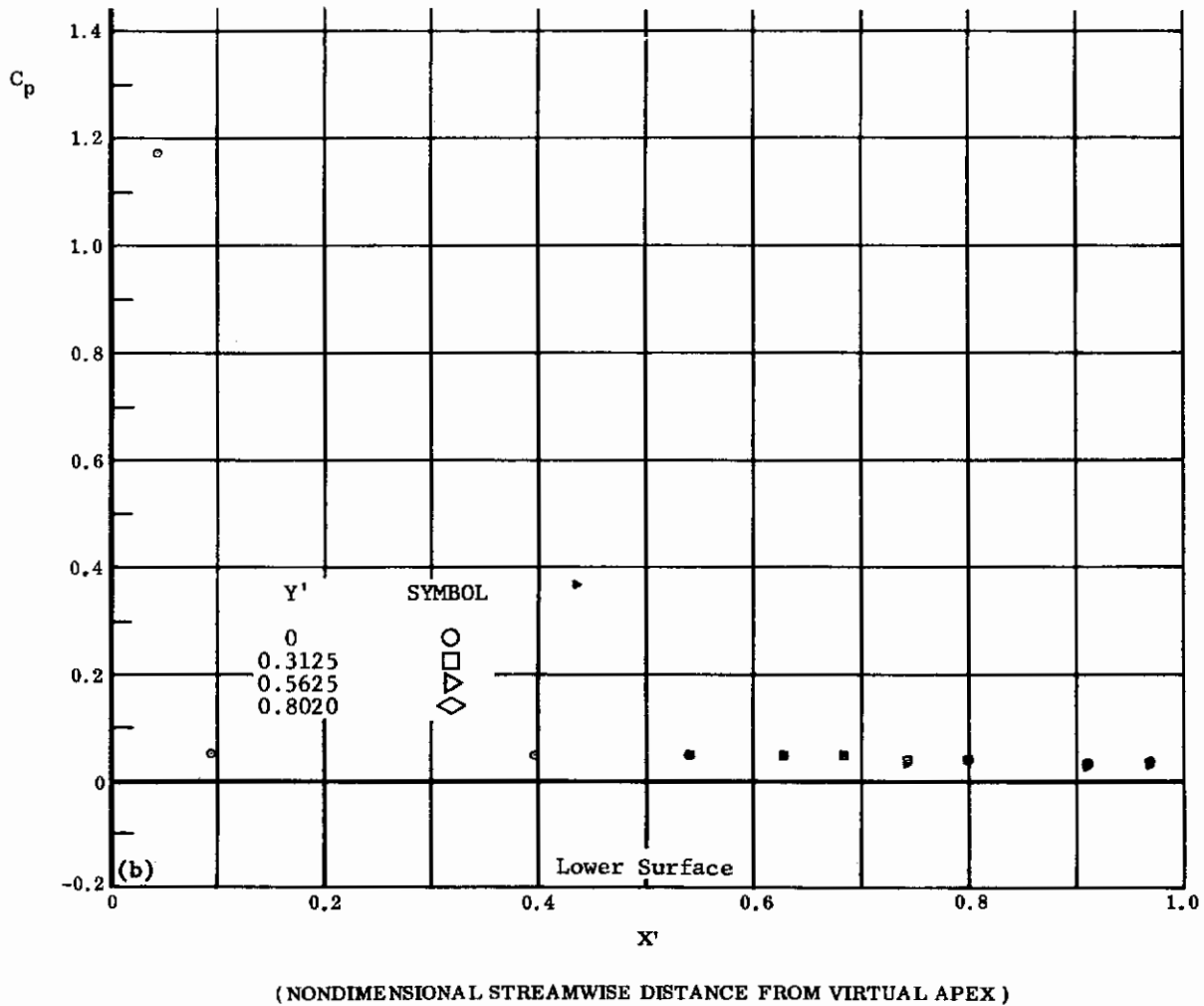
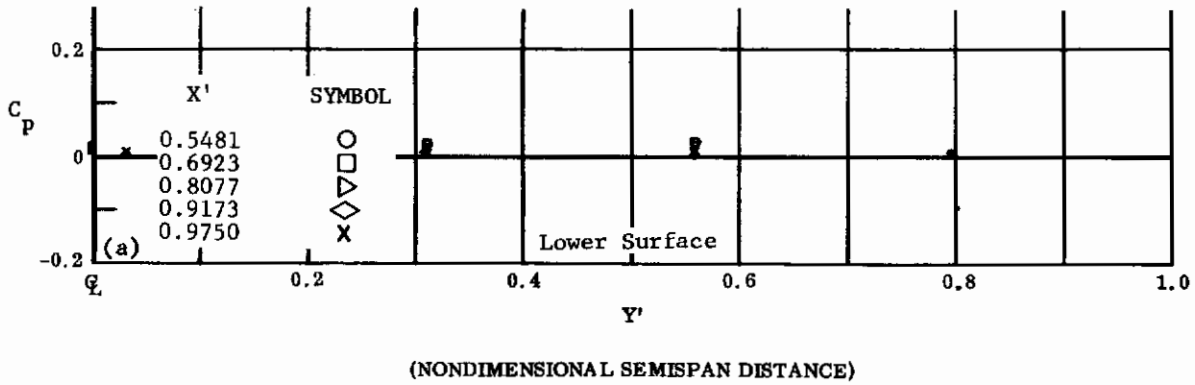

Fig. 24 Configuration I, $\alpha = -35$, $\delta_2 = \delta_3 = -30$

a) C_p vs. Y' , lower surface

b) C_p vs. X' , lower surface

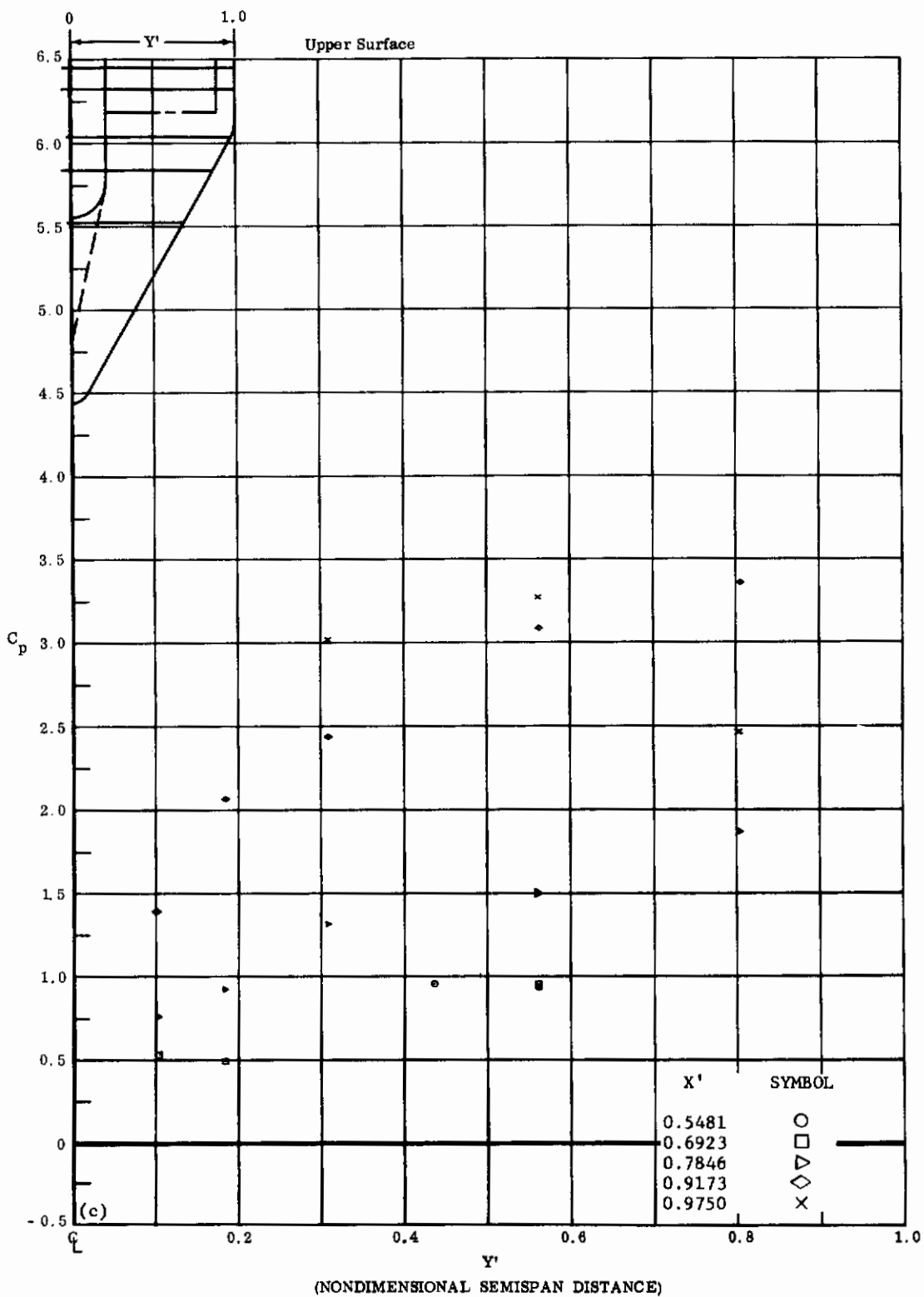
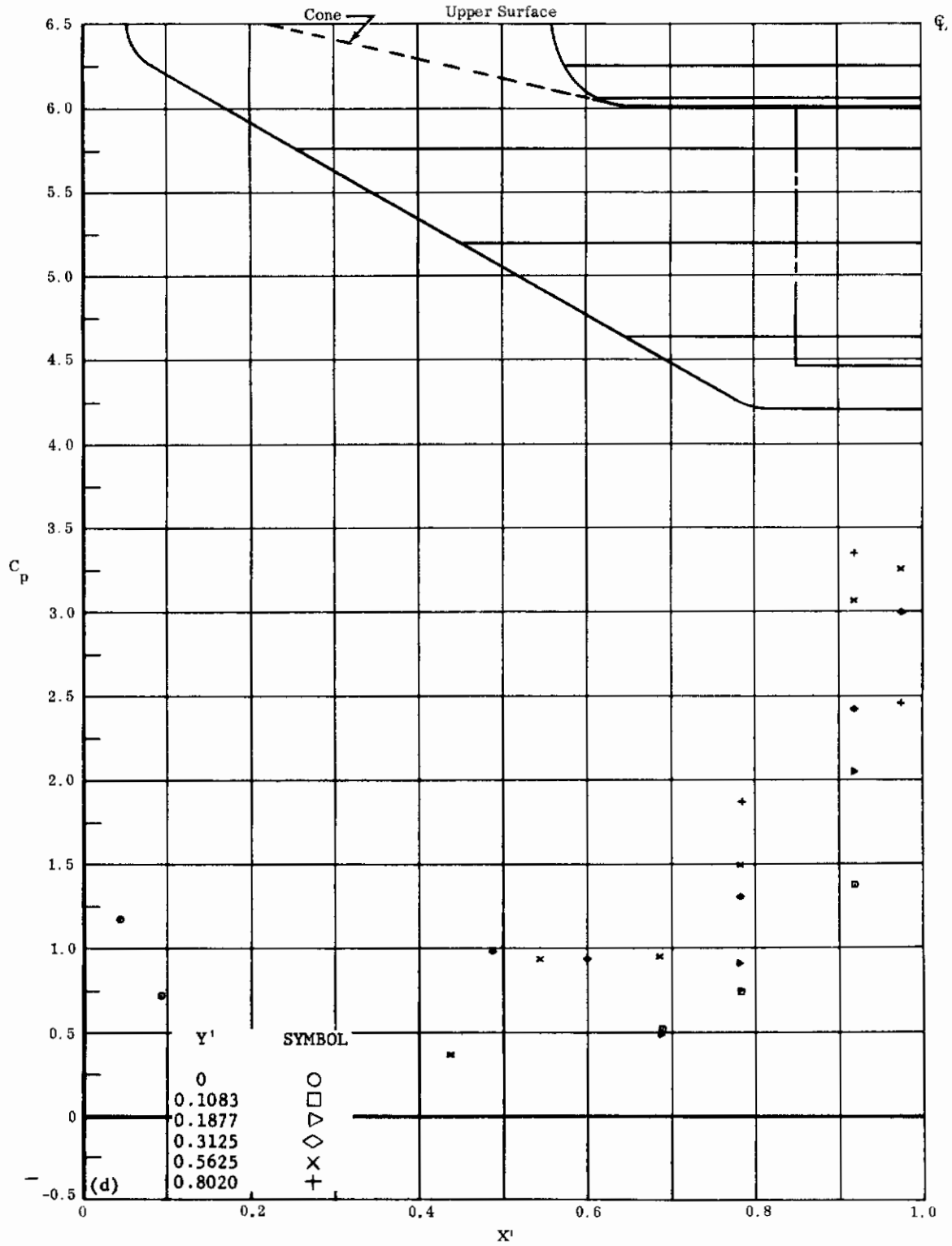

Fig. 24c Configuration I, $\alpha = -35$, $\delta_2 = \delta_3 = -30$

C_p vs. Y' , upper surface



(NONDIMENSIONAL STREAMWISE DISTANCE FROM VIRTUAL APEX)

Fig. 24d Configuration I, $\alpha = -35$, $\delta_2 = \delta_3 = -30$

C_p vs. X' , upper surface

Contrails

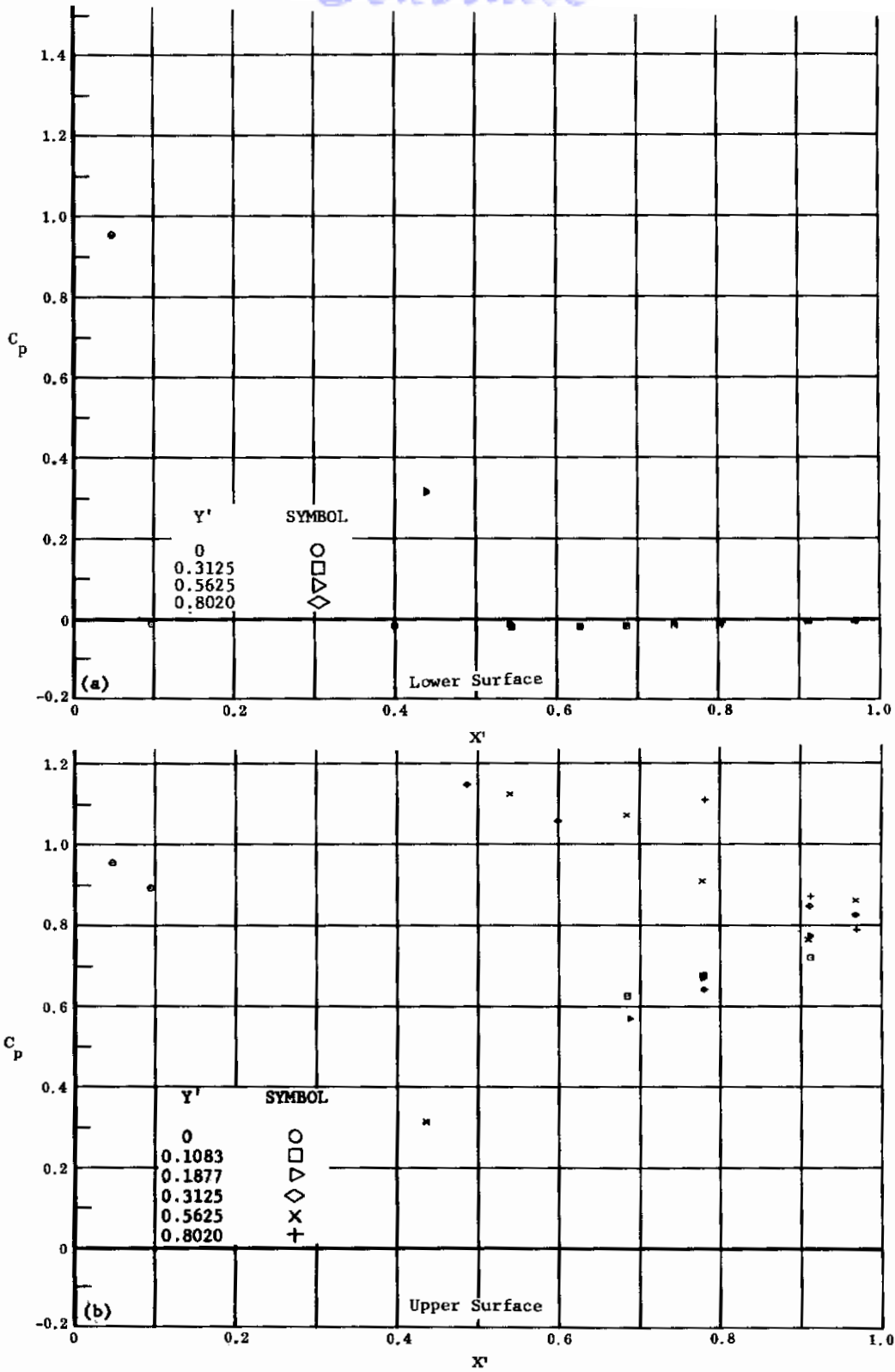

(NONDIMENSIONAL STREAMWISE DISTANCE FROM VIRTUAL APEX)

Fig. 25 Configuration I, $\alpha = -40$, $\delta_2 = \delta_3 = 0$

a) C_p vs. X' , lower surface

b) C_p vs. X' , upper surface

Contrails

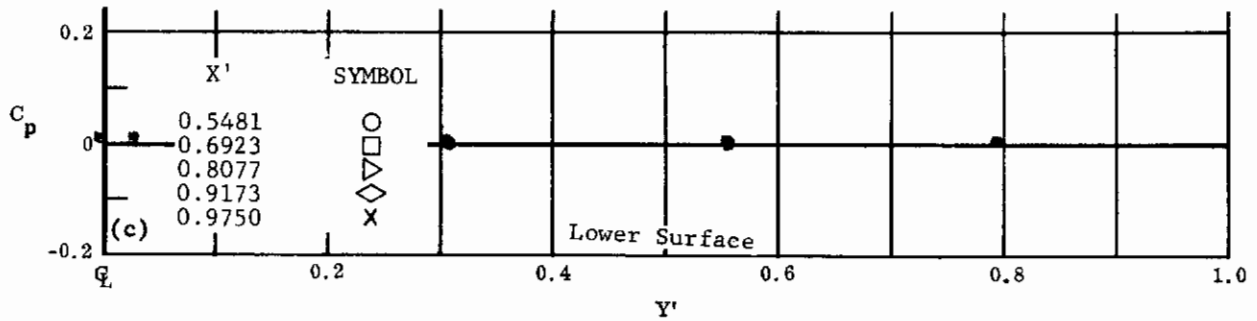

(NONDIMENSIONAL SEMISPAN DISTANCE)

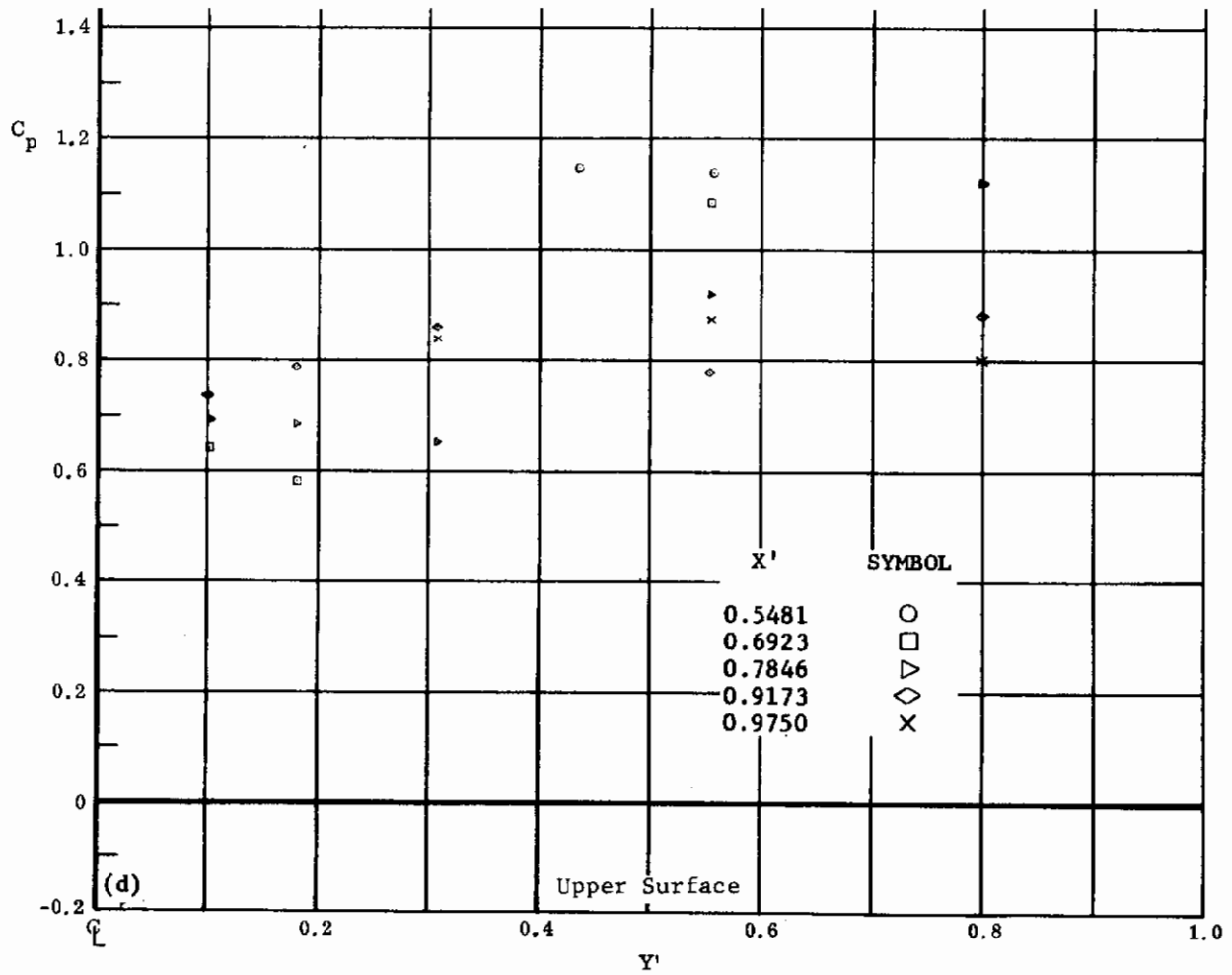

(NONDIMENSIONAL SEMISPAN DISTANCE)

Fig. 25 Configuration I, $\alpha = -40$, $\delta_2 = \delta_3 = 0$

c) C_p vs. Y' , lower surface

d) C_p vs. Y' , upper surface

Contrails

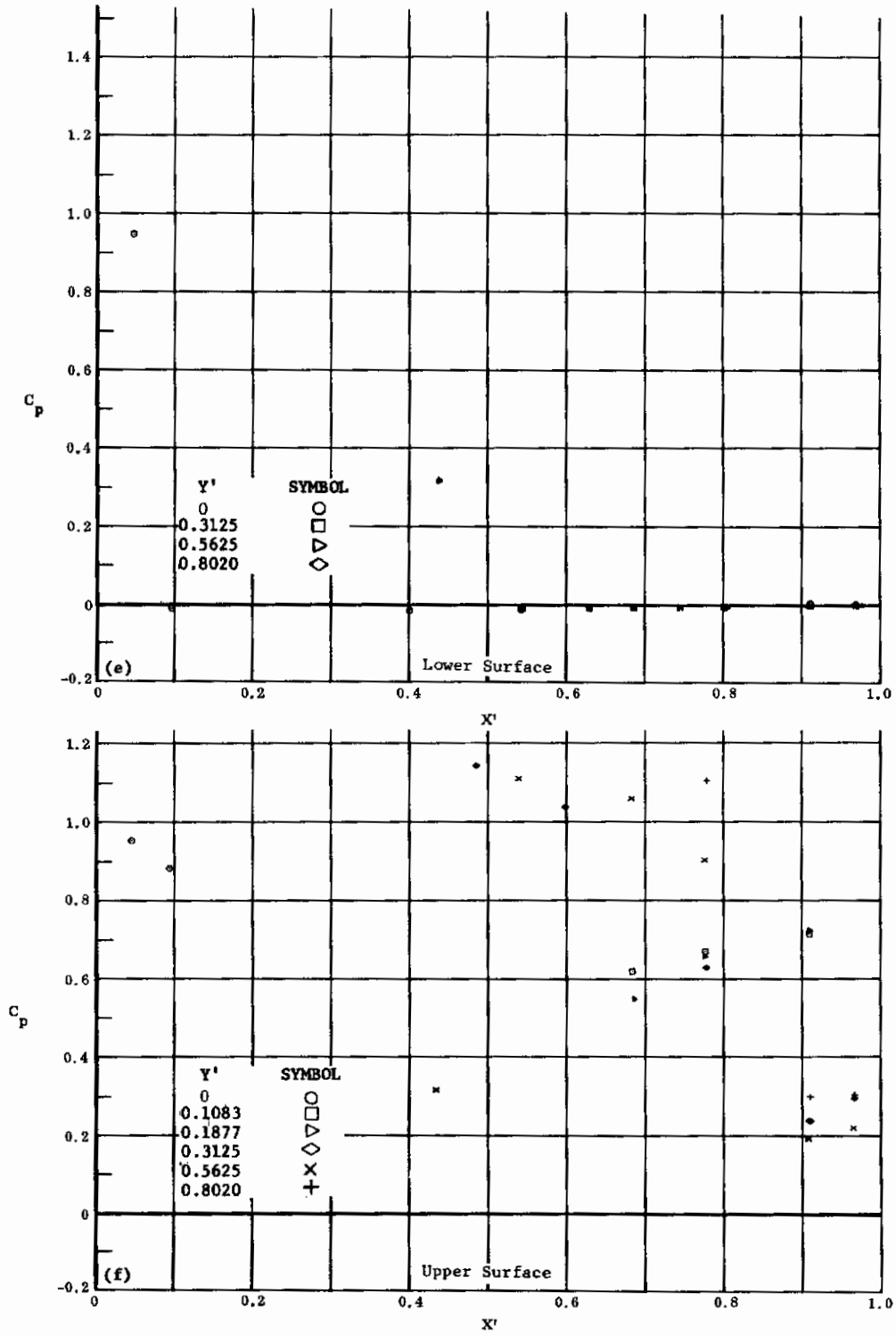

(NONDIMENSIONAL STREAMWISE DISTANCE FROM VIRTUAL APEX)

Fig. 25 Configuration I, $\alpha = -40^\circ$, $\delta_2 = \delta_3 = +20^\circ$

e) C_p vs. X' , lower surface

f) C_p vs. X' , upper surface

Contrails

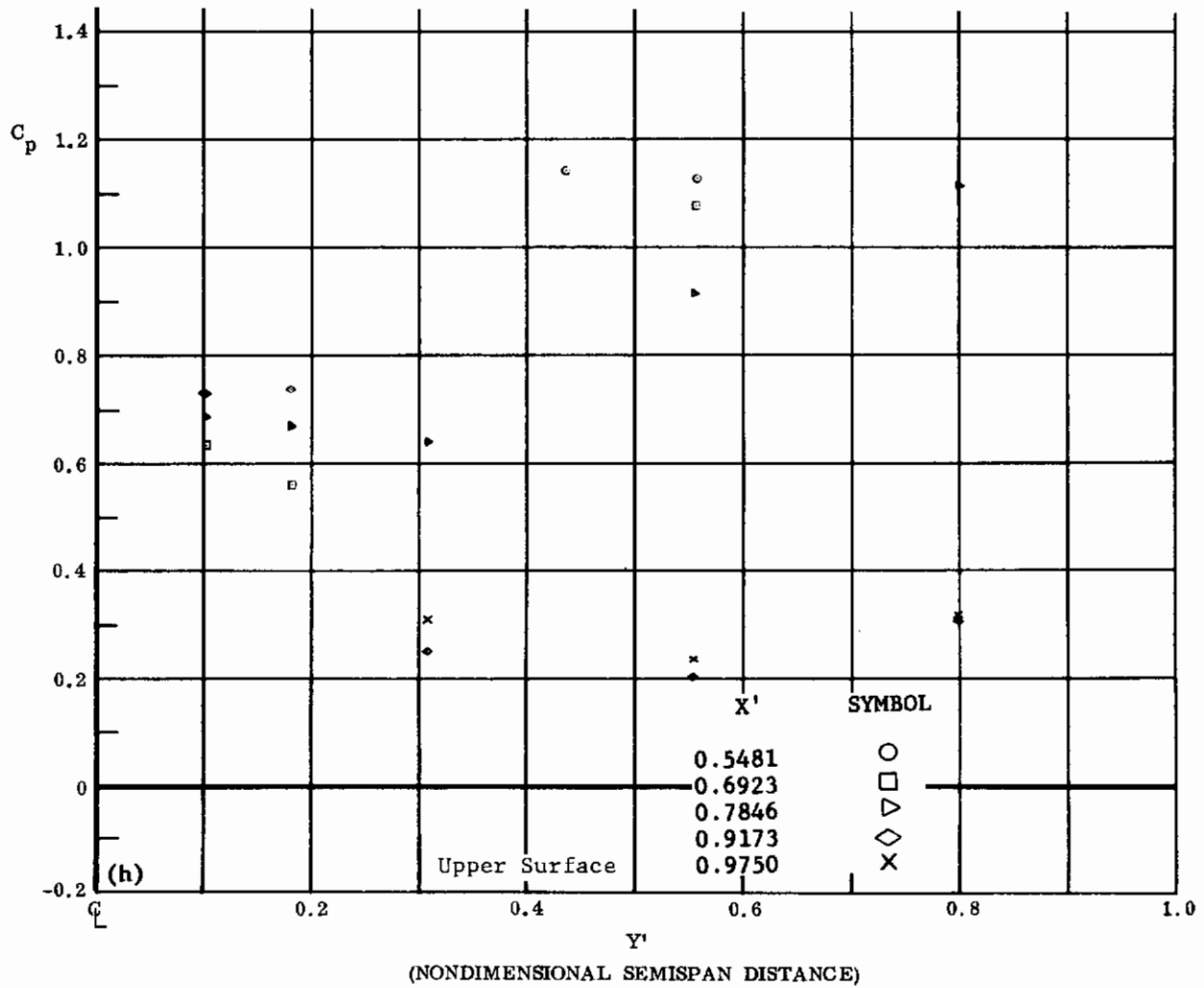
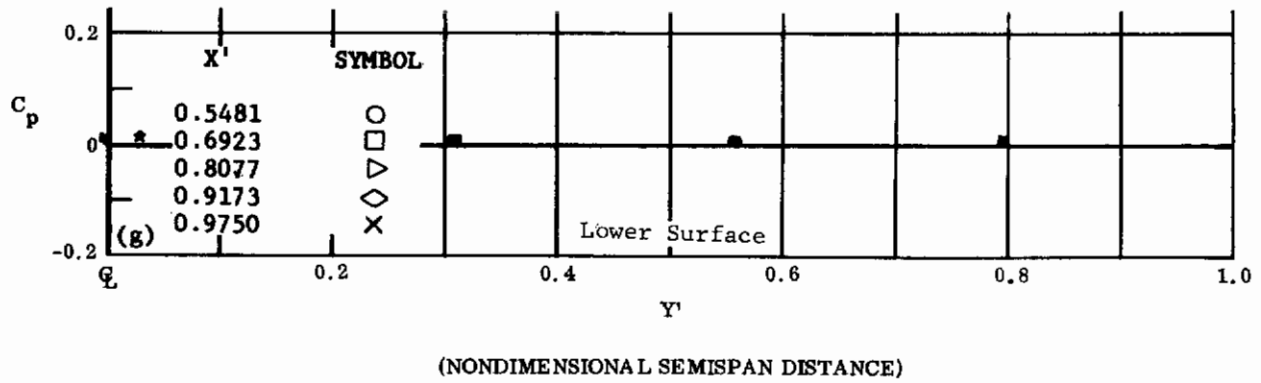
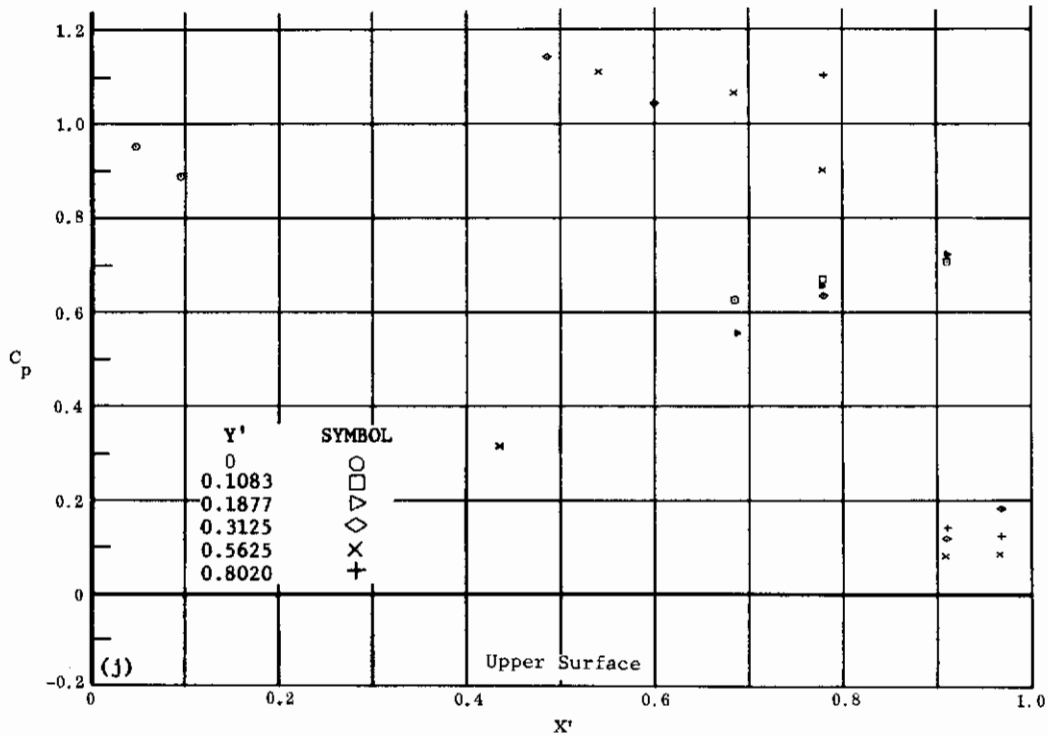
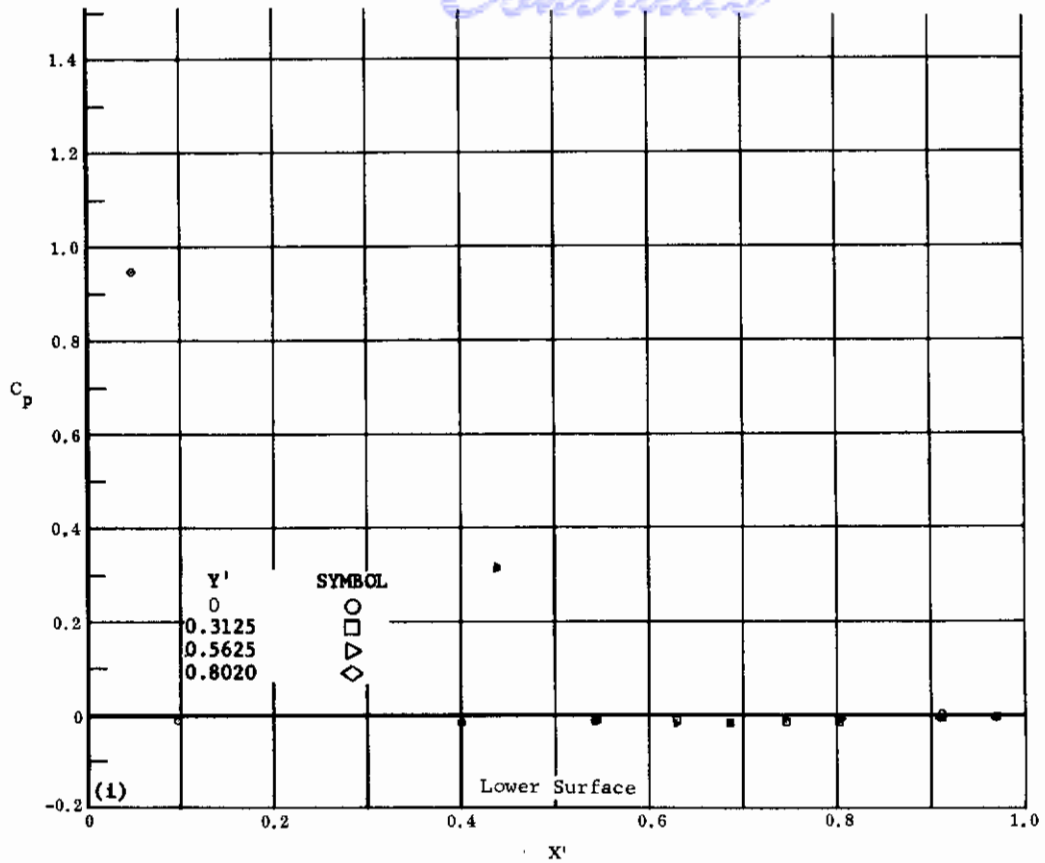

Fig. 25 Configuration I, $\alpha = -40$, $\delta_2 = \delta_3 = +20$

g) C_p vs. Y' , lower surface

h) C_p vs. Y' , upper surface



(NONDIMENSIONAL STREAMWISE DISTANCE FROM VIRTUAL APEX)

Fig. 25 Configuration I, $\alpha = -40$, $\delta_2 = \delta_3 = +30$

i) C_p vs. X' , lower surface

j) C_p vs. X' , upper surface

Contrails

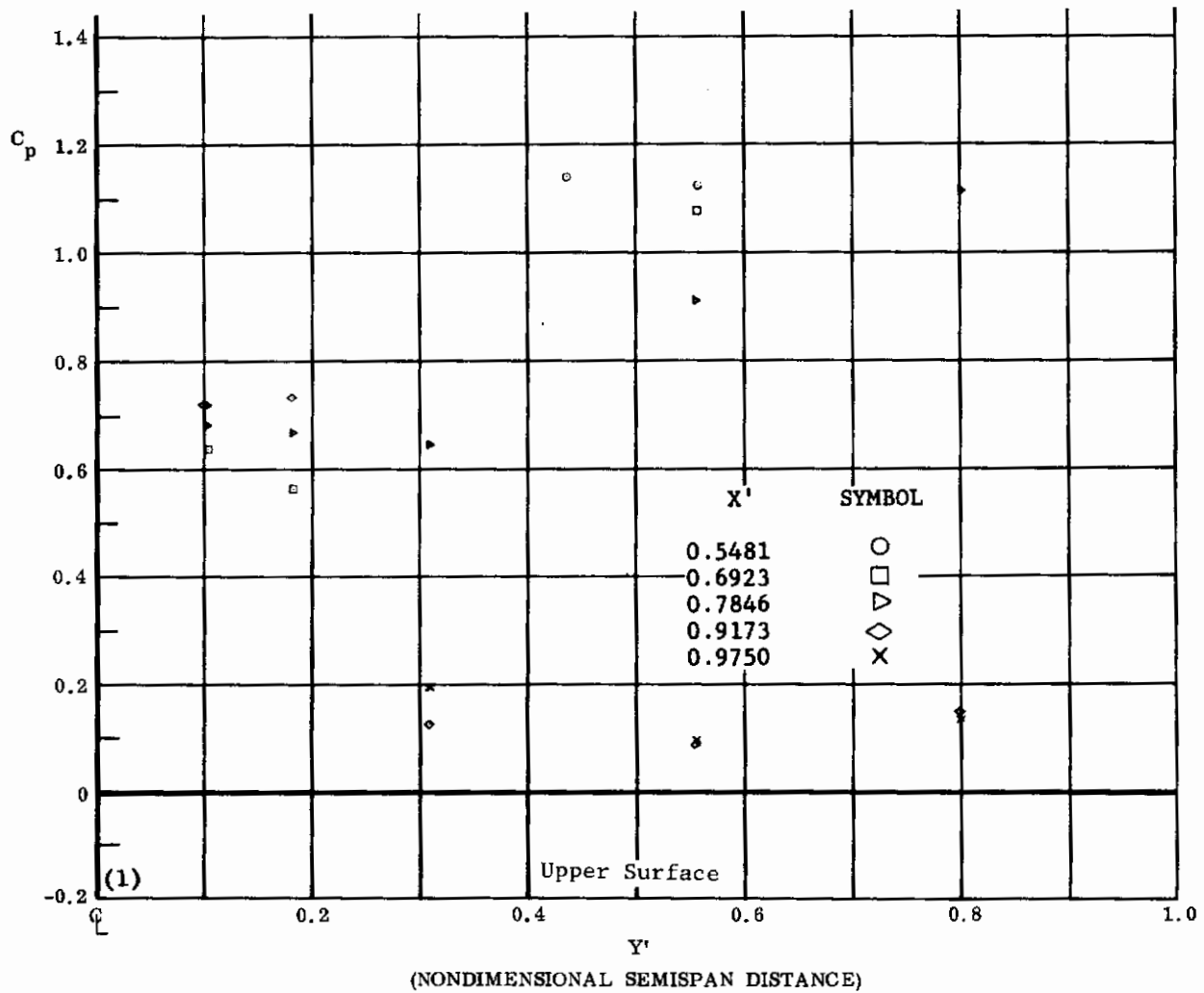
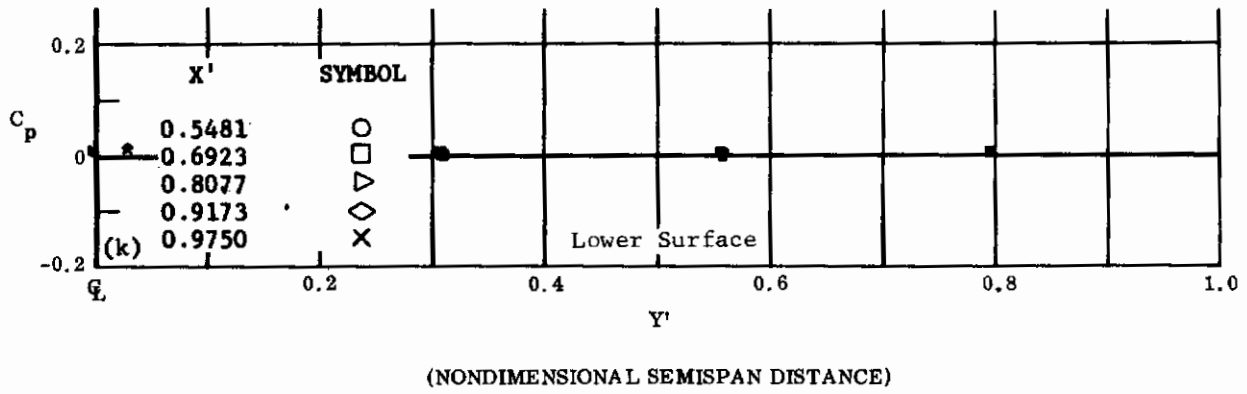
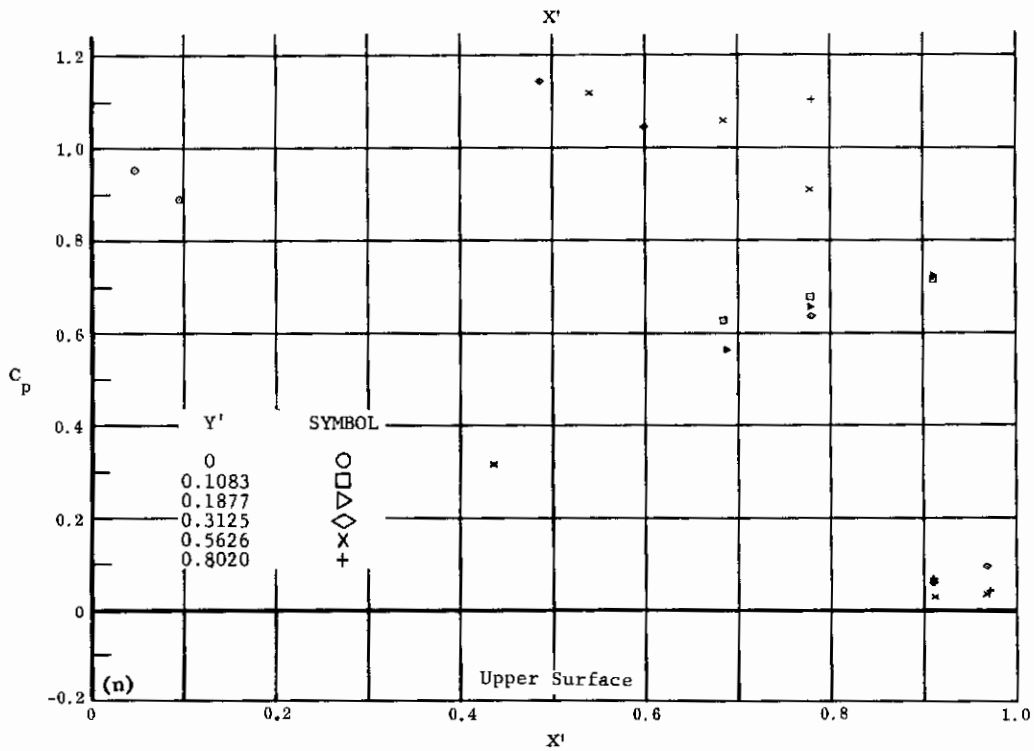
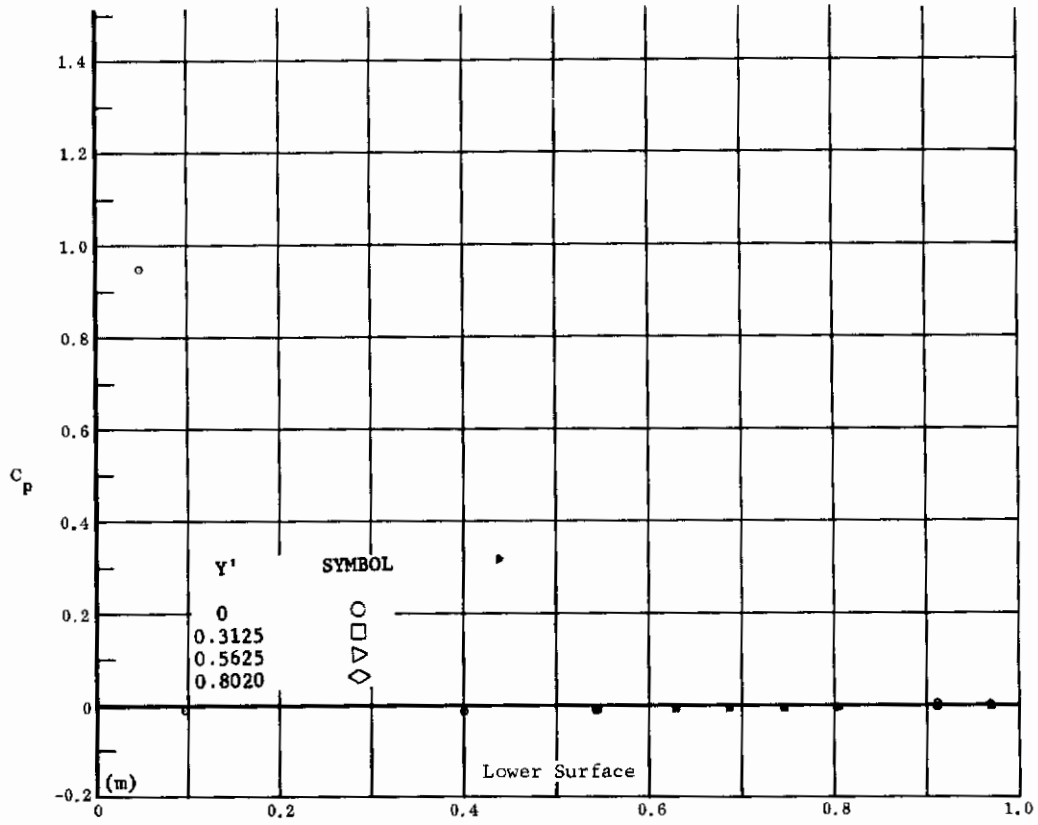

Fig. 25 Configuration I, $\alpha = -40$, $\delta_2 = \delta_3 = +30$

k) C_p vs. Y' , lower surface

1) C_p vs. Y' , upper surface

Contrails



(NONDIMENSIONAL STREAMWISE DISTANCE FROM VIRTUAL APEX)

Fig. 25 Configuration I, $\alpha = -40$, $\delta_2 = \delta_3 = +39$

m) C_p vs. X' , lower surface

n) C_p vs. X' , upper surface

Contrails

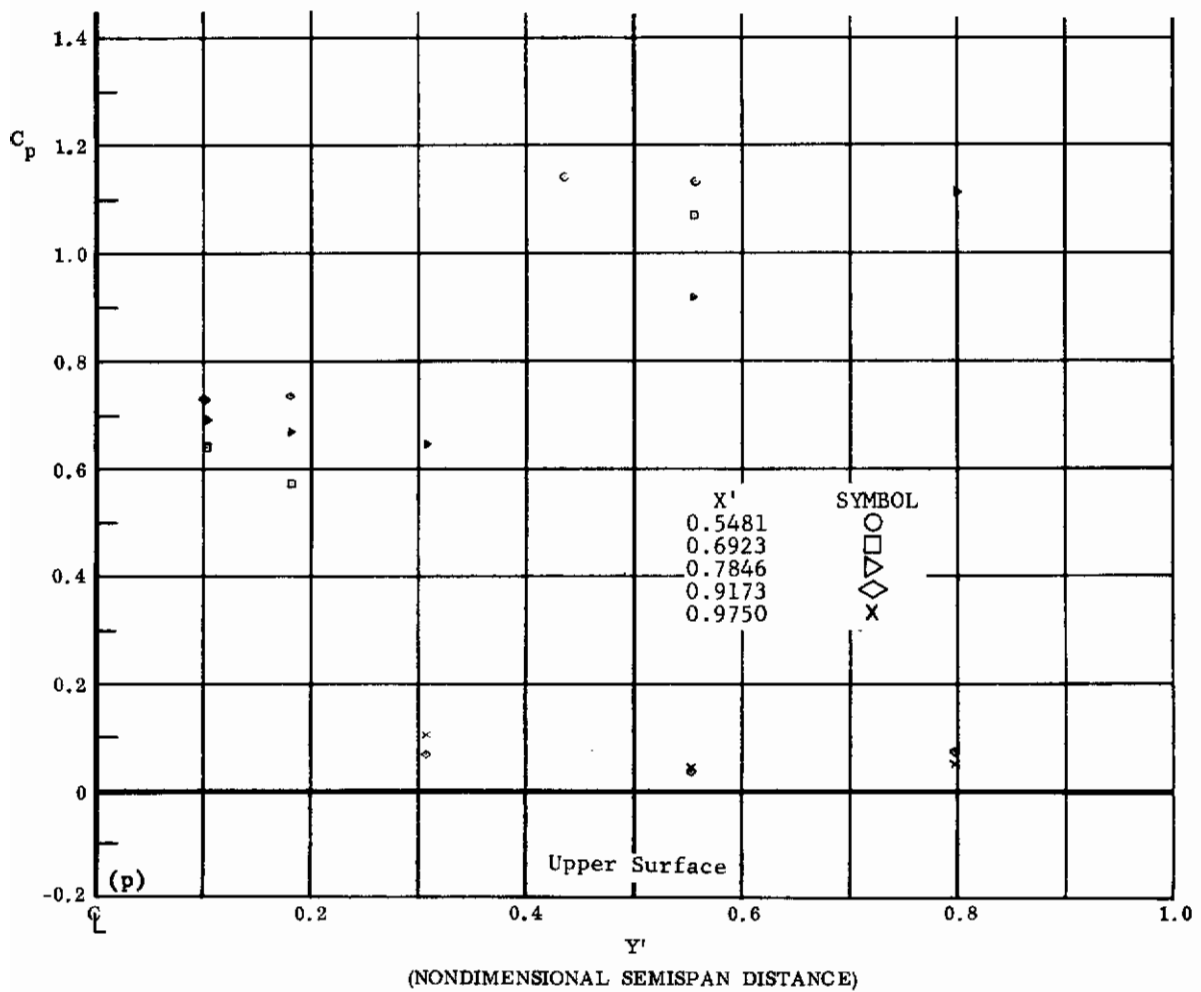
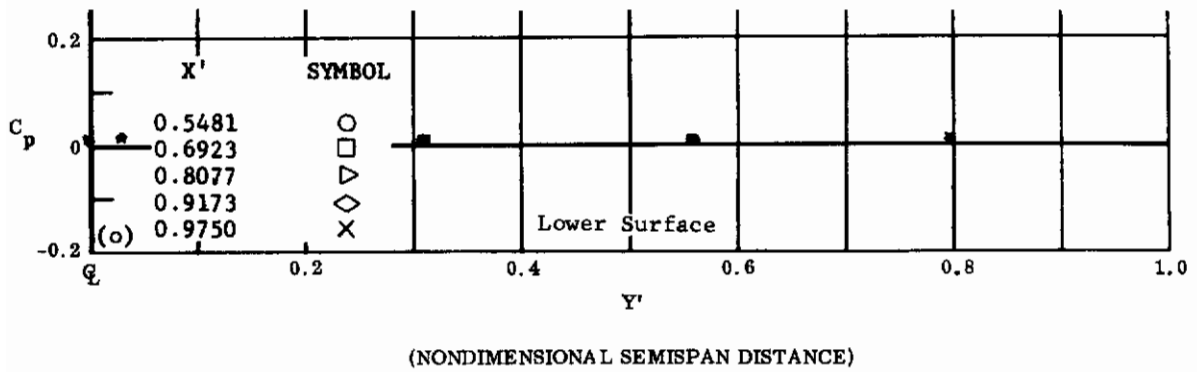
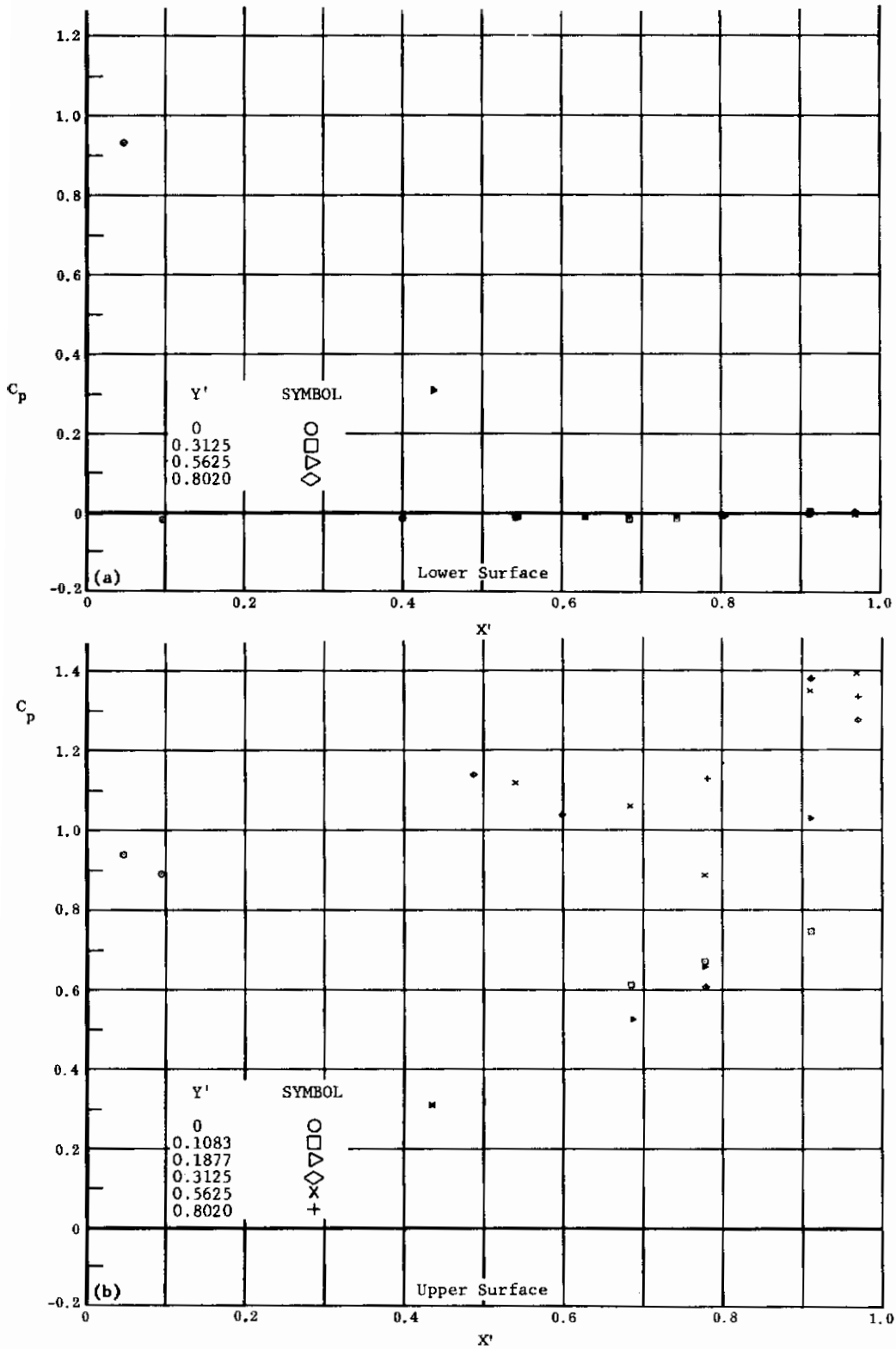

Fig. 25 Configuration I, $\alpha = -40$, $\delta_2 = \delta_3 = +39$

- o) C_p vs. Y' , lower surface
- p) C_p vs. Y' , upper surface

Contrails



(NONDIMENSIONAL STREAMWISE DISTANCE FROM VIRTUAL APEX)

Fig. 26 Configuration I, $\alpha = -40$, $\delta_2 = \delta_3 = -10$

a) C_p vs. X' , lower surface

b) C_p vs. X' , upper surface

Contrails

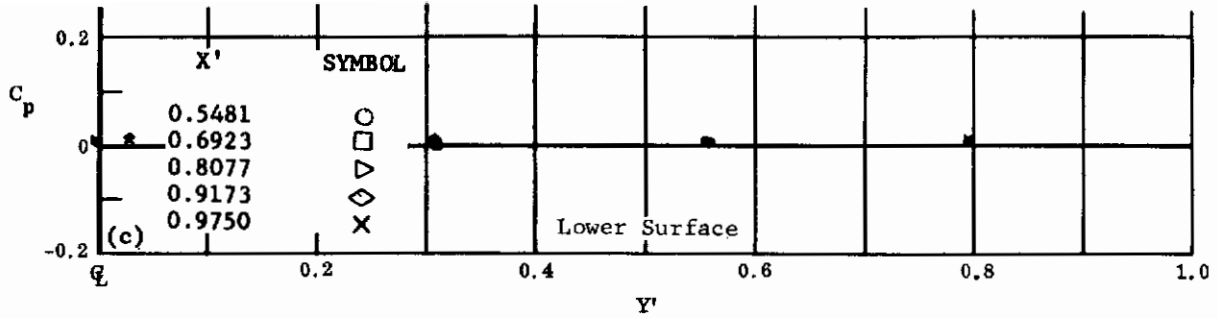

(NONDIMENSIONAL SEMISPAN DISTANCE)

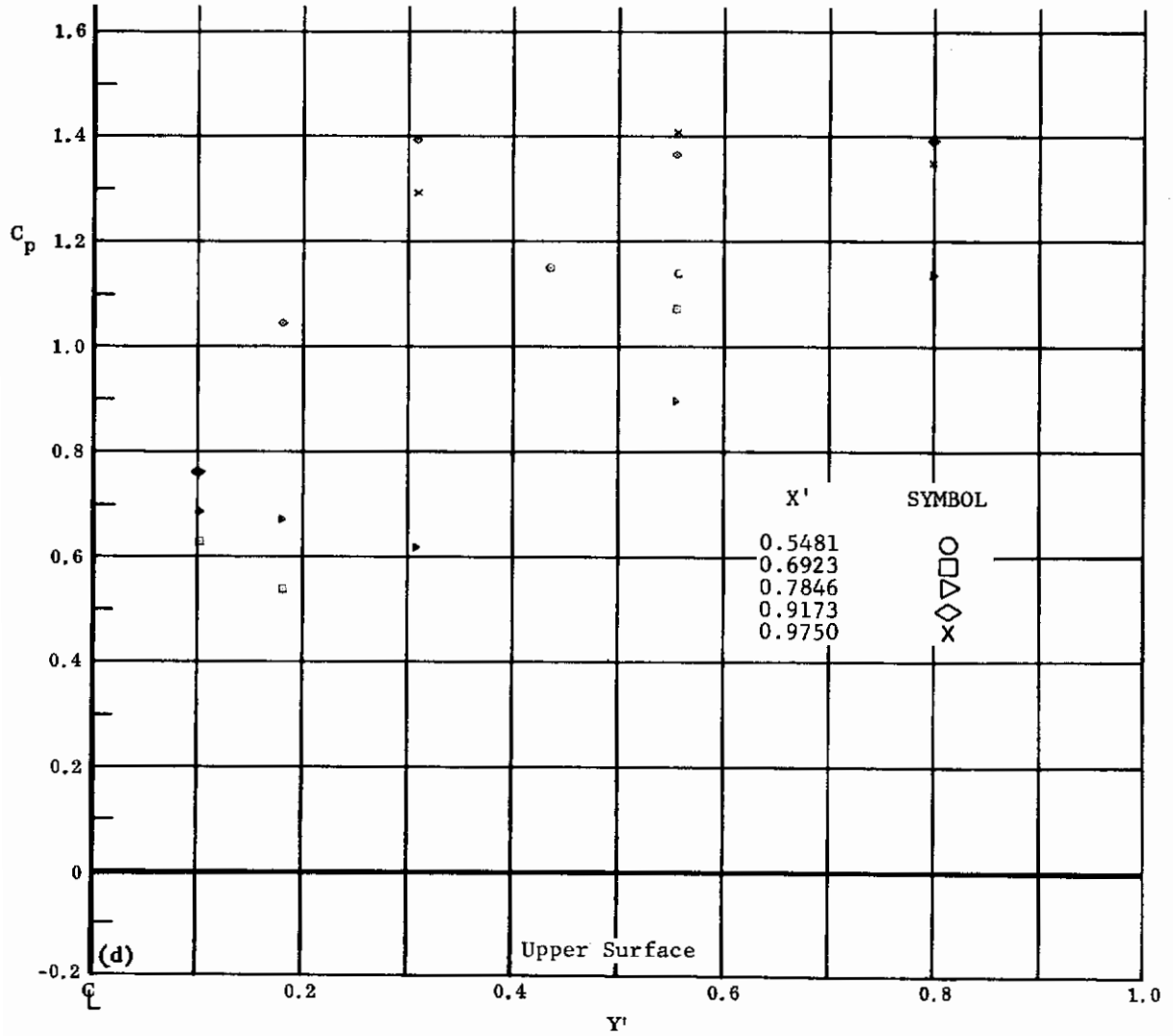

(NONDIMENSIONAL SEMISPAN DISTANCE)

Fig. 26 Configuration I, $\alpha = -40$, $\delta_2 = \delta_3 = -10$

c) C_p vs. Y' , lower surface

d) C_p vs. Y' , upper surface

Contrails

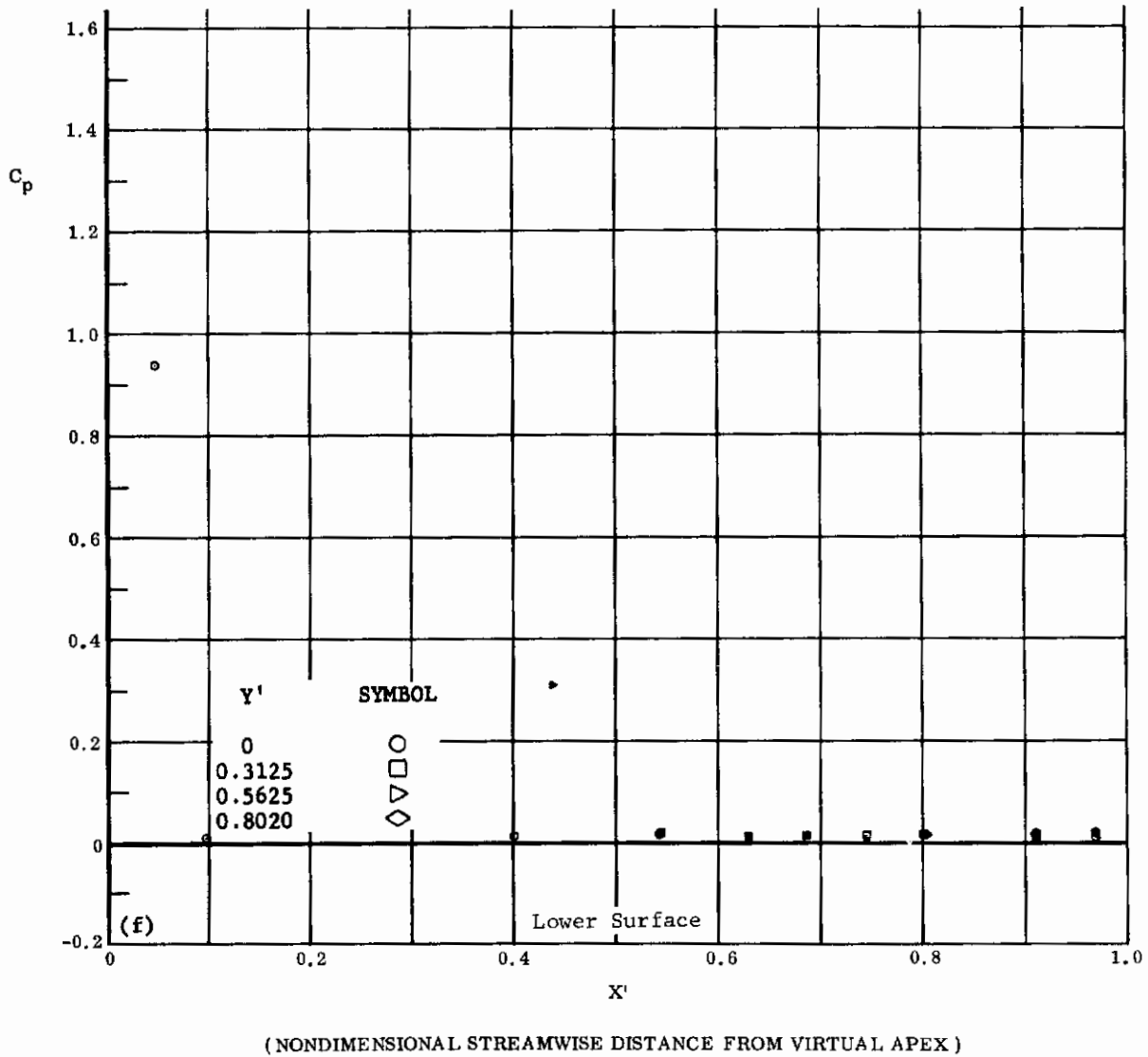
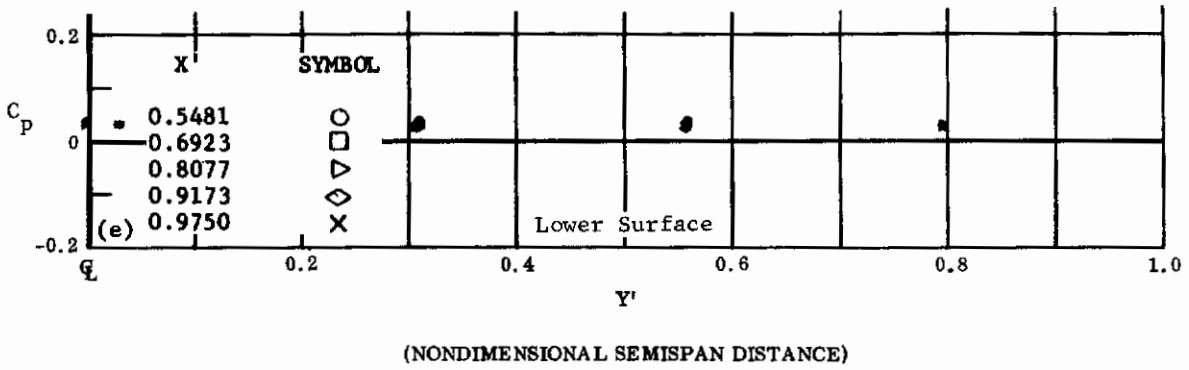

Fig. 26 Configuration I, $\alpha = -40$, $\delta_2 = \delta_3 = -20$

e) C_p vs. Y' , lower surface

f) C_p vs. X' , lower surface

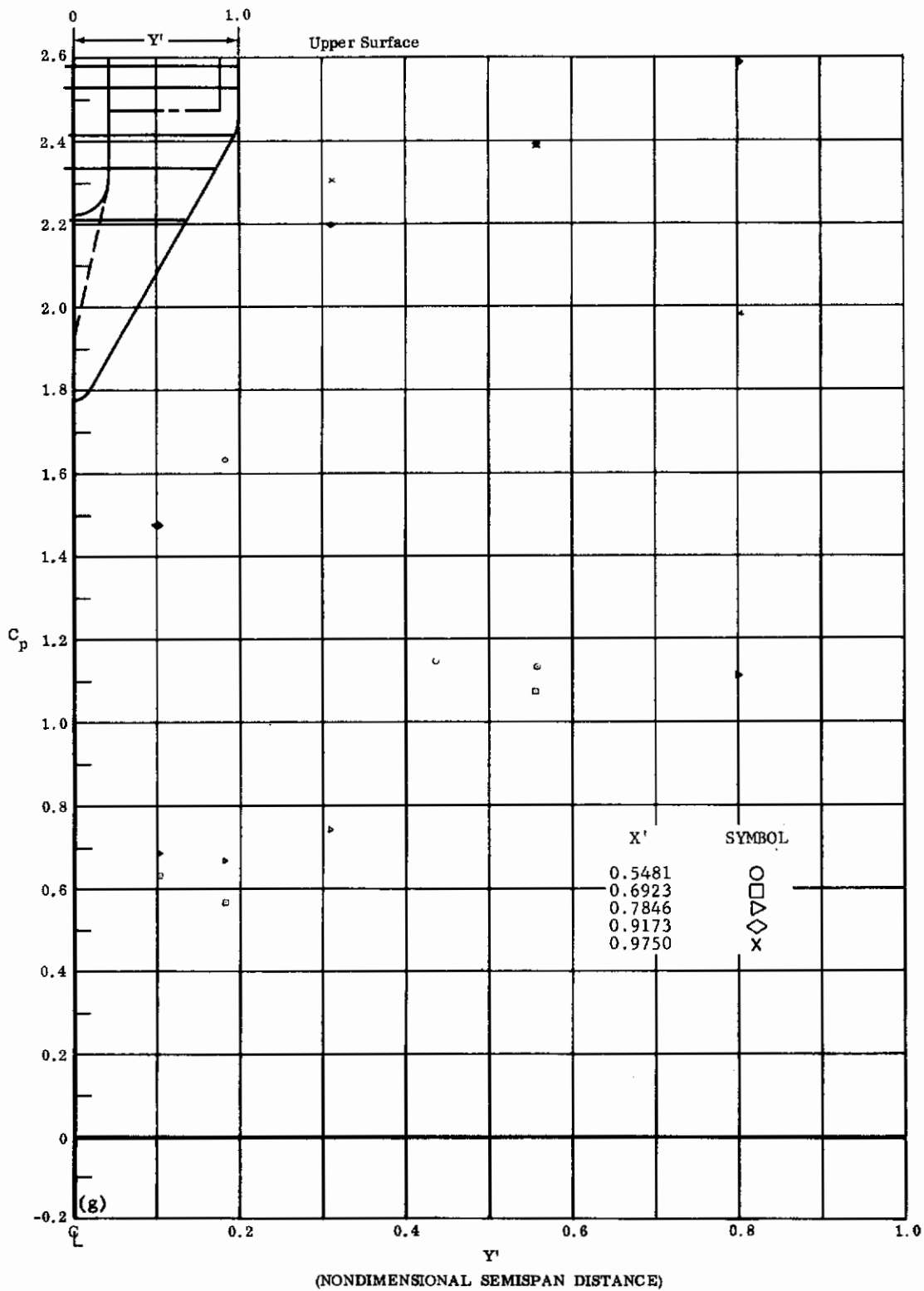
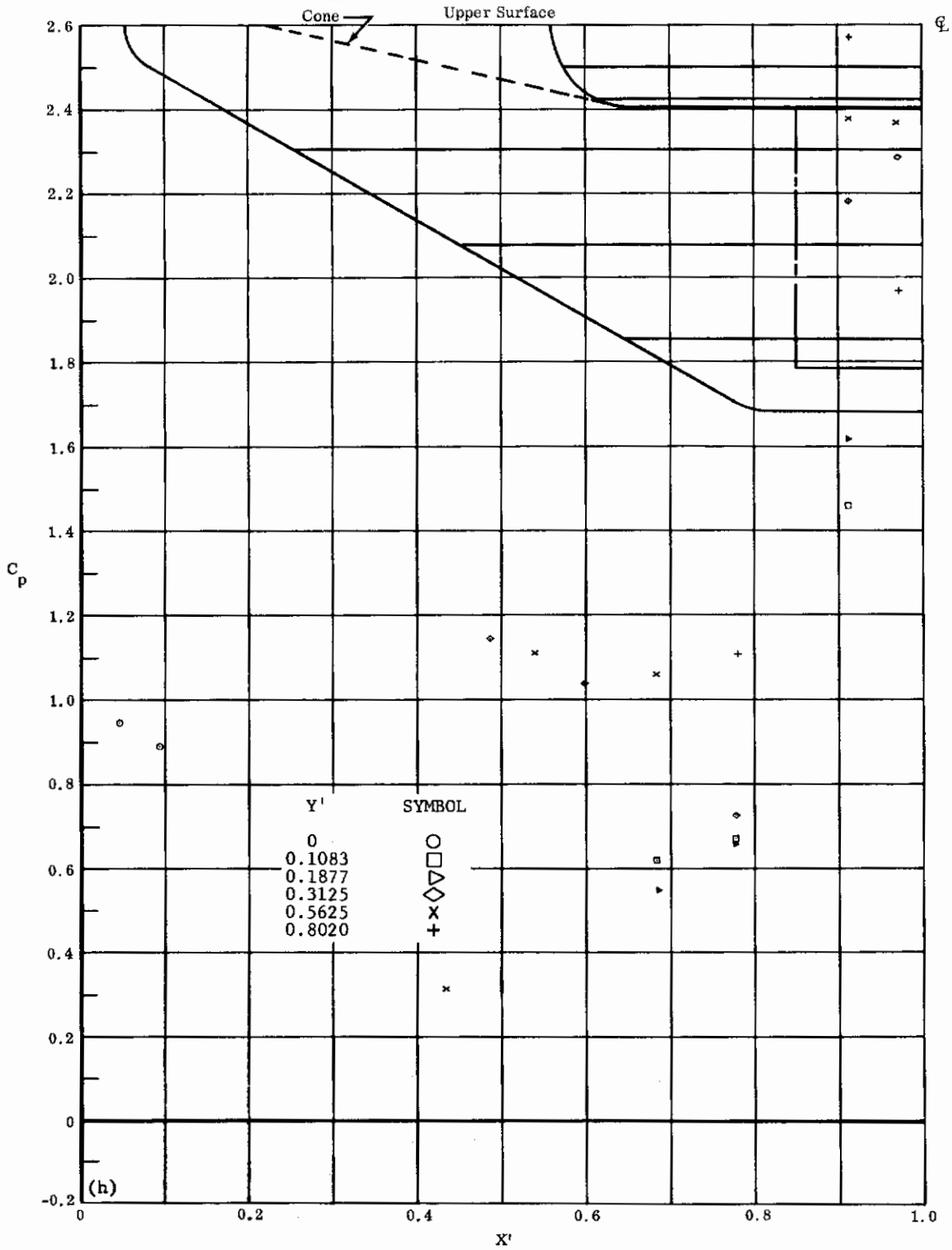

Fig. 26g Configuration I, $\alpha = -40$, $\delta_2 = \delta_3 = -20$
 C_p vs. Y' , upper surface



(NONDIMENSIONAL STREAMWISE DISTANCE FROM VIRTUAL APEX)

Fig. 26h Configuration I, $\alpha = -40$, $\delta_2 = \delta_3 = -20$

C_p vs. X' , upper surface

Contrails

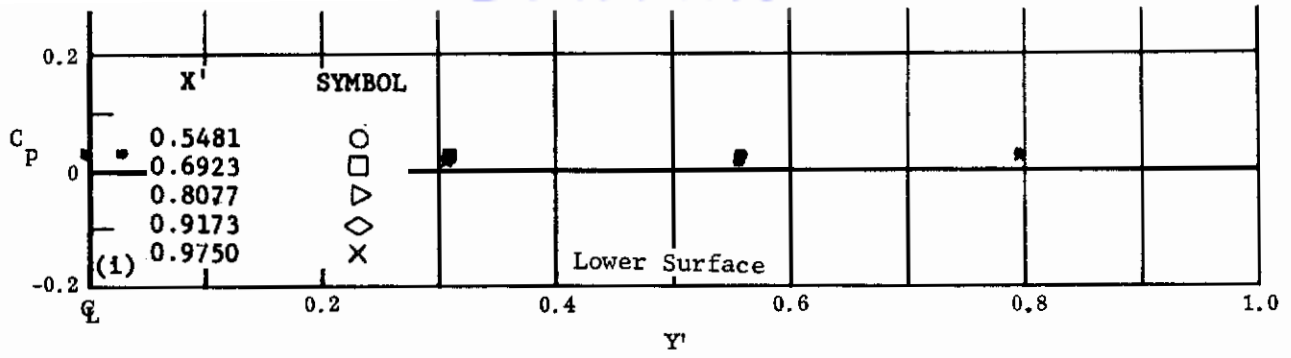

(NONDIMENSIONAL SEMISPAN DISTANCE)

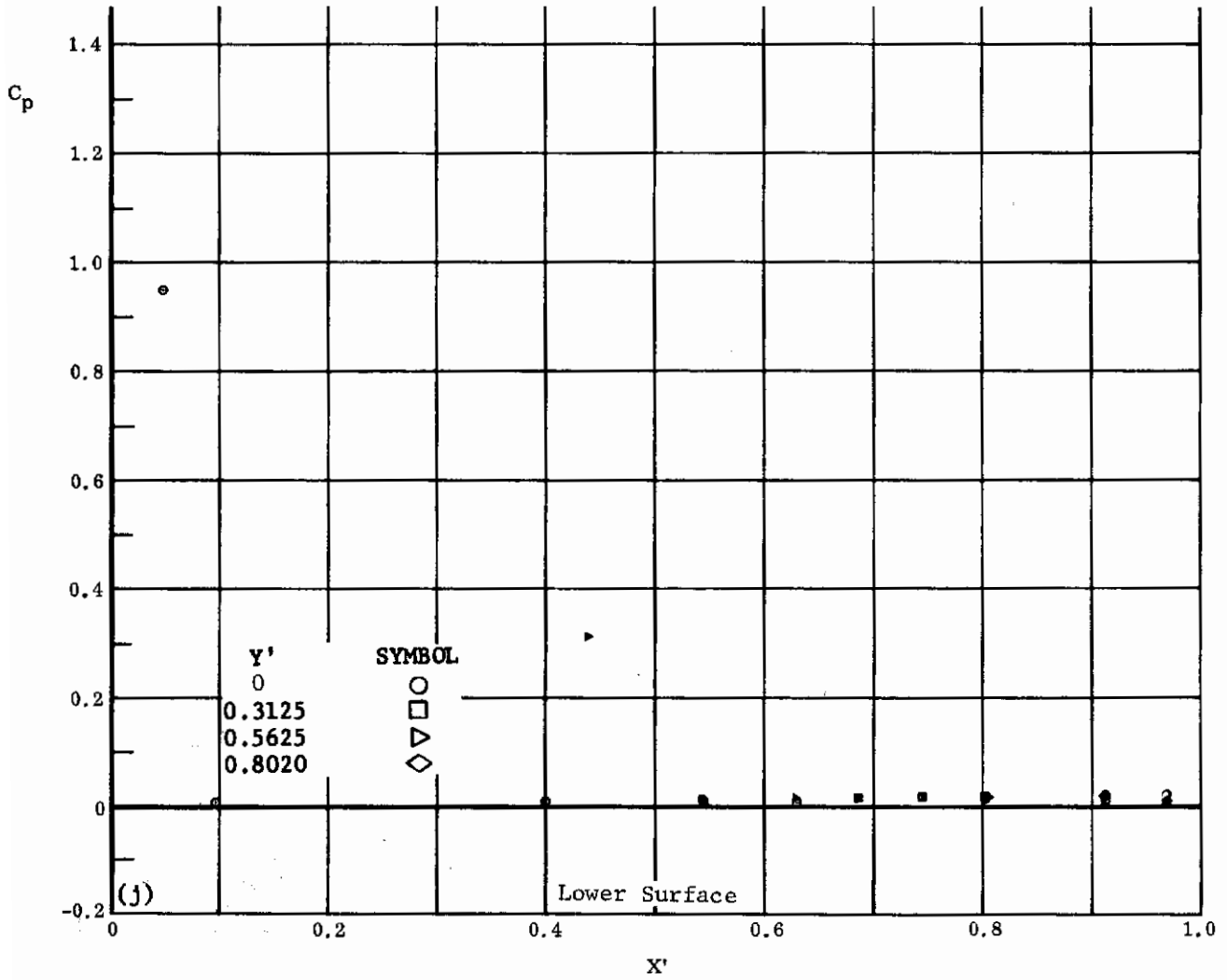

(NONDIMENSIONAL STREAMWISE DISTANCE FROM VIRTUAL APEX)

Fig. 26 Configuration I, $\alpha = -40$, $\delta_2 = \delta_3 = -30$

i) C_p vs. Y' , lower surface

j) C_p vs. X' , lower surface

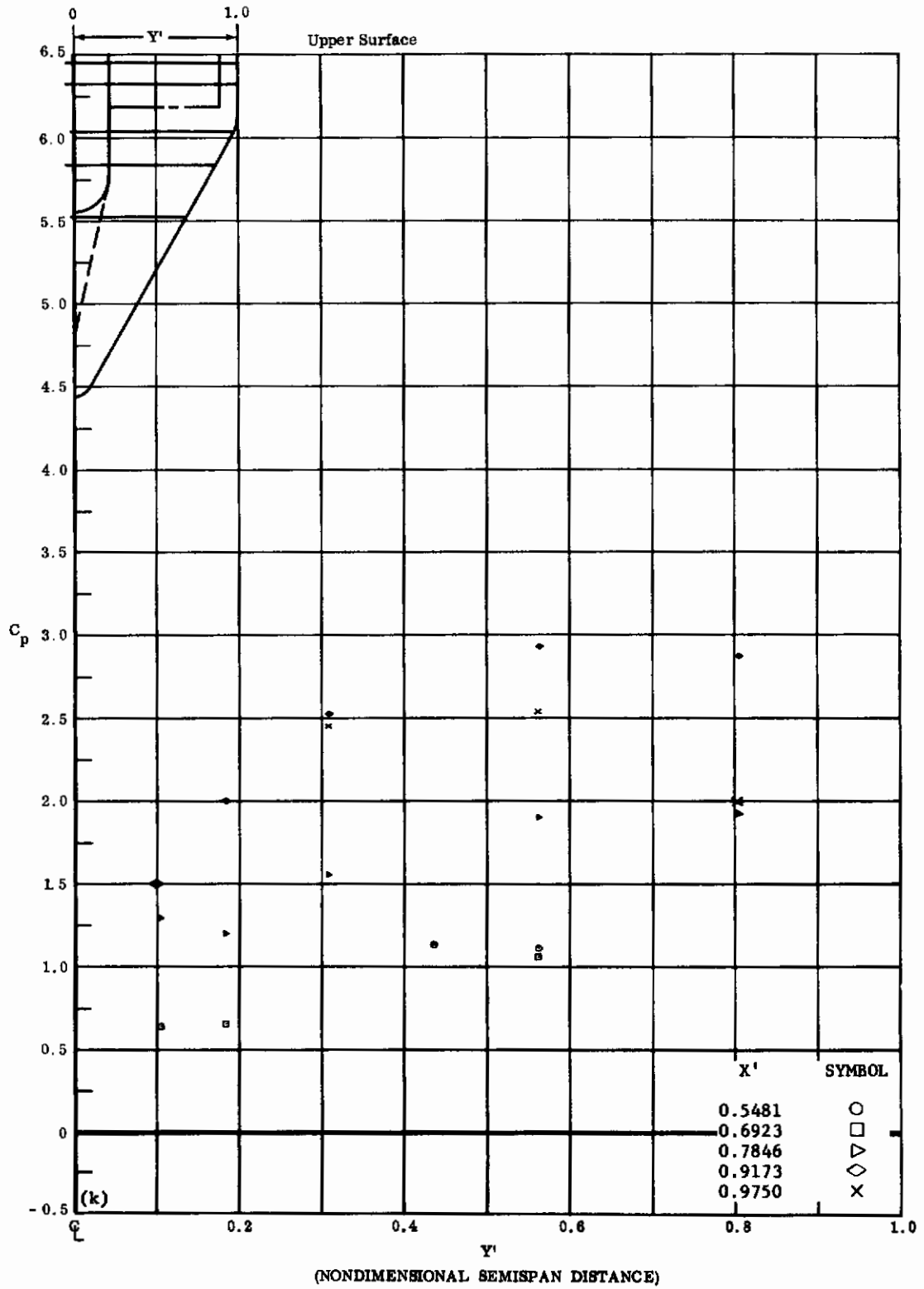
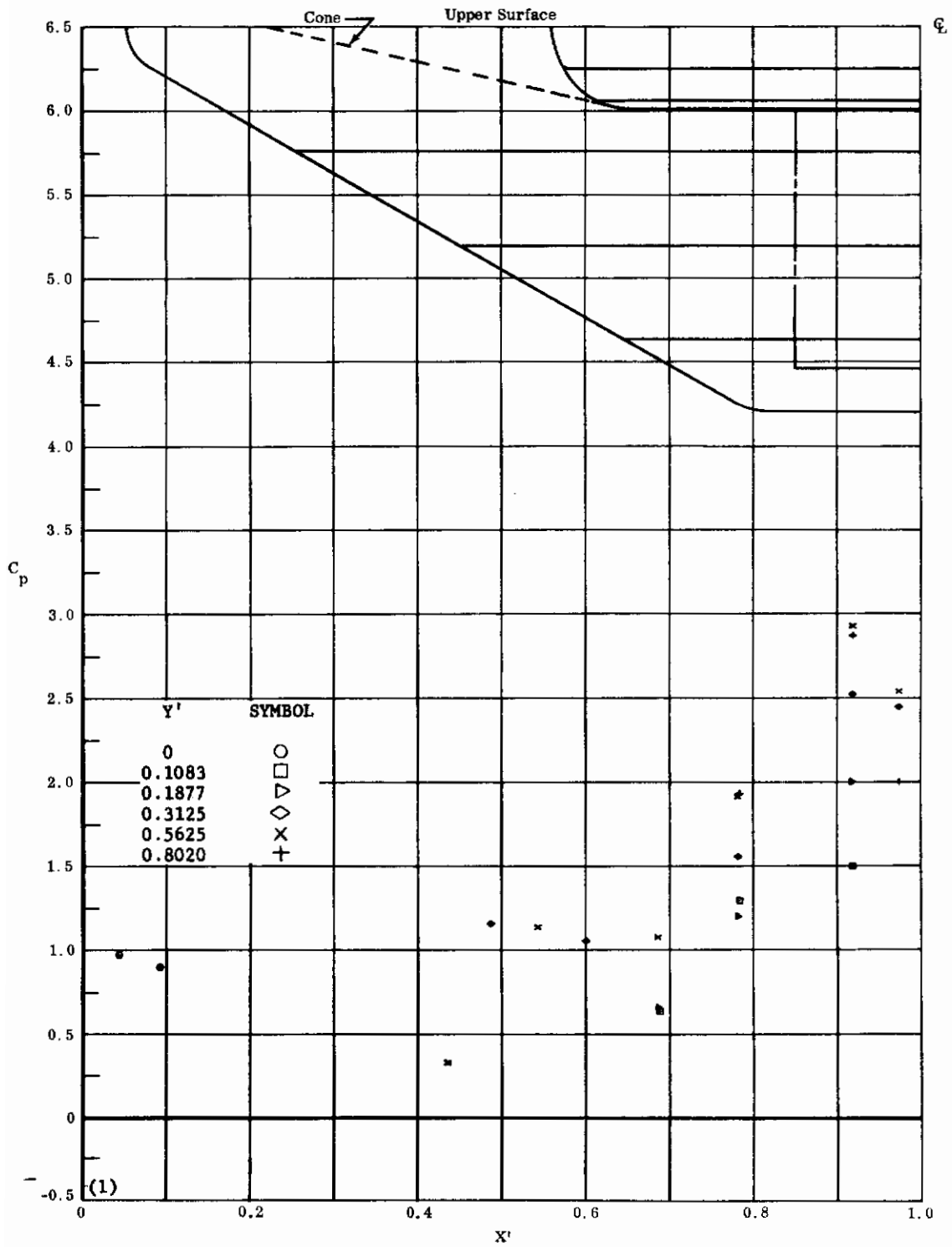

Fig. 26k Configuration I, $\alpha = -40$, $\delta_2 = \delta_3 = -30$

C_p vs. Y' , upper surface

Contraails



(NONDIMENSIONAL STREAMWISE DISTANCE FROM VIRTUAL APEX)

Fig. 261 Configuration I, $\alpha = -40$, $\delta_2 = \delta_3 = -30$

C_p vs. X' , upper surface

Contrails

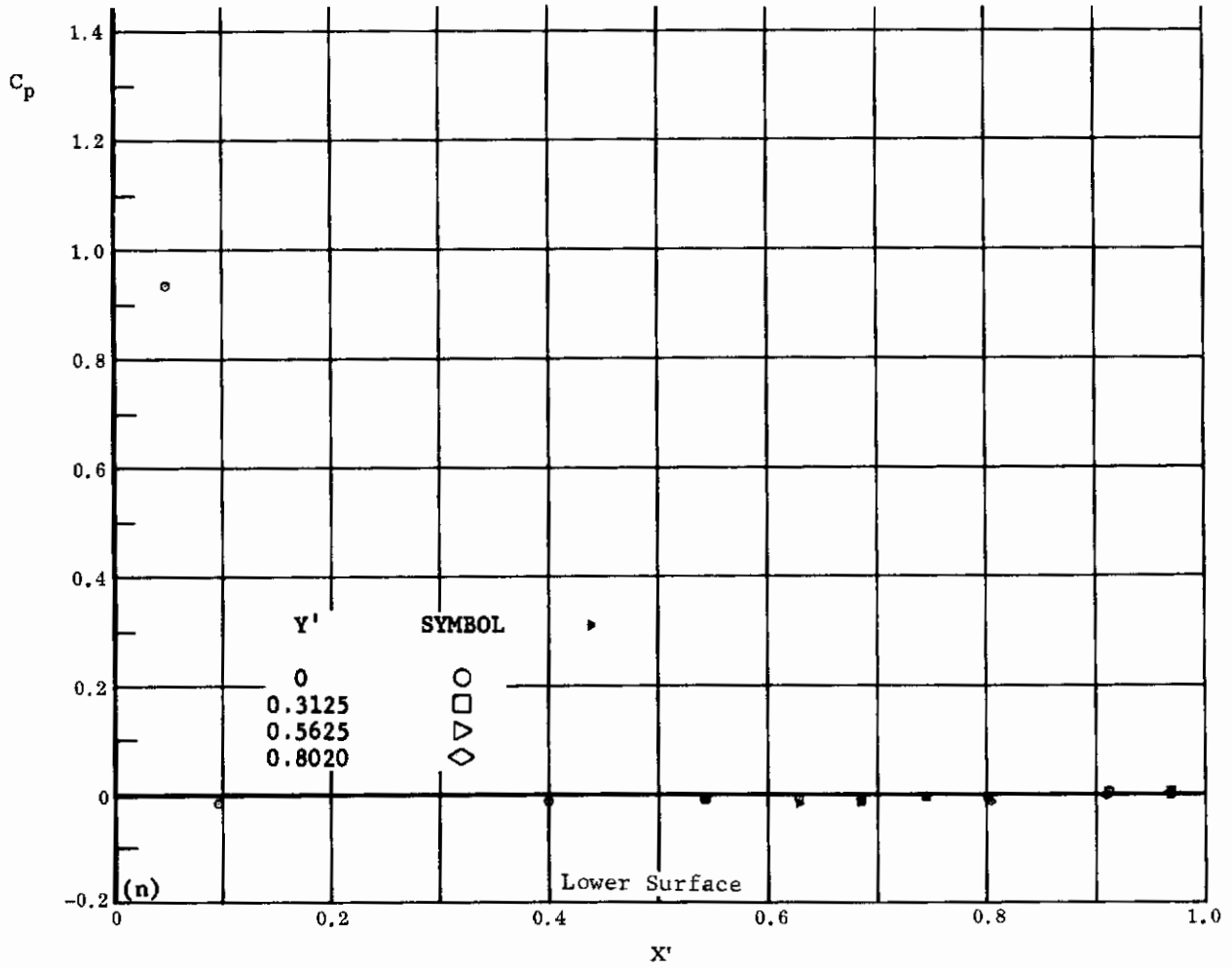
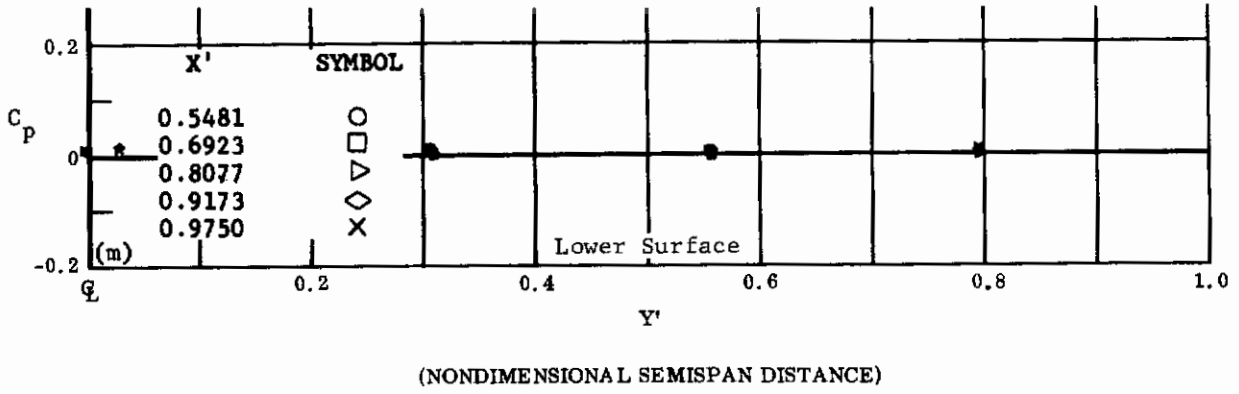

Fig. 26 Configuration I, $\alpha = -40$, $\delta_2 = \delta_3 = -39$

m) C_p vs. Y' , lower surface

n) C_p vs. X' , lower surface

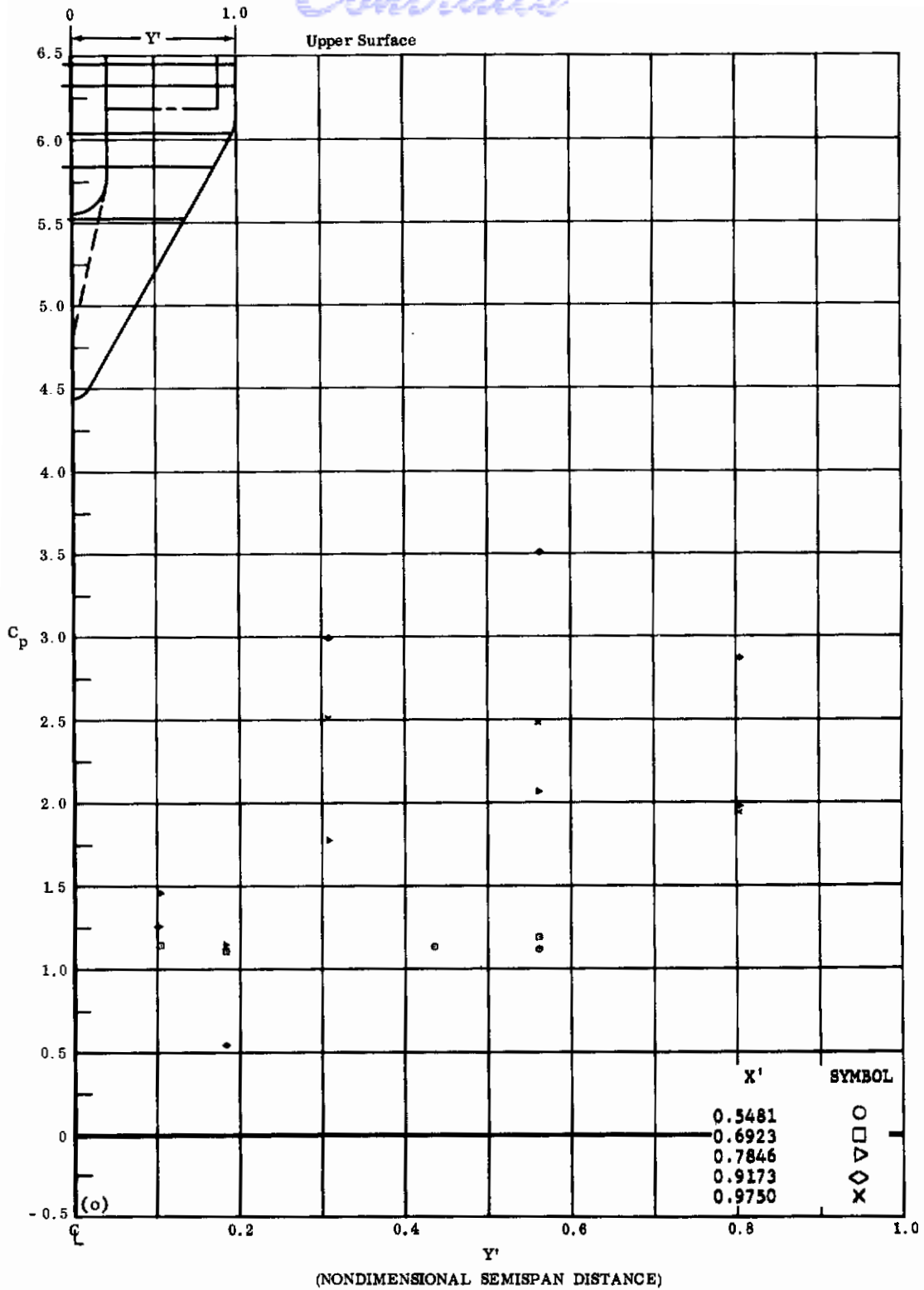
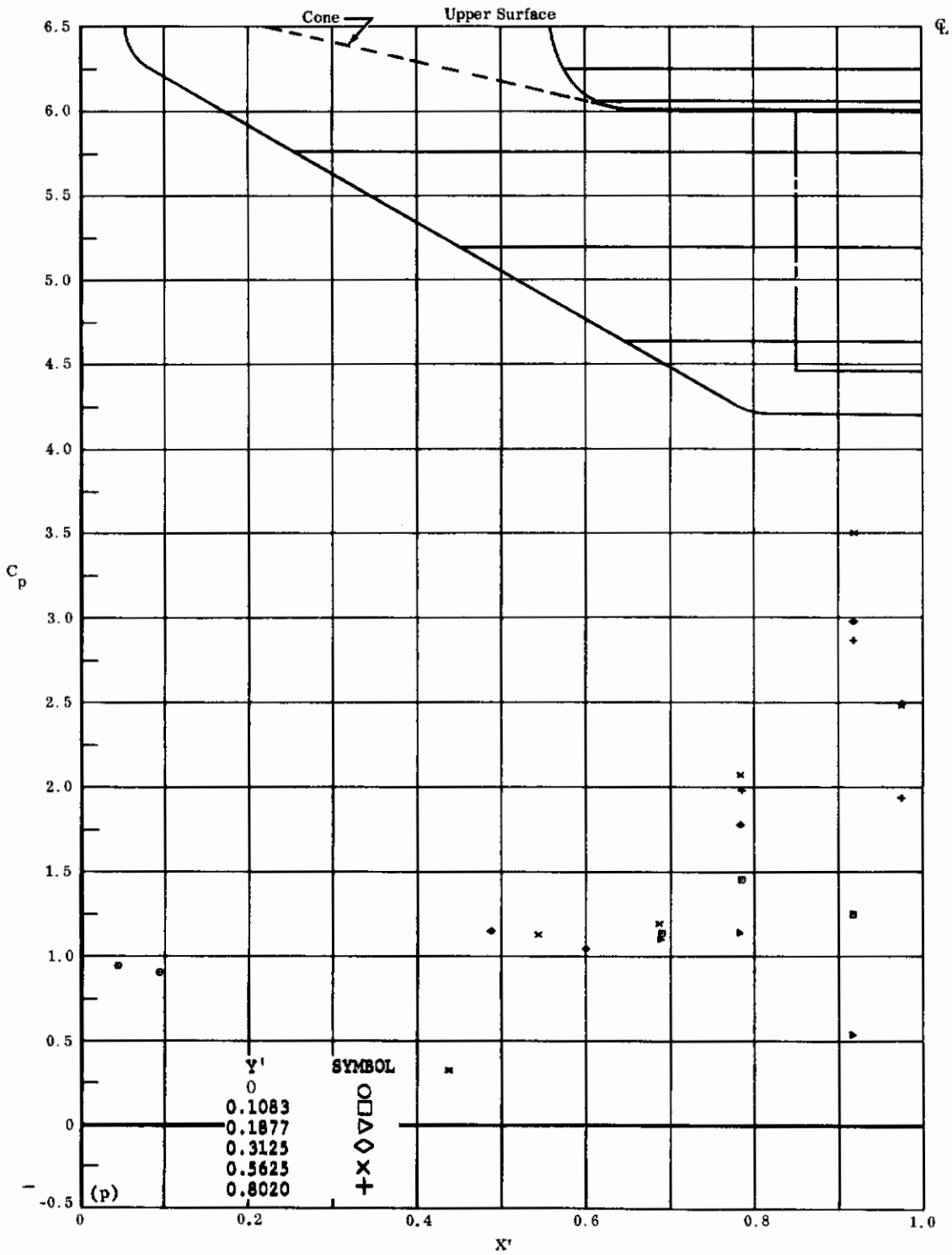

Fig. 26c Configuration I, $\alpha = -40$, $\delta_2 = \delta_3 = -39$

C_p vs. Y' , upper surface

Contrails



(NONDIMENSIONAL STREAMWISE DISTANCE FROM VIRTUAL APEX)

Fig. 26p Configuration I, $\alpha = -40$, $\delta_2 = \delta_3 = -39$

C_p vs. X' , upper surface

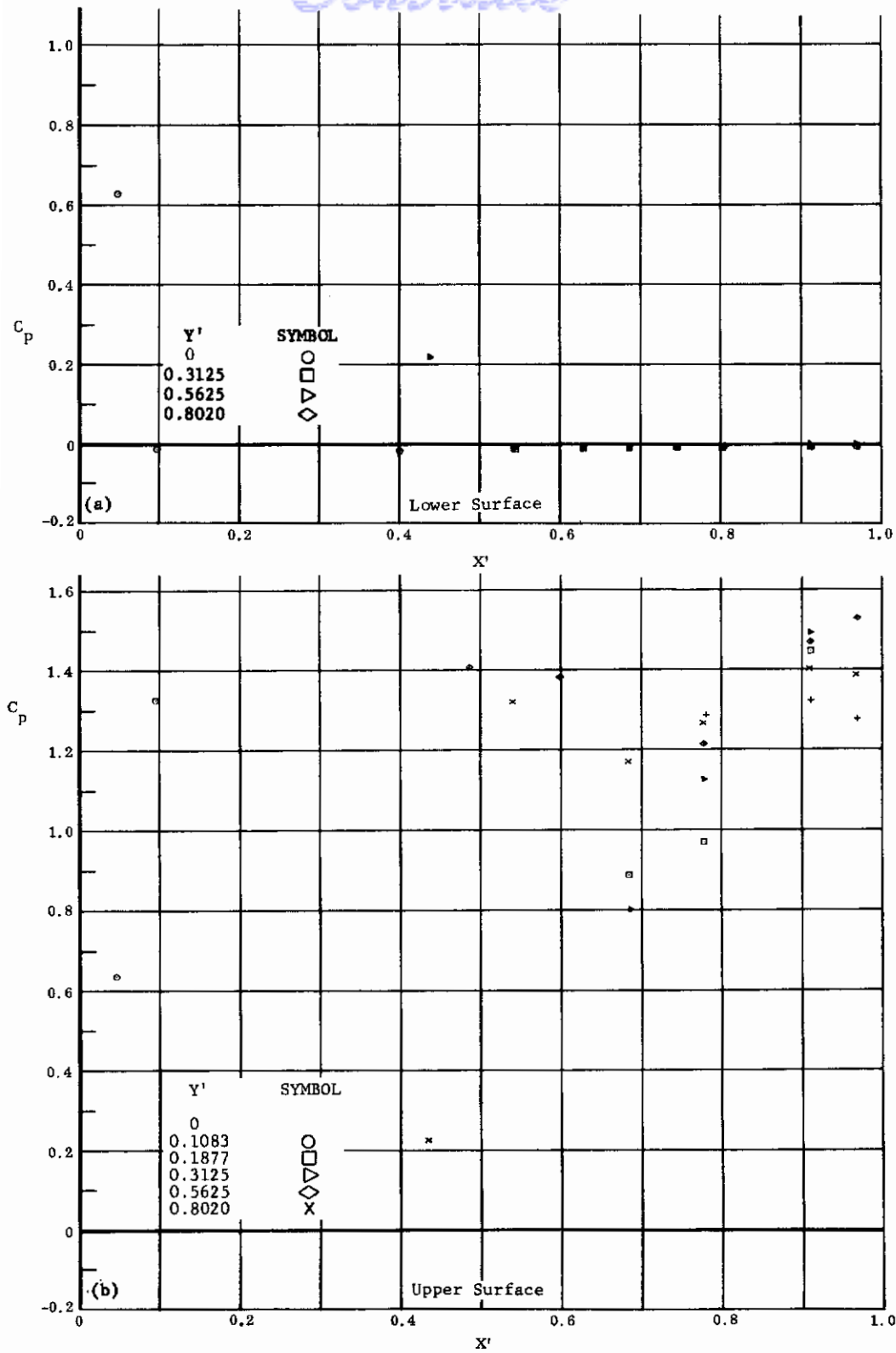

(NONDIMENSIONAL STREAMWISE DISTANCE FROM VIRTUAL APEX)

Fig. 27 Configuration I, $\alpha = -50$, $\delta_2 = \delta_3 = 0$

a) C_p vs. X' , lower surface

b) C_p vs. X' , upper surface

Contrails

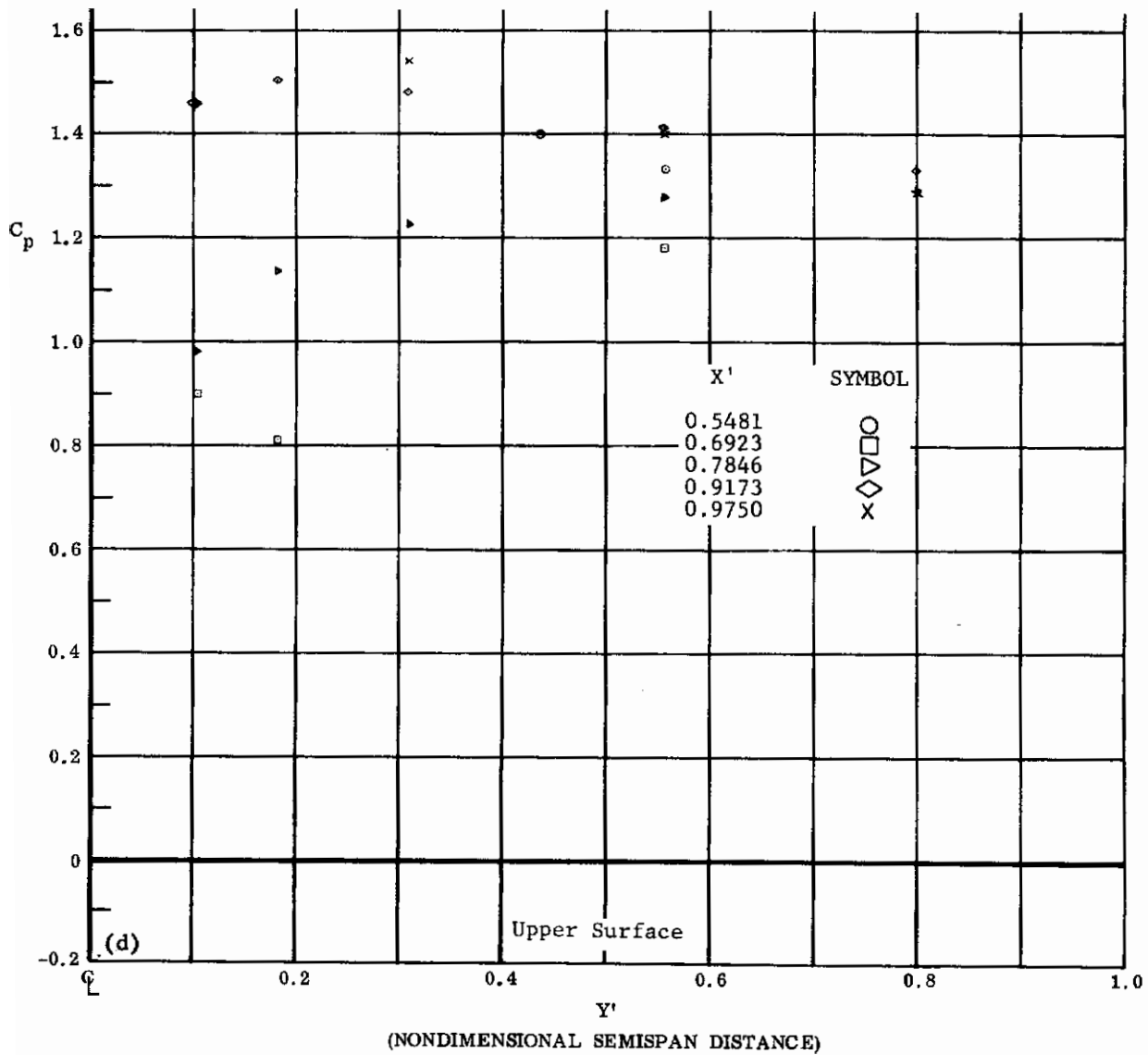
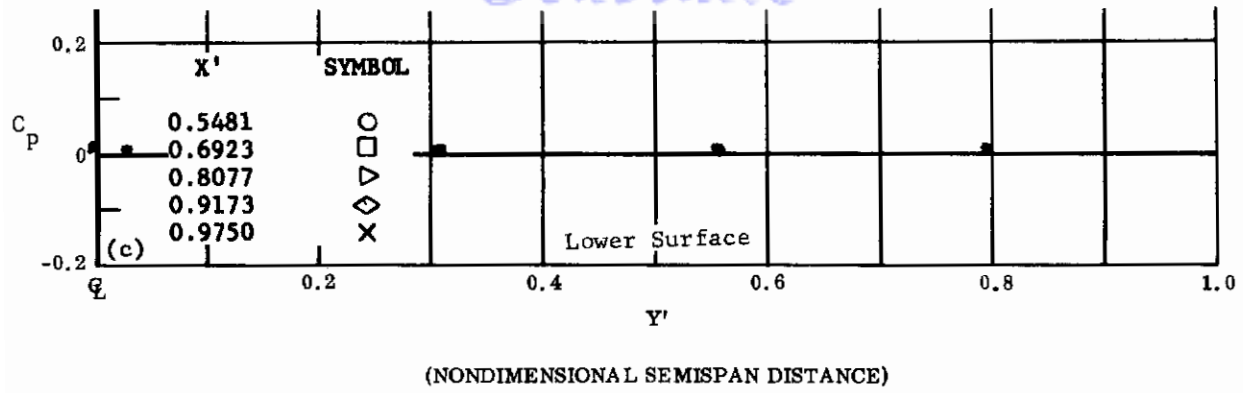
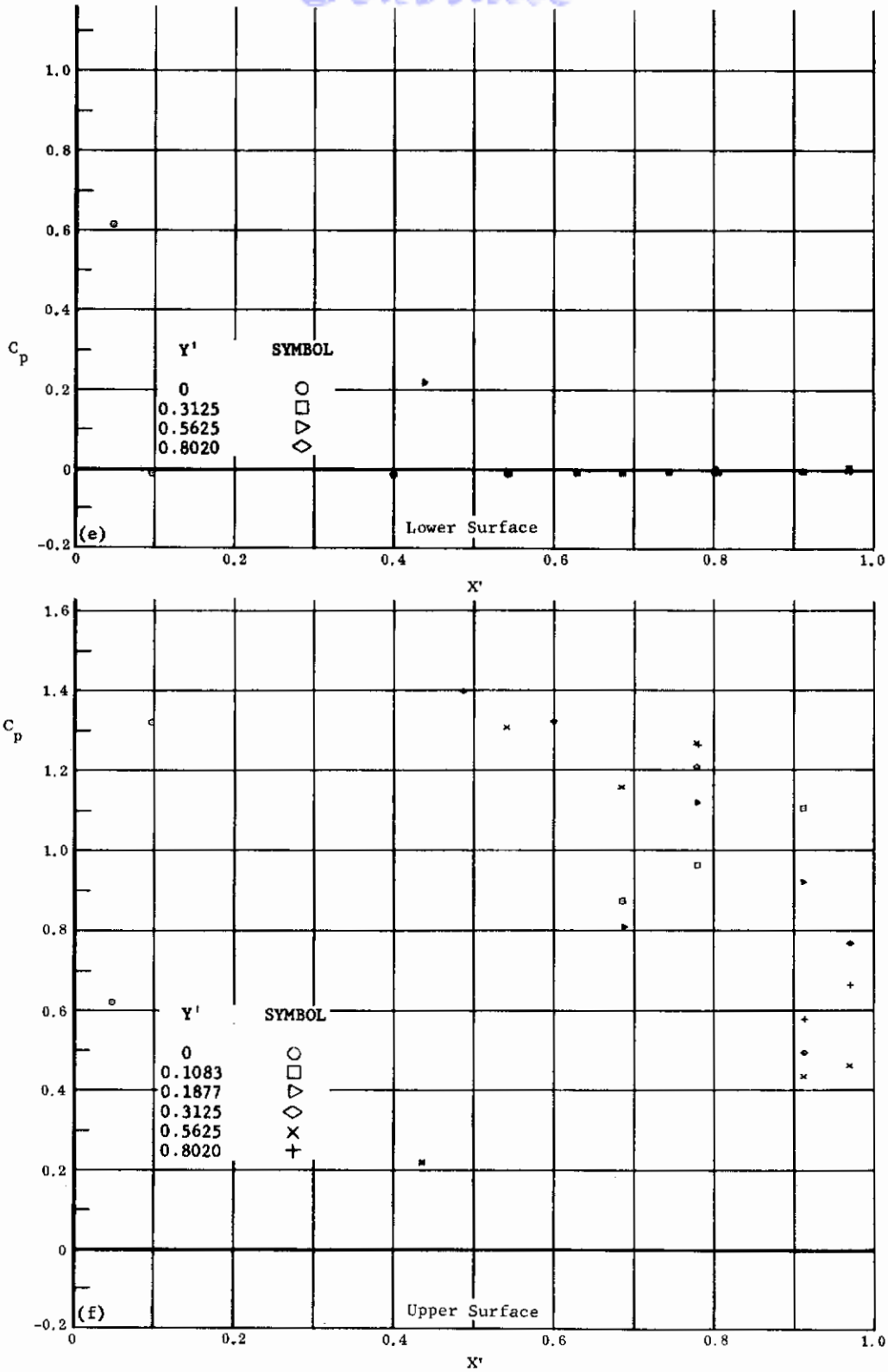

Fig. 27 Configuration I, $\alpha = -50$, $\delta_2 = \delta_3 = 0$

c) C_p vs. Y' , lower surface

d) C_p vs. Y' , upper surface



(NONDIMENSIONAL STREAMWISE DISTANCE FROM VIRTUAL APEX)

Fig. 27 Configuration I, $\alpha = -50$, $\delta_2 = \delta_3 = +20$

e) C_p vs. X' , lower surface

f) C_p vs. X' , upper surface

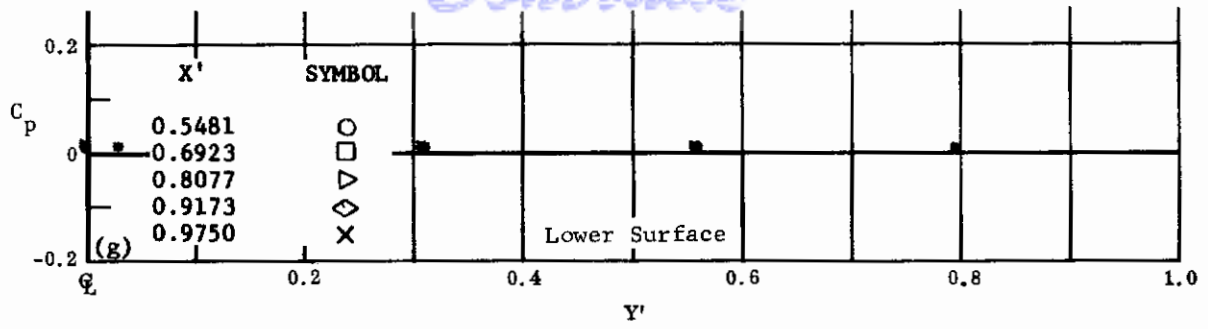

(NONDIMENSIONAL SEMISPAN DISTANCE)

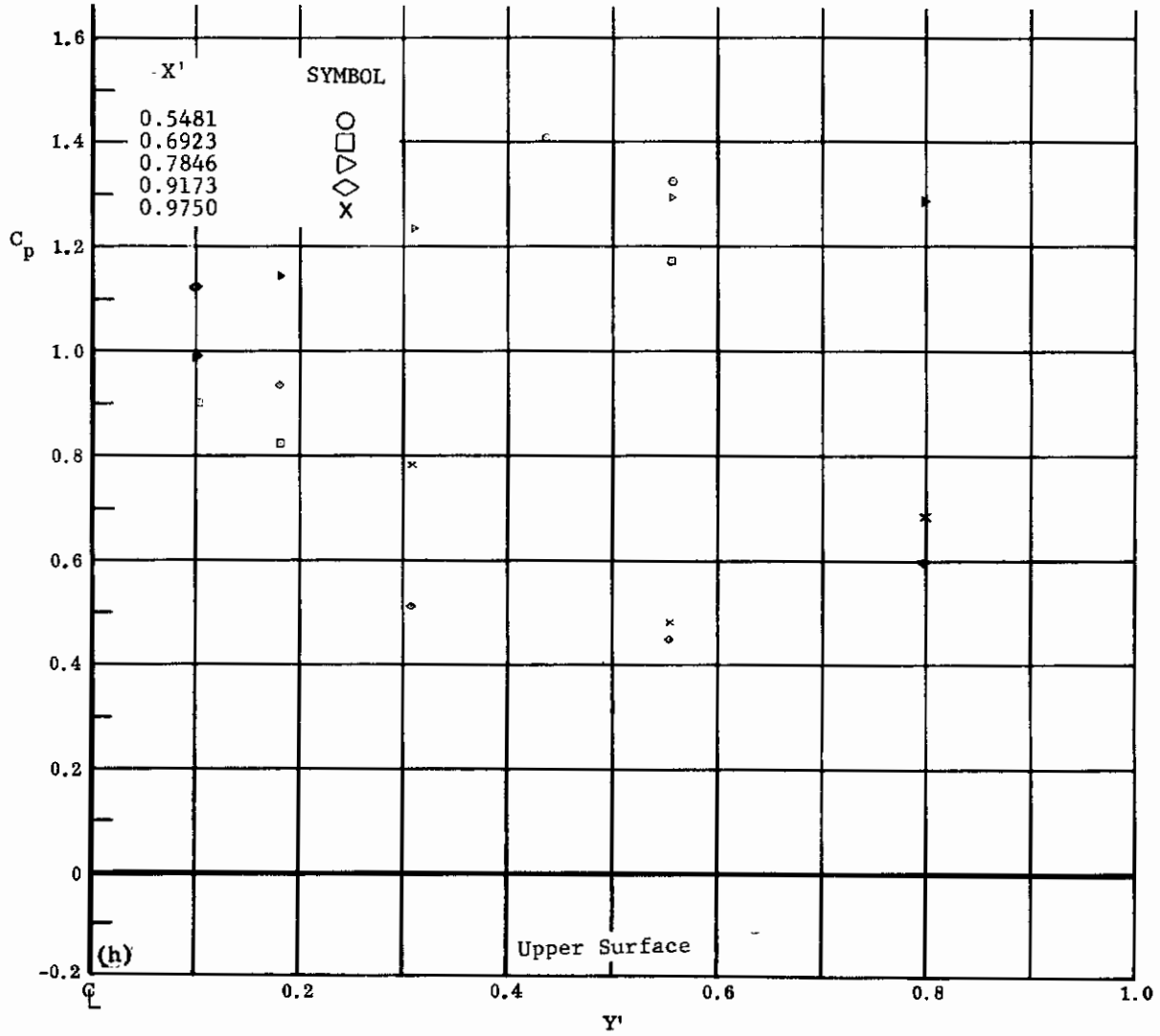

(NONDIMENSIONAL SEMISPAN DISTANCE)

Fig. 27 Configuration I, $\alpha = -50$, $\delta_2 = \delta_3 = +20$

g) C_p vs. Y' , lower surface

h) C_p vs. Y' , upper surface

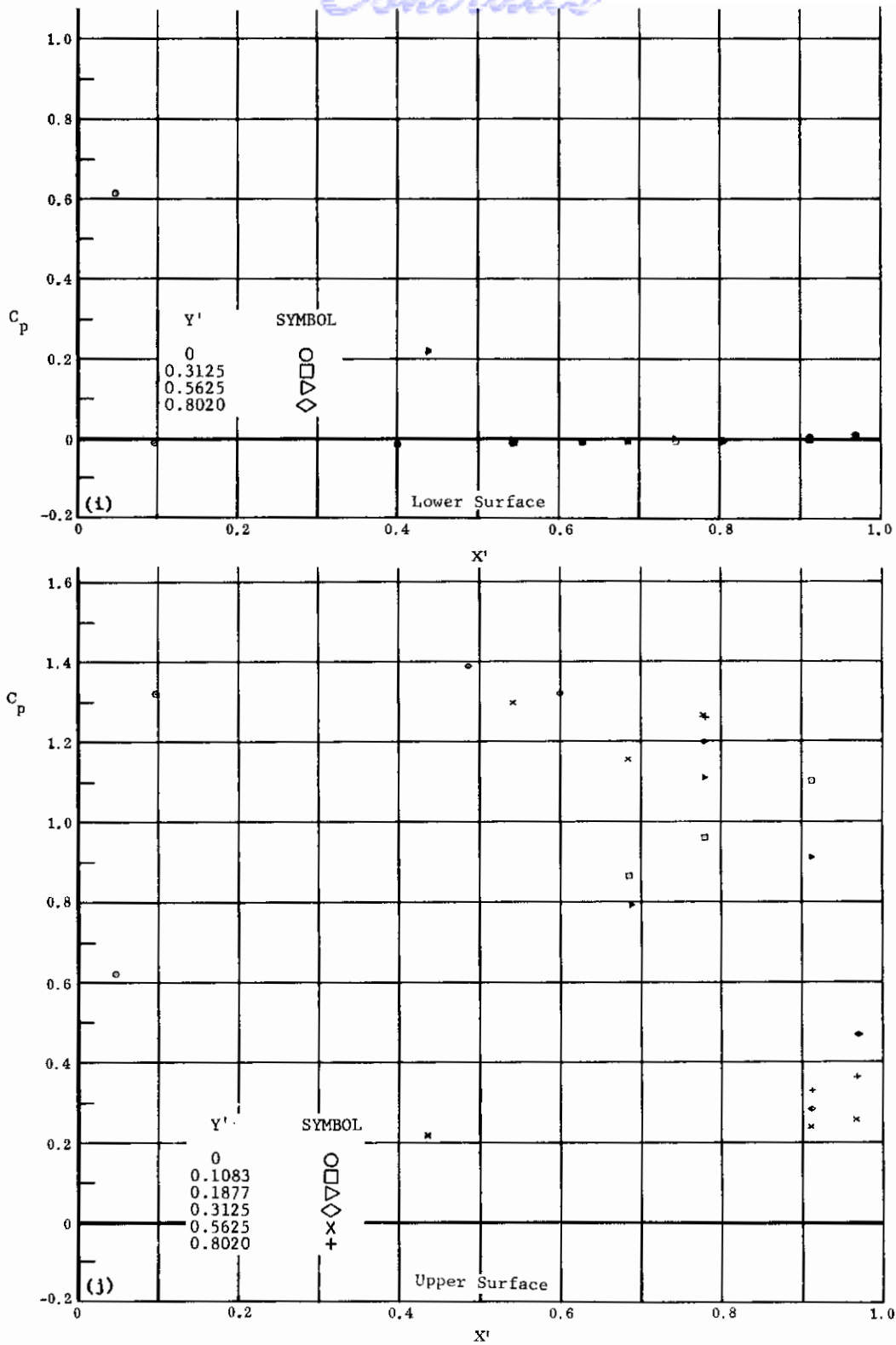

(NONDIMENSIONAL STREAMWISE DISTANCE FROM VIRTUAL APEX)

Fig. 27 Configuration I, $\alpha = -50$, $\delta_2 = \delta_3 = +30$

- i) C_p vs. X' , lower surface
- j) C_p vs. X' , upper surface

Contrails

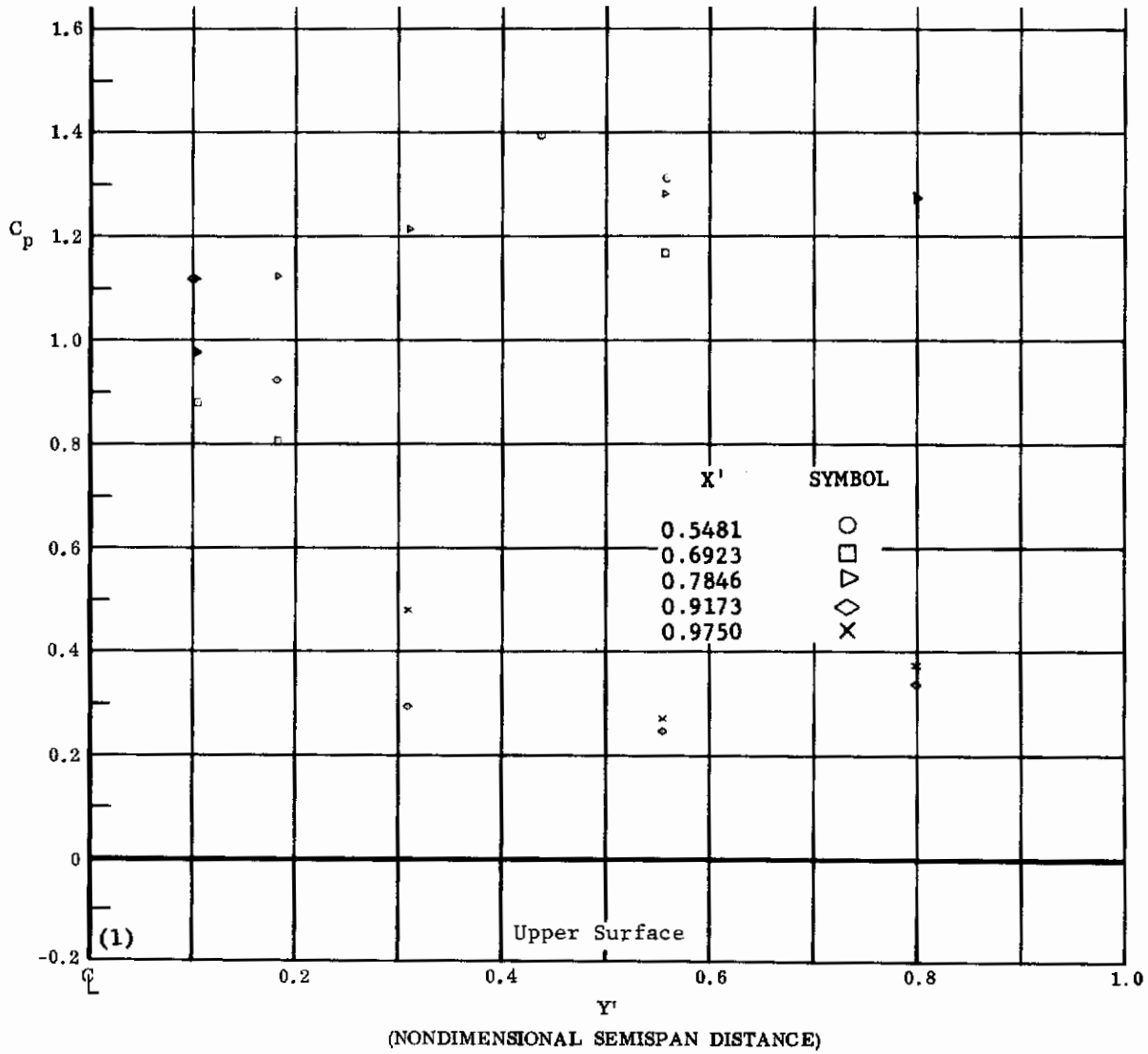
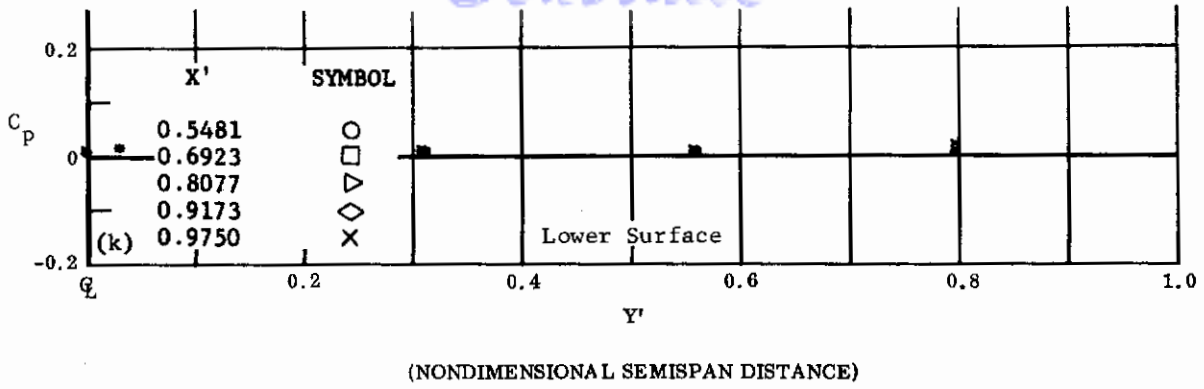
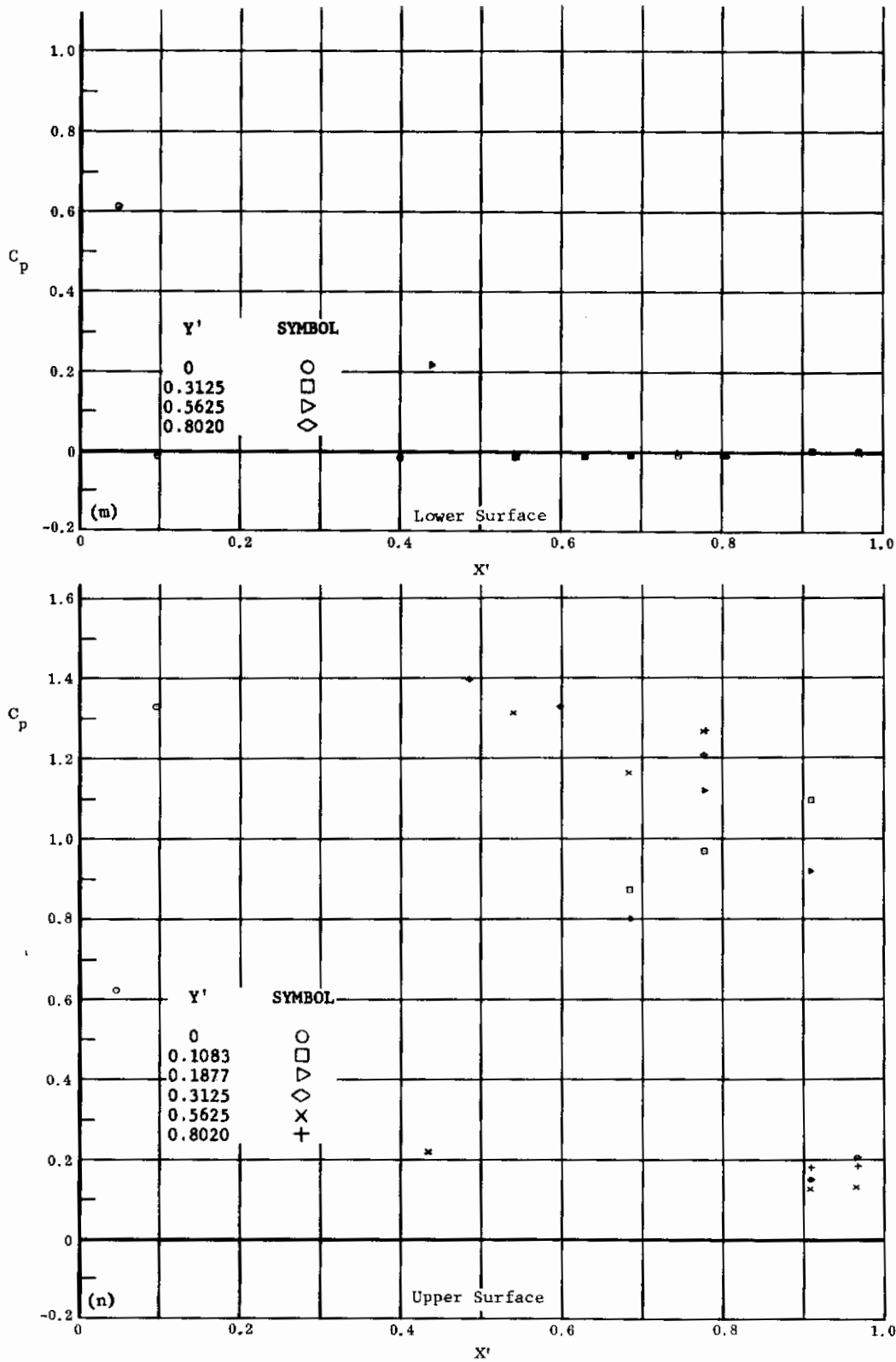

Fig. 27 Configuration I, $\alpha = -50$, $\delta_2 = \delta_3 = +30$

k) C_p vs. Y' , lower surface

l) C_p vs. Y' , upper surface

Contrails



(NONDIMENSIONAL STREAMWISE DISTANCE FROM VIRTUAL APEX)

Fig. 27 Configuration I, $\alpha = -50$, $\delta_2 = \delta_3 = +39$

m) C_p vs. X' , lower surface

n) C_p vs. X' , upper surface

Contrails

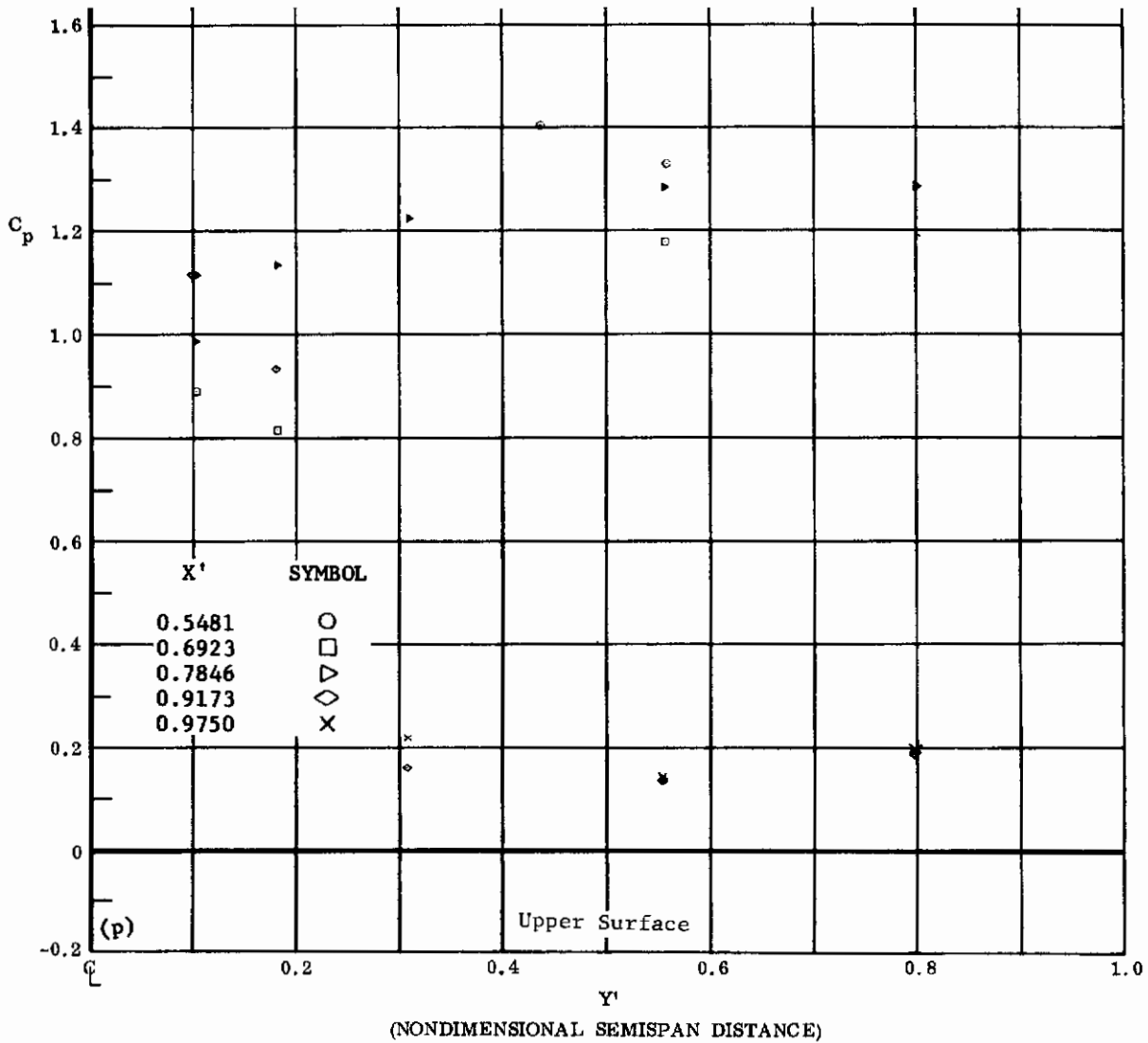
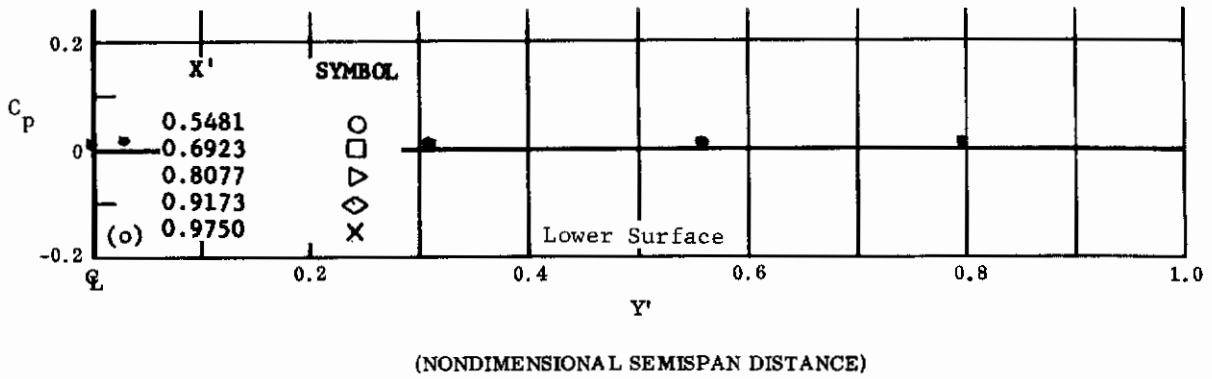
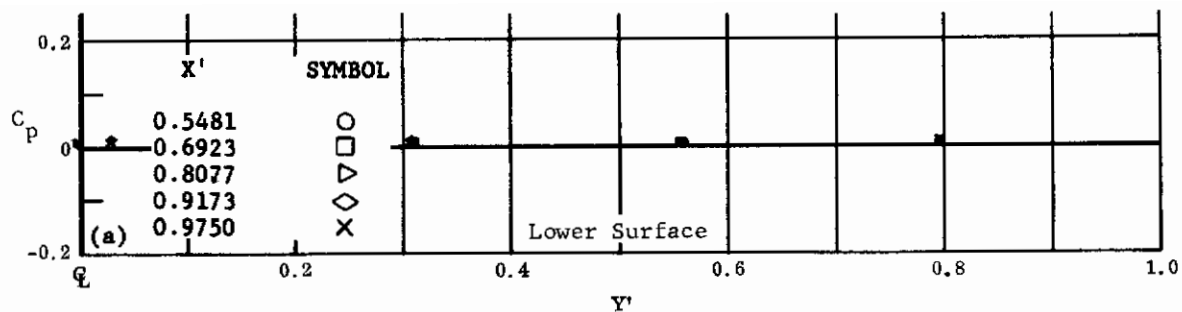

Fig. 27 Configuration I, $\alpha = -50$, $\delta_2 = \delta_3 = +39$

o) C_p vs. Y' , lower surface

p) C_p vs. Y' , upper surface

Contrails



(NONDIMENSIONAL SEMISPAN DISTANCE)

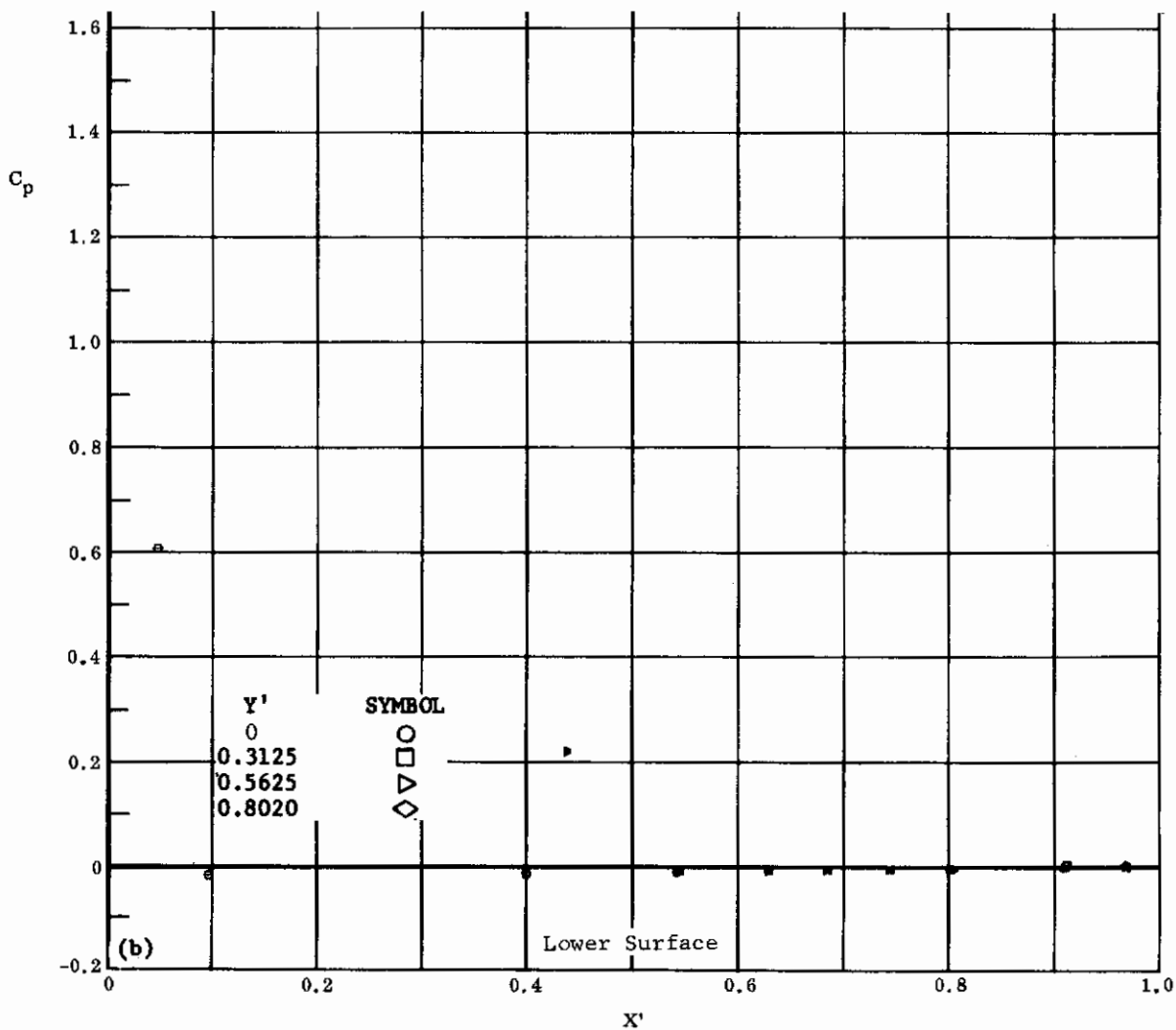

(NONDIMENSIONAL STREAMWISE DISTANCE FROM VIRTUAL APEX)

Fig. 28 Configuration I, $\alpha = -50$, $\delta_2 = \delta_3 = -10$

- a) C_p vs. Y' , lower surface
- b) C_p vs. X' , lower surface

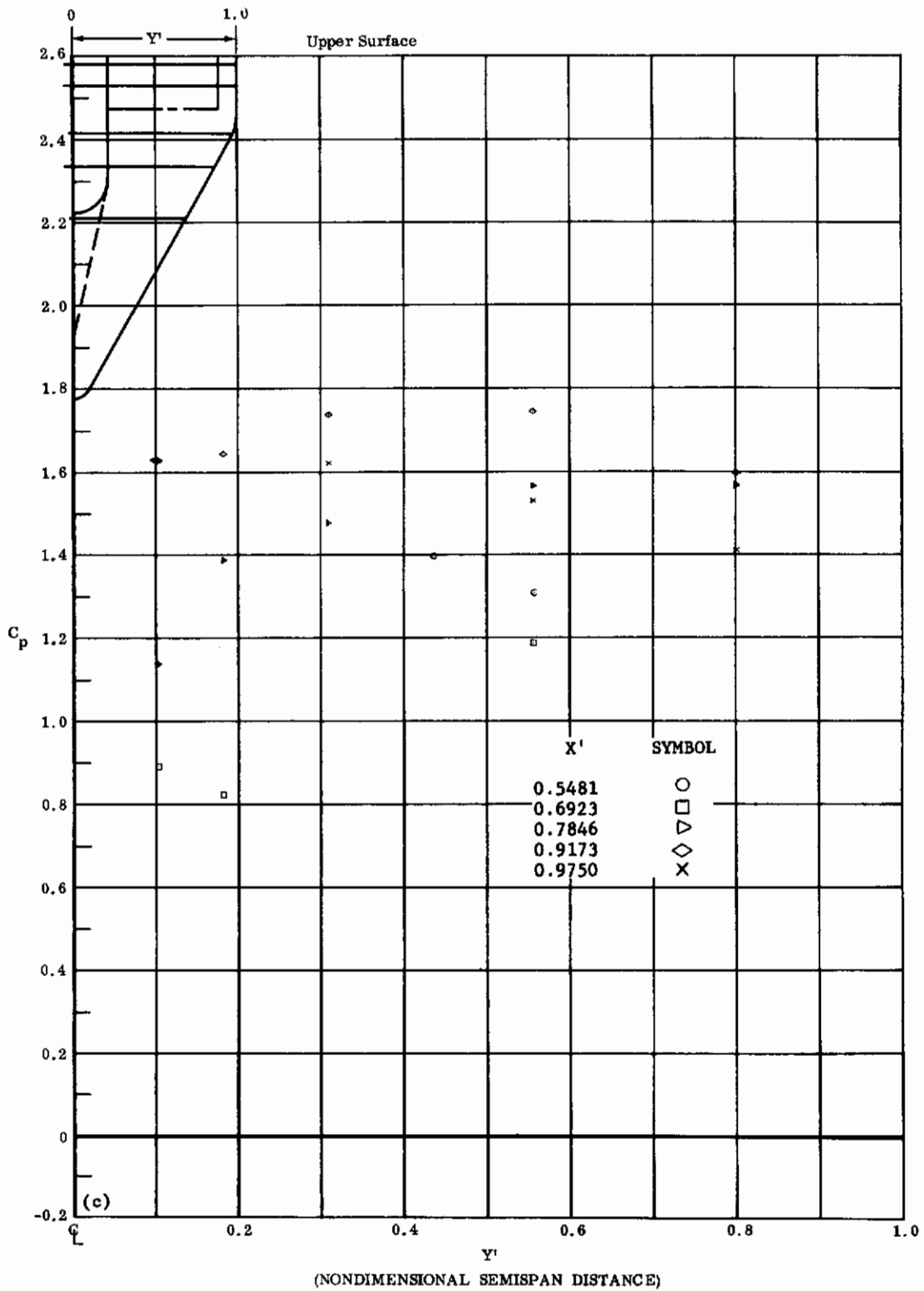
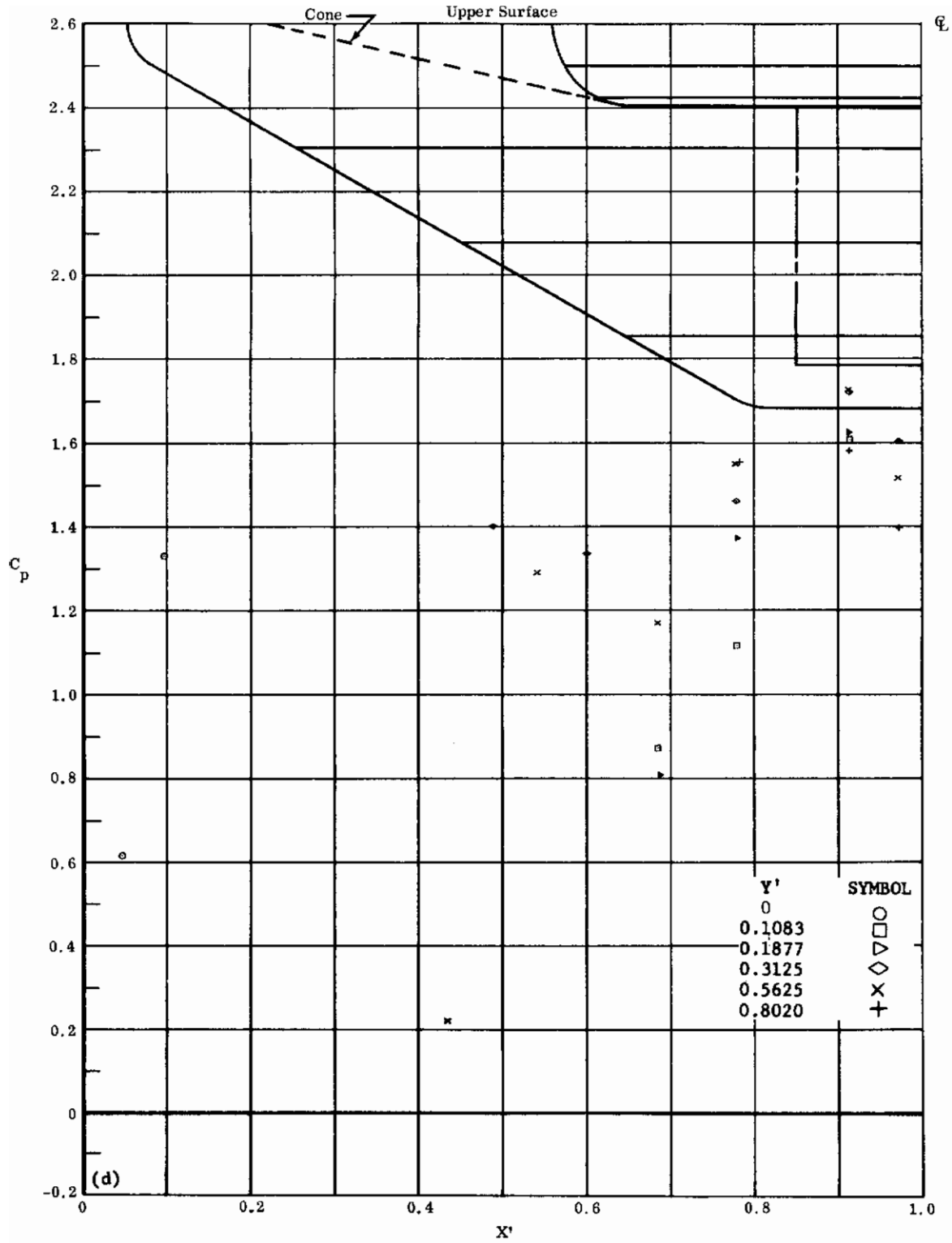

Fig. 28c Configuration I, $\alpha = -50$, $\delta_2 = \delta_3 = -10$

C_p vs. Y' , upper surface

Contraails



(NONDIMENSIONAL STREAMWISE DISTANCE FROM VIRTUAL APEX)

Fig. 28d Configuration I, $\alpha = -50$, $\delta_2 = \delta_3 = -10$

C_p vs. X' , upper surface

Contrails

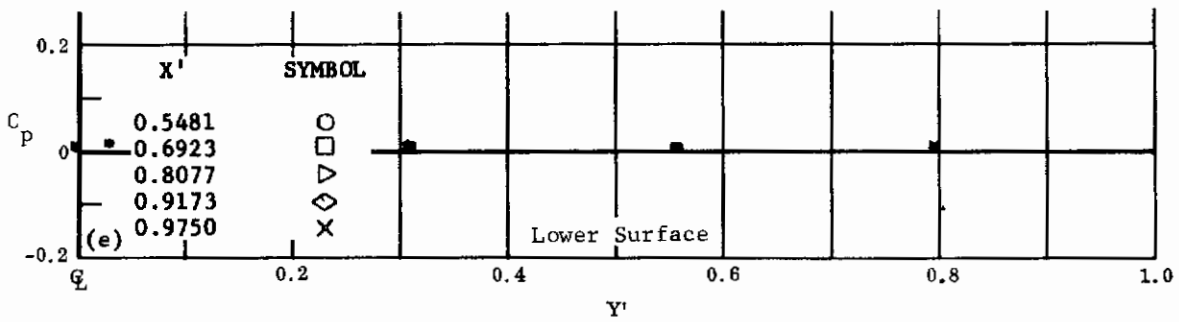

(NONDIMENSIONAL SEMISPAN DISTANCE)

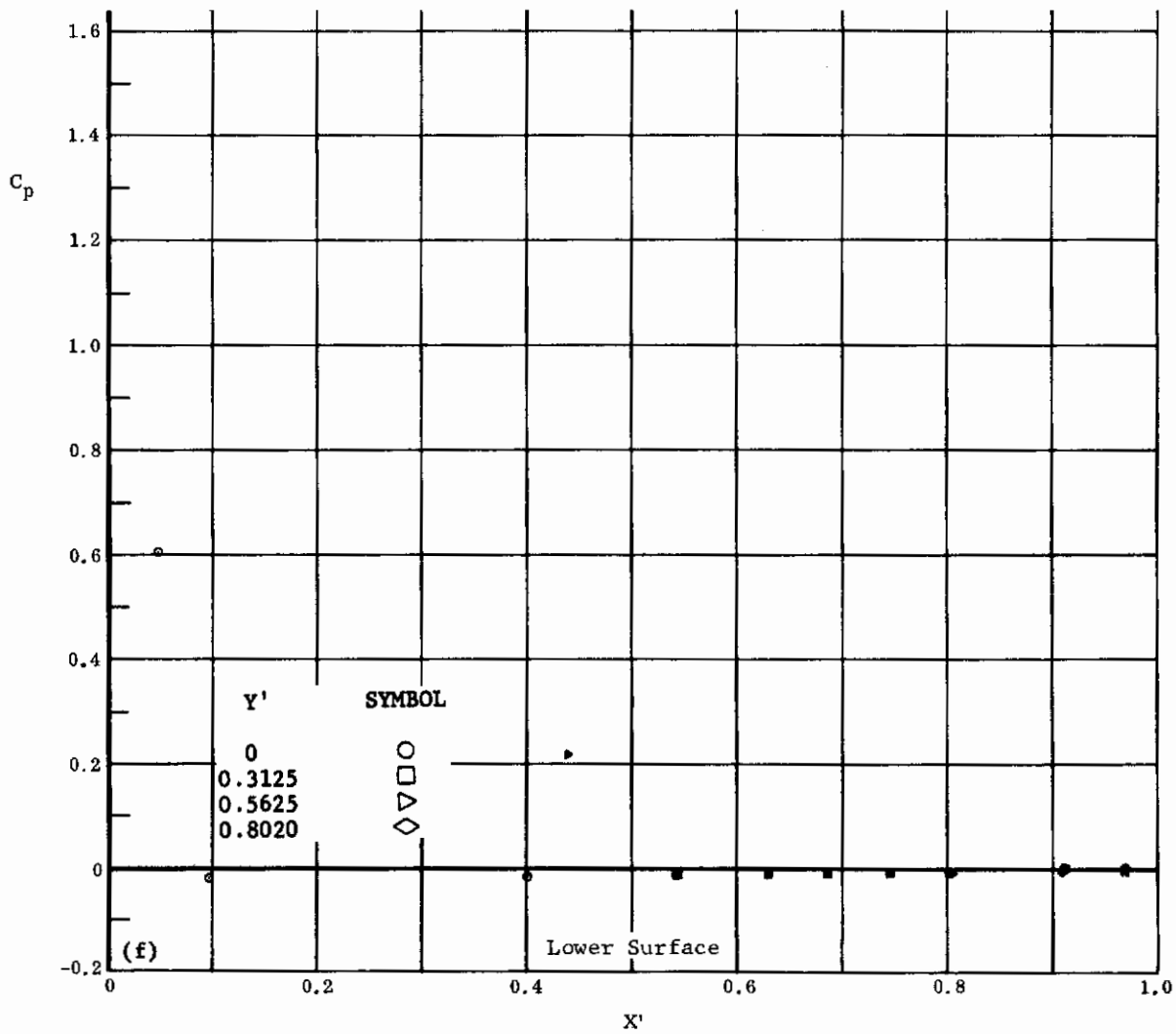

(NONDIMENSIONAL STREAMWISE DISTANCE FROM VIRTUAL APEX)

Fig. 28 Configuration I, $\alpha = -50$, $\delta_2 = \delta_3 = -20$

e) C_p vs. Y' , lower surface

f) C_p vs. X' , lower surface

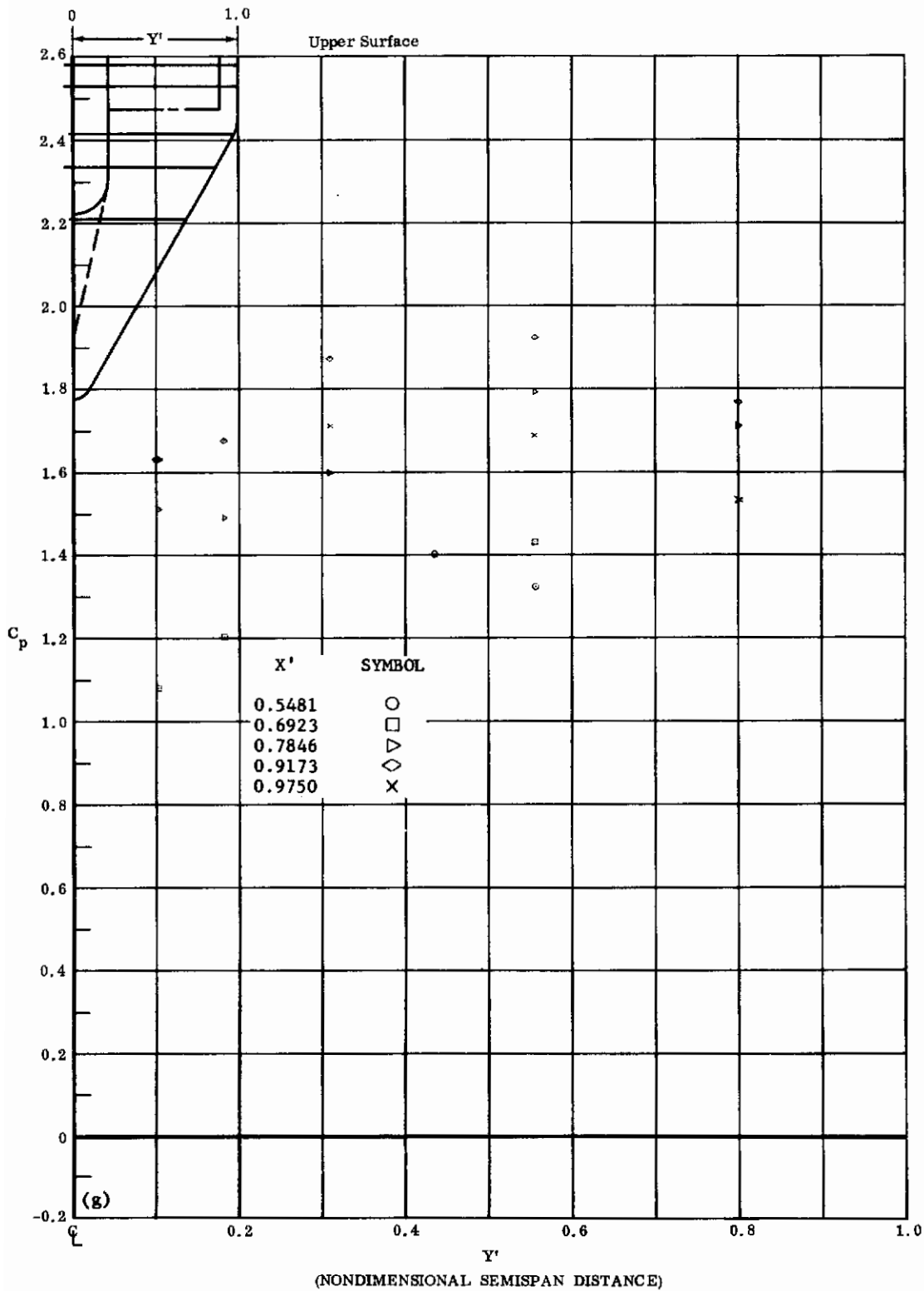
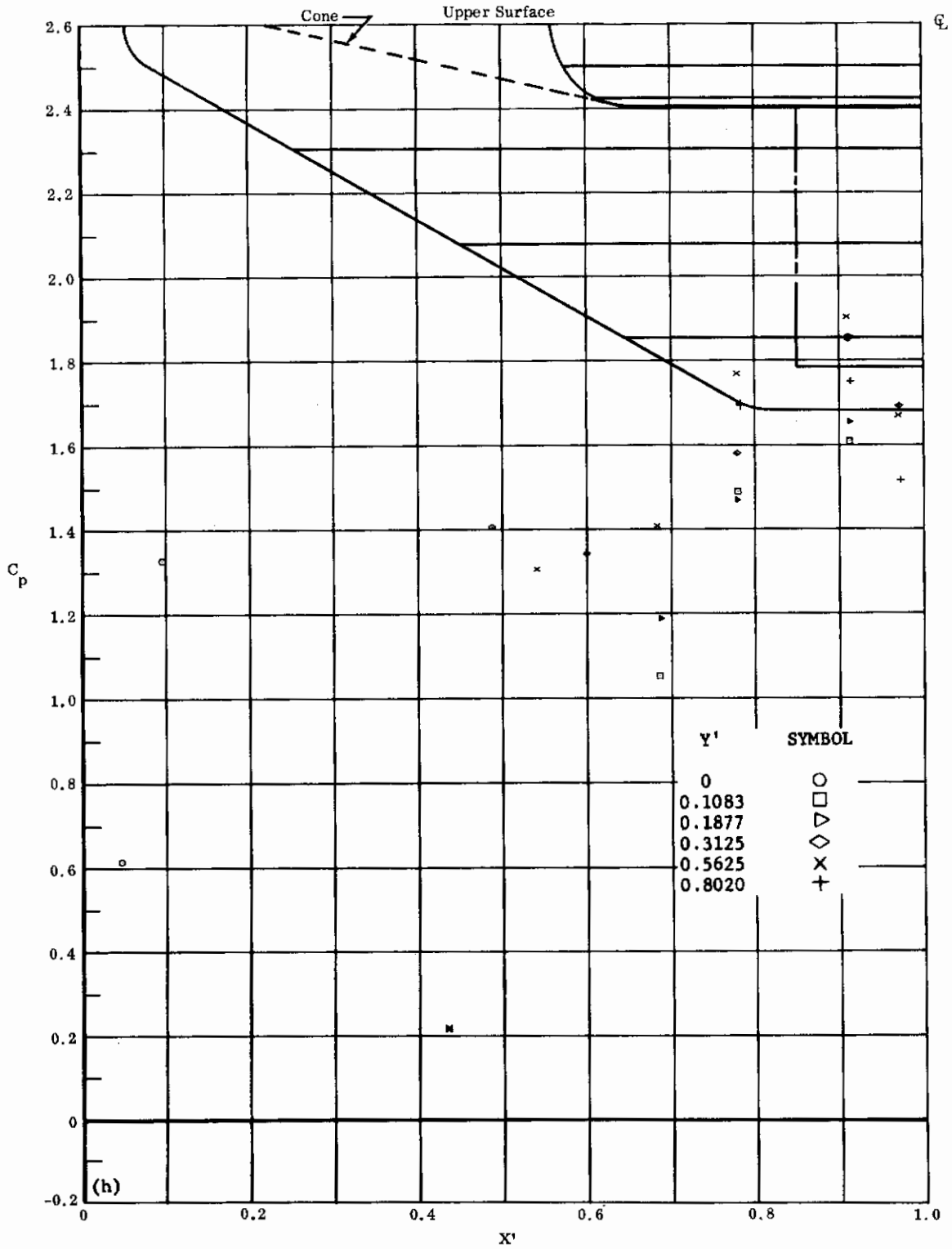

Fig. 28g Configuration I, $\alpha = -50$, $\delta_2 = \delta_3 = -20$

C_p vs. Y' , upper surface



(NONDIMENSIONAL STREAMWISE DISTANCE FROM VIRTUAL APEX)

Fig. 28h Configuration I, $\alpha = -50$, $\delta_2 = \delta_3 = -20$

C_p vs. X' , upper surface

Contrails

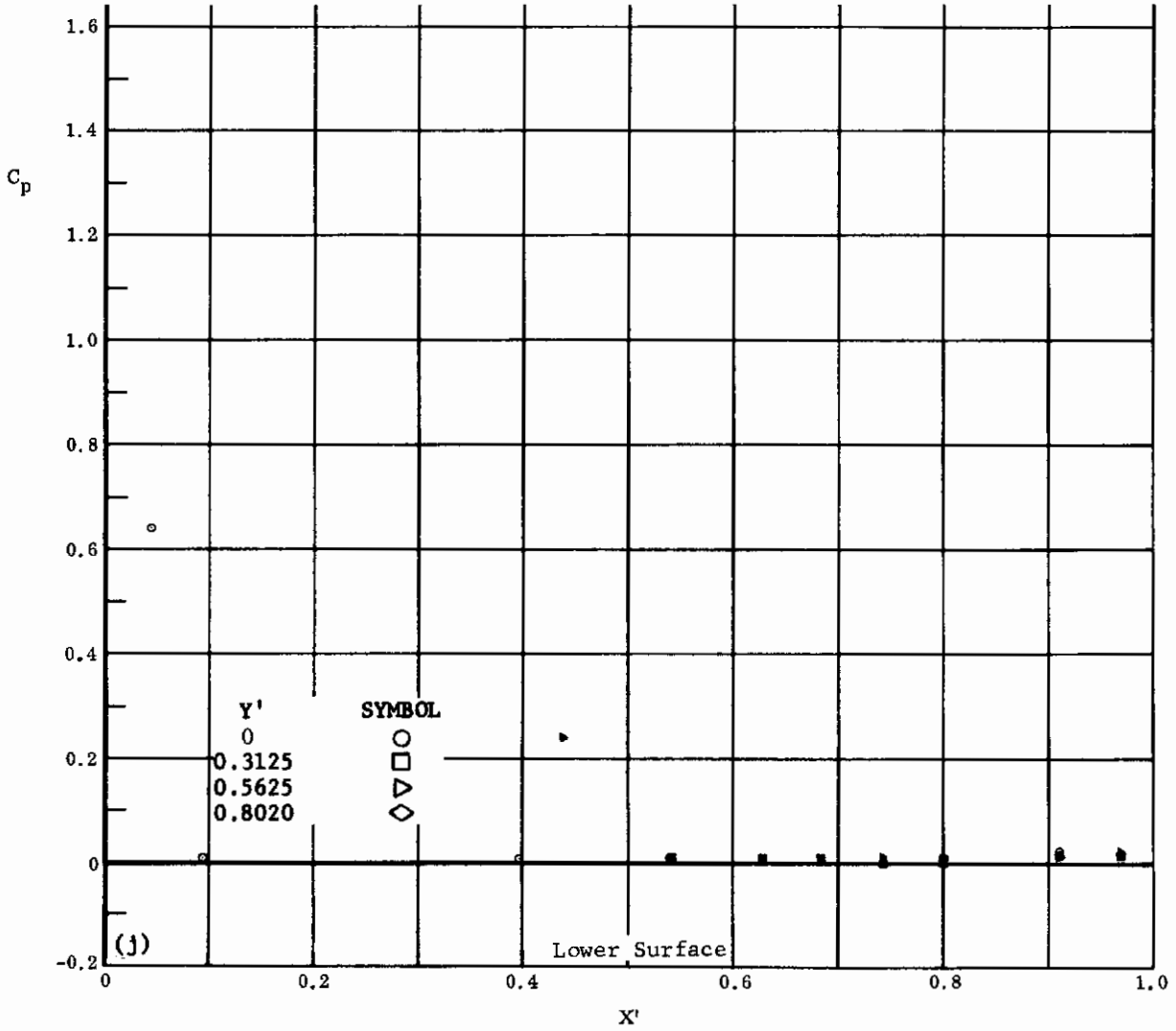
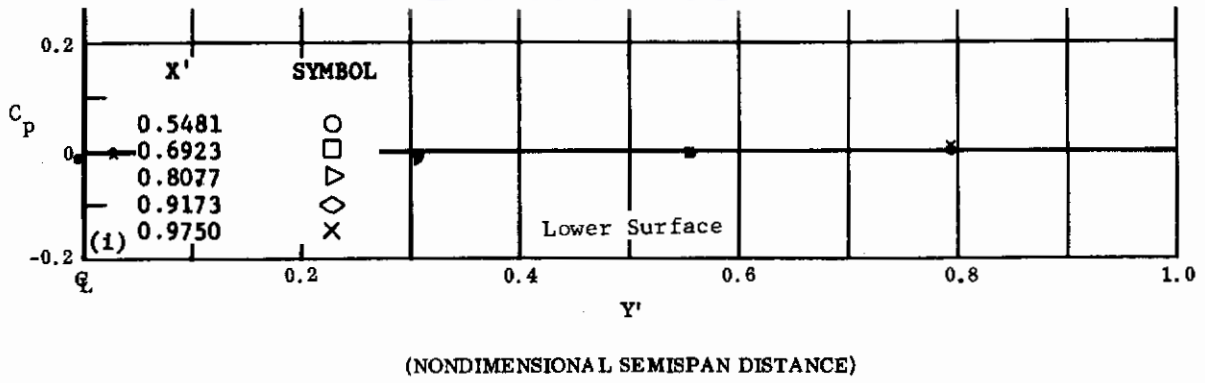

Fig. 28 Configuration I, $\alpha = -50$, $\delta_2 = \delta_3 = -30$

- i) C_p vs. Y' , lower surface
- j) C_p vs. X' , lower surface

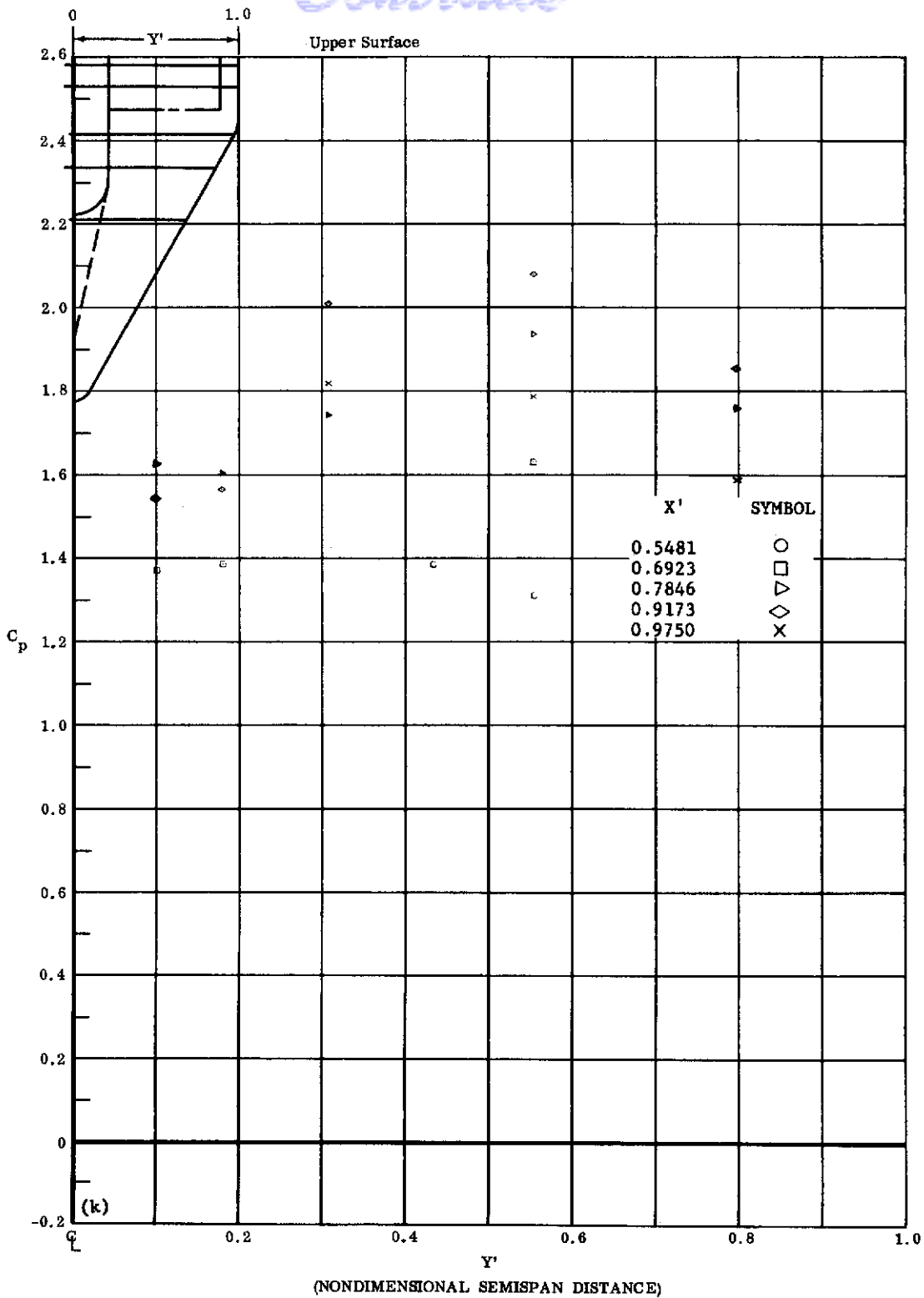
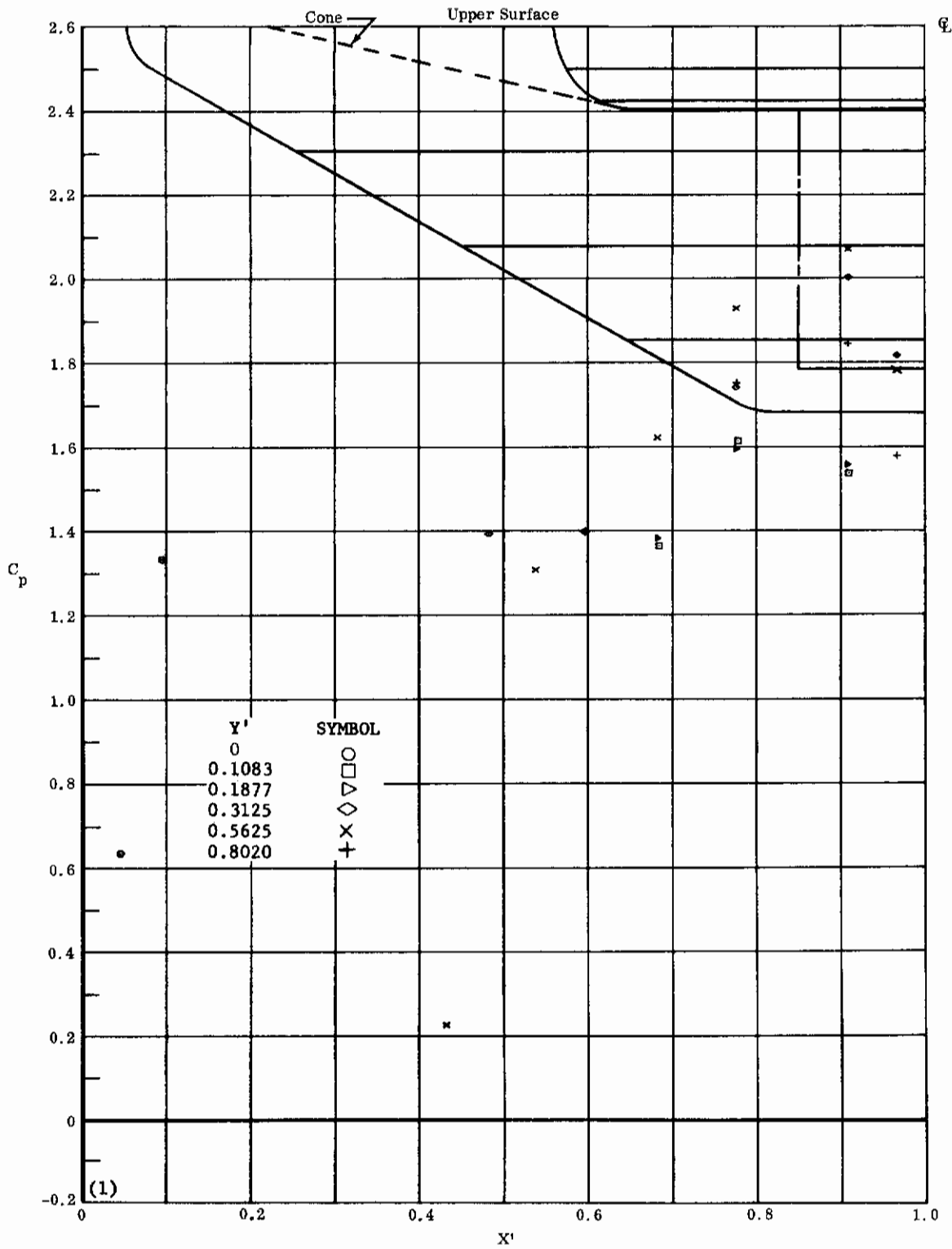

Fig. 28k Configuration I, $\alpha = -50$, $\delta_2 = \delta_3 = -30$

C_p vs. Y' , upper surface

Contraails



(NONDIMENSIONAL STREAMWISE DISTANCE FROM VIRTUAL APEX)

Fig. 281 Configuration I, $\alpha = -50$, $\delta_2 = \delta_3 = -30$

C_p vs. X' , upper surface

Contrails

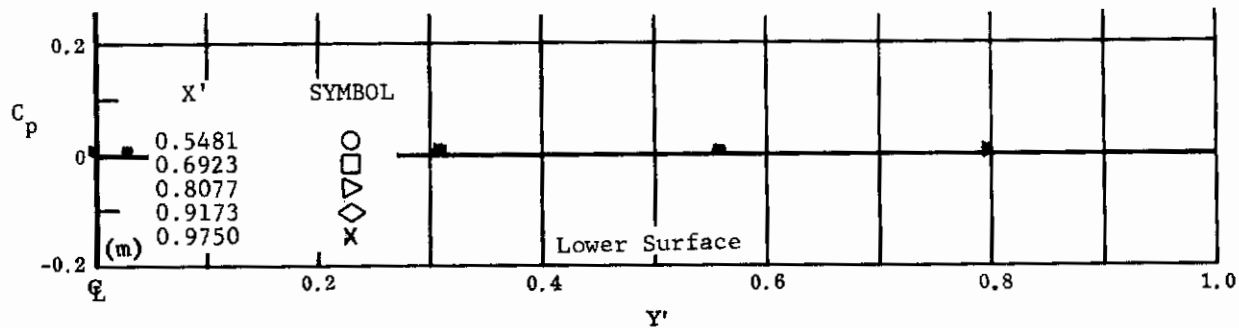

(NONDIMENSIONAL SEMISPAN DISTANCE)

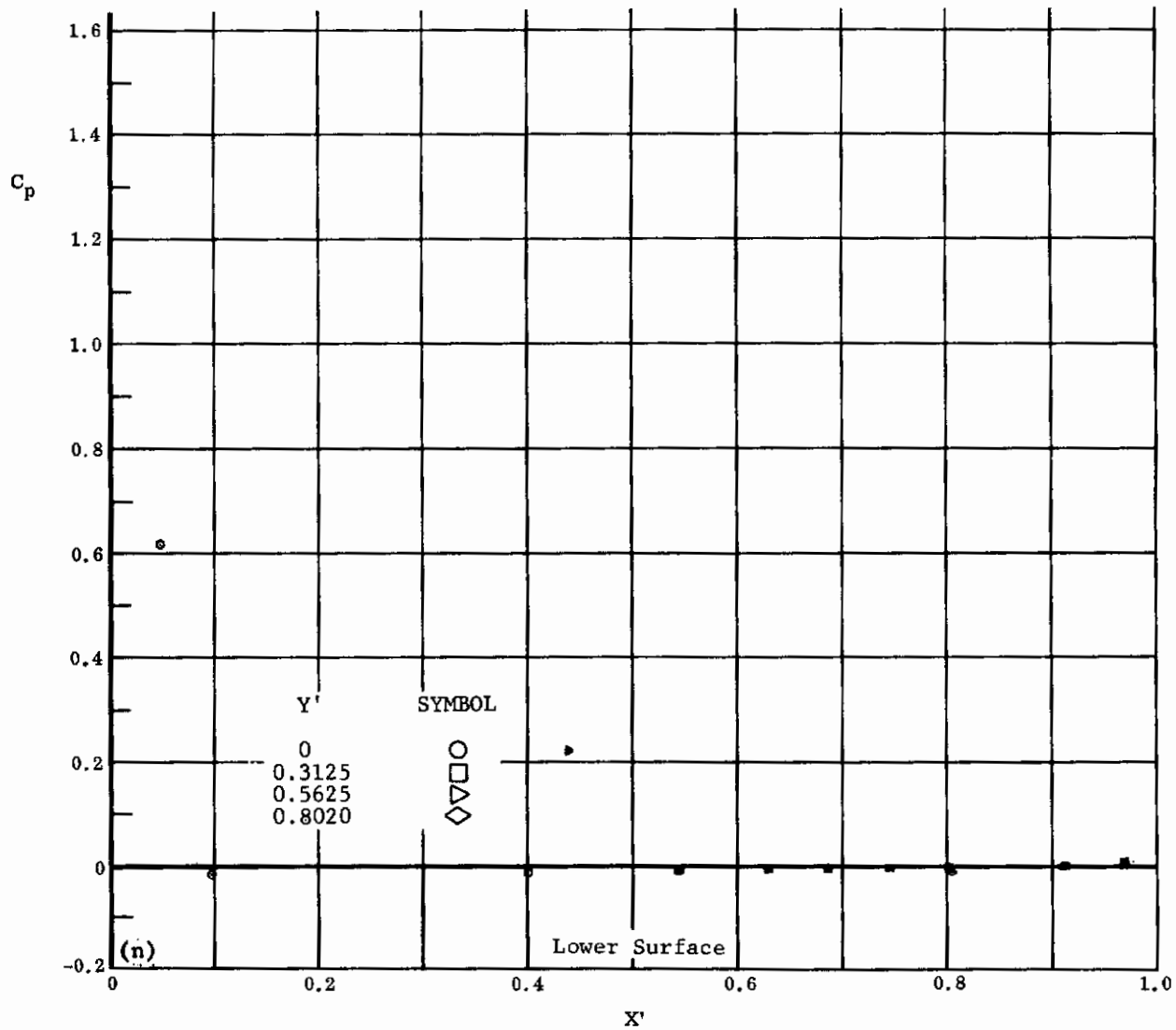

(NONDIMENSIONAL STREAMWISE DISTANCE FROM VIRTUAL APEX)

Fig. 28 Configuration I, $\alpha = -50$, $\delta_2 = \delta_3 = -39$

m) C_p vs. Y' , lower surface

n) C_p vs. X' , lower surface

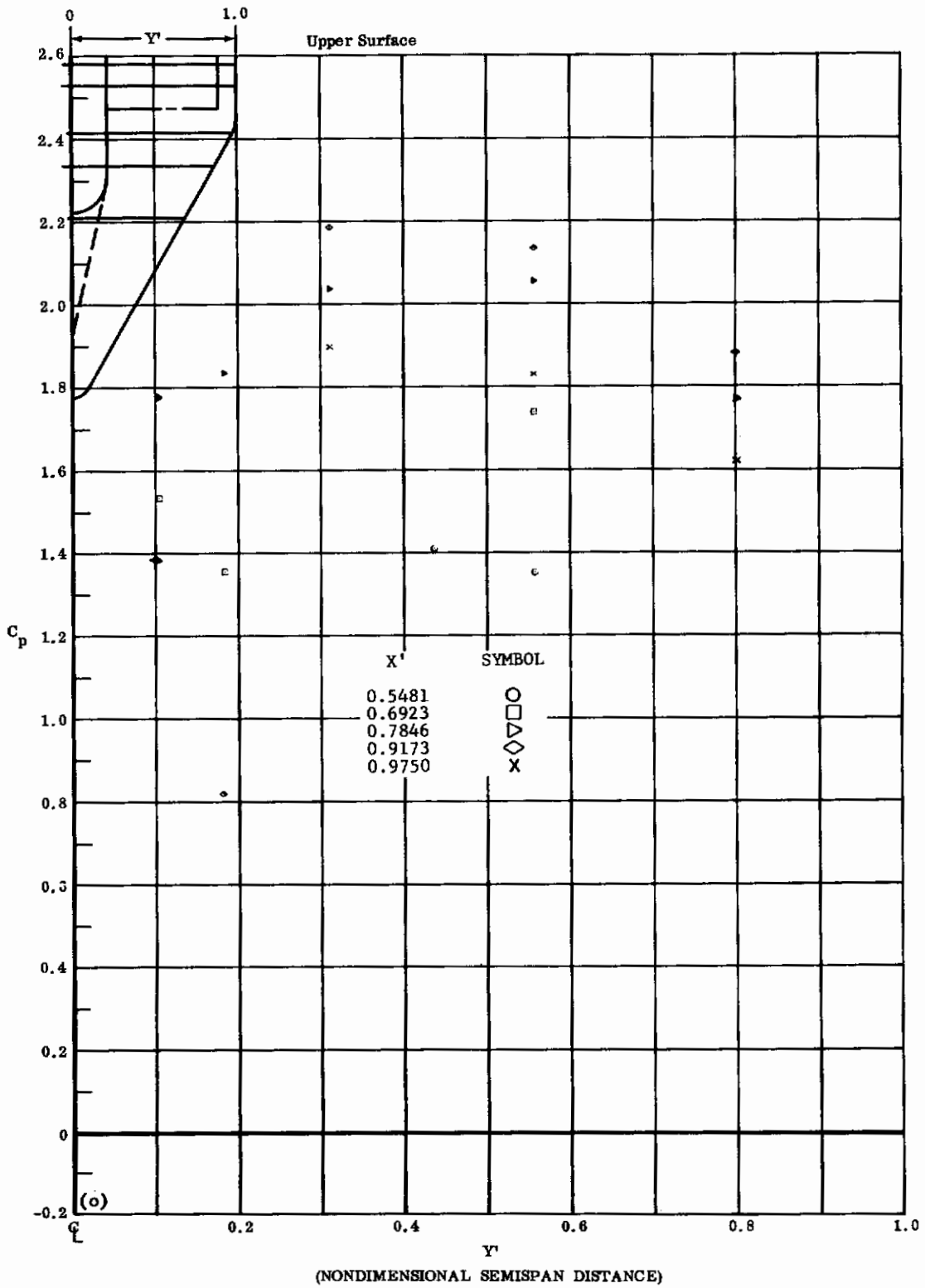
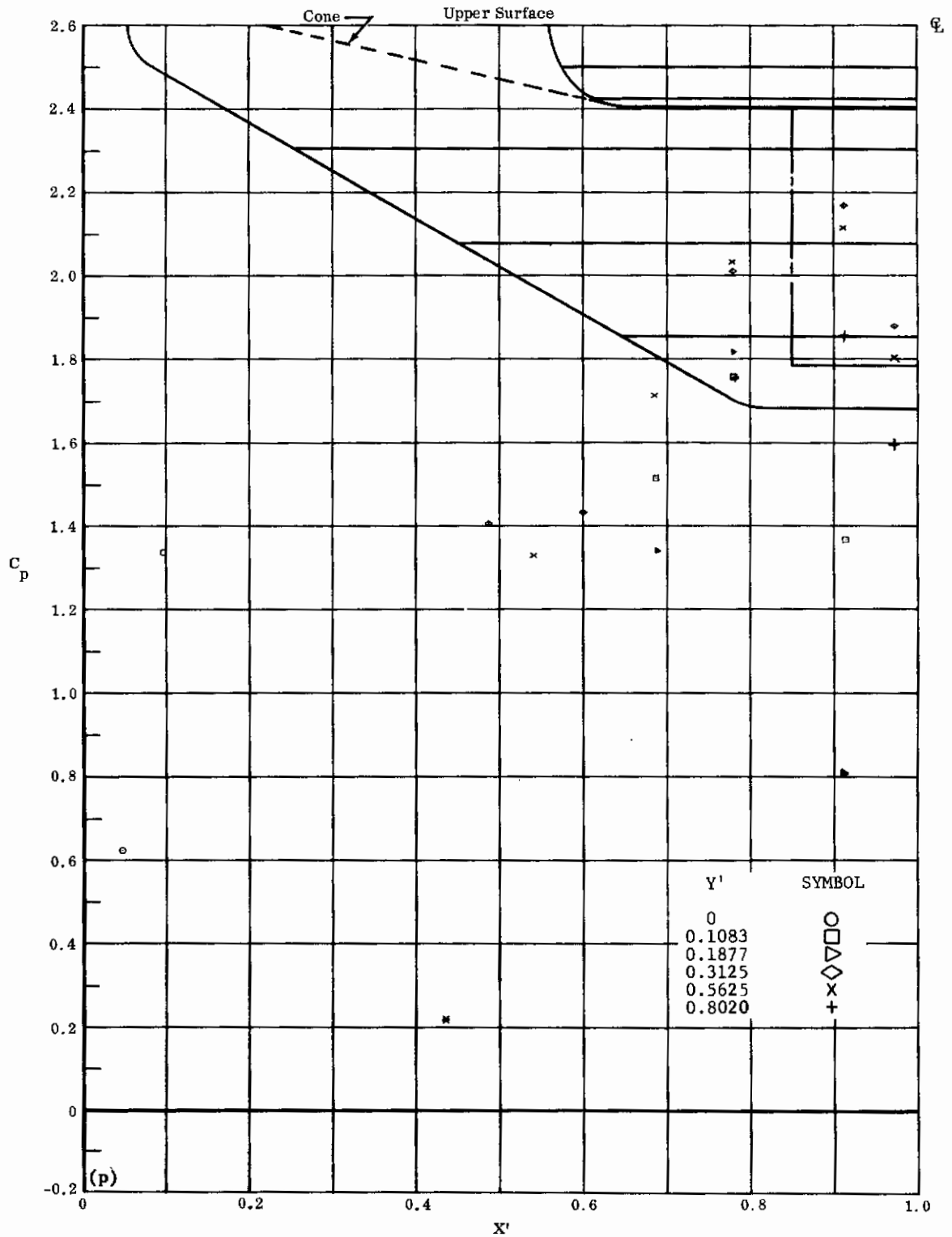

Fig. 28o Configuration I, $\alpha = -50$, $\delta_2 = \delta_3 = -39$

C_p vs. Y' , upper surface

Contraails



(NONDIMENSIONAL STREAMWISE DISTANCE FROM VIRTUAL APEX)

Fig. 28p Configuration I, $\alpha = -50$, $\delta_2 = \delta_3 = -39$

C_p vs. X' , upper surface

Contrails

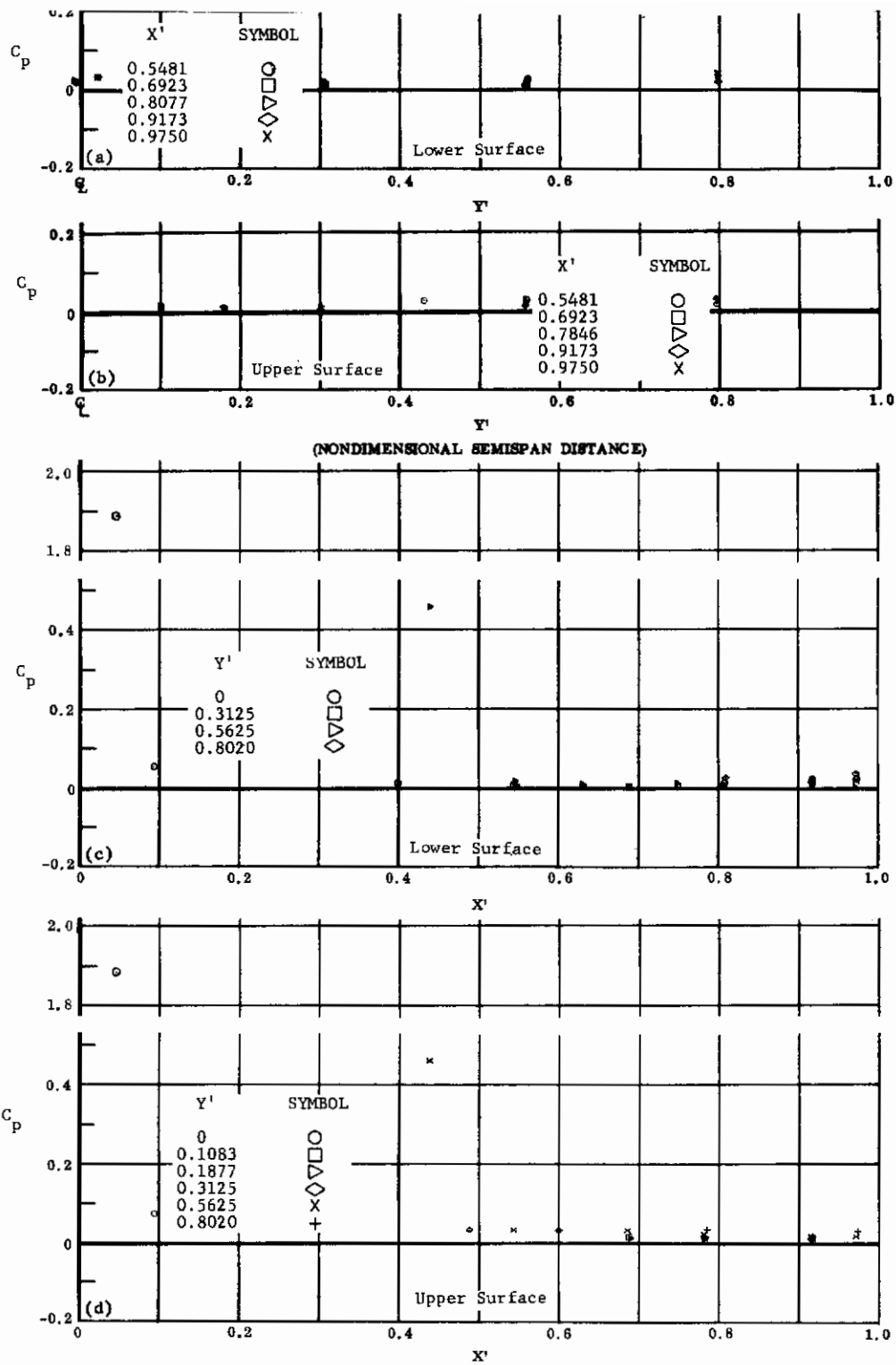
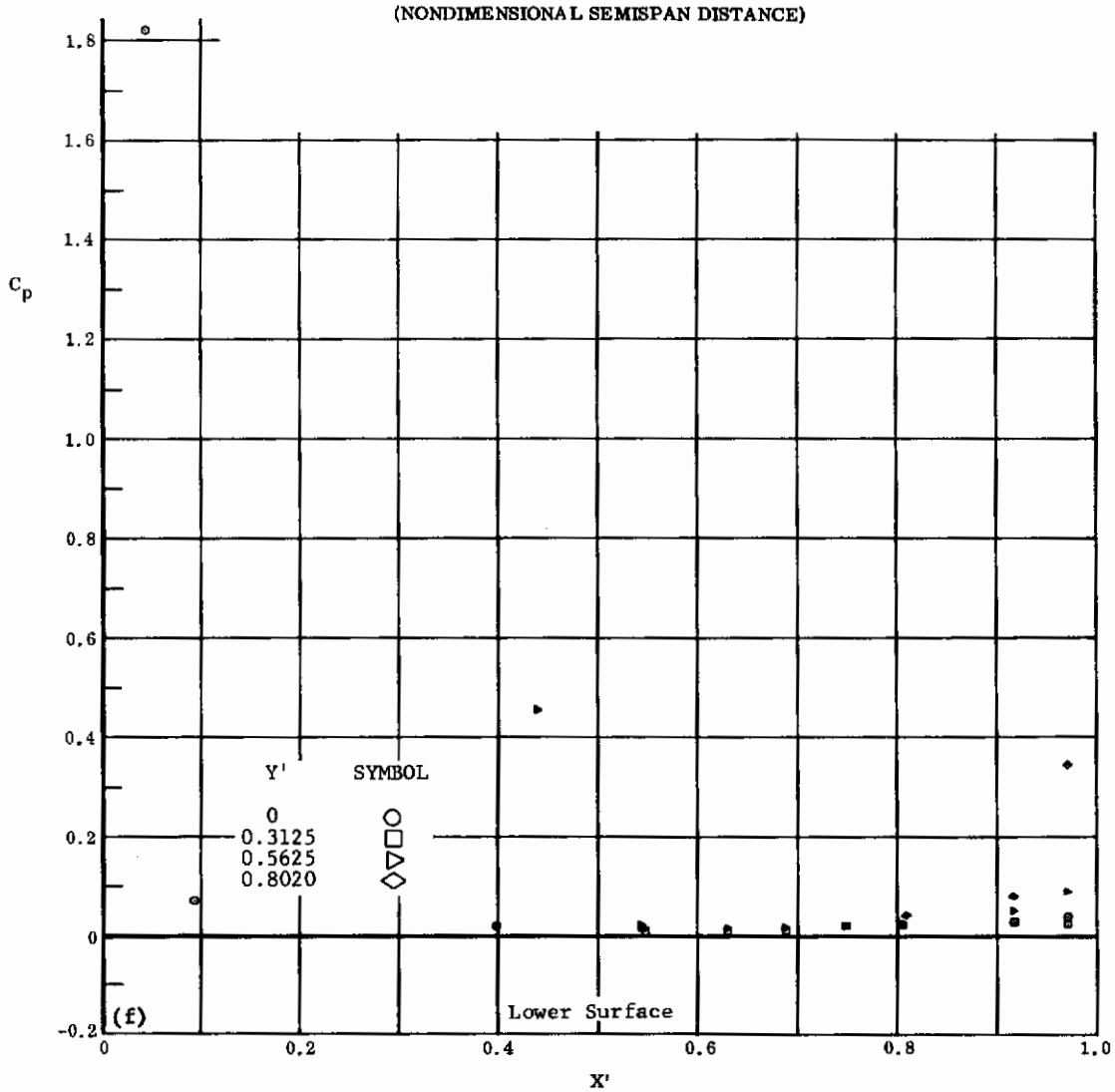
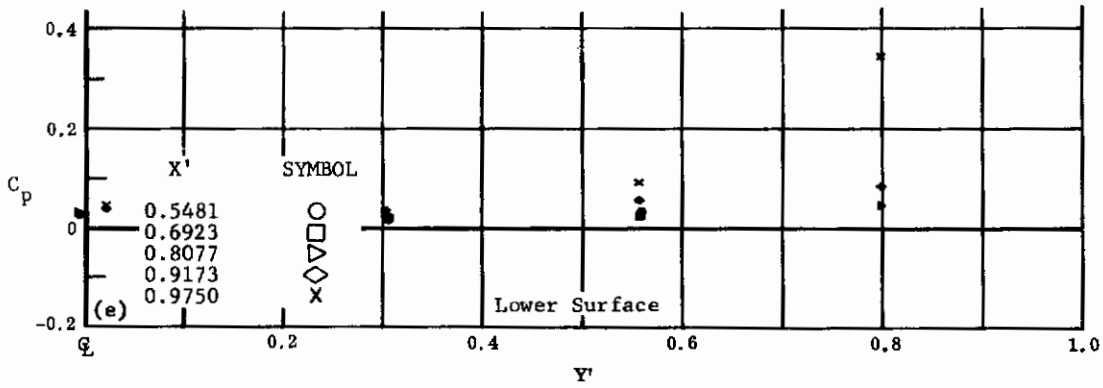

Fig. 29 Configuration IV, $\alpha = 0$, $\delta_2 = \delta_3 = 0$

- a) C_p vs. Y' , lower surface
- b) C_p vs. Y' , upper surface
- c) C_p vs. X' , lower surface
- d) C_p vs. X' , upper surface

Contrails



(NONDIMENSIONAL STREAMWISE DISTANCE FROM VIRTUAL APEX)

Fig. 29 Configuration IV, $\alpha = 0$, $\delta_2 = \delta_3 = +10$

e) C_p vs. Y' , lower surface

f) C_p vs. X' , lower surface

Contrails

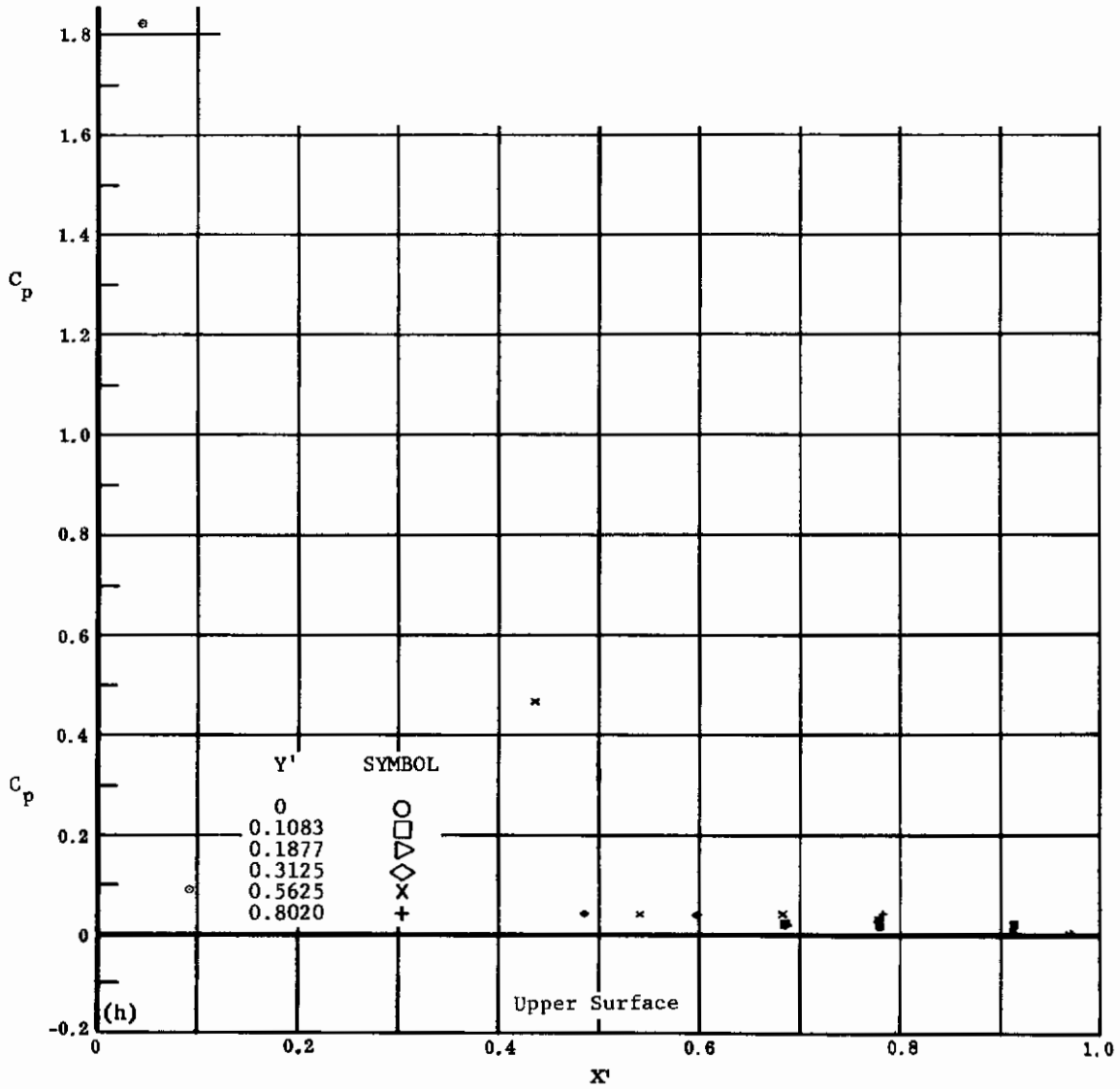
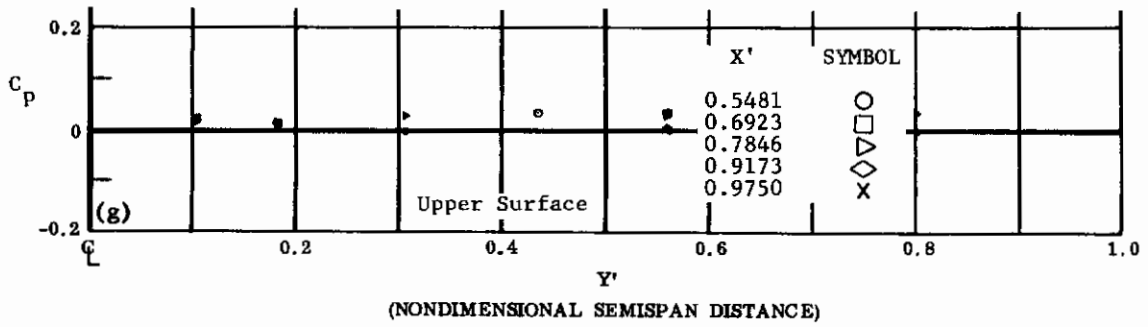

(NONDIMENSIONAL STREAMWISE DISTANCE FROM VIRTUAL APEX)

Fig. 29 Configuration IV, $\alpha = 0$, $\delta_2 = \delta_3 = +10$

g) C_p vs. Y' , upper surface

h) C_p vs. X' , upper surface

Contrails

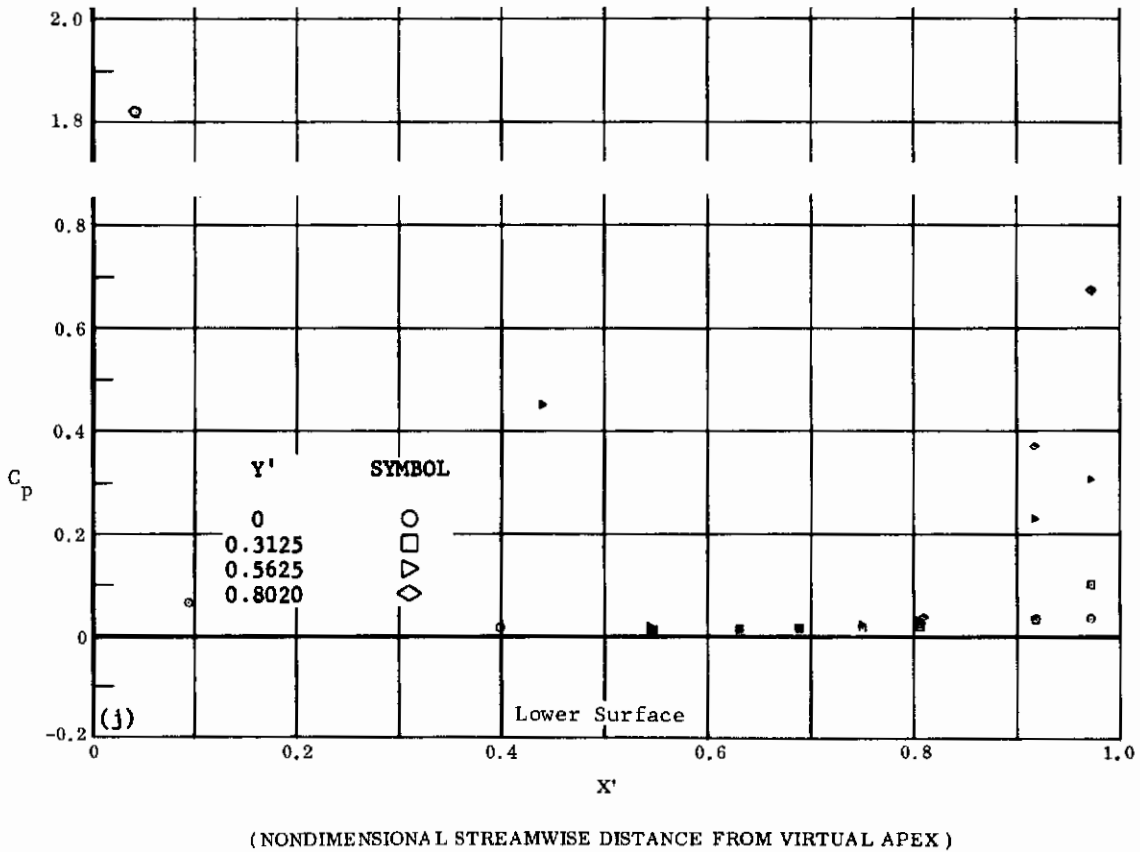
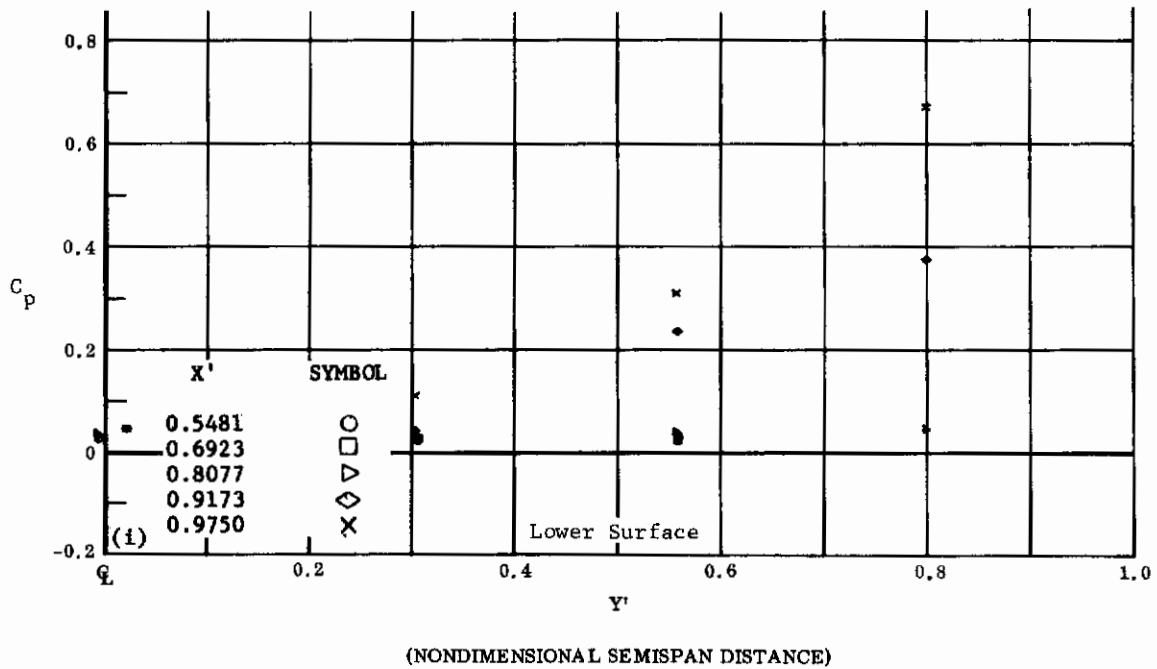
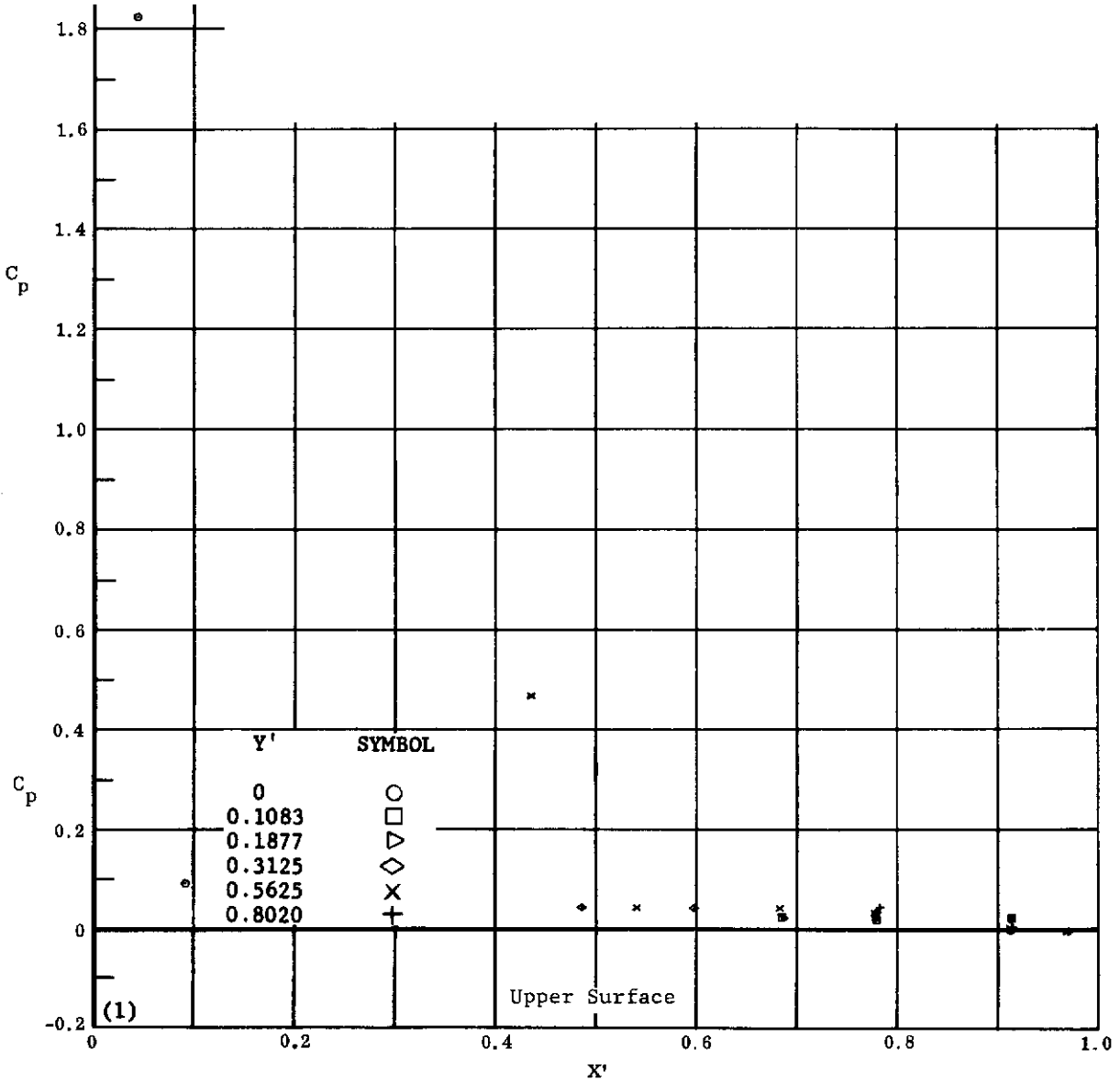
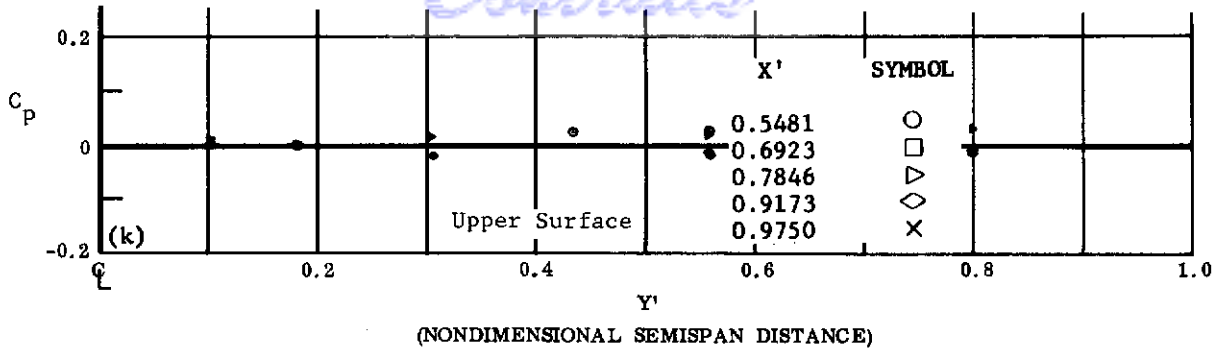

Fig. 29 Configuration IV, $\alpha = 0$, $\delta_2 = \delta_3 = +20$

- 1) C_p vs. Y' , lower surface
- j) C_p vs. X' , lower surface

Contrails



(NONDIMENSIONAL STREAMWISE DISTANCE FROM VIRTUAL APEX)

Fig. 29 Configuration IV, $\alpha = 0$, $\delta_2 = \delta_3 = +20$

k) C_p vs. Y' , upper surface

1) C_p vs. X' , upper surface

Contrails

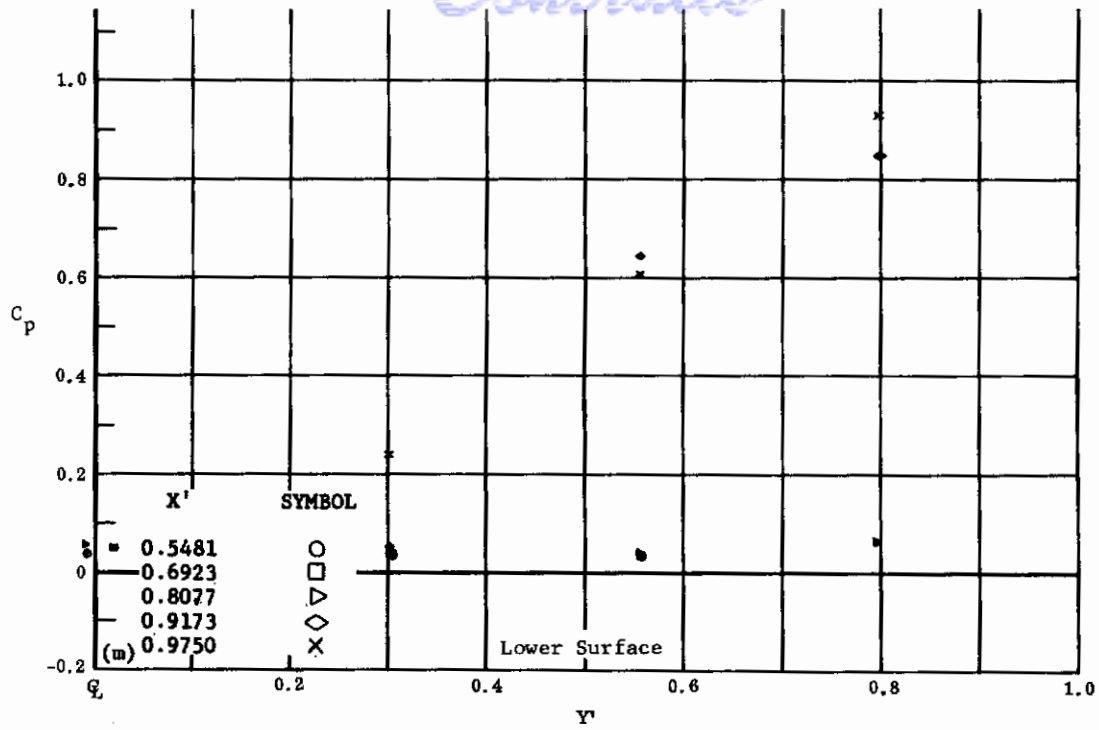

(NONDIMENSIONAL SEMISPAN DISTANCE)

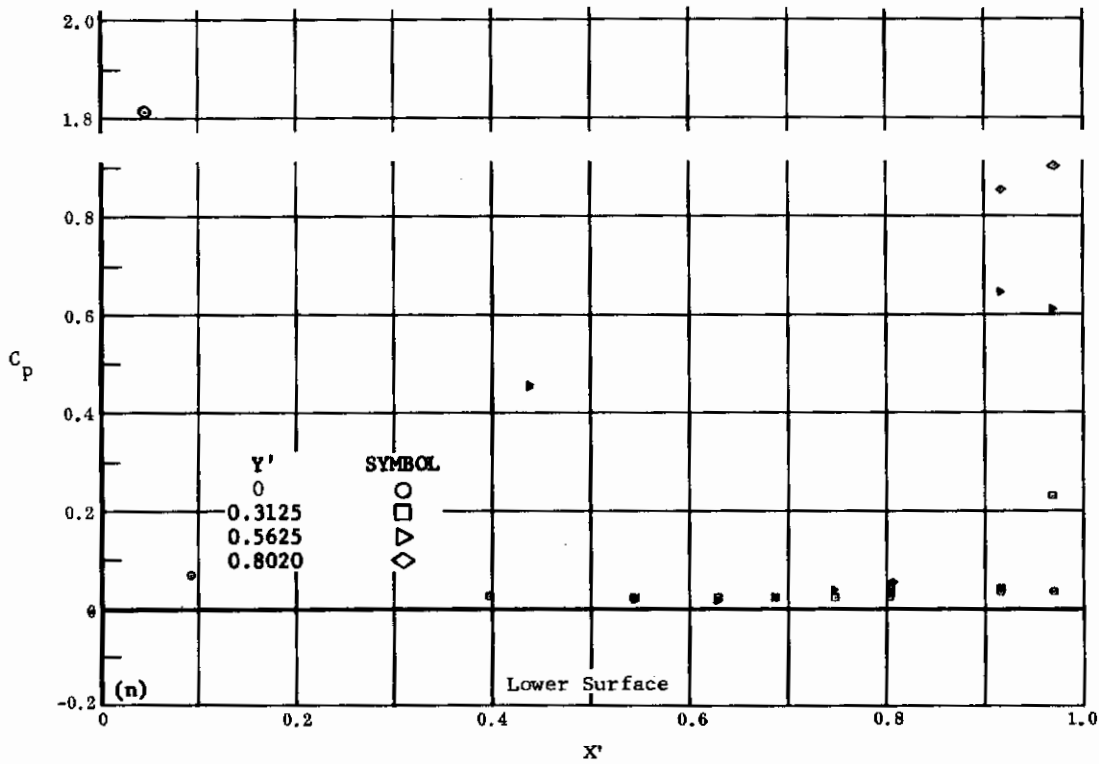

(NONDIMENSIONAL STREAMWISE DISTANCE FROM VIRTUAL APEX)

Fig. 29 Configuration IV, $\alpha = 0$, $\delta_2 = \delta_3 = +30$

m) C_p vs. Y' , lower surface

n) C_p vs. X' , lower surface

Contrails

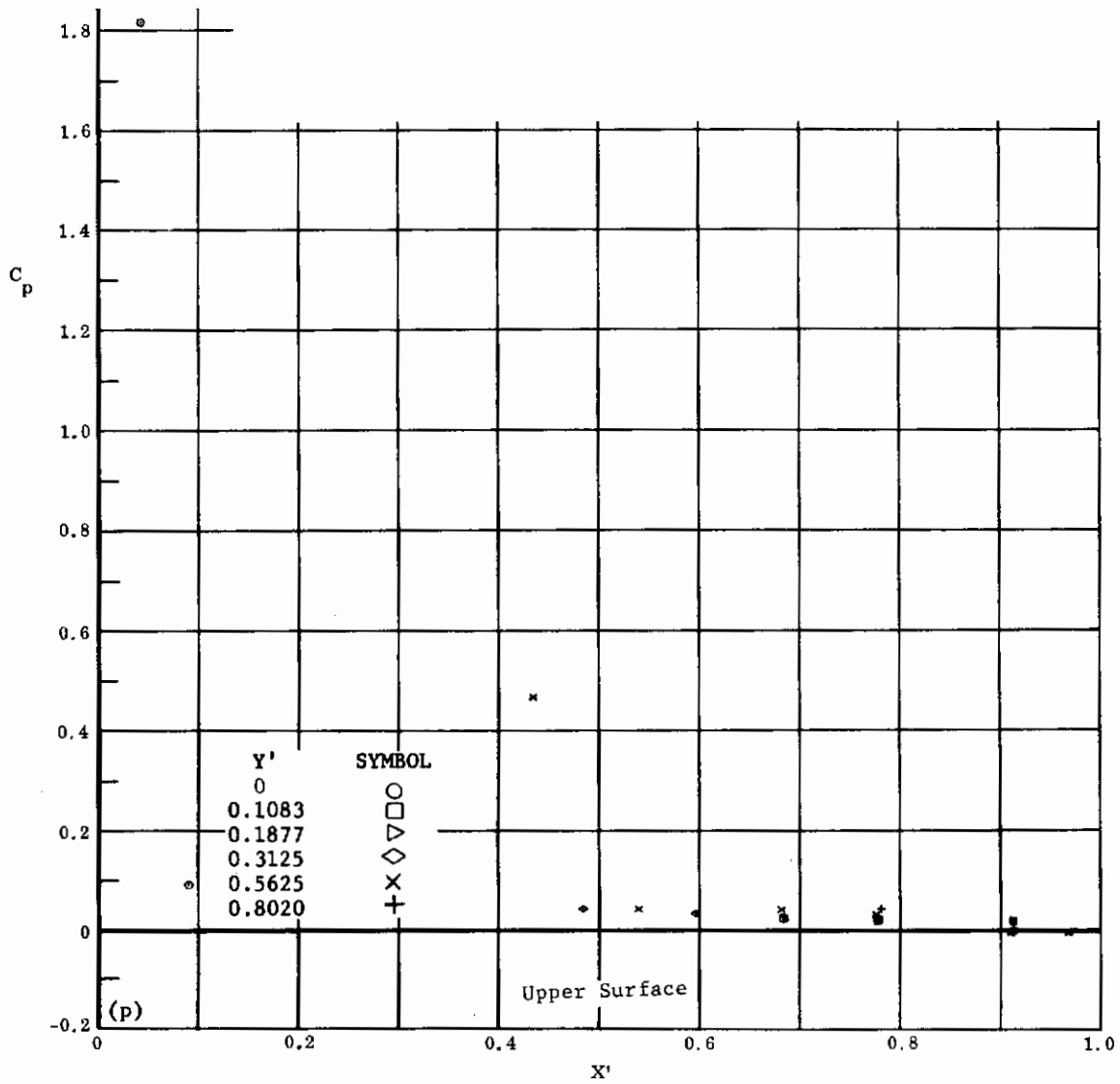
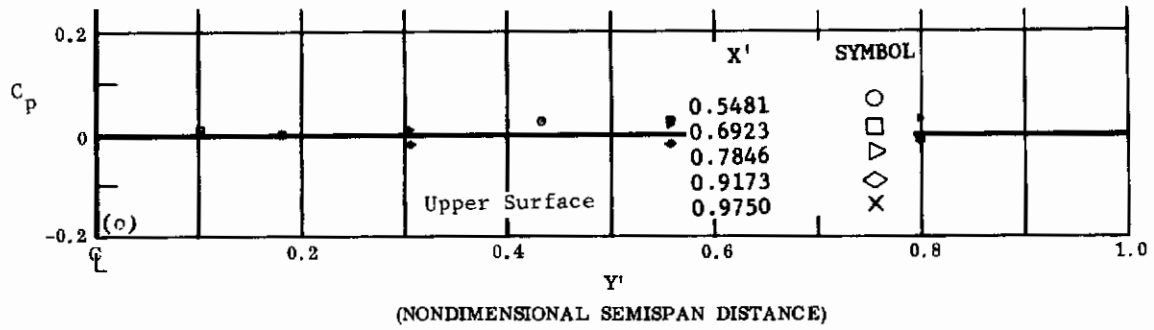

Fig. 29 Configuration IV, $\alpha = 0$, $\delta_2 = \delta_3 = +30$

o) C_p vs. Y' , upper surface

p) C_p vs. X' , upper surface

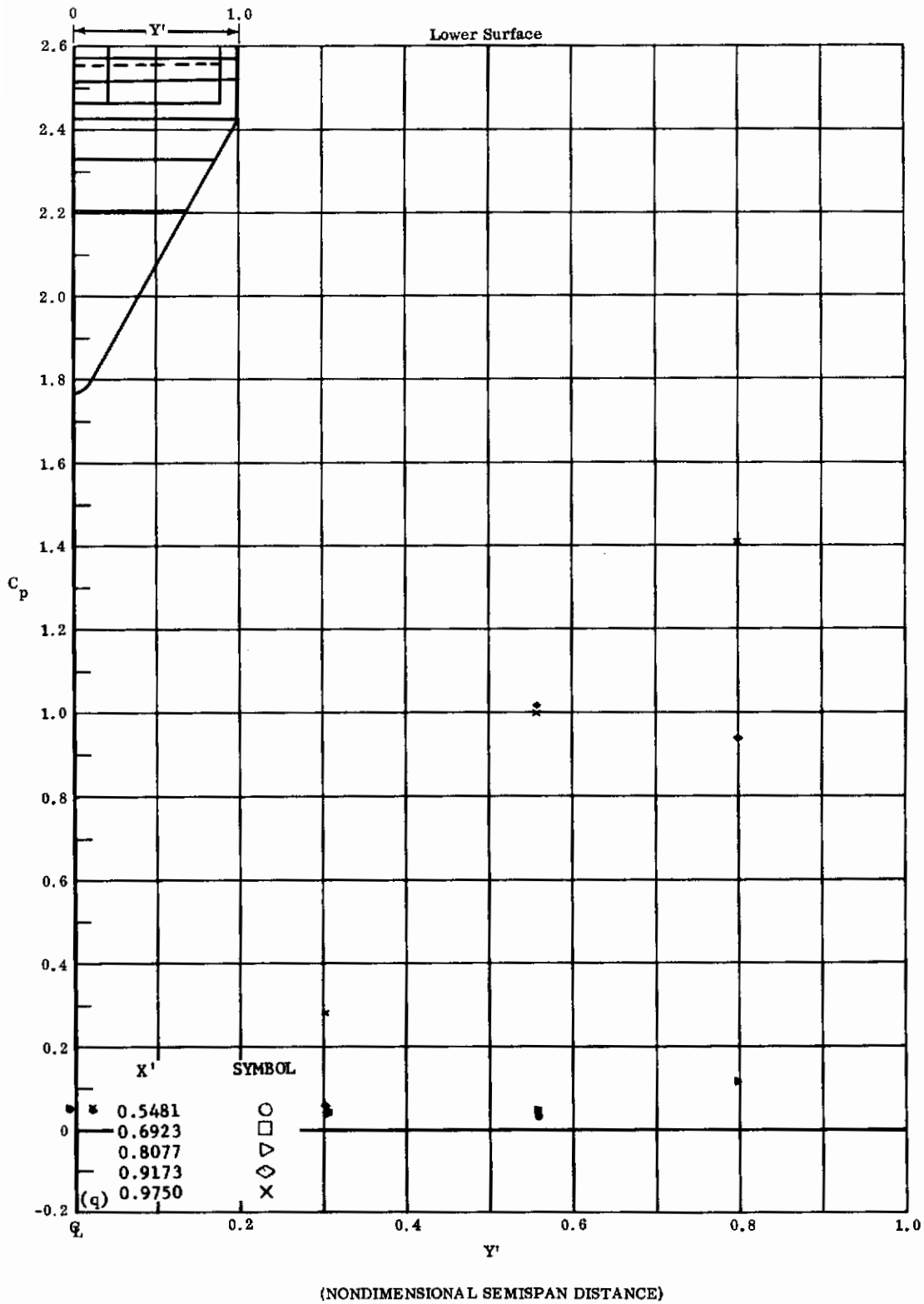
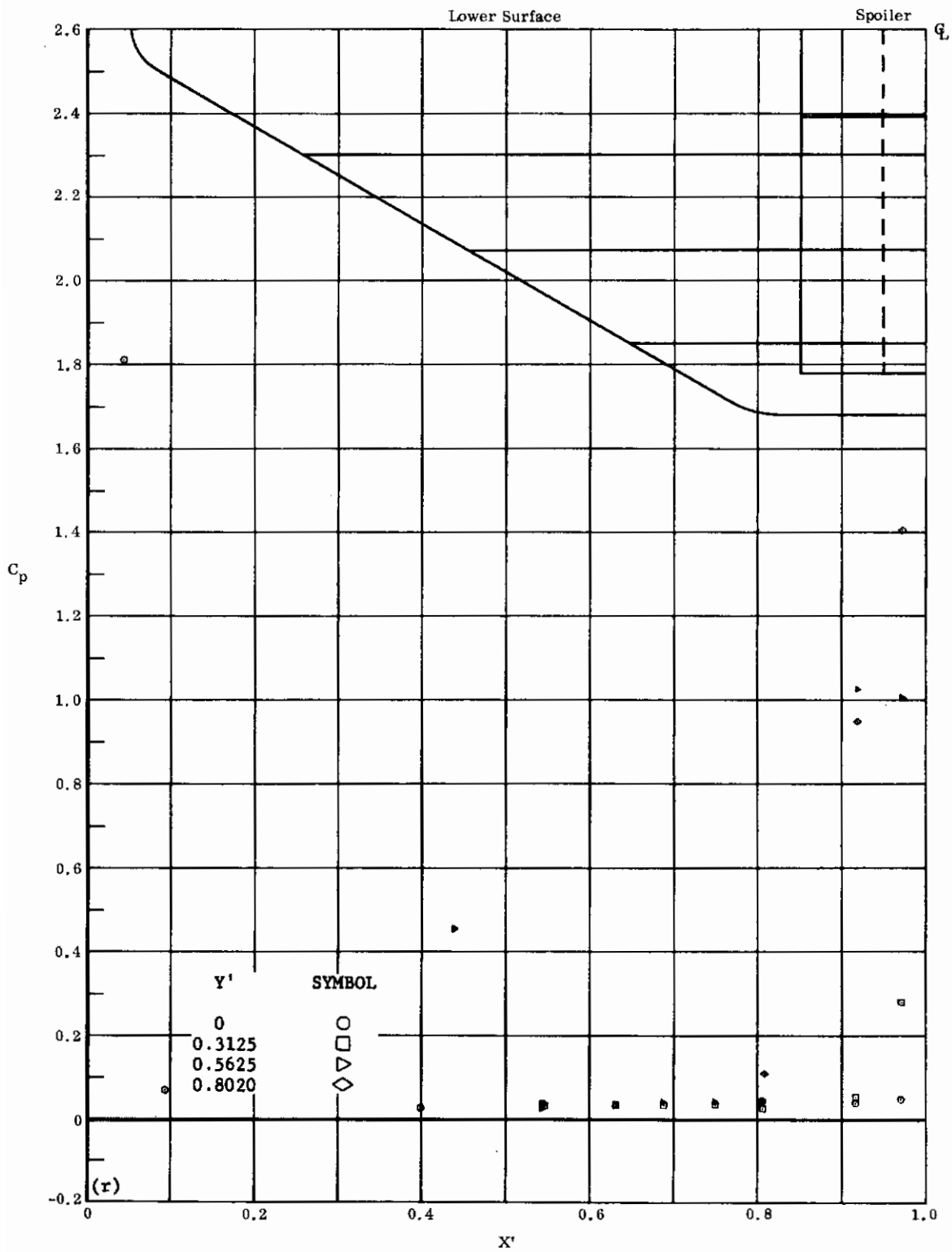

Fig. 29q Configuration IV, $\alpha = 0$, $\delta_2 = \delta_3 = +39$

C_p vs. Y', lower surface



(NONDIMENSIONAL STREAMWISE DISTANCE FROM VIRTUAL APEX)

Fig. 29r Configuration IV, $\alpha = 0$, $\delta_2 = \delta_3 = +39$

C_p vs. X', lower surface

Contrails

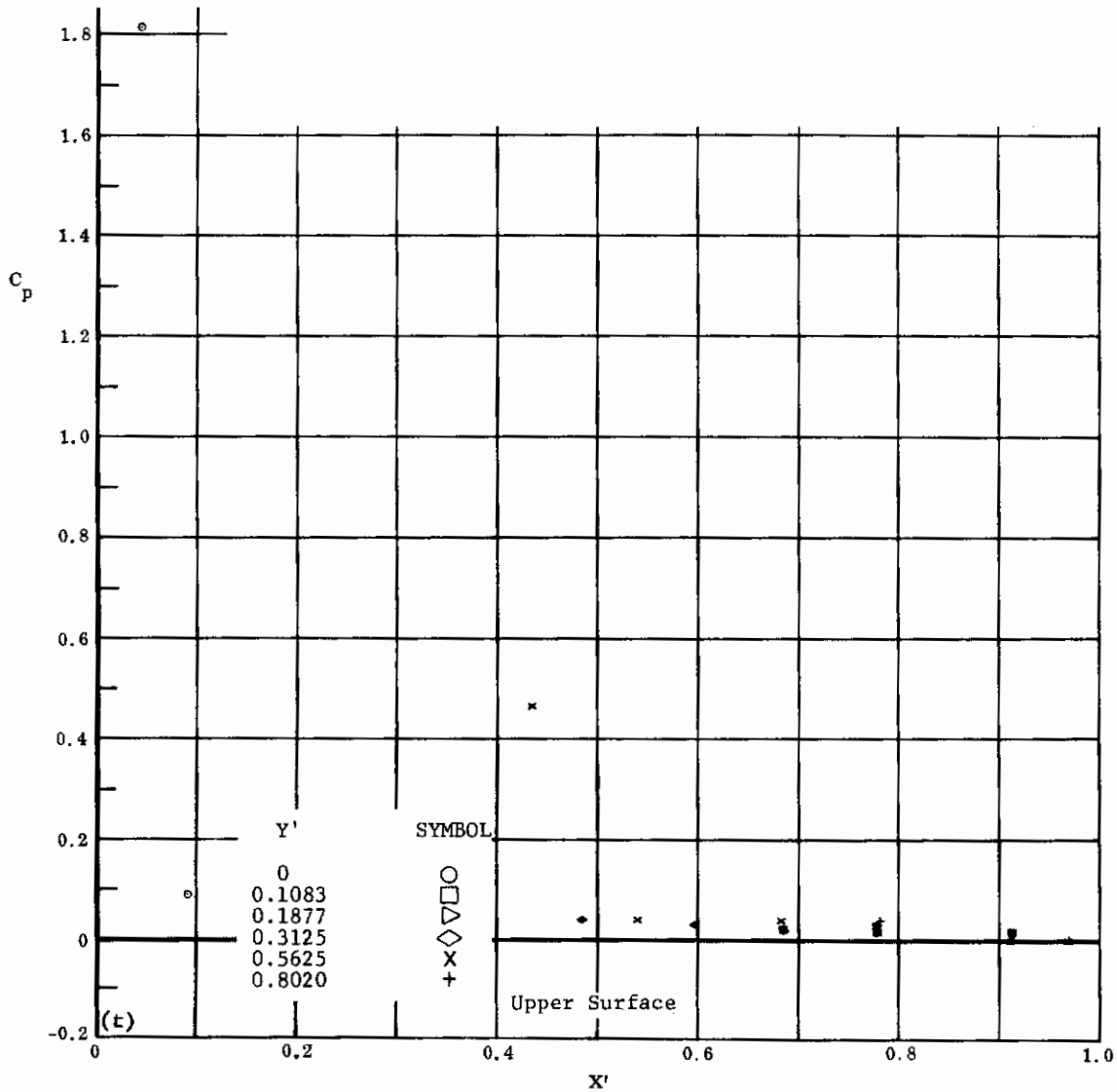
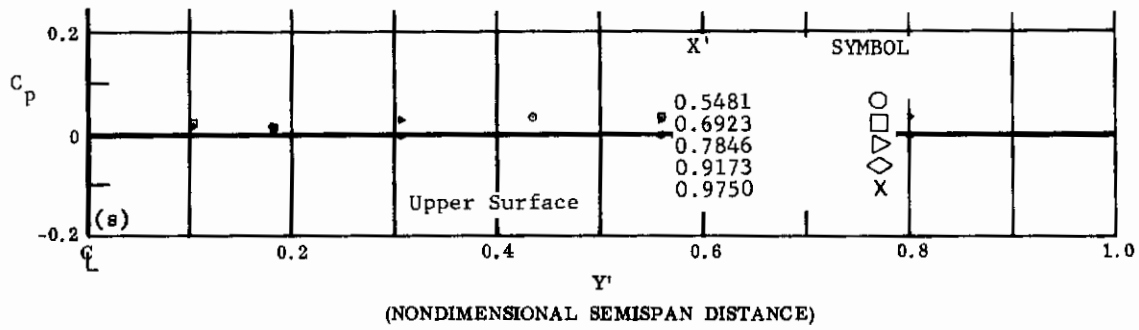

(NONDIMENSIONAL STREAMWISE DISTANCE FROM VIRTUAL APEX)

Fig. 29 Configuration IV, $\alpha = 0$, $\delta_2 = \delta_3 = +39$

s) C_p vs. Y' , upper surface

t) C_p vs. X' , upper surface

Contrails

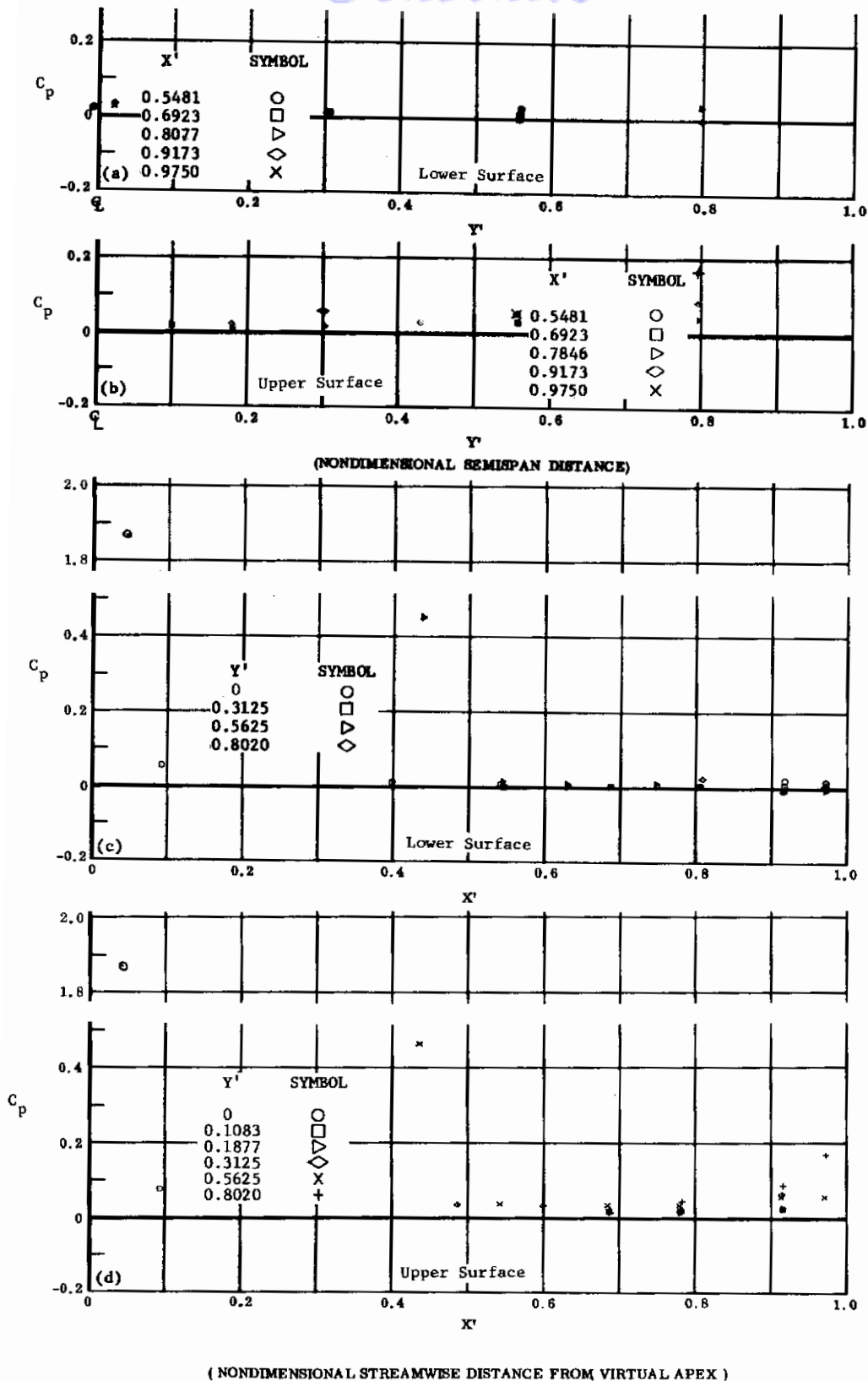

Fig. 30 Configuration IV, $\alpha = 0$, $\delta_2 = \delta_3 = -10$

- a) C_p vs. Y' , lower surface
- b) C_p vs. Y' , upper surface
- c) C_p vs. X' , lower surface
- d) C_p vs. X' , upper surface

Contrails

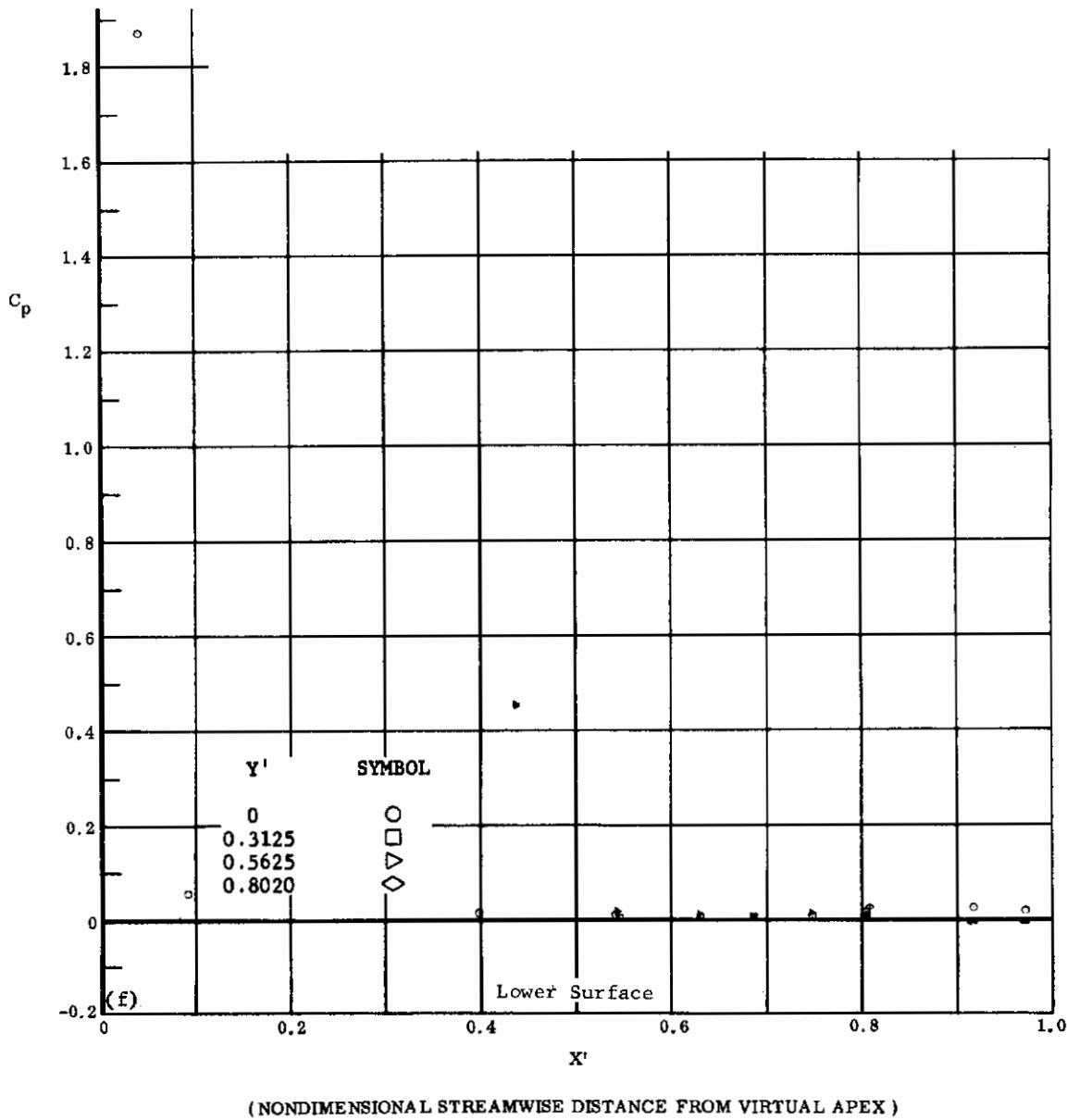
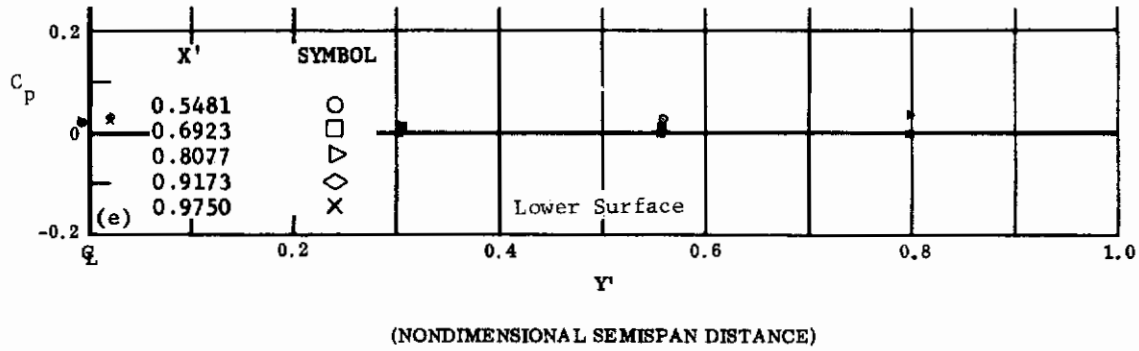

Fig. 30 Configuration IV, $\alpha = 0$, $\delta_2 = \delta_3 = -20$

e) C_p vs. Y' , lower surface

f) C_p vs. X' , lower surface

Contrails

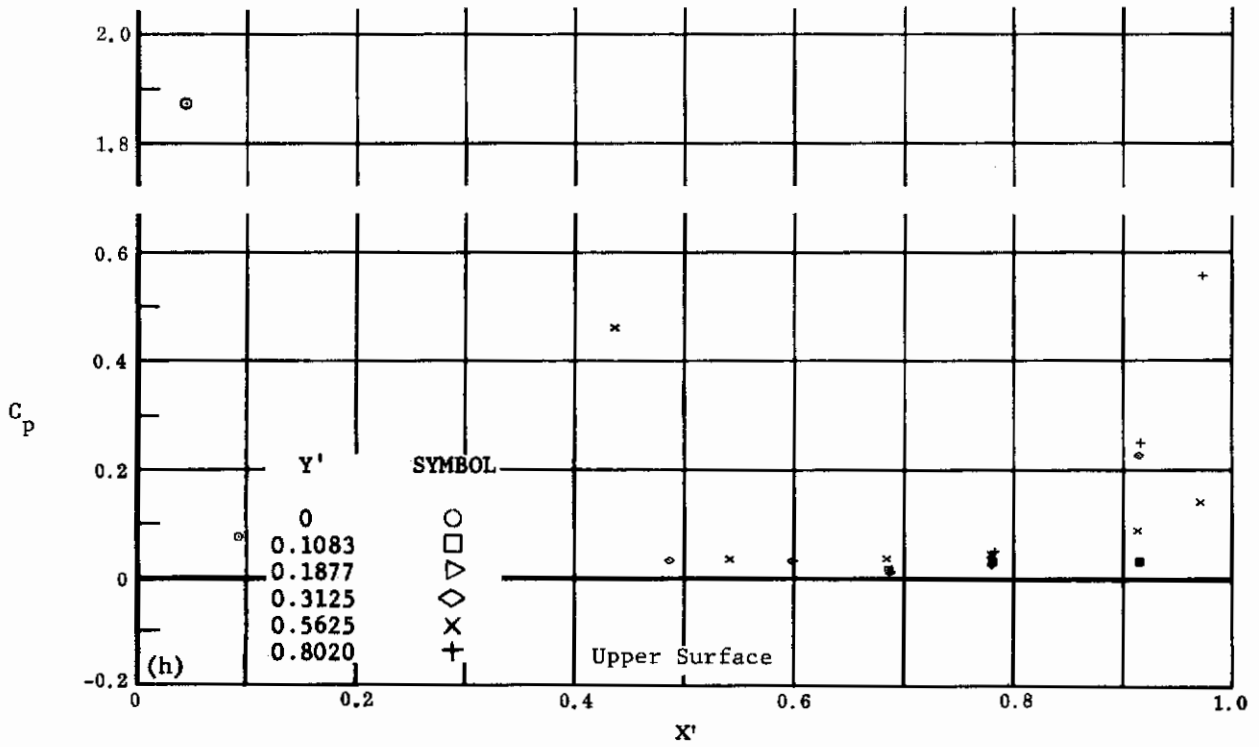
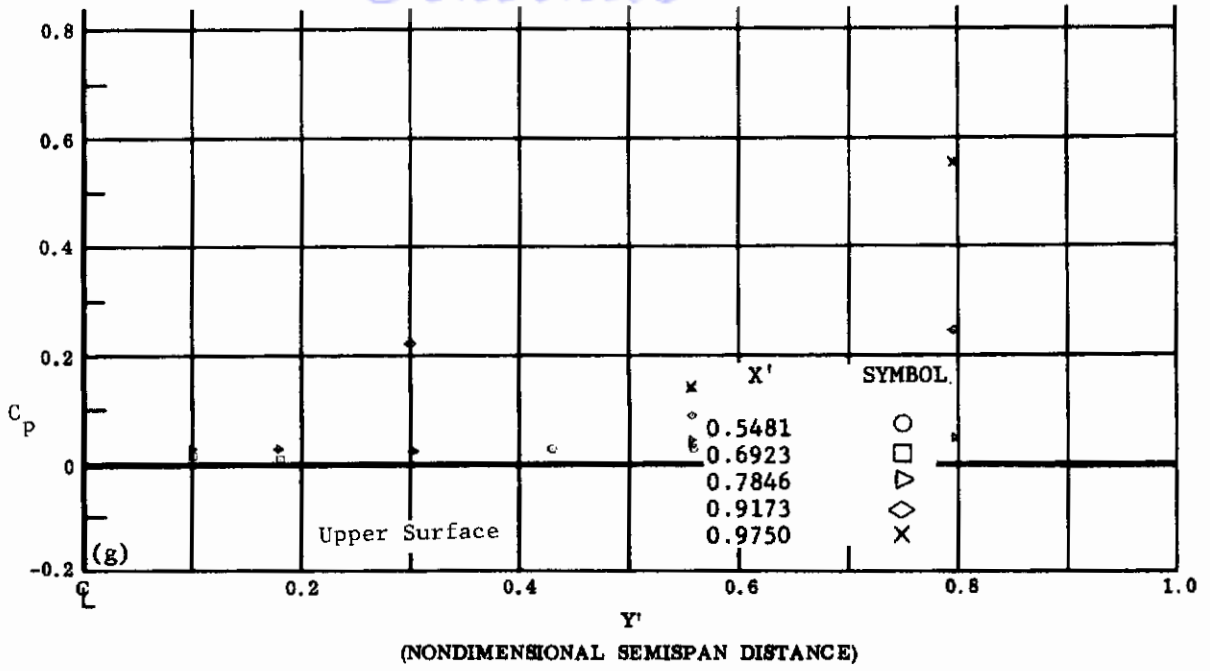
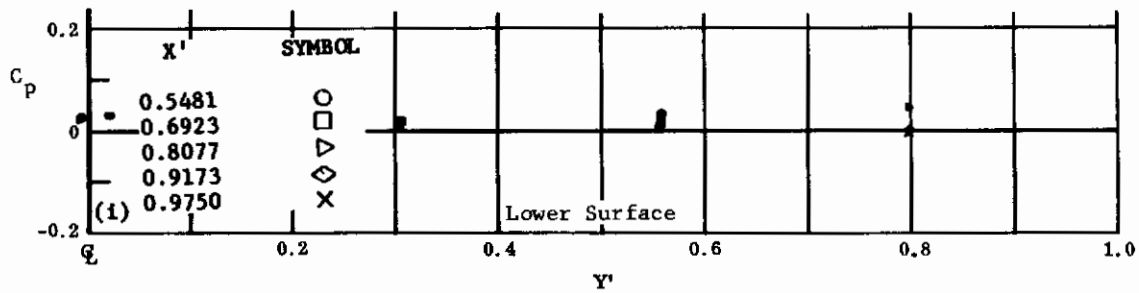

Fig. 30 Configuration IV, $\alpha = 0$, $\delta_2 = \delta_3 = -20$

g) C_p vs. Y' , upper surface

h) C_p vs. X' , upper surface

Contrails



(NONDIMENSIONAL SEMISPAN DISTANCE)

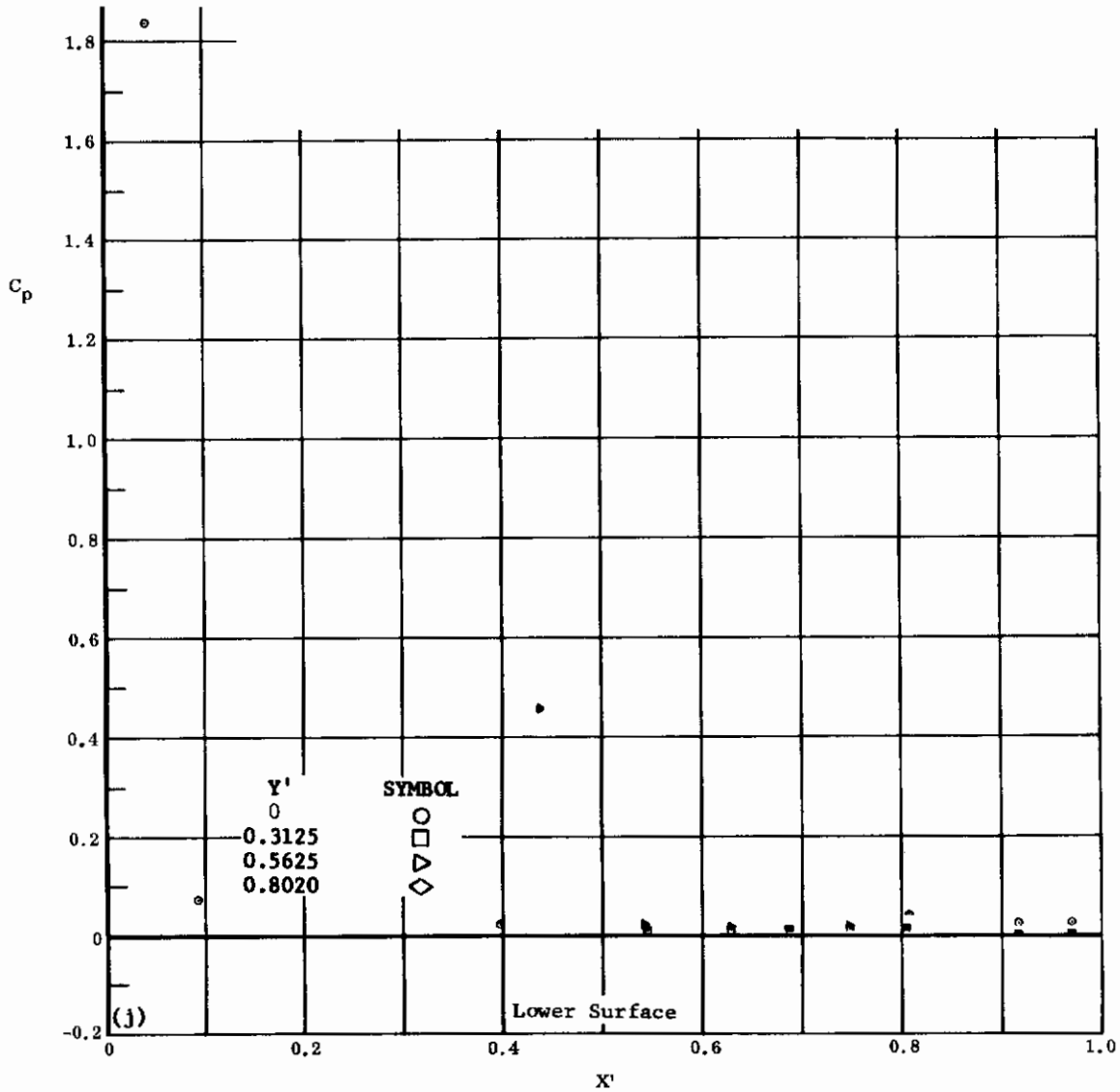

(NONDIMENSIONAL STREAMWISE DISTANCE FROM VIRTUAL APEX)

Fig. 30 Configuration IV, $\alpha = 0$, $\delta_2 = \delta_3 = -30$

- i) C_p vs. Y' , lower surface
- j) C_p vs. X' , lower surface

Contrails

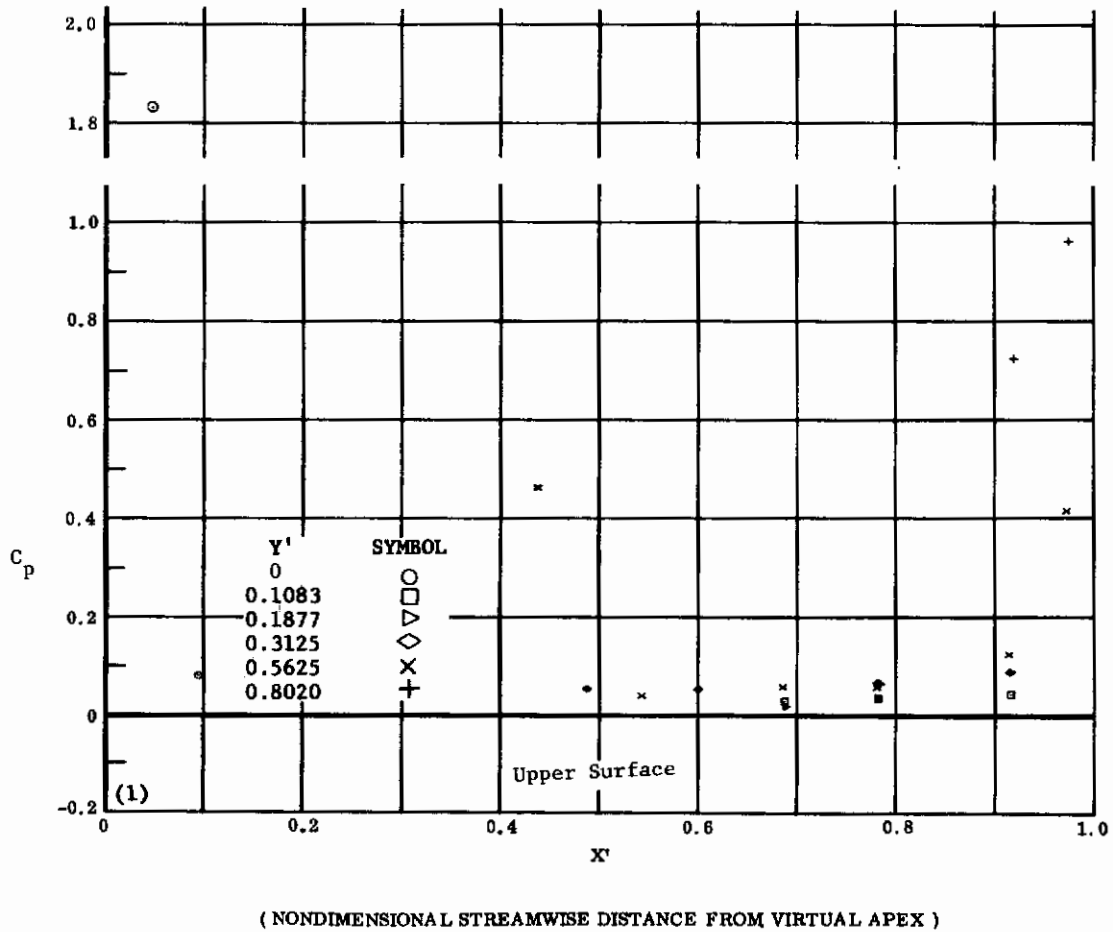
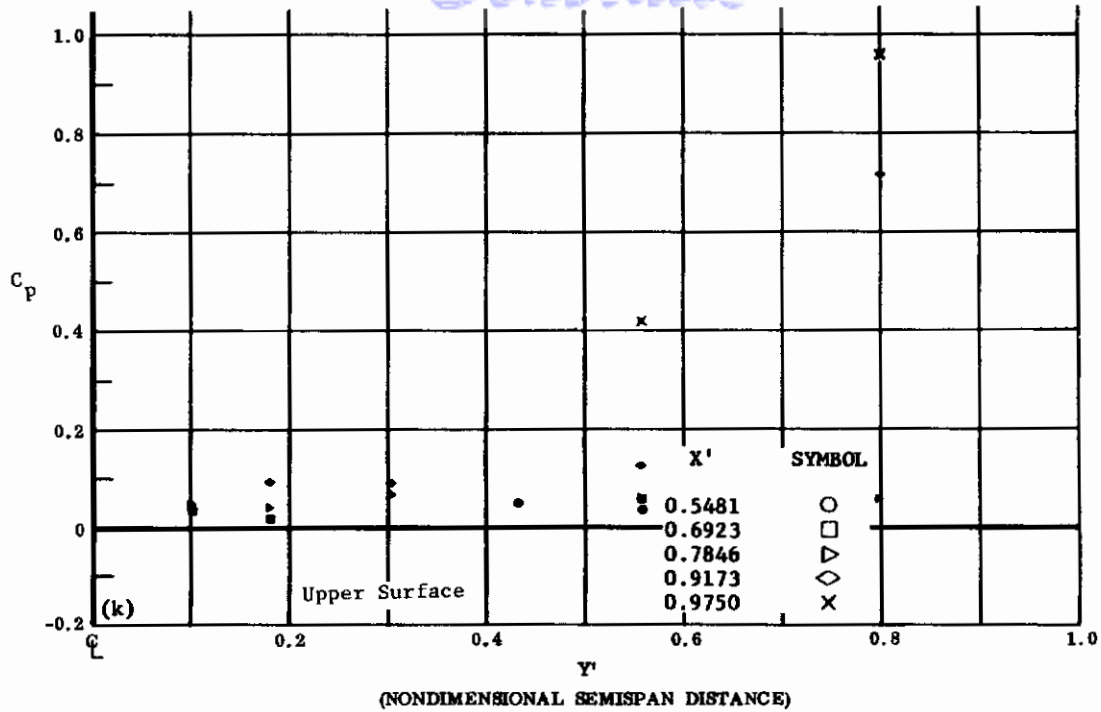
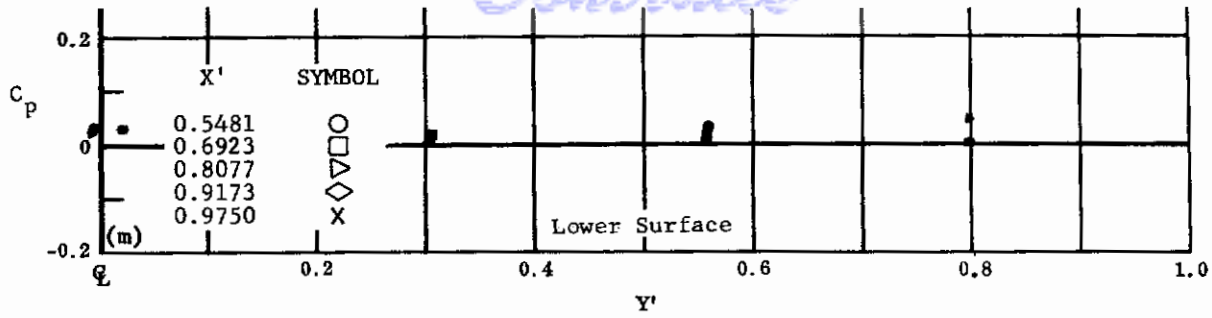

Fig. 30 Configuration IV, $\alpha = 0$, $\delta_2 = \delta_3 = -30$

k) C_p vs. Y' , upper surface

1) C_p vs. X' , upper surface

Contrails



(NONDIMENSIONAL SEMISPAN DISTANCE)

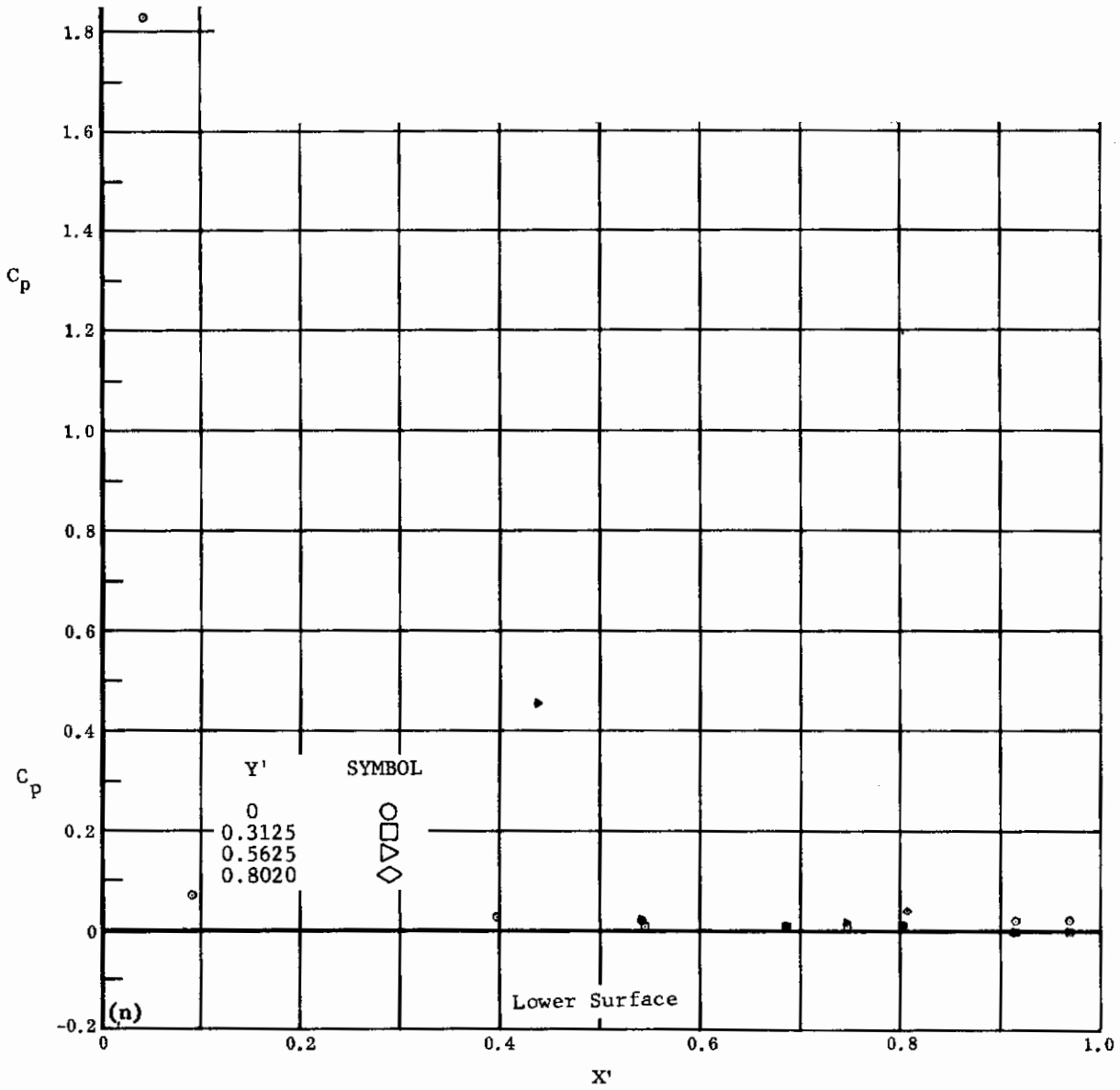

(NONDIMENSIONAL STREAMWISE DISTANCE FROM VIRTUAL APEX)

Fig. 30 Configuration IV, $\alpha = 0$, $\delta_2 = \delta_3 = -39$

m) C_p vs. Y' , lower surface

n) C_p vs. X' , lower surface

Contrails

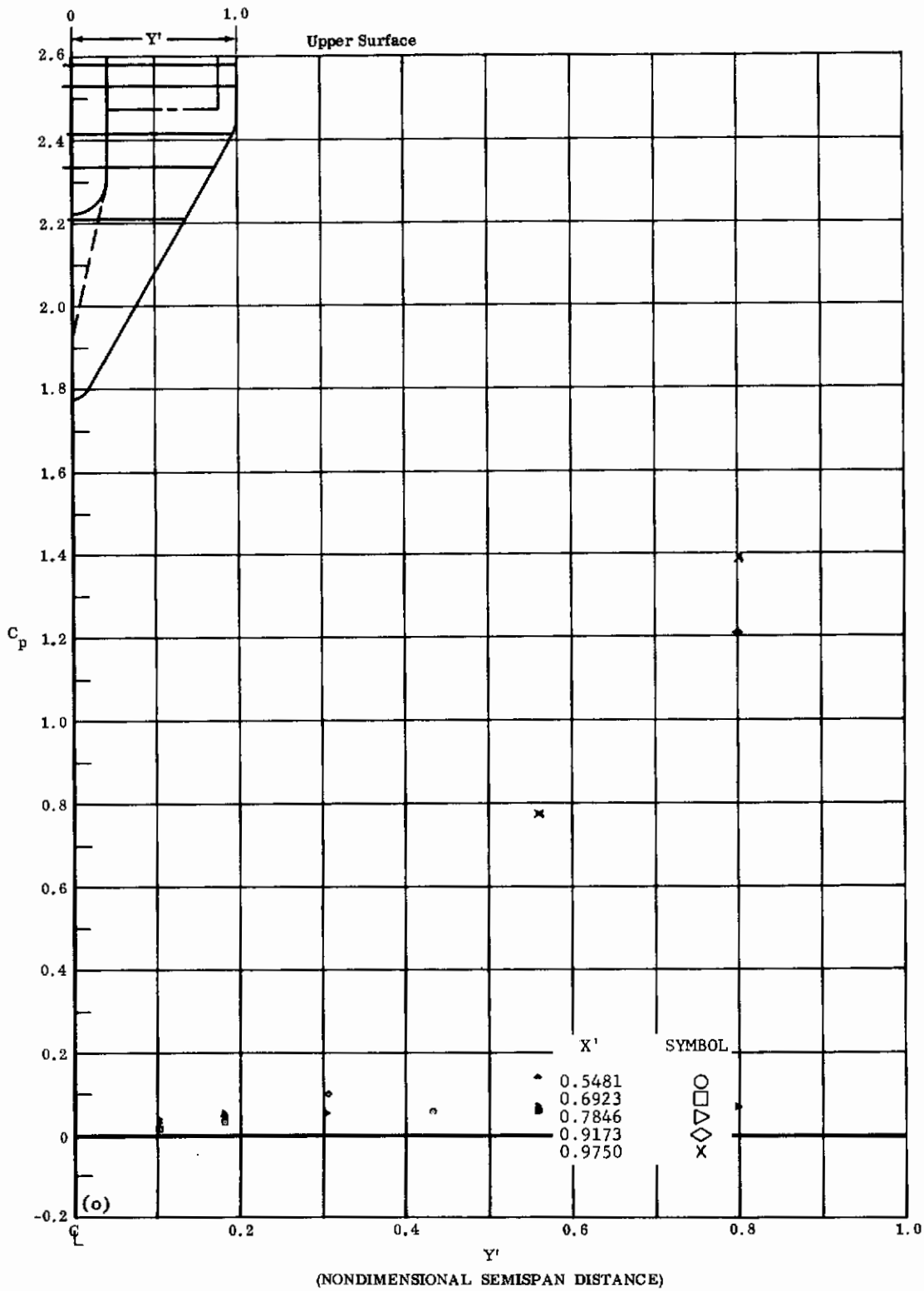
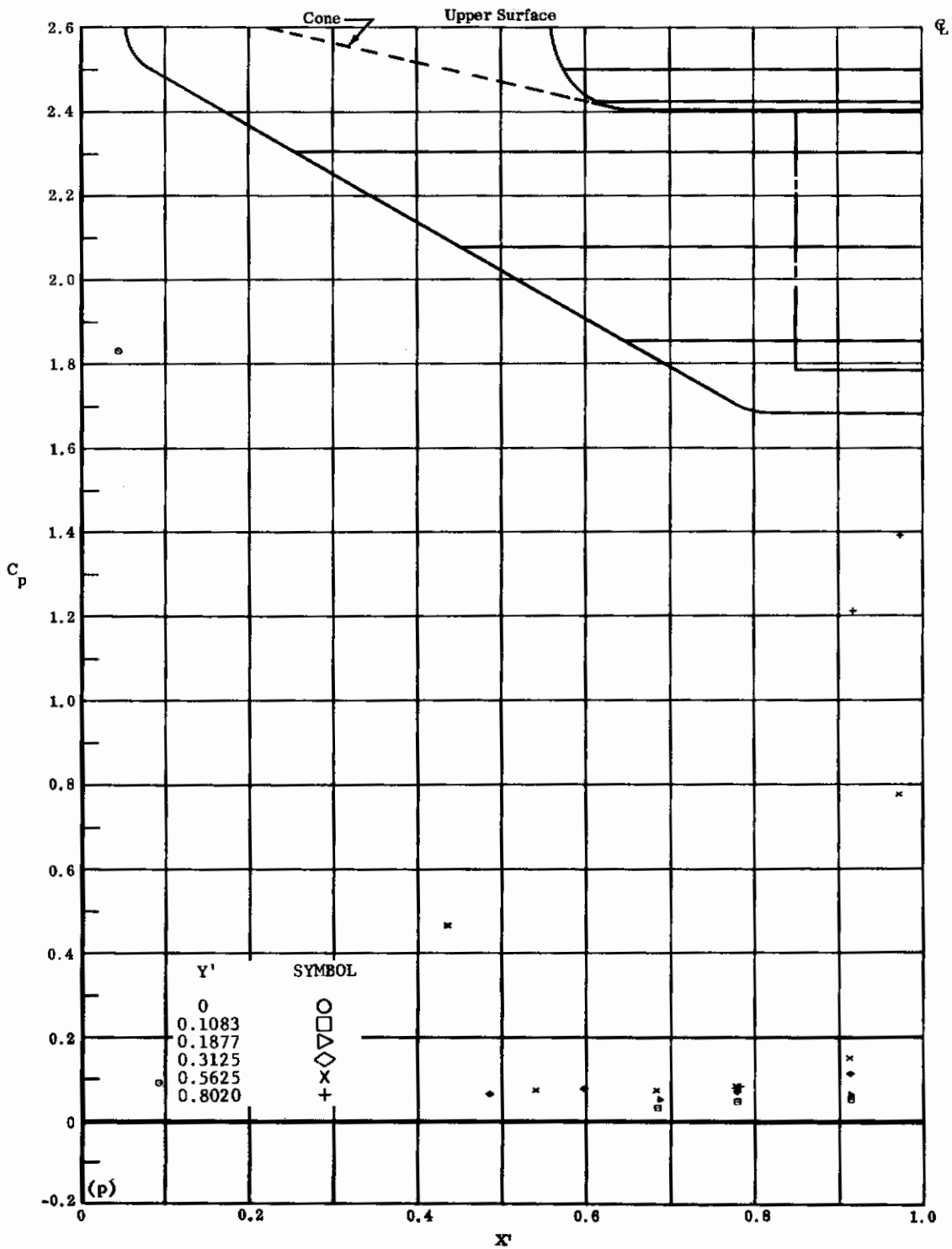

Fig. 30 Configuration IV, $\alpha = 0$, $\delta_2 = \delta_3 = -39^\circ$

o) C_p vs. Y' , upper surface

Contrails



(NONDIMENSIONAL STREAMWISE DISTANCE FROM VIRTUAL APEX)

Fig 30 Configuration IV, $a = 0$, $\delta_2 = \delta_3 = -39$

p) C_p vs. X' , upper surface

Contrails

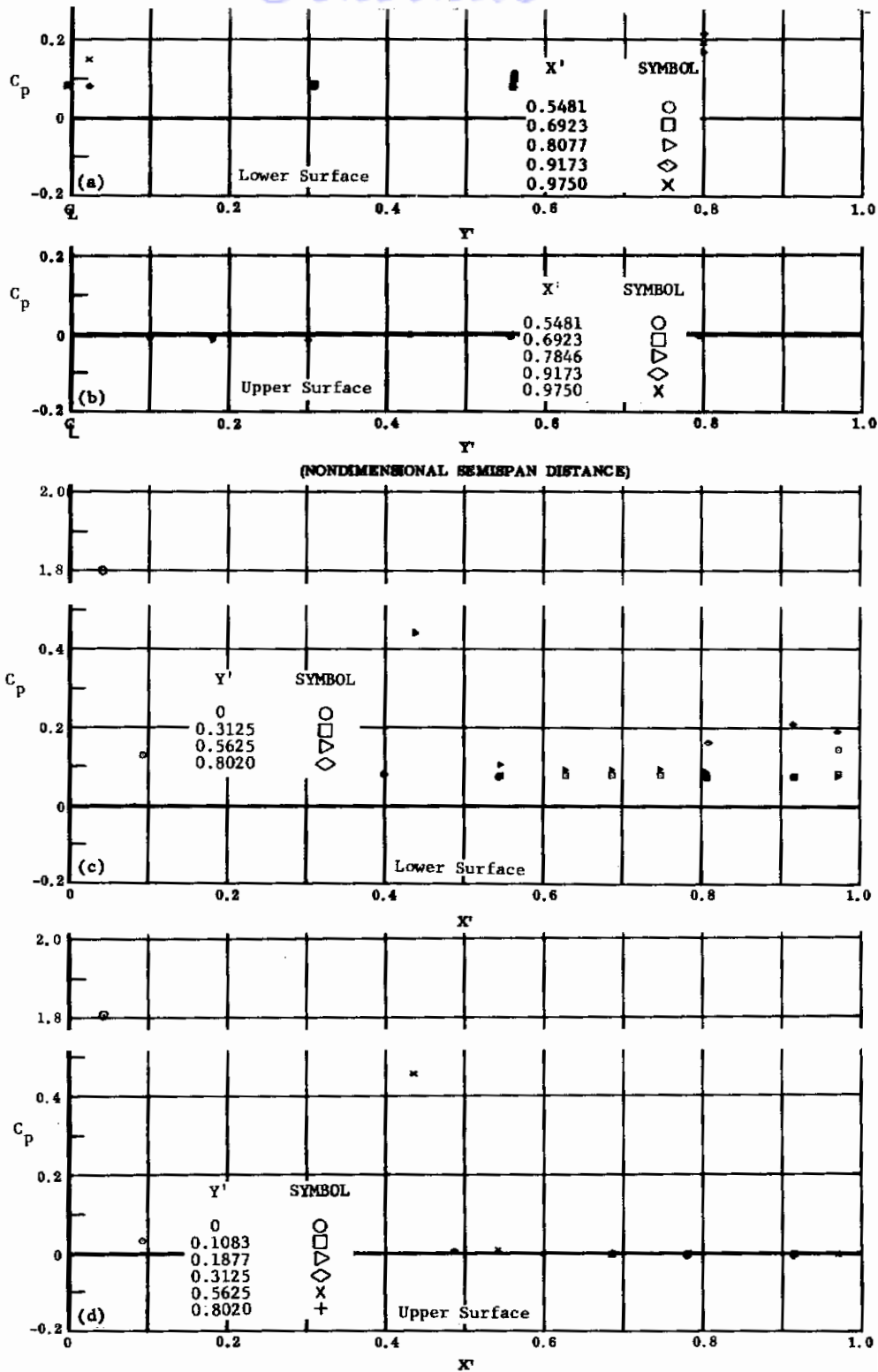
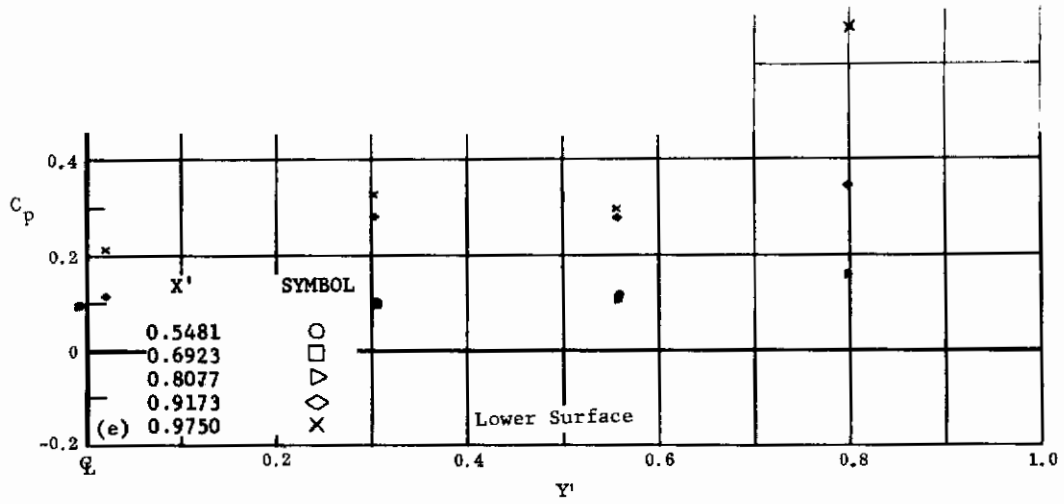

Fig. 31 Configuration IV, $\alpha = +10$, $\delta_2 = \delta_3 = 0$

- a) C_p vs. Y' , lower surface
- b) C_p vs. Y' , upper surface
- c) C_p vs. X' , lower surface
- d) C_p vs. X' , upper surface

Contrails



(NONDIMENSIONAL SEMISPAN DISTANCE)

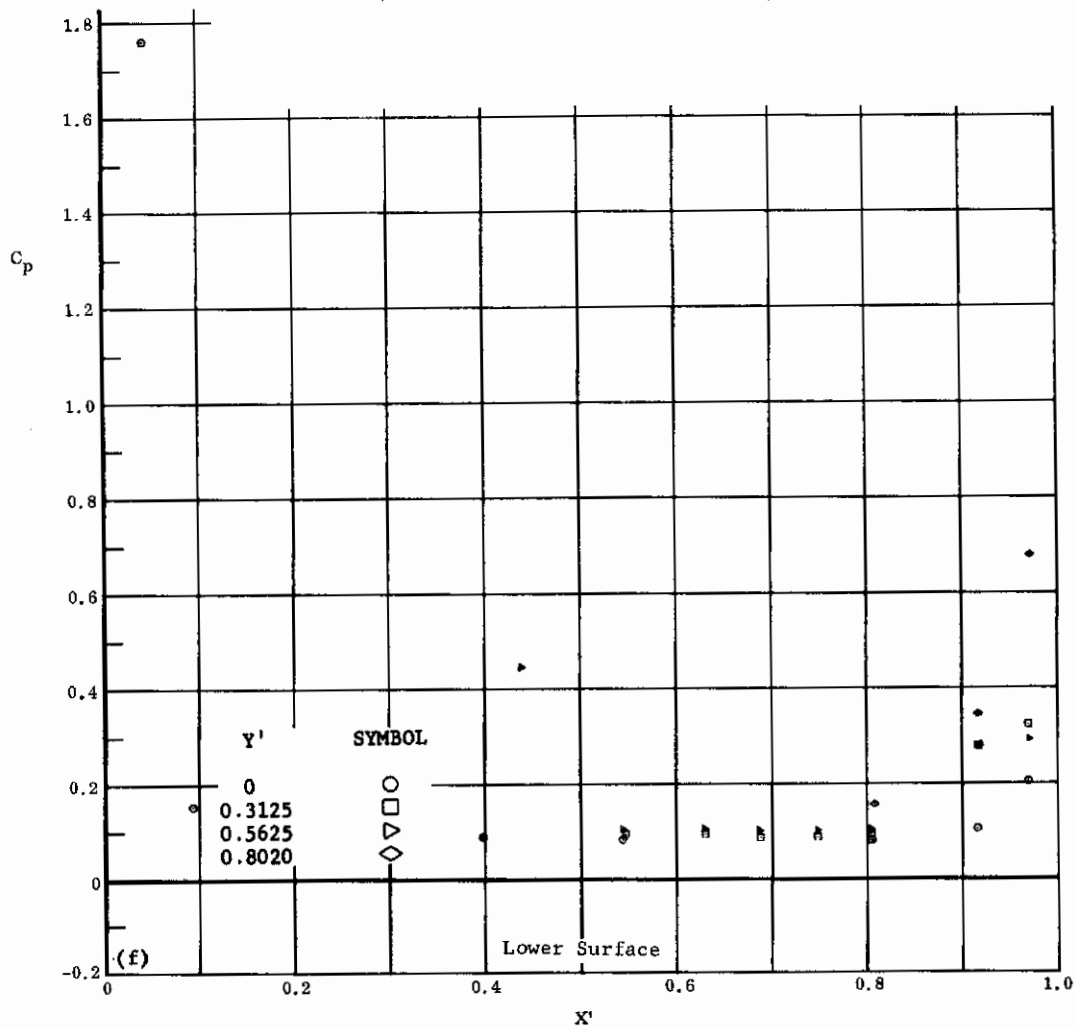

(NONDIMENSIONAL STREAMWISE DISTANCE FROM VIRTUAL APEX)

Fig. 31 Configuration IV, $\alpha = +10$, $\delta_2 = \delta_3 = +10$

e) C_p vs. Y' , lower surface

f) C_p vs. X' , lower surface

Contrails

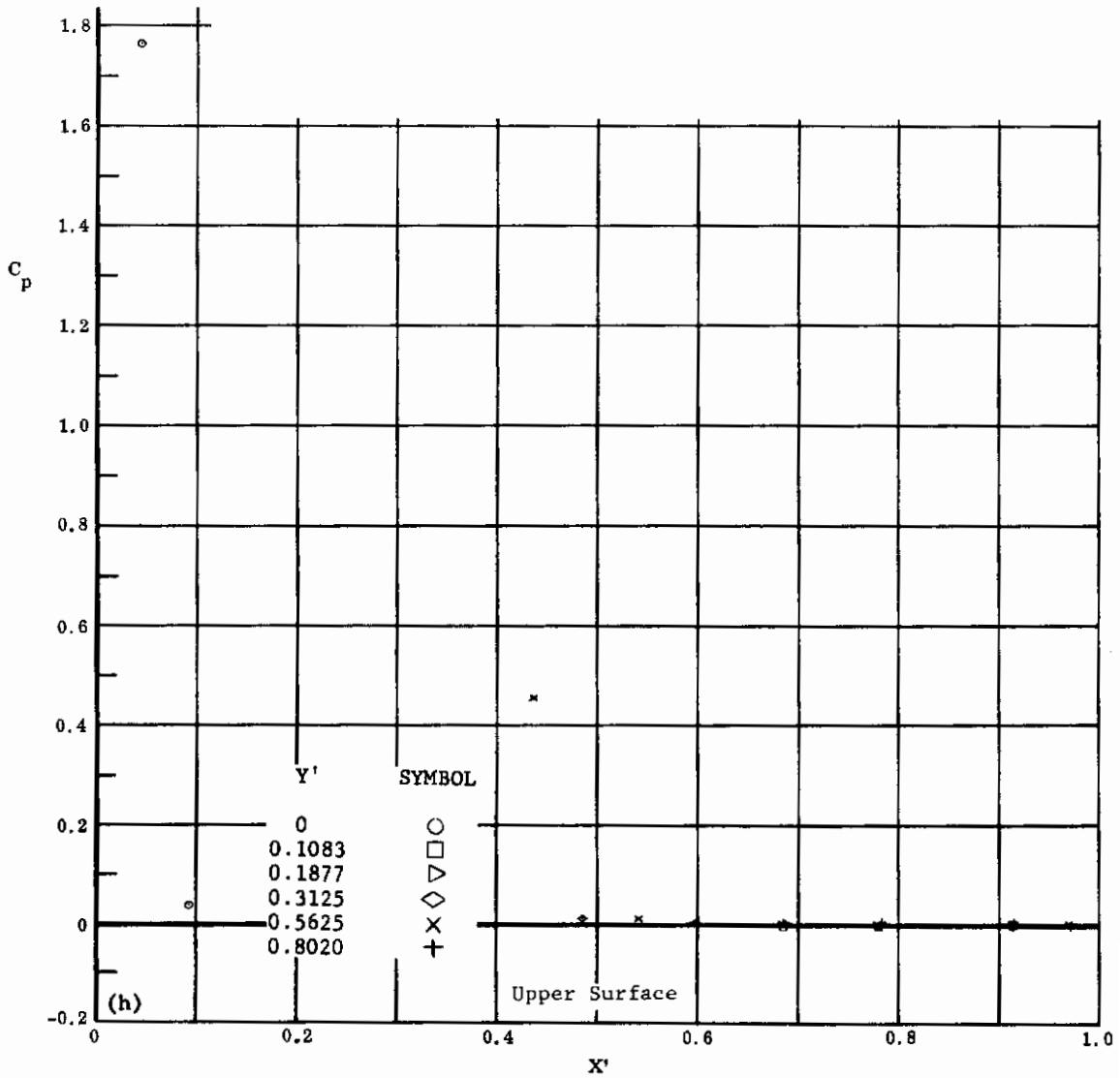
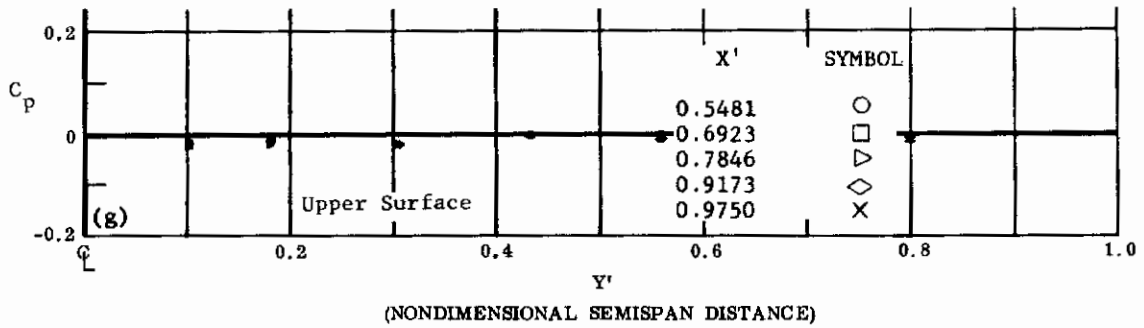

Fig. 31 Configuration IV, $\alpha = +10$, $\delta_2 = \delta_3 = +10$

g) C_p vs. Y' , upper surface

h) C_p vs. X' , upper surface

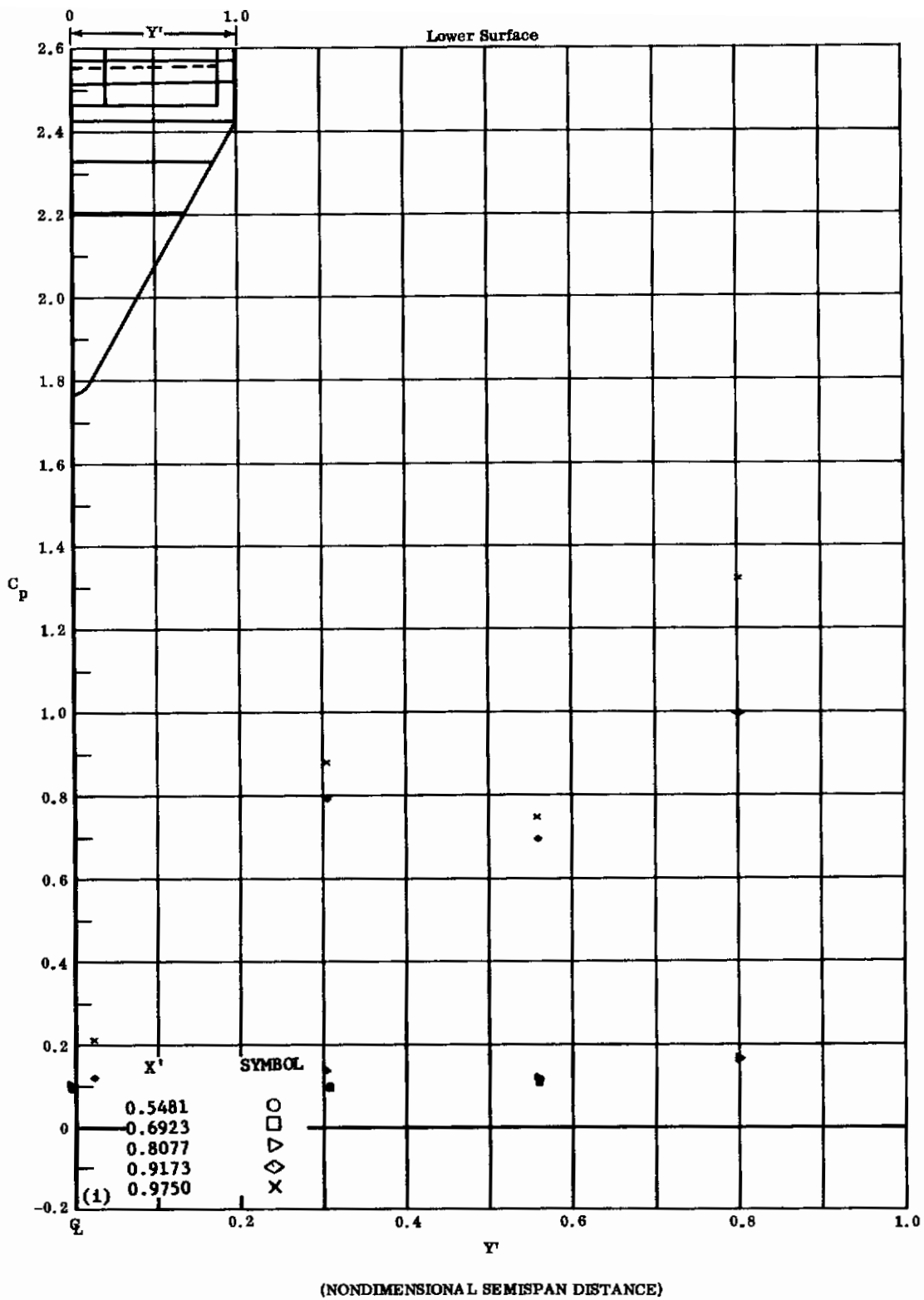
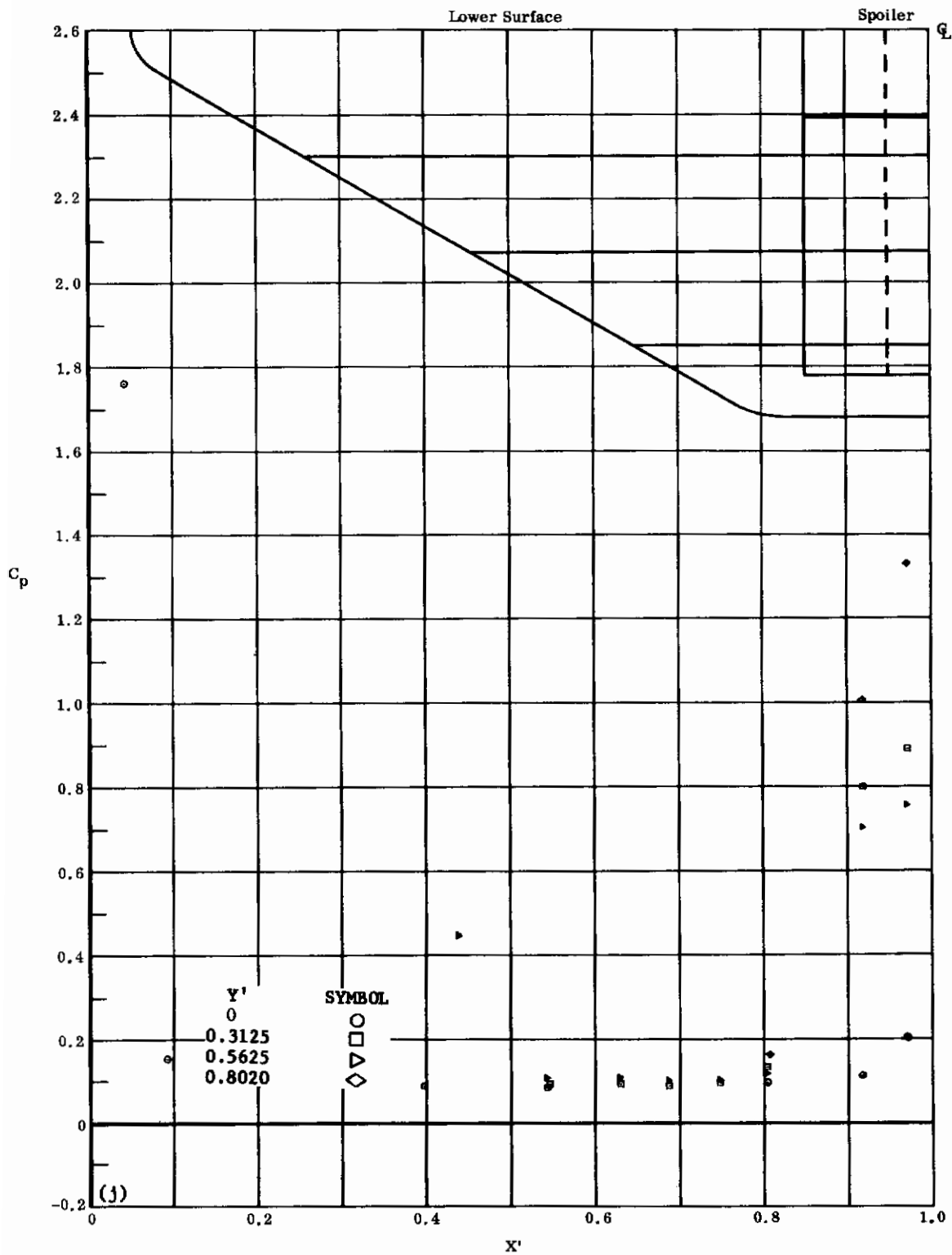

Fig. 31i Configuration IV, $\alpha = +10$, $\delta_2 = \delta_3 = +20$

C_p vs. Y' , lower surface



(NONDIMENSIONAL STREAMWISE DISTANCE FROM VIRTUAL APEX)

Fig. 31j Configuration IV, $\alpha = +10$, $\delta_2 = \delta_3 = +20$

C_p vs. X' , lower surface

Contrails

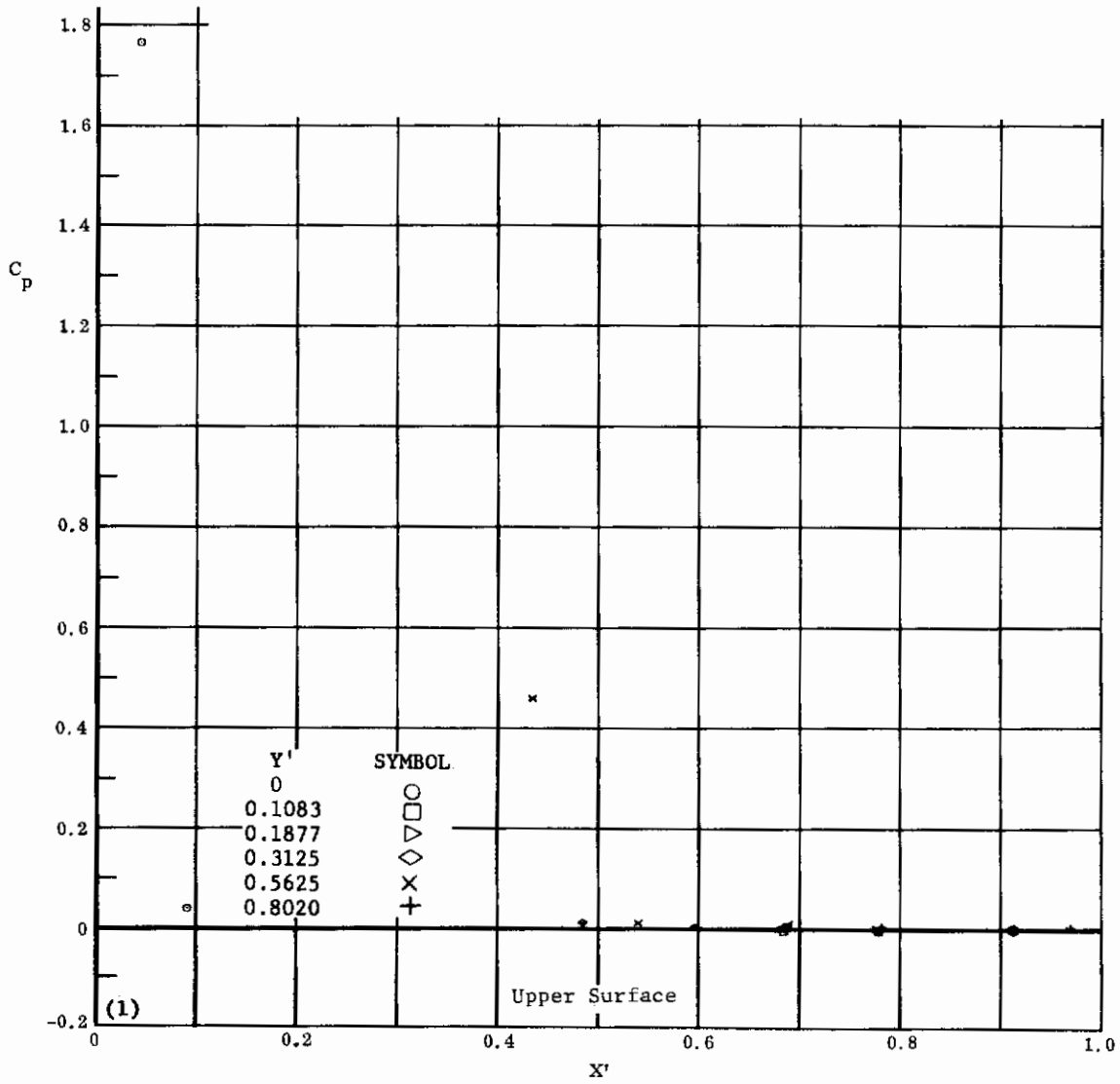
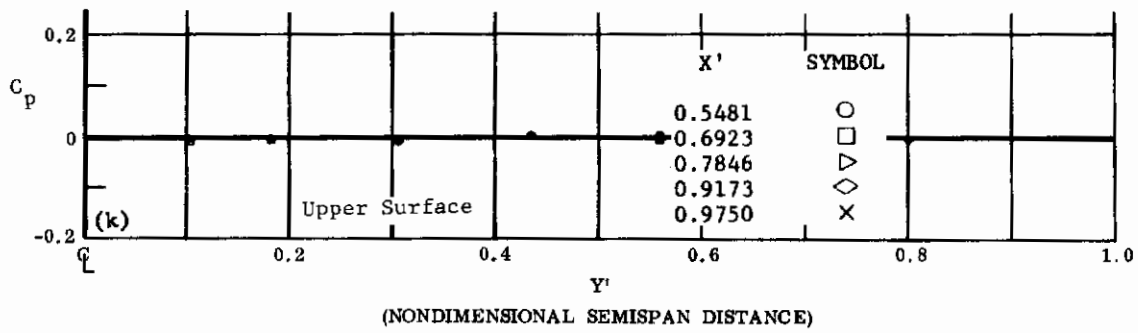

(NONDIMENSIONAL STREAMWISE DISTANCE FROM VIRTUAL APEX)

Fig. 31 Configuration IV, $\alpha = +10$, $\delta_2 = \delta_3 = +20$

k) C_p vs. Y' , upper surface

l) C_p vs. X' , upper surface

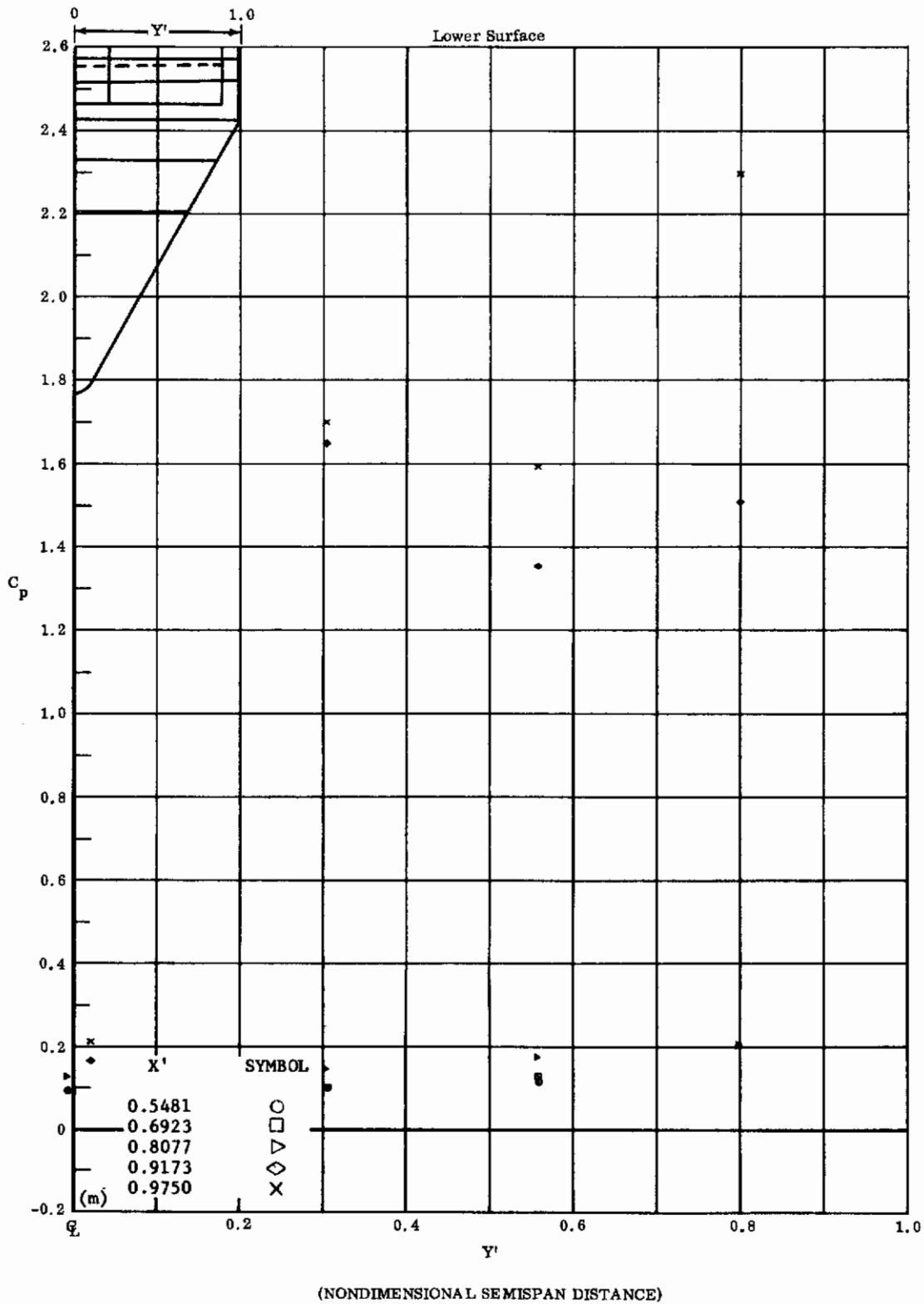
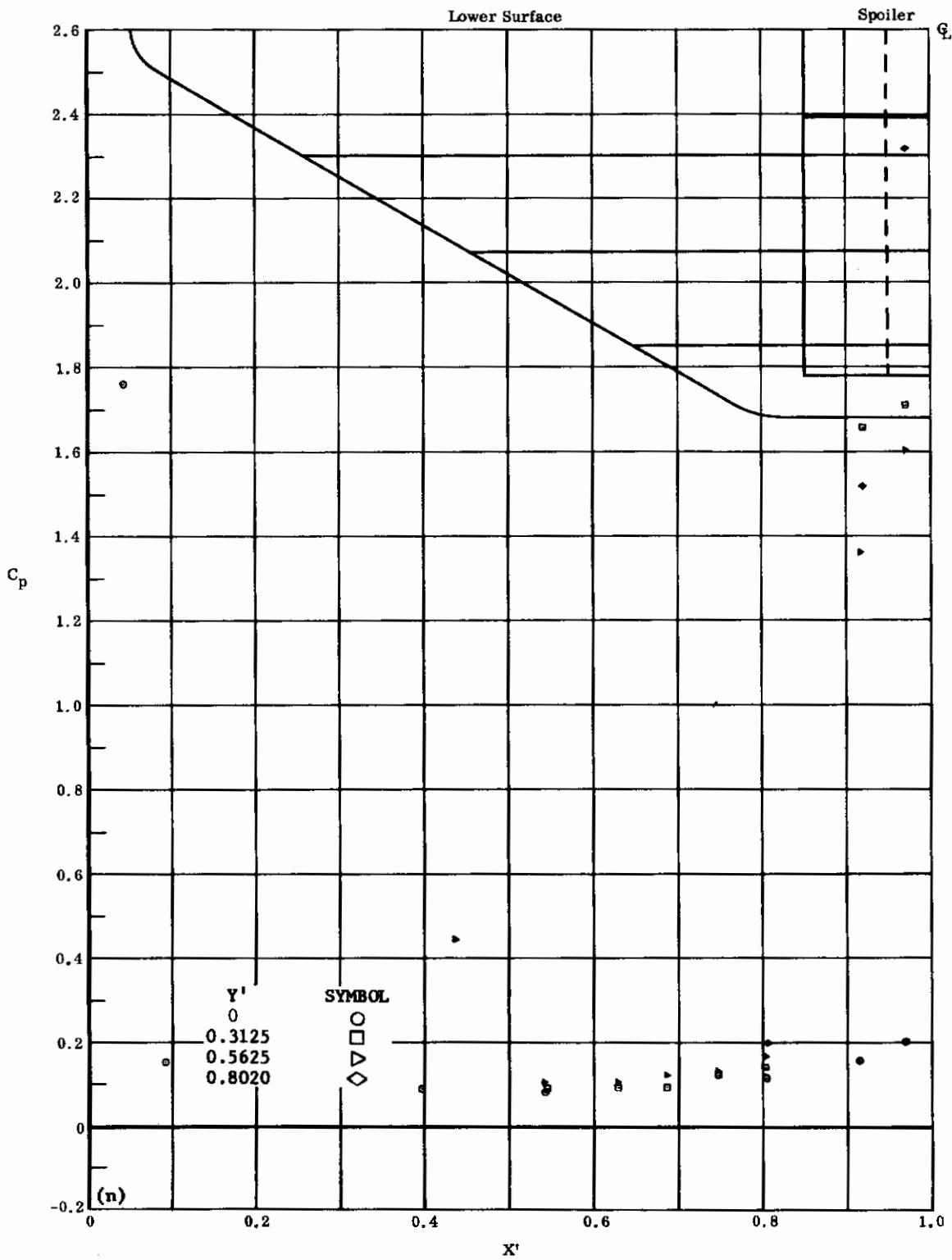

Fig. 31m Configuration IV, $\alpha = +10$, $\delta_2 = \delta_3 = +30$
 C_p vs. Y' , lower surface



(NONDIMENSIONAL STREAMWISE DISTANCE FROM VIRTUAL APEX)

Fig. 3ln Configuration IV, $\alpha = +10$, $\delta_2 = \delta_3 = +30$

C_p vs. X' , lower surface

Contrails

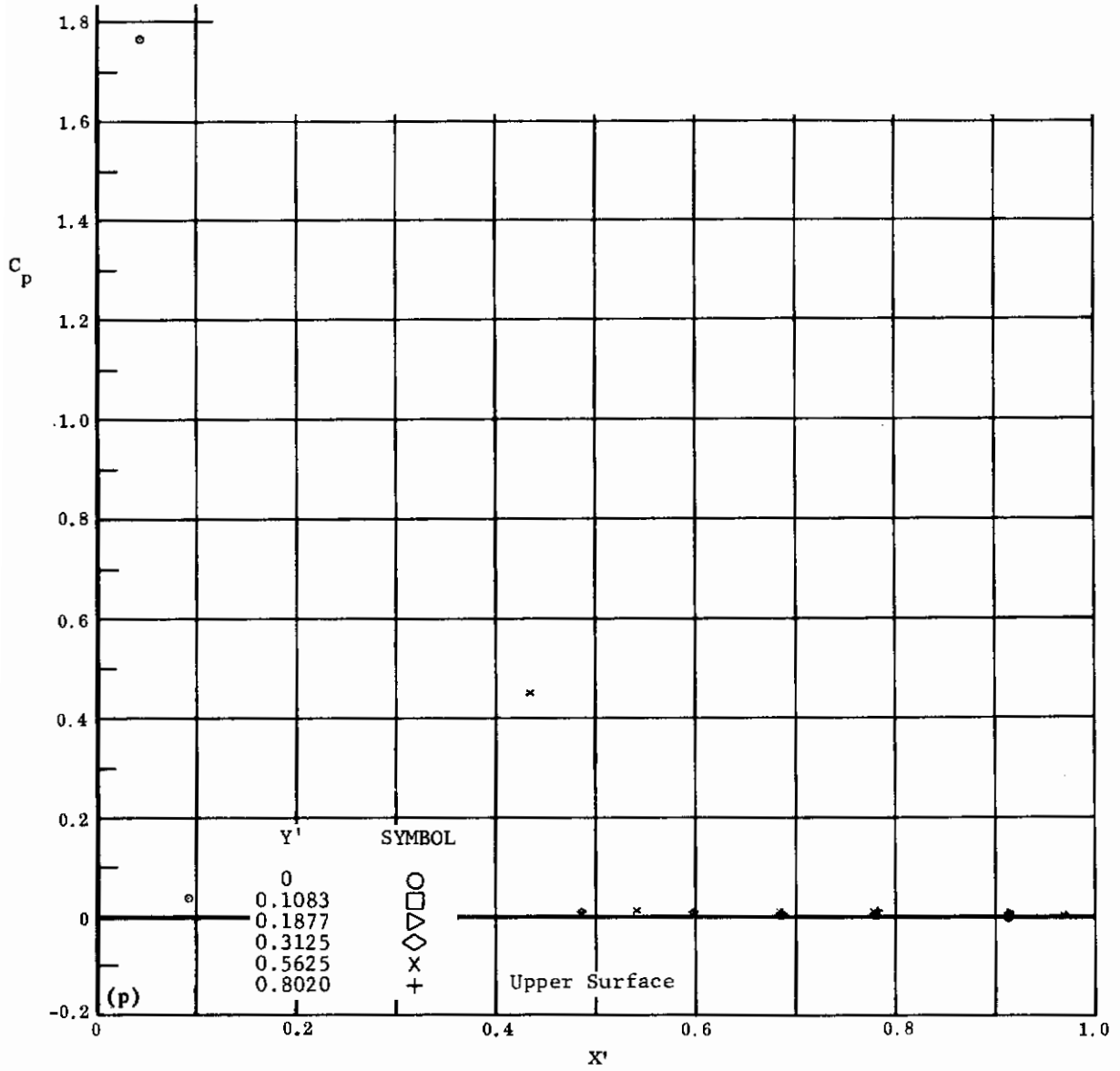
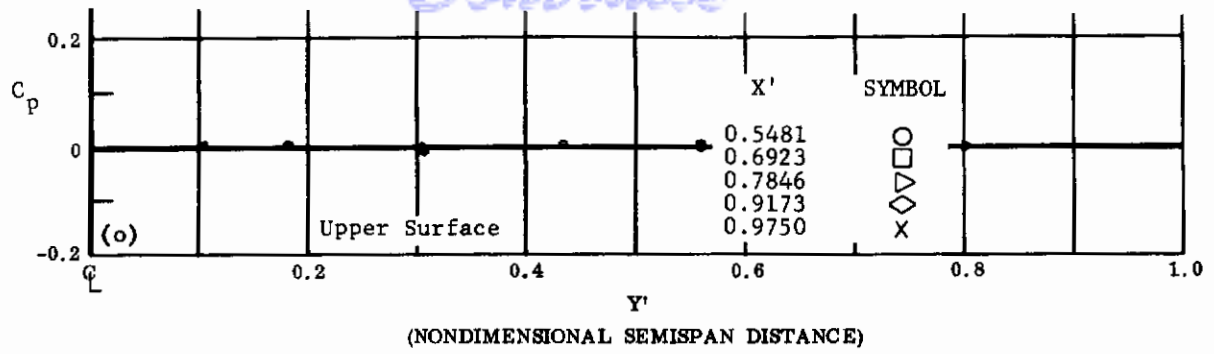

Fig. 31 Configuration IV, $\alpha = +10$, $\delta_2 = \delta_3 = +30$

- o) C_p vs. Y' , upper surface
- p) C_p vs. X' , upper surface

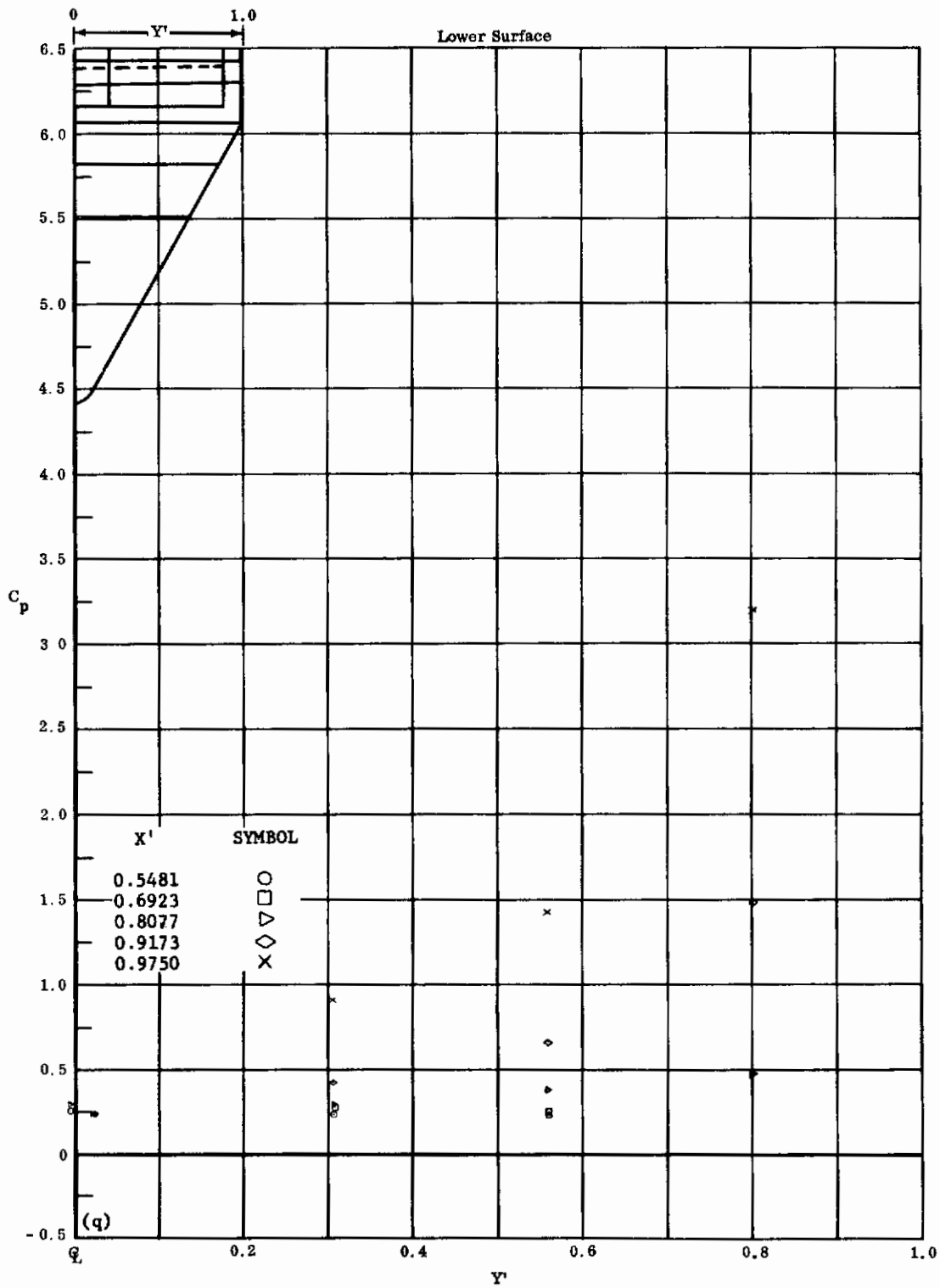
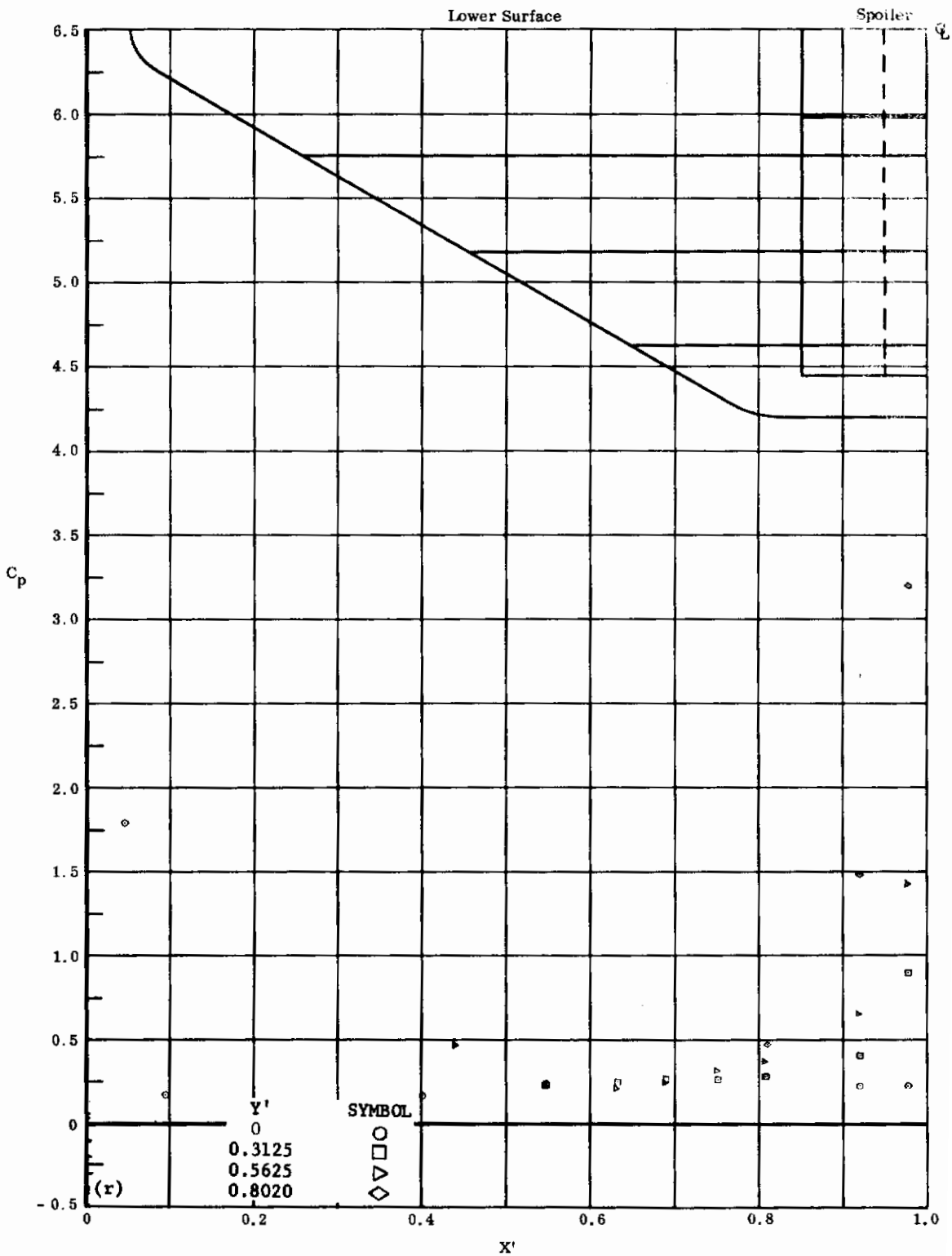

Fig. 31q Configuration IV, $\alpha = +10$, $\delta_2 = \delta_3 = +39$

C_p vs. Y' , lower surface



(NONDIMENSIONAL STREAMWISE DISTANCE FROM VIRTUAL APEX)

Fig. 31r Configuration IV, $\alpha = +10$, $\delta_2 = \delta_3 = +39$

C_p vs. X' , lower surface

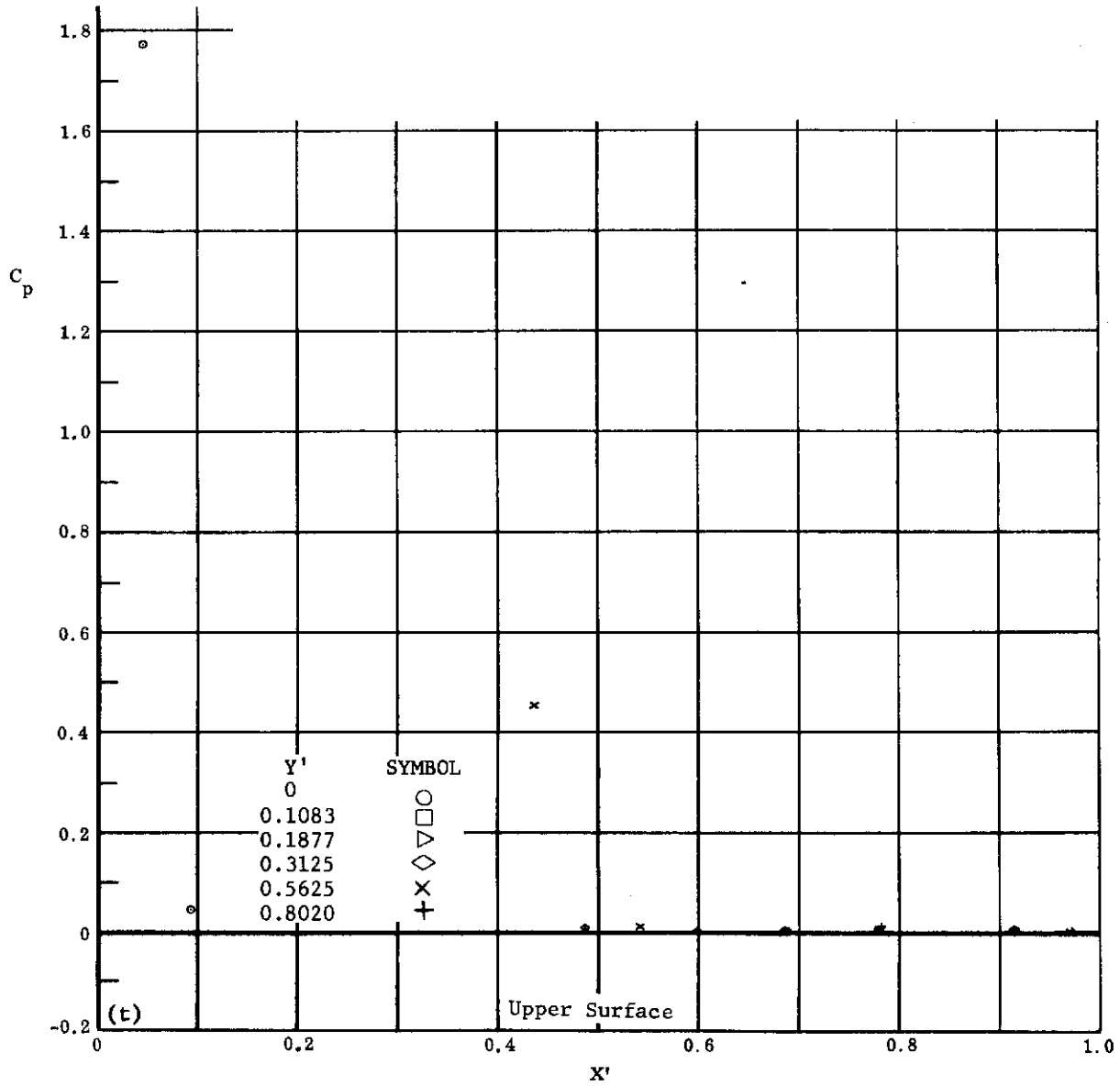
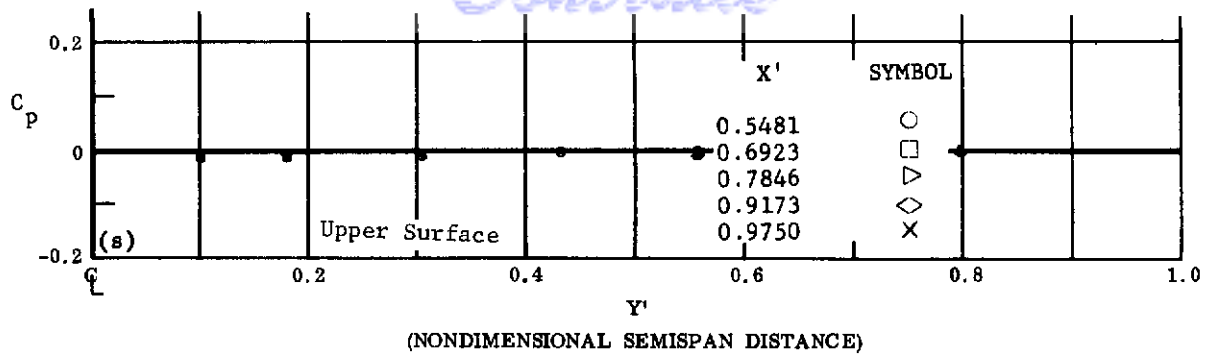

(NONDIMENSIONAL STREAMWISE DISTANCE FROM VIRTUAL APEX)

Fig. 31 Configuration IV, $\alpha = +10$, $\delta_2 = \delta_3 = +39$

s) C_p vs. Y' , upper surface

t) C_p vs. X' , upper surface

Contrails

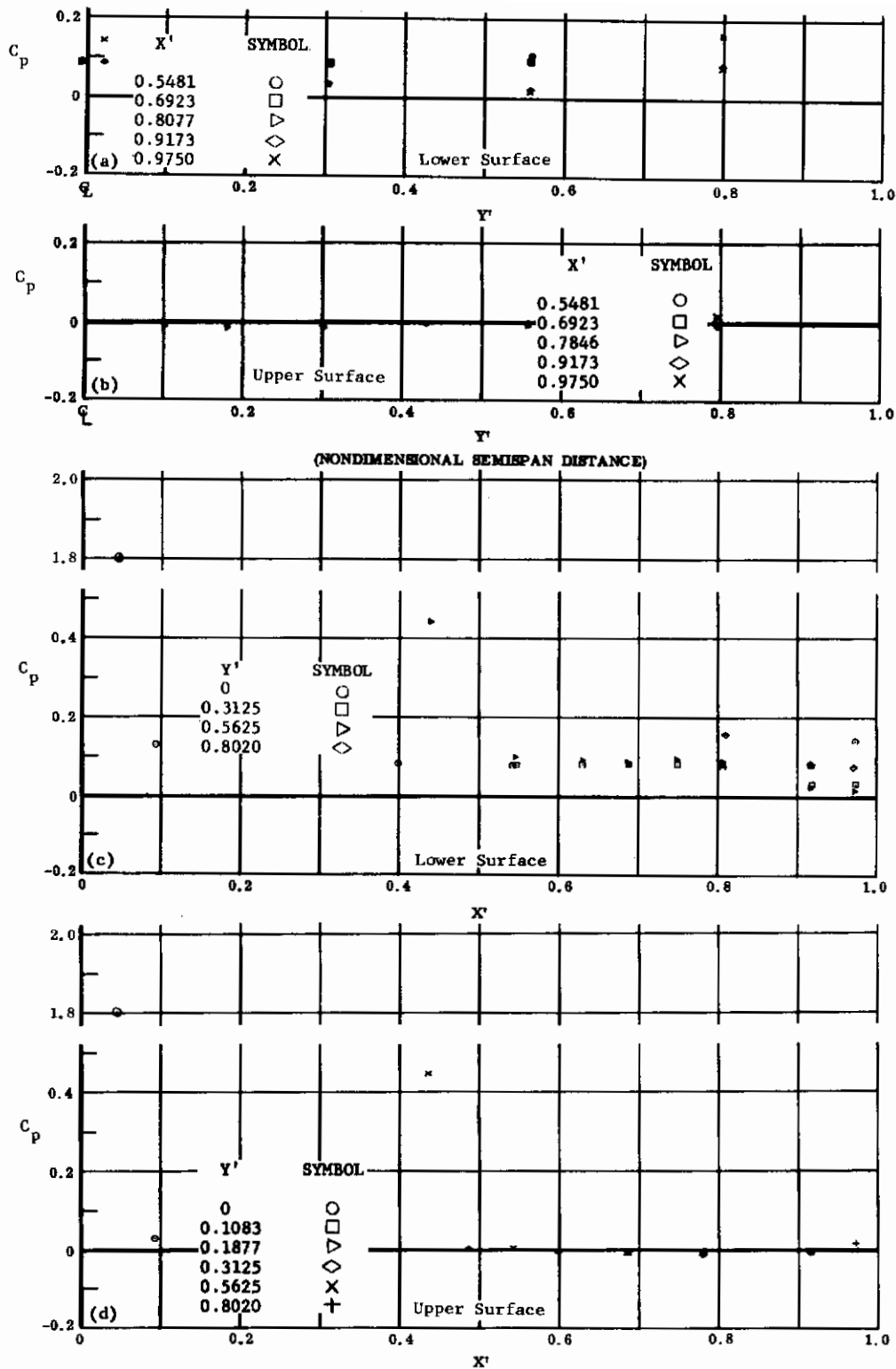

Fig. 32 Configuration IV, $\alpha = +10$, $\delta_2 = \delta_3 = -10$

- a) C_p vs. Y' , lower surface
- b) C_p vs. Y' , upper surface
- c) C_p vs. X' , lower surface
- d) C_p vs. X' , upper surface

Contrails

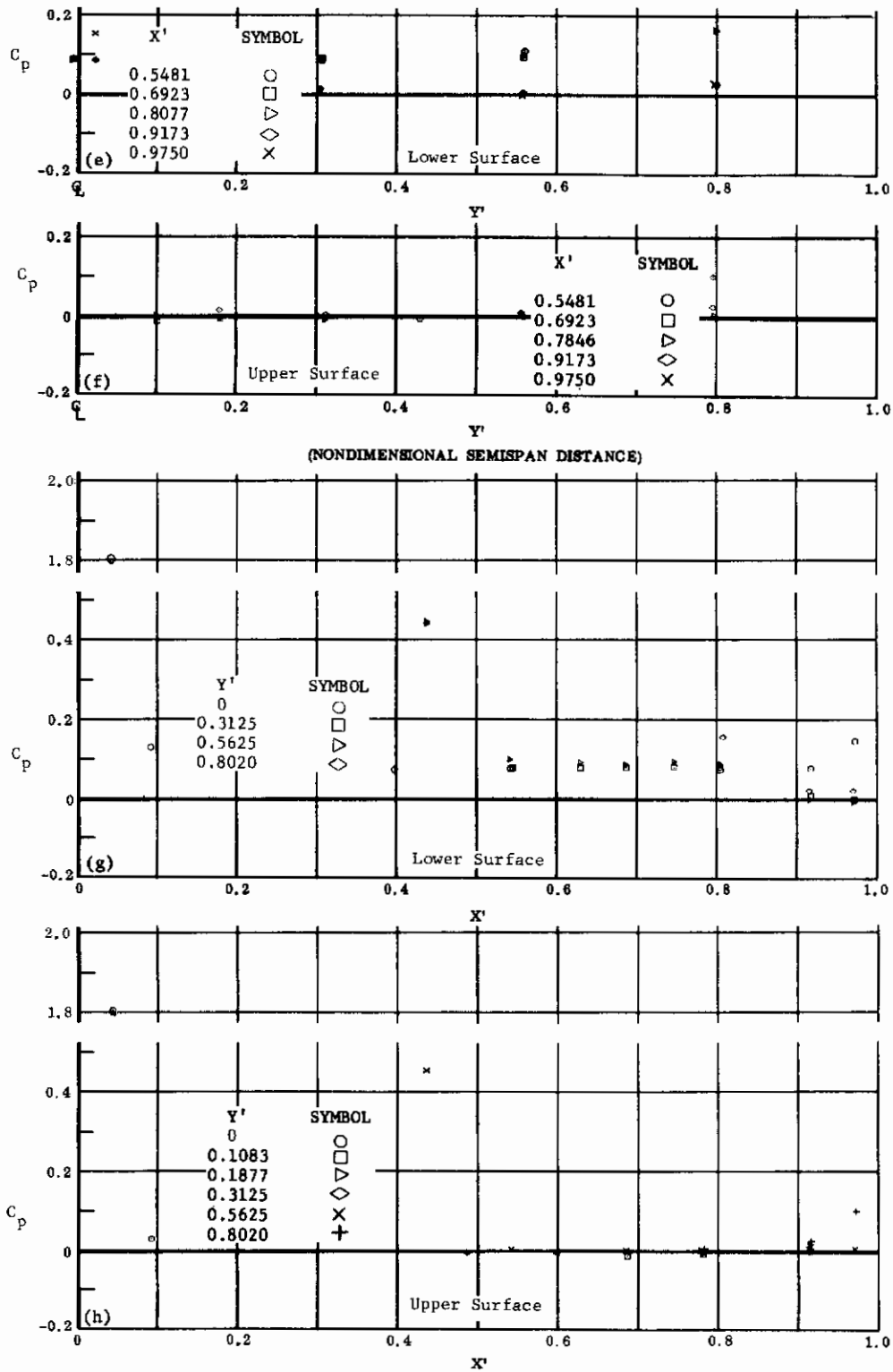

Fig. 32 Configuration IV, $\alpha = +10$, $\delta_2 = \delta_3 = -20$

- e) C_p vs. Y' , lower surface
- f) C_p vs. Y' , upper surface
- g) C_p vs. X' , lower surface
- h) C_p vs. X' , upper surface

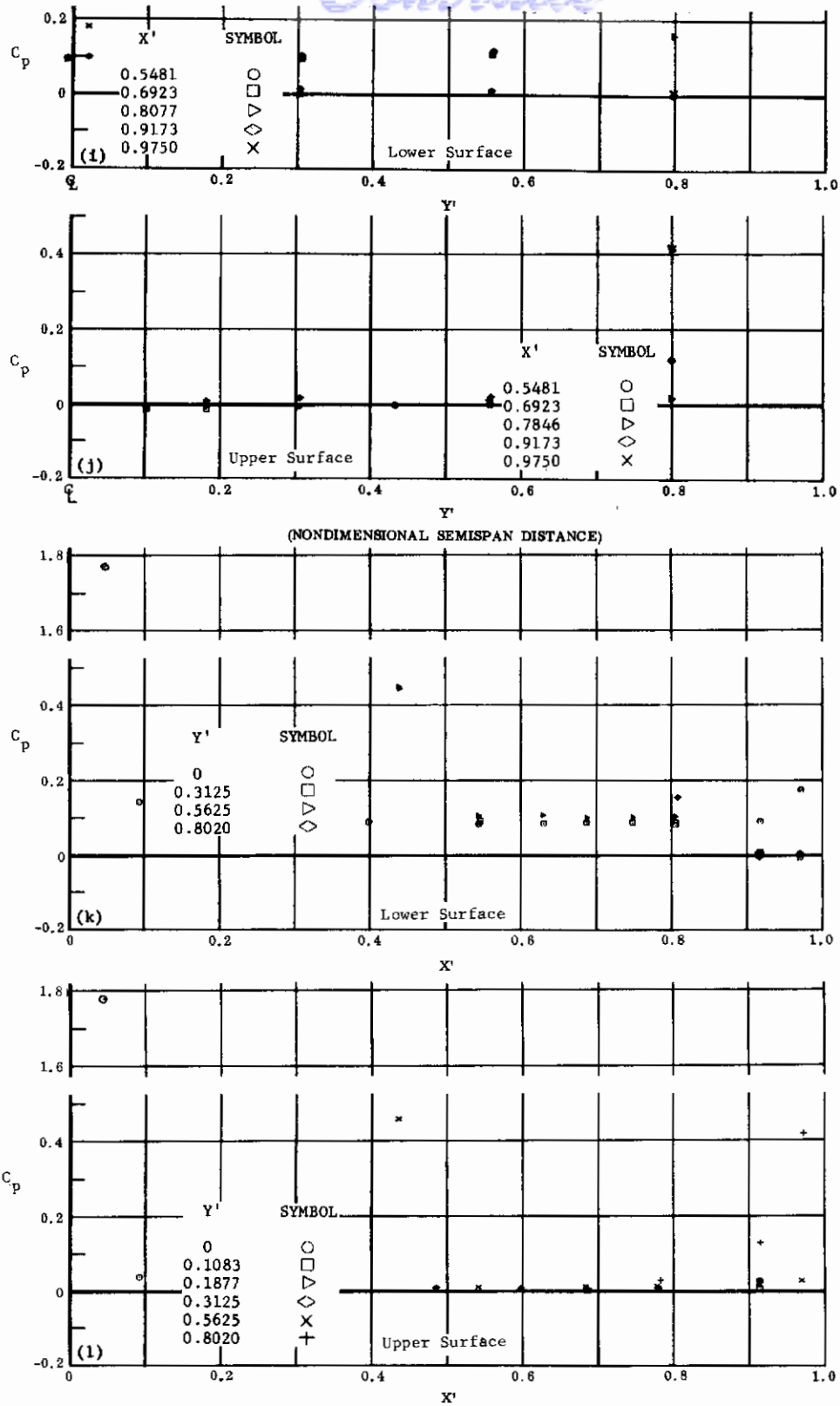

Fig. 32 Configuration IV, $\alpha = +10$, $\delta_2 = \delta_3 = -30$

- i) C_p vs. Y' , lower surface
- j) C_p vs. Y' , upper surface
- k) C_p vs. X' , lower surface
- l) C_p vs. X' , upper surface

Contrails

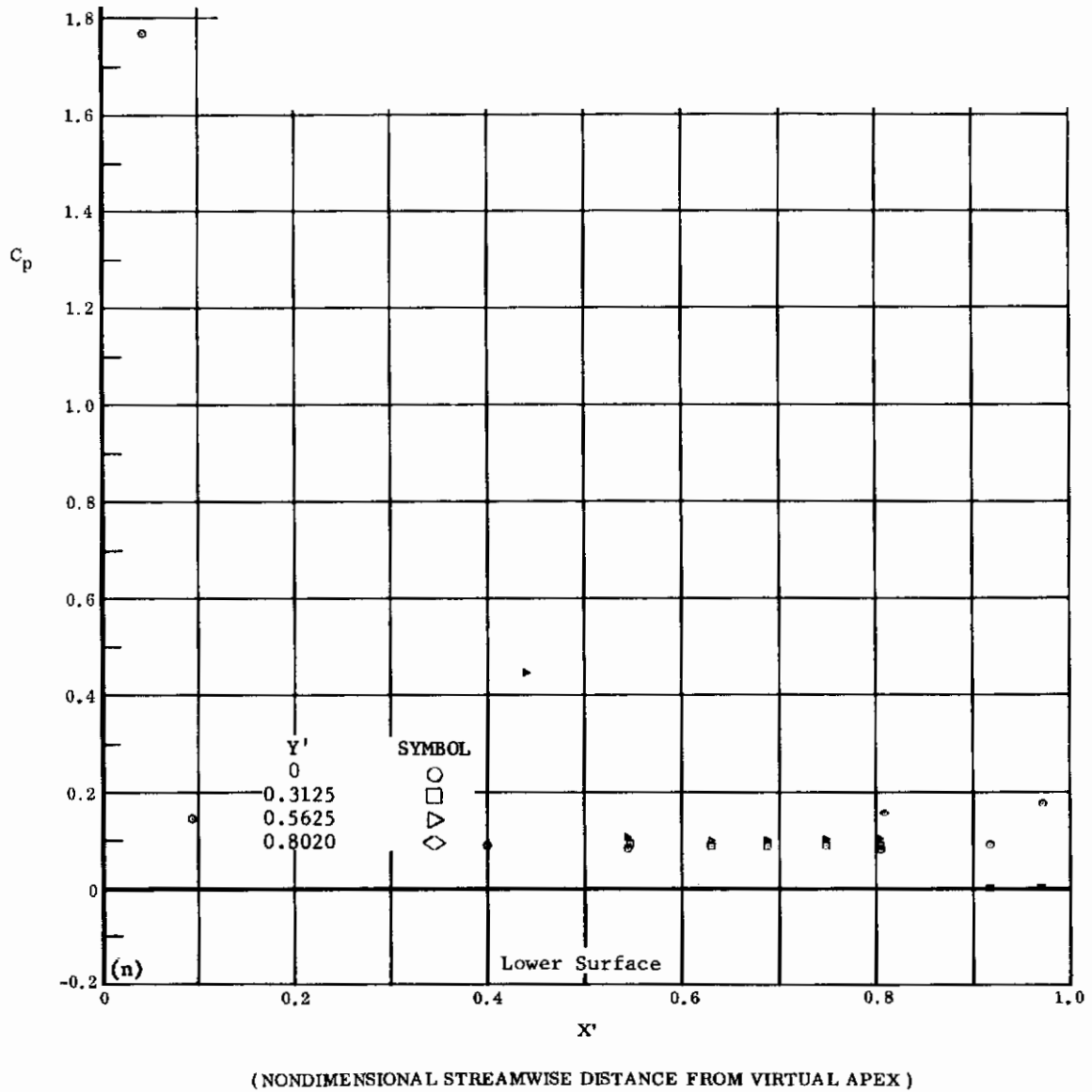
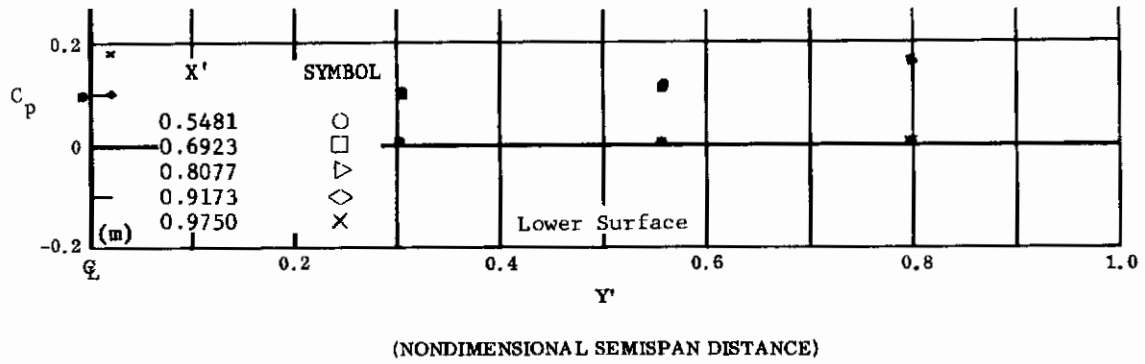
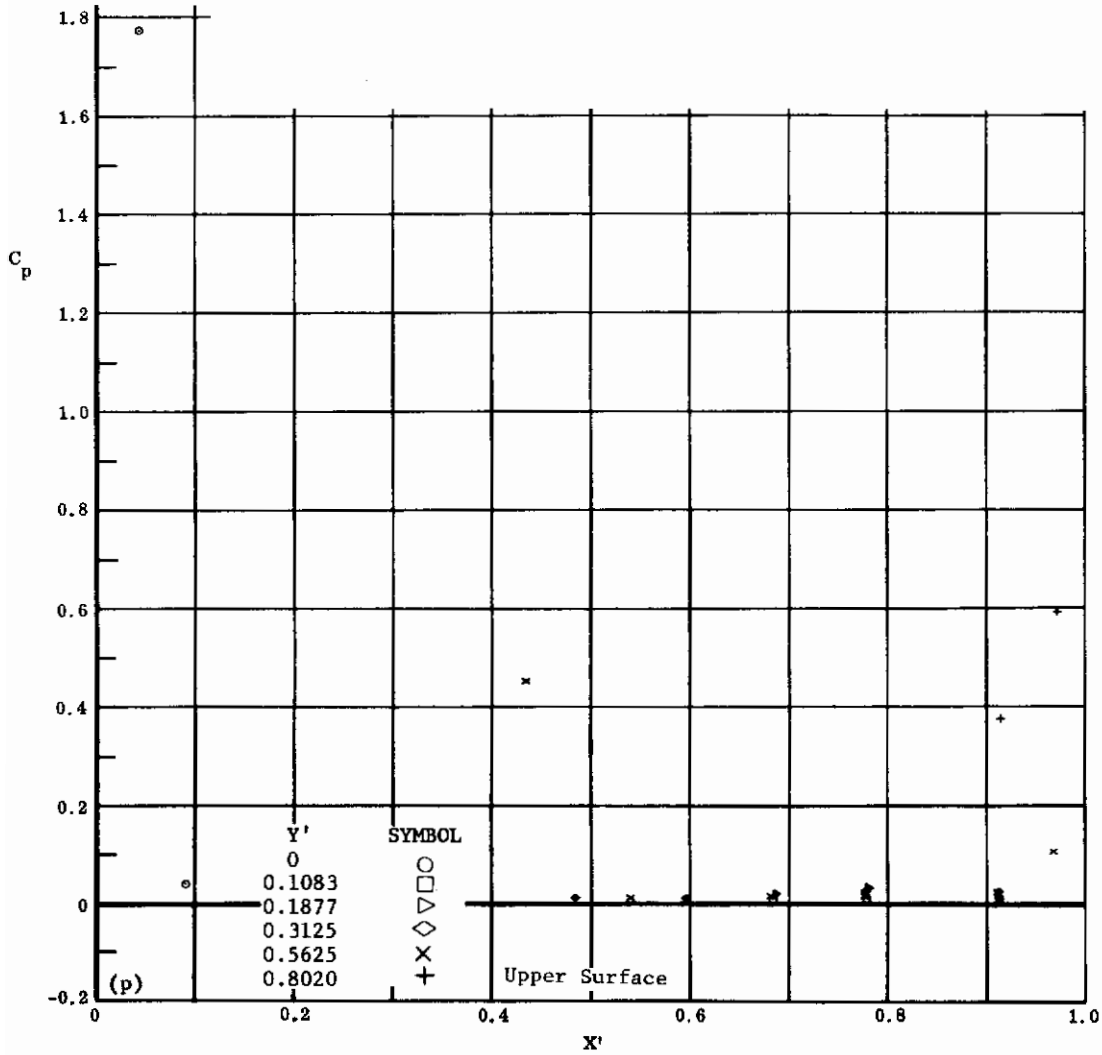
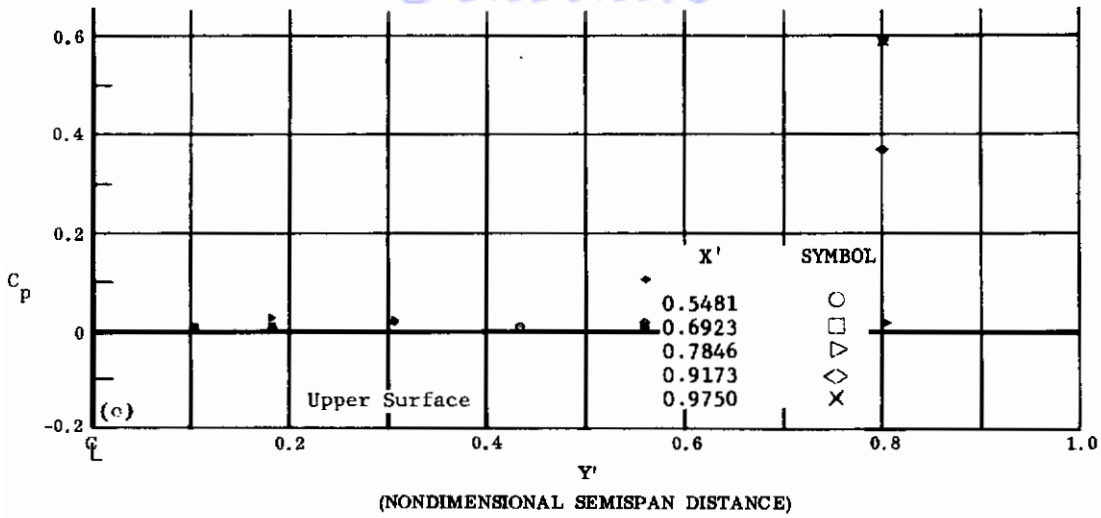

Fig. 32 Configuration IV, $\alpha = +10$, $\delta_2 = \delta_3 = -39$

m) C_p vs. Y' , lower surface

n) C_p vs. X' , lower surface

Contrails



(NONDIMENSIONAL STREAMWISE DISTANCE FROM VIRTUAL APEX)

Fig. 32 Configuration IV, $\alpha = +10$, $\delta_2 = \delta_3 = -39$

o) C_p vs. Y' , upper surface

p) C_p vs. X' , upper surface

Contrails

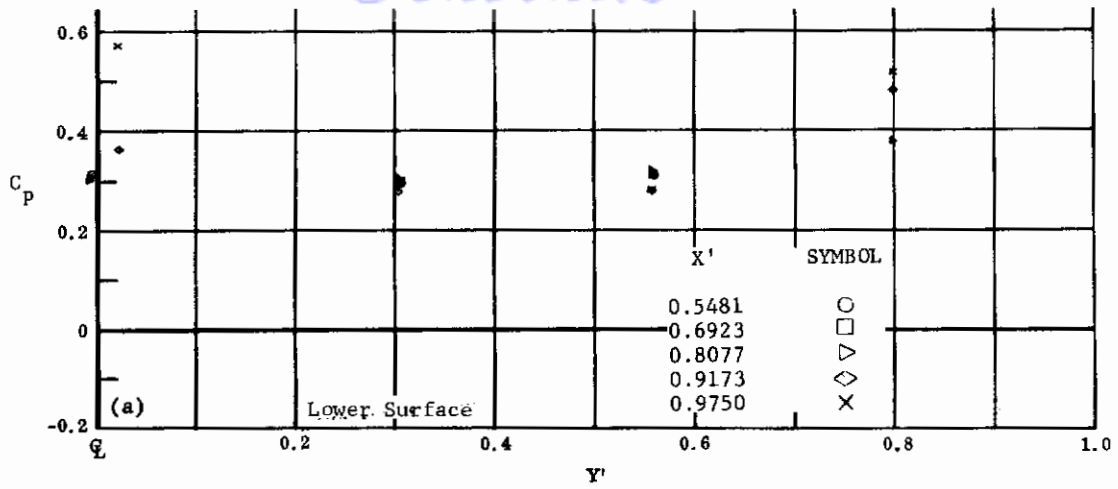

(NONDIMENSIONAL SEMISPAN DISTANCE)

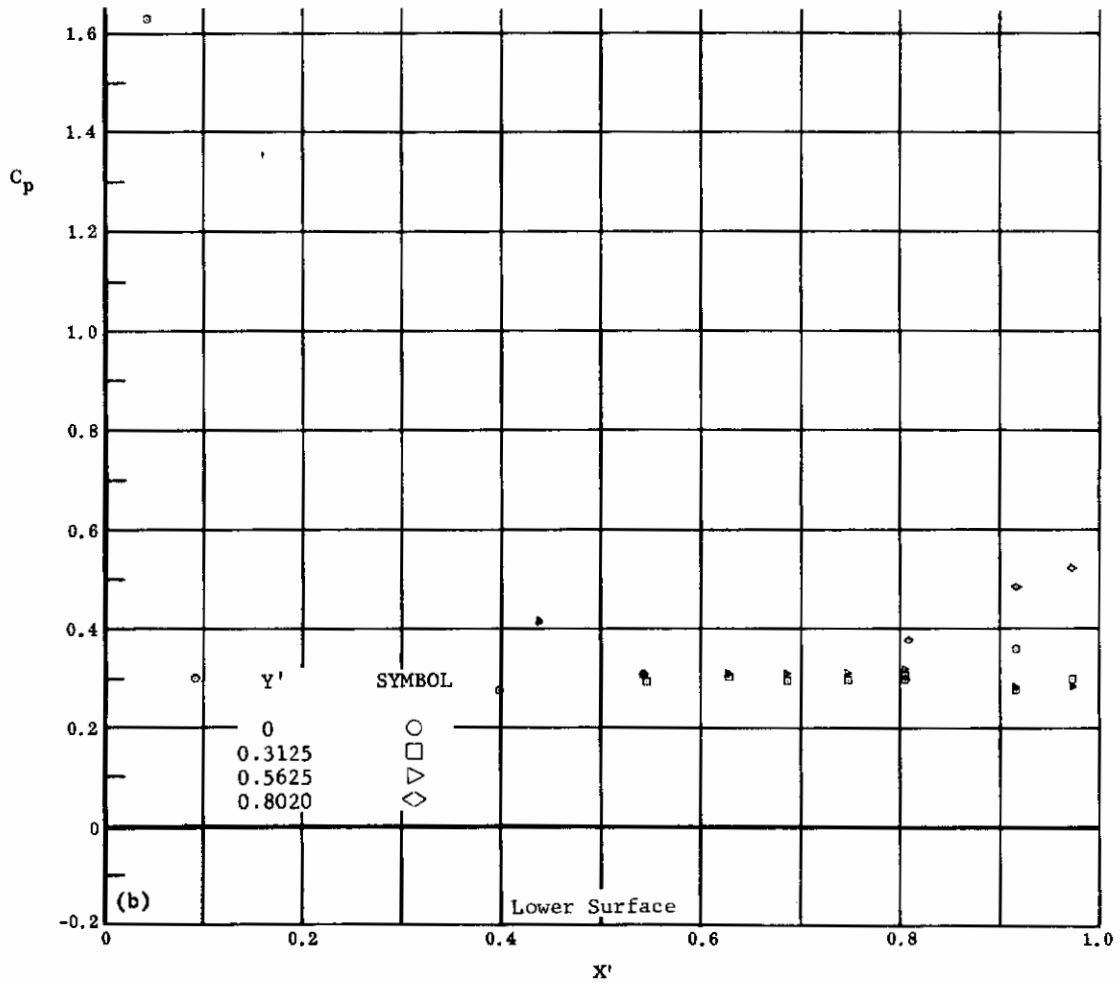

(NONDIMENSIONAL STREAMWISE DISTANCE FROM VIRTUAL APEX)

Fig. 33 Configuration IV, $\alpha = +20$, $\delta_2 = \delta_3 = 0$

a) C_p vs. Y' , lower surface

b) C_p vs. X' , lower surface

Contraails

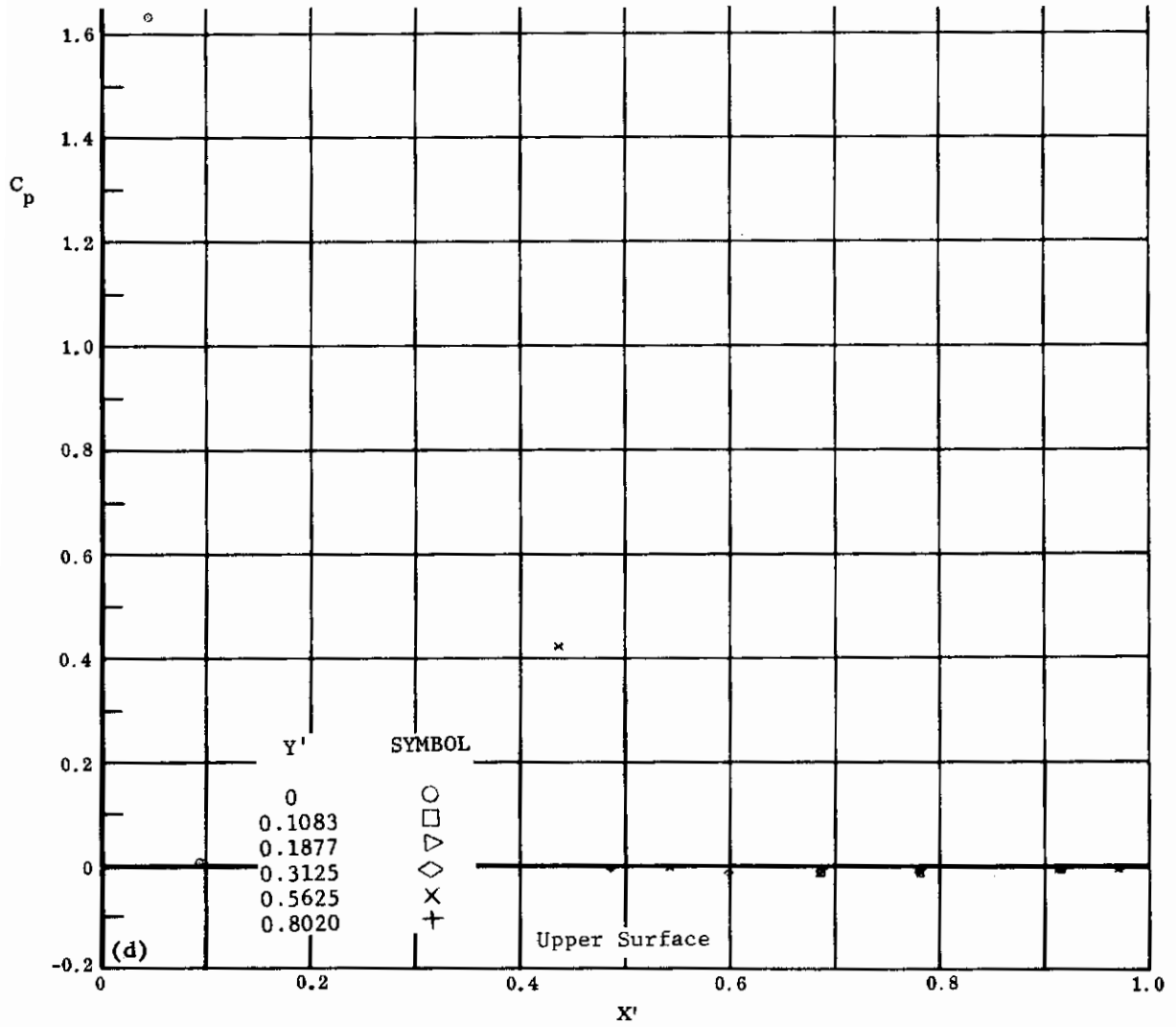
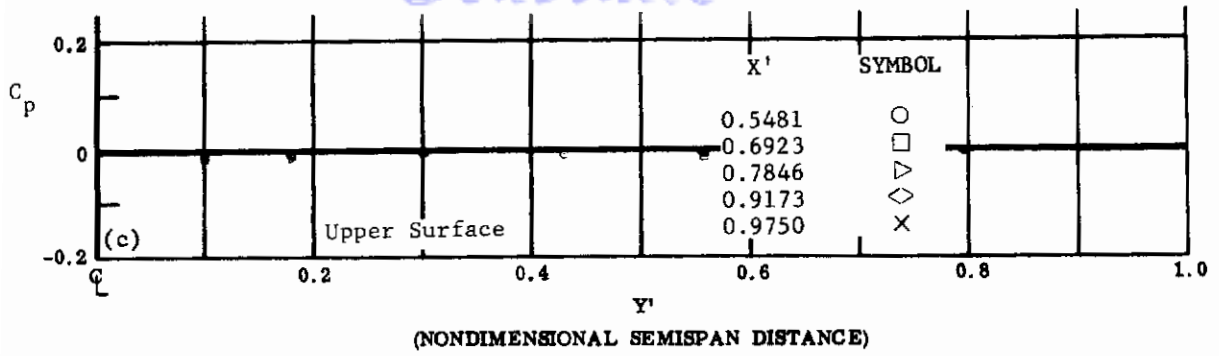

Fig. 33 Configuration IV, $\alpha = +20$, $\delta_2 = \delta_3 = 0$

c) C_p vs. Y' , upper surface

d) C_p vs. X' , upper surface

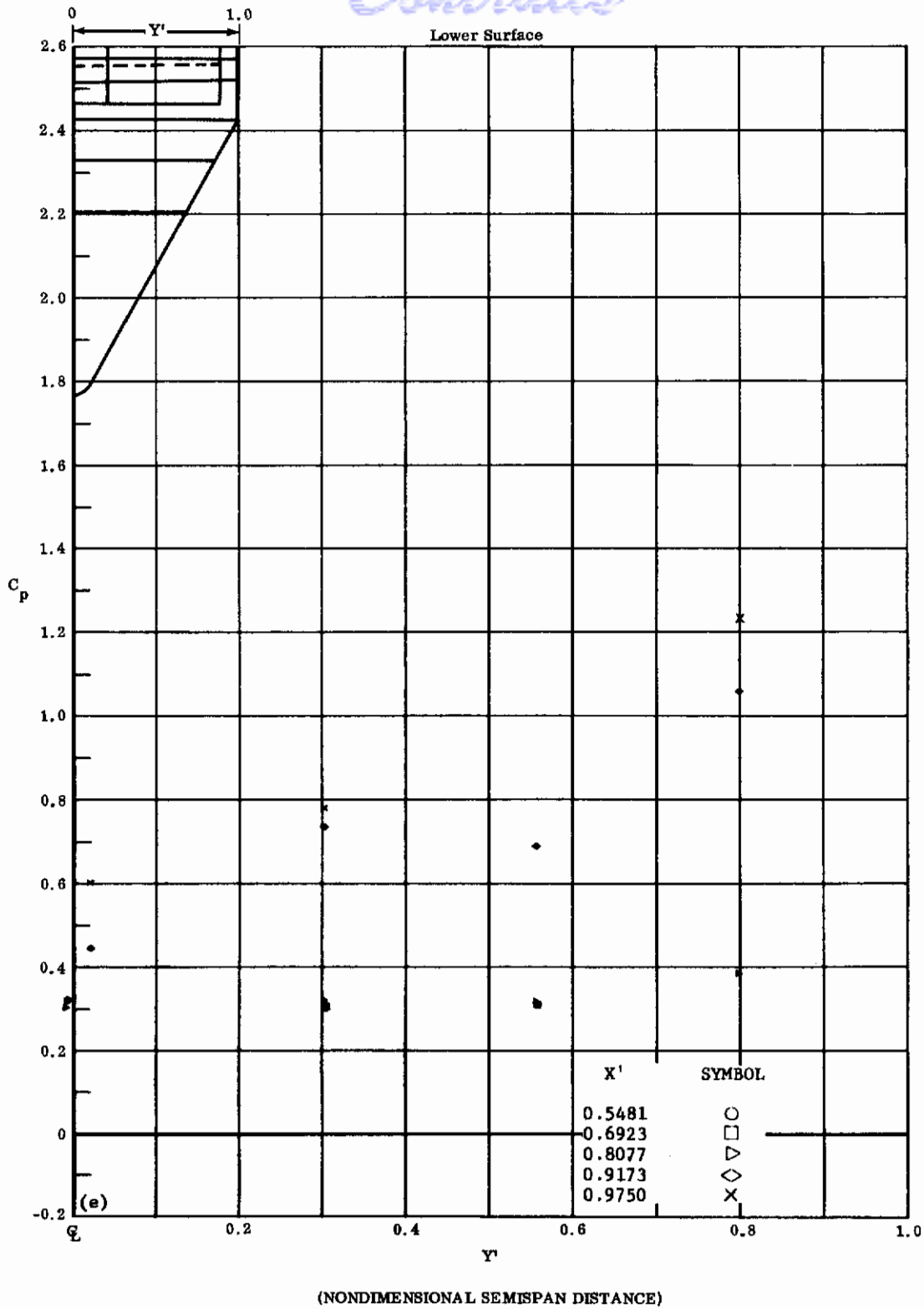
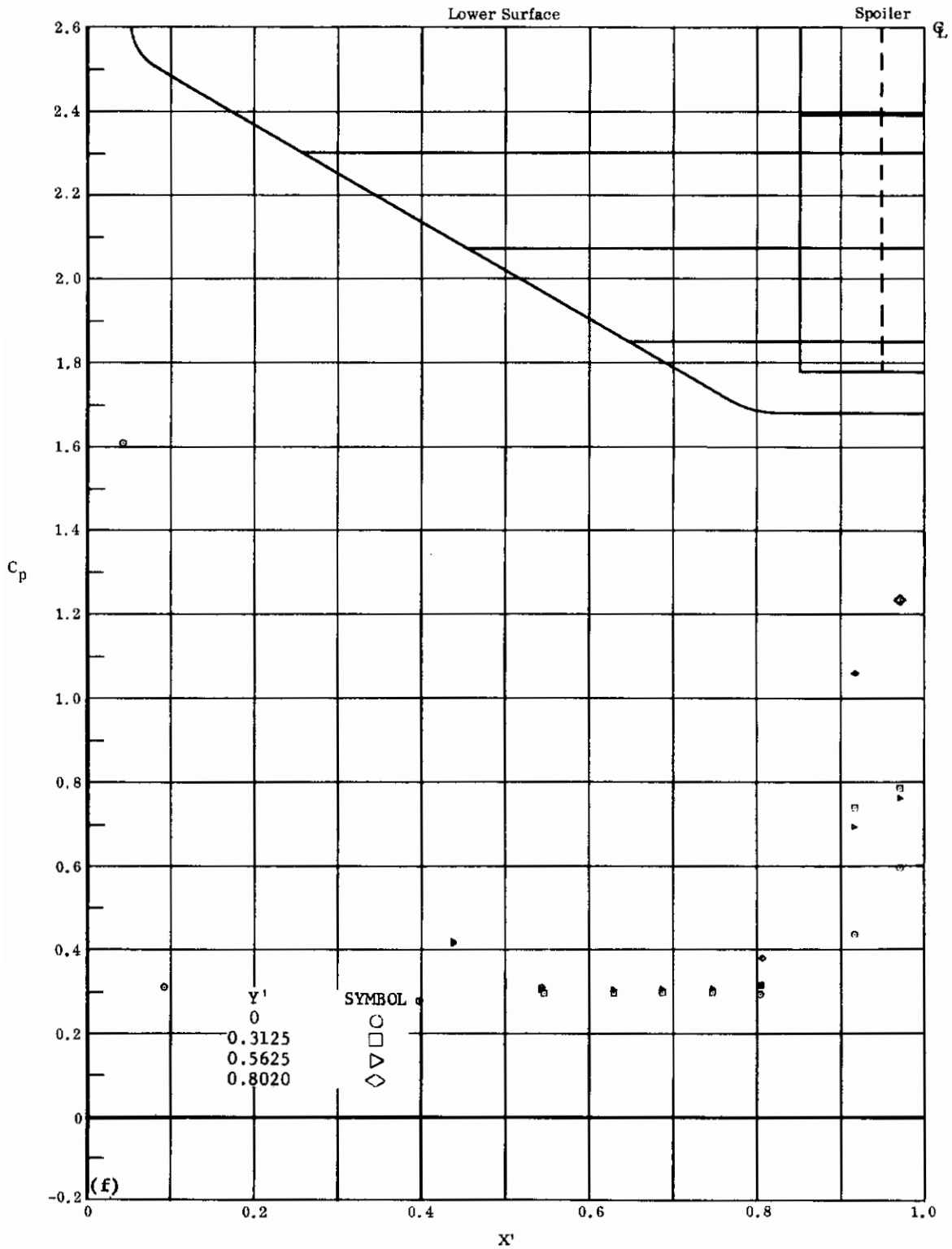

Fig. 33e Configuration IV, $\alpha = +20$, $\delta_2 = \delta_3 = +10$
 C_p vs. Y' , lower surface



(NONDIMENSIONAL STREAMWISE DISTANCE FROM VIRTUAL APEX)

Fig. 33F Configuration IV, $\alpha = +20$, $\delta_2 = \delta_3 = +10$

C_p vs. X' , lower surface

Contrails

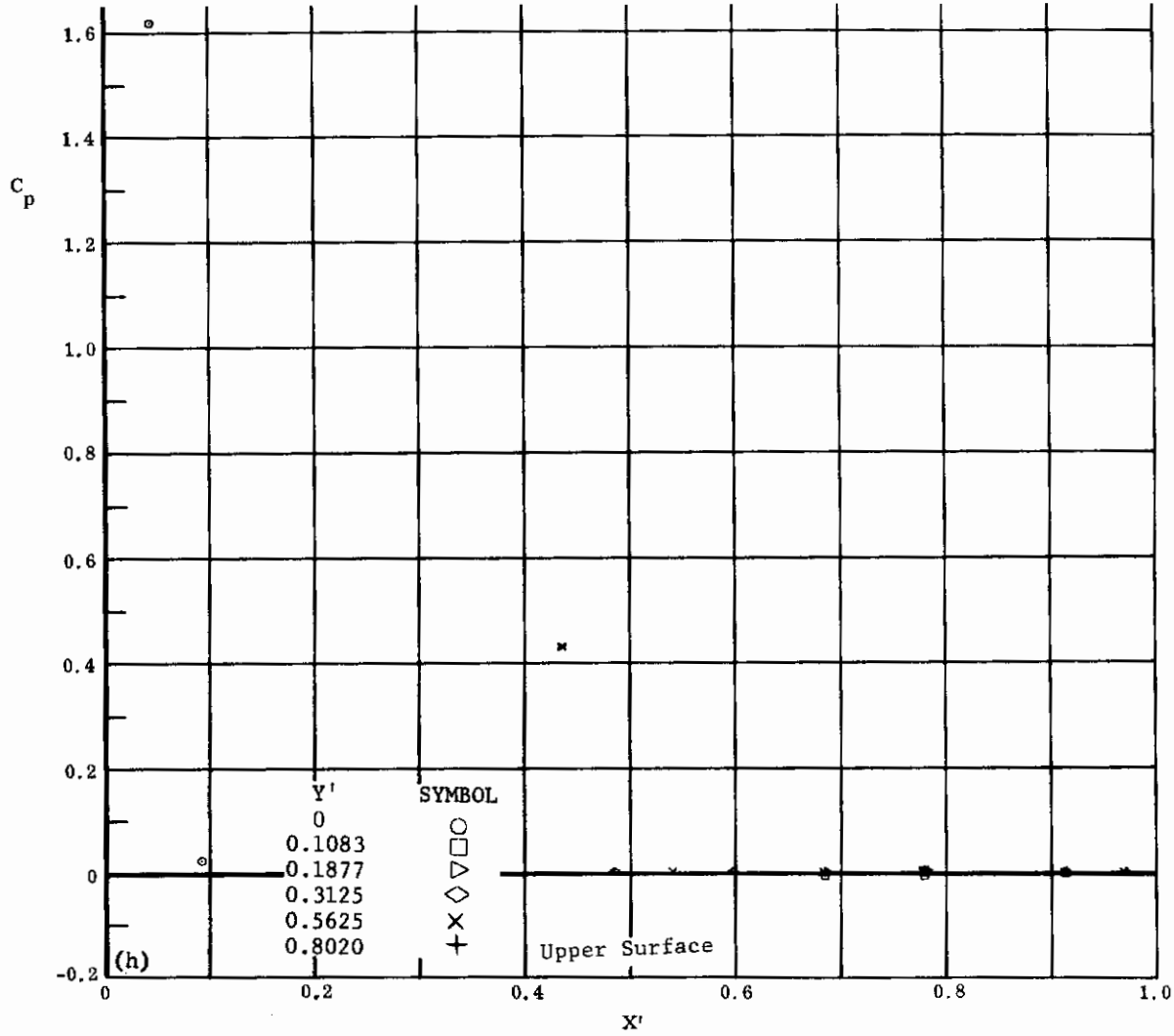
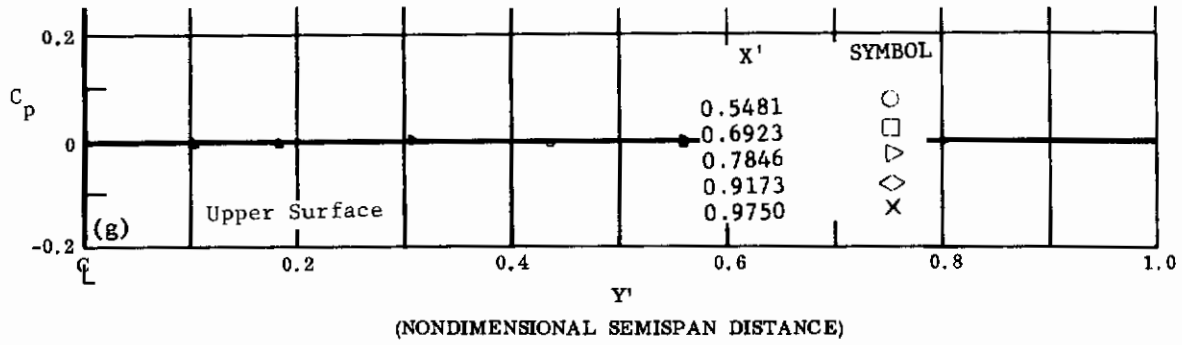

Fig. 33 Configuration IV, $\alpha = +20$, $\delta_2 = \delta_3 = +10$

g) C_p vs. Y' , upper surface

h) C_p vs. X' , upper surface

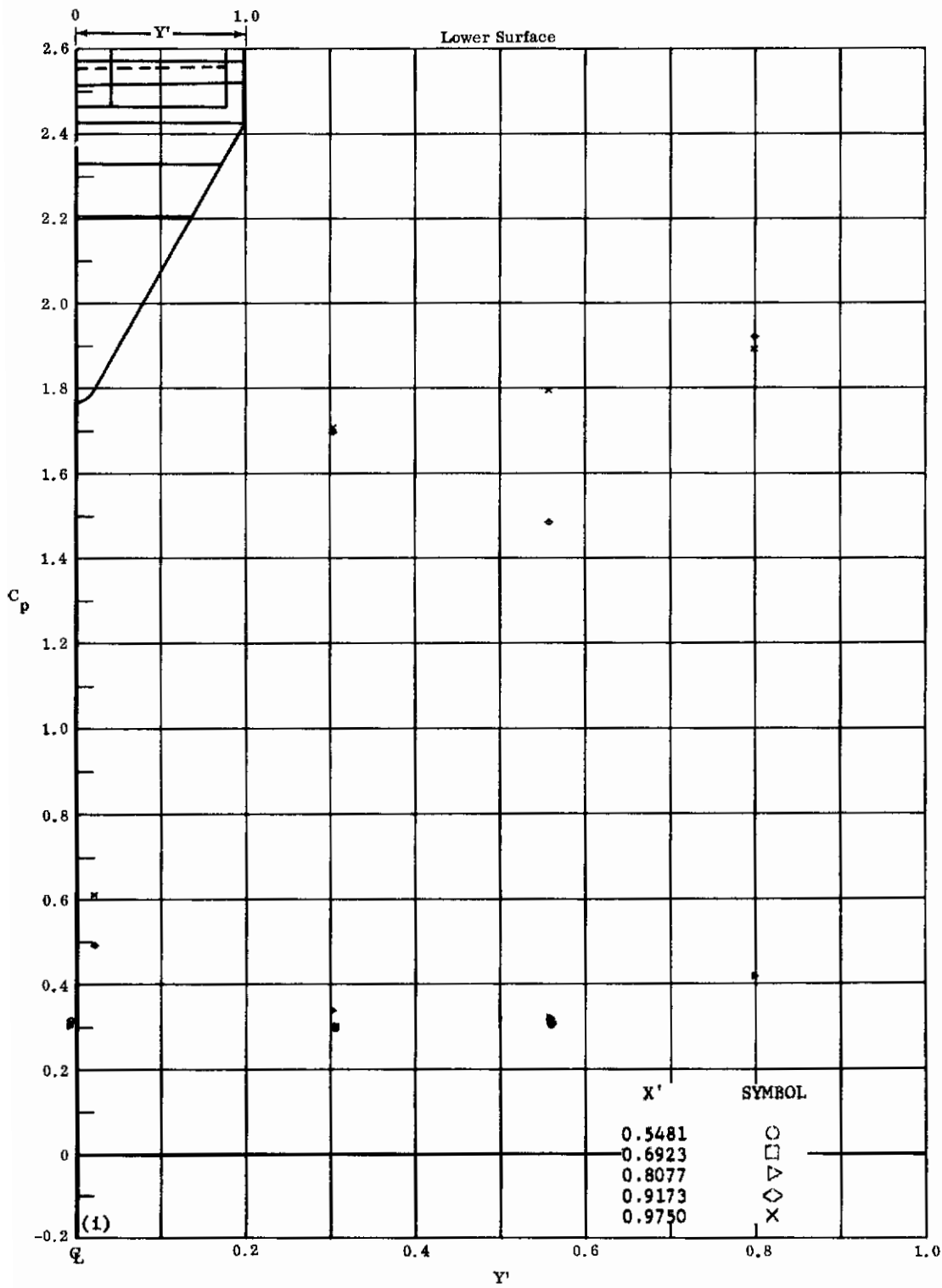
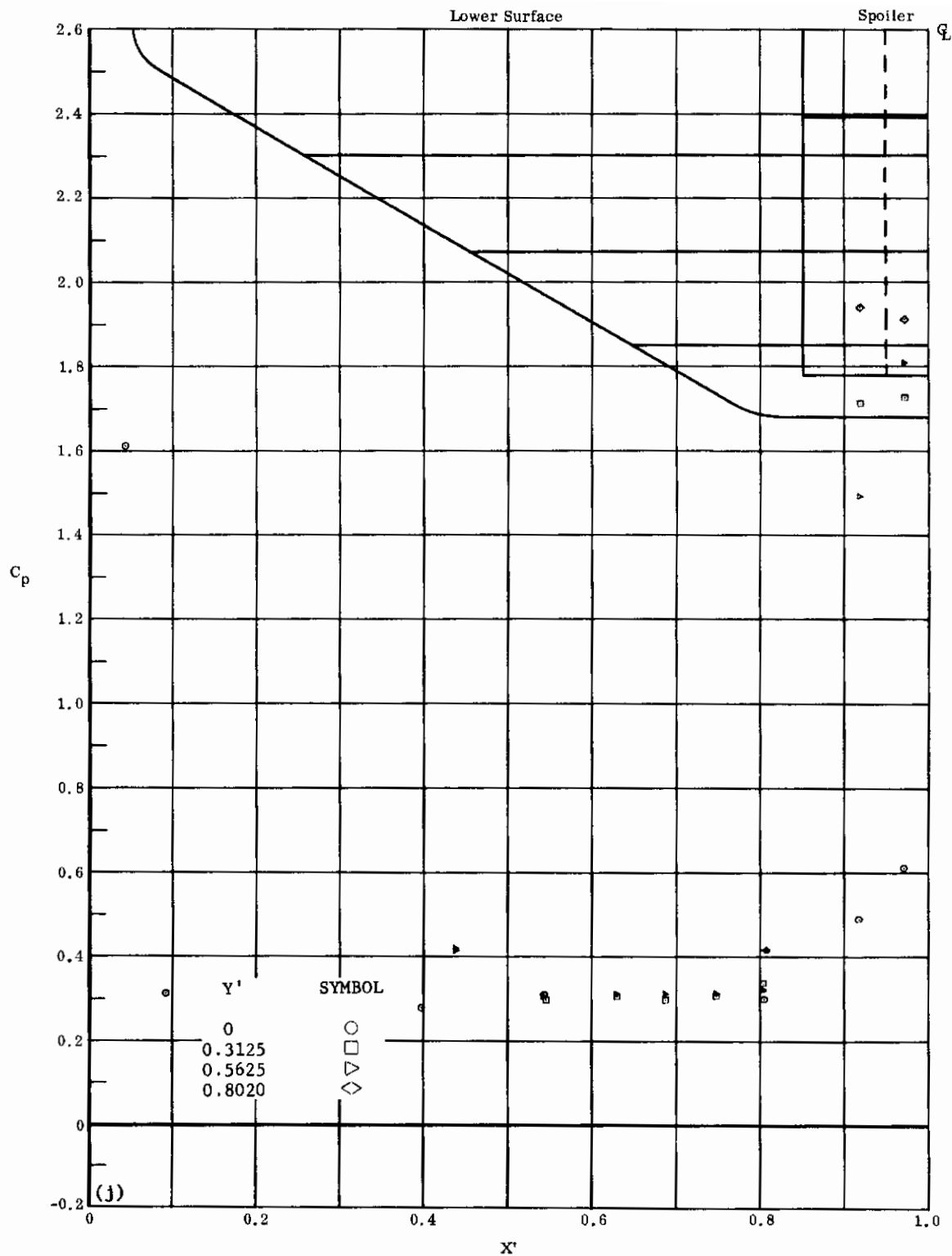

Fig. 33i Configuration IV, $\alpha = +20$, $\delta_2 = \delta_3 = +20$

C_p vs. Y' , lower surface



(NONDIMENSIONAL STREAMWISE DISTANCE FROM VIRTUAL APEX)

Fig. 33j Configuration IV, $\alpha = +20$, $\delta_2 = \delta_3 = +20$

C_p vs. X' , lower surface

Contrails

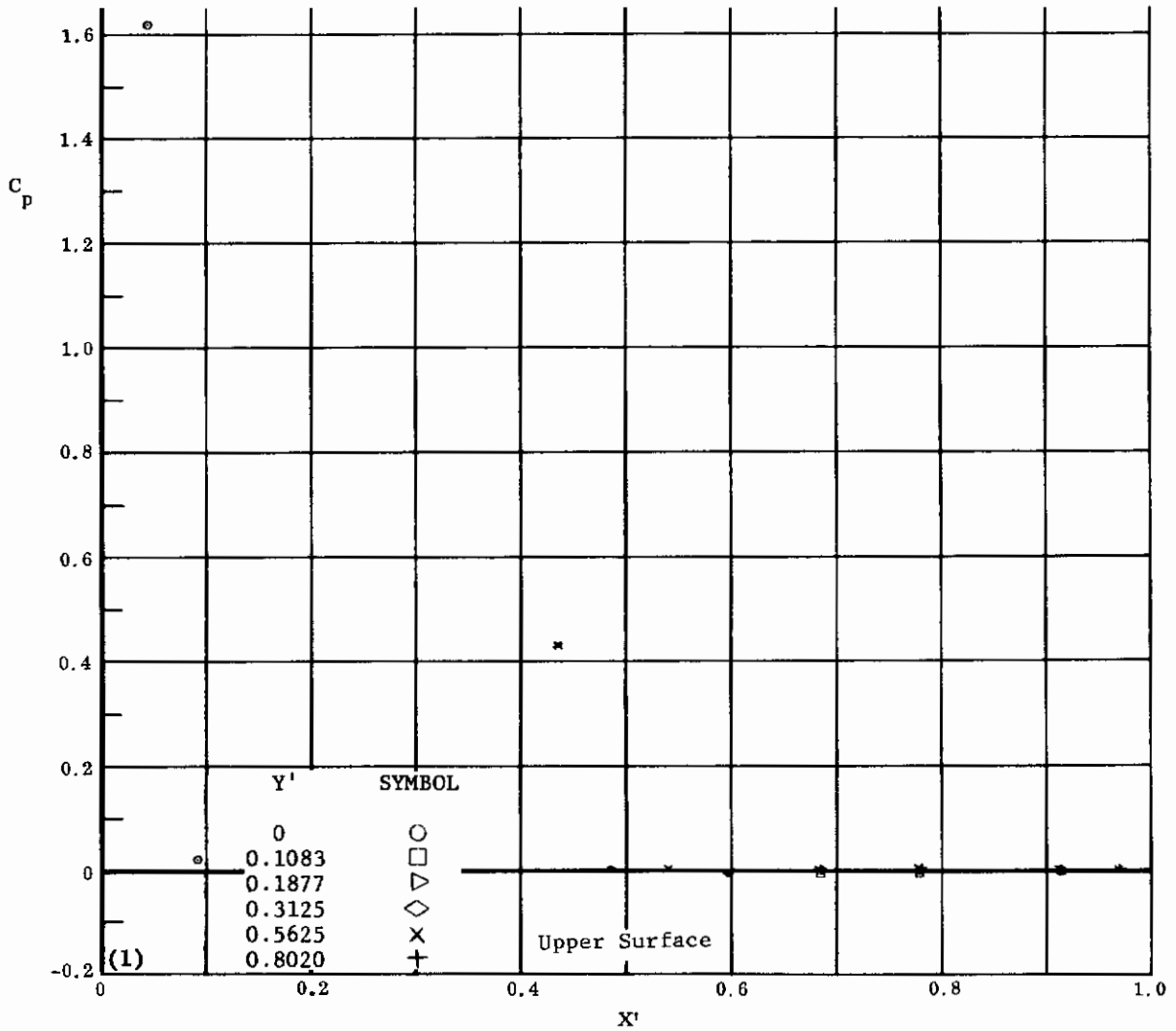
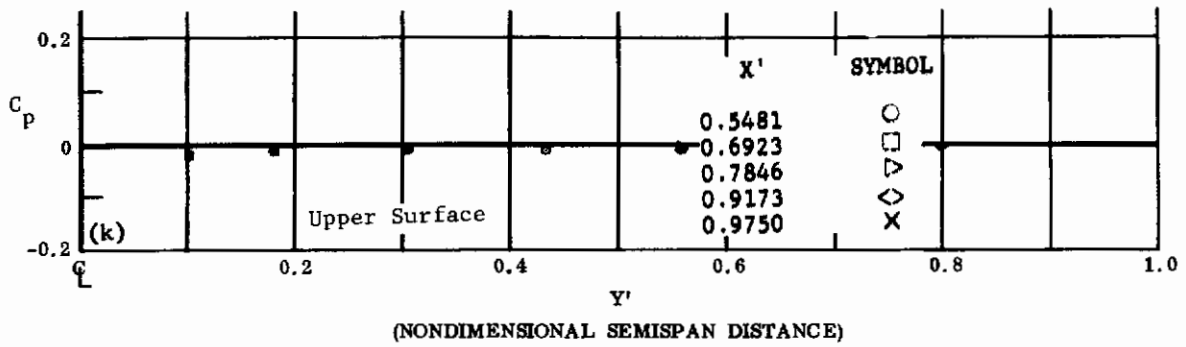

Fig. 33 Configuration IV, $\alpha = +20^\circ$, $\delta_2 = \delta_3 = +20^\circ$

k) C_p vs. Y' , upper surface

l) C_p vs. X' , upper surface

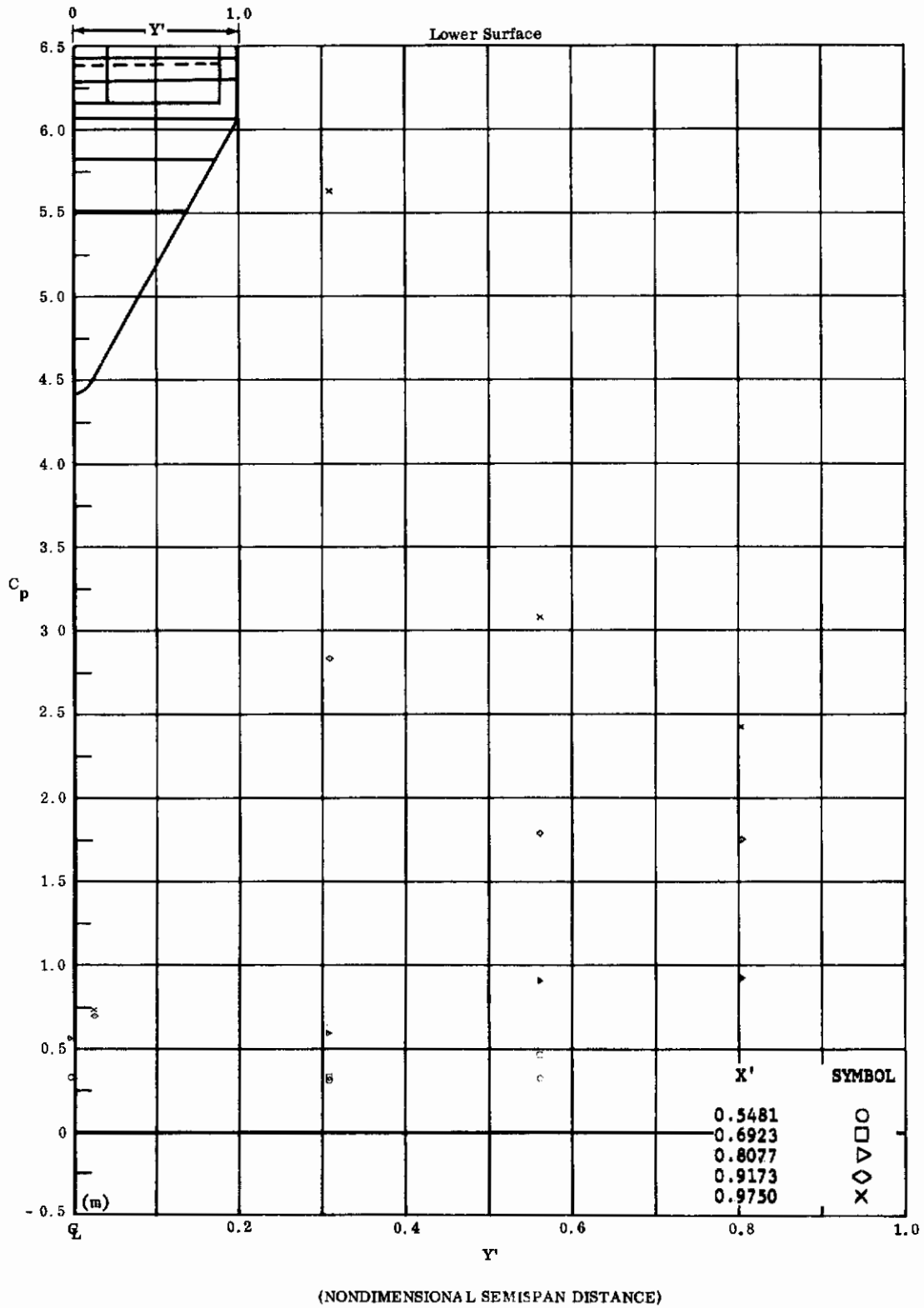
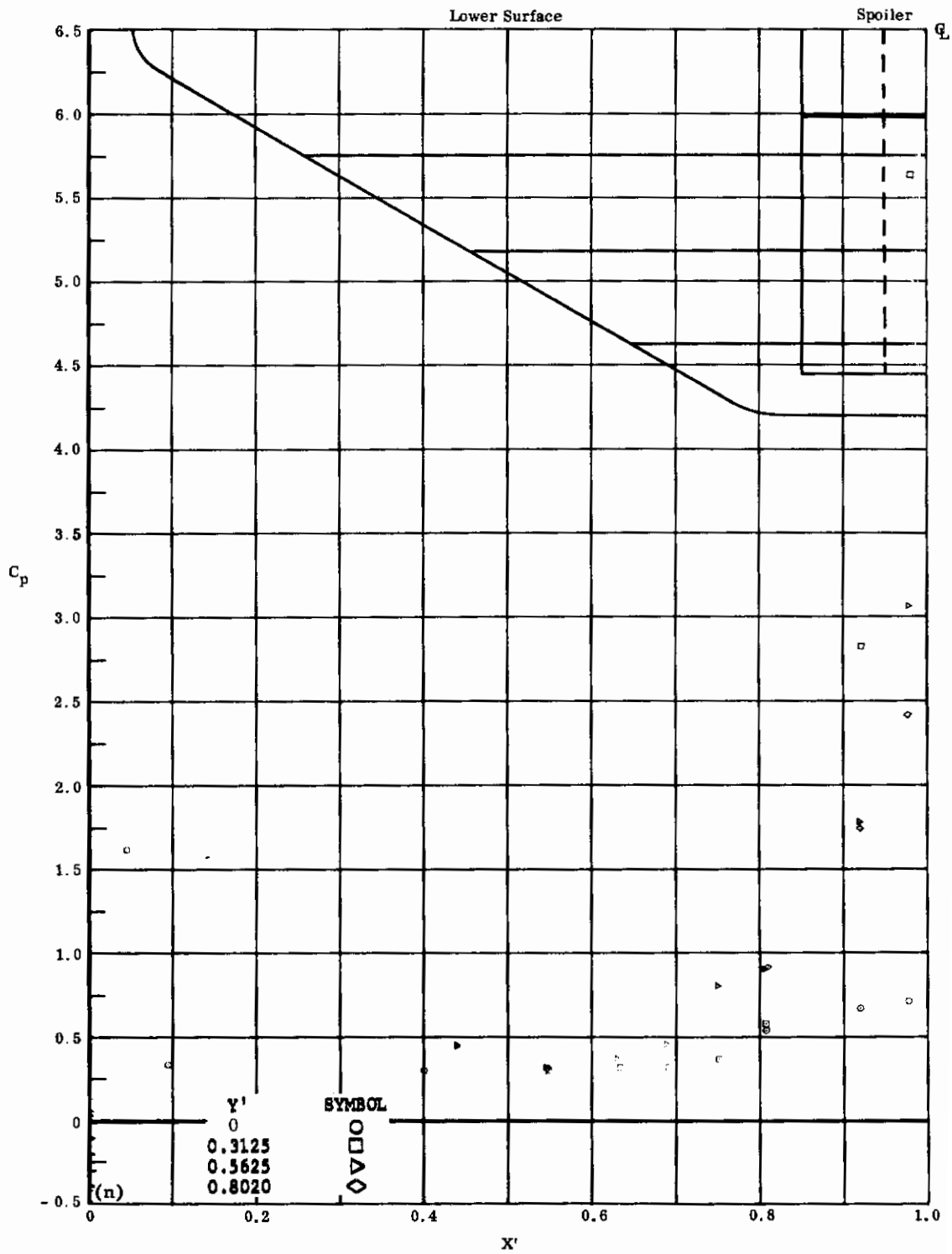

Fig. 33m Configuration IV, $\alpha = +20$, $\delta_2 = \delta_3 = +30$

C_p vs. Y' , lower surface



(NONDIMENSIONAL STREAMWISE DISTANCE FROM VIRTUAL APEX)

Fig. 33n Configuration IV, $\alpha = +20$, $\delta_2 = \delta_3 = +30$

C_p vs. X' , lower surface

Contrails

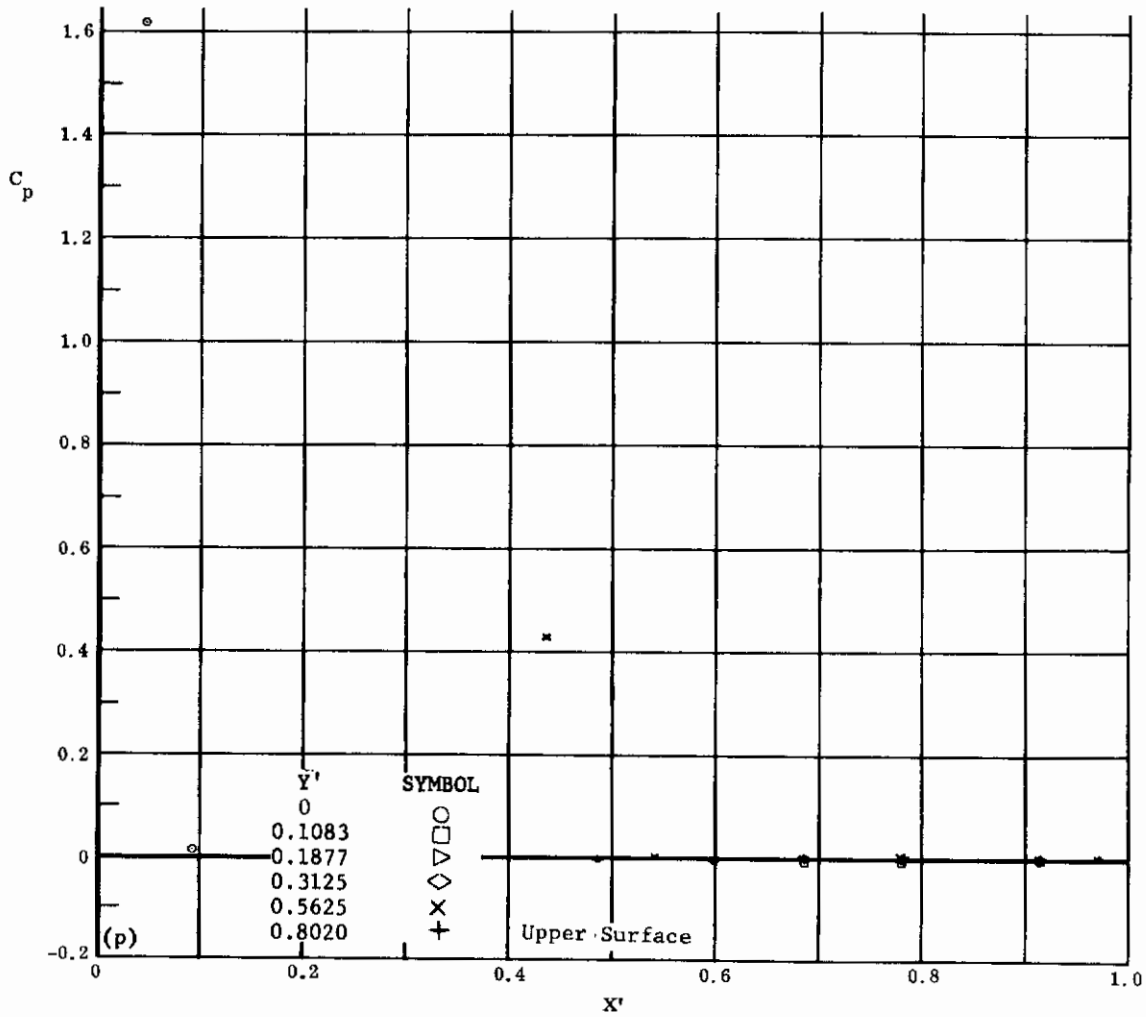
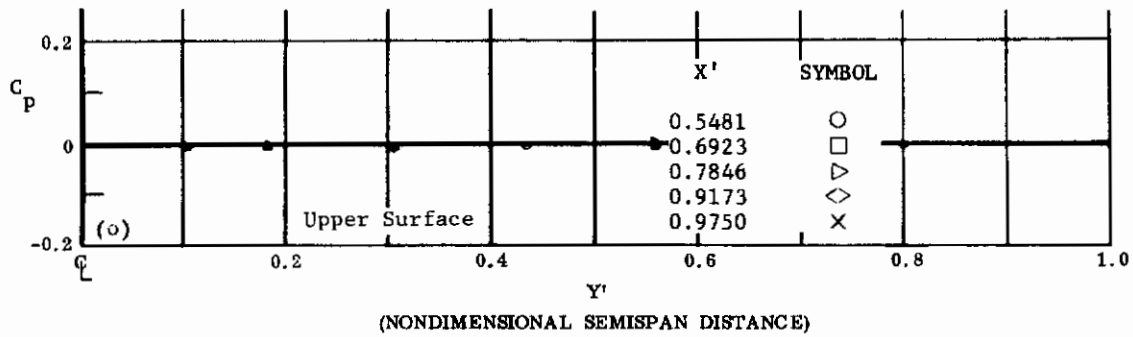

(NONDIMENSIONAL STREAMWISE DISTANCE FROM VIRTUAL APEX)

Fig. 33 Configuration IV, $\alpha = +20$, $\delta_2 = \delta_3 = +30$

- o) C_p vs. Y' , upper surface
- p) C_p vs. X' , upper surface

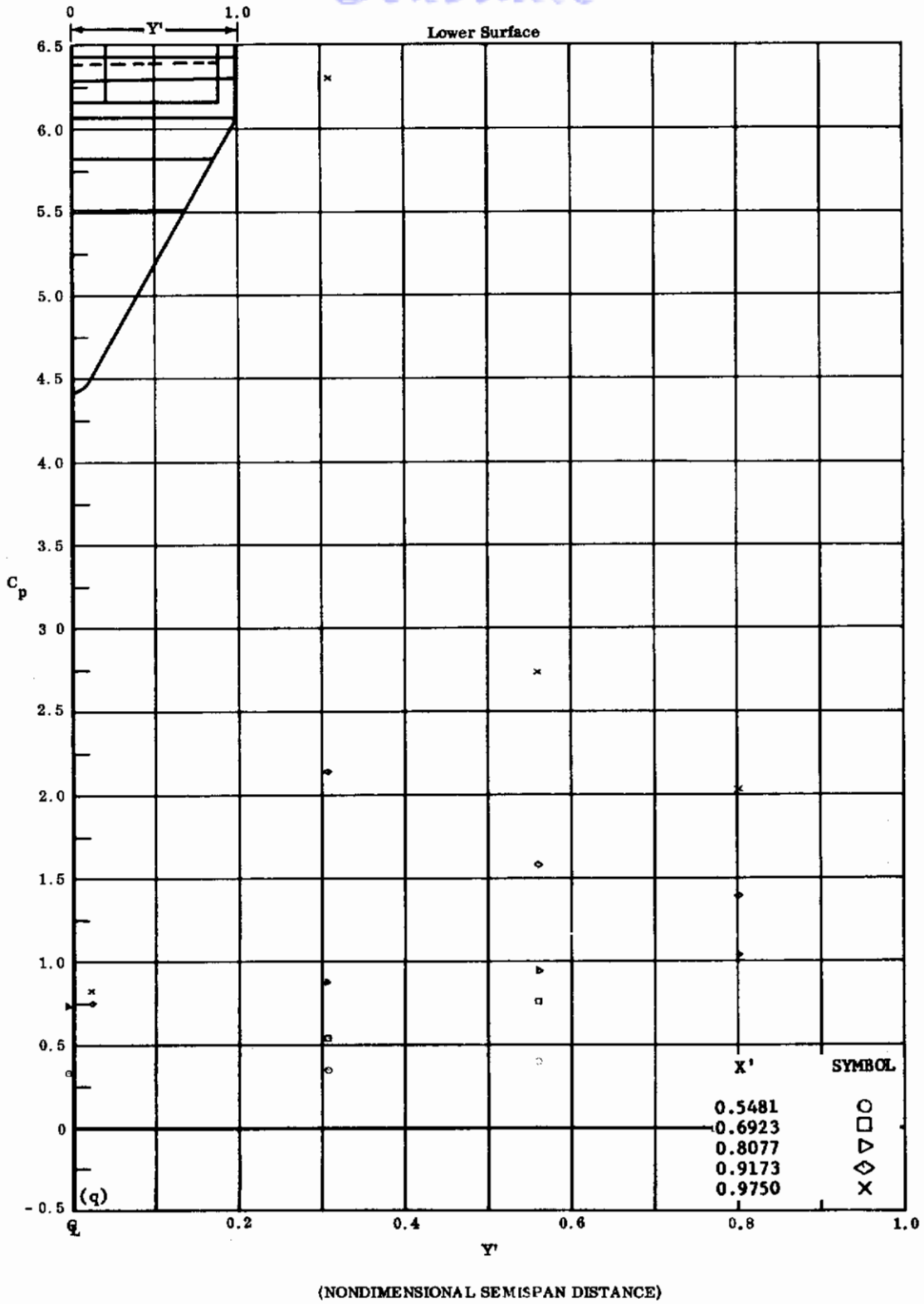

Fig. 33q Configuration IV, $\alpha = +20$, $\delta_2 = \delta_3 = +39$

C_p vs. Y' , lower surface

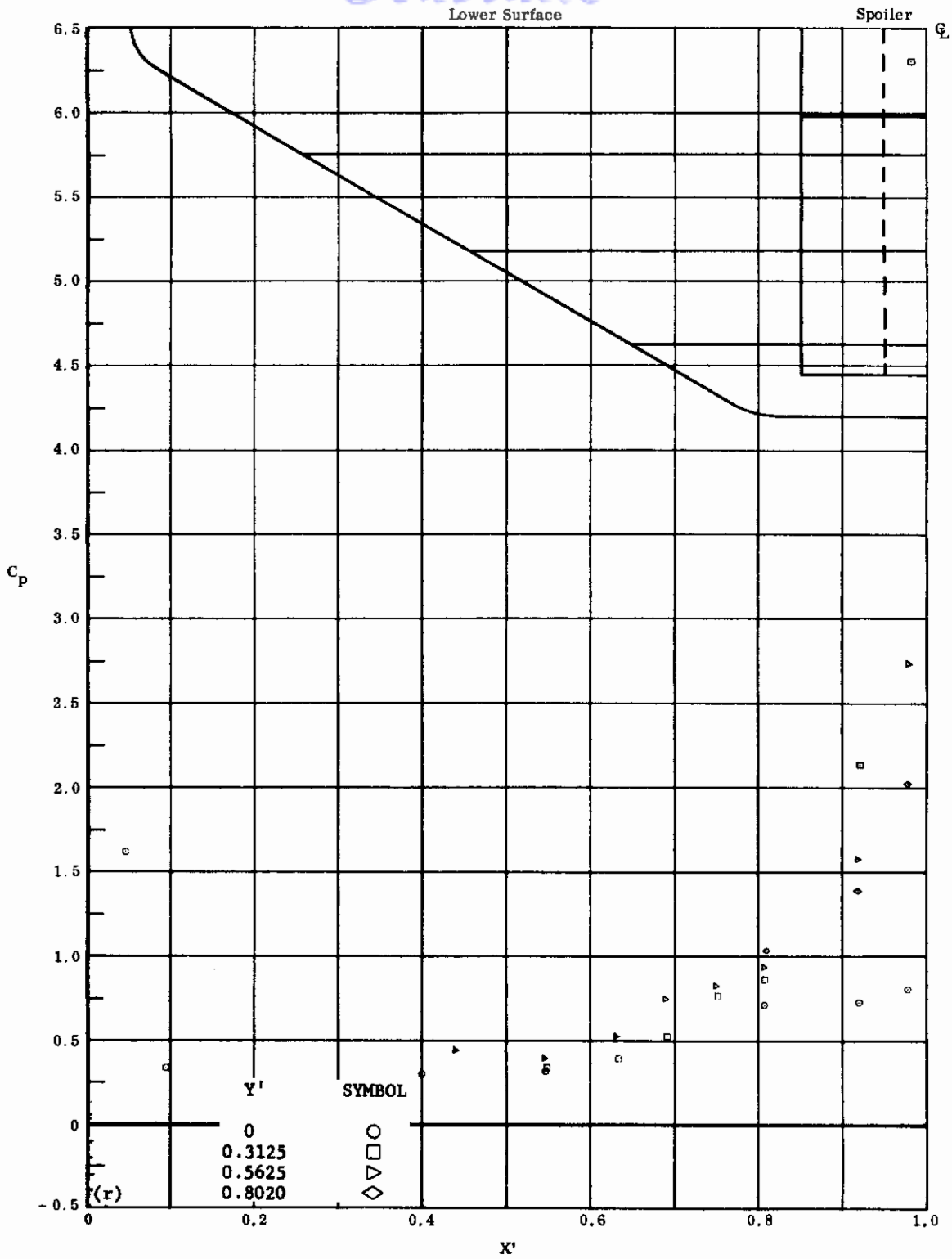
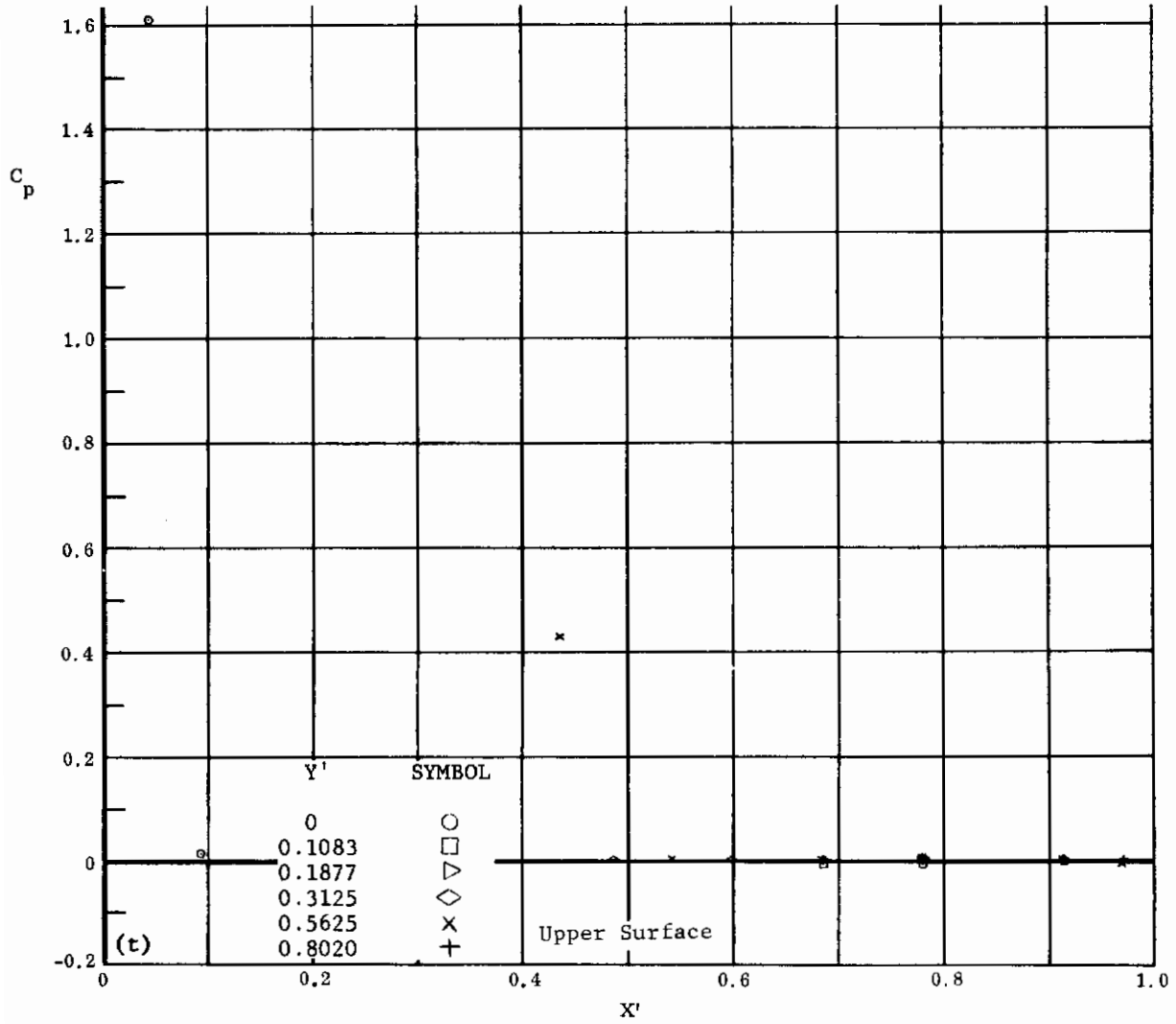
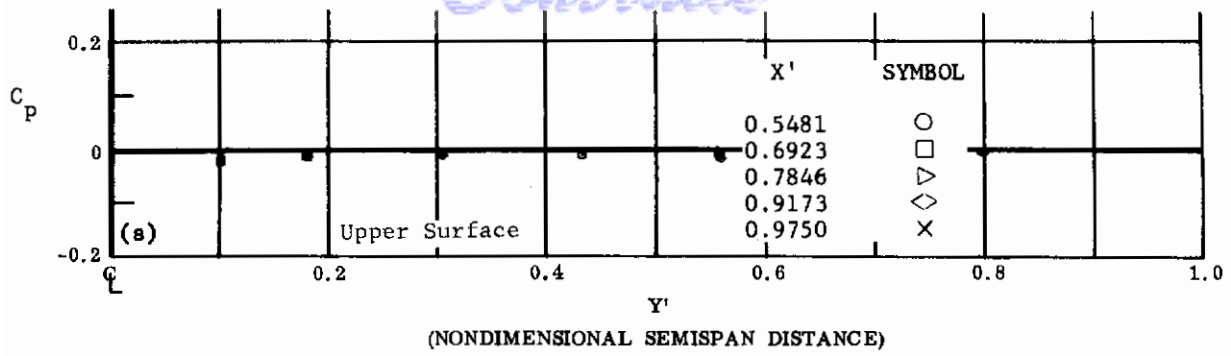

Fig. 33r Configuration IV, $\alpha = +20$, $\delta_2 = \delta_3 = +39$

C_p vs. X' , lower surface

Contrails



(NONDIMENSIONAL STREAMWISE DISTANCE FROM VIRTUAL APEX)

Fig. 33 Configuration IV, $\alpha = +20$, $\delta_2 = \delta_3 = +39$

s) C_p vs. Y' , upper surface

t) C_p vs. X' , upper surface

Contrails

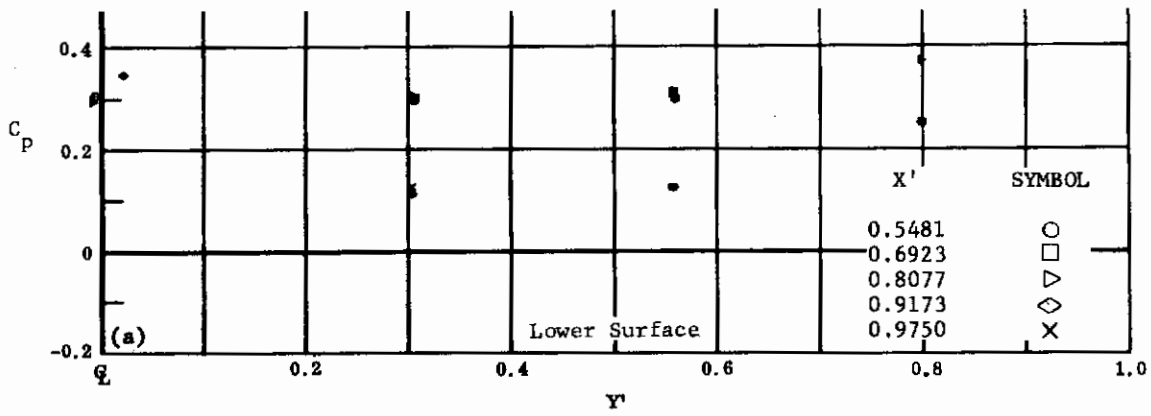

(NONDIMENSIONAL SEMISPAN DISTANCE)

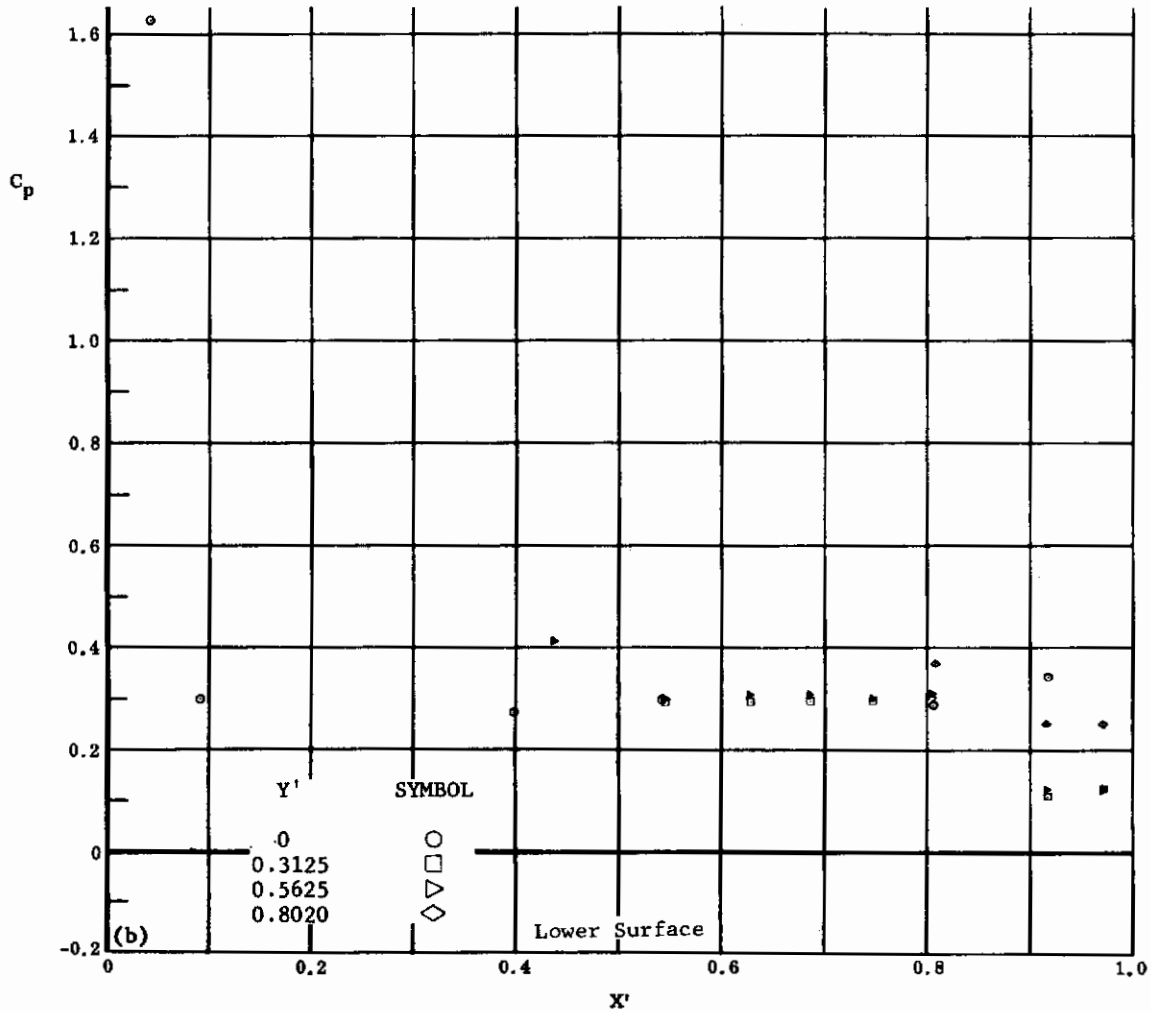

(NONDIMENSIONAL STREAMWISE DISTANCE FROM VIRTUAL APEX)

Fig. 34 Configuration IV, $\alpha = +20$, $\delta_2 = \delta_3 = -10$

- a) C_p vs. Y' , lower surface
- b) C_p vs. X' , lower surface

Contrails

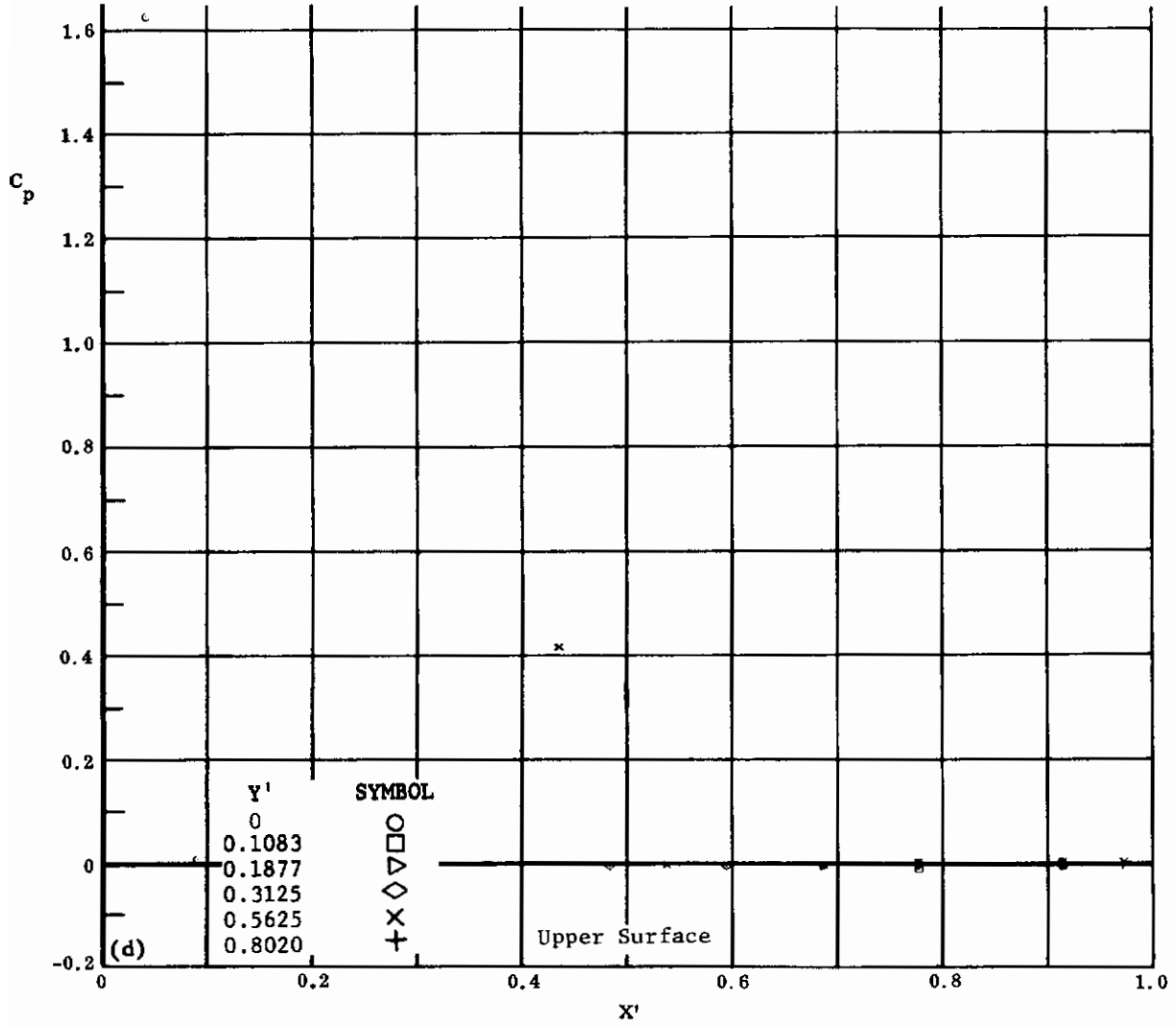
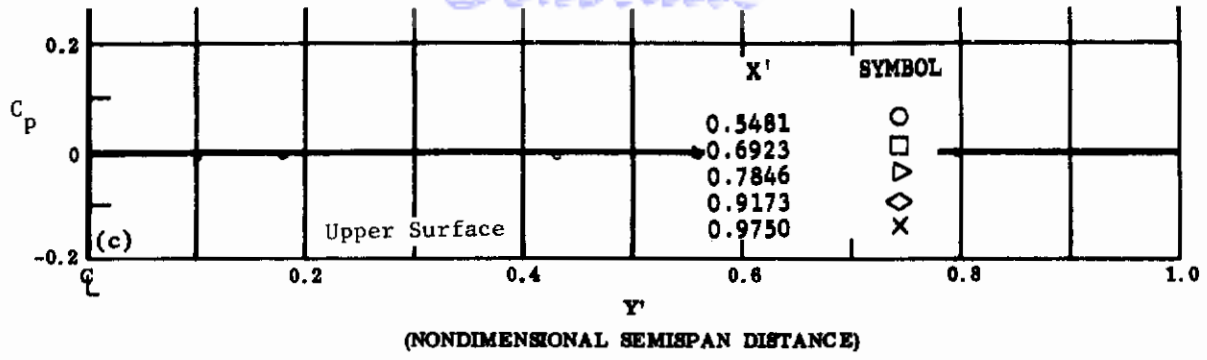
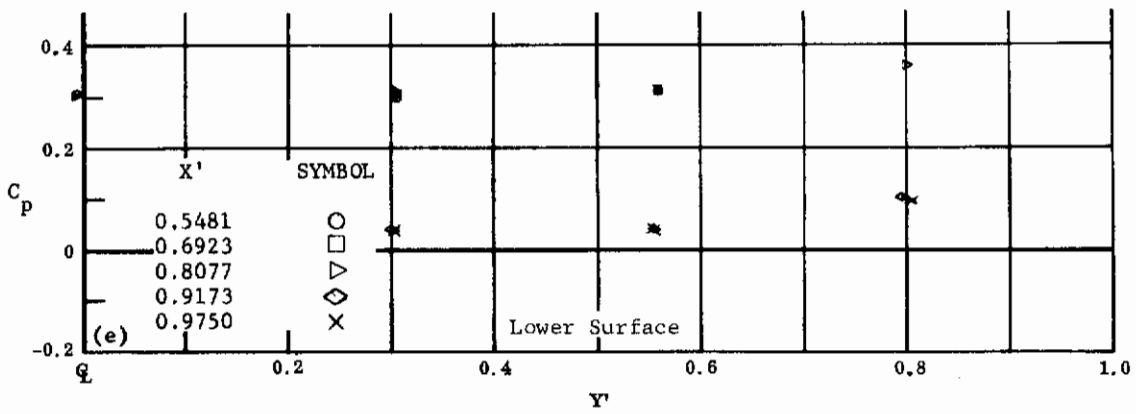

Fig. 34 Configuration IV, $\alpha = +20$, $\delta_2 = \delta_3 = -10$

c) C_p vs. Y' , upper surface

d) C_p vs. X' , upper surface

Contrails



(NONDIMENSIONAL SEMISPAN DISTANCE)

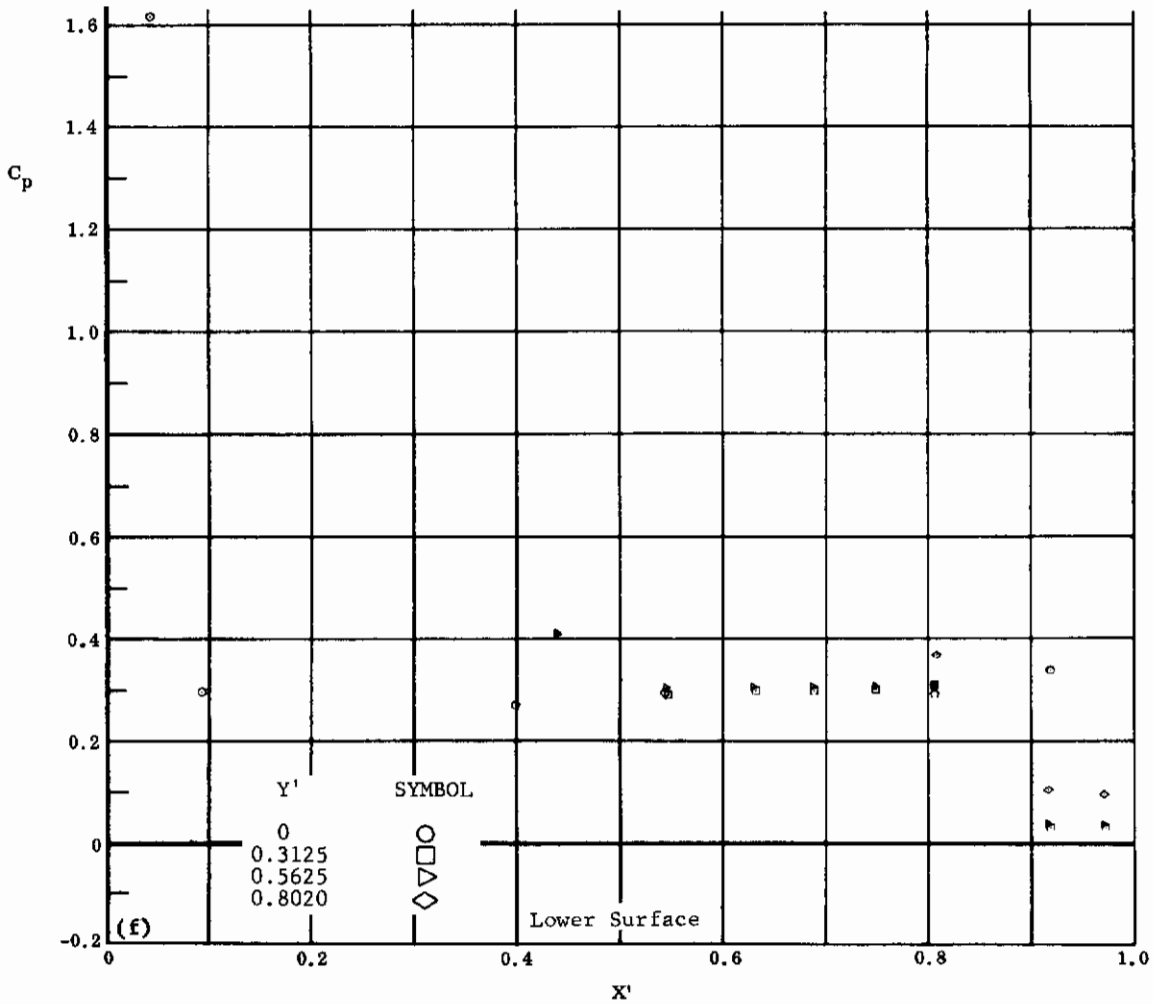

(NONDIMENSIONAL STREAMWISE DISTANCE FROM VIRTUAL APEX)

Fig. 34 Configuration IV, $\alpha = +20$, $\delta_2 = \delta_3 = -20$

e) C_p vs. Y' , lower surface

f) C_p vs. X' , lower surface

Contrails

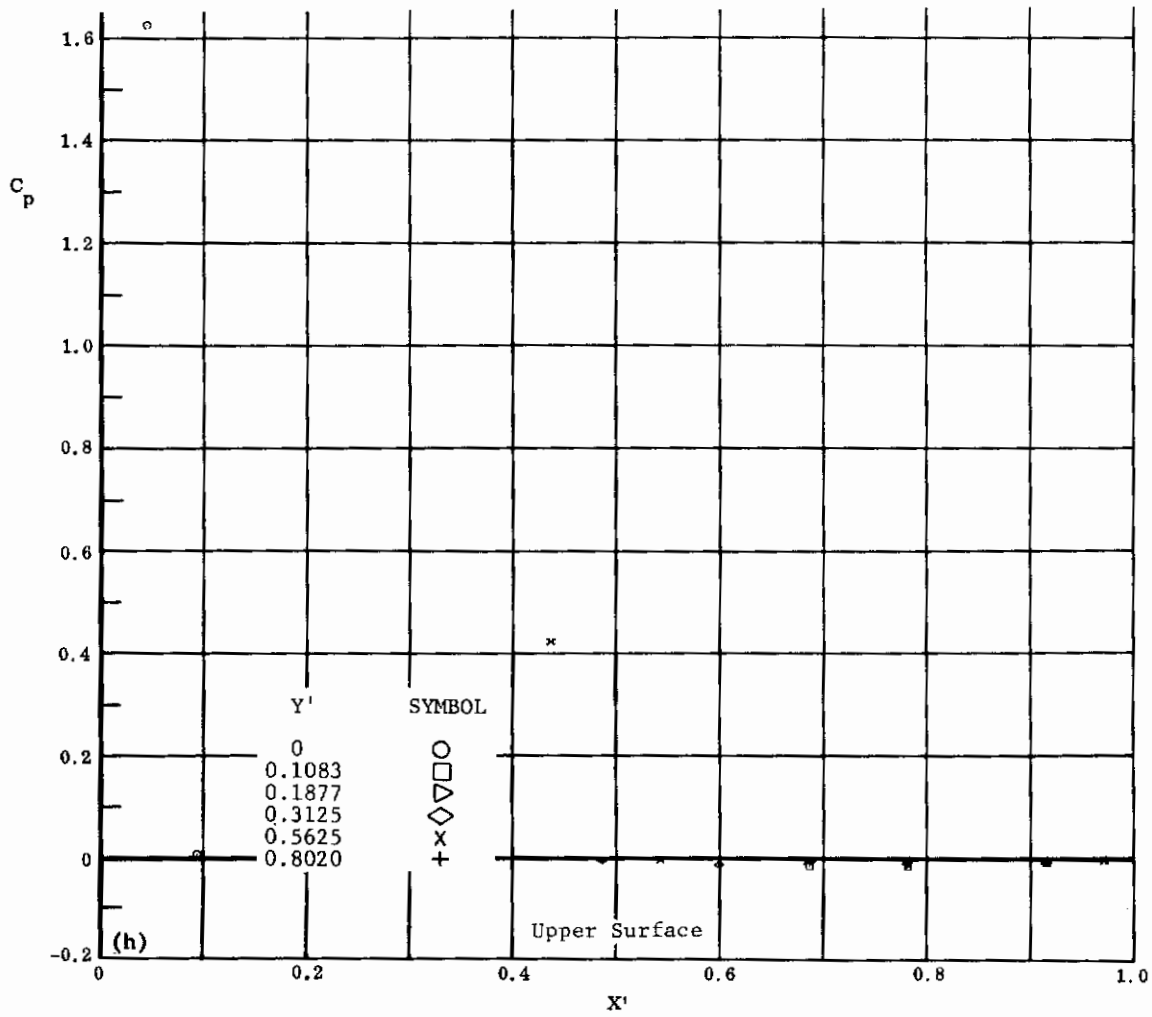
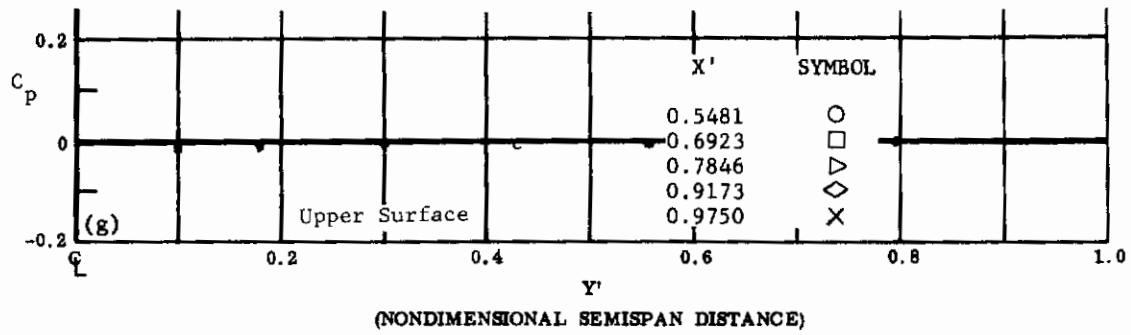

(NONDIMENSIONAL STREAMWISE DISTANCE FROM VIRTUAL APEX)

Fig. 34 Configuration IV, $\alpha = +20$, $\delta_2 = \delta_3 = -20$

g) C_p vs. Y' , upper surface

h) C_p vs. X' , upper surface

Contrails

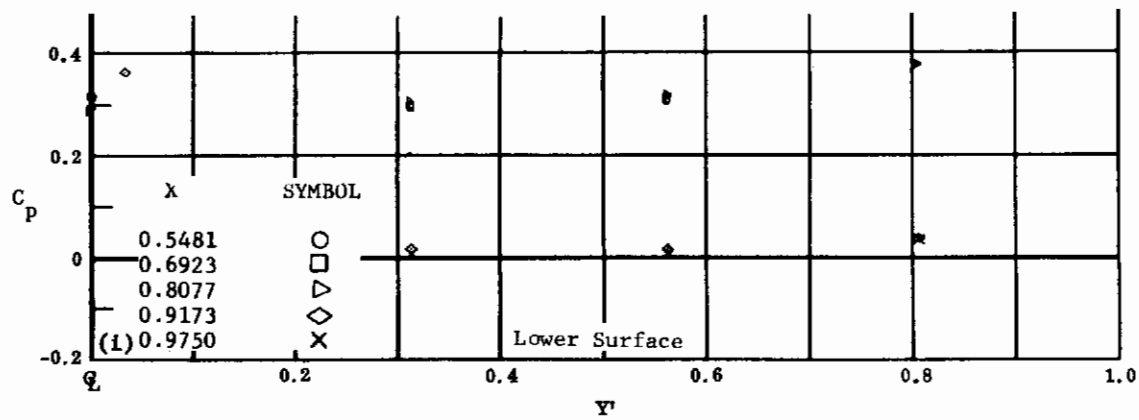

(NONDIMENSIONAL SEMISPAN DISTANCE)

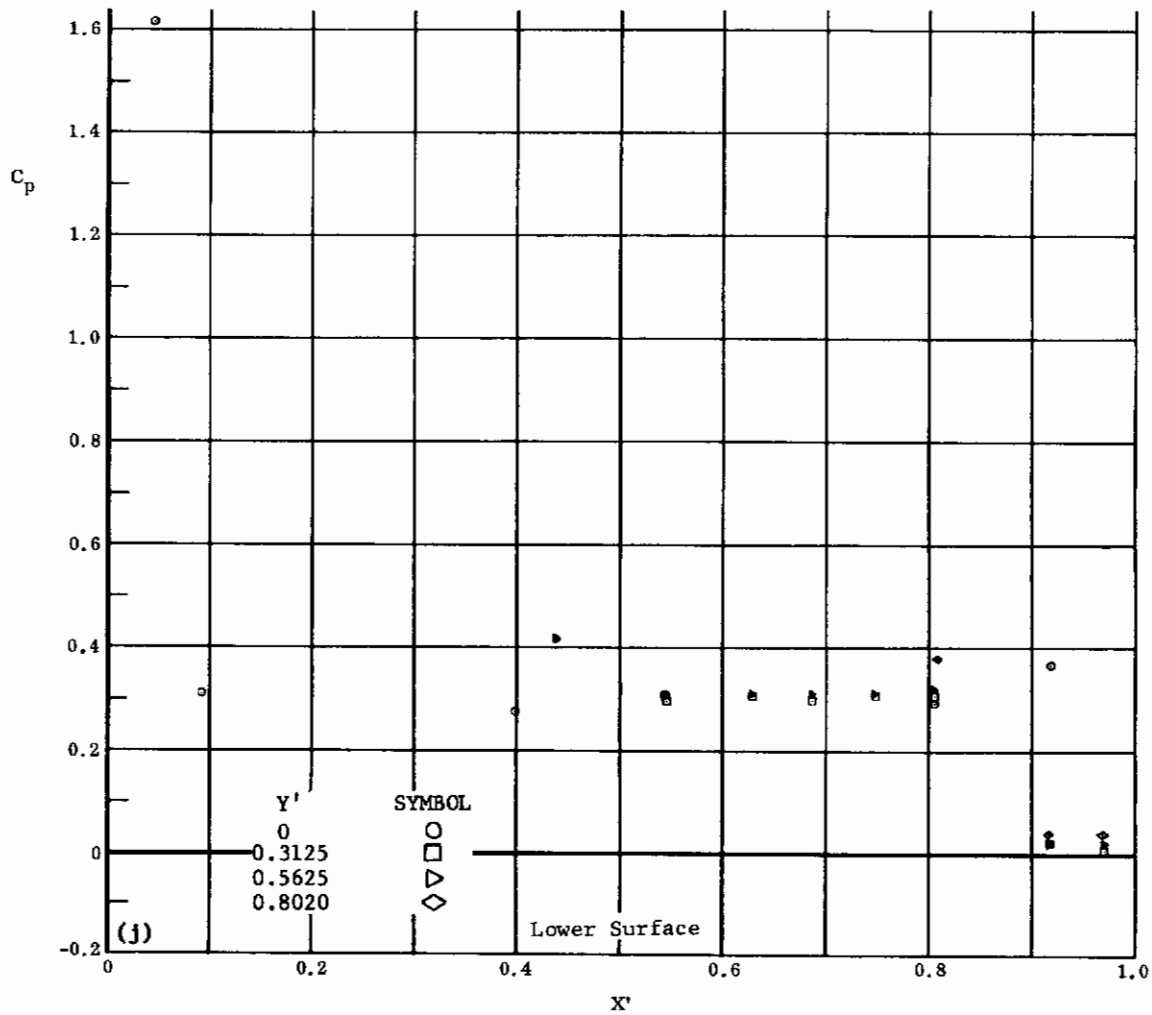

(NONDIMENSIONAL STREAMWISE DISTANCE FROM VIRTUAL APEX)

Fig. 34 Configuration IV, $\alpha = +20$, $\delta_2 = \delta_3 = -30$

i) C_p vs. Y' , lower surface

j) C_p vs. X' , lower surface

Contrails

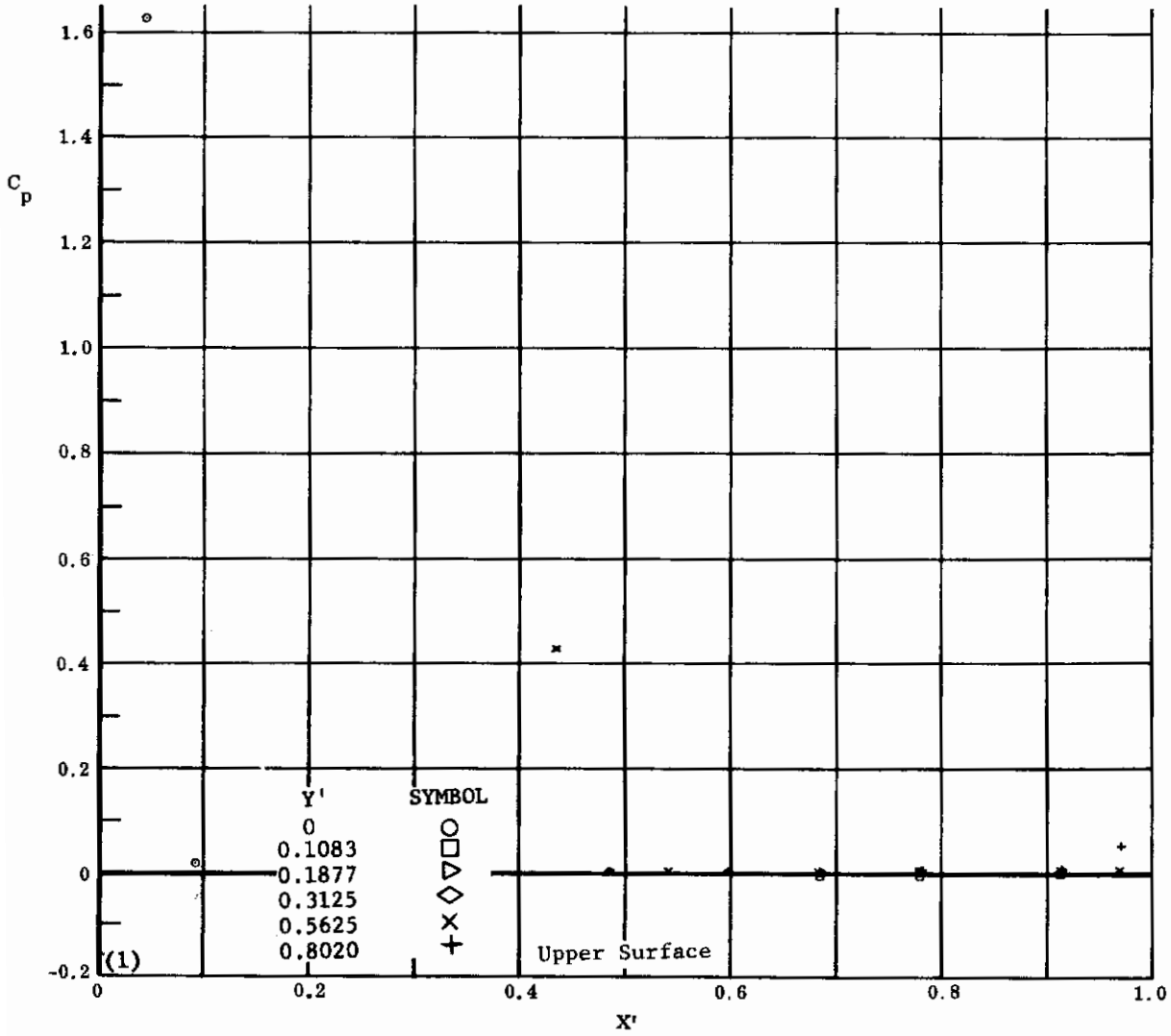
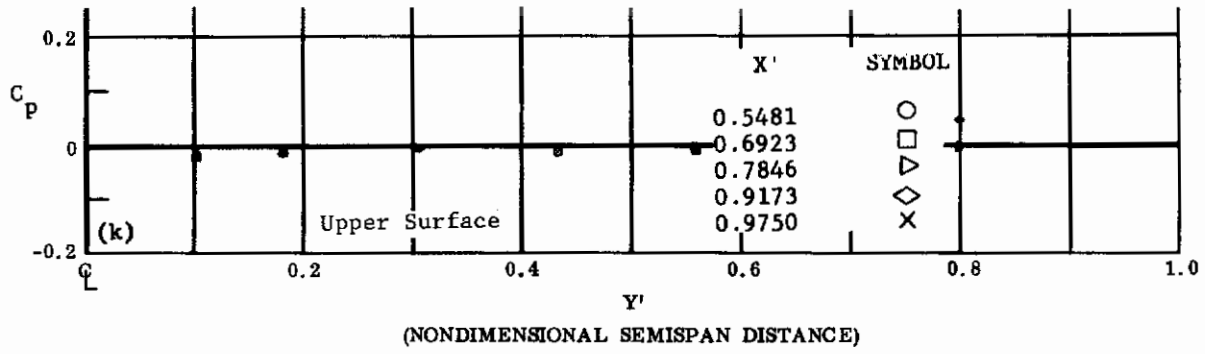
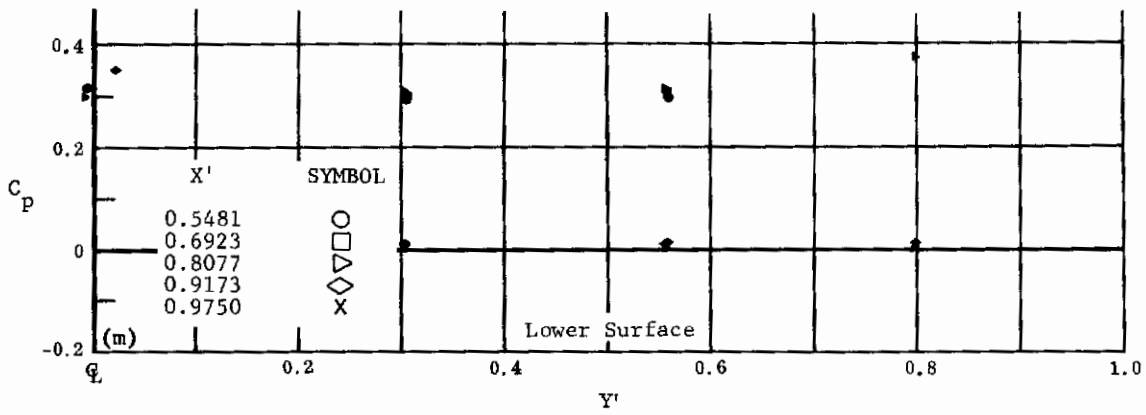

Fig. 34 Configuration IV, $\alpha = +20$, $\delta_2 = \delta_3 = -30$

k) C_p vs. Y' , upper surface

l) C_p vs. X' , upper surface

Contrails



(NONDIMENSIONAL SEMISPAN DISTANCE)

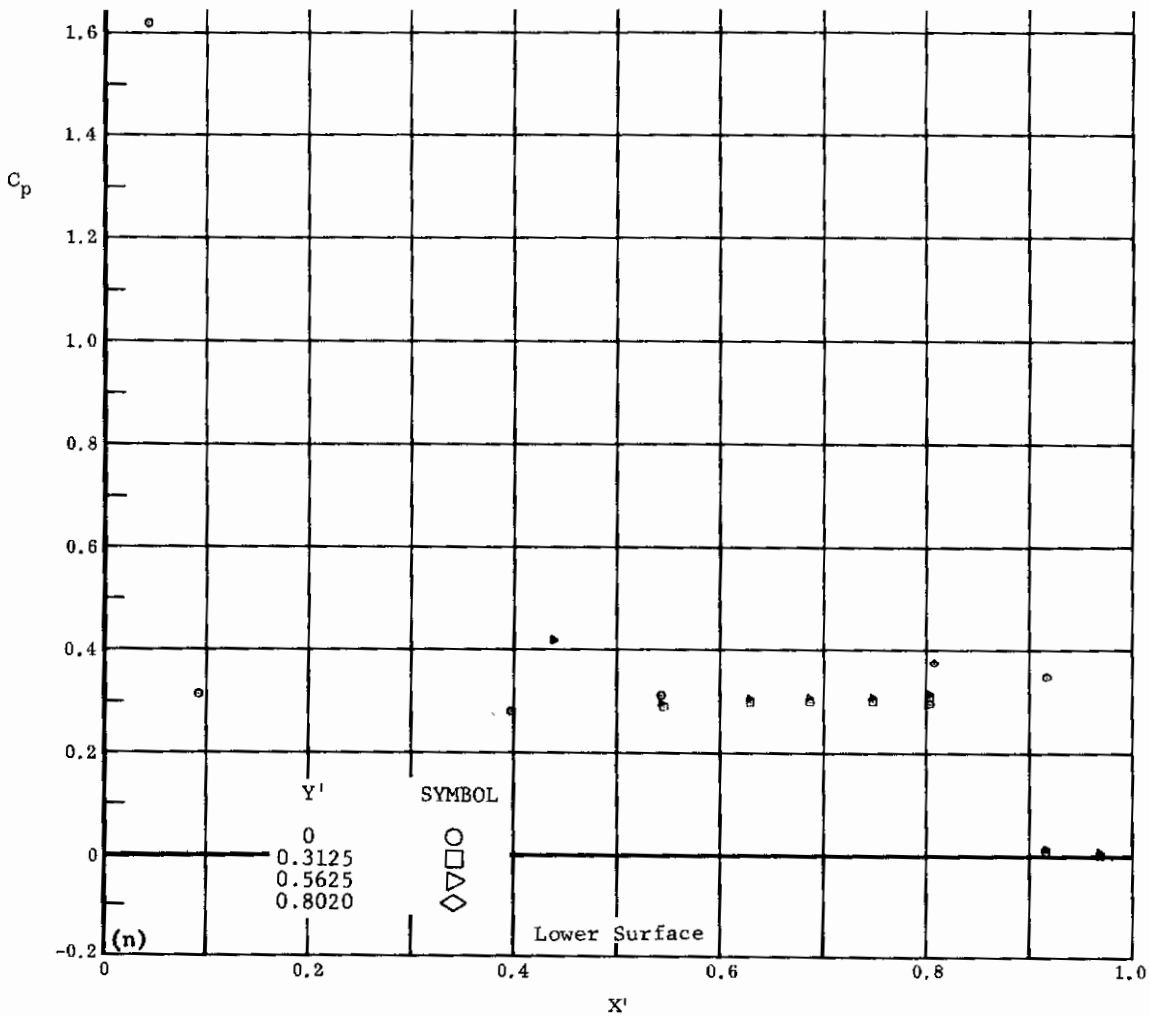

(NONDIMENSIONAL STREAMWISE DISTANCE FROM VIRTUAL APEX)

Fig. 34 Configuration IV, $\alpha = +20$, $\delta_2 = \delta_3 = -39$

- m) C_p vs. Y' , lower surface
- n) C_p vs. X' , lower surface

Contrails

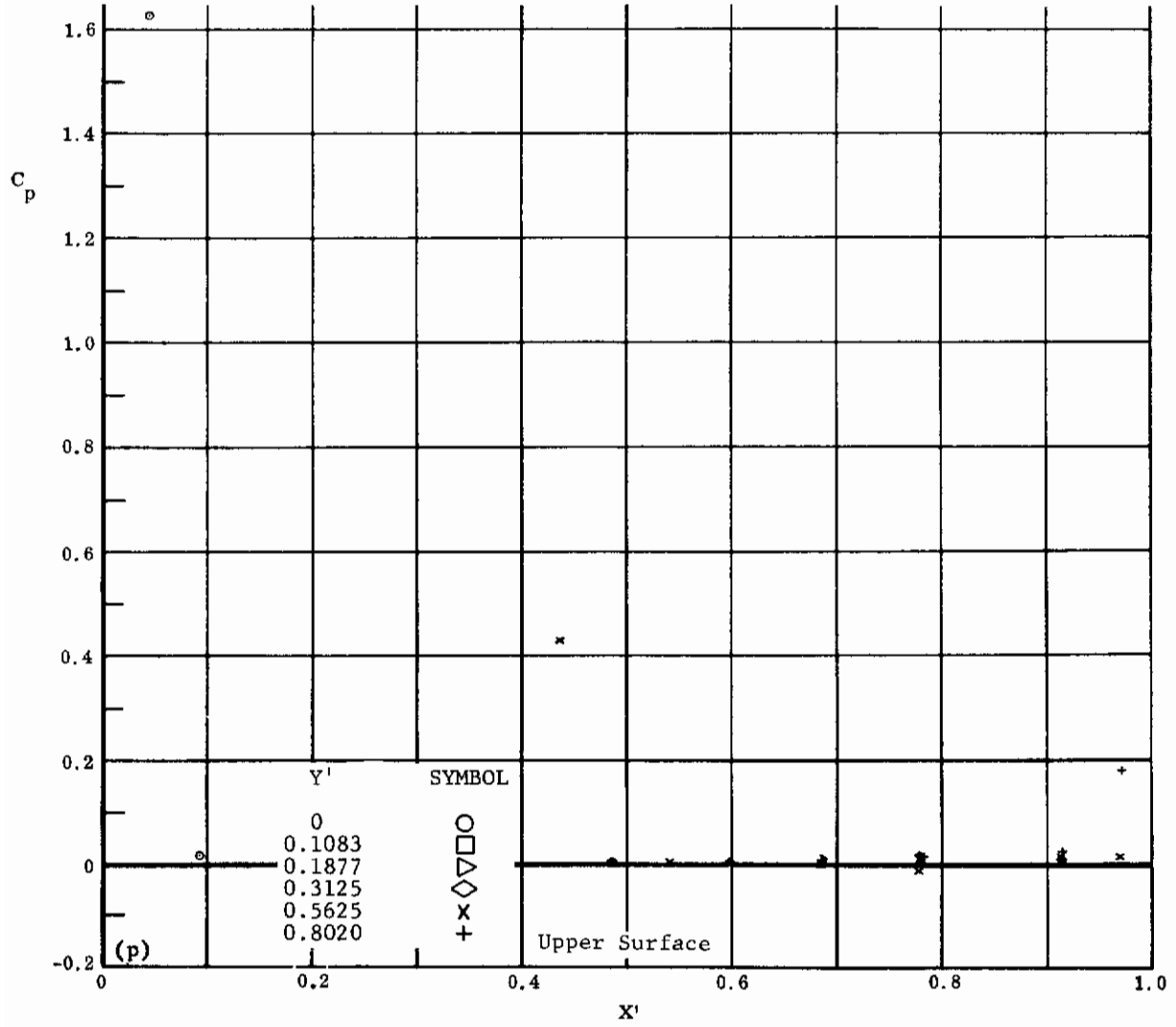
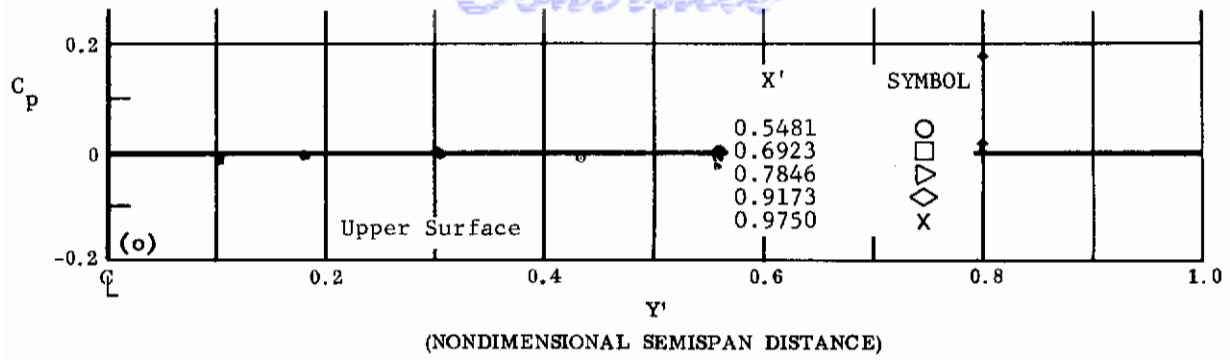

(NONDIMENSIONAL STREAMWISE DISTANCE FROM VIRTUAL APEX)

Fig. 34 Configuration IV, $\alpha = +20$, $\delta_2 = \delta_3 = -39$

o) C_p vs. Y' , upper surface

p) C_p vs. X' , upper surface

Contrails

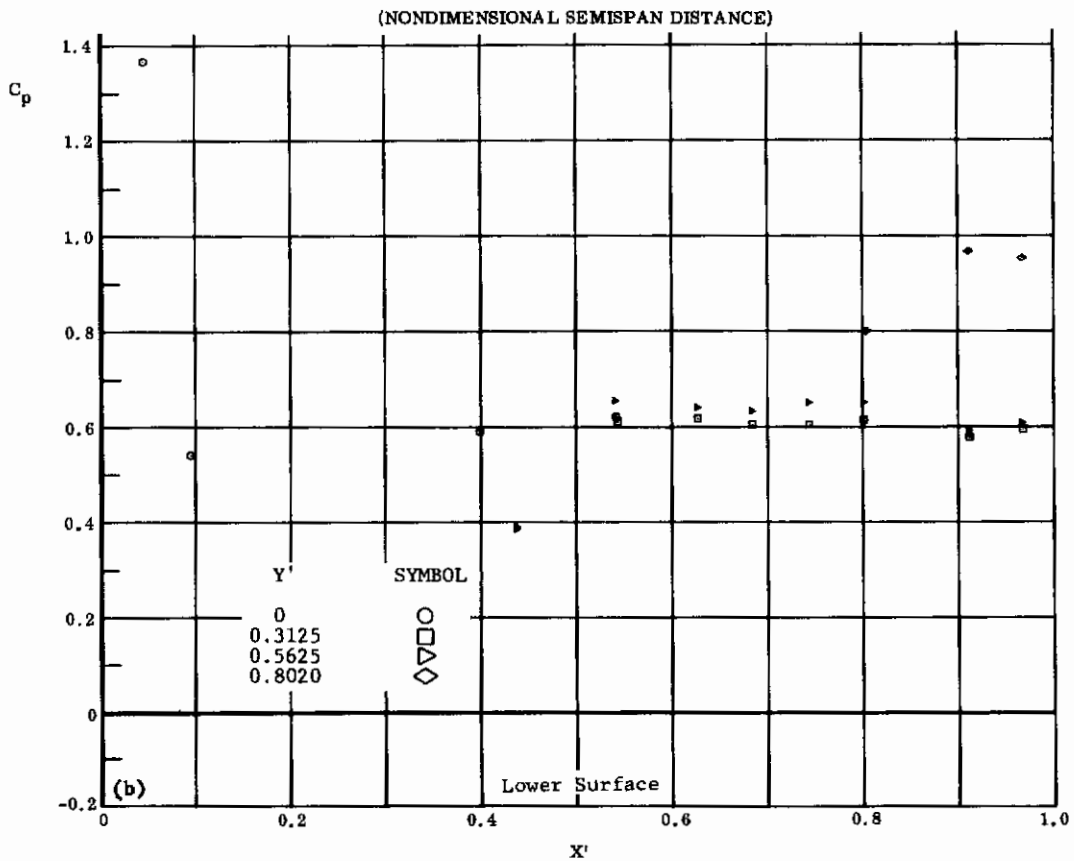
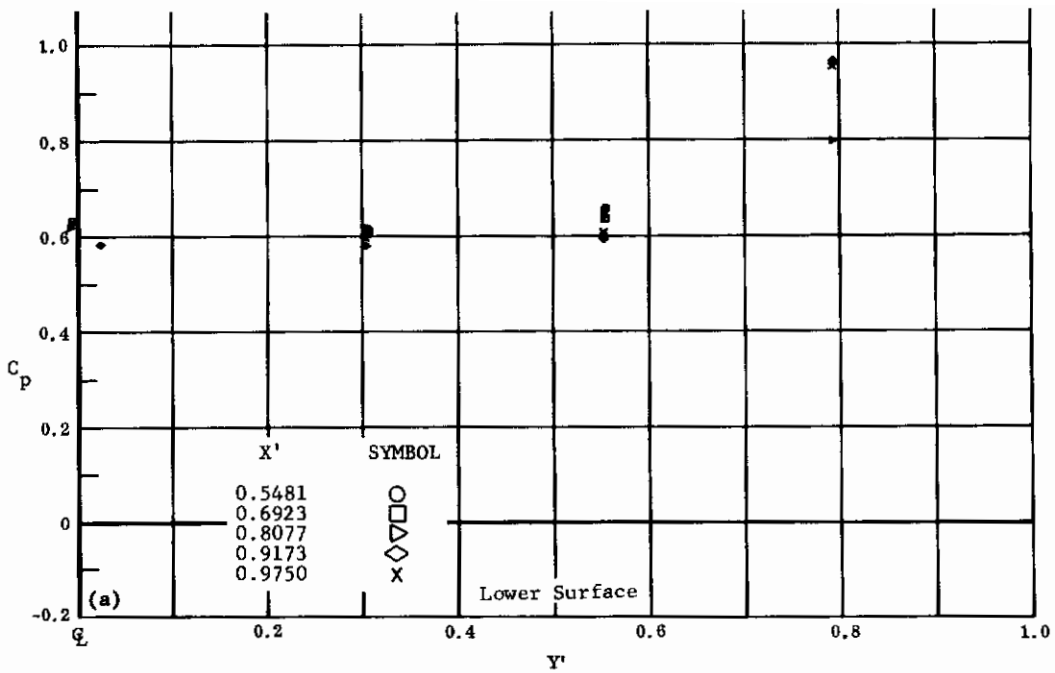

(NONDIMENSIONAL STREAMWISE DISTANCE FROM VIRTUAL APEX)

Fig. 35 Configuration IV, $\alpha = +30$, $\delta_2 = \delta_3 = 0$

a) C_p vs. Y' , lower surface

b) C_p vs. X' , lower surface

Contraails

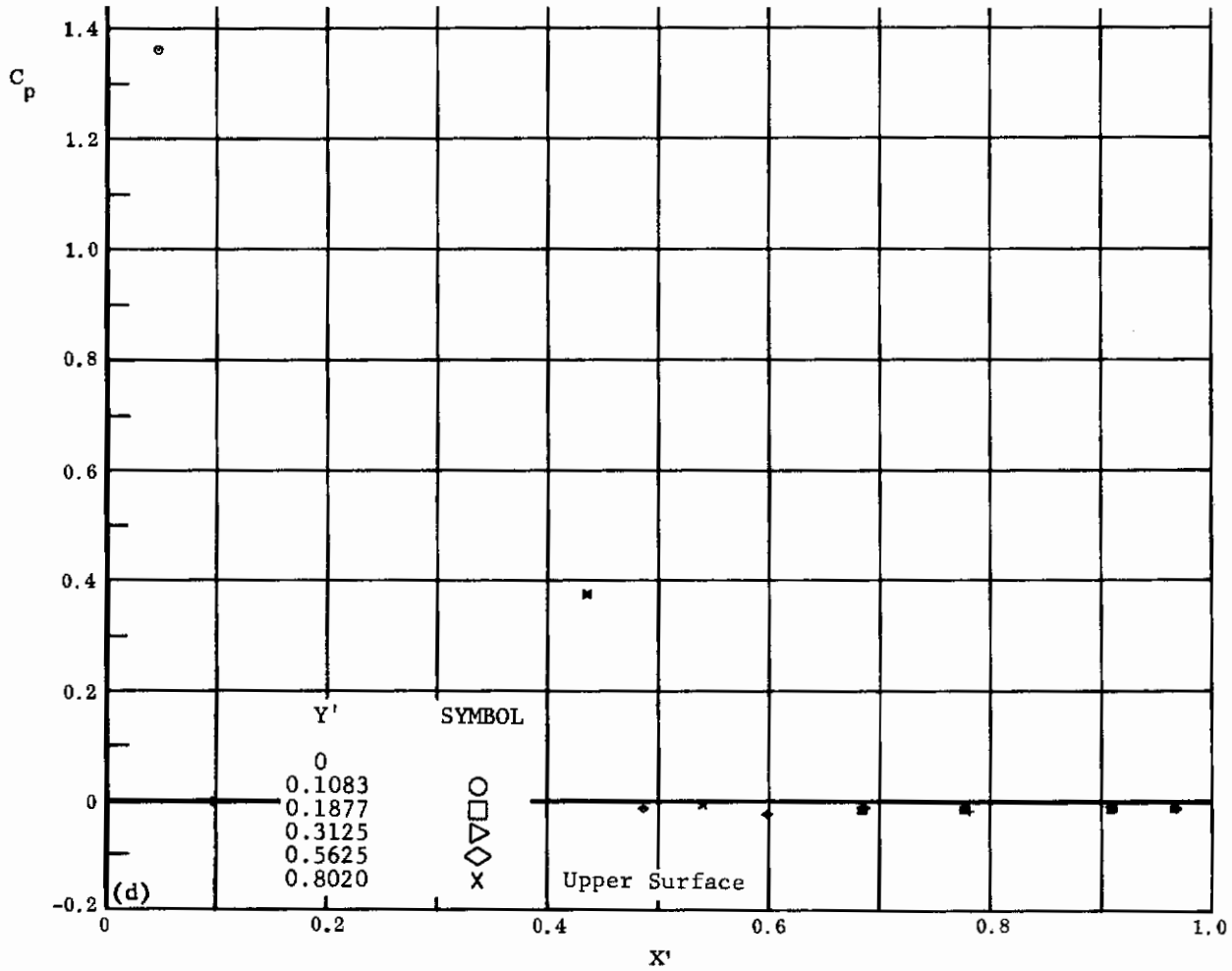
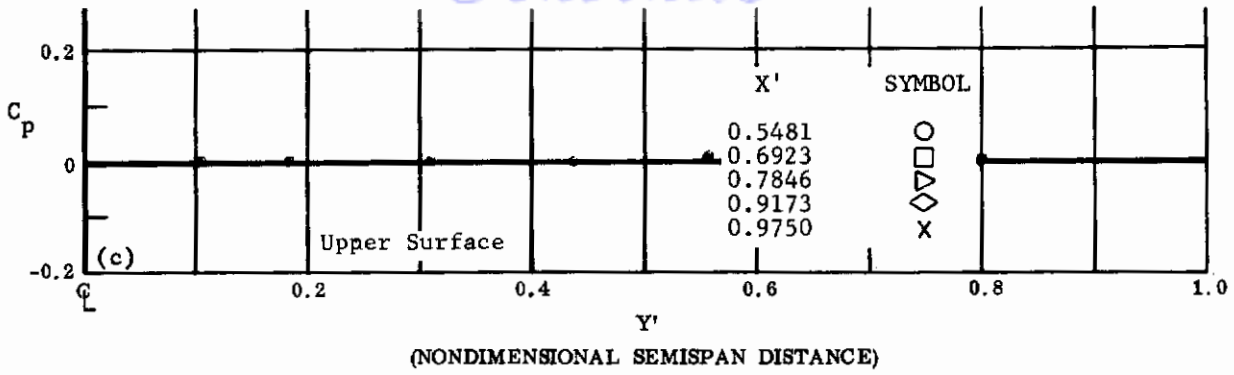

(NONDIMENSIONAL STREAMWISE DISTANCE FROM VIRTUAL APEX)

Fig. 35 Configuration IV, $\alpha = +30$, $\delta_2 = \delta_3 = 0$

c) C_p vs. Y' , upper surface

d) C_p vs. X' , upper surface

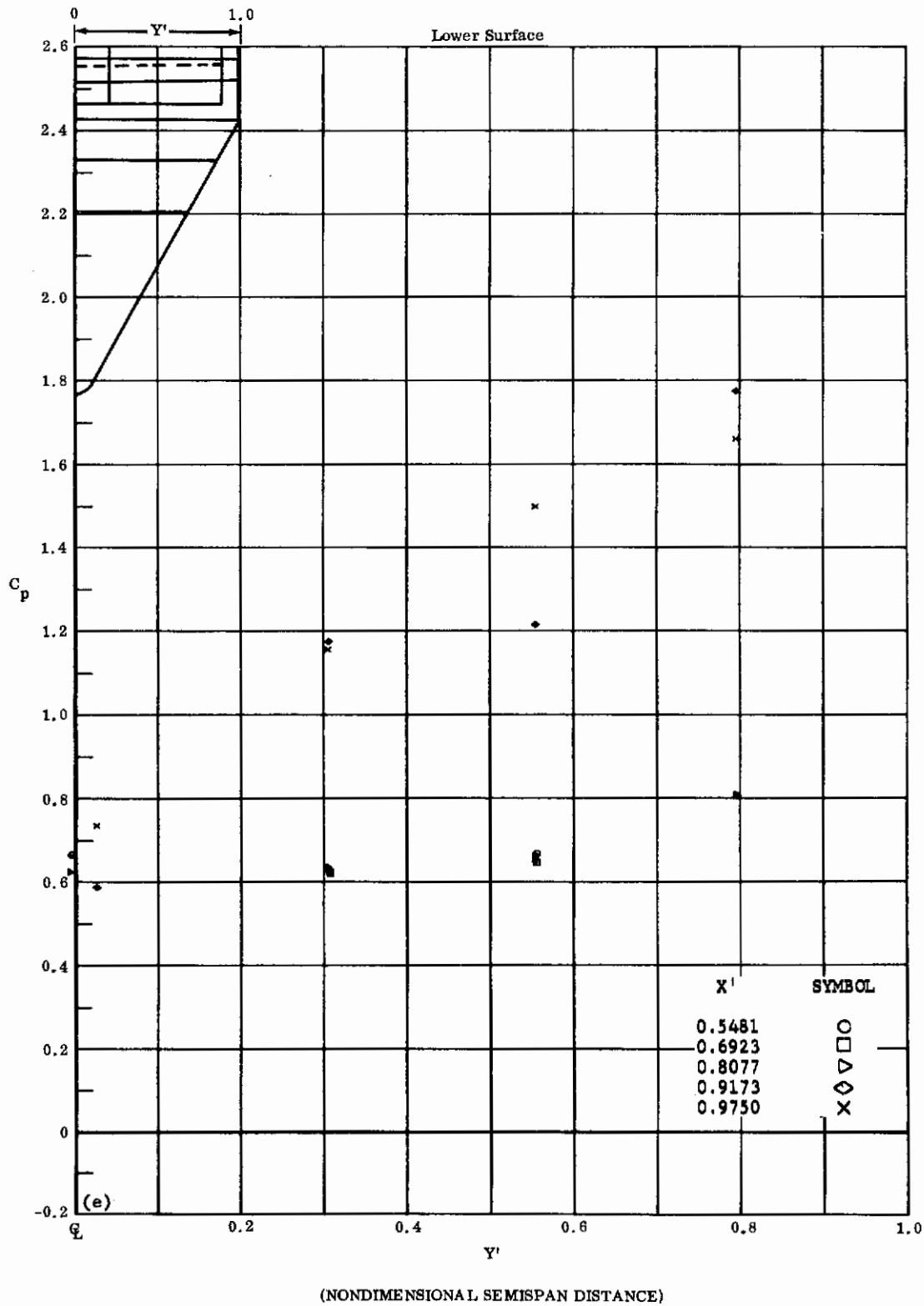
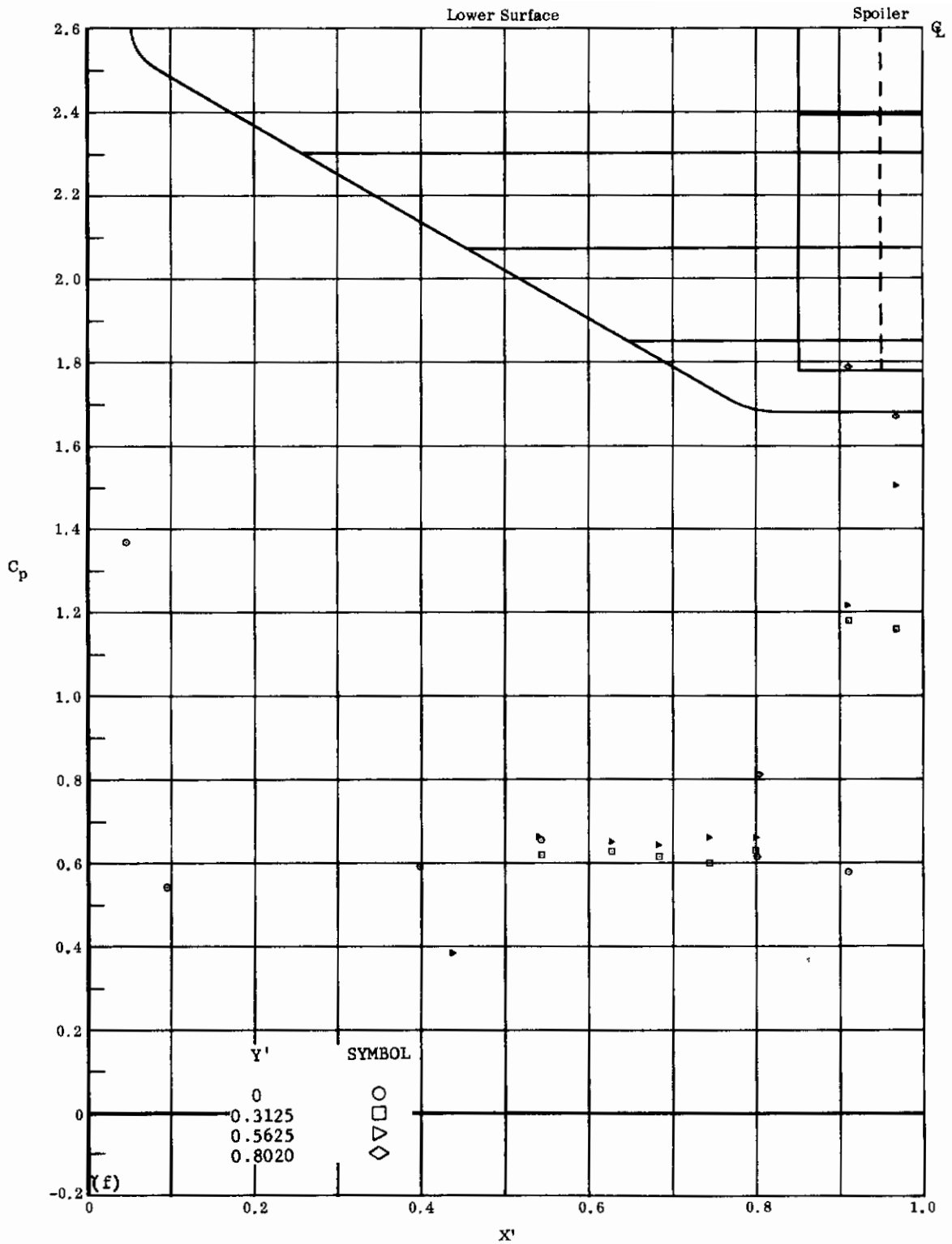

Fig. 35e Configuration IV, $\alpha = +30$, $\delta_2 = \delta_3 = +10$

C_p vs. Y' , lower surface



(NONDIMENSIONAL STREAMWISE DISTANCE FROM VIRTUAL APEX)

Fig. 35f Configuration IV, $\alpha = +30$, $\delta_2 = \delta_3 = +10$

C_p vs. X' , lower surface

Contrails

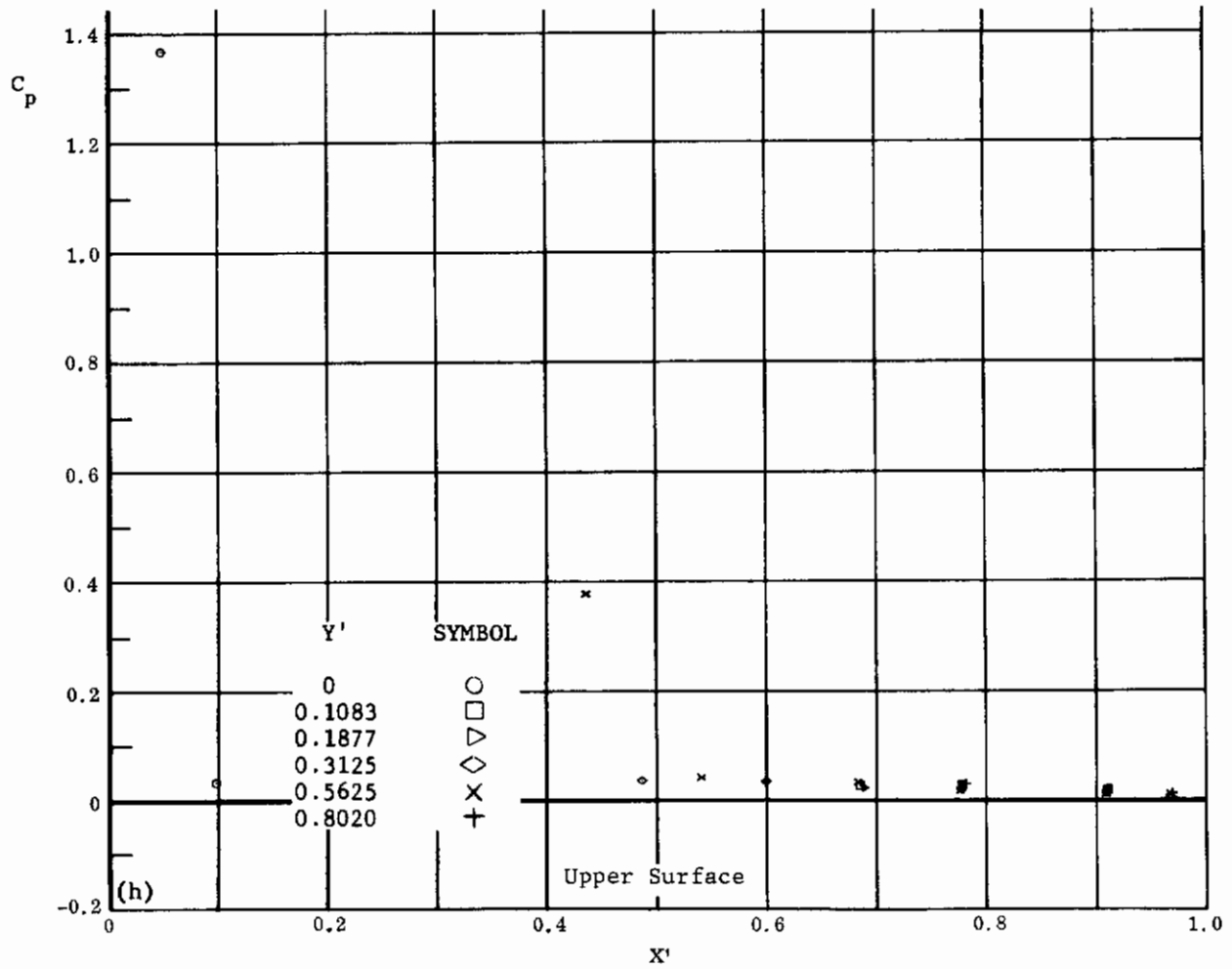
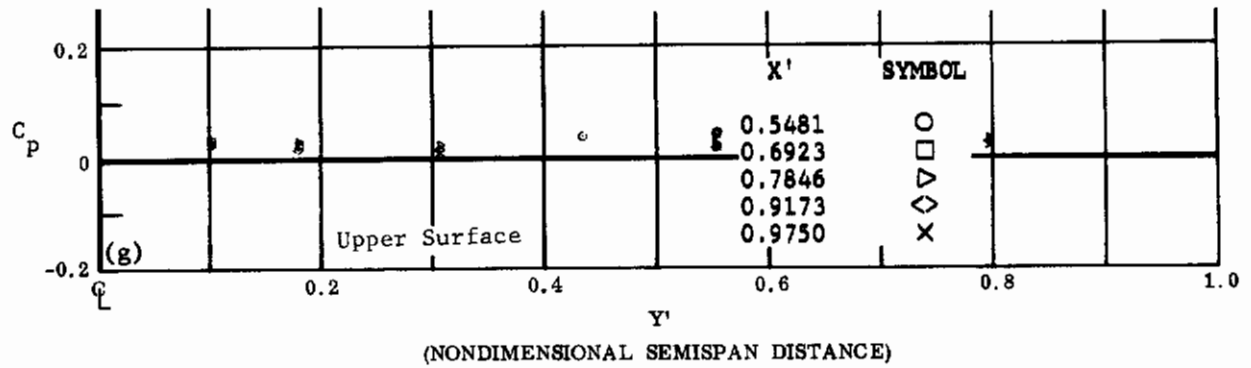

(NONDIMENSIONAL STREAMWISE DISTANCE FROM VIRTUAL APEX)

Fig. 35 Configuration IV, $\alpha = +30$, $\delta_2 = \delta_3 = +10$

g) C_p vs. Y' , upper surface

h) C_p vs. X' , upper surface

Contrails

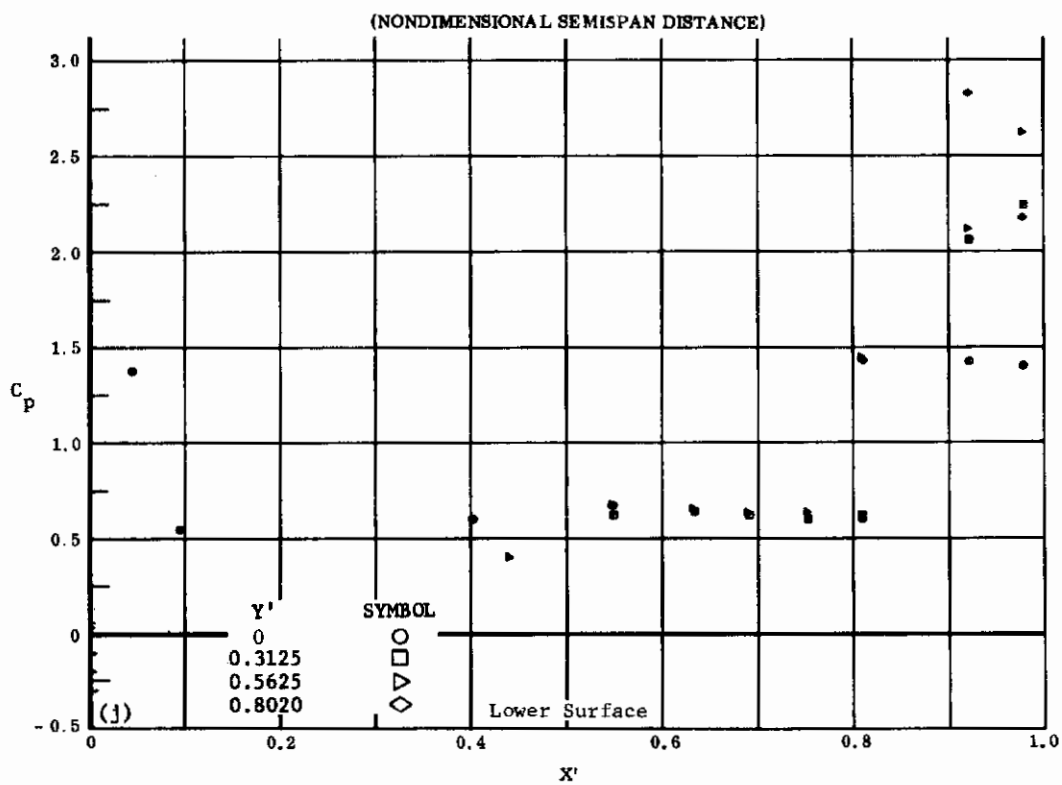
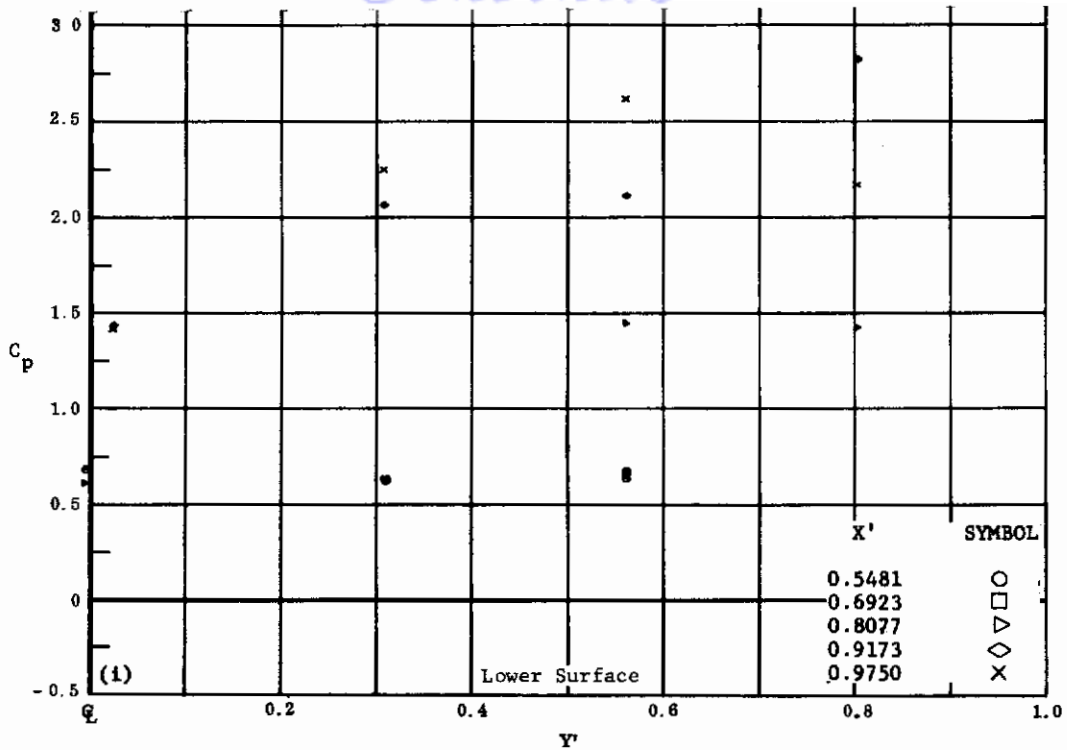

(NONDIMENSIONAL STREAMWISE DISTANCE FROM VIRTUAL APEX)

Fig. 35 Configuration IV, $\alpha = +30$, $\delta_2 = \delta_3 = +20$

- i) C_p vs. Y' , lower surface
- j) C_p vs. X' , lower surface

Contrails

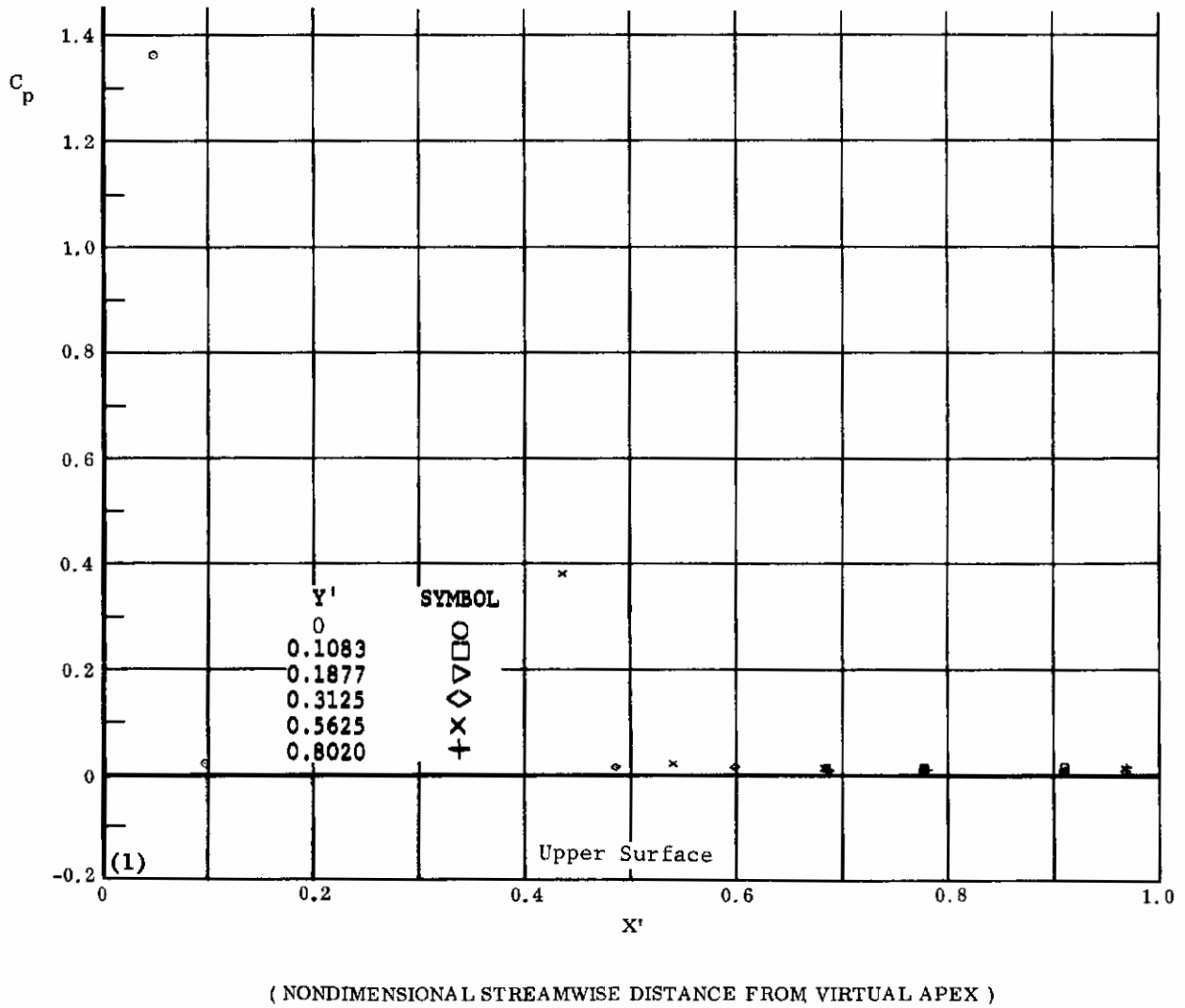
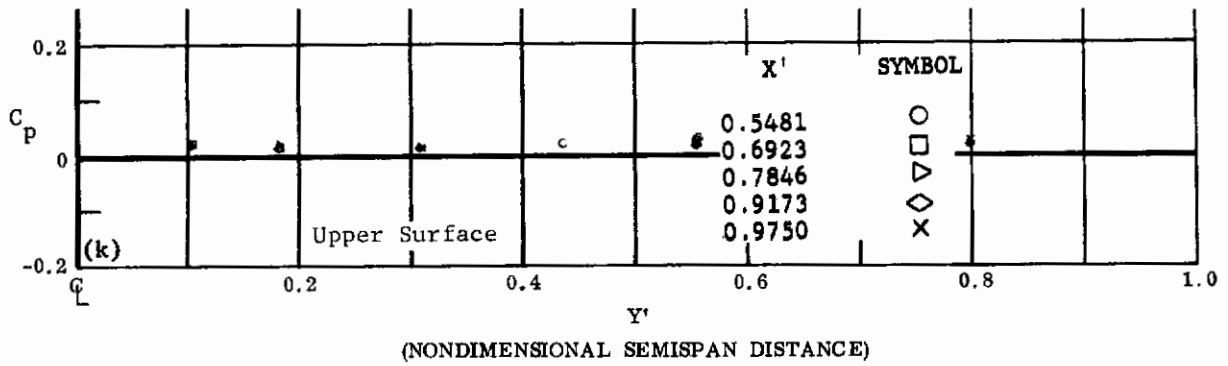

Fig. 35 Configuration IV, $\alpha = +30$, $\delta_2 = \delta_3 + 20$

k) C_p vs. Y' , upper surface

1) C_p vs. X' , upper surface

Contrails

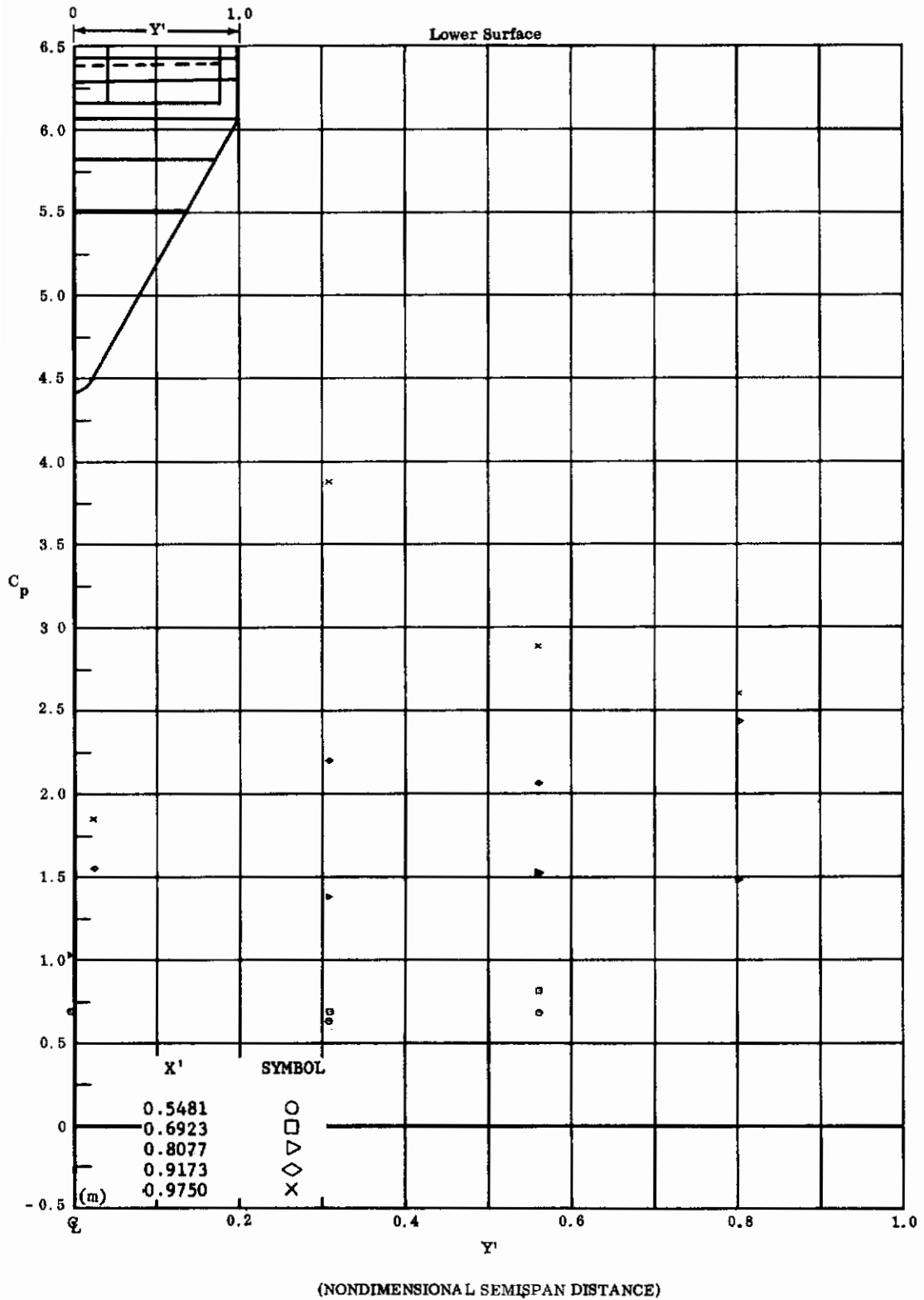

Fig. 35m Configuration IV, $\alpha = +30$, $\delta_2 = \delta_3 = +30$
 C_p vs. Y' , lower surface

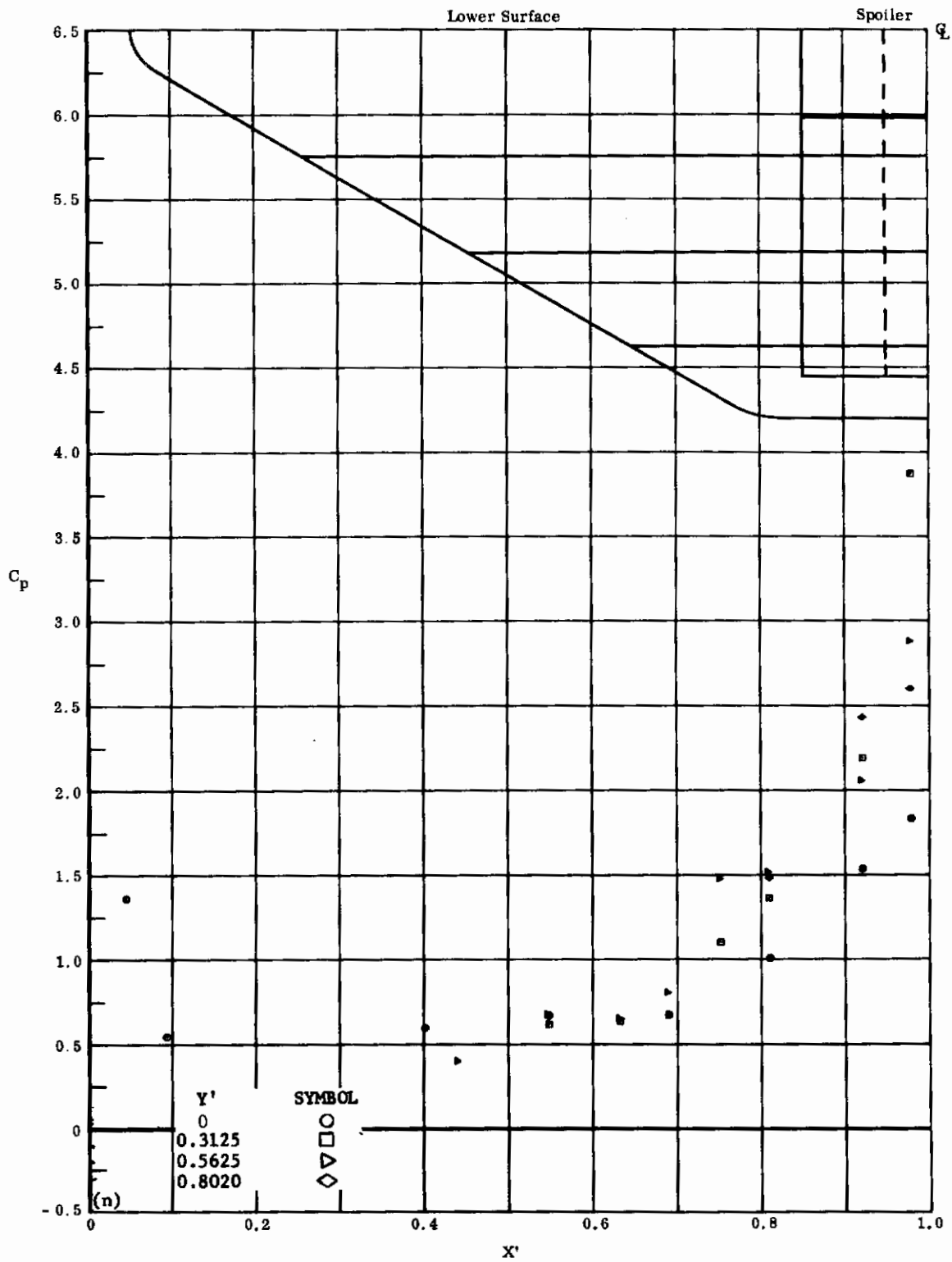
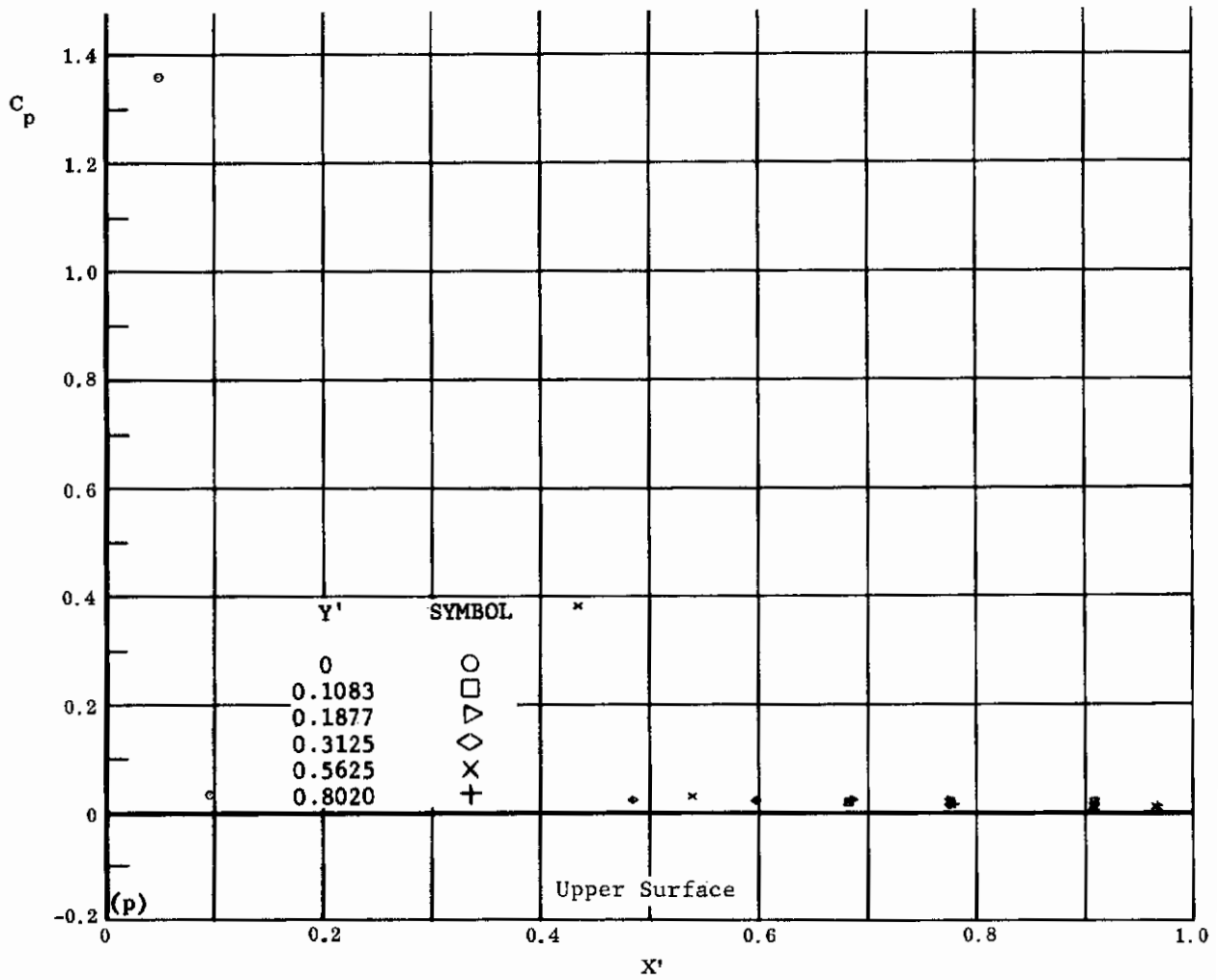
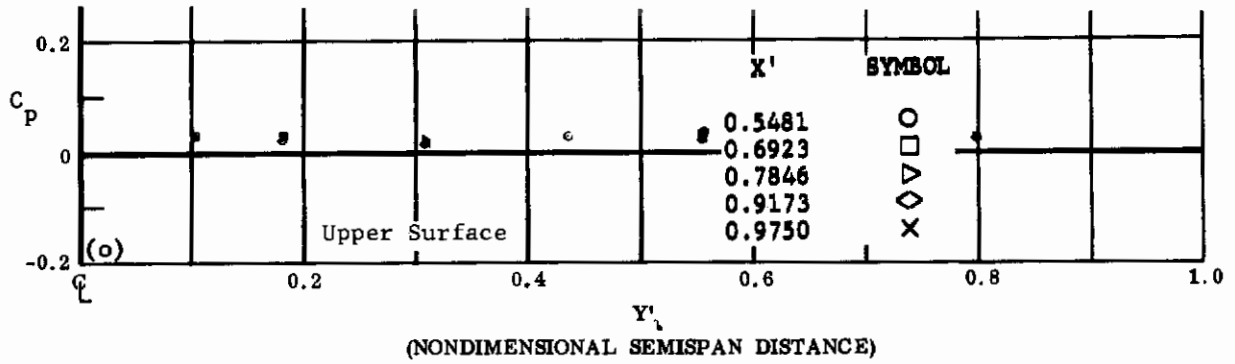

Fig. 35n Configuration IV, $\alpha = +30$, $\delta_2 = \delta_3 = +30$

C_p vs. X' , lower surface

Contrails



(NONDIMENSIONAL STREAMWISE DISTANCE FROM VIRTUAL APEX)

Fig. 35 Configuration IV, $\alpha = +30$, $\delta_2 = \delta_3 = +30$

o) C_p vs. Y' , upper surface

p) C_p vs. X' , upper surface

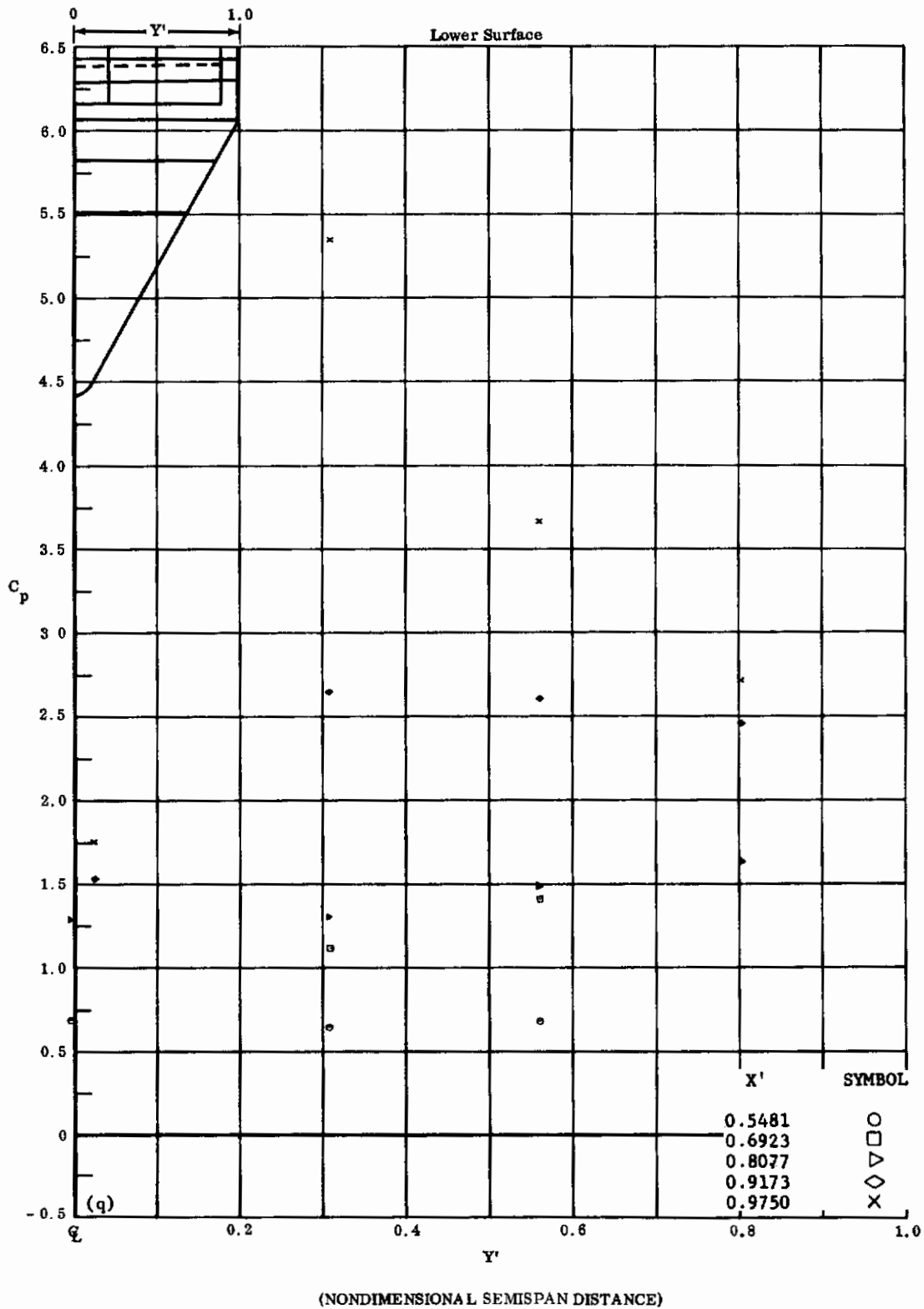
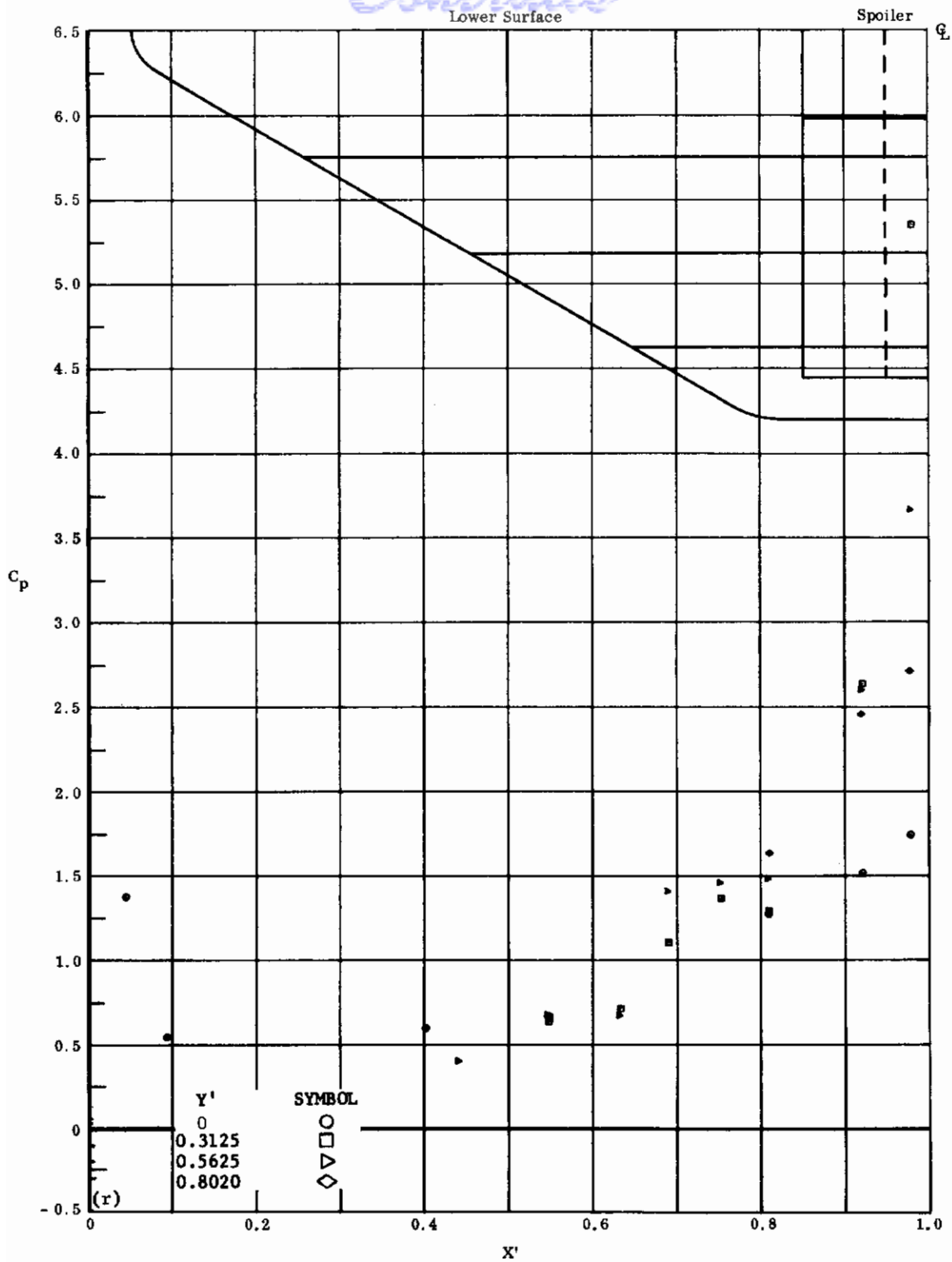

Fig. 35q Configuration IV, $\alpha = +30$, $\delta_2 = \delta_3 = +39$

C_p vs. Y' , lower surface



(NONDIMENSIONAL STREAMWISE DISTANCE FROM VIRTUAL APEX)

Fig. 35r Configuration IV, $\alpha = +30$, $\delta_2 = \delta_3 = +39$

C_p vs. X' , lower surface

Contrails

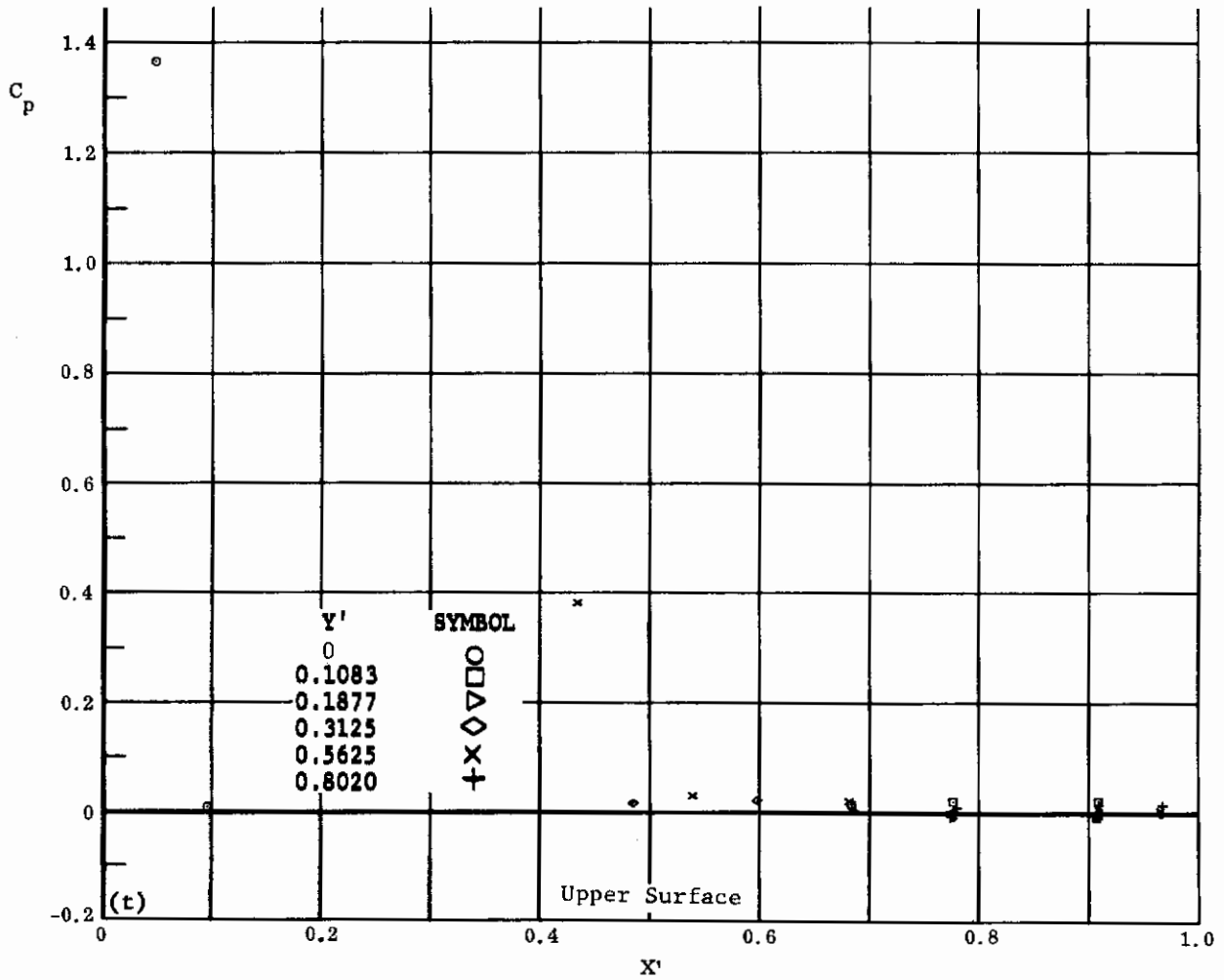
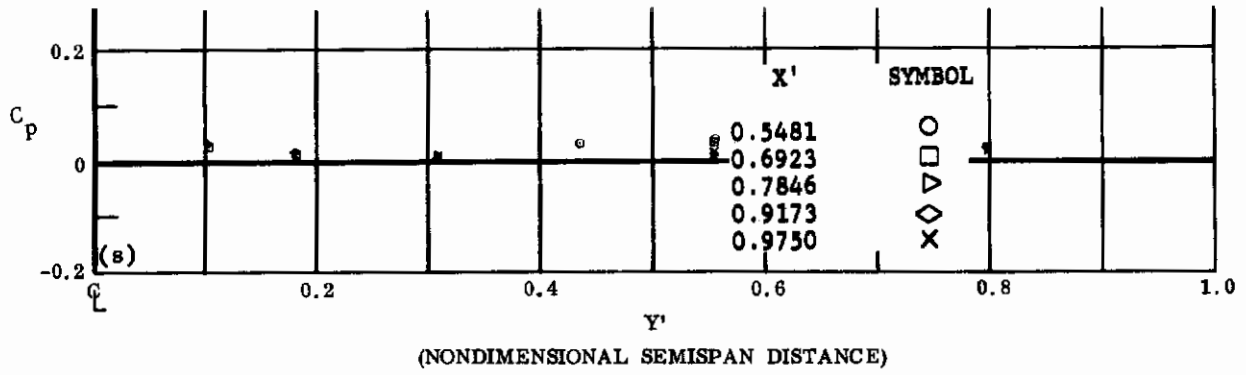

(NONDIMENSIONAL STREAMWISE DISTANCE FROM VIRTUAL APEX)

Fig. 35 Configuration IV, $\alpha = +30$, $\delta_2 = \delta_3 = +39$

s) C_p vs. Y' , upper surface

t) C_p vs. X' , upper surface

Contrails

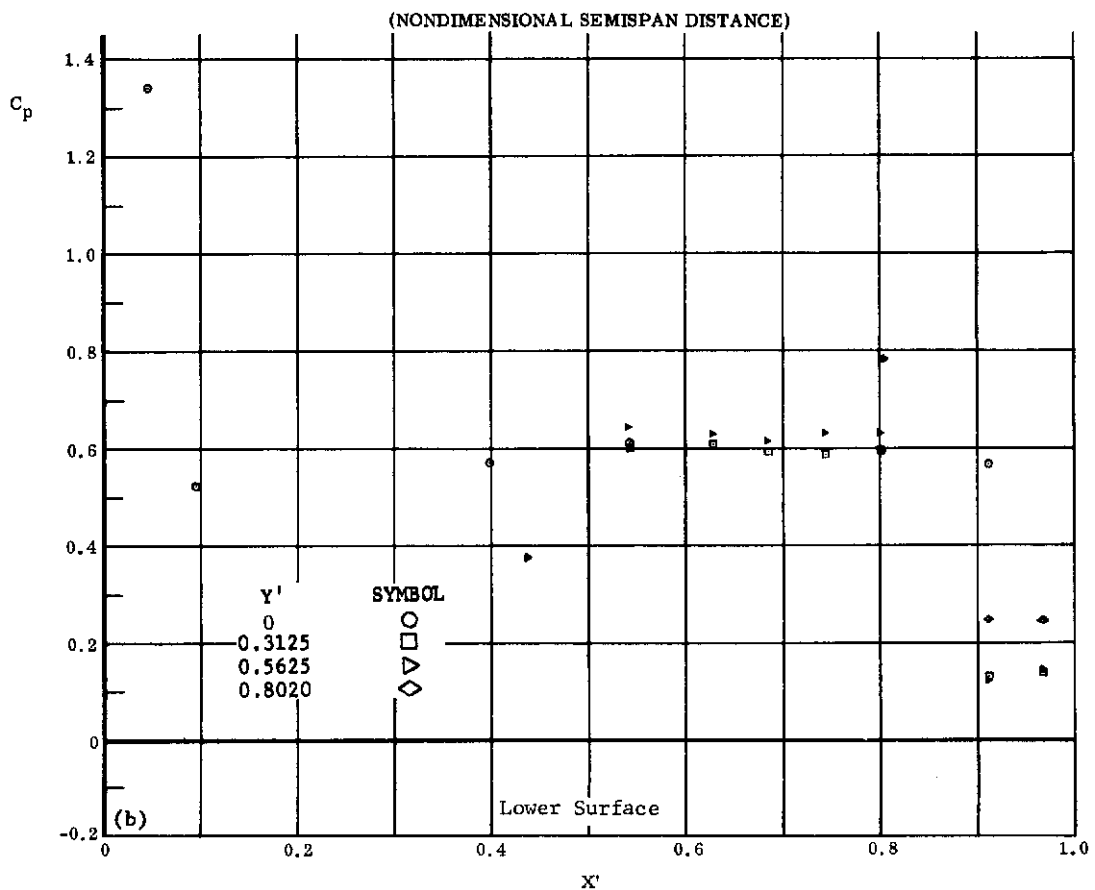
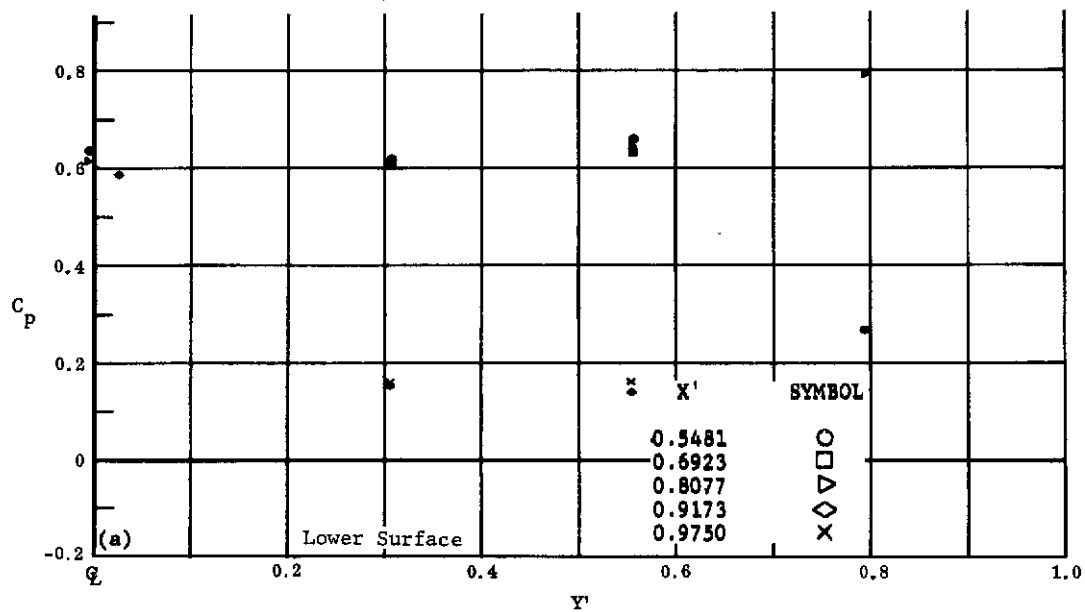

(NONDIMENSIONAL STREAMWISE DISTANCE FROM VIRTUAL APEX)

Fig. 36 Configuration IV, $\alpha = +30$, $\delta_2 = \delta_3 = -20$

a) C_p vs. Y' , lower surface

b) C_p vs. X' , lower surface

Contrails

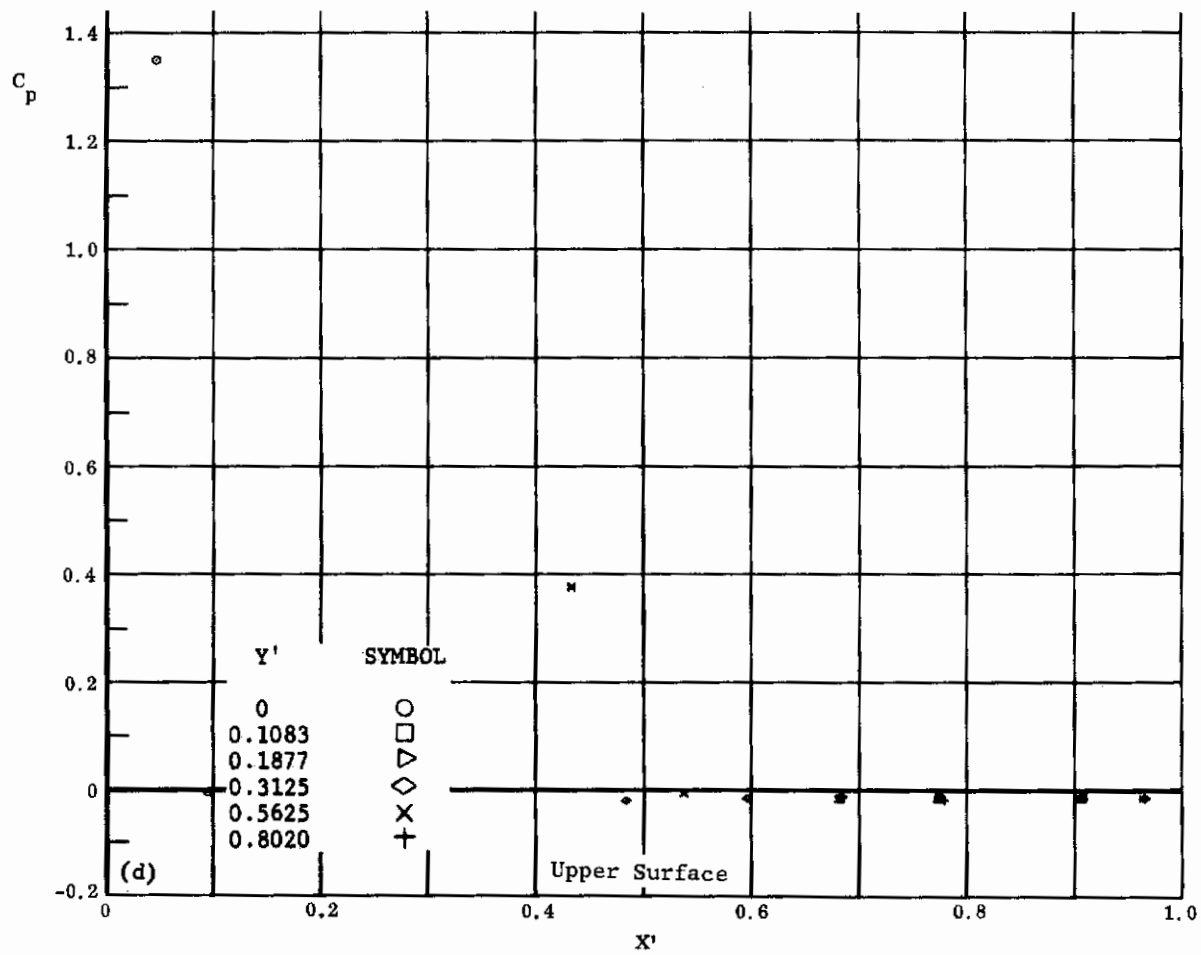
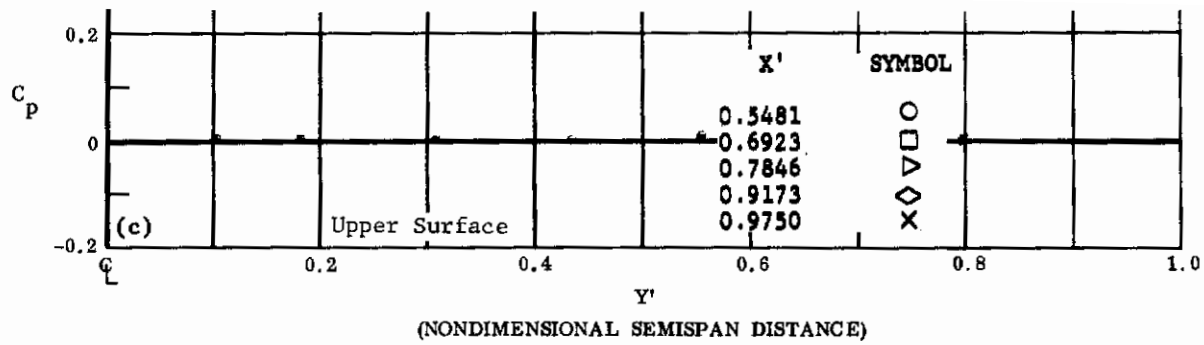
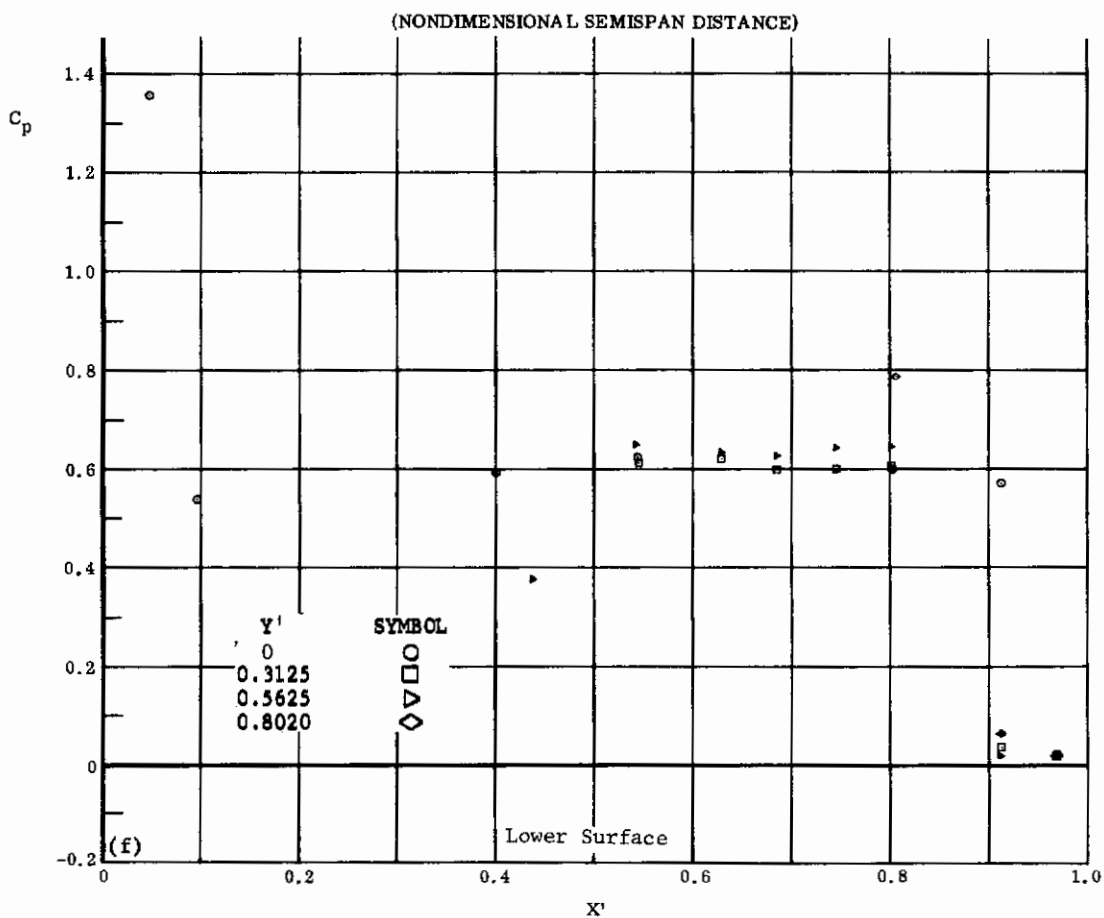
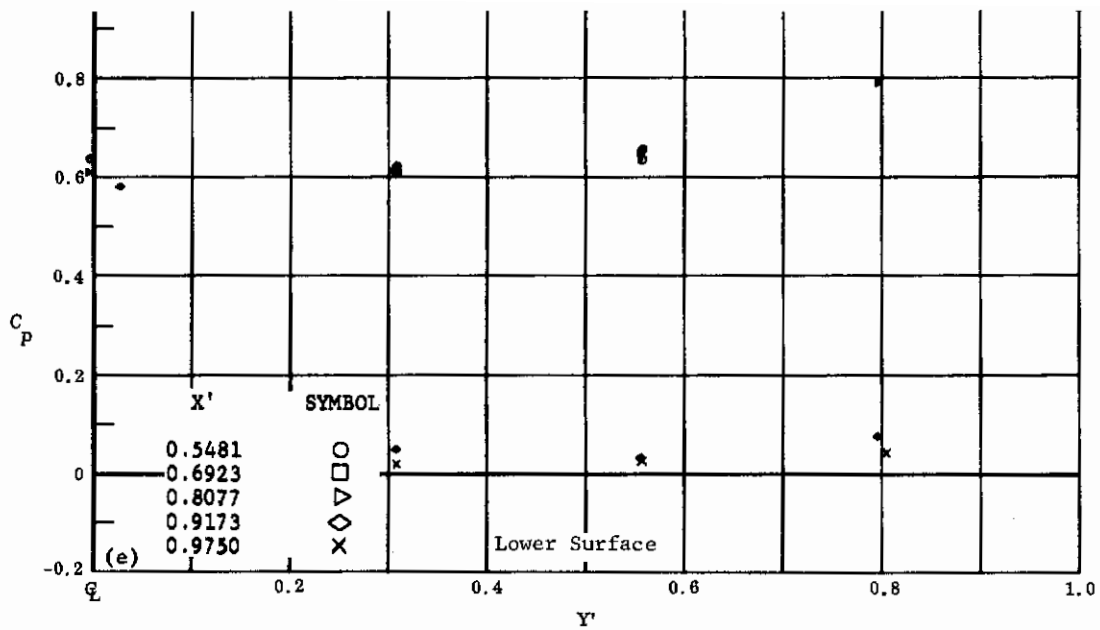

Fig. 36 Configuration IV, $\alpha = +30$, $\delta_2 = \delta_3 = -20$

c) C_p vs. Y' , upper surface

d) C_p vs. X' , upper surface

Contrails



(NONDIMENSIONAL STREAMWISE DISTANCE FROM VIRTUAL APEX)

Fig. 36 Configuration IV, $\alpha = +30$, $\delta_2 = \delta_3 = -39$

e) C_p vs. Y' , lower surface

f) C_p vs. X' , lower surface

Contrails

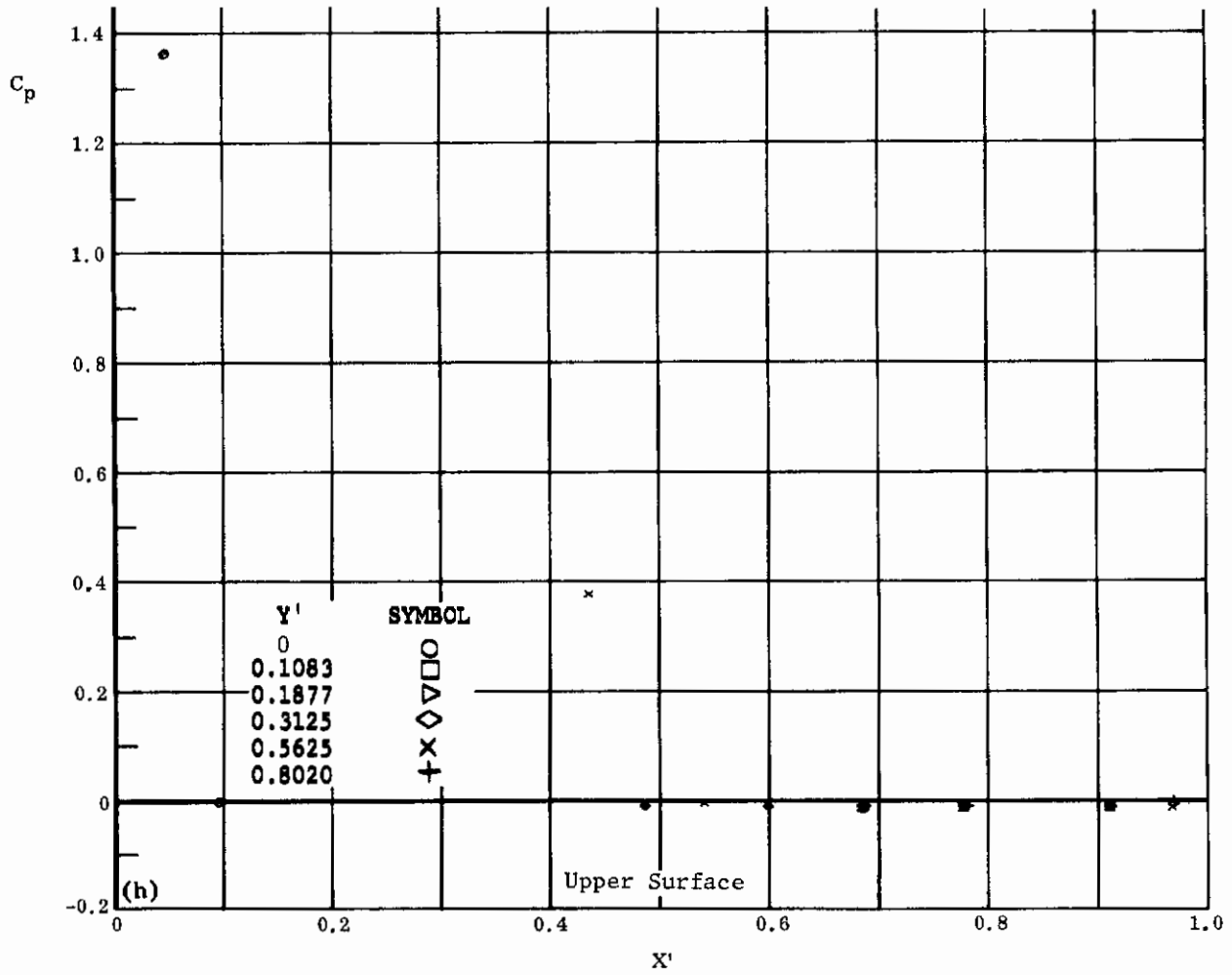
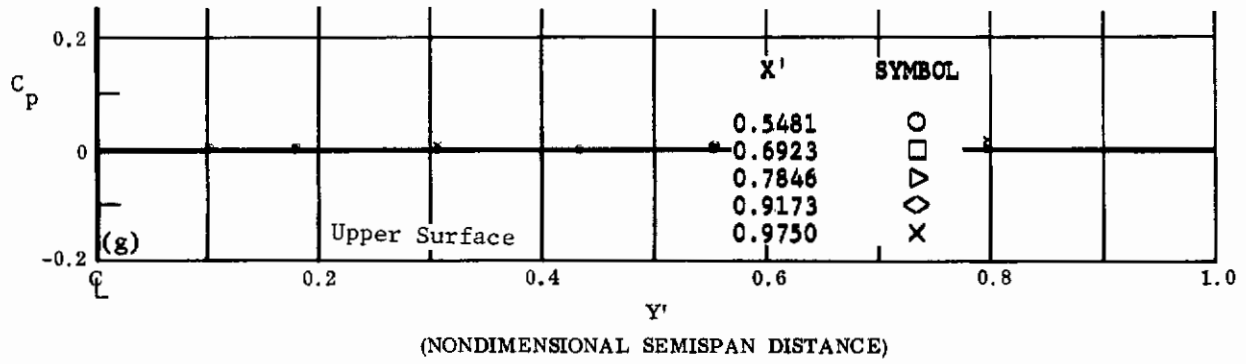

Fig. 36 Configuration IV, $\alpha = +30$, $\delta_2 = \delta_3 = -39$

g) C_p vs. Y' , upper surface

h) C_p vs. X' , upper surface

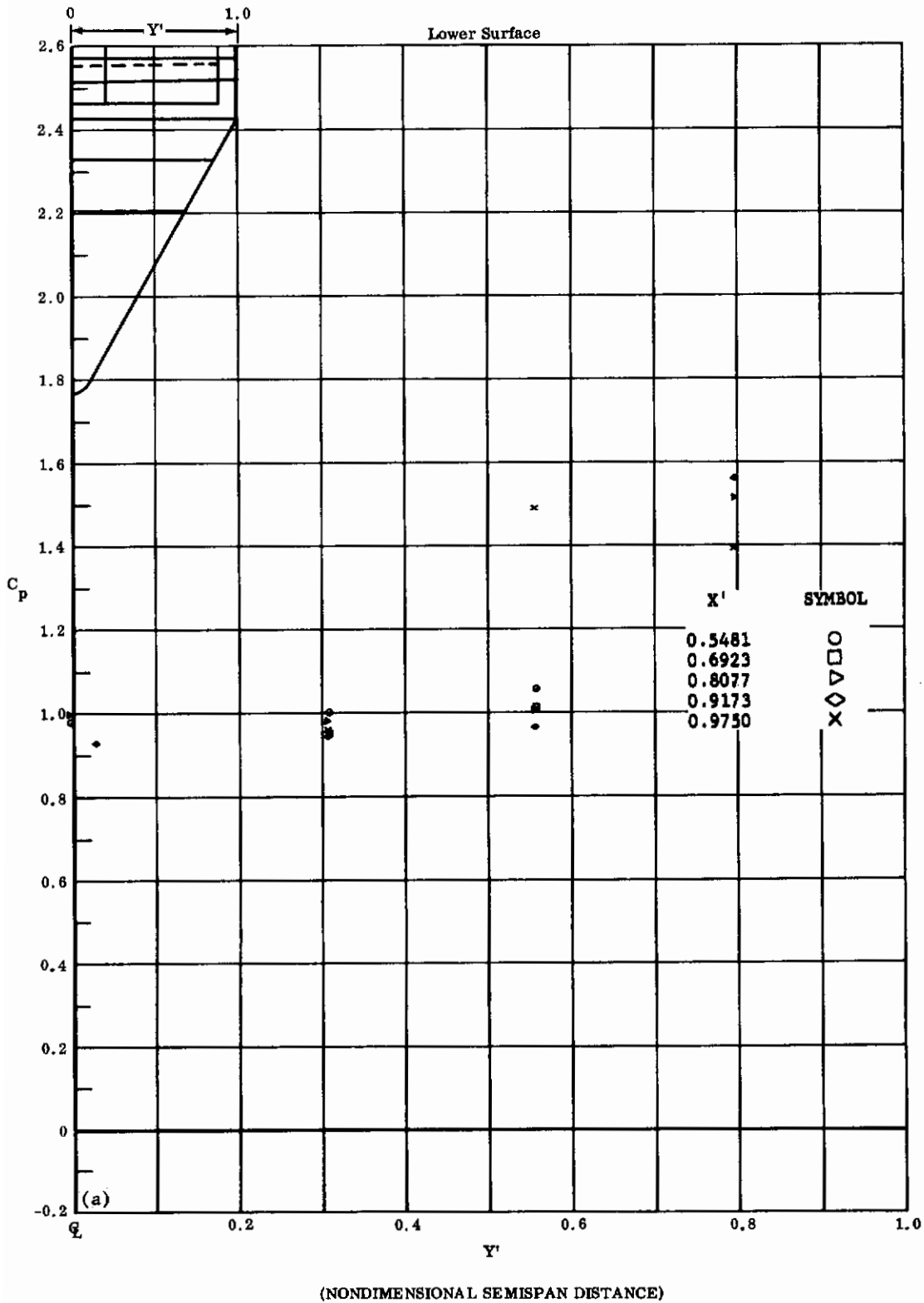
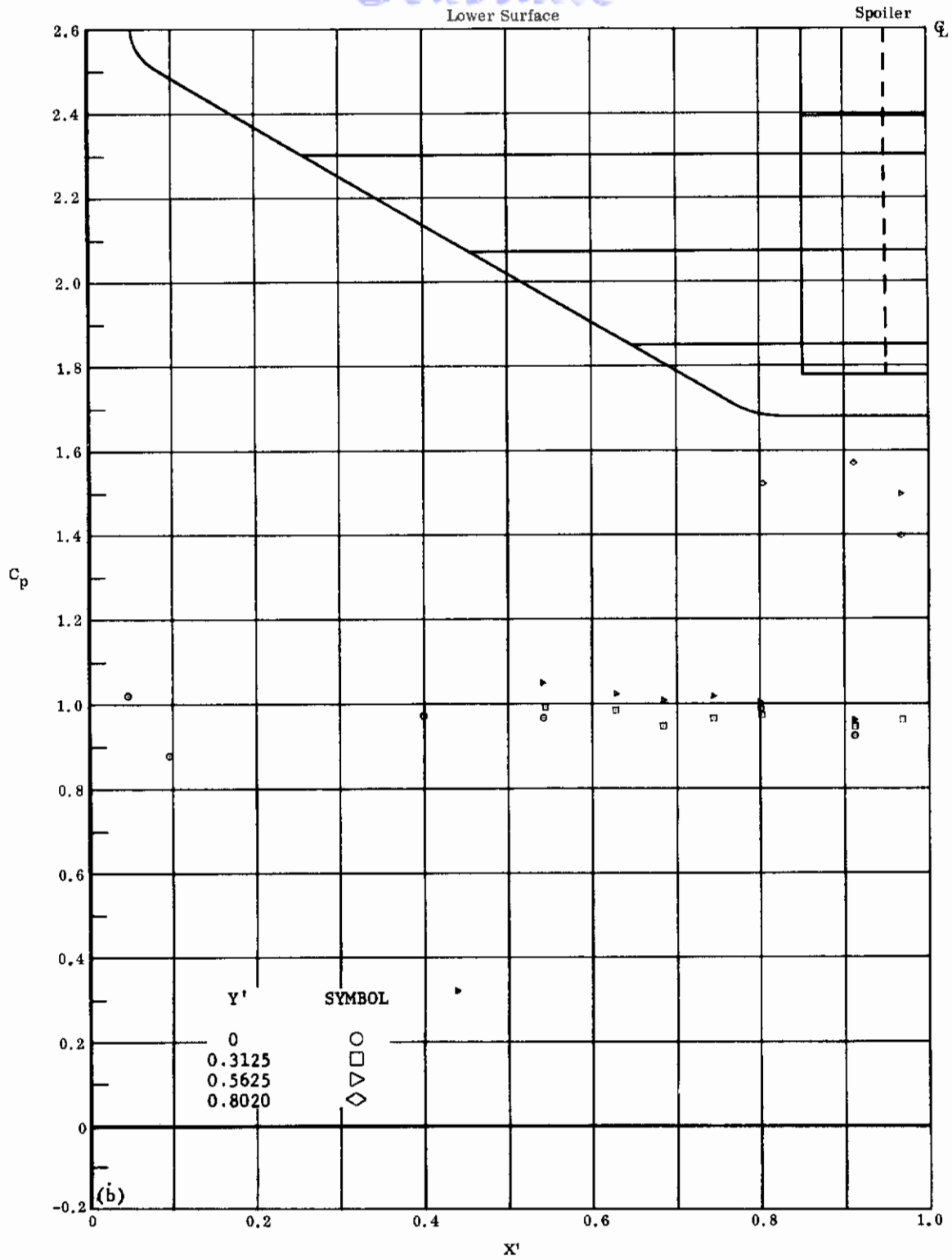

Fig. 37a Configuration IV, $\alpha = +40^\circ$, $\delta_2 = \delta_3 = 0$

C_p vs. Y' , lower surface



(NONDIMENSIONAL STREAMWISE DISTANCE FROM VIRTUAL APEX)

Fig. 37b Configuration IV, $\alpha = +40$, $\delta_2 = \delta_3 = 0$

C_p vs. X' , lower surface

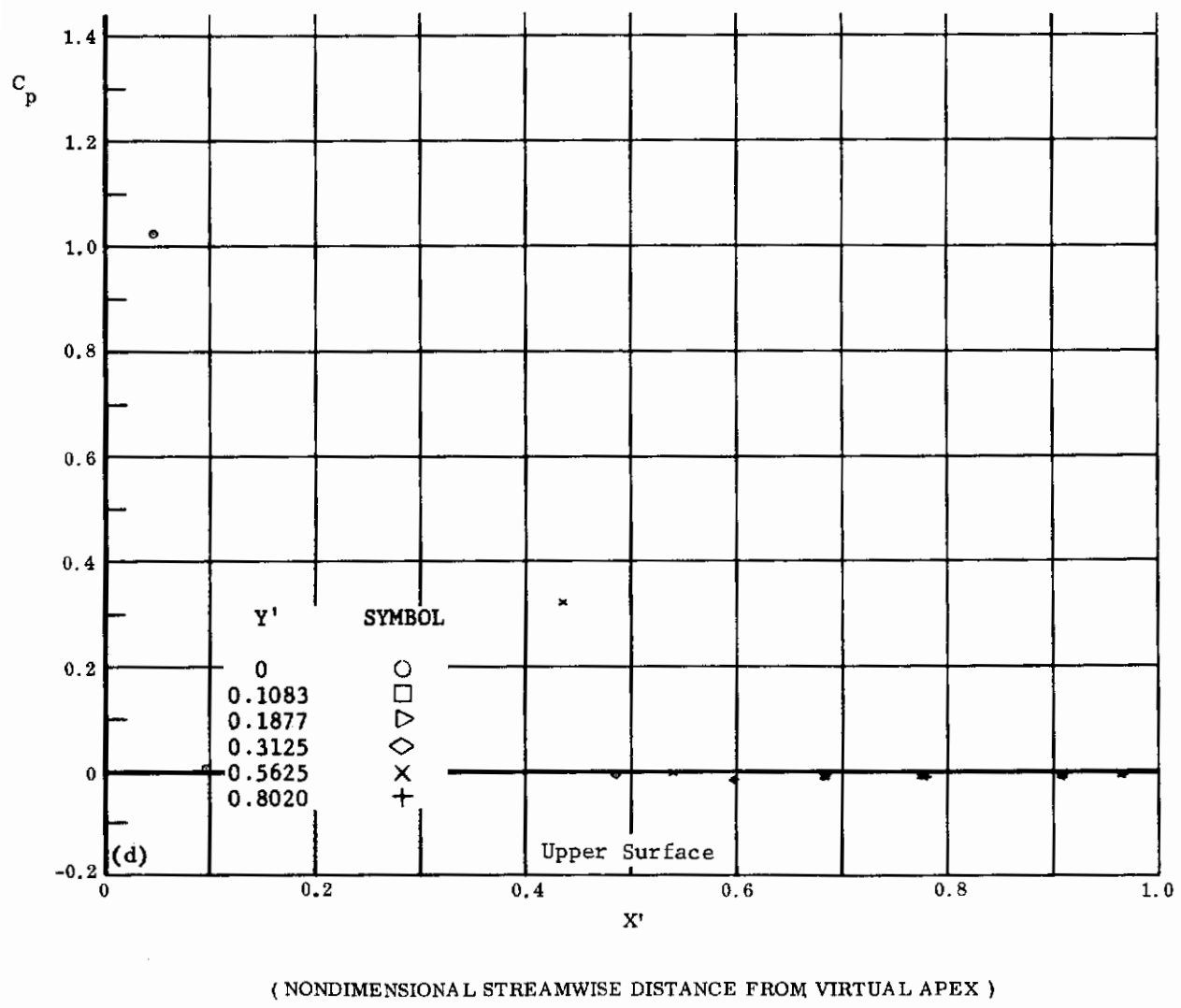
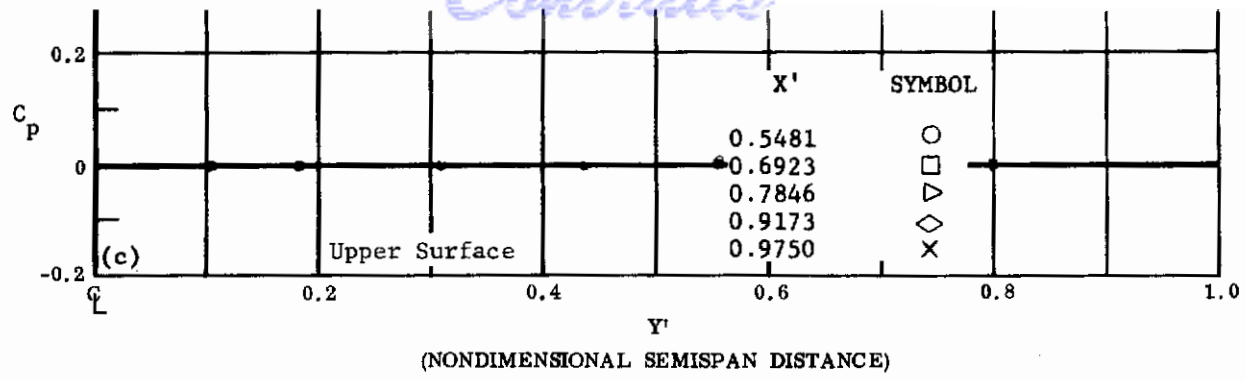

Fig. 37 Configuration IV, $\alpha = +40$, $\delta_2 = \delta_3 = 0$

- c) C_p vs. Y' , upper surface
- d) C_p vs. X' , upper surface

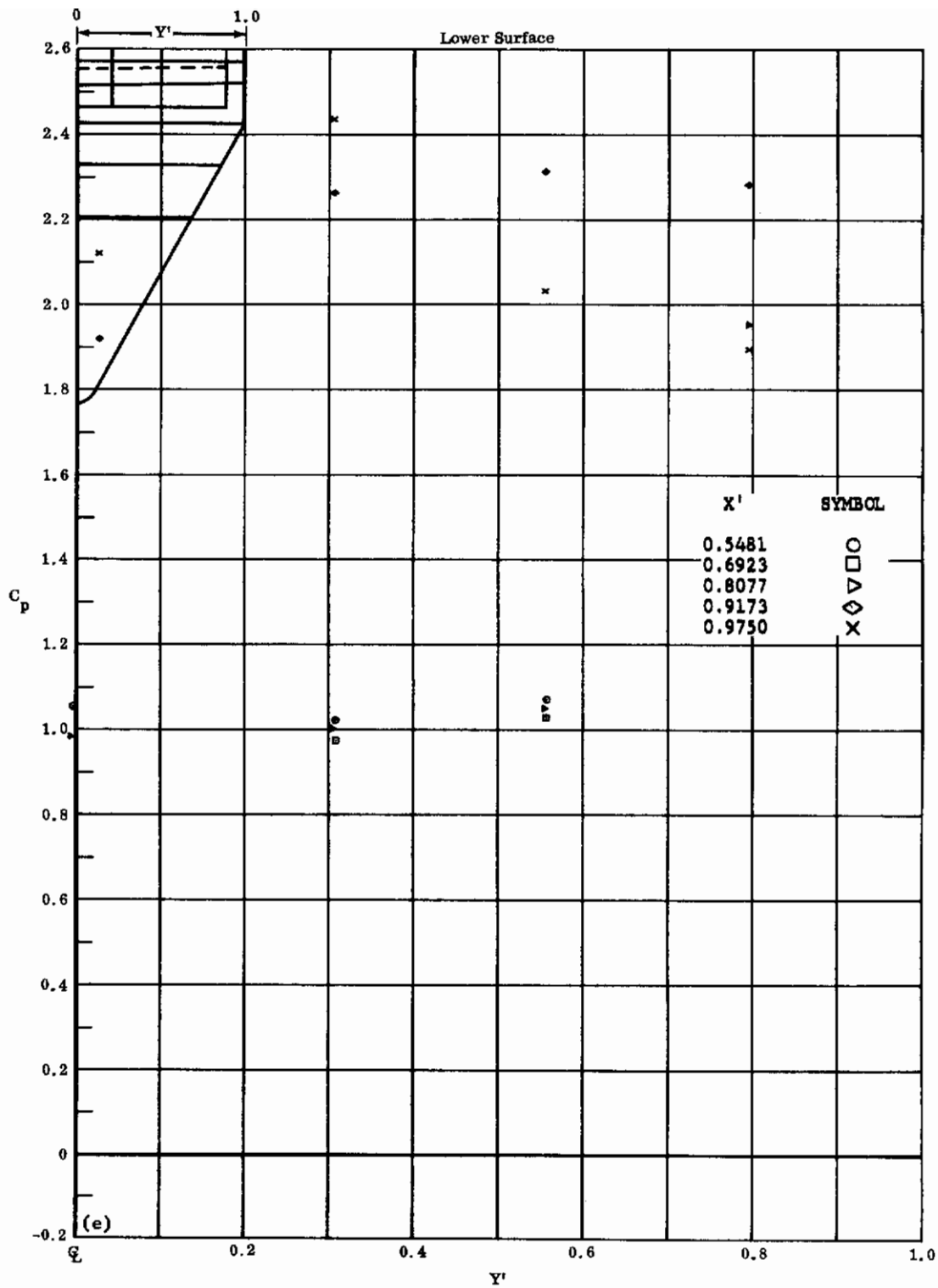
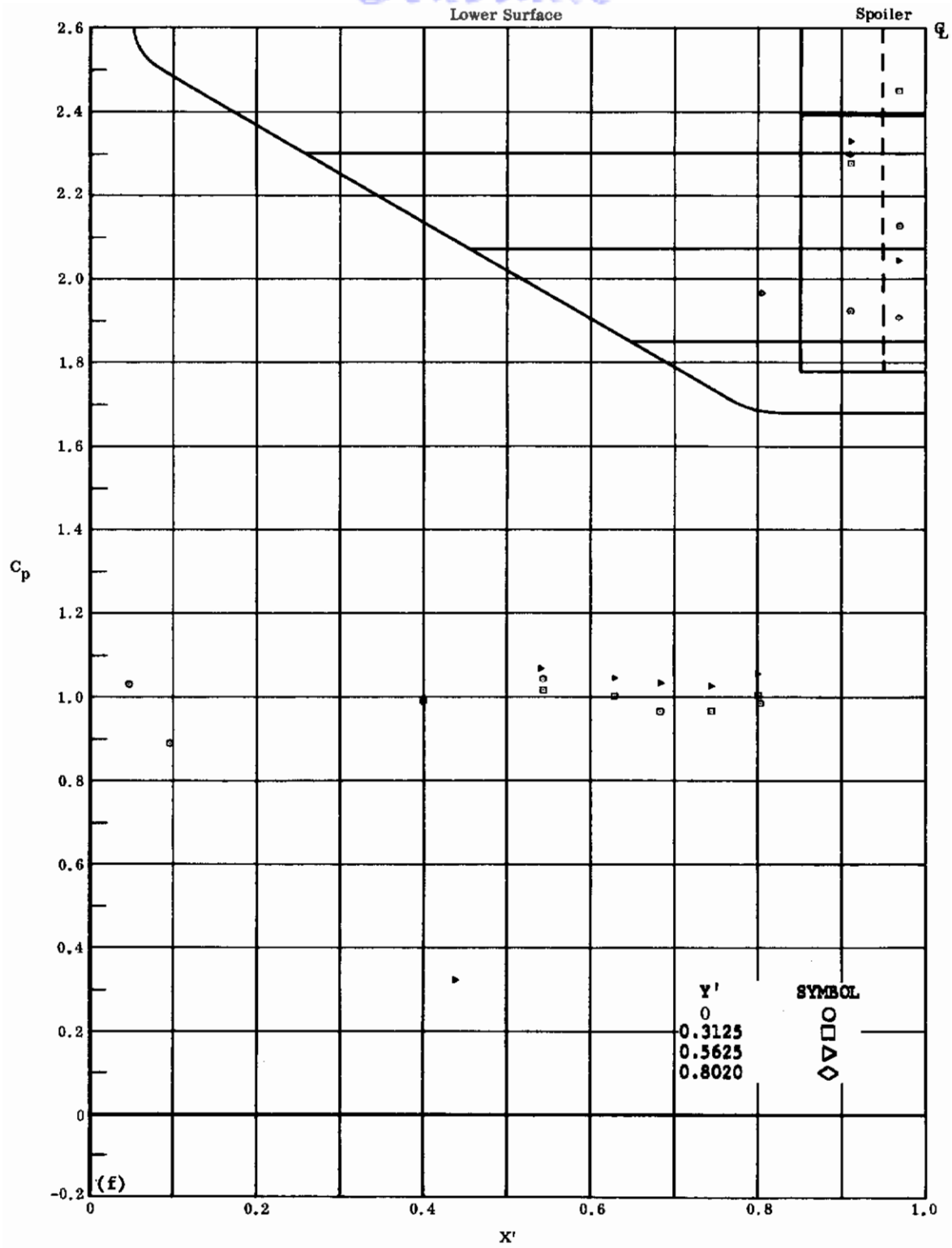

Fig. 37e Configuration IV, $\alpha = +40$, $\delta_2 = \delta_3 = +10$

C_p vs. Y' , lower surface



(NONDIMENSIONAL STREAMWISE DISTANCE FROM VIRTUAL APEX)

Fig. 37f Configuration IV, $\alpha = +40$, $\delta_2 = \delta_3 = +10$

C_p vs. X' , lower surface

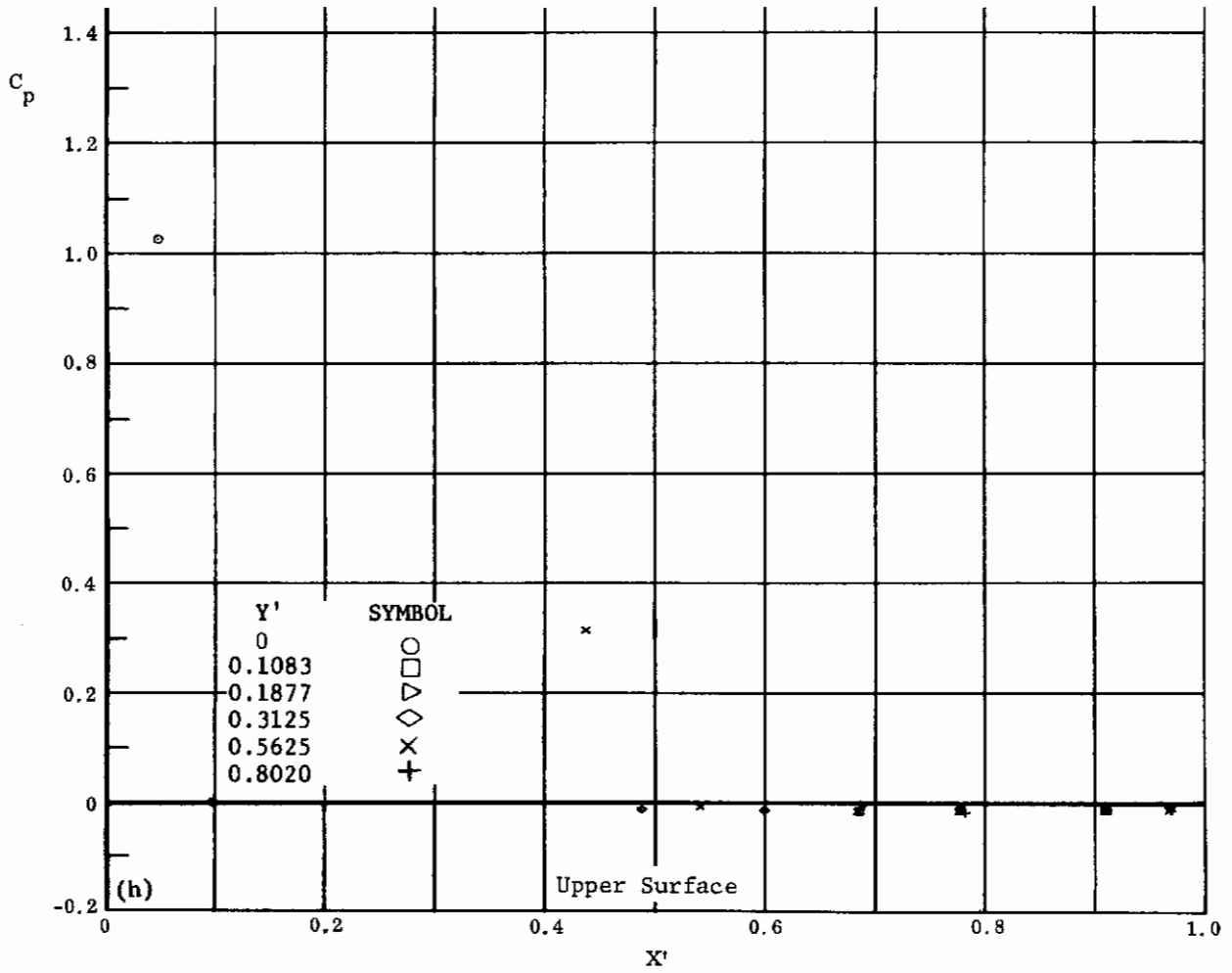
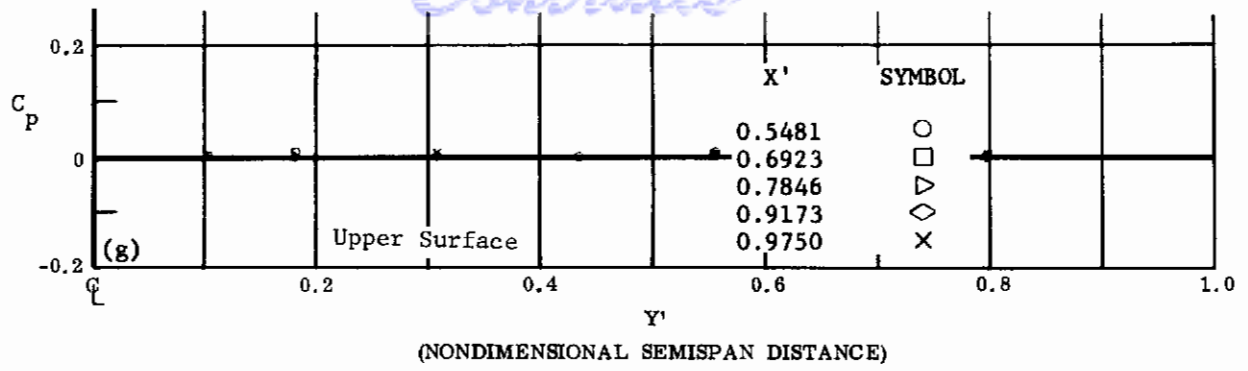
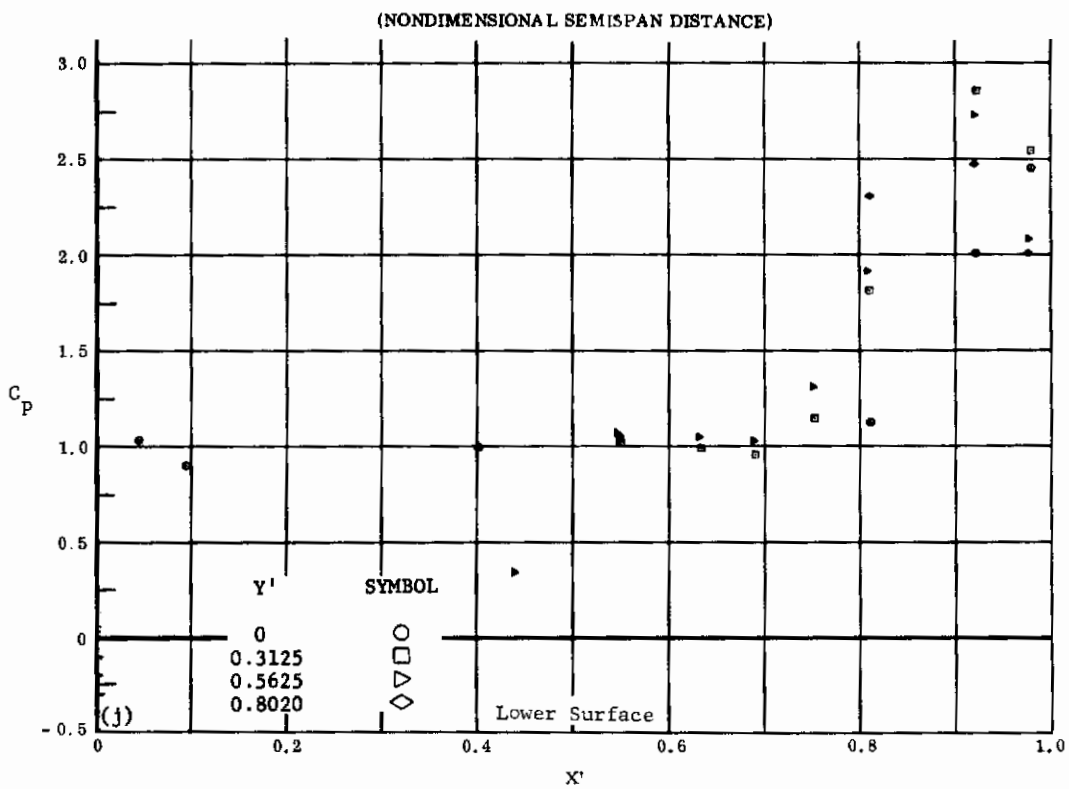
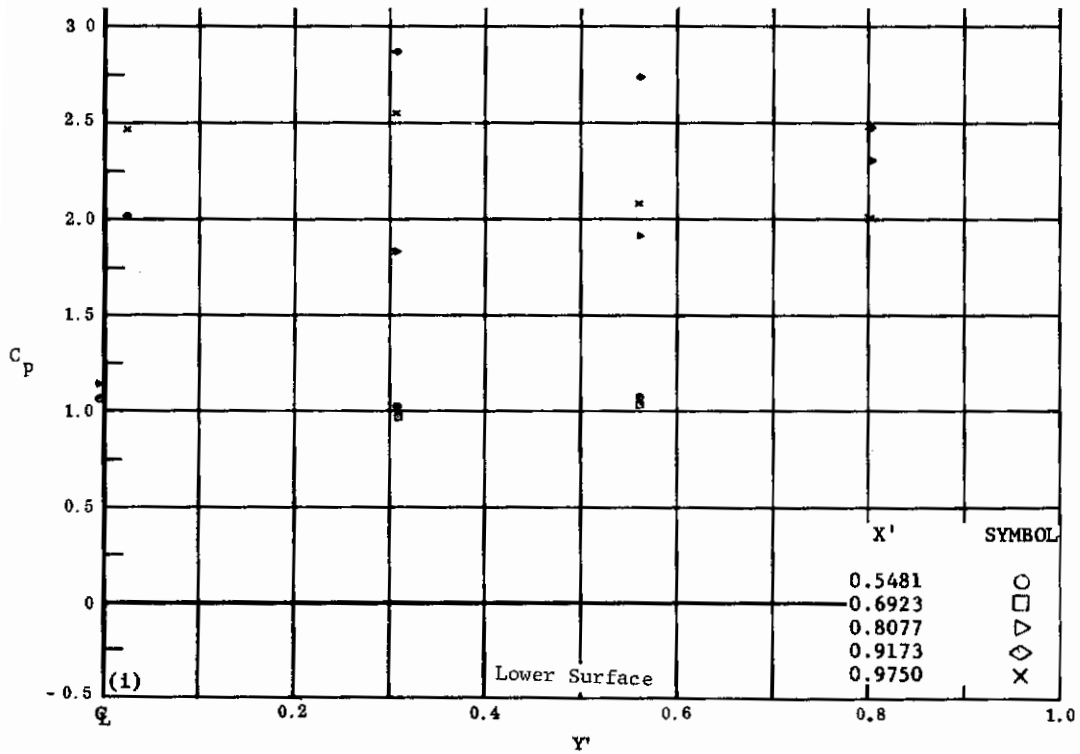

Fig. 37 Configuration IV, $\alpha = +40$, $\delta_2 = \delta_3 = +10$

g) C_p vs. Y' , upper surface

h) C_p vs. X' , upper surface

Contrails



(NONDIMENSIONAL STREAMWISE DISTANCE FROM VIRTUAL APEX)

Fig. 37 Configuration IV, $\alpha = +40$, $\delta_2 = \delta_3 = +20$

i) C_p vs. Y' , lower surface

j) C_p vs. X' , lower surface

Contrails

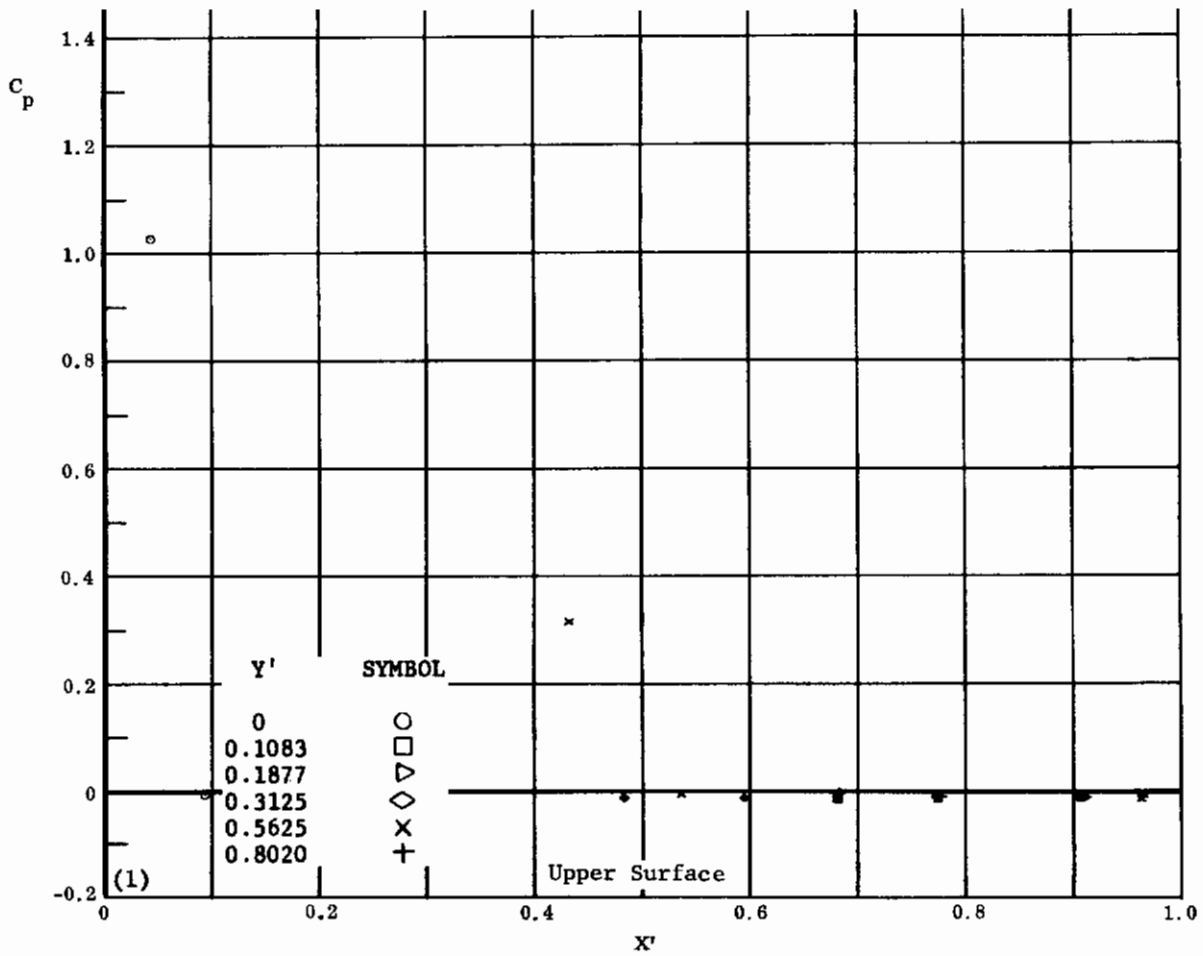
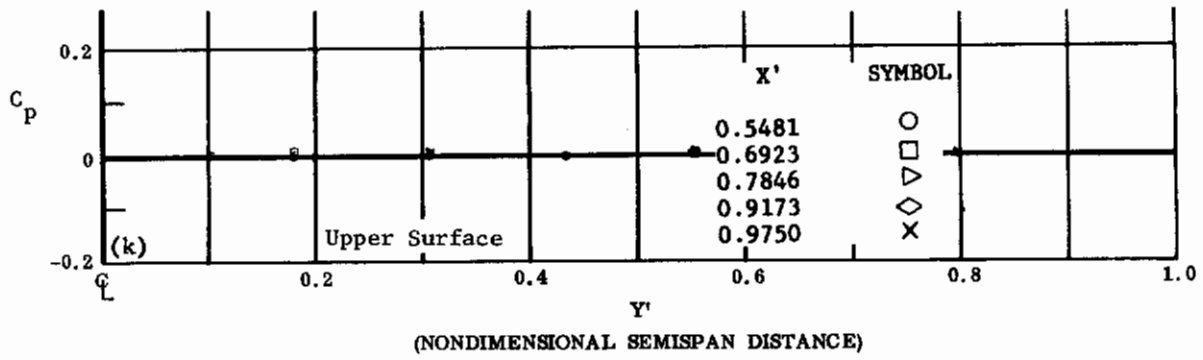

Fig. 37 Configuration IV, $\alpha = +40$, $\delta_2 = \delta_3 = +20$

k) C_p vs. Y' , upper surface

l) C_p vs. X' , upper surface

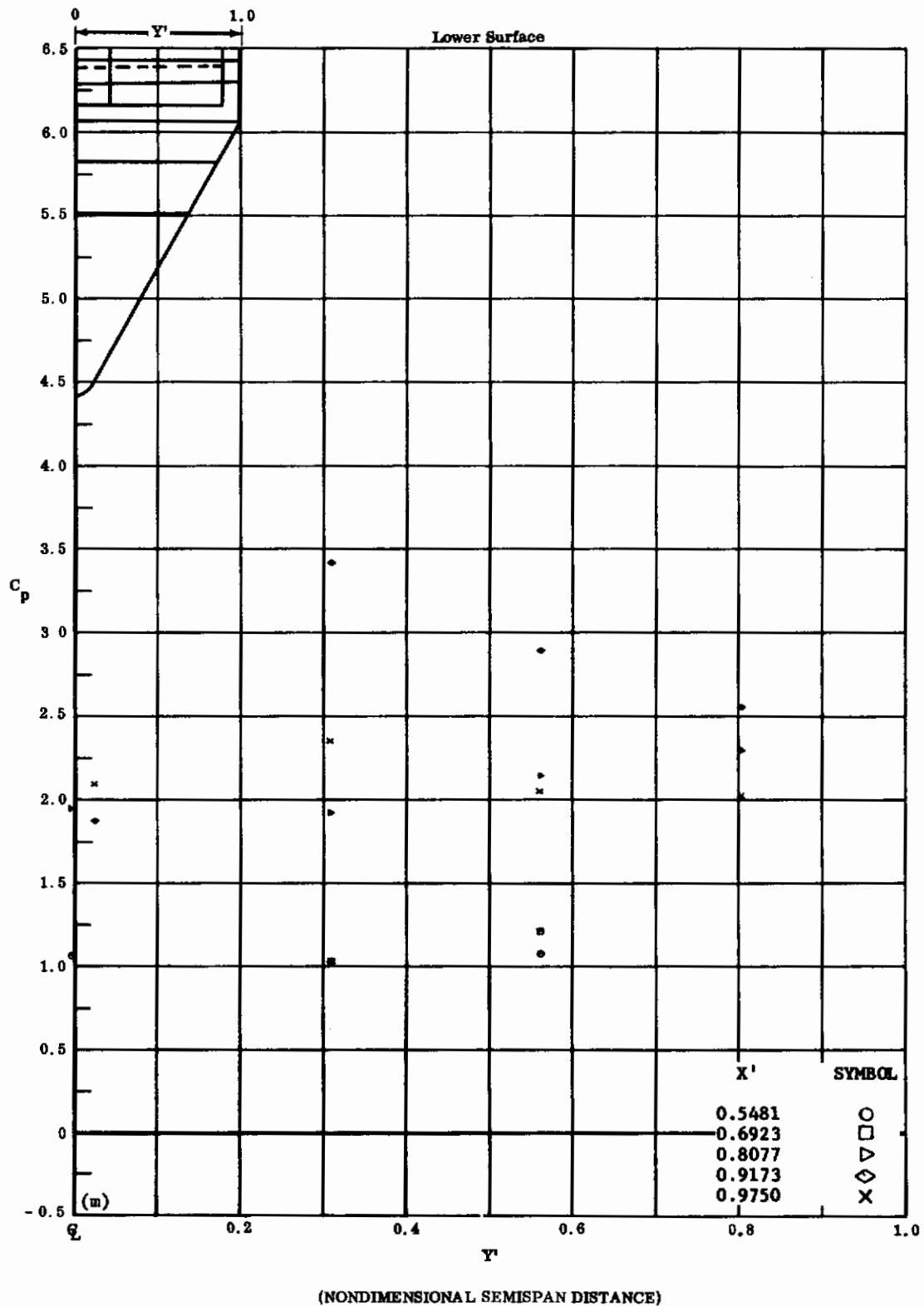
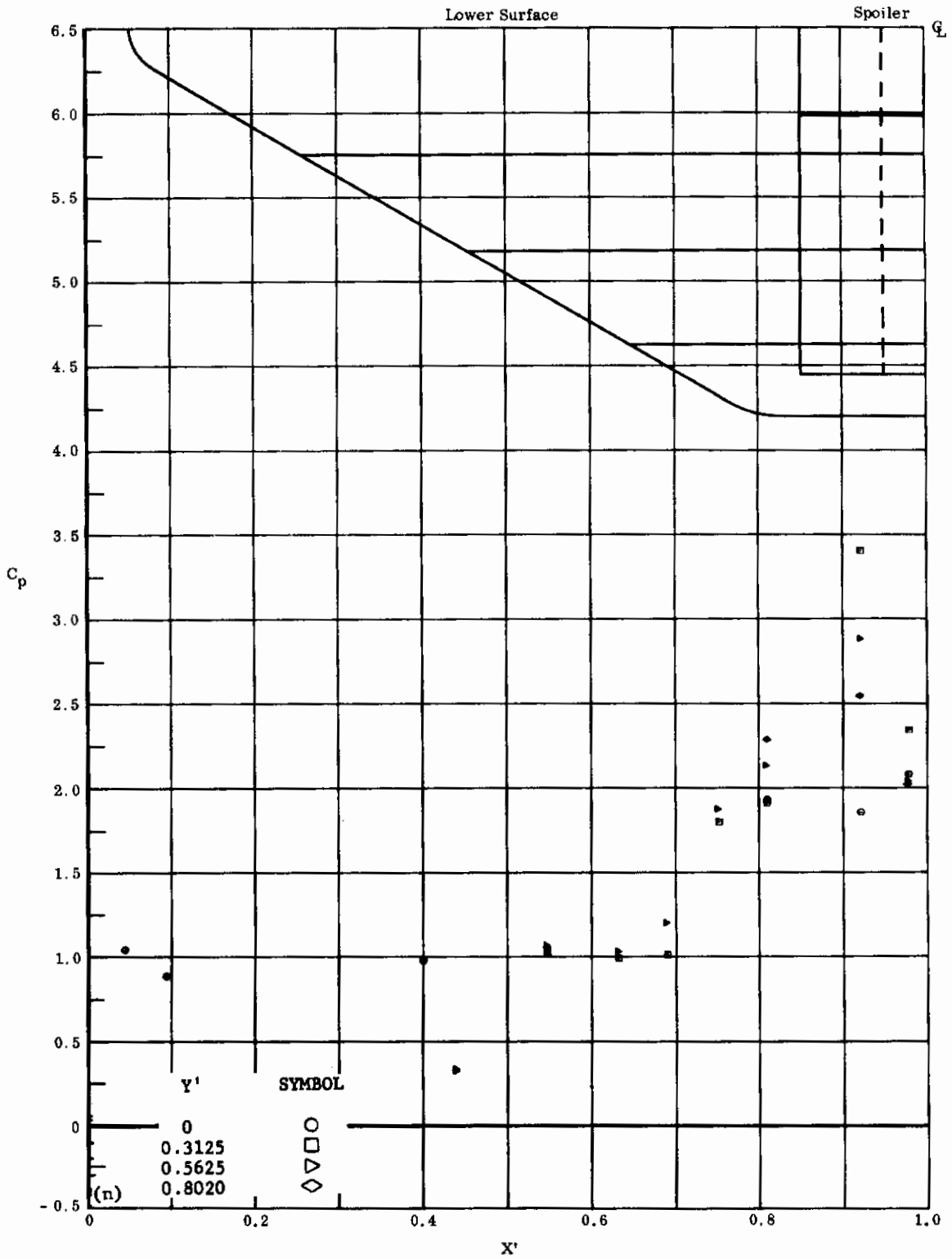

Fig. 37m Configuration IV, $\alpha = +40$, $\delta_2 = \delta_3 = +30$
 C_p vs. Y' , lower surface



(NONDIMENSIONAL STREAMWISE DISTANCE FROM VIRTUAL APEX)

Fig. 37n Configuration IV, $\alpha = +40$, $\delta_2 = \delta_3 = +30$

C_p vs. X' , lower surface

Contrails

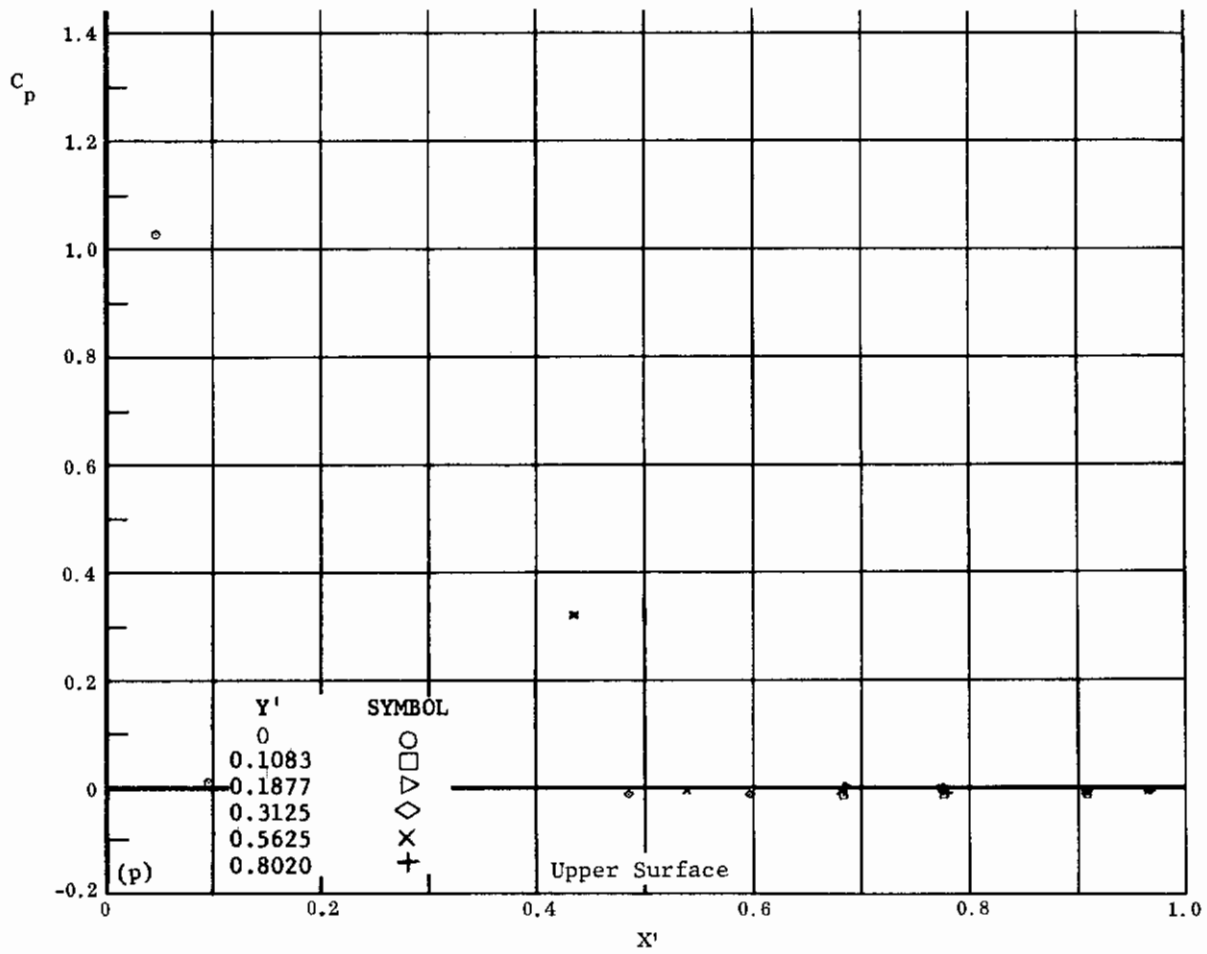
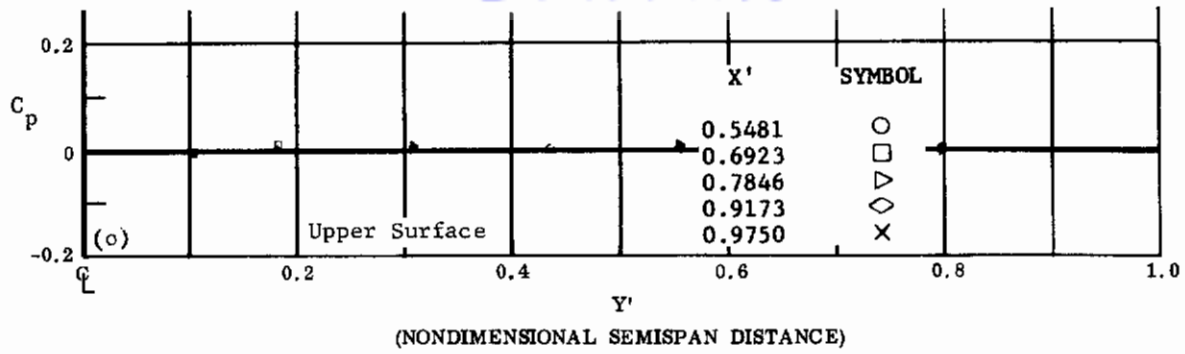

(NONDIMENSIONAL STREAMWISE DISTANCE FROM VIRTUAL APEX)

Fig. 37 Configuration IV, $\alpha = +40$, $\delta_2 = \delta_3 = +30$

o) C_p vs. Y' , upper surface

p) C_p vs. X' , upper surface

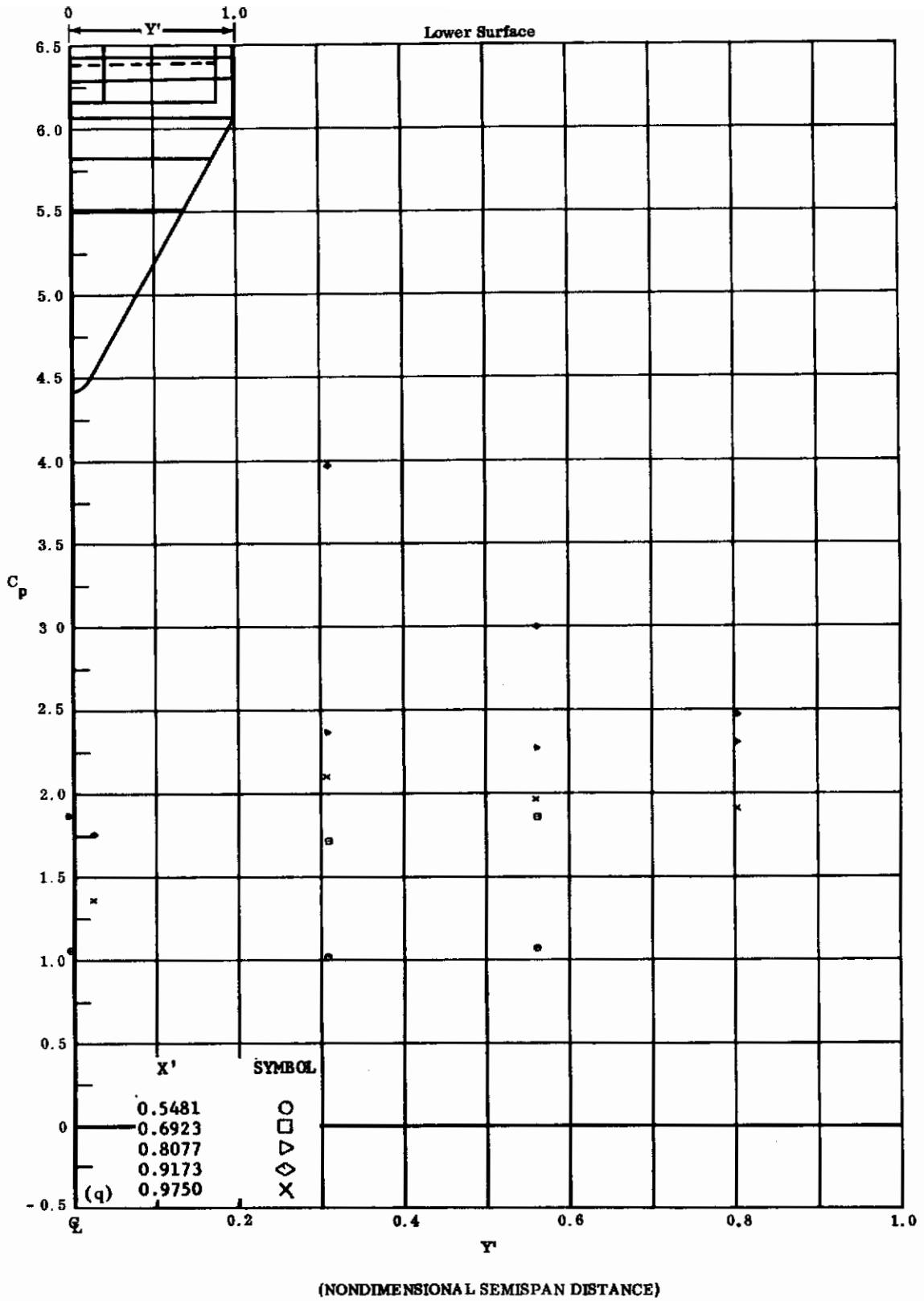
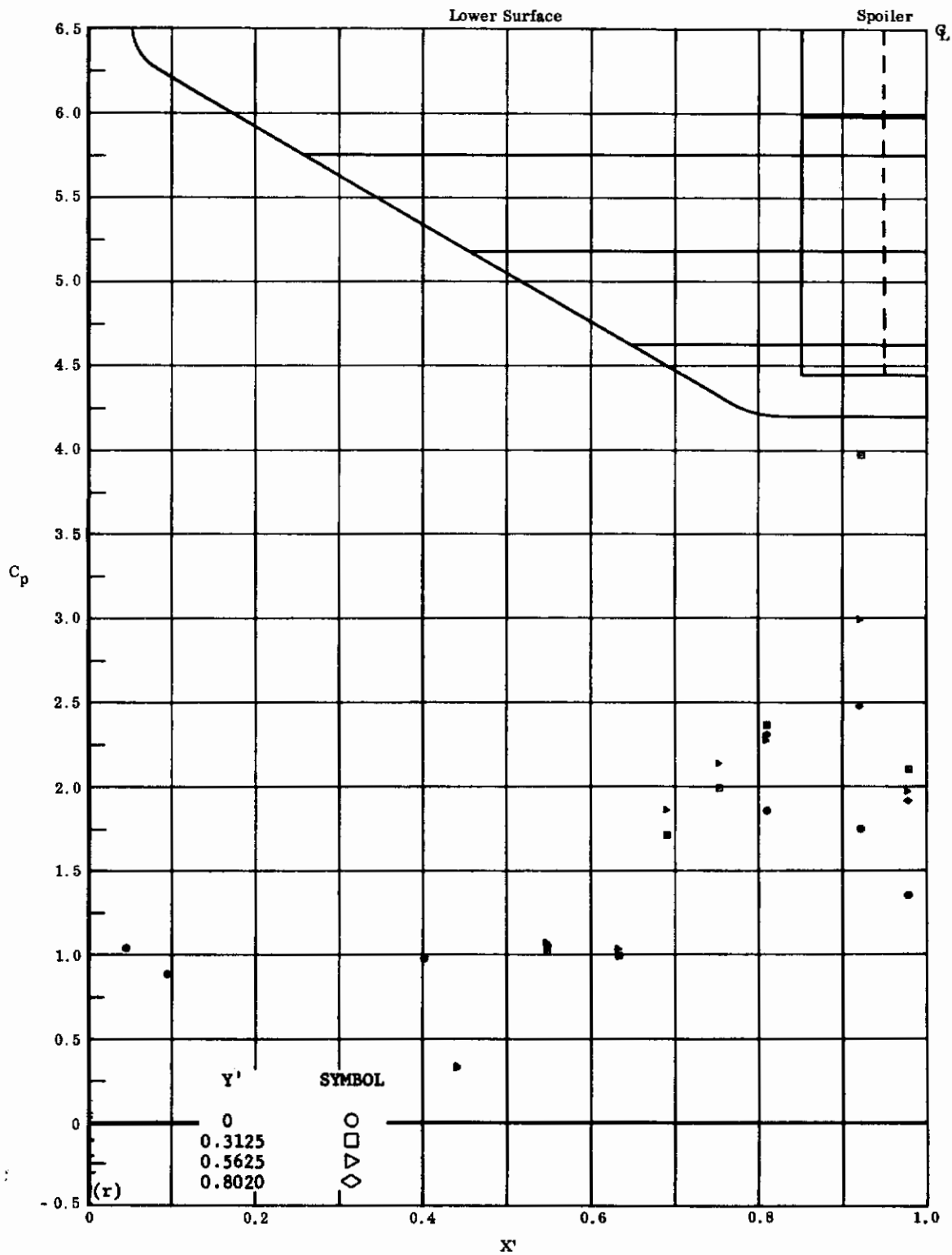

Fig. 37q Configuration IV, $\alpha = +40$, $\delta_2 = \delta_3 = +39$

C_p vs. Y' , lower surface



(NONDIMENSIONAL STREAMWISE DISTANCE FROM VIRTUAL APEX)

Fig. 37r Configuration IV, $\alpha = +40$, $\delta_2 = \delta_3 = +39$

C_p vs. X' , lower surface

Contrails

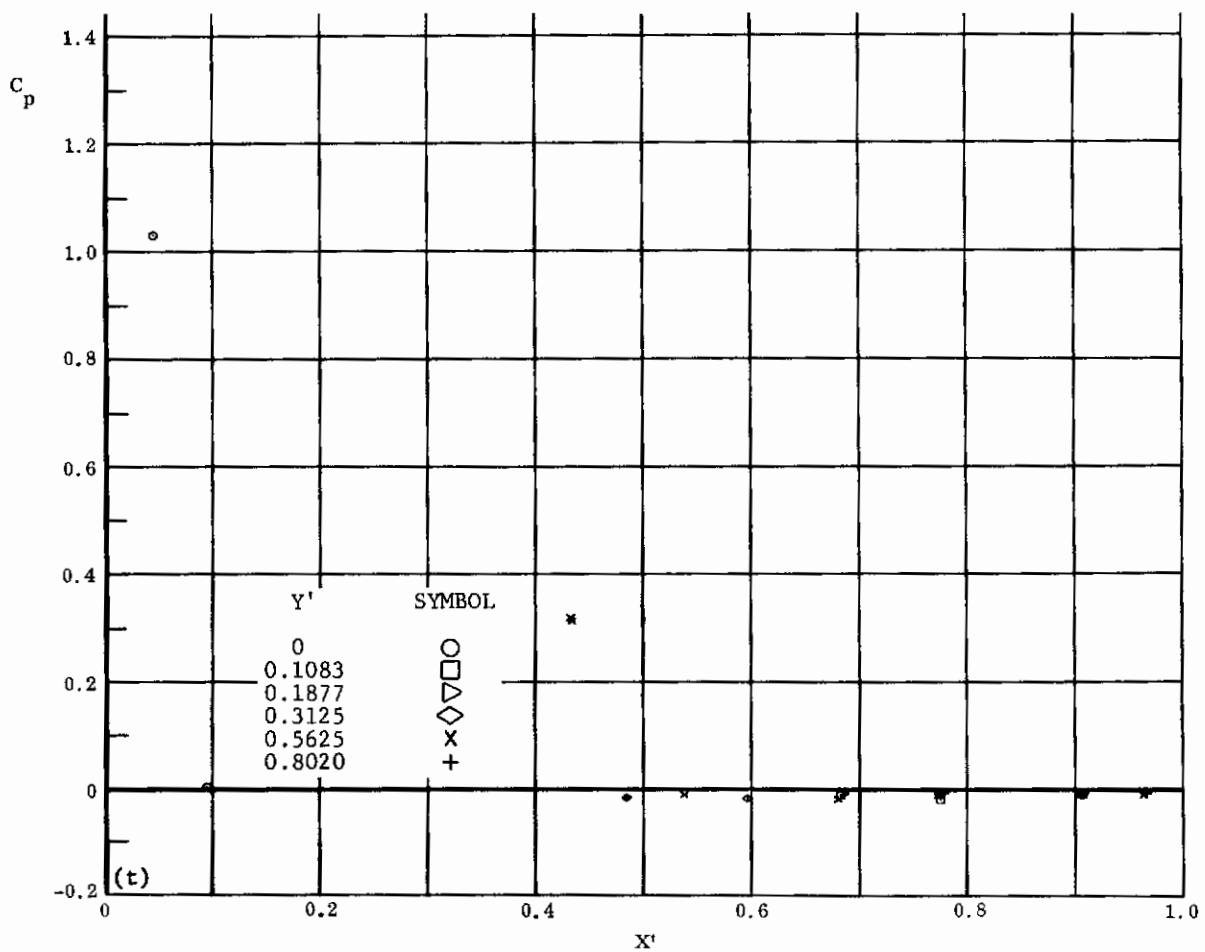
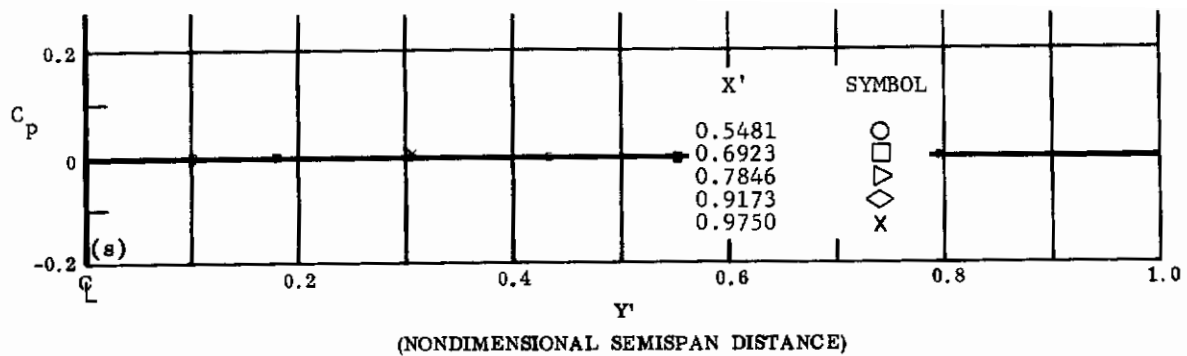

Fig. 37 Configuration IV, $\alpha = +40$, $\delta_2 = \delta_3 = +39$

s) C_p vs. Y' , upper surface

t) C_p vs. X' , upper surface

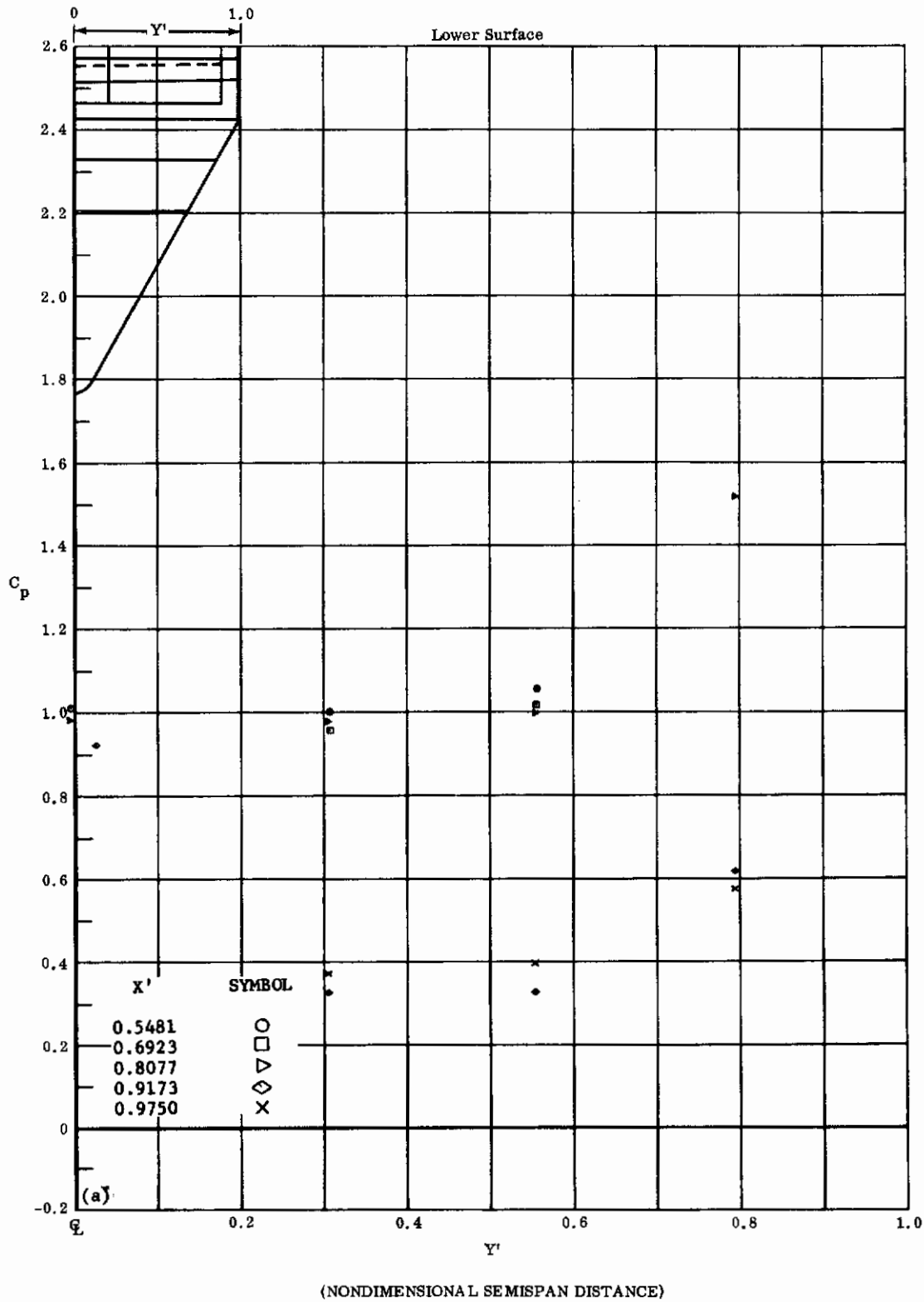
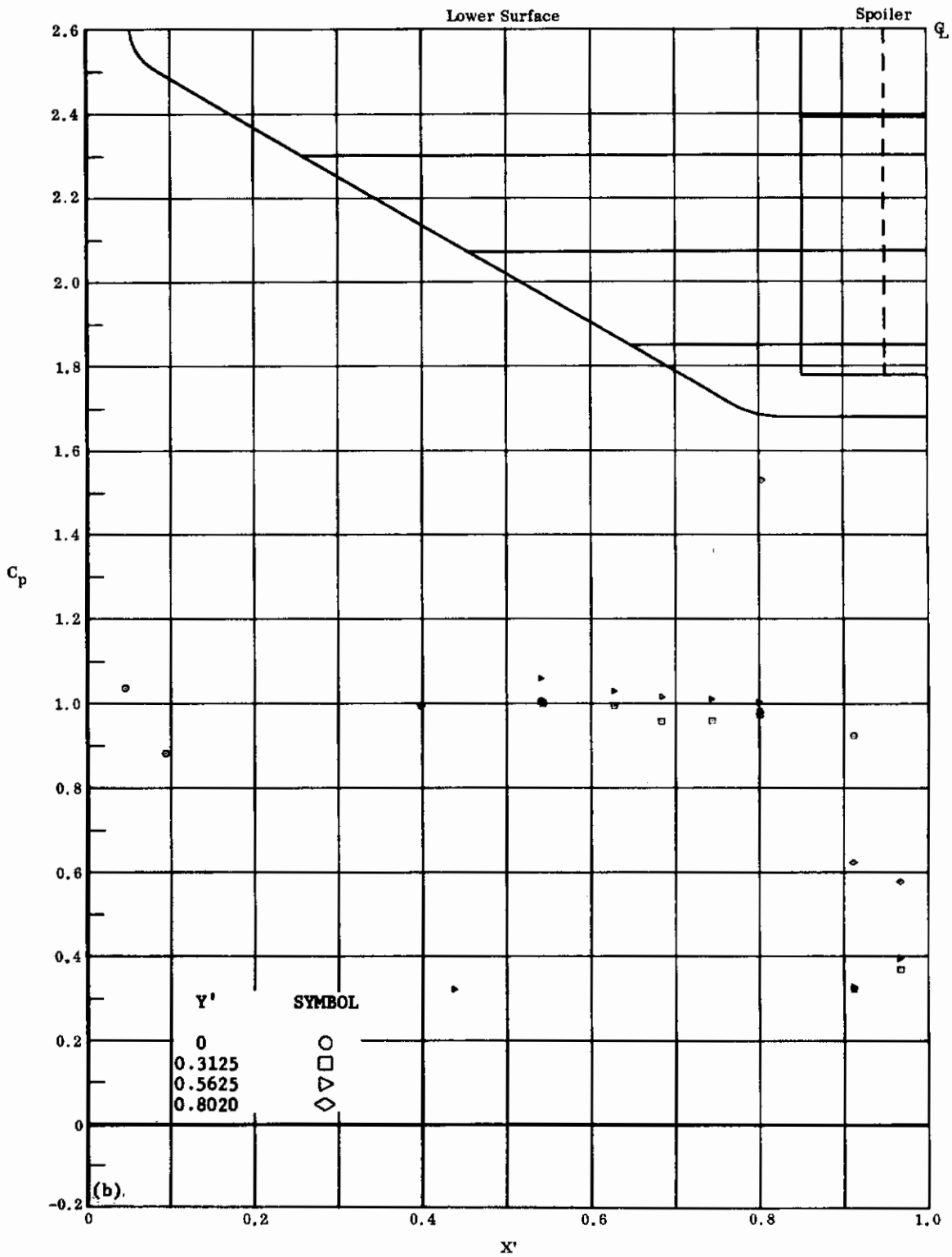

Fig. 38a Configuration IV, $\alpha = +40$, $\delta_2 = \delta_3 = -20$
 C_p vs. Y' , lower surface



(NONDIMENSIONAL STREAMWISE DISTANCE FROM VIRTUAL APEX)

Fig. 38b Configuration IV, $\alpha = +40$, $\delta_2 = \delta_3 = -20$

C_p vs. X' , lower surface

Contrails

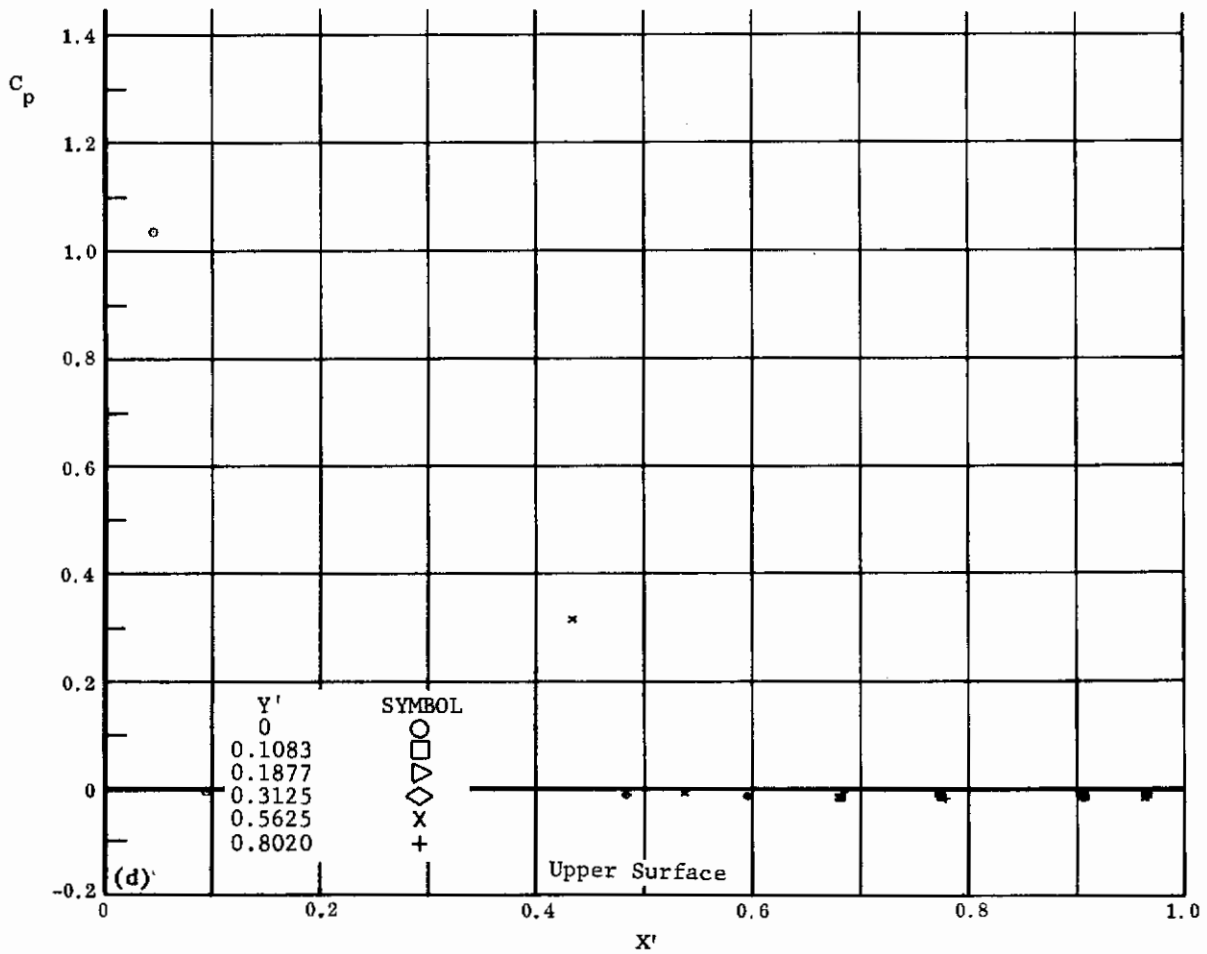
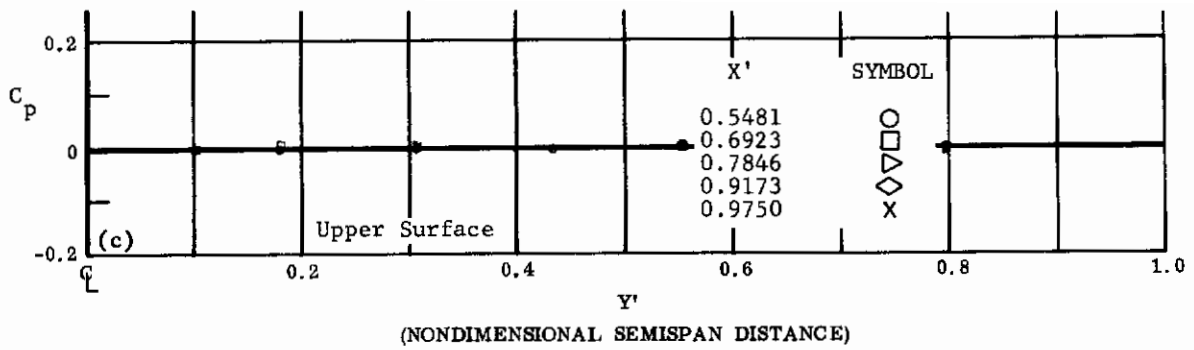

Fig. 38 Configuration IV, $\alpha = +40$, $\delta_2 = \delta_3 = -20$

c) C_p vs. Y' , upper surface

d) C_p vs. X' , upper surface

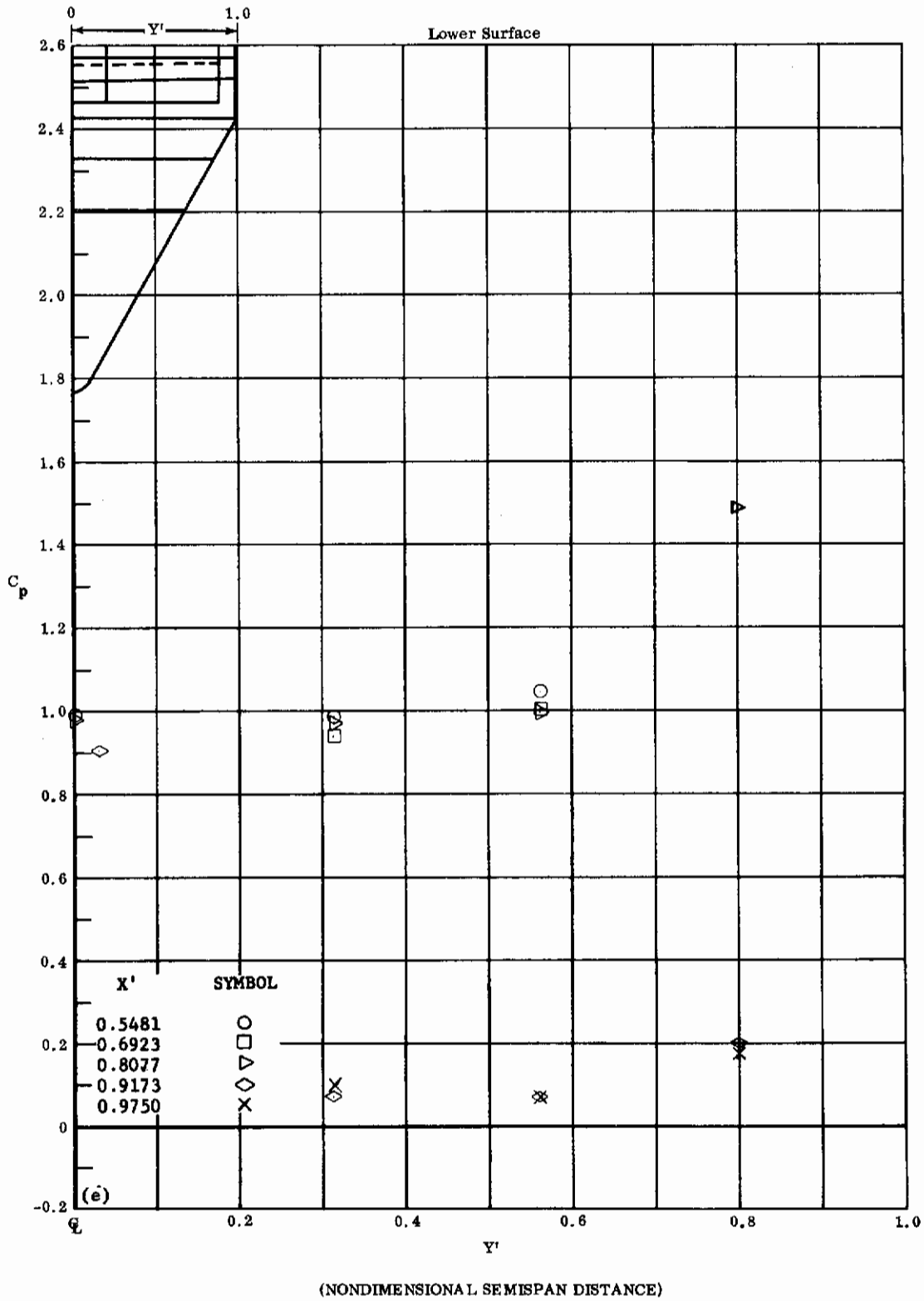
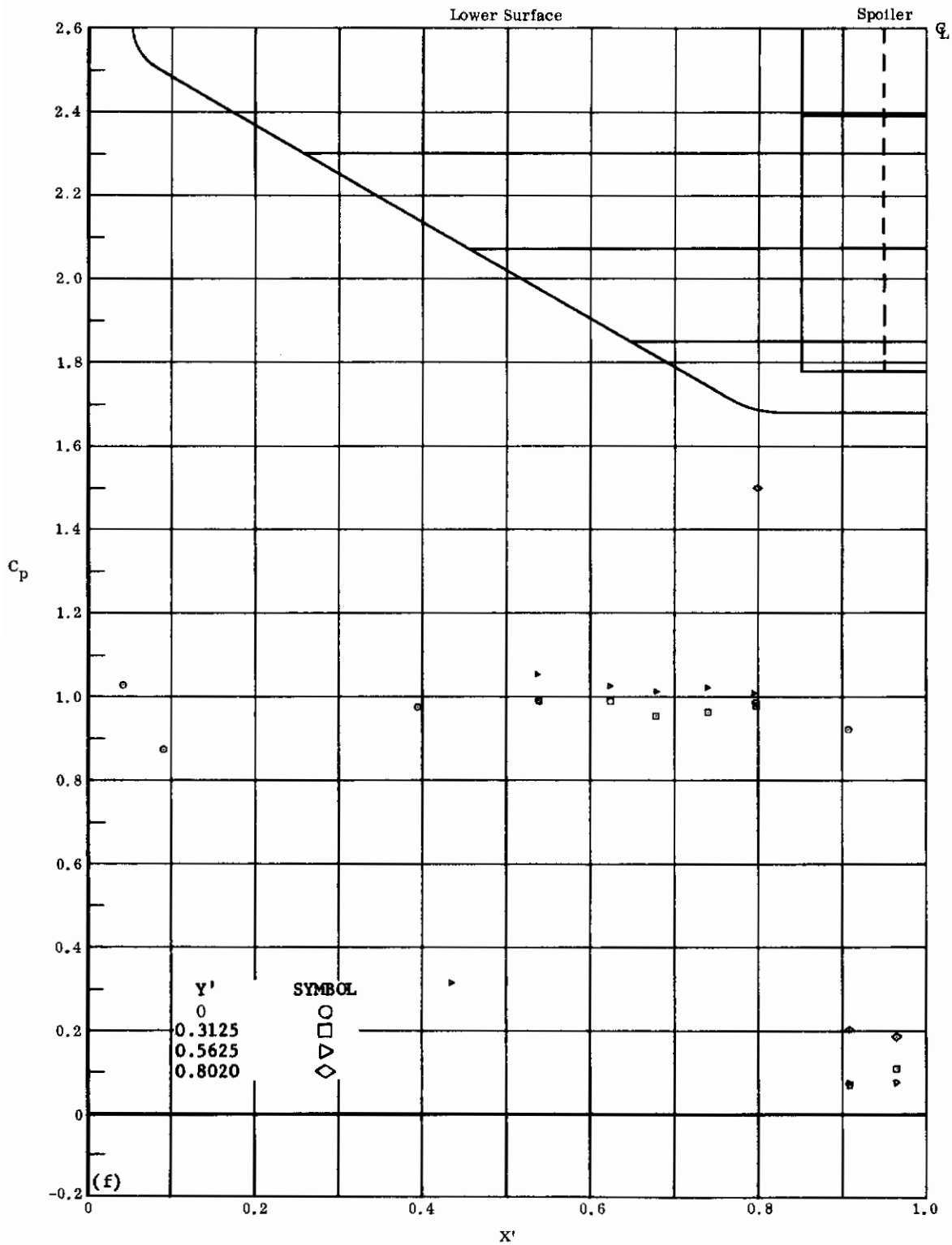

Fig. 38e Configuration IV, $\alpha = +40$, $\delta_2 = \delta_3 = -39$
 C_p vs. Y' , lower surface



(NONDIMENSIONAL STREAMWISE DISTANCE FROM VIRTUAL APEX)

Fig. 38f Configuration IV, $\alpha = +40$, $\delta_2 = \delta_3 = -39$

C_p vs. X' , lower surface

Contrails

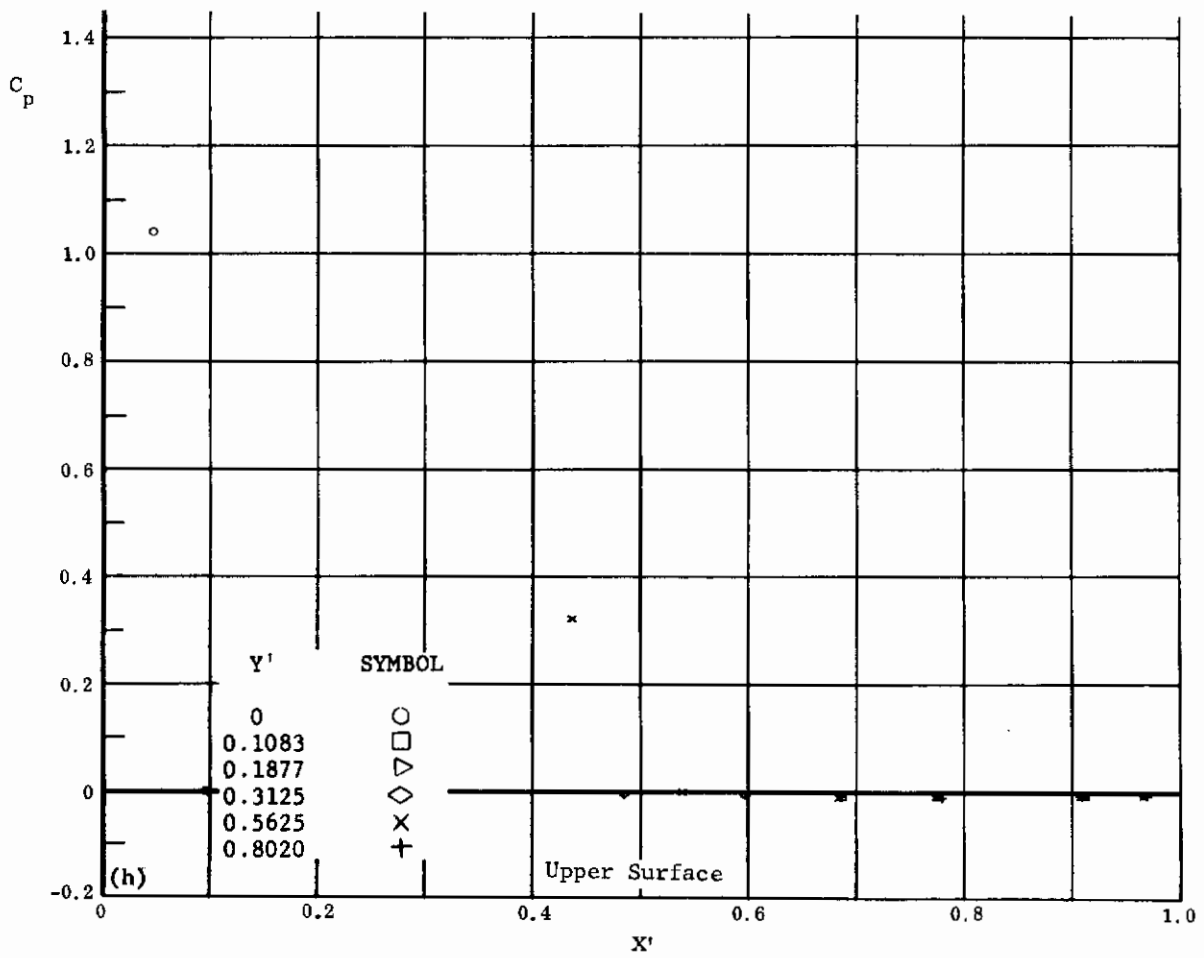
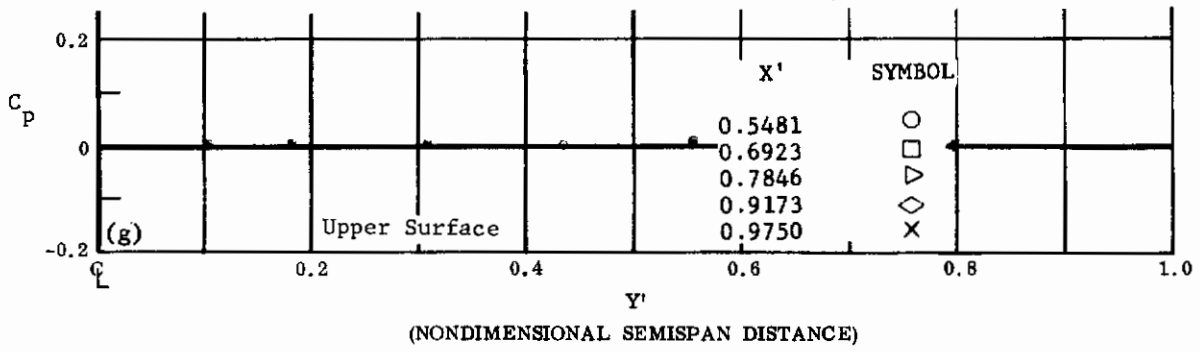

Fig. 38 Configuration IV, $\alpha = +40$, $\delta_2 = \delta_3 = -39$

g) C_p vs. Y' , upper surface

h) C_p vs. X' , upper surface

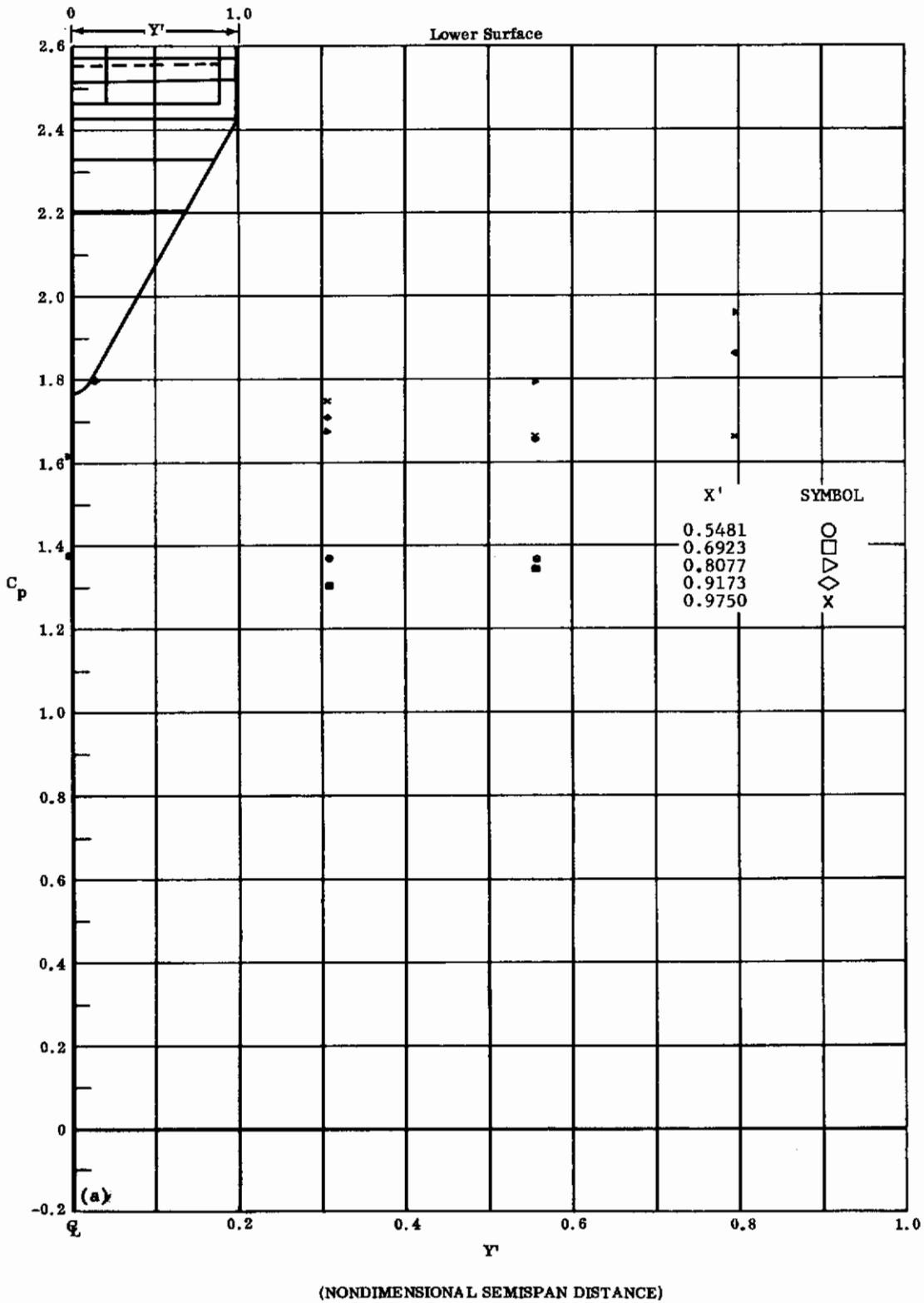
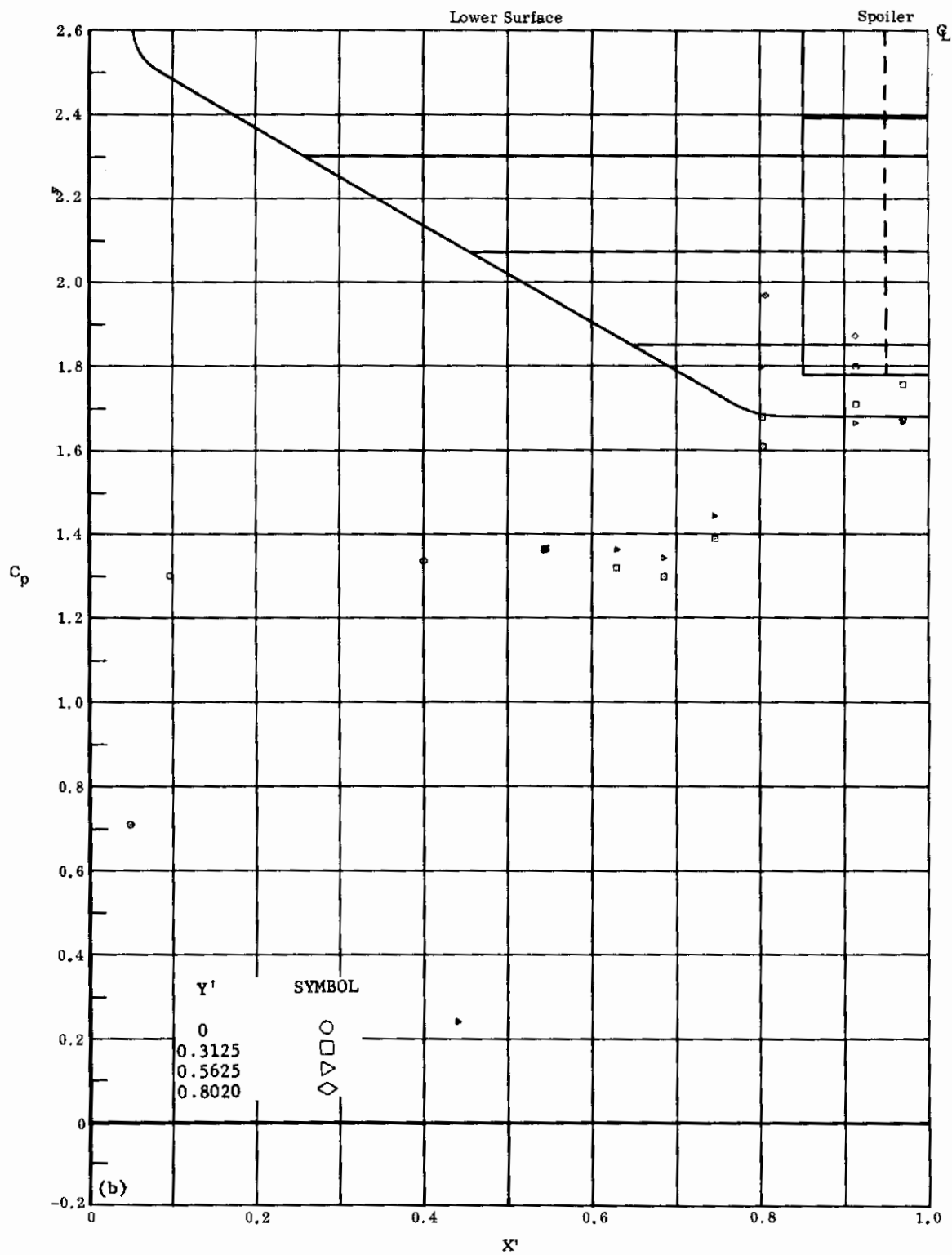

Fig. 39a Configuration IV, $\alpha = +50$, $\delta_2 = \delta_3 = 0$
 C_p vs. Y' , lower surface



(NONDIMENSIONAL STREAMWISE DISTANCE FROM VIRTUAL APEX)

Fig. 39b Configuration IV, $\alpha = +50$, $\delta_2 = \delta_3 = 0$

C_p vs. X' , lower surface

Contrails

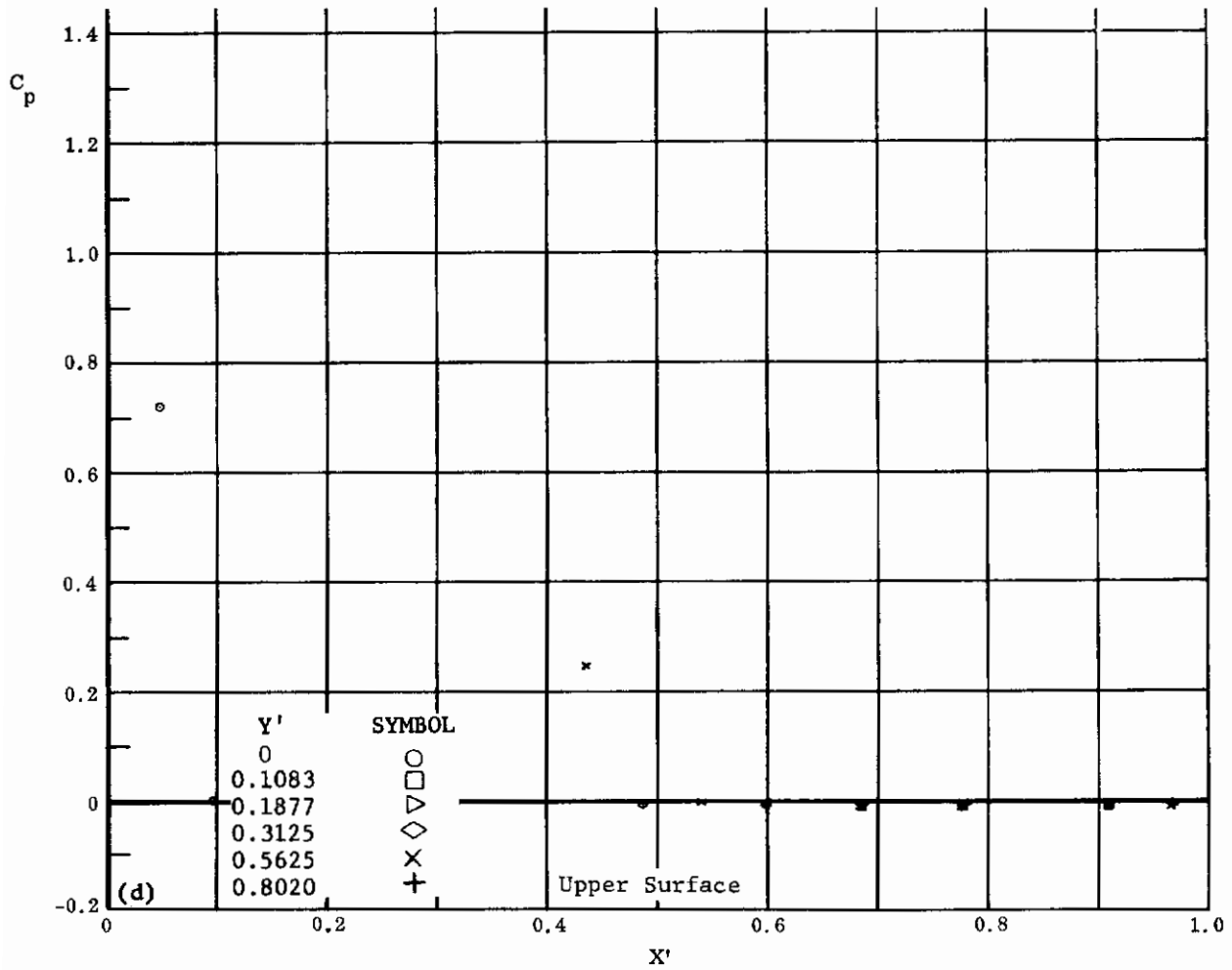
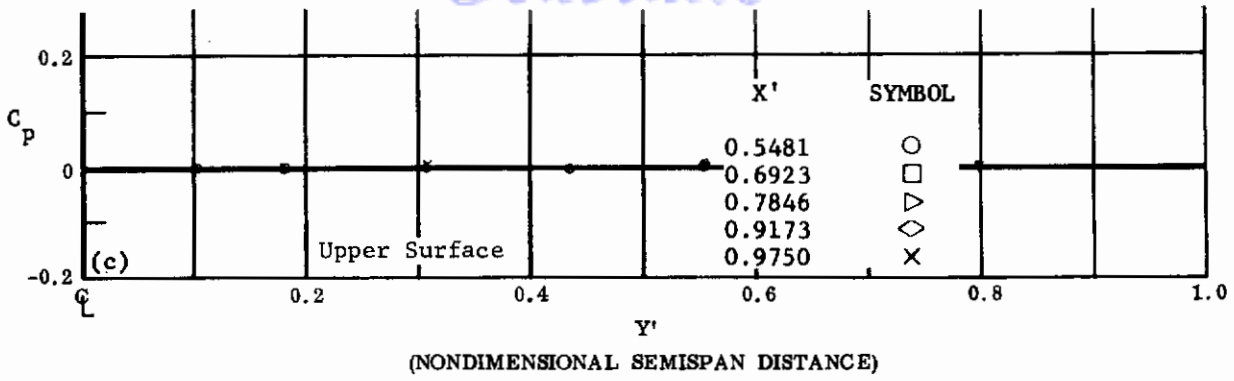

(NONDIMENSIONAL STREAMWISE DISTANCE FROM VIRTUAL APEX)

Fig. 39 Configuration IV, $\alpha = +50$, $\delta_2 = \delta_3 = 0$

c) C_p vs. Y' , upper surface

d) C_p vs. X' , upper surface

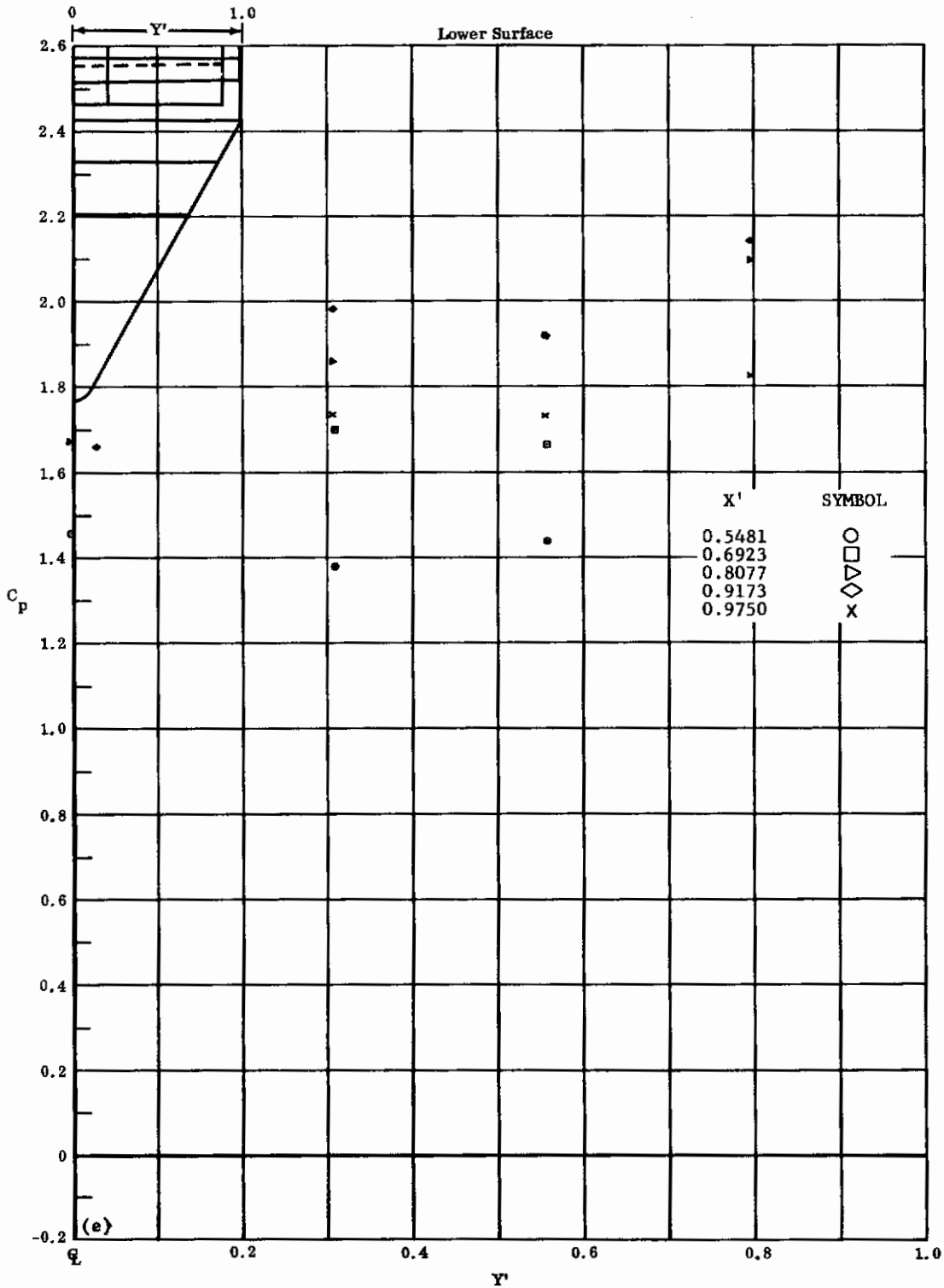

(NONDIMENSIONAL SEMISPAN DISTANCE)

Fig. 39e Configuration IV, $\alpha = +50$, $\delta_2 = \delta_3 = +20$

C_p vs. Y' , lower surface

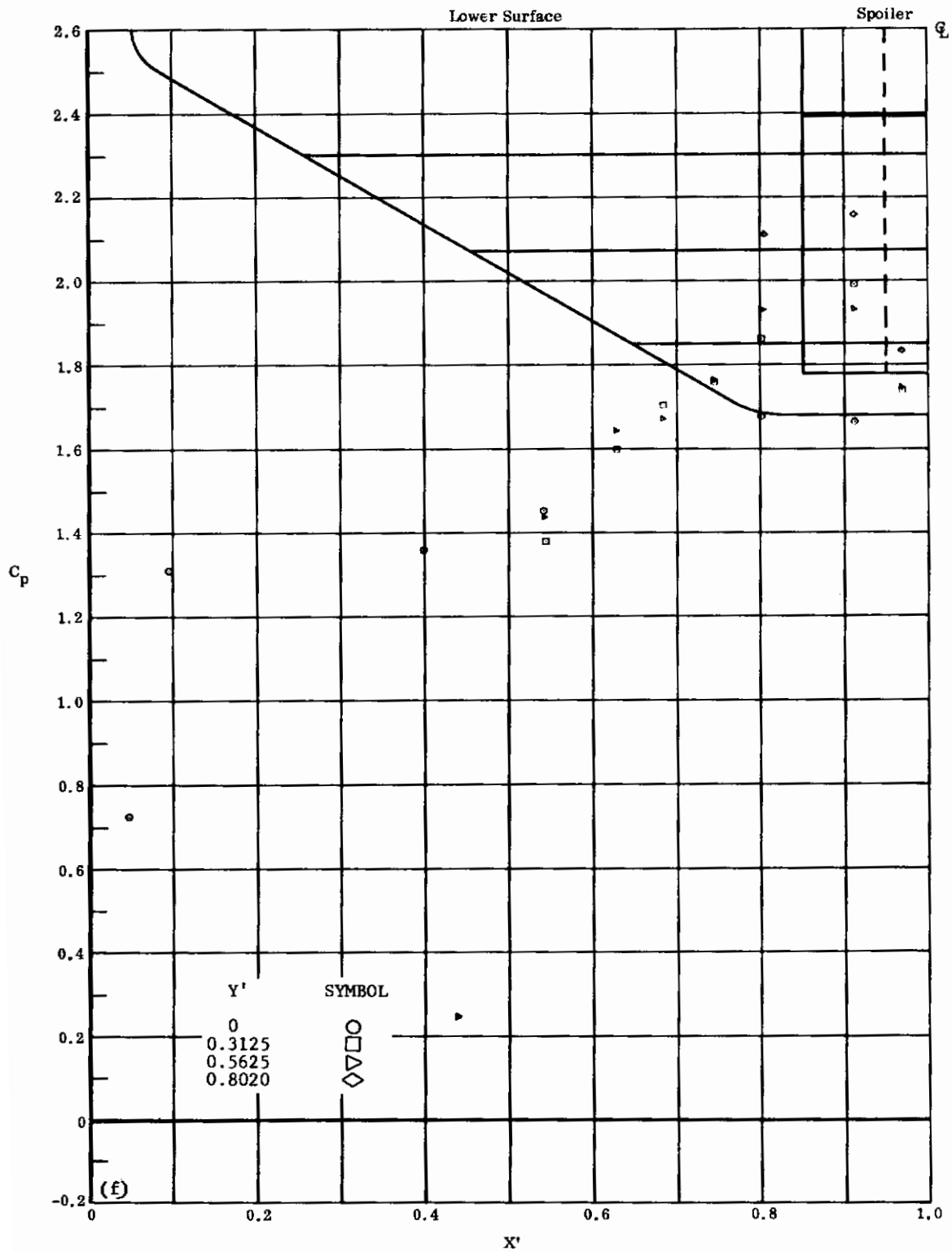

(NONDIMENSIONAL STREAMWISE DISTANCE FROM VIRTUAL APEX)

Fig. 39f Configuration IV, $\alpha = +50$, $\delta_2 = \delta_3 = +20$

C_p vs. X' , lower surface

Contrails

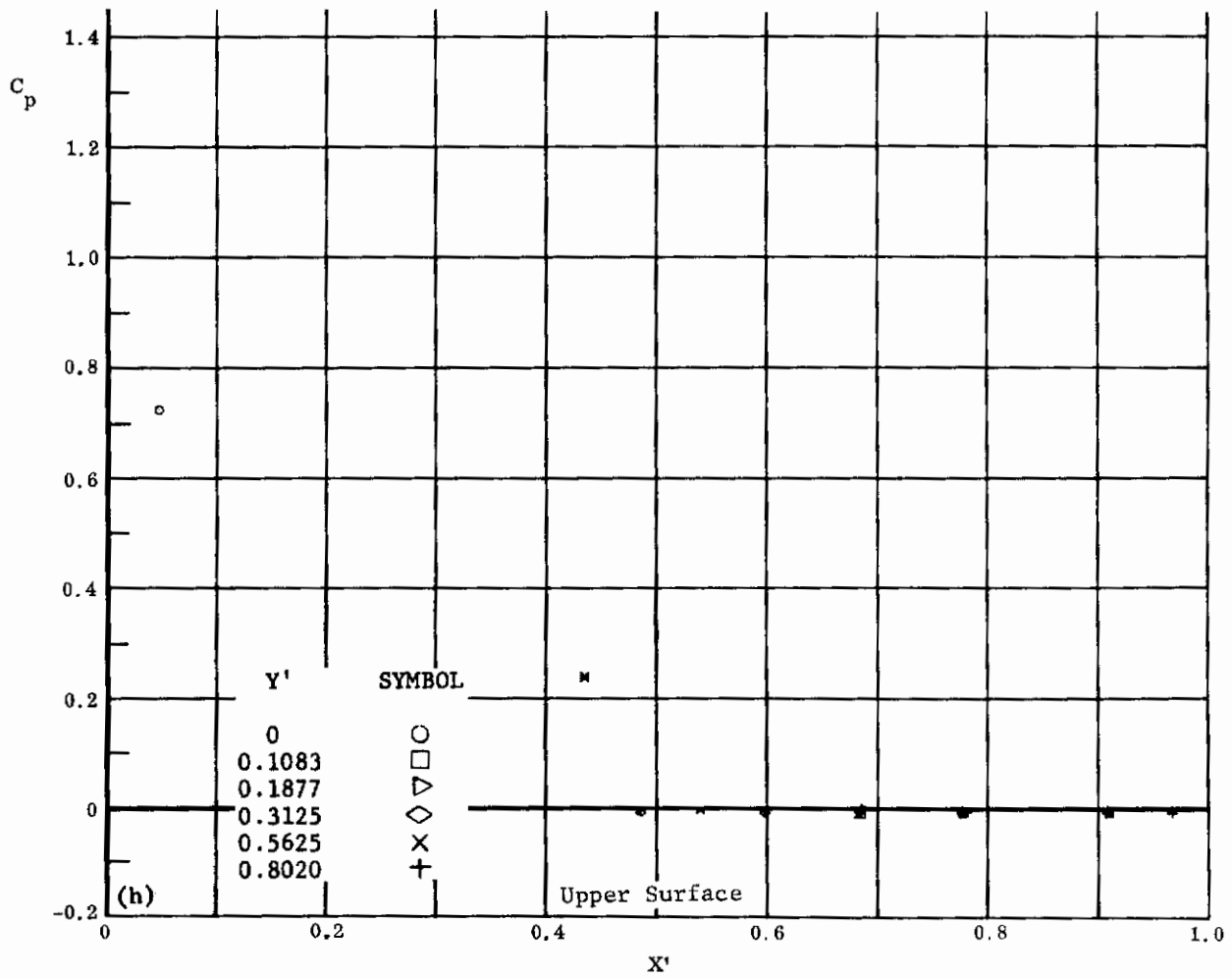
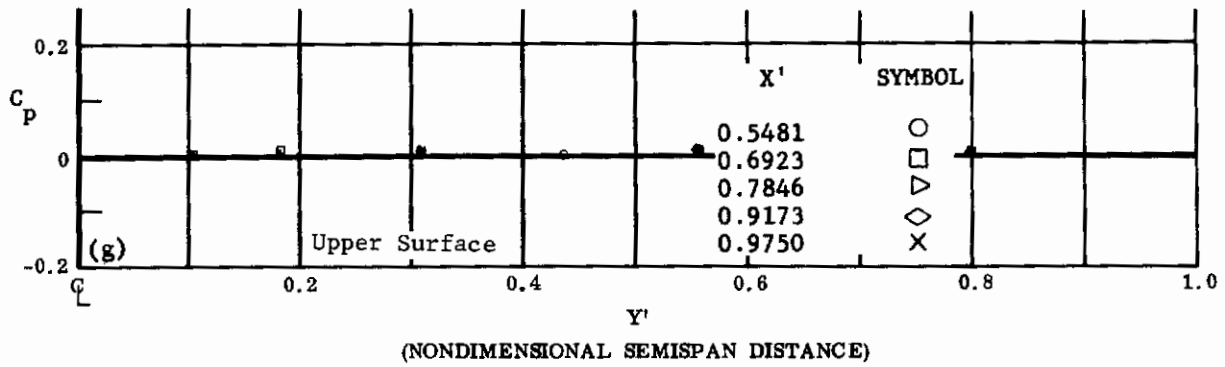

(NONDIMENSIONAL STREAMWISE DISTANCE FROM VIRTUAL APEX)

Fig. 39 Configuration IV, $\alpha = +50$, $\delta_2 = \delta_3 = +20$

g) C_p vs. Y' , upper surface

h) C_p vs. X' , upper surface

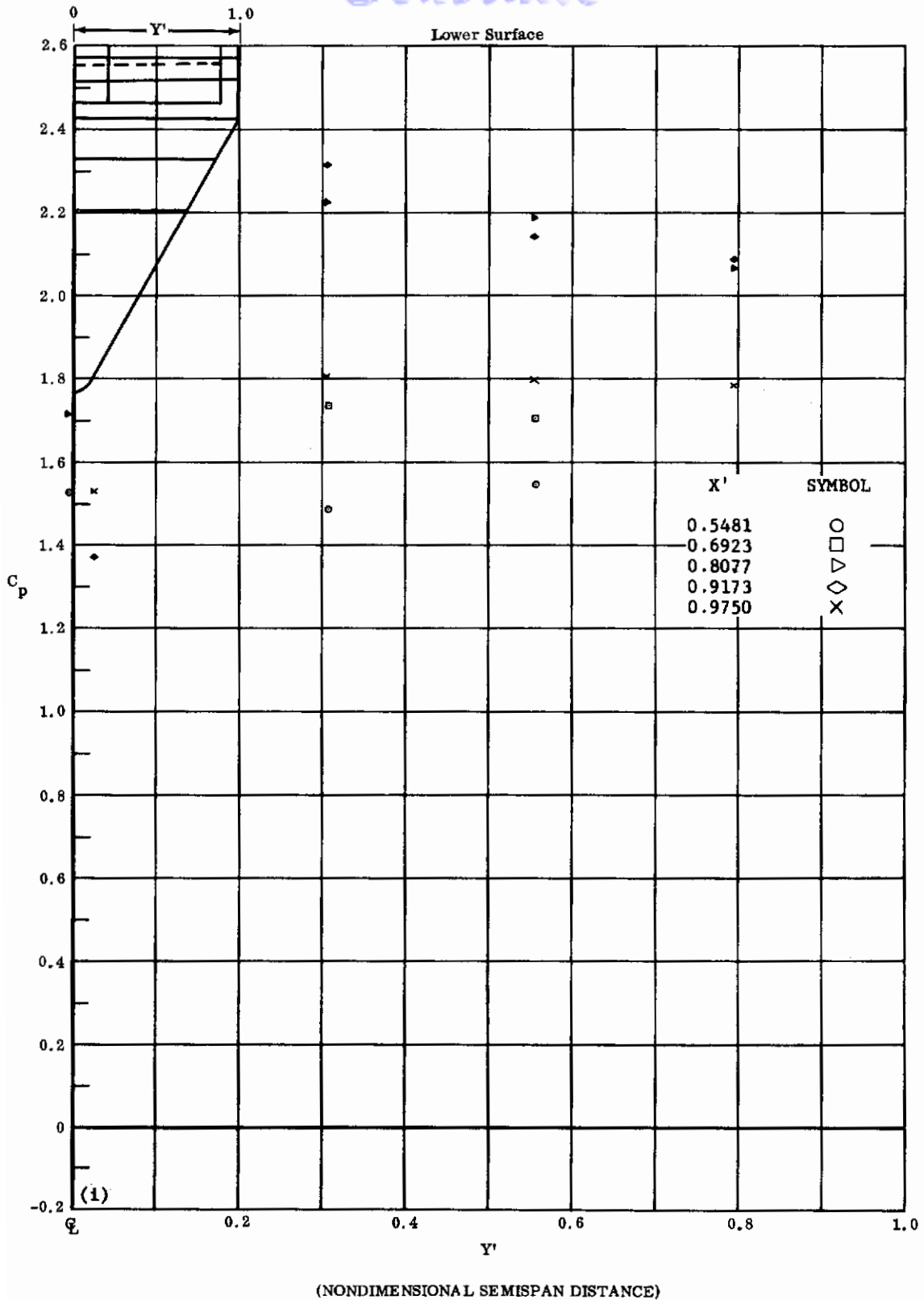
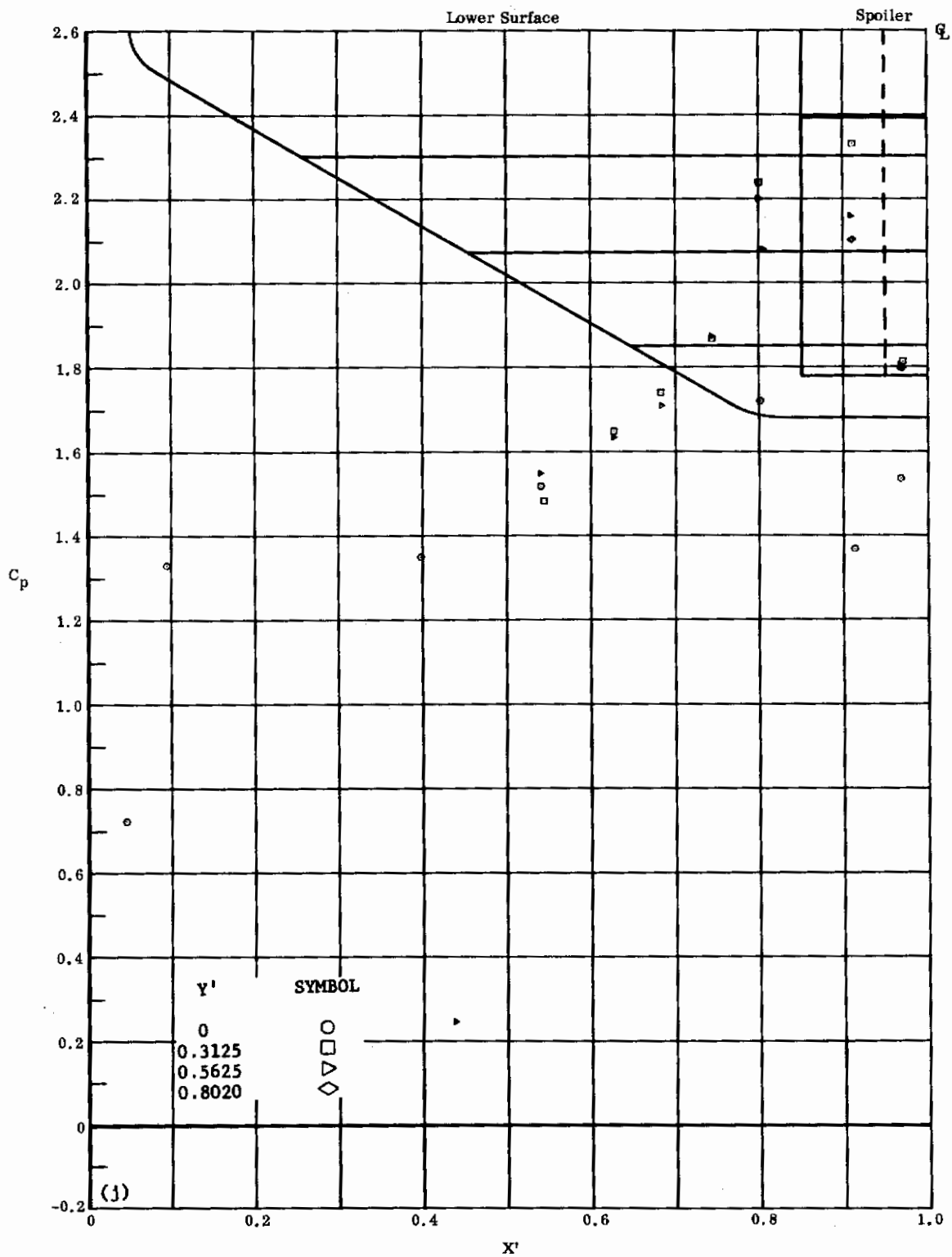

Fig. 391 Configuration IV, $\alpha = +50$, $\delta_2 = \delta_3 = +39$

C_p vs. Y' , lower surface



(NONDIMENSIONAL STREAMWISE DISTANCE FROM VIRTUAL APEX)

Fig. 39j Configuration IV, $\alpha = +50$, $\delta_2 = \delta_3 = +39$

C_p vs. X' , lower surface

Contrails

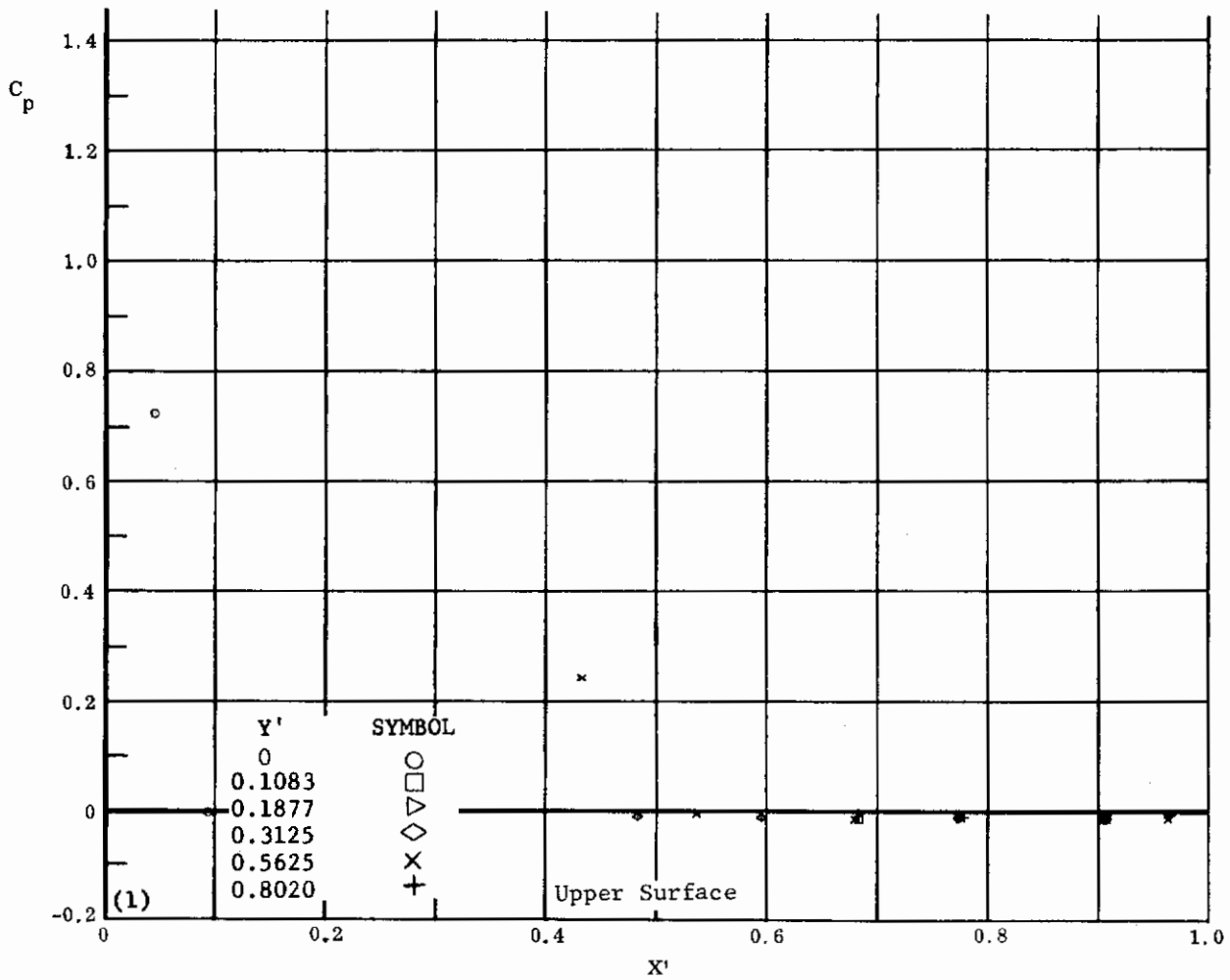
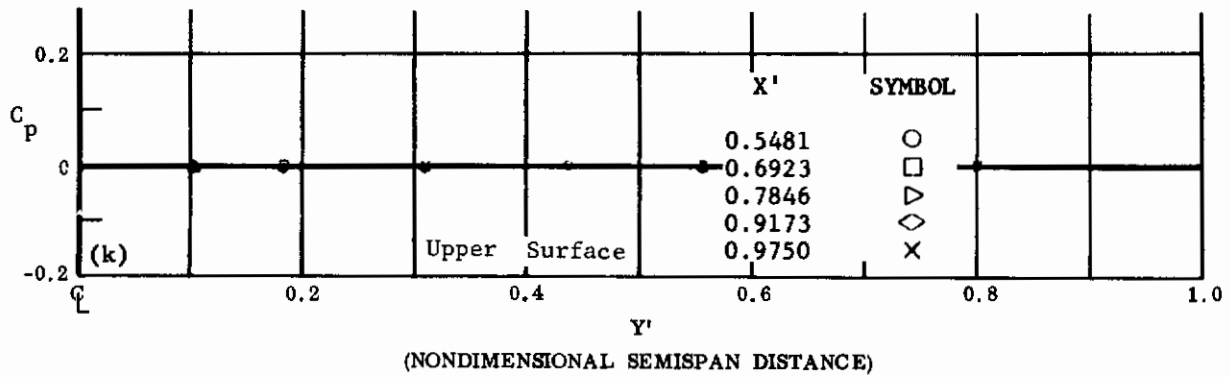

(NONDIMENSIONAL STREAMWISE DISTANCE FROM VIRTUAL APEX)

Fig. 39 Configuration IV, $\alpha = +50$, $\delta_2 = \delta_3 = +39$

k) C_p vs. Y' , upper surface

l) C_p vs. X' , upper surface

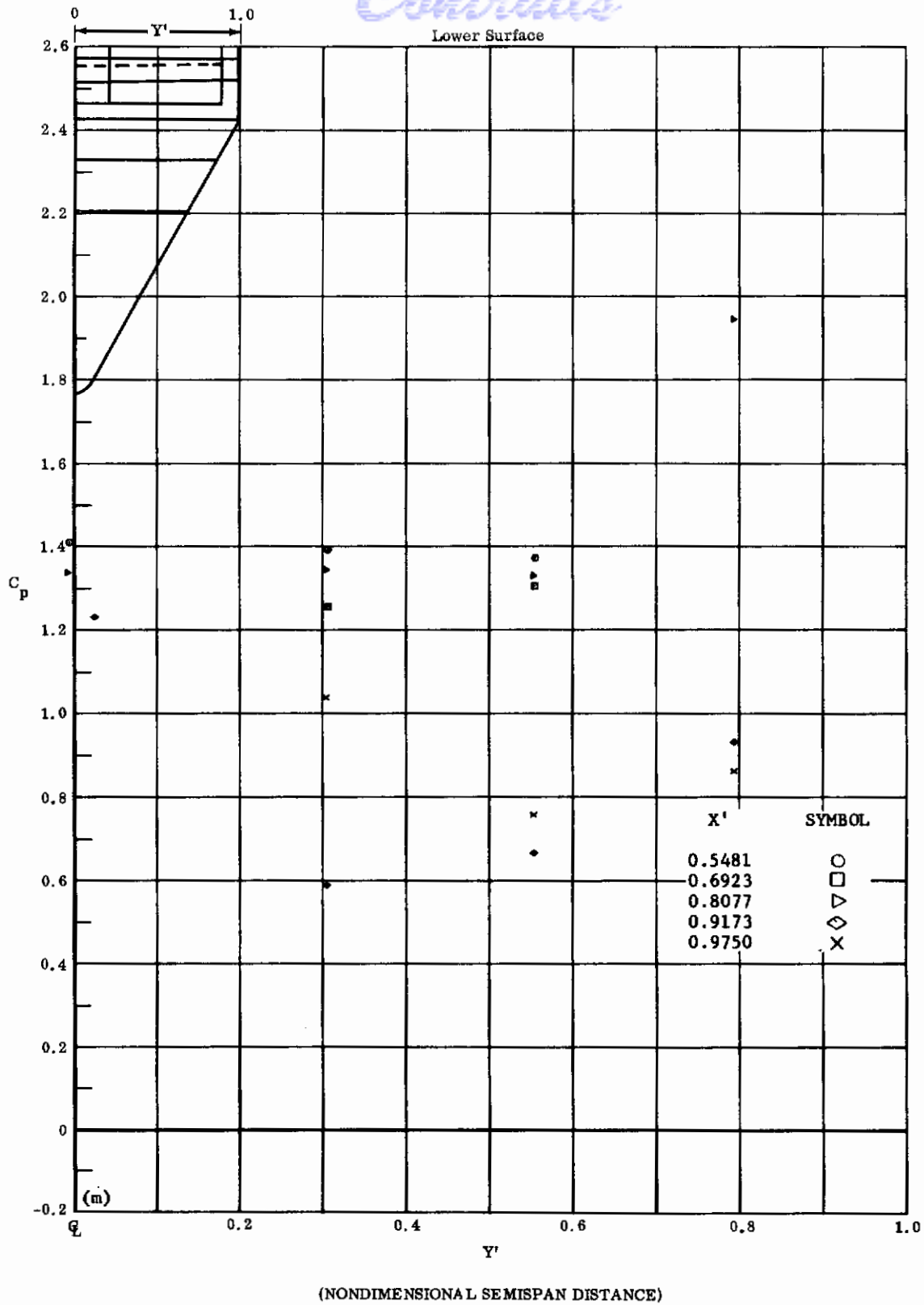
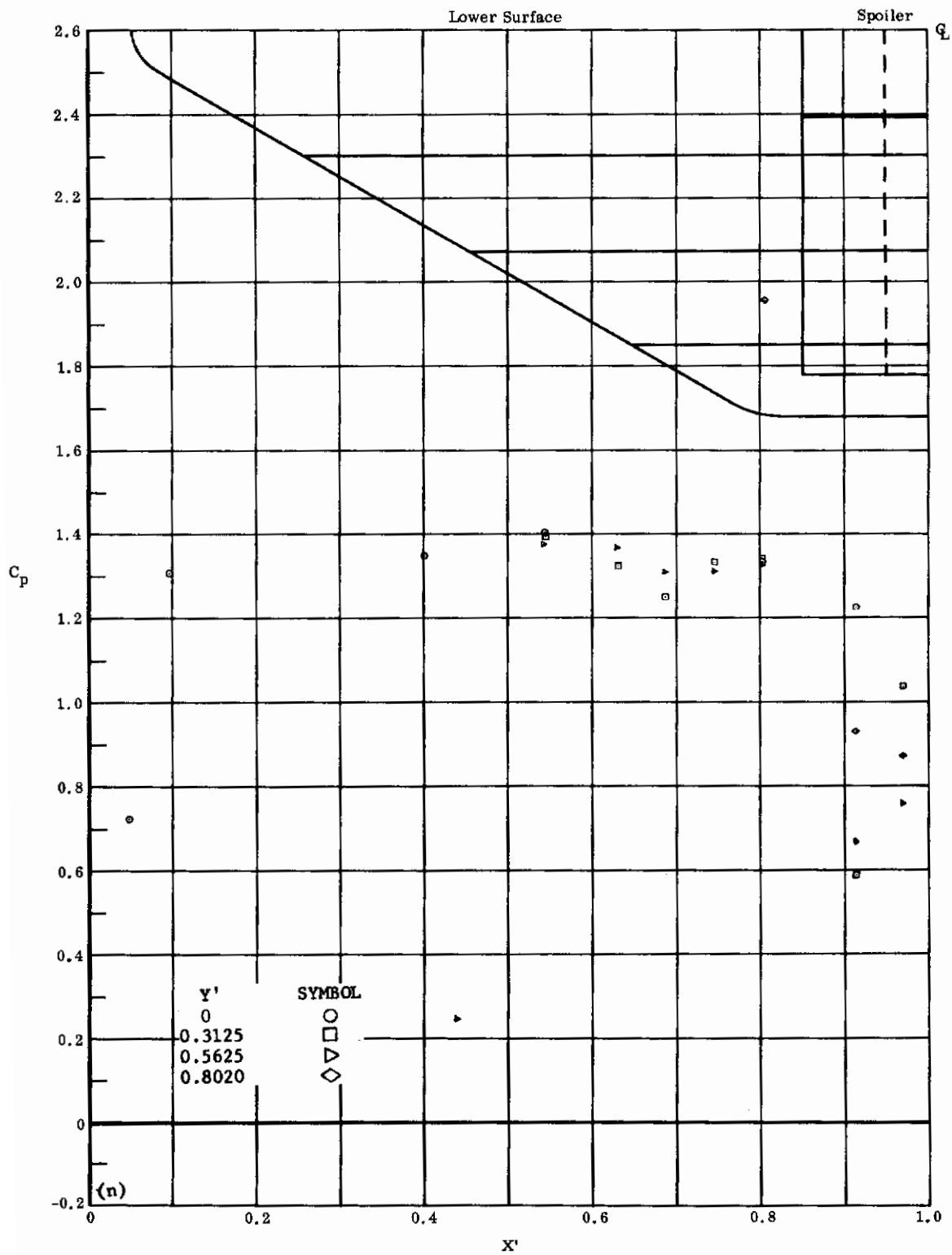

Fig. 39m Configuration IV, $\alpha = +50$, $\delta_2 = \delta_3 = -20$

C_p vs. Y' , lower surface



(NONDIMENSIONAL STREAMWISE DISTANCE FROM VIRTUAL APEX)

Fig. 39n Configuration IV, $\alpha = +50$, $\delta_2 = \delta_3 = -20$

C_p vs. X' , lower surface

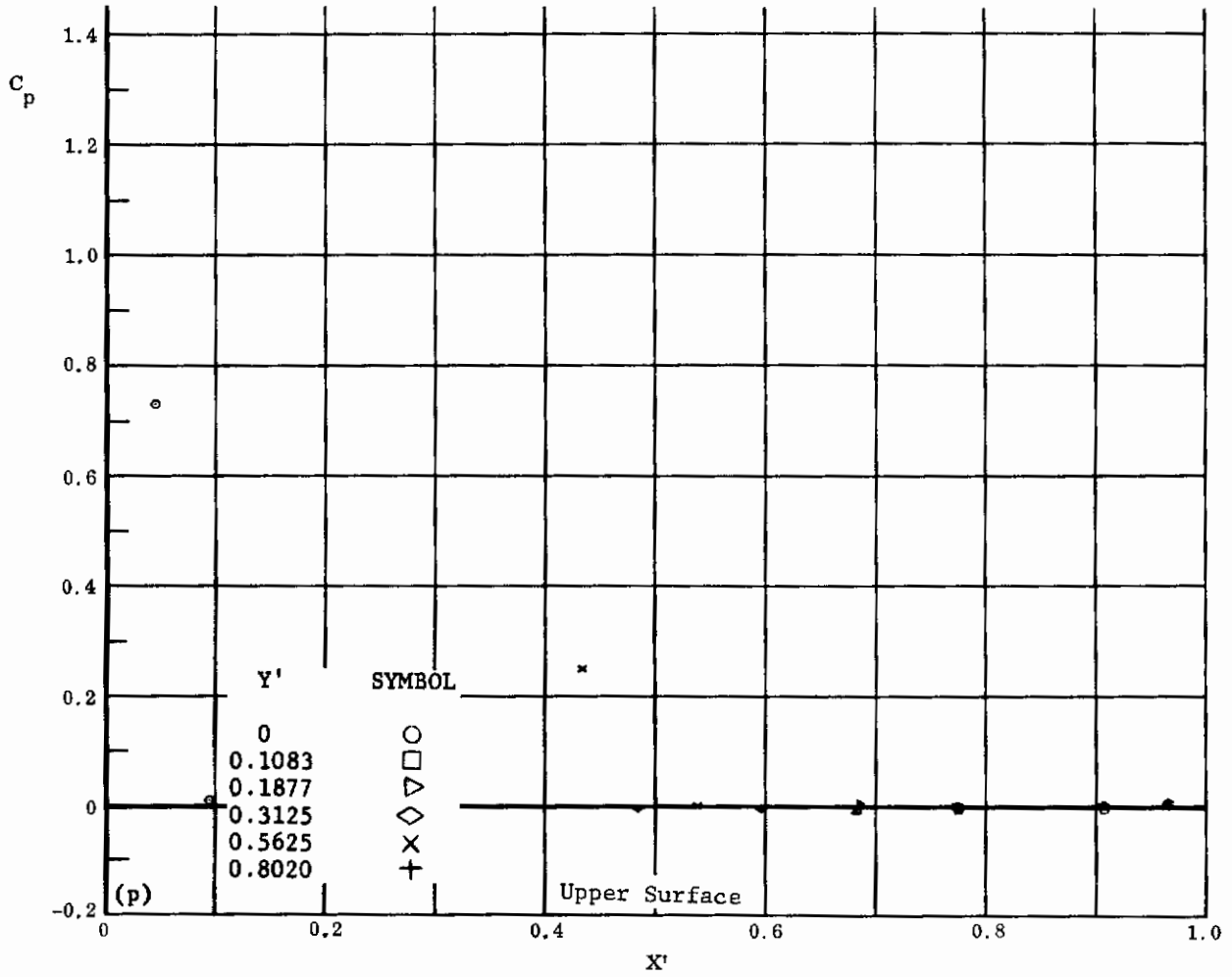
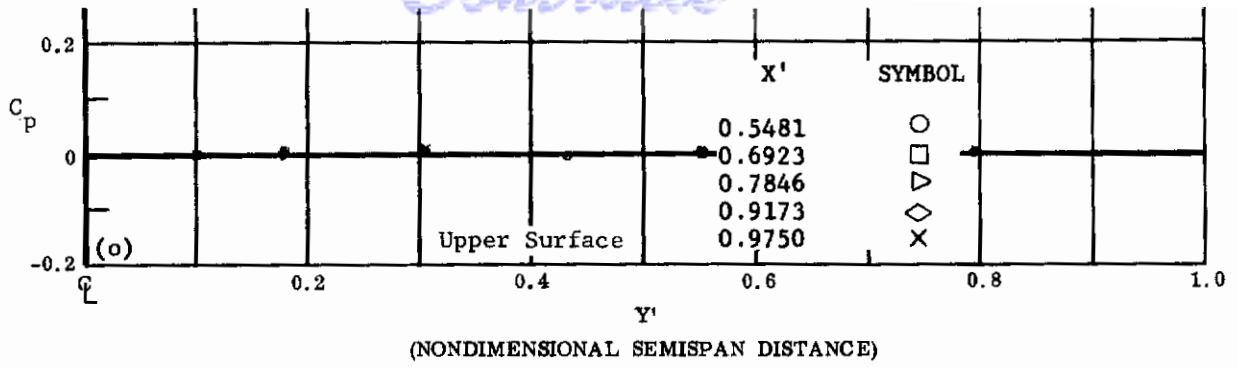

(NONDIMENSIONAL STREAMWISE DISTANCE FROM VIRTUAL APEX)

Fig. 39 Configuration IV, $\alpha = +50$, $\delta_2 = \delta_3 = -20$

o) C_p vs. Y' , upper surface

p) C_p vs. X' , upper surface

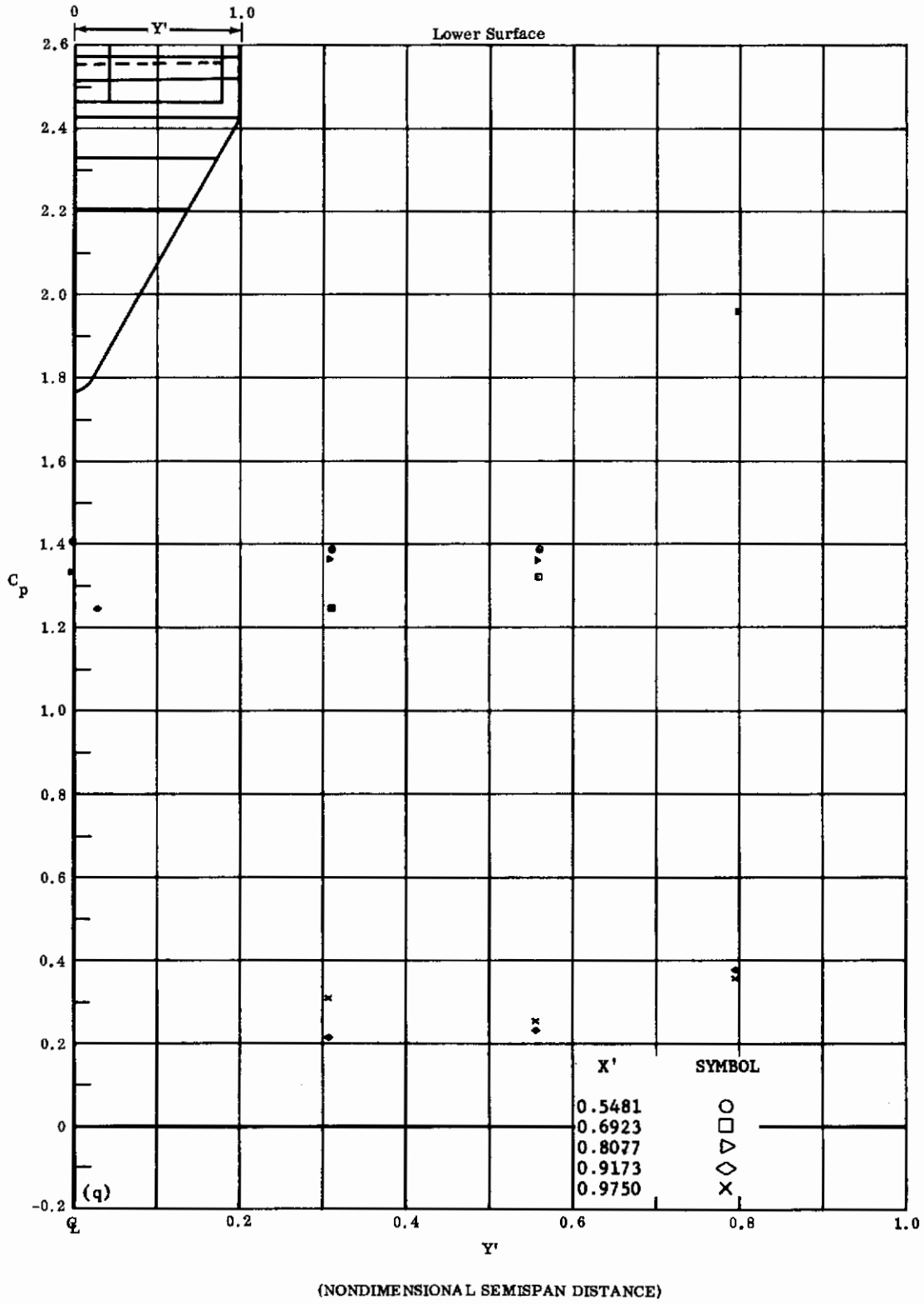
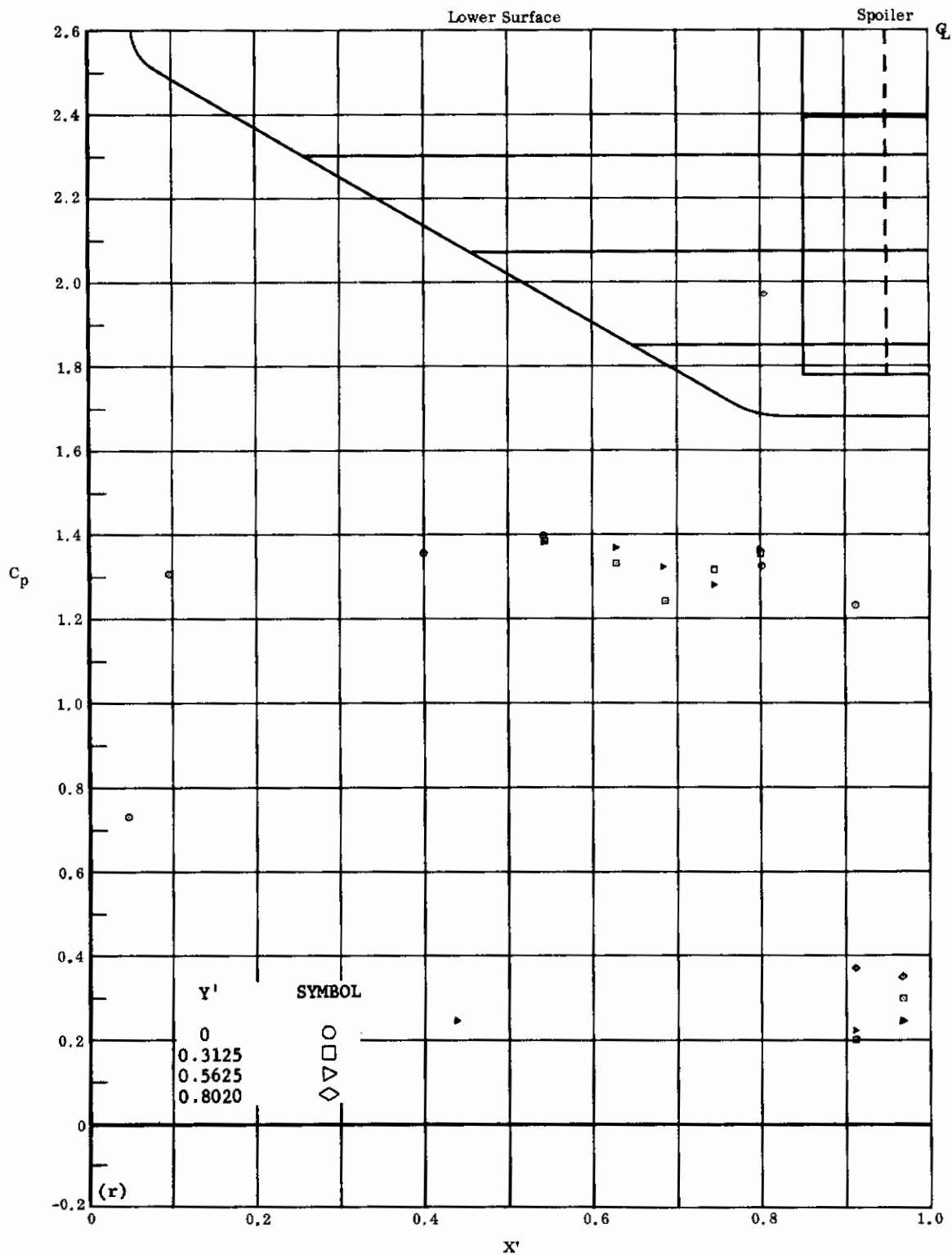

Fig. 39q Configuration IV, $\alpha = +50$, $\delta_2 = \delta_3 = -39$

C_p vs. Y' , lower surface



(NONDIMENSIONAL STREAMWISE DISTANCE FROM VIRTUAL APEX)

Fig. 39r Configuration IV, $\alpha = +50$, $\delta_2 = \delta_3 = -39$

C_p vs. X' , lower surface

Contrails

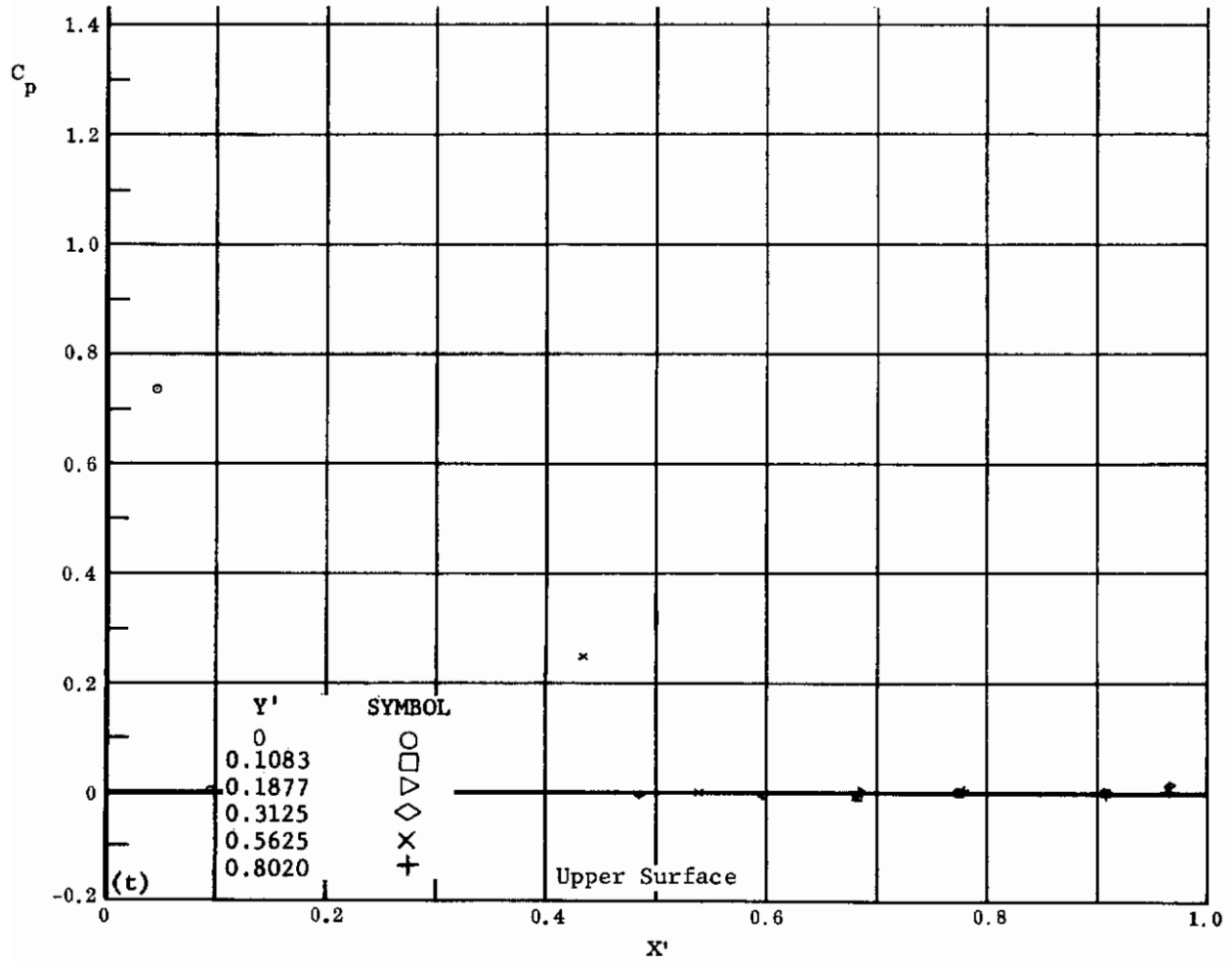
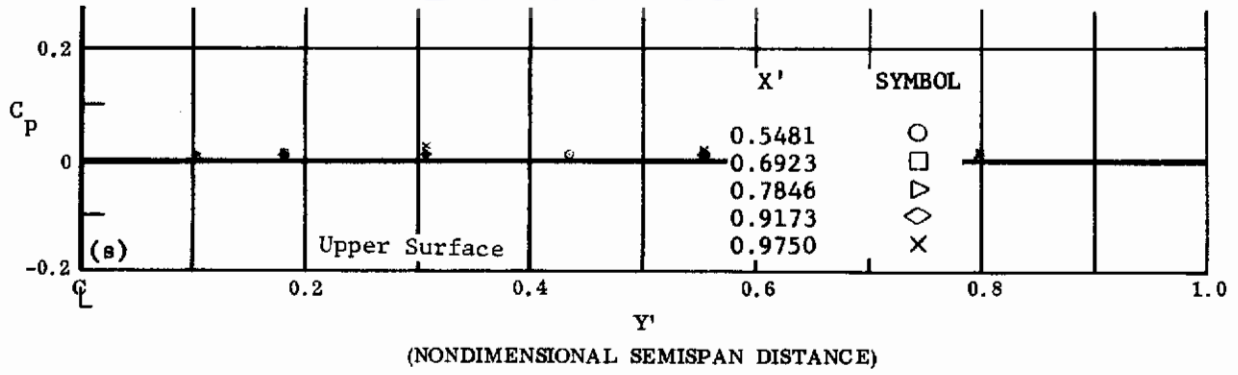

(NONDIMENSIONAL STREAMWISE DISTANCE FROM VIRTUAL APEX)

Fig. 39 Configuration IV, $\alpha = +50$, $\delta_2 = \delta_3 = -39$

s) C_p vs. Y' , upper surface

t) C_p vs. X' , upper surface

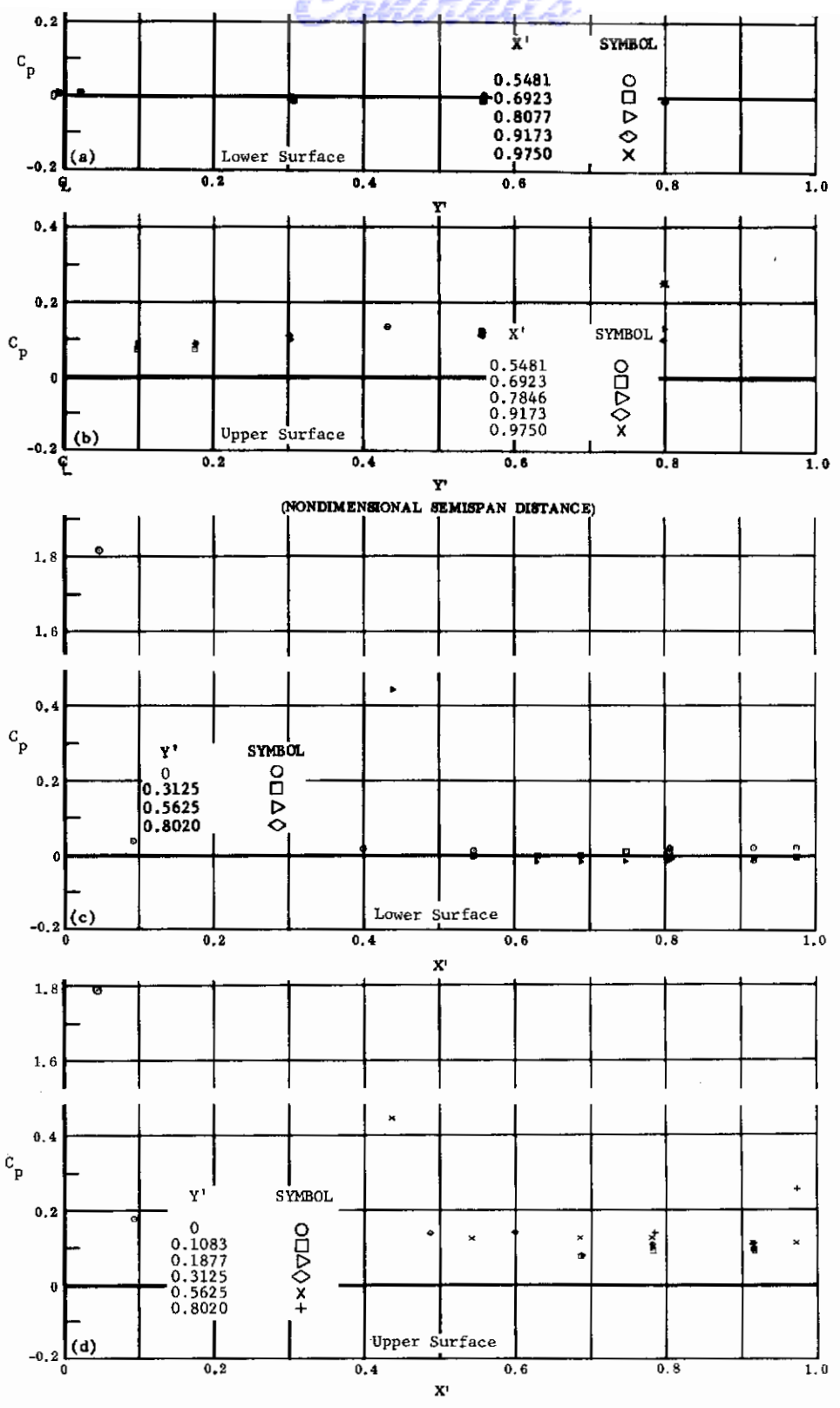

(NONDIMENSIONAL STREAMWISE DISTANCE FROM VIRTUAL APEX)

Fig. 40 Configuration IV, $\alpha = -10$, $\delta_2 = \delta_3 = 0$

- a) C_p vs. Y' , lower surface
- b) C_p vs. Y' , upper surface
- c) C_p vs. X' , lower surface
- d) C_p vs. X' , upper surface

Contrails

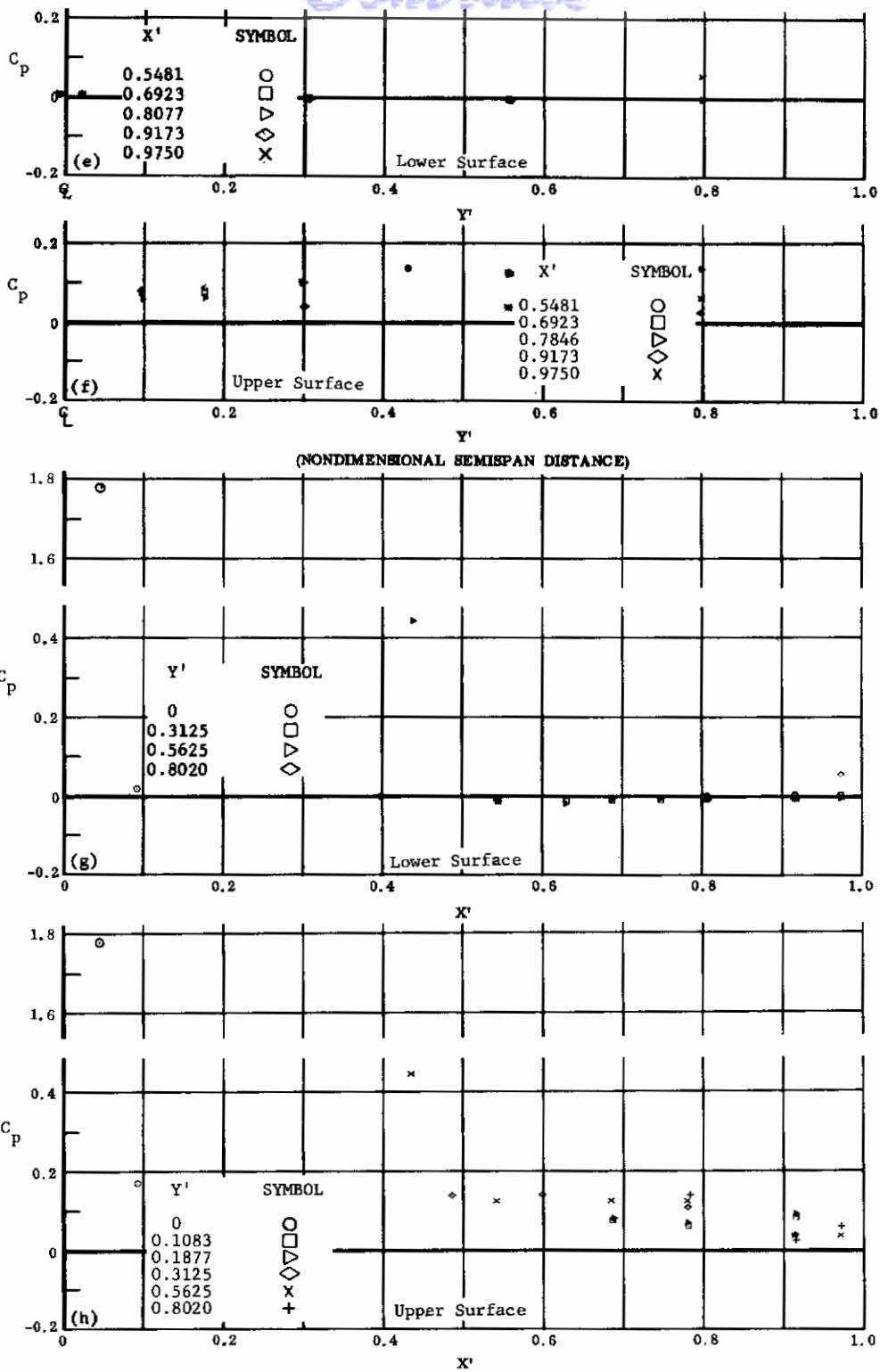

(NONDIMENSIONAL STREAMWISE DISTANCE FROM VIRTUAL APEX)

Fig. 40 Configuration IV, $\alpha = -10$, $\delta_2 = \delta_3 = +10$

- e) C_p vs. Y' , lower surface
- f) C_p vs. Y' , upper surface
- g) C_p vs. X' , lower surface
- h) C_p vs. X' , upper surface

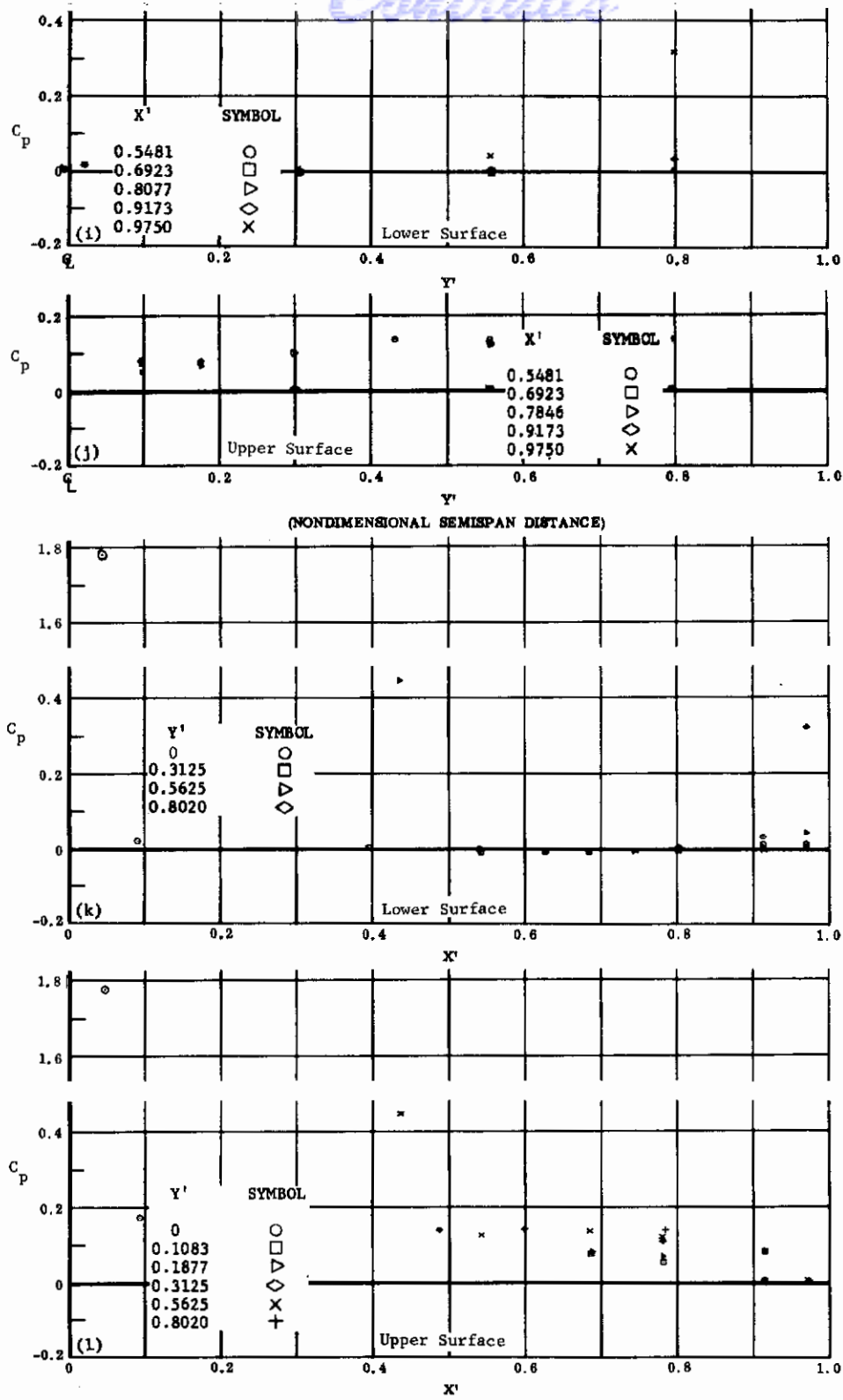

Fig. 40 Configuration IV, $\alpha = -10$, $\delta_2 = \delta_3 = +20$

- i) C_p vs. Y' , lower surface
- j) C_p vs. Y' , upper surface
- k) C_p vs. X' , lower surface
- l) C_p vs. X' , upper surface

Contrails

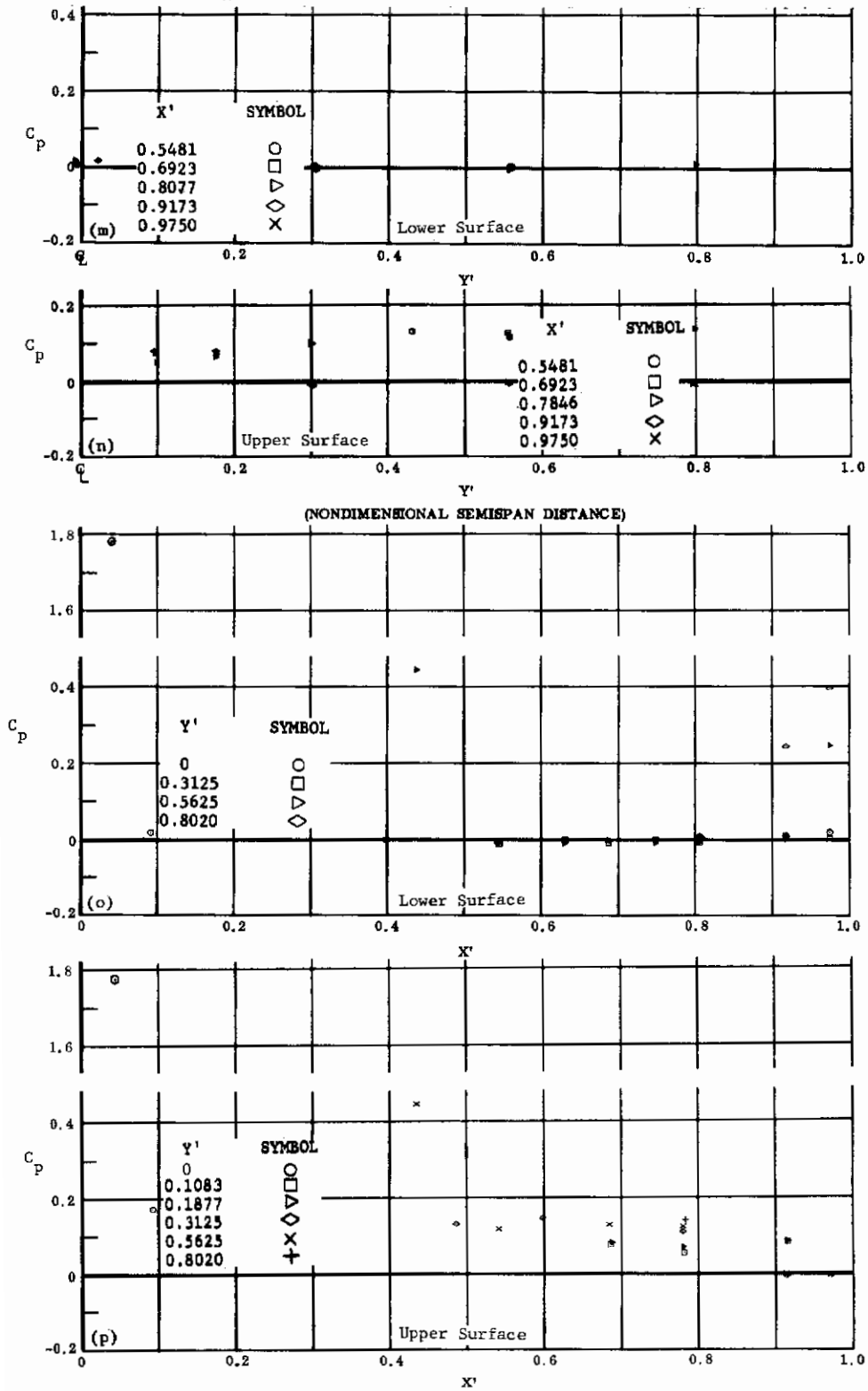
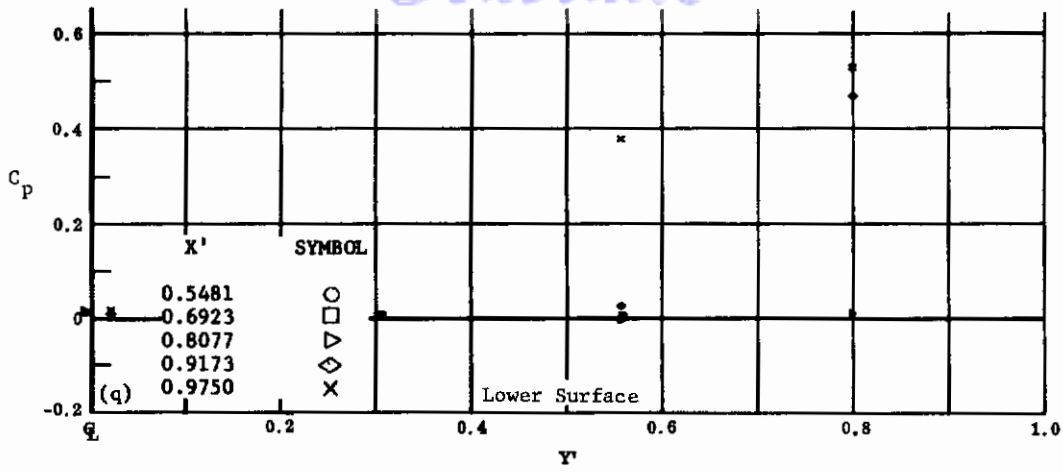

Fig. 40 Configuration IV, $\alpha = -10$, $\delta_2 = \delta_3 = +30$

- m) C_p vs. Y' , lower surface
- n) C_p vs. Y' , upper surface
- o) C_p vs. X' , lower surface
- p) C_p vs. X' , upper surface

Contrails



(NONDIMENSIONAL SEMISPAN DISTANCE)

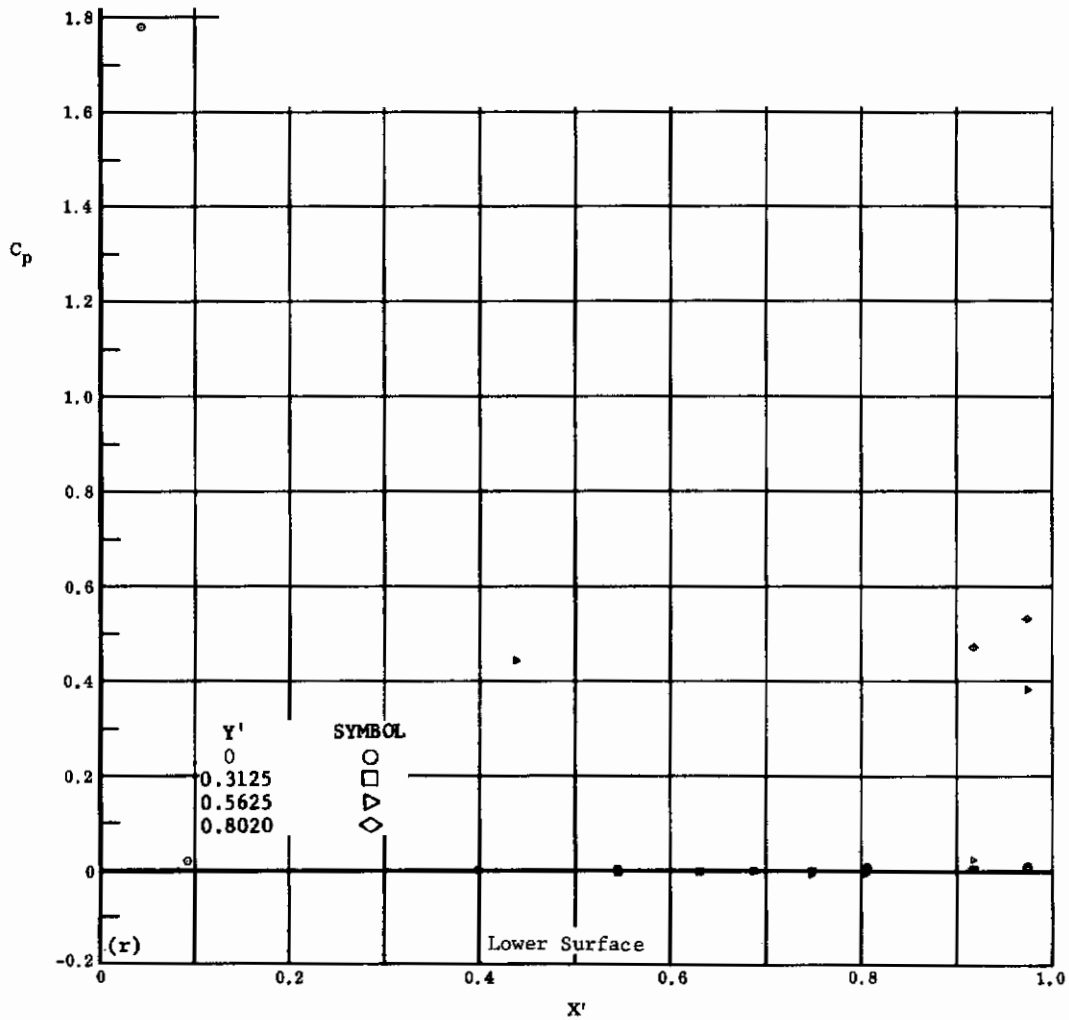

(NONDIMENSIONAL STREAMWISE DISTANCE FROM VIRTUAL APEX)

Fig. 40 Configuration IV, $\alpha = -10$, $\delta_2 = \delta_3 = +39$

q) C_p vs. Y' , lower surface

r) C_p vs. X' , lower surface

Contrails

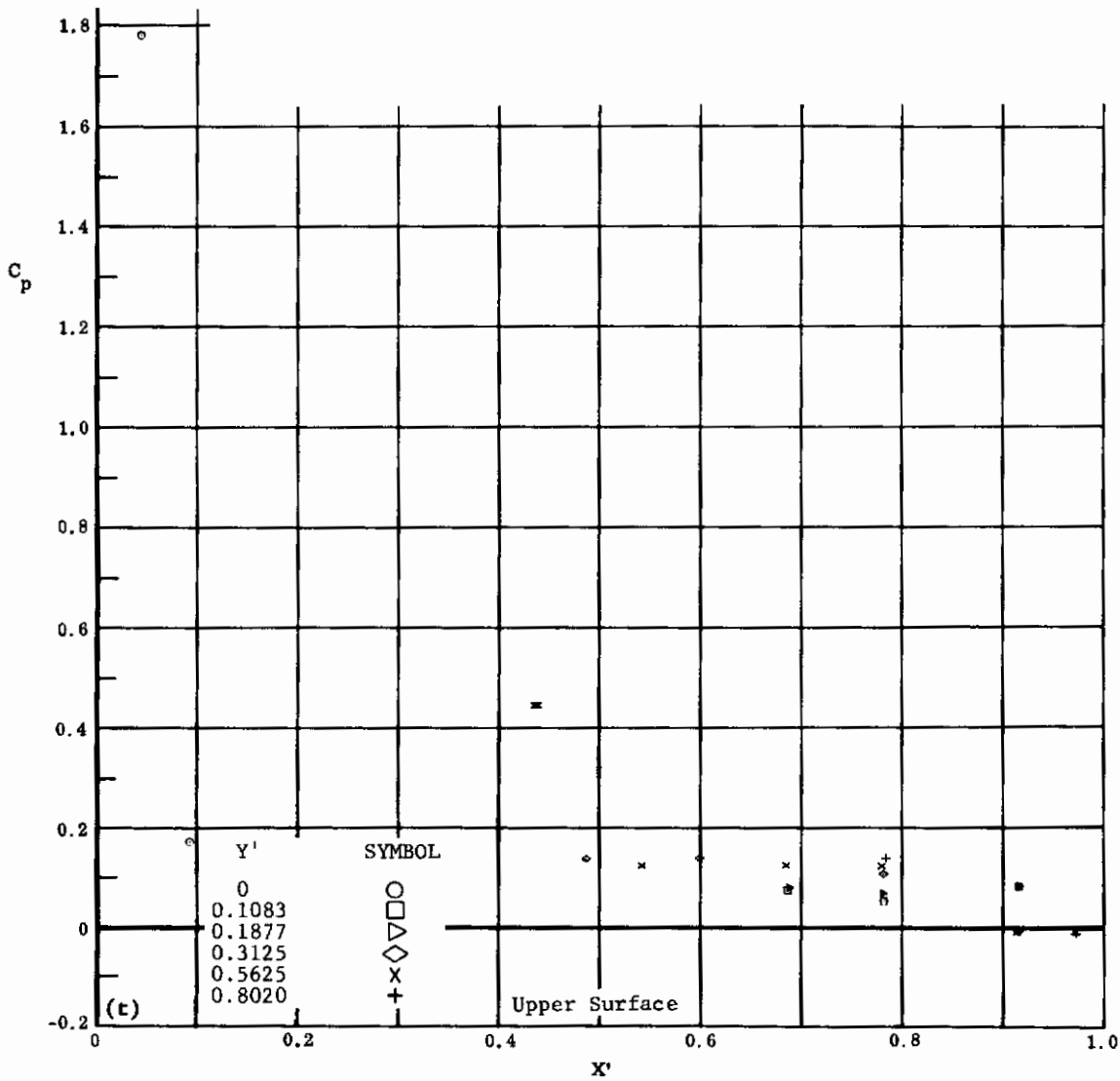
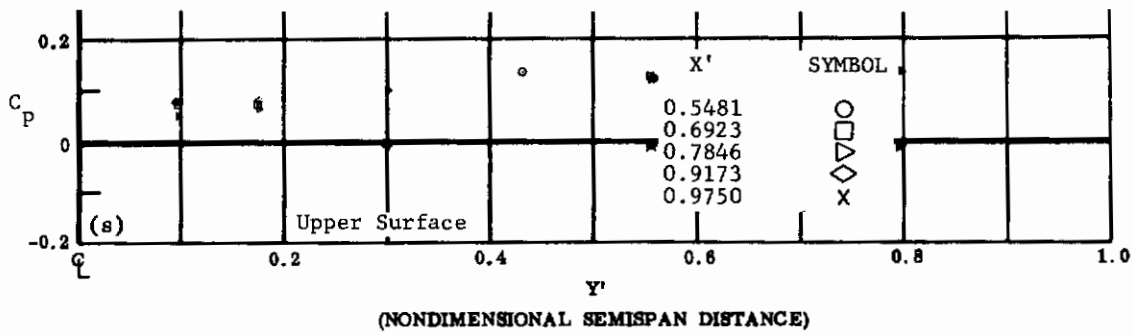

(NONDIMENSIONAL STREAMWISE DISTANCE FROM VIRTUAL APEX)

Fig. 40 Configuration IV, $\alpha = -10$, $\delta_2 = \delta_3 = +39$

s) C_p vs. Y' , upper surface

t) C_p vs. X' , upper surface

Contraails

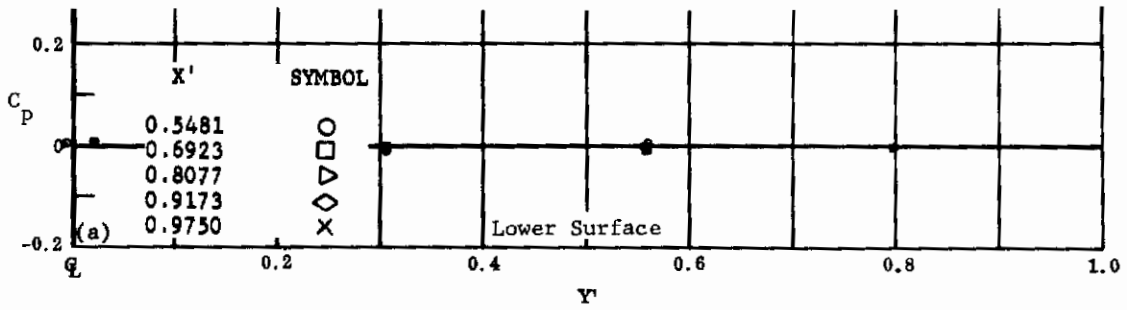

(NONDIMENSIONAL SEMISPAN DISTANCE)

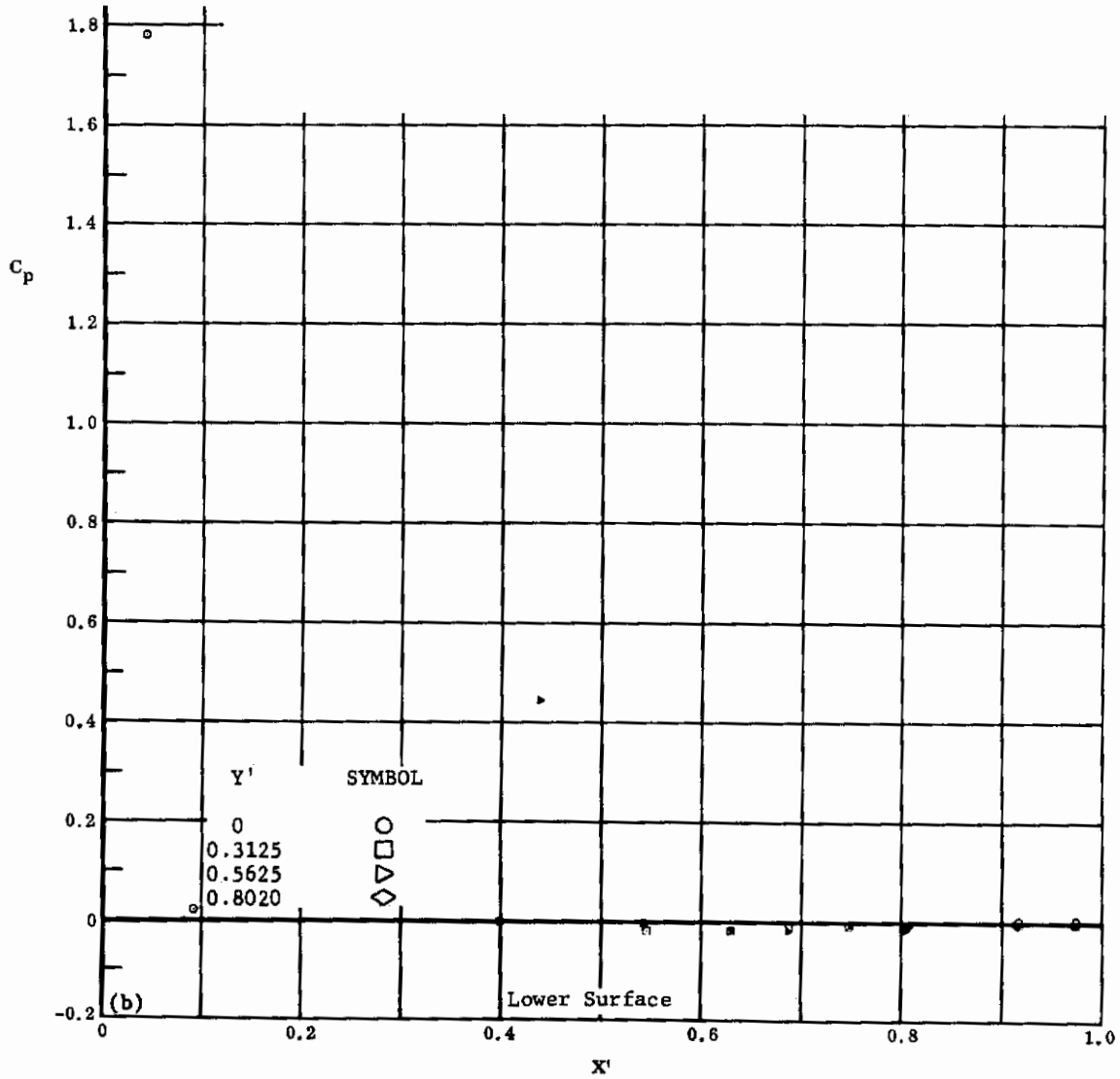

(NONDIMENSIONAL STREAMWISE DISTANCE FROM VIRTUAL APEX)

Fig. 41 Configuration IV, $\alpha = -10$, $\delta_2 = \delta_3 = -10$

- a) C_p vs. Y' , lower surface
- b) C_p vs. X' , lower surface

Contrails

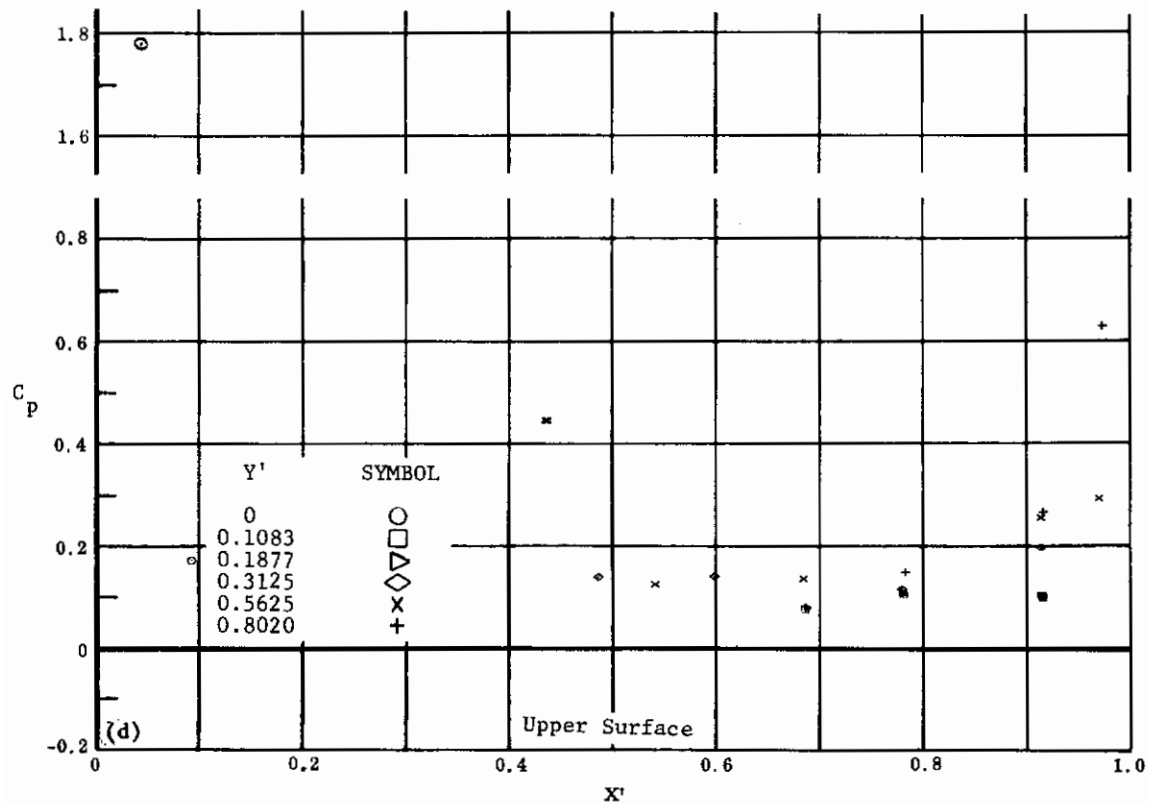
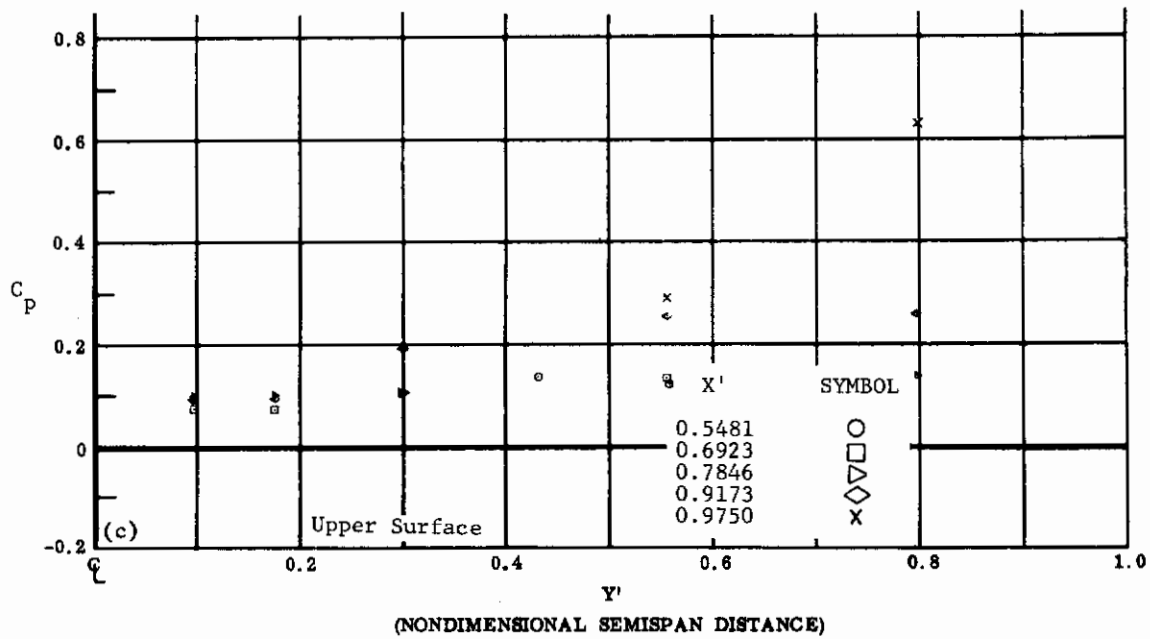

(NONDIMENSIONAL STREAMWISE DISTANCE FROM VIRTUAL APEX)

Fig. 41 Configuration IV, $\alpha = -10$, $\delta_2 = \delta_3 = -10$

c) C_p vs. Y' , upper surface

d) C_p vs. X' , upper surface

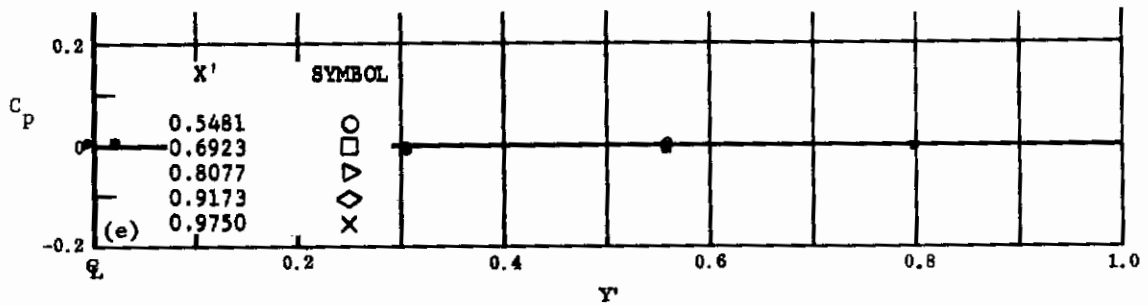

(NONDIMENSIONAL SEMISPAN DISTANCE)

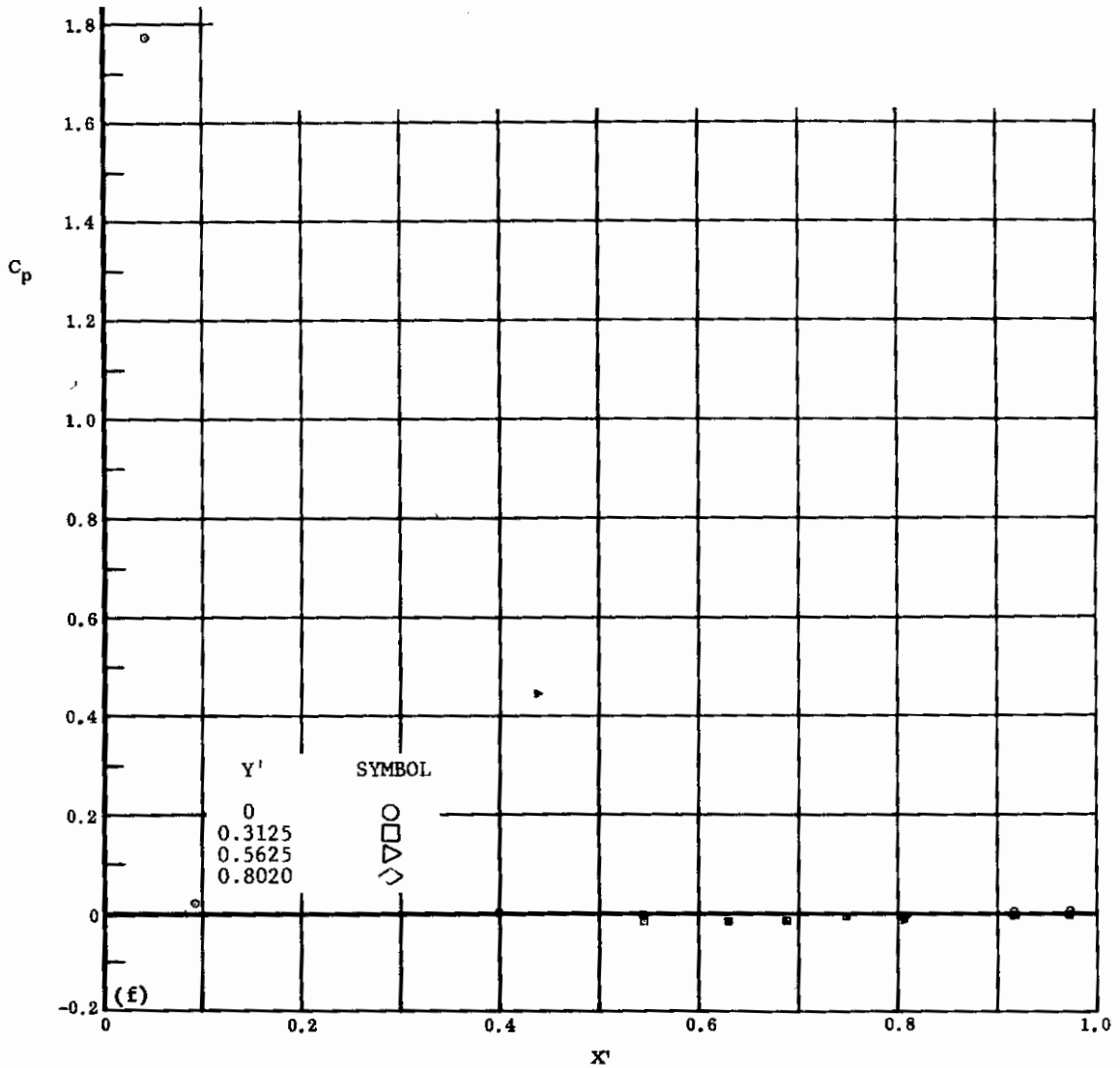

(NONDIMENSIONAL STREAMWISE DISTANCE FROM VIRTUAL APEX)

Fig. 41 Configuration IV, $\alpha = -10$, $\delta_2 = \delta_3 = -20$

e) C_p vs. Y' , lower surface

f) C_p vs. X' , lower surface

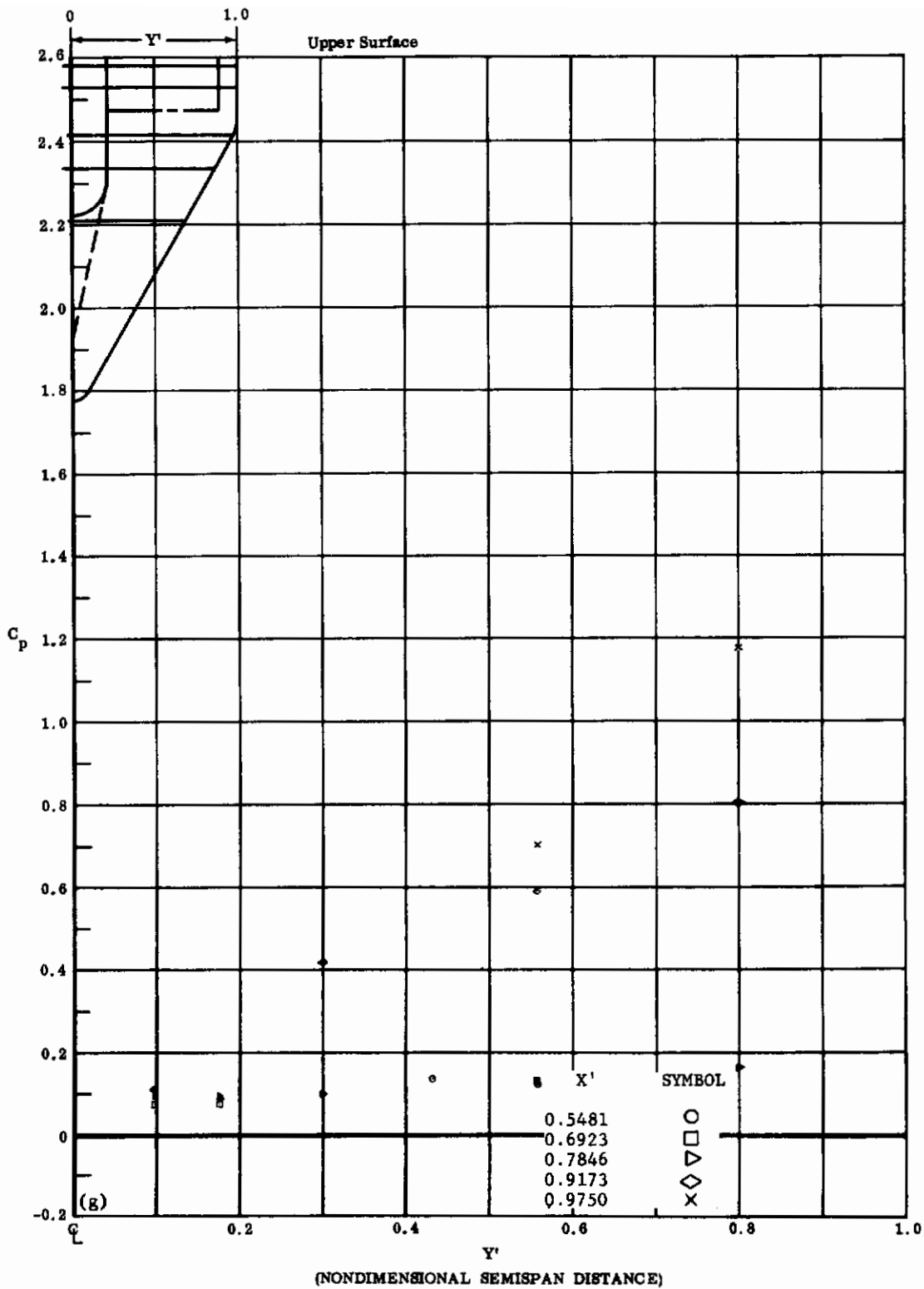
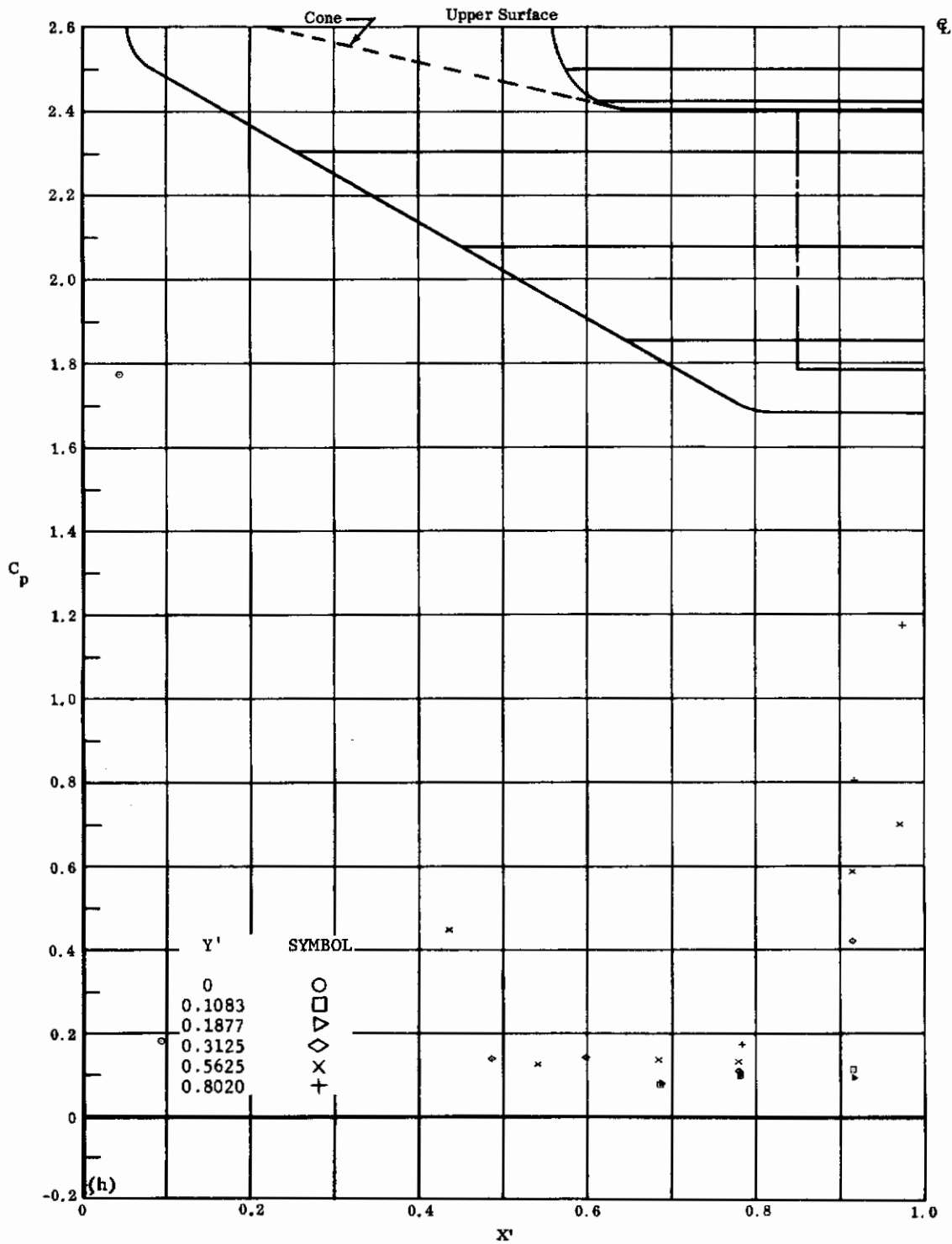

Fig. 41g Configuration IV, $\alpha = -10$, $\delta_2 = \delta_3 = -20$

C_p vs. Y' , upper surface



(NONDIMENSIONAL STREAMWISE DISTANCE FROM VIRTUAL APEX)

Fig. 4lh Configuration IV, $\alpha = -10$, $\delta_2 = \delta_3 = -20$

C_p vs. X' , upper surface

Contrails

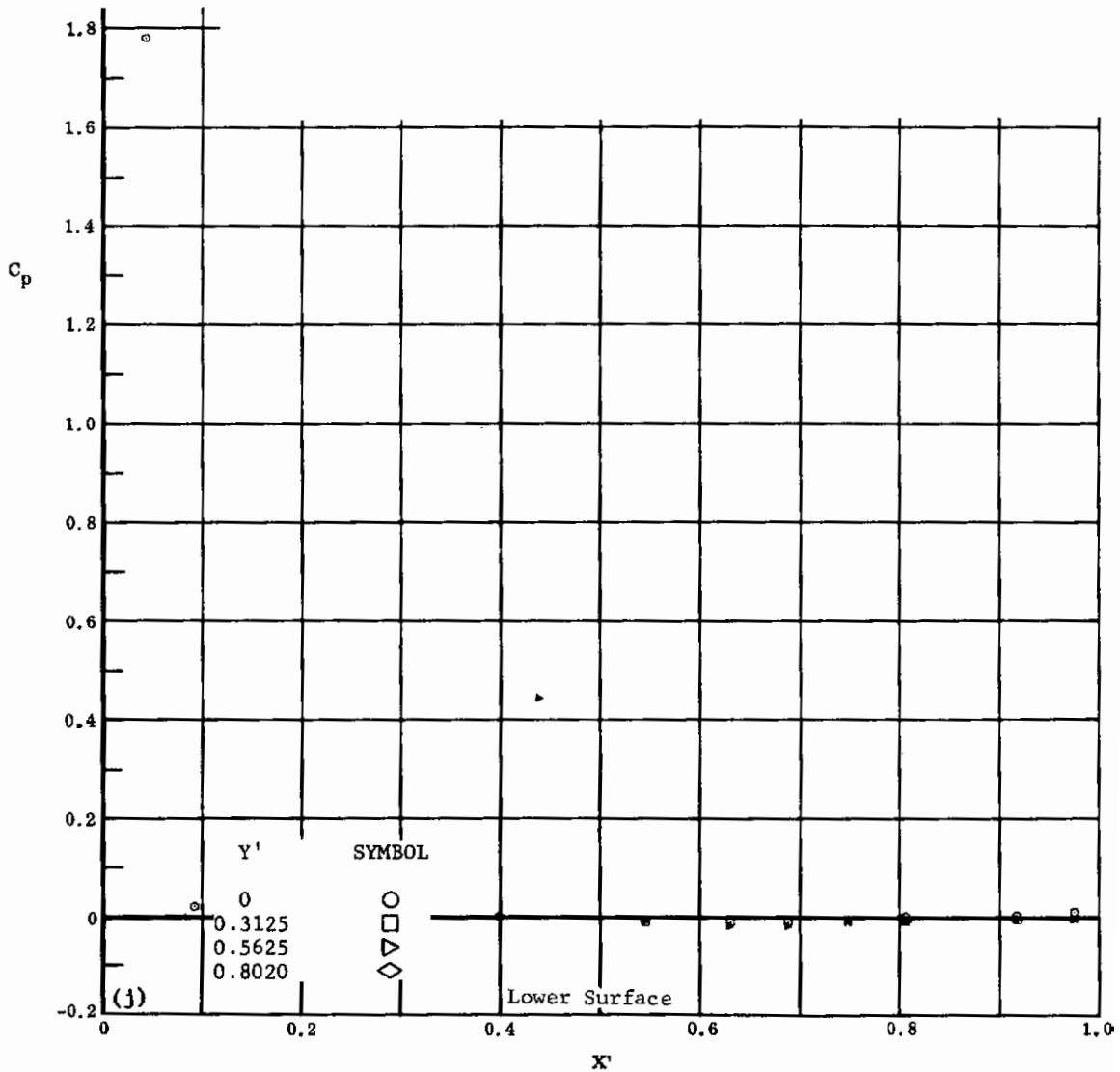
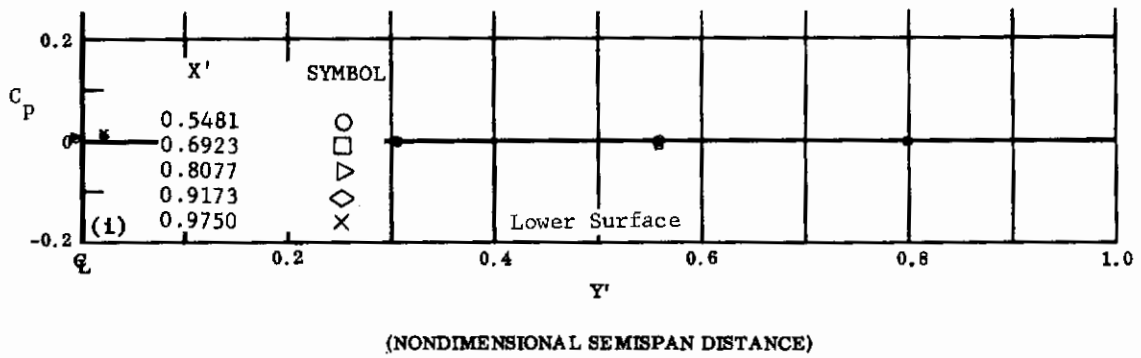

(NONDIMENSIONAL STREAMWISE DISTANCE FROM VIRTUAL APEX)

Fig. 41 Configuration IV, $\alpha = -10$, $\delta_2 = \delta_3 = -30$

i) C_p vs. Y' , lower surface

j) C_p vs. X' , lower surface

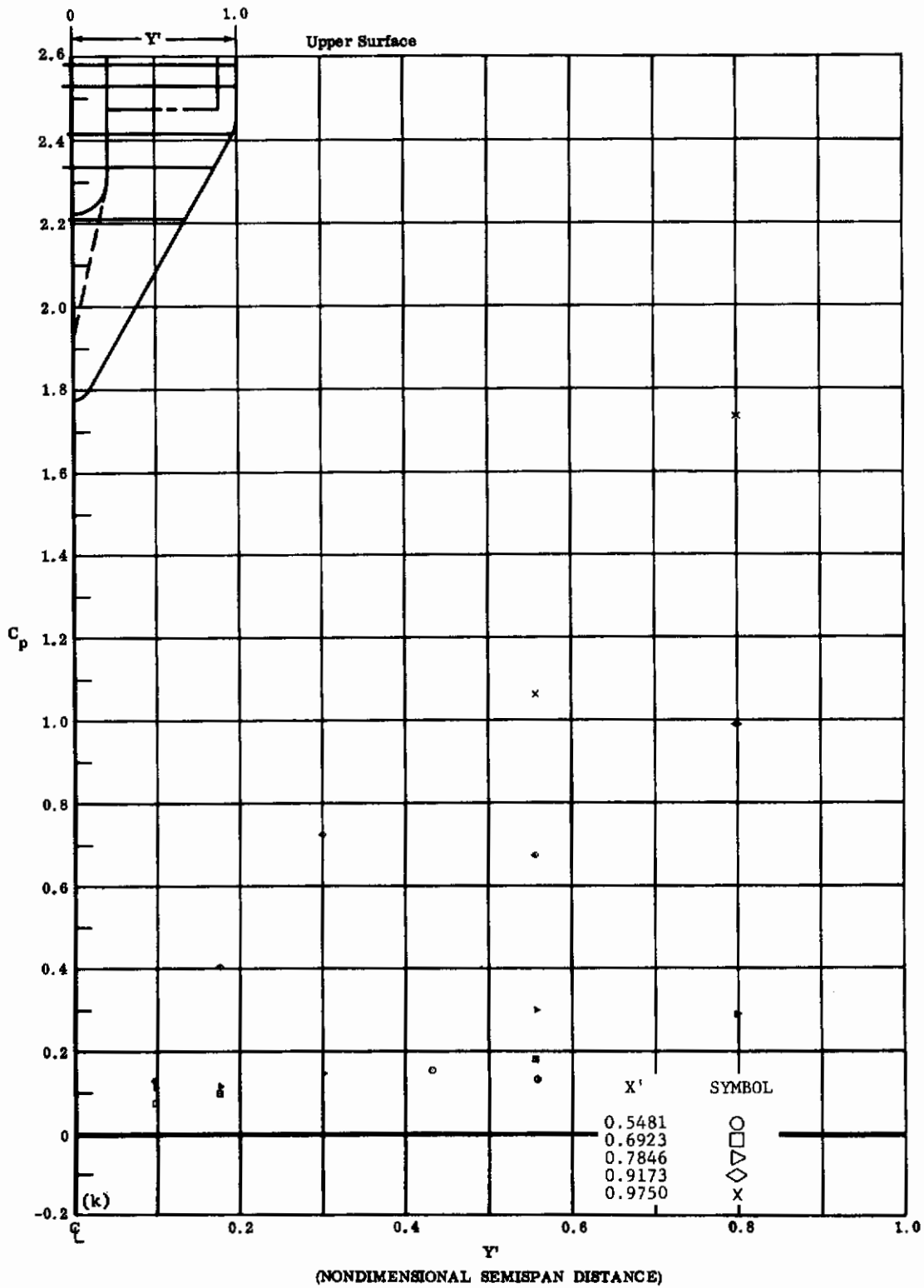
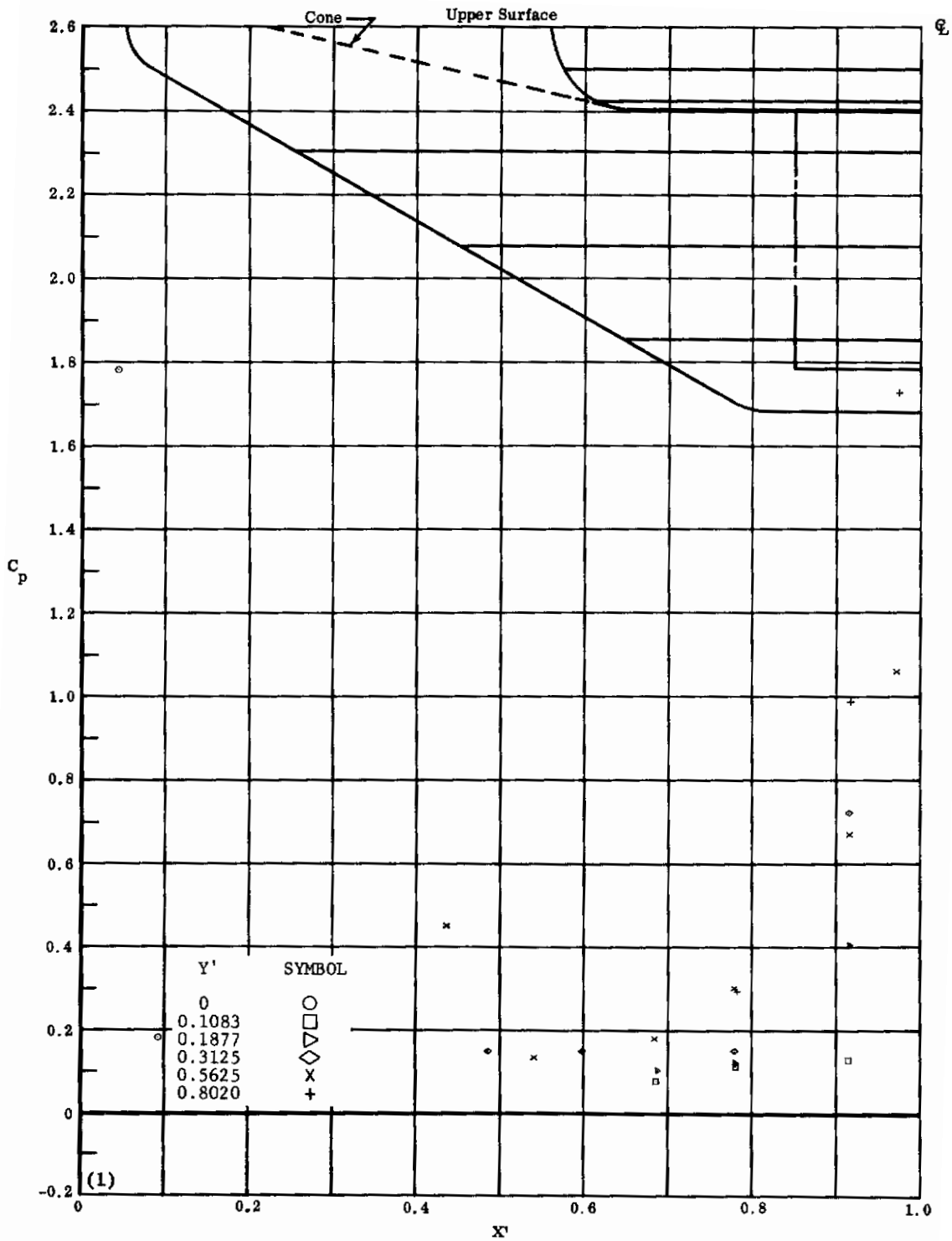

Fig. 41k Configuration IV, $\alpha = -10$, $\delta_2 = \delta_3 = -30$

C_p vs. Y' , upper surface



(NONDIMENSIONAL STREAMWISE DISTANCE FROM VIRTUAL APEX)

Fig. 411 Configuration IV, $\alpha = -10$, $\delta_2 = \delta_3 = -30$

C_p vs. X' , upper surface

Contrails

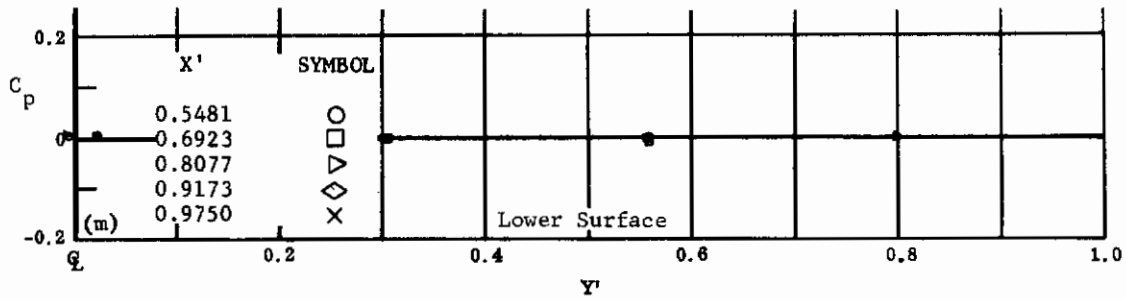

(NONDIMENSIONAL SEMISPAN DISTANCE)

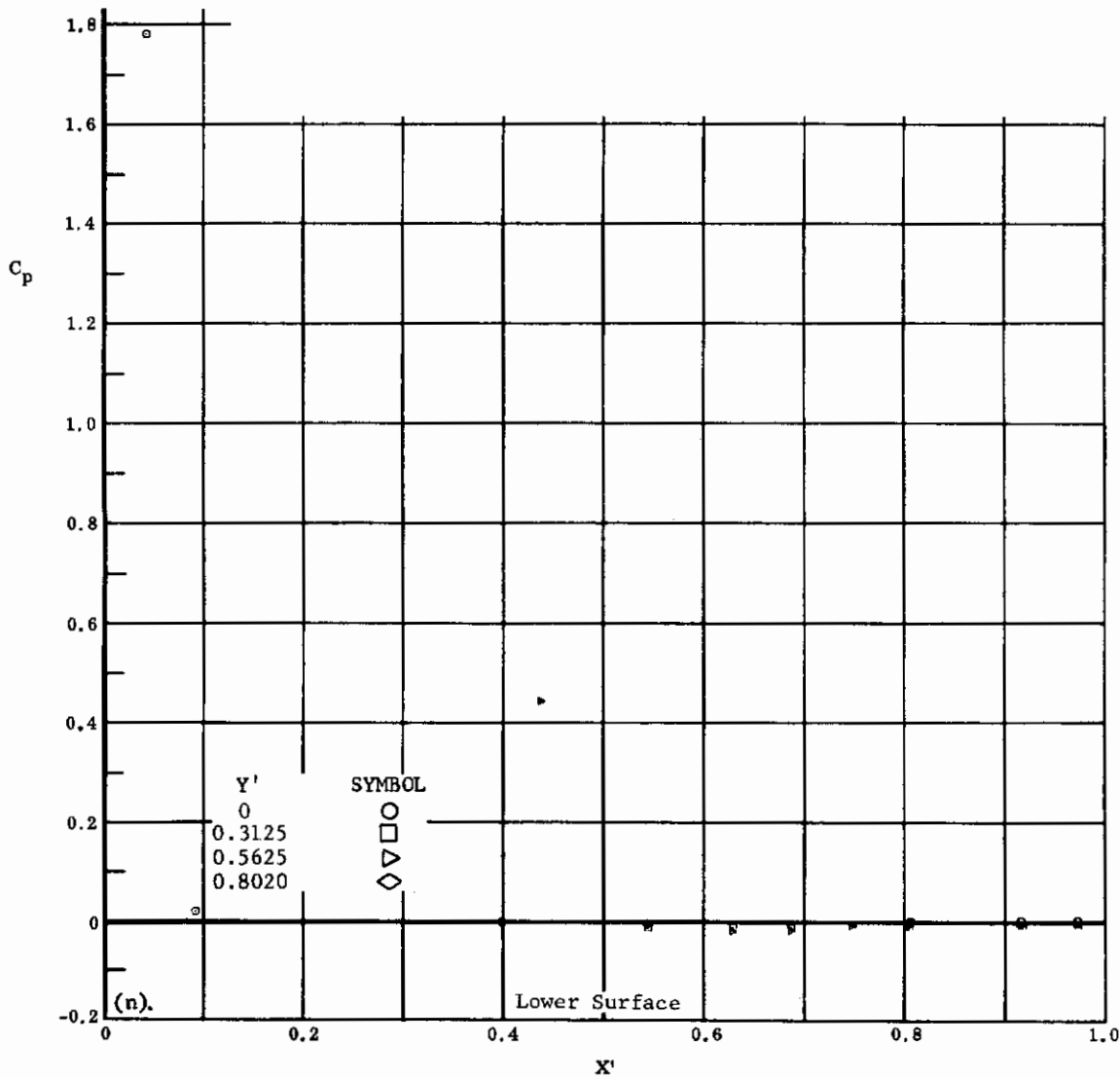

(NONDIMENSIONAL STREAMWISE DISTANCE FROM VIRTUAL APEX)

Fig. 41 Configuration IV, $\alpha = -10$, $\delta_2 = \delta_3 = -39$

- m) C_p vs. Y' , lower surface
- n) C_p vs. X' , lower surface

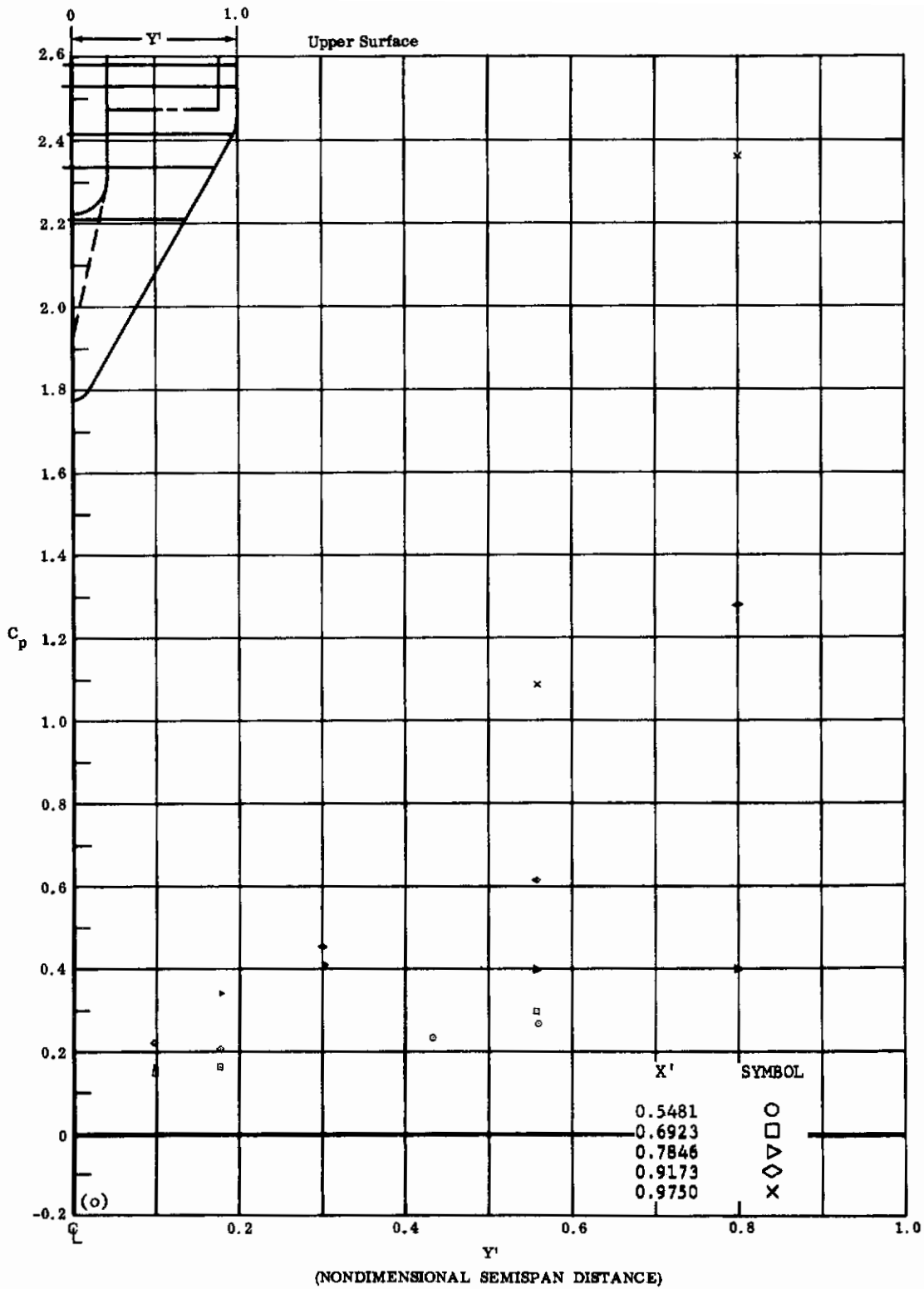
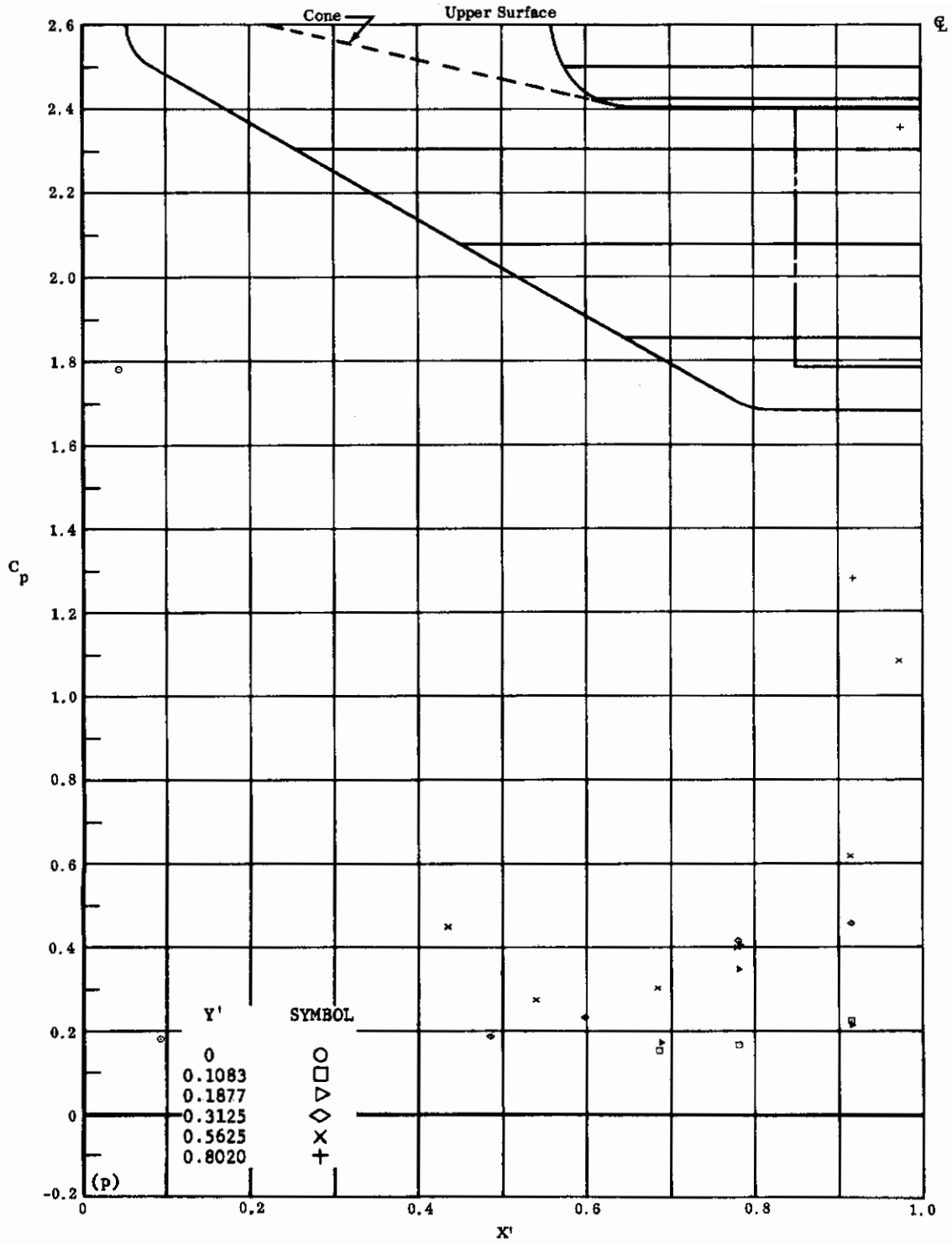

Fig. 41o Configuration IV, $\alpha = -10$, $\delta_2 = \delta_3 = -39$

C_p vs. Y' , upper surface



(NONDIMENSIONAL STREAMWISE DISTANCE FROM VIRTUAL APEX)

Fig. 41p Configuration IV, $\alpha = -10$, $\delta_2 = \delta_3 = -39$

C_p vs. X' , upper surface

Contrails

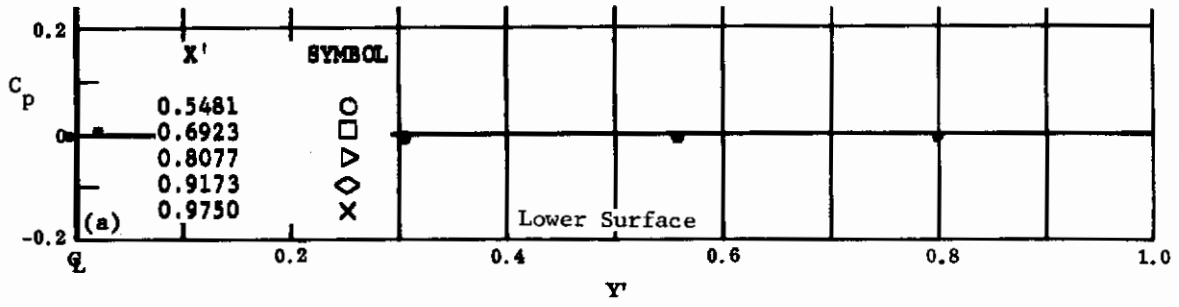

(NONDIMENSIONAL SEMISPAN DISTANCE)

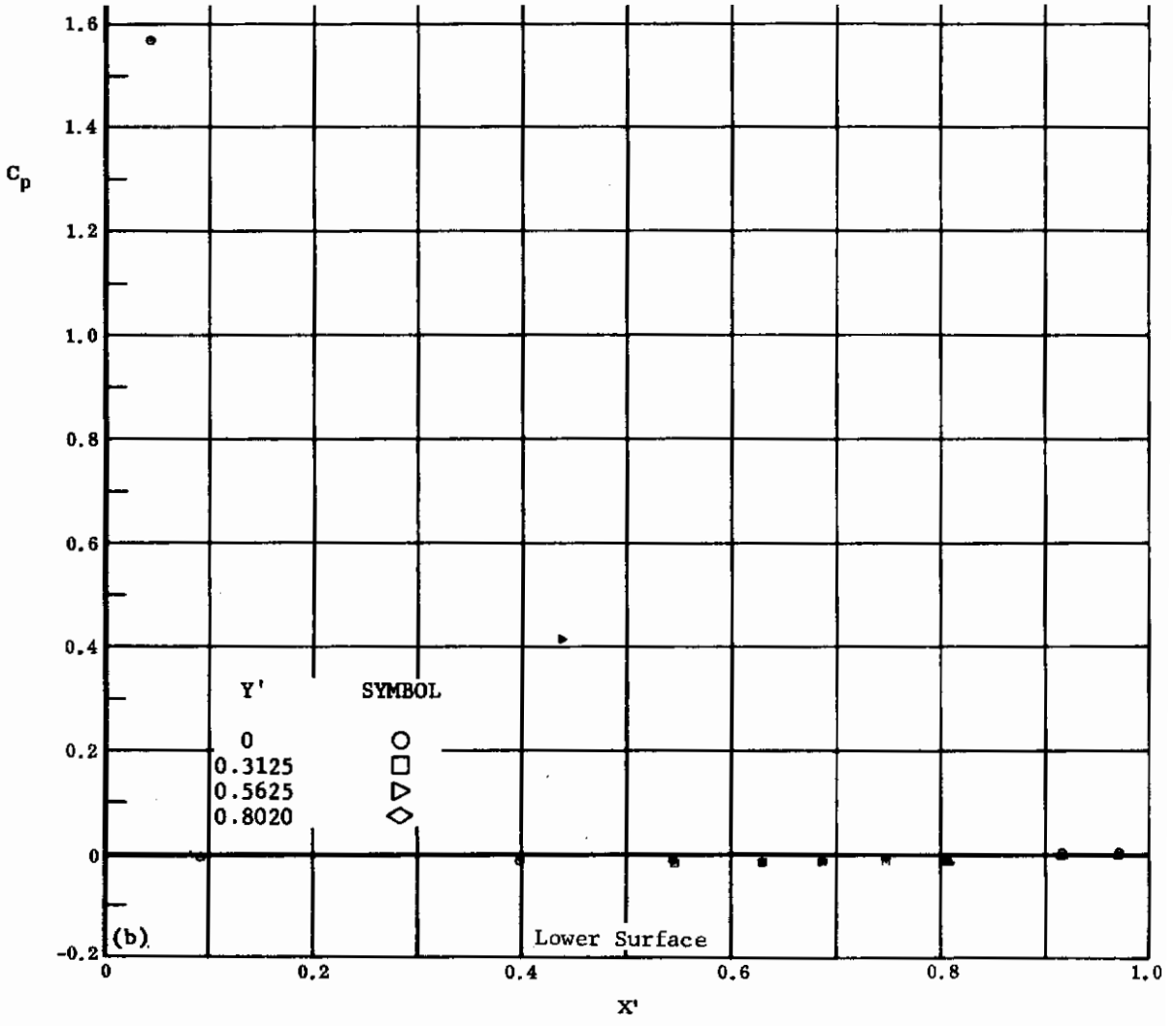

(NONDIMENSIONAL STREAMWISE DISTANCE FROM VIRTUAL APEX)

Fig. 42 Configuration IV, $\alpha = -20$, $\delta_2 = \delta_3 = 0$

- a) C_p vs. Y', lower surface
- b) C_p vs. X', lower surface

Contrails

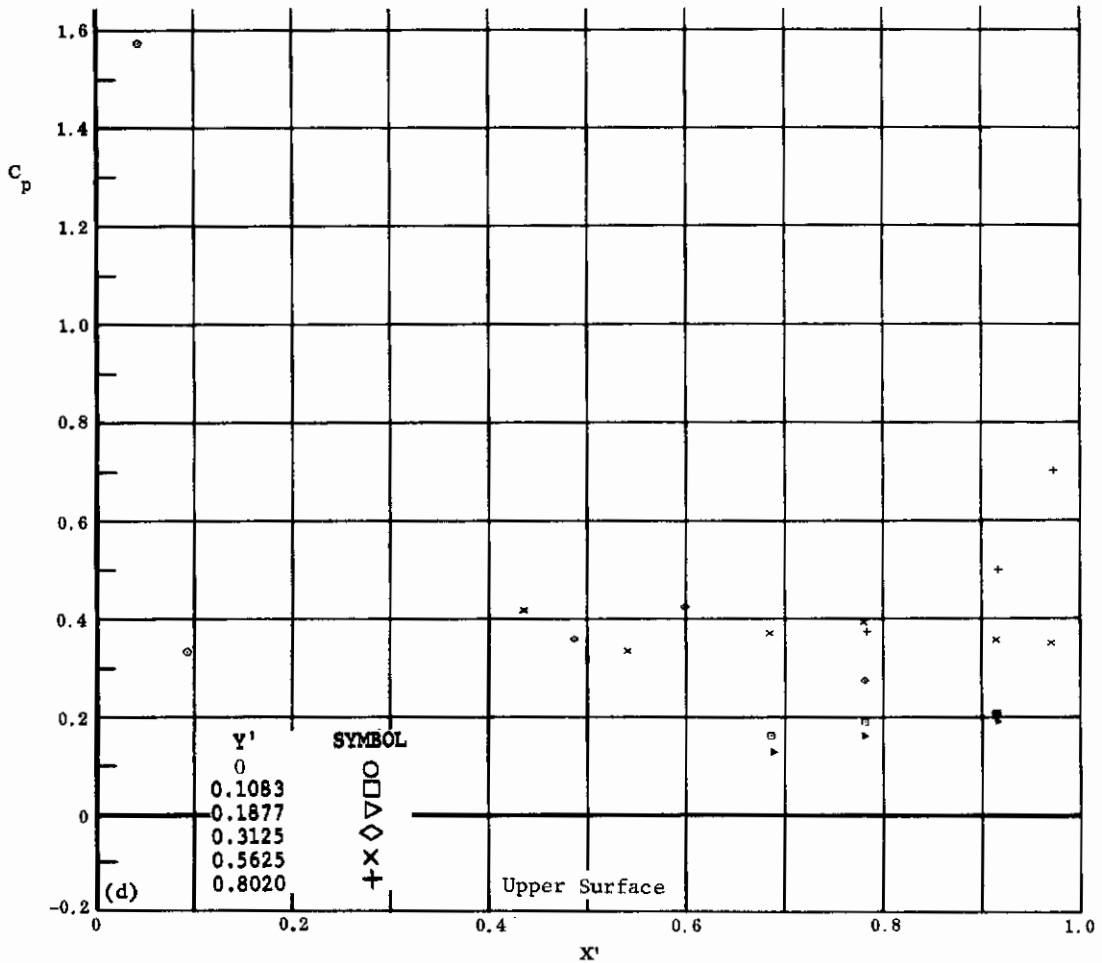
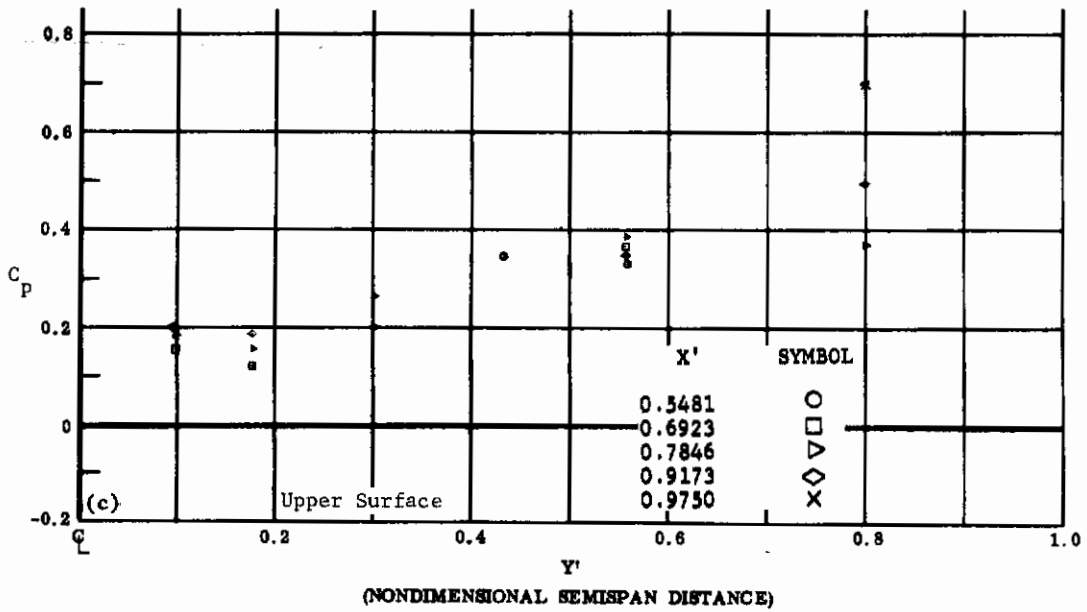

(NONDIMENSIONAL STREAMWISE DISTANCE FROM VIRTUAL APEX)

Fig. 42 Configuration IV, $\alpha = -20$, $\delta_2 = \delta_3 = 0$

c) C_p vs. Y' , upper surface

d) C_p vs. X' , upper surface

Contrails

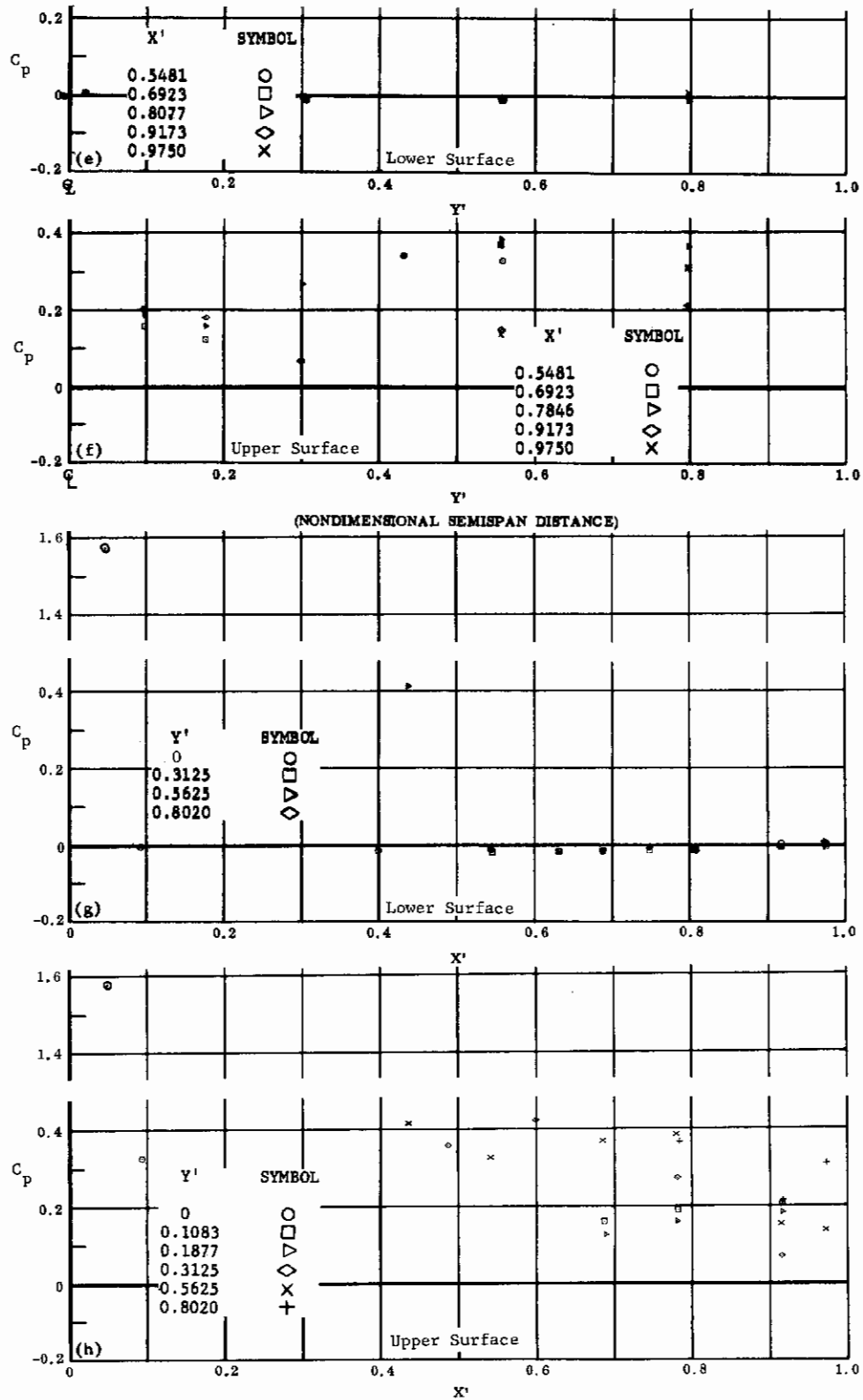
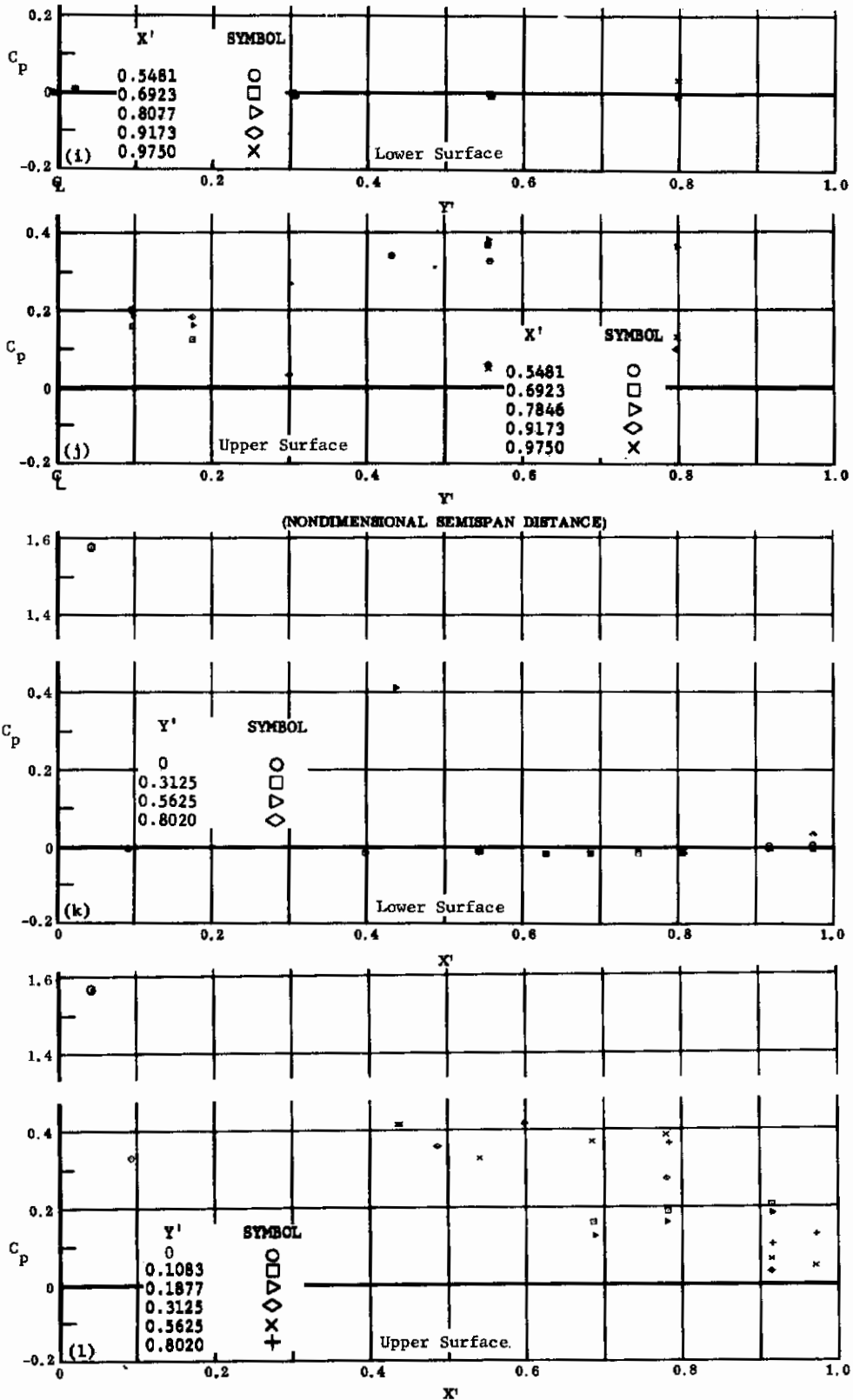

Fig. 42 Configuration IV, $\alpha = -20$, $\delta_2 = \delta_3 = +10$

- e) C_p vs. Y' , lower surface
- f) C_p vs. Y' , upper surface
- g) C_p vs. X' , lower surface
- h) C_p vs. X' , upper surface

Contrails



(NONDIMENSIONAL STREAMWISE DISTANCE FROM VIRTUAL APEX)

Fig. 42 Configuration IV, $\alpha = -20$, $\delta_2 = \delta_3 = +20$

- 1) C_p vs. Y' , lower surface
- j) C_p vs. Y' , upper surface
- k) C_p vs. X' , lower surface
- l) C_p vs. X' , upper surface

Contrails

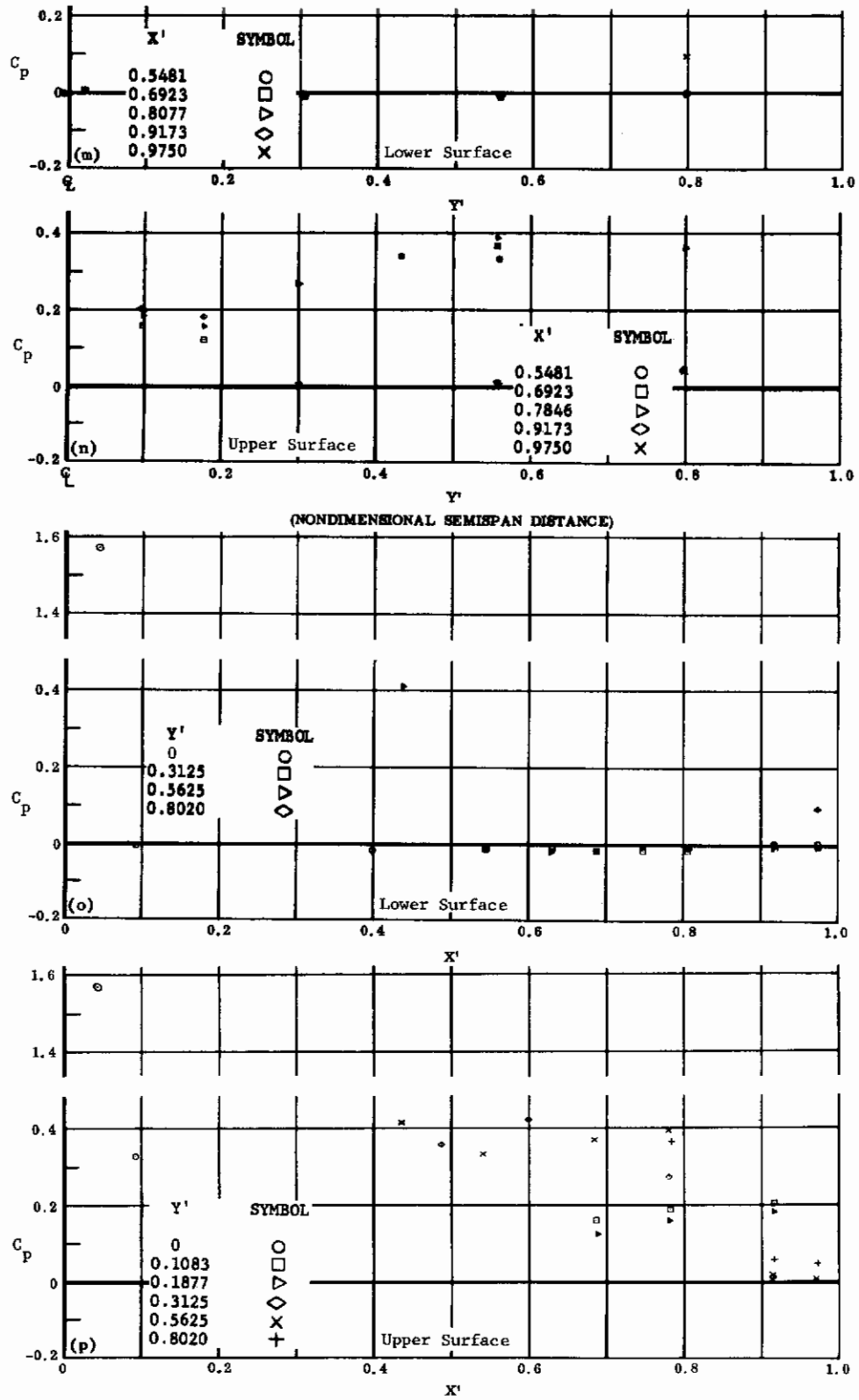

(NONDIMENSIONAL STREAMWISE DISTANCE FROM VIRTUAL APEX)

Fig. 42 Configuration IV, $\alpha = -20^\circ$, $\delta_2 = \delta_3 = +30^\circ$

- m) C_p vs. Y' , lower surface
- n) C_p vs. Y' , upper surface
- o) C_p vs. X' , lower surface
- p) C_p vs. X' , upper surface

Contraails

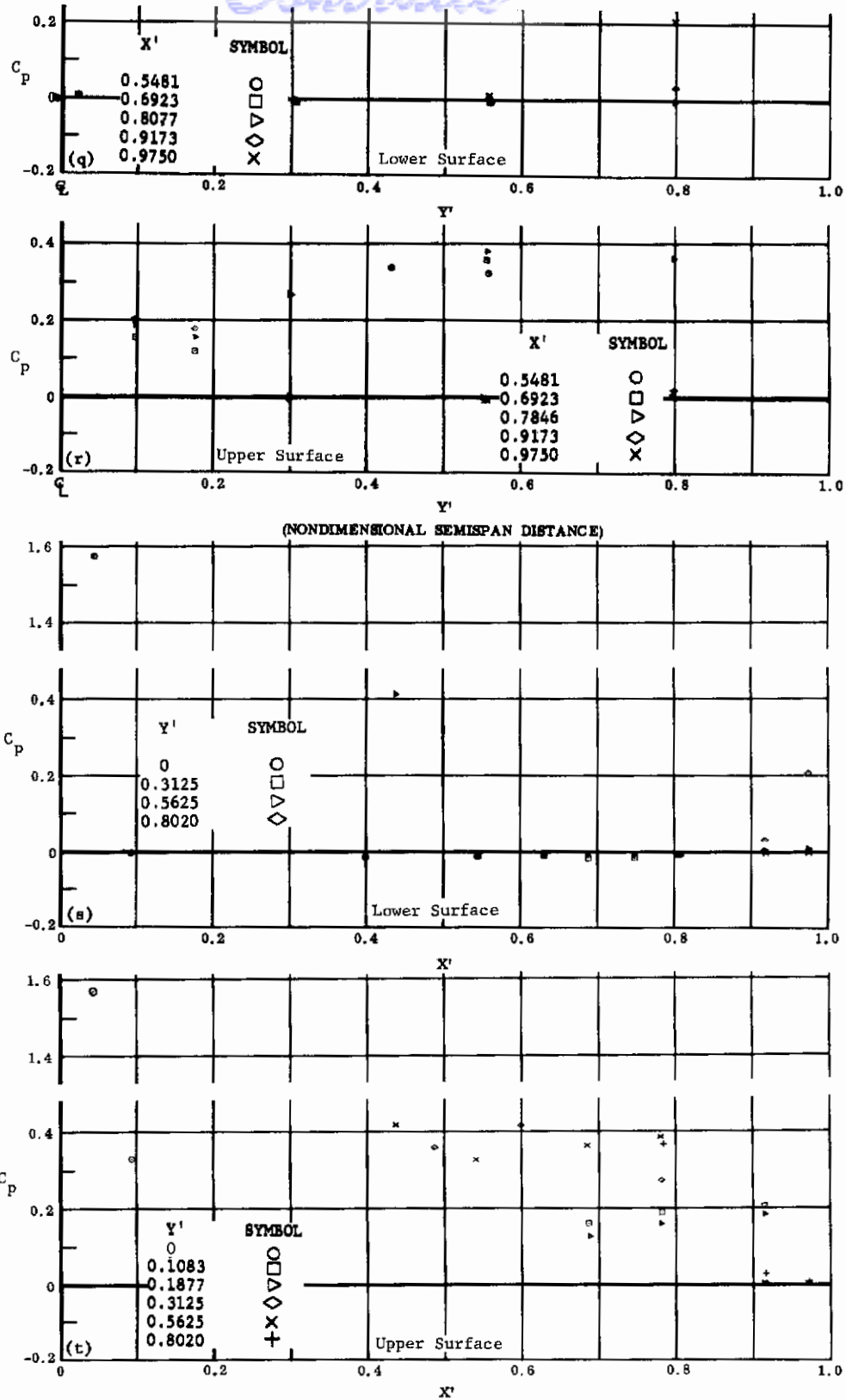

(NONDIMENSIONAL STREAMWISE DISTANCE FROM VIRTUAL APEX)

Fig. 42 Configuration IV, $\alpha = -20$, $\delta_2 = \delta_3 = +39$

- q) C_p vs. Y' , lower surface
- r) C_p vs. Y' , upper surface
- s) C_p vs. X' , lower surface
- t) C_p vs. X' , upper surface

Contrails

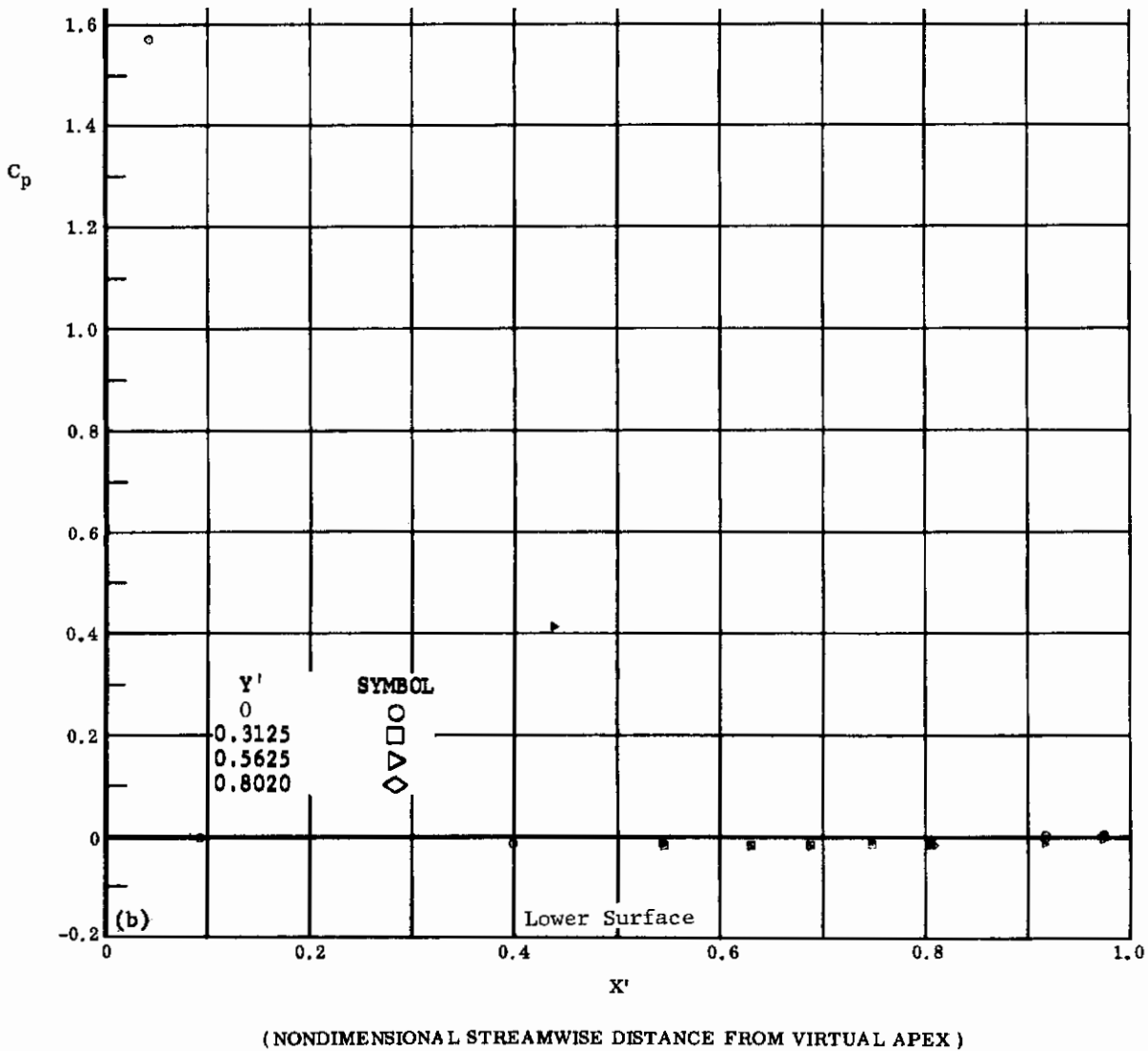
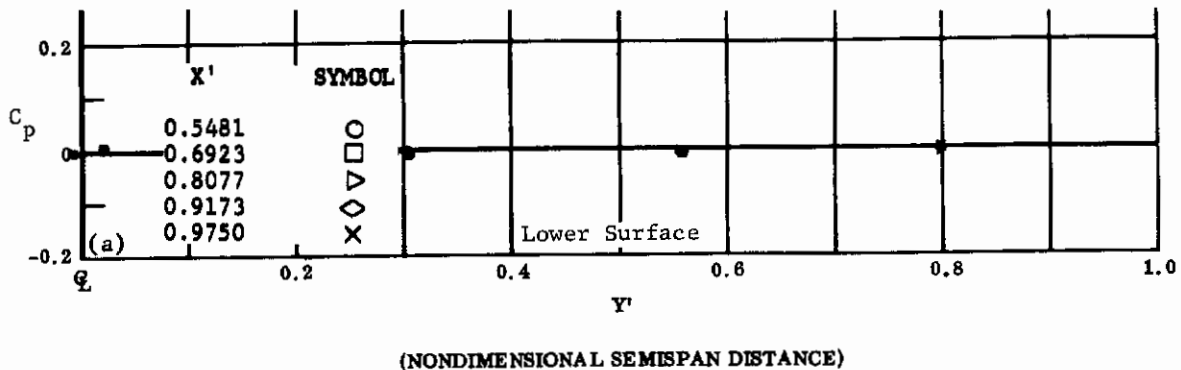

Fig. 43 Configuration IV, $\alpha = -20$, $\delta_2 = \delta_3 = -10$

- a) C_p vs. Y' , lower surface
- b) C_p vs. X' , lower surface

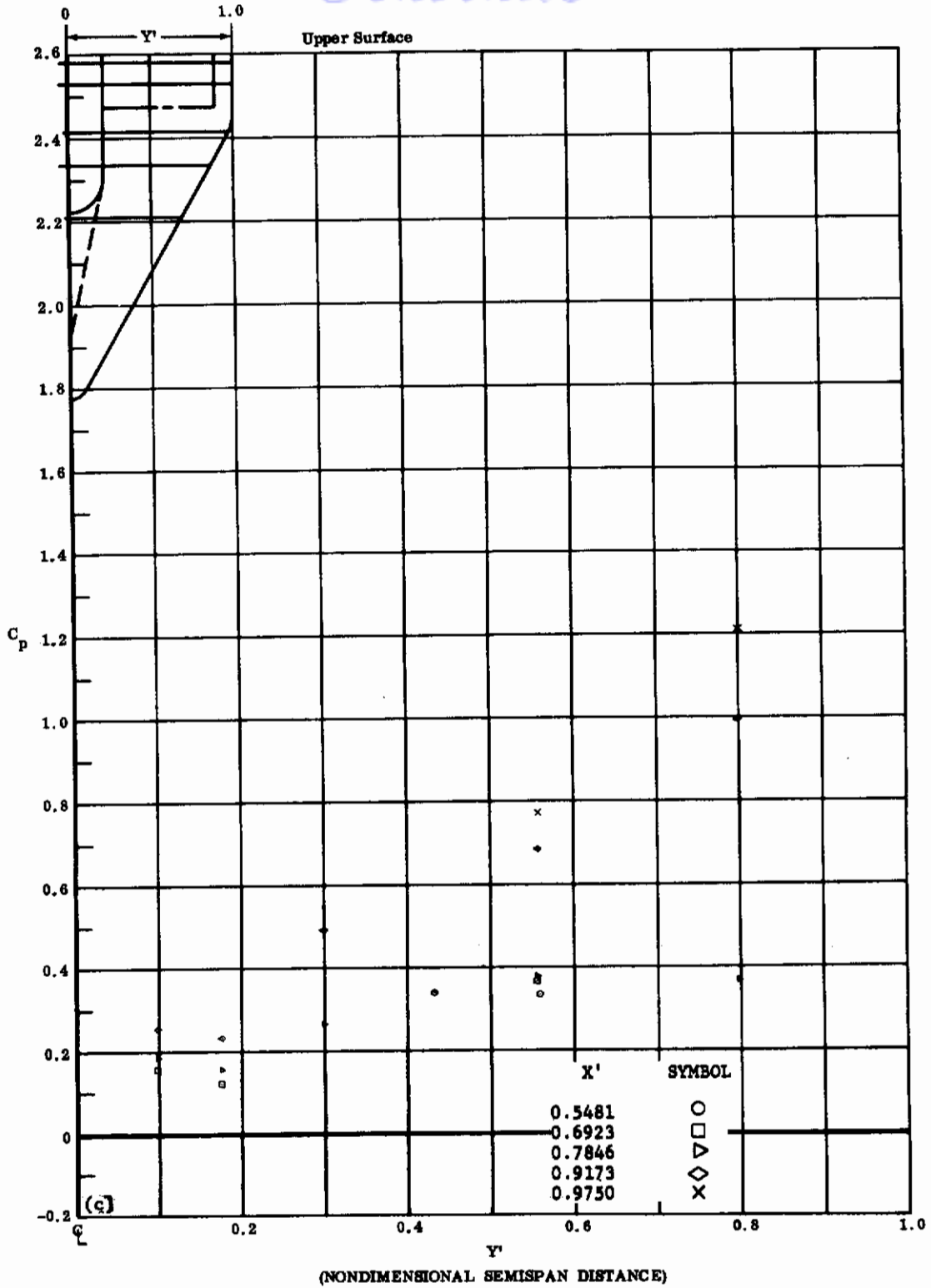
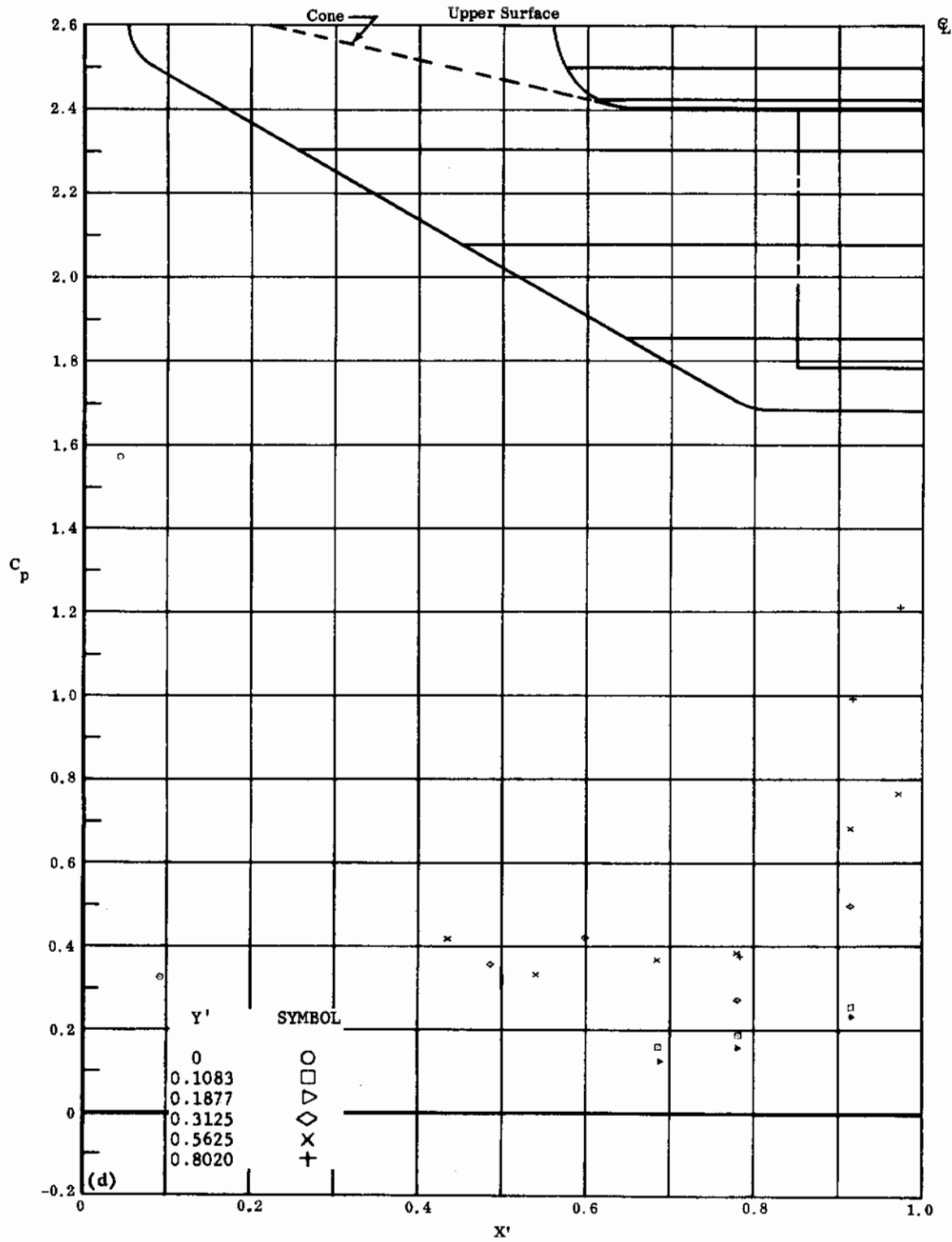

Fig. 43c Configuration IV, $\alpha = -20$, $\delta_2 = \delta_3 = -10$

C_p vs. Y' , upper surface



(NONDIMENSIONAL STREAMWISE DISTANCE FROM VIRTUAL APEX)

Fig. 43d Configuration IV, $\alpha = -20$, $\delta_2 = \delta_3 = -10$

C_p vs. X' , upper surface

Contrails

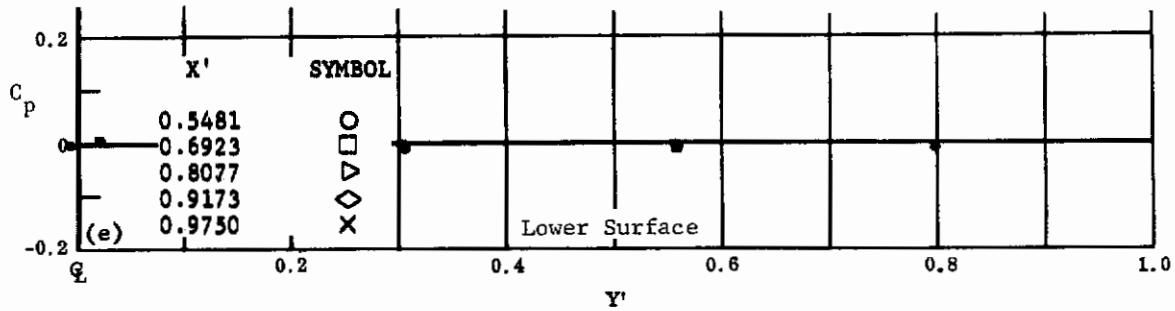

(NONDIMENSIONAL SEMISPAN DISTANCE)

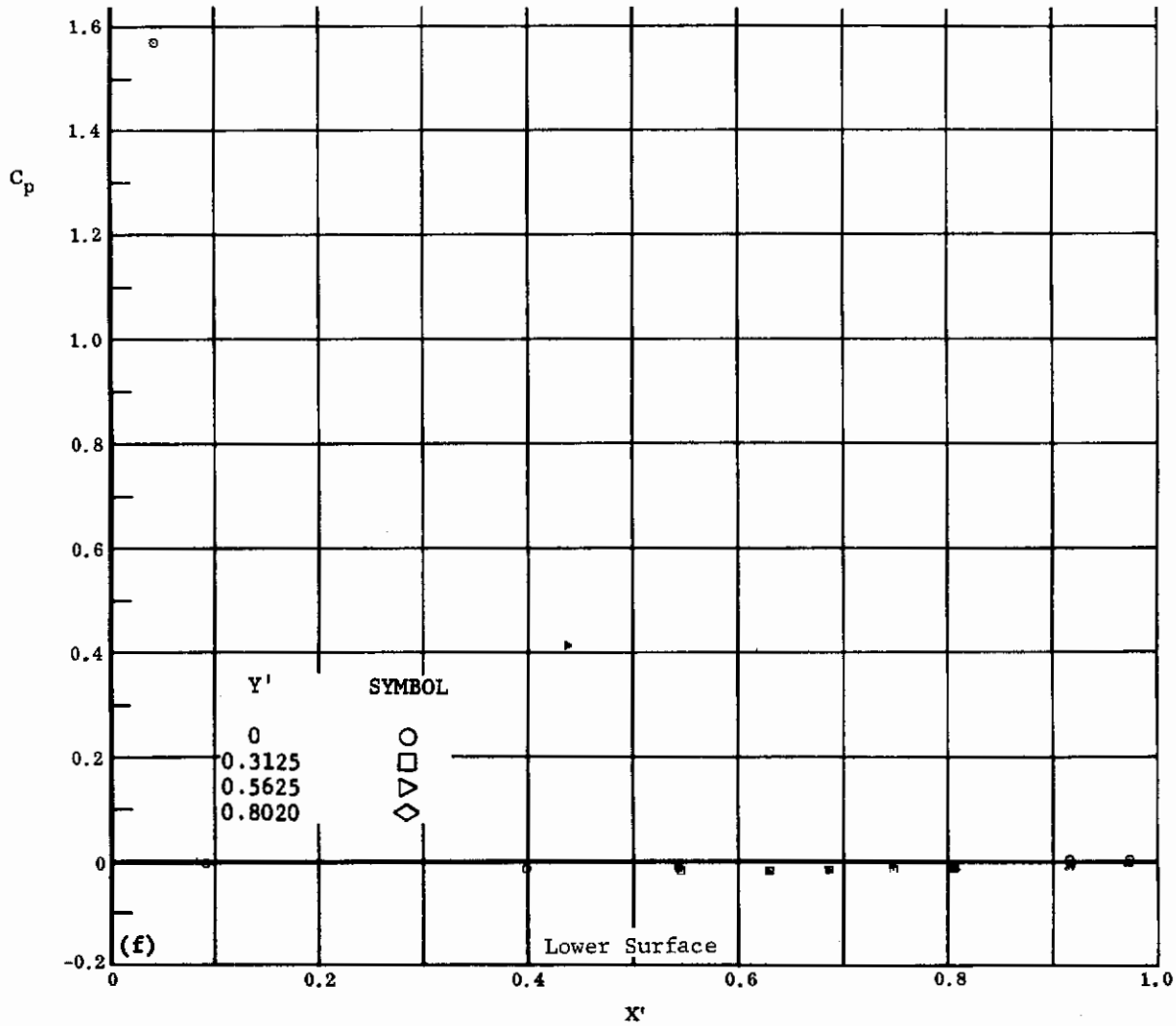

(NONDIMENSIONAL STREAMWISE DISTANCE FROM VIRTUAL APEX)

Fig. 43 Configuration IV, $\alpha = -20$, $\delta_2 = \delta_3 = -20$

e) C_p vs. Y' , lower surface

f) C_p vs. X' , lower surface

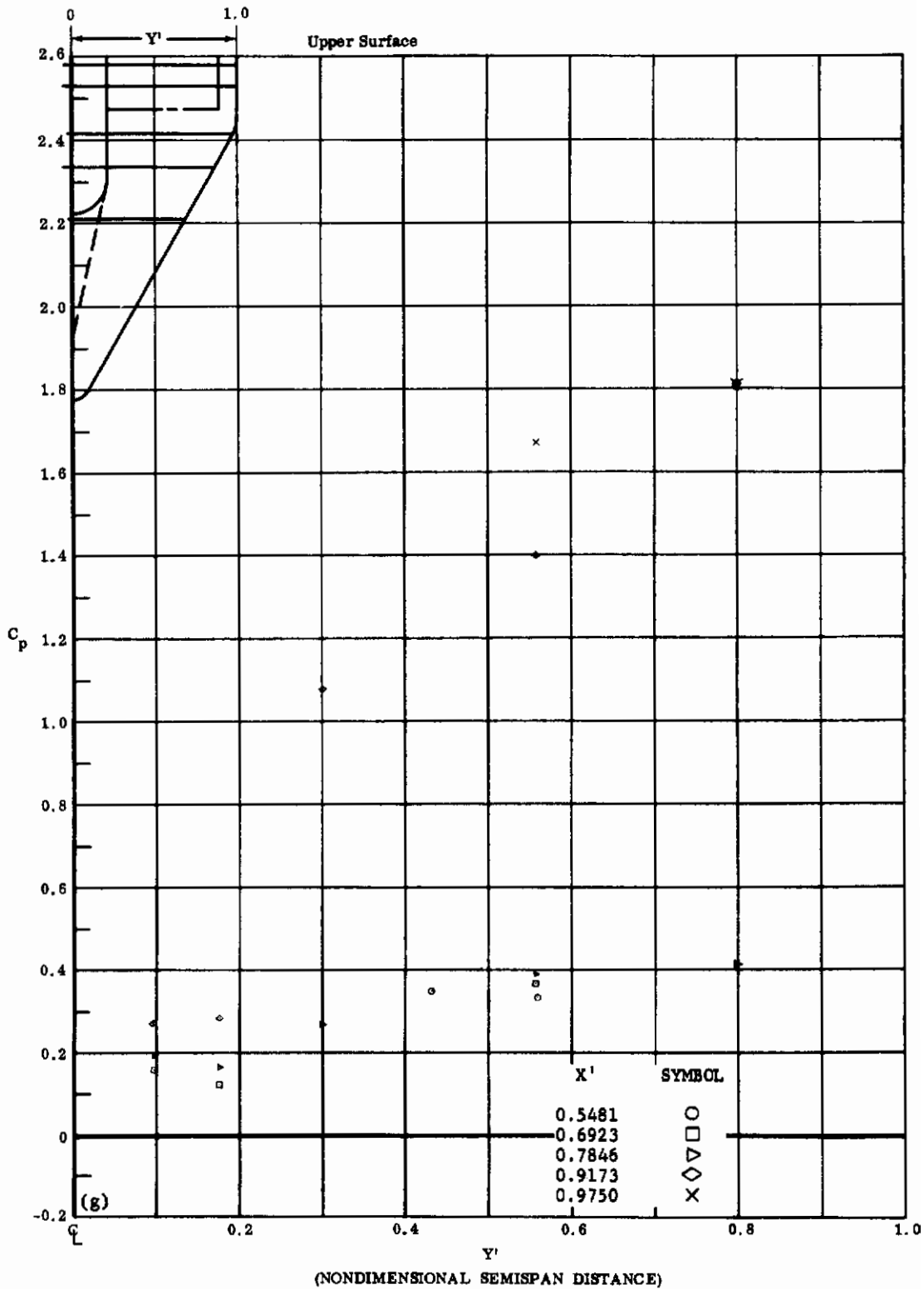
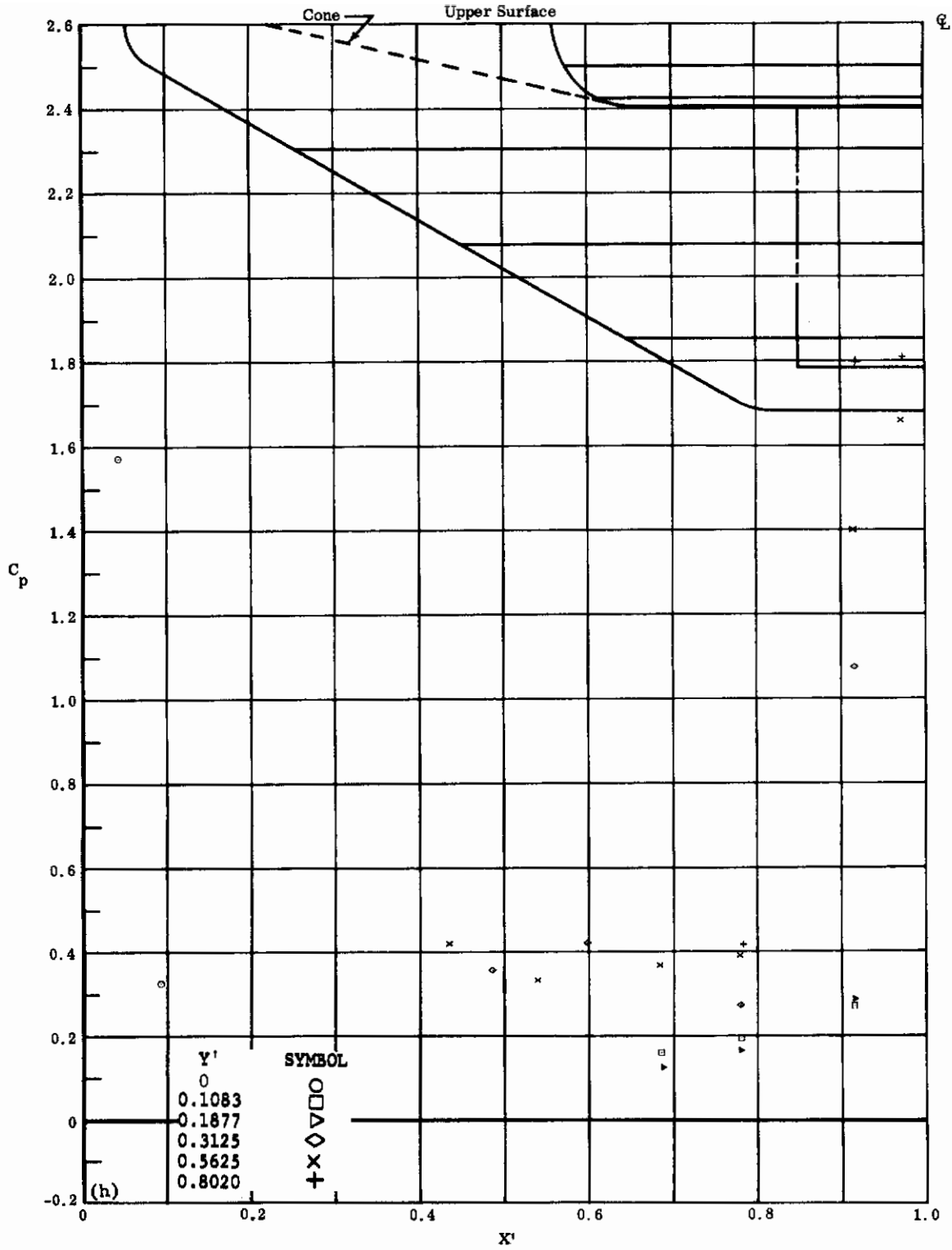

Fig. 43g Configuration IV, $\alpha = -20$, $\delta_2 = \delta_3 = -20$

C_p vs. Y' , upper surface



(NONDIMENSIONAL STREAMWISE DISTANCE FROM VIRTUAL APEX)

Fig. 43h Configuration IV, $\alpha = -20$, $\delta_2 = \delta_3 = -20$

C_p vs. X' , upper surface

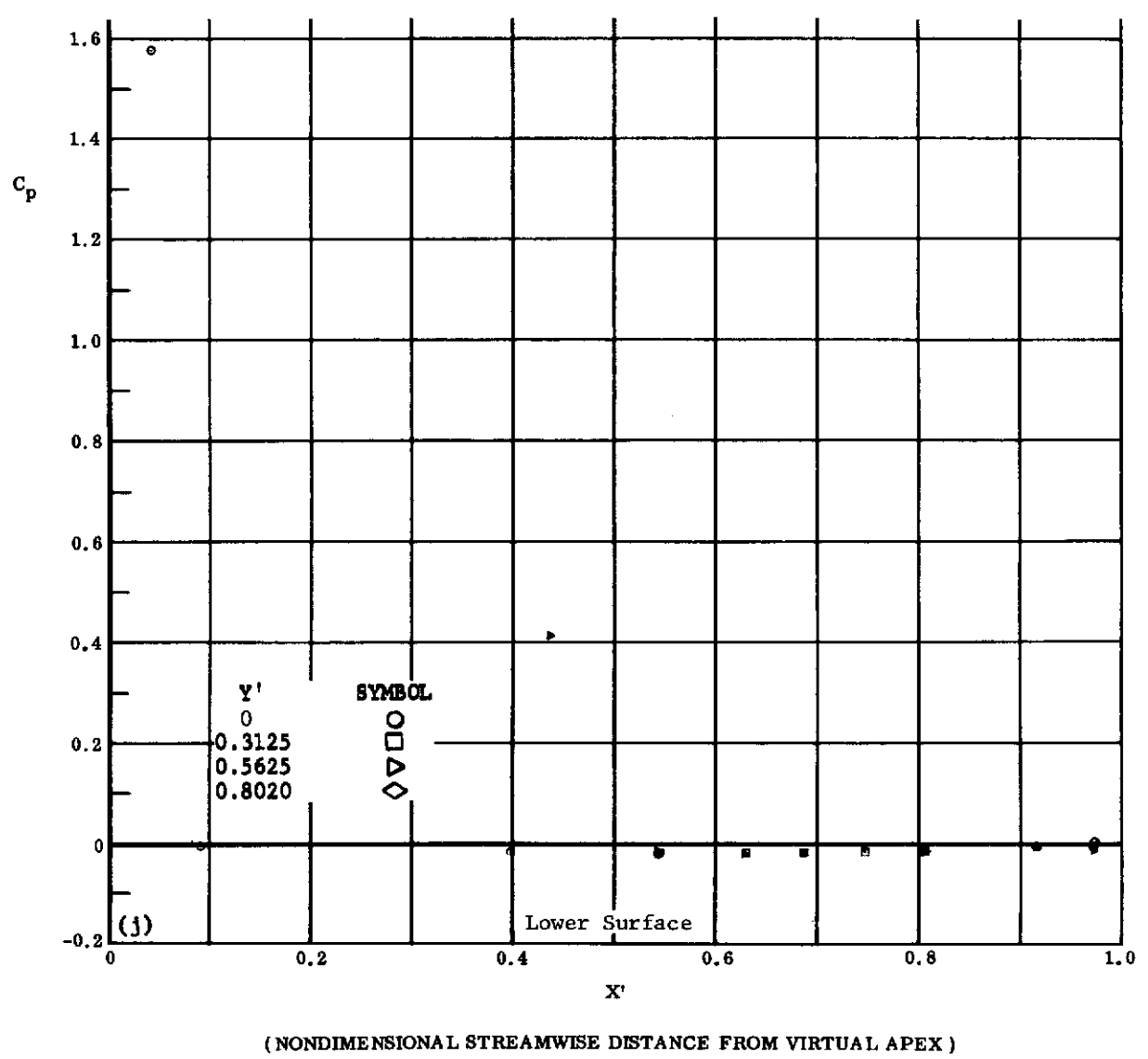
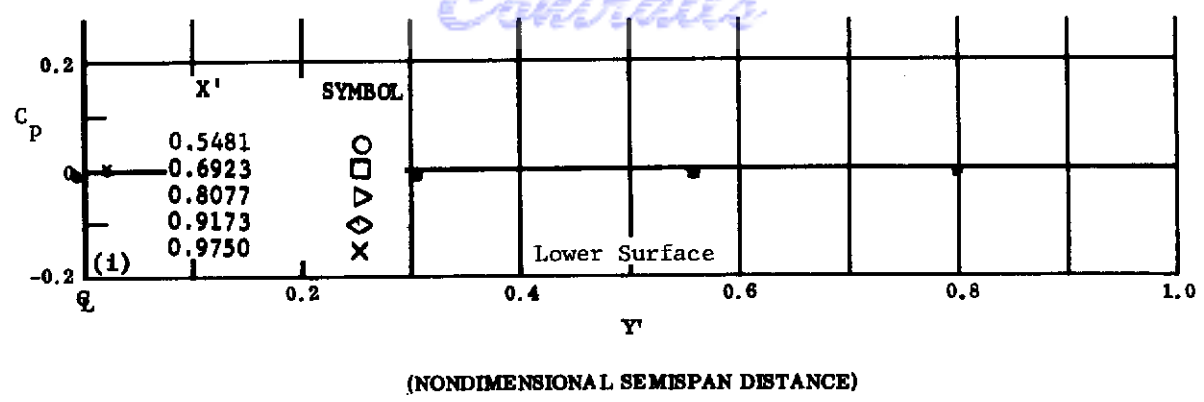

Fig. 43 Configuration IV, $\alpha = -20$, $\delta_2 = \delta_3 = -30$

- i) C_p vs. Y' , lower surface
- j) C_p vs. X' , lower surface

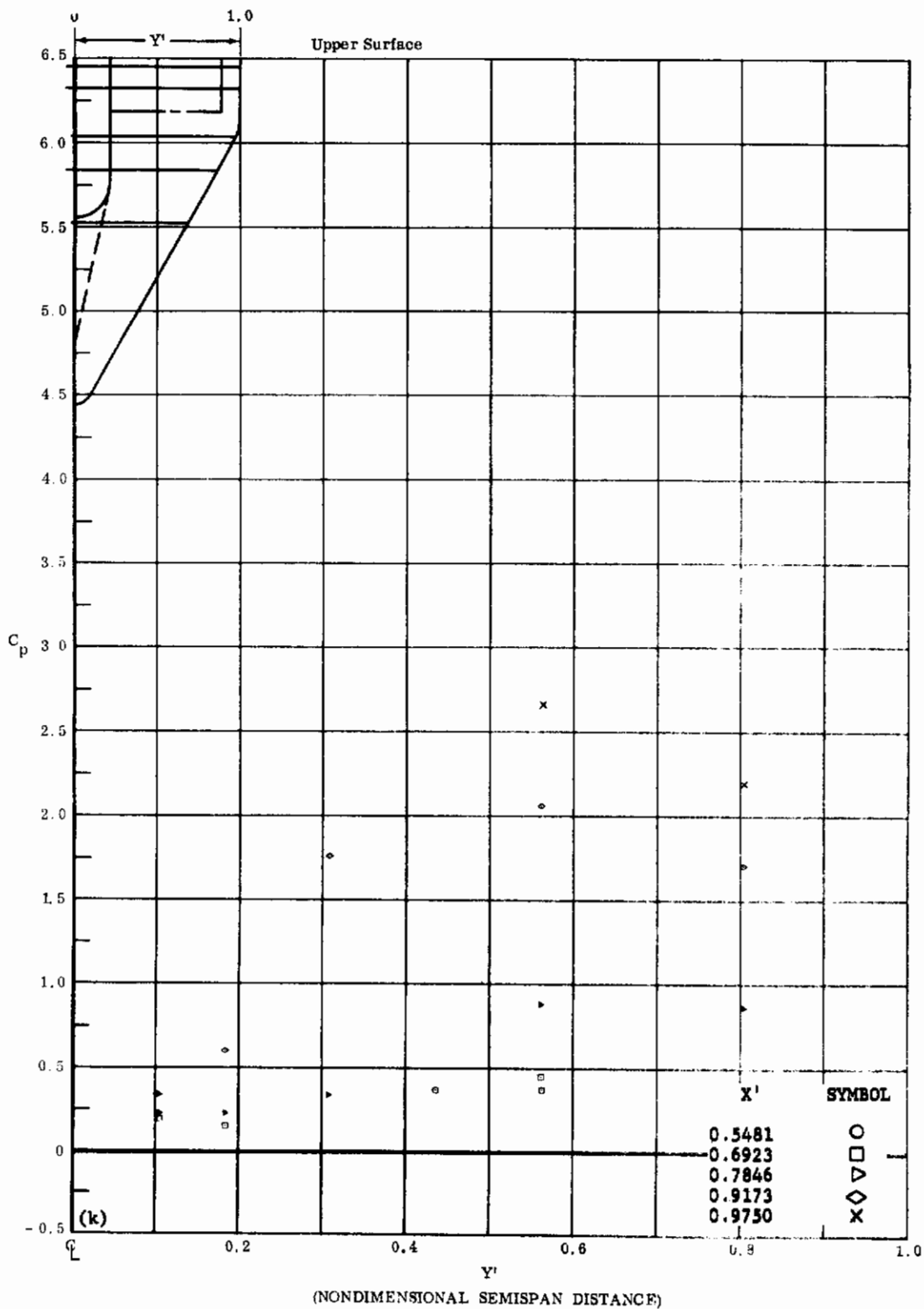
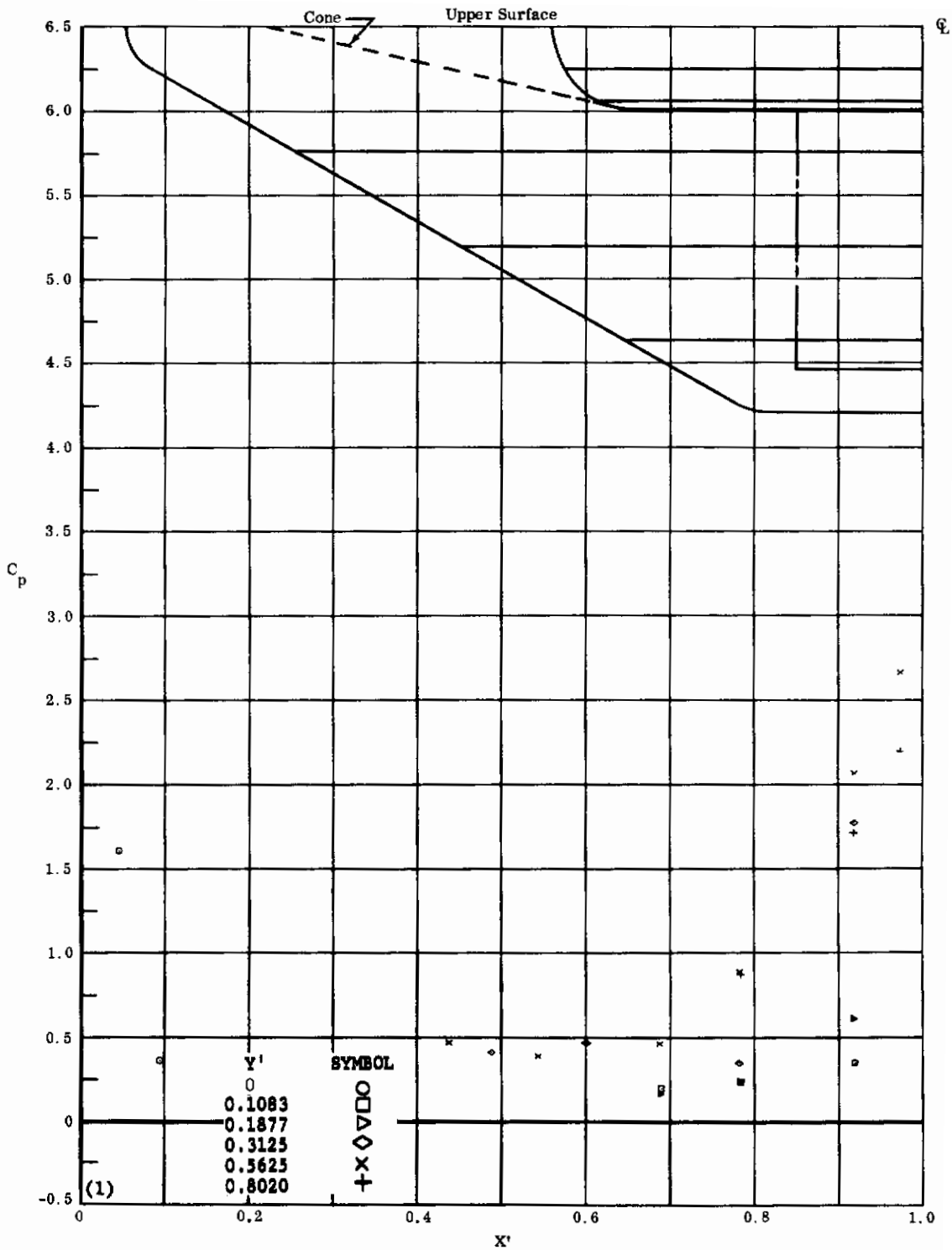

Fig. 43k Configuration IV, $\alpha = -20$, $\delta_2 = \delta_3 = -30$

C_p vs. Y' , upper surface



(NONDIMENSIONAL STREAMWISE DISTANCE FROM VIRTUAL APEX)

Fig. 431 Configuration IV, $\alpha = -20$, $\delta_2 = \delta_3 = -30$

C_p vs. X' , upper surface

Contrails

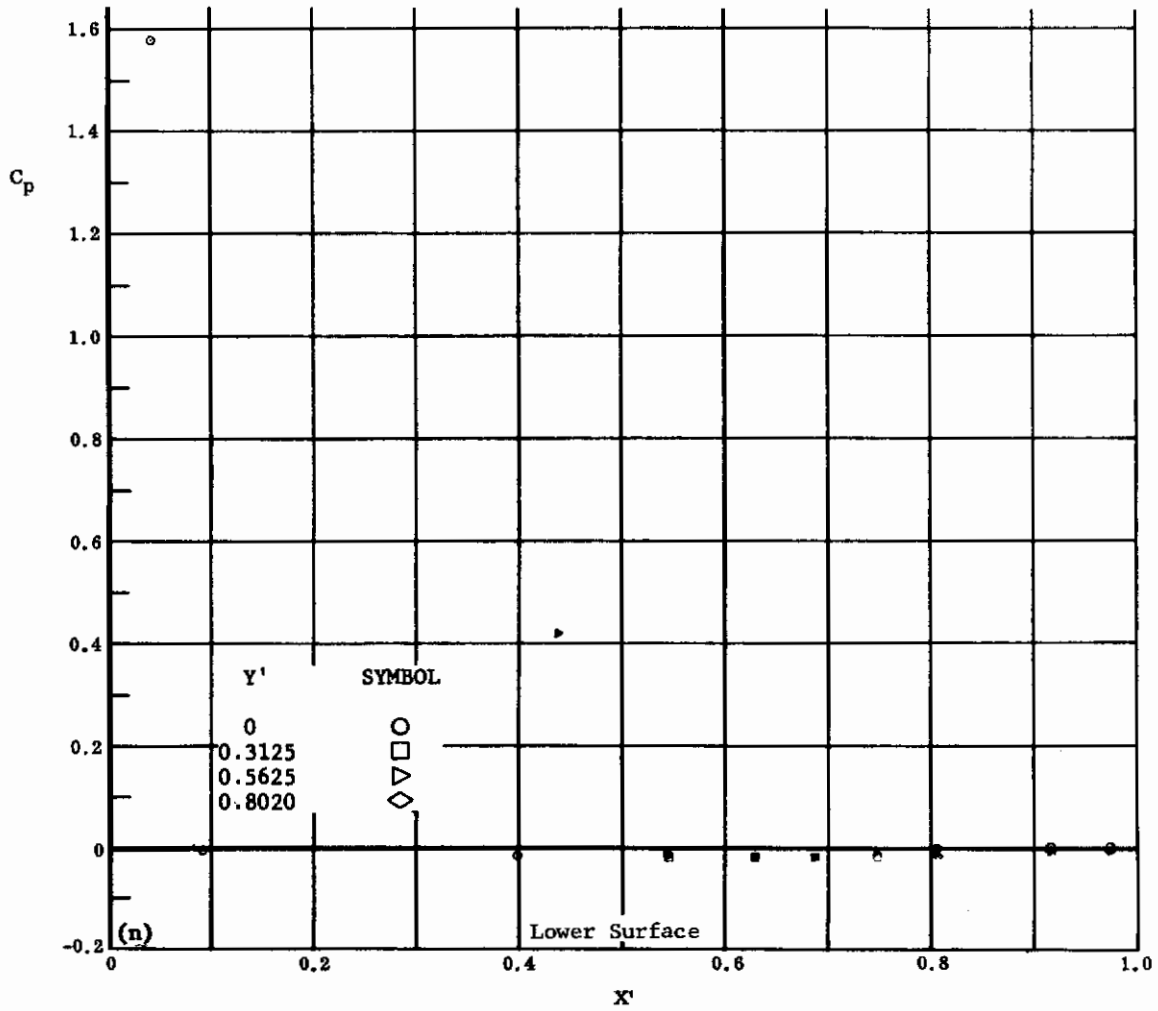
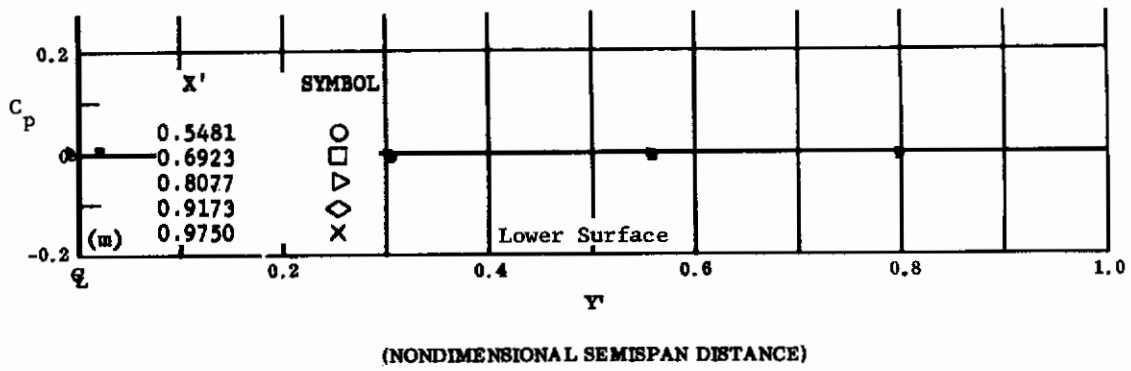

Fig. 43 Configuration IV, $\alpha = -20$, $\delta_2 = \delta_3 = -39$

m) C_p vs. Y' , lower surface

n) C_p vs. X' , lower surface

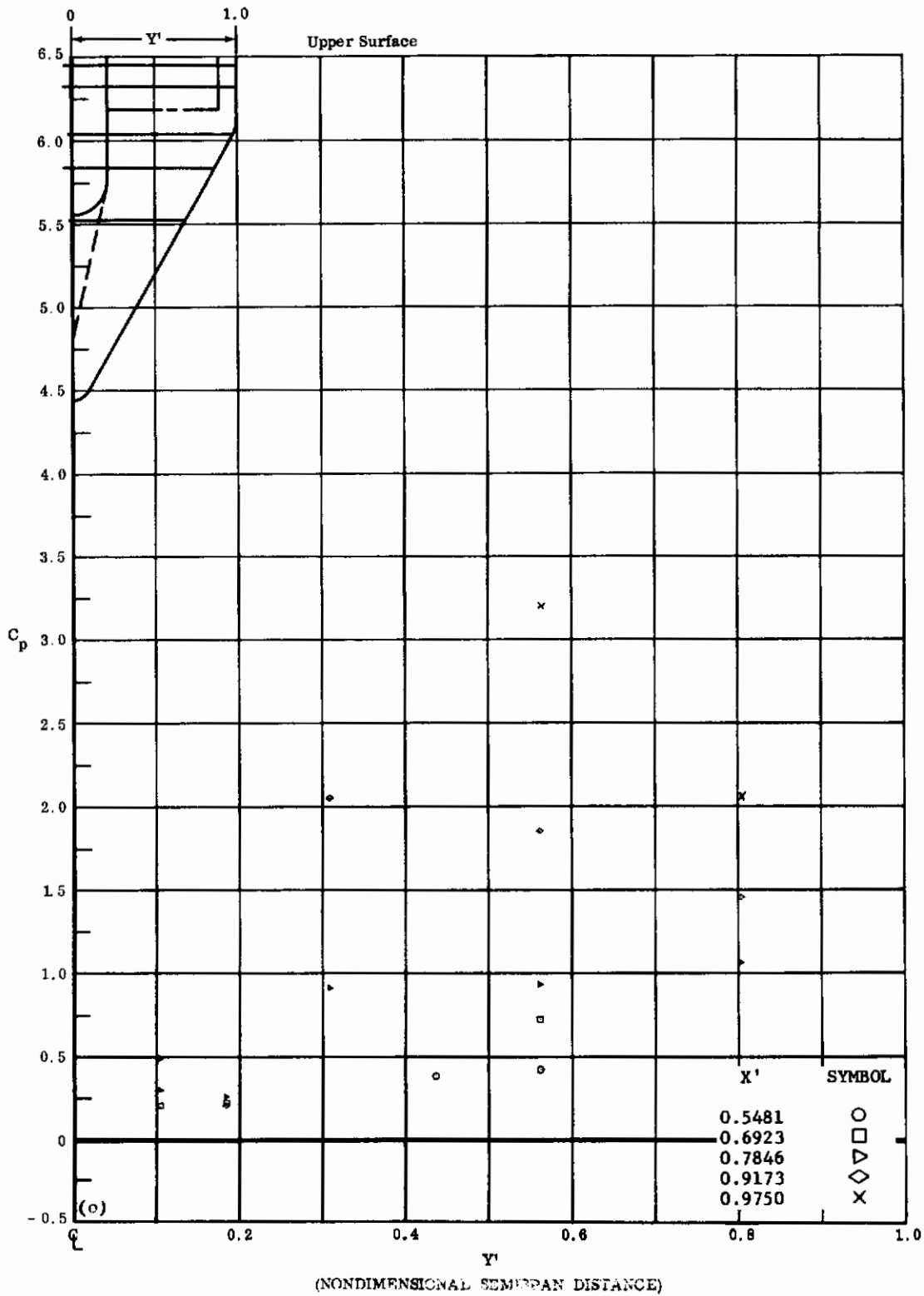
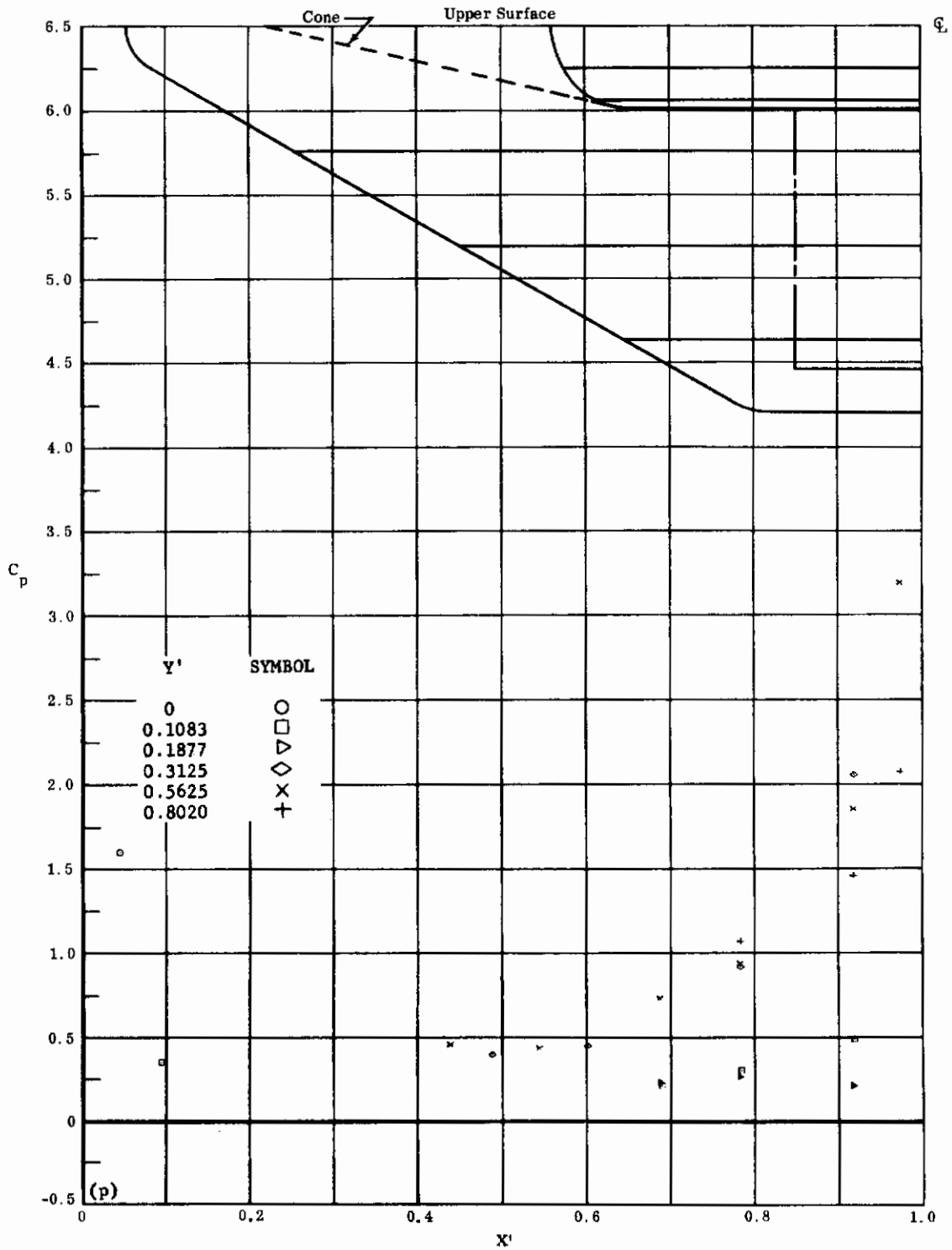

Fig. 43o Configuration IV, $\alpha = -20$, $\delta_2 = \delta_3 = -39$

C_p vs. Y' , upper surface



(NONDIMENSIONAL STREAMWISE DISTANCE FROM VIRTUAL APEX)

Fig. 43p Configuration IV, $\alpha = -20$, $\delta_2 = \delta_3 = -39$

C_p vs. X' , upper surface

Contrails

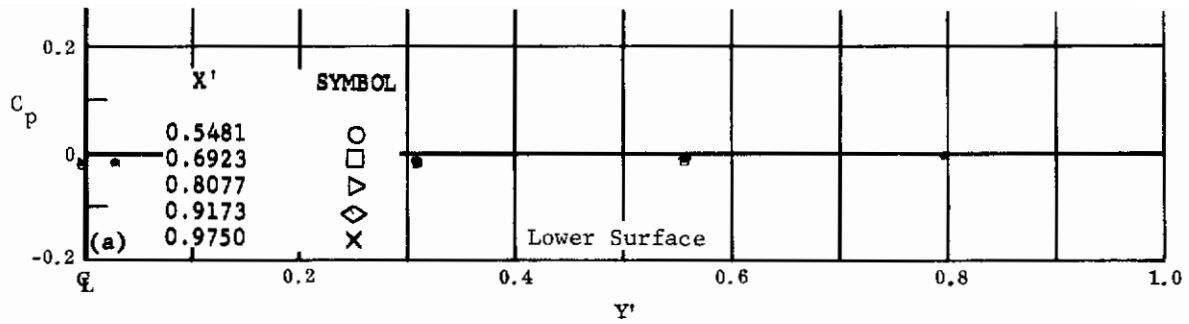

(NONDIMENSIONAL SEMISPAN DISTANCE)

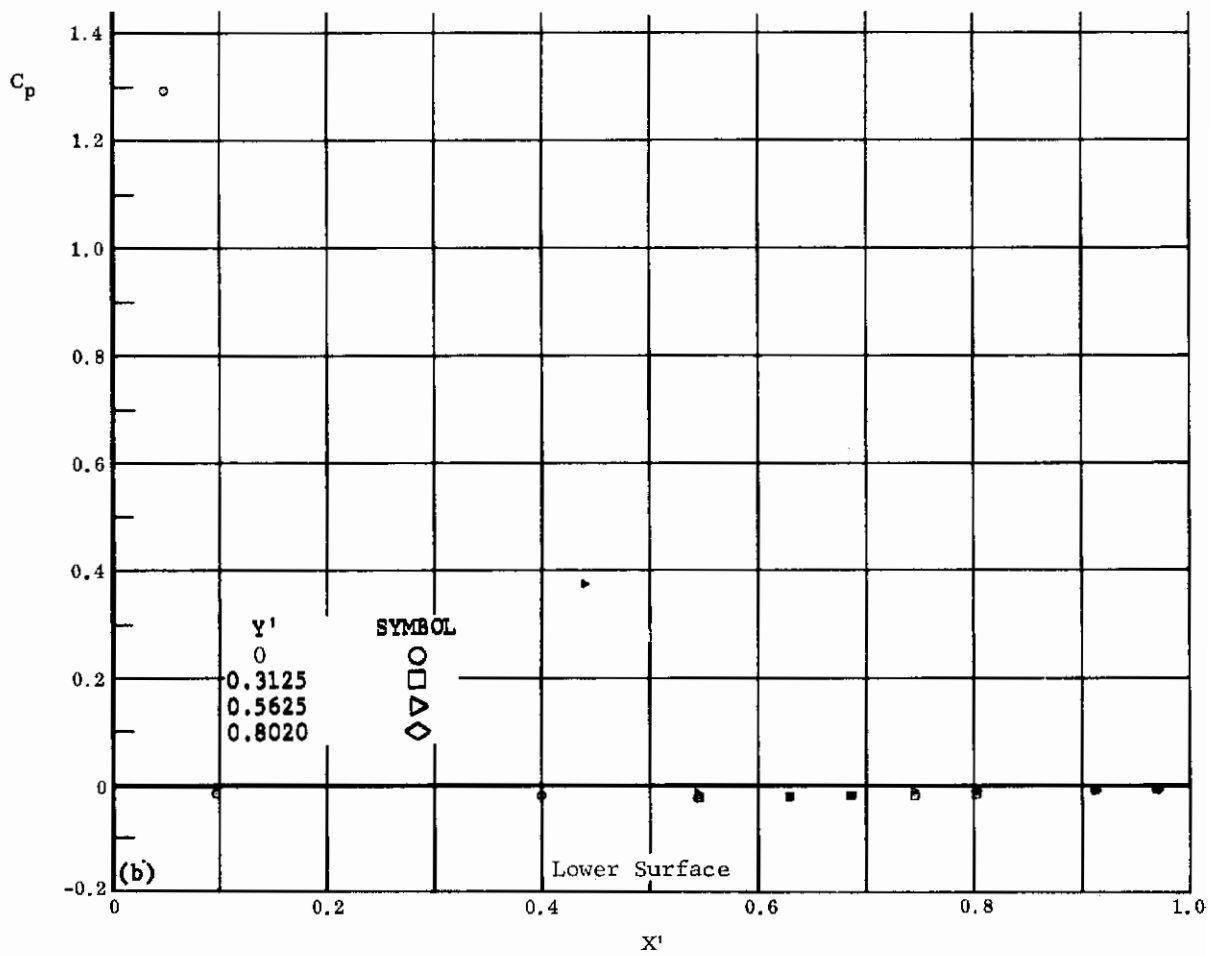

(NONDIMENSIONAL STREAMWISE DISTANCE FROM VIRTUAL APEX)

Fig. 44 Configuration IV, $\alpha = -30$, $\delta_2 = \delta_3 = 0$

a) C_p vs. Y', lower surface

b) C_p vs. X', lower surface

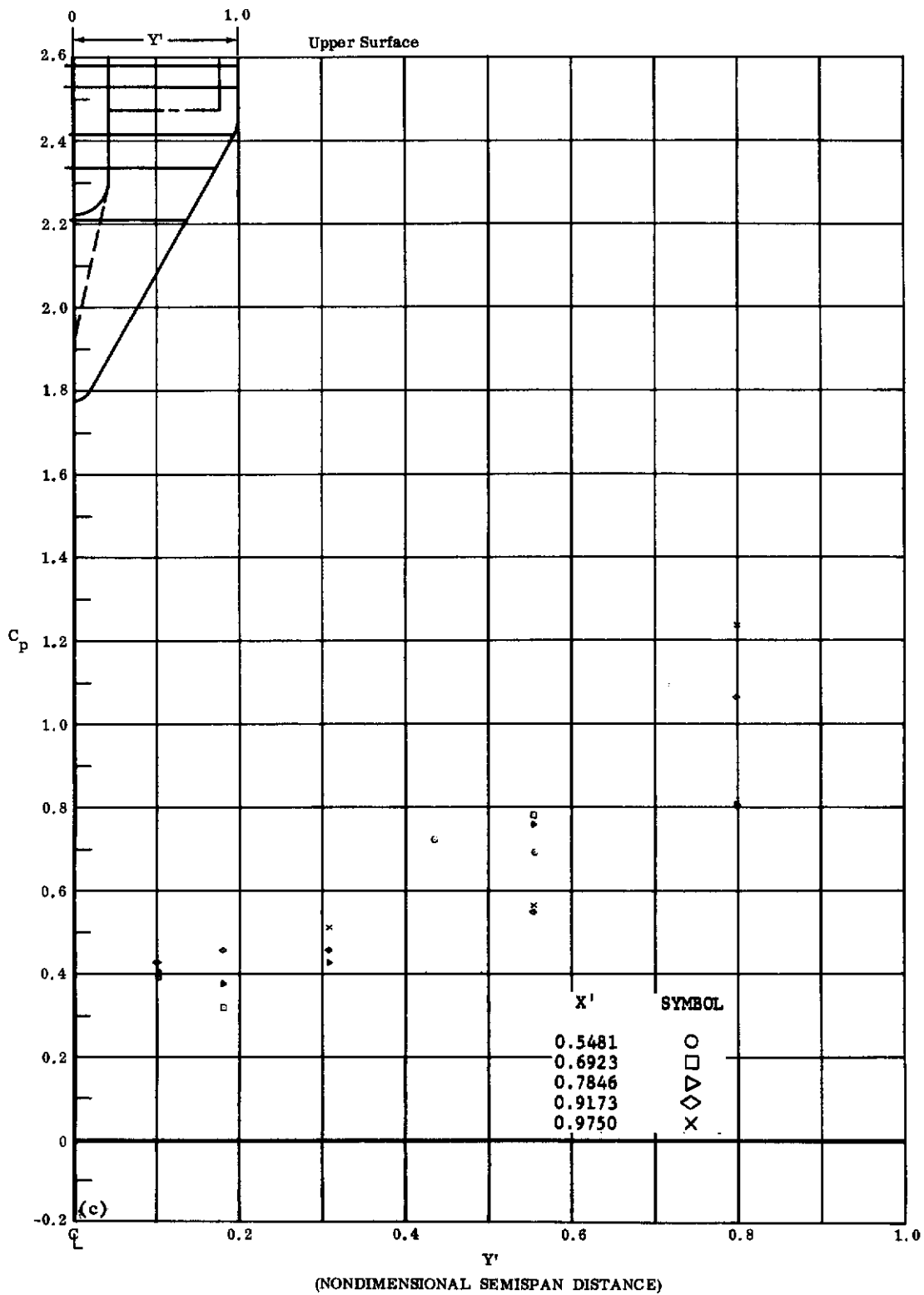
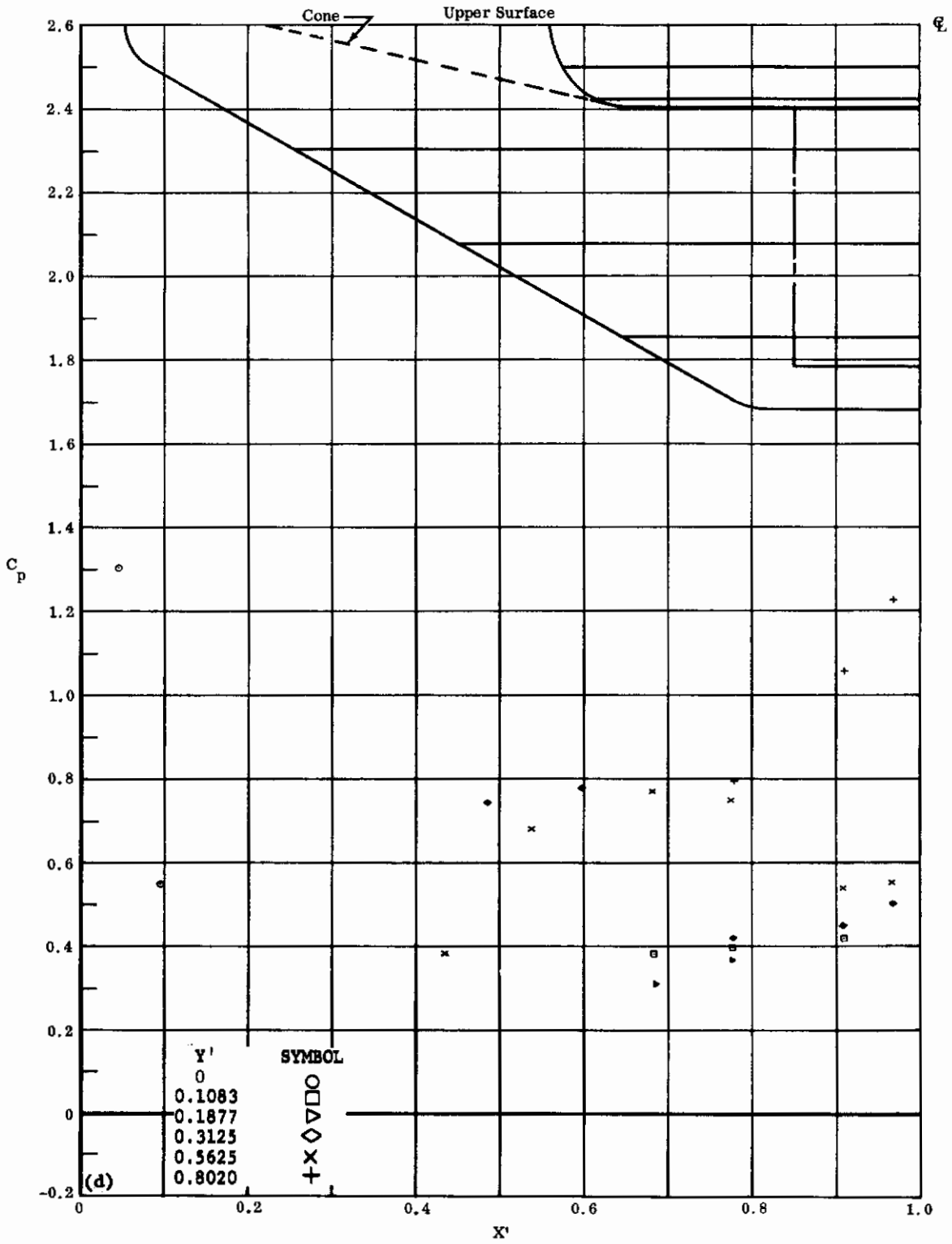

Fig. 44c Configuration IV, $\alpha = -30$, $\delta_2 = \delta_3 = 0$

C_p vs. Y' , upper surface



(NONDIMENSIONAL STREAMWISE DISTANCE FROM VIRTUAL APEX)

Fig. 44d Configuration IV, $\alpha = -30$, $\delta_2 = \delta_3 = 0$

C_p vs. X' , upper surface

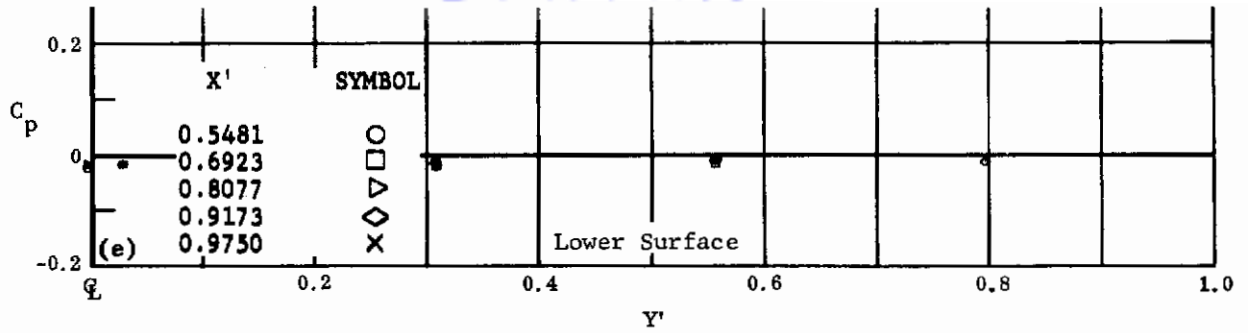

(NONDIMENSIONAL SEMISPAN DISTANCE)

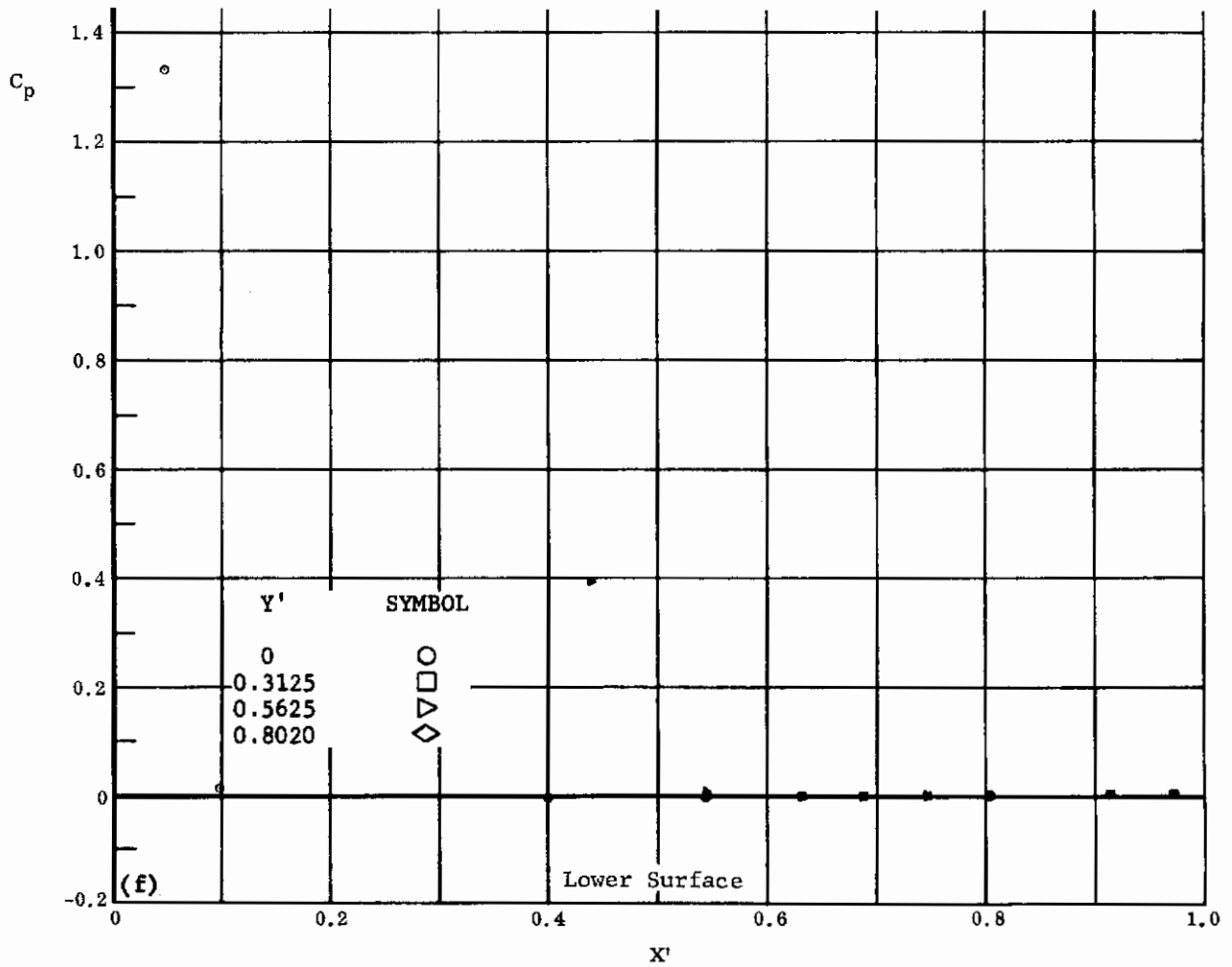

(NONDIMENSIONAL STREAMWISE DISTANCE FROM VIRTUAL APEX)

Fig. 44 Configuration IV, $\alpha = -30$, $\delta_2 = \delta_3 = +20$

e) C_p vs. Y' , lower surface

f) C_p vs. X' , lower surface

Contrails

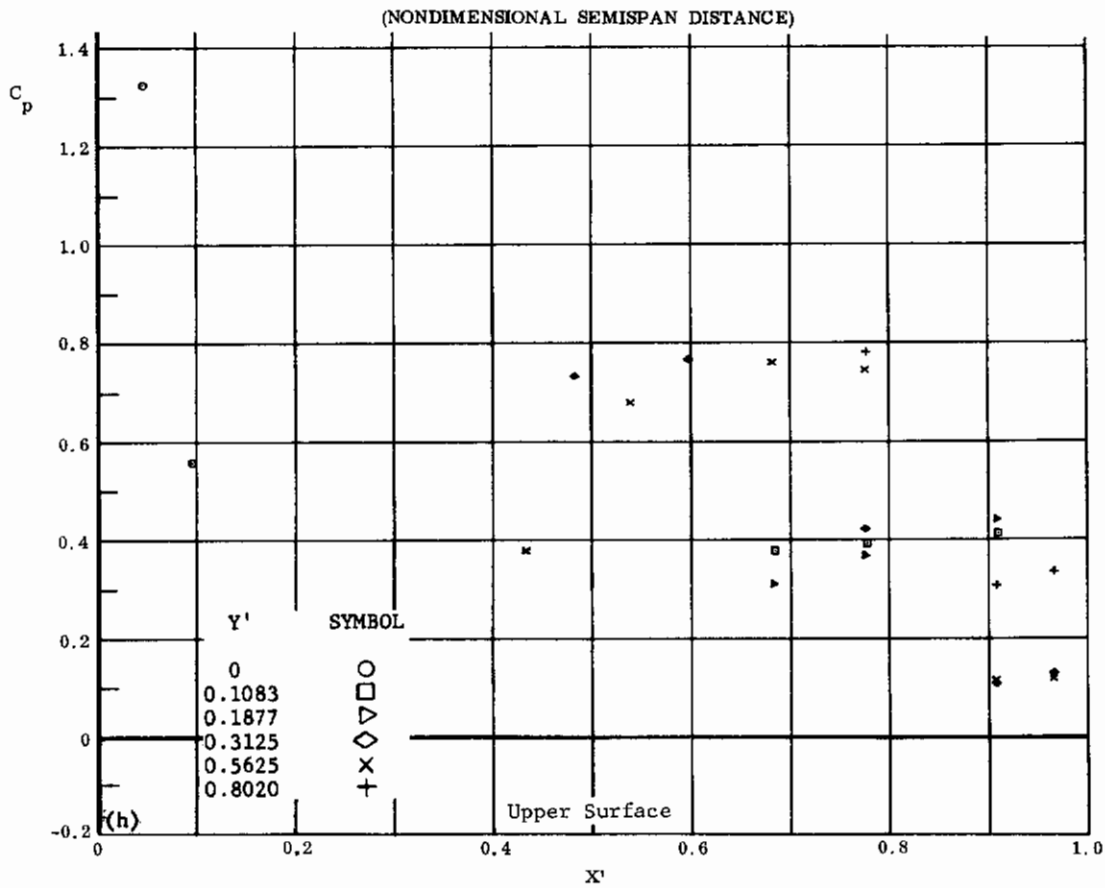
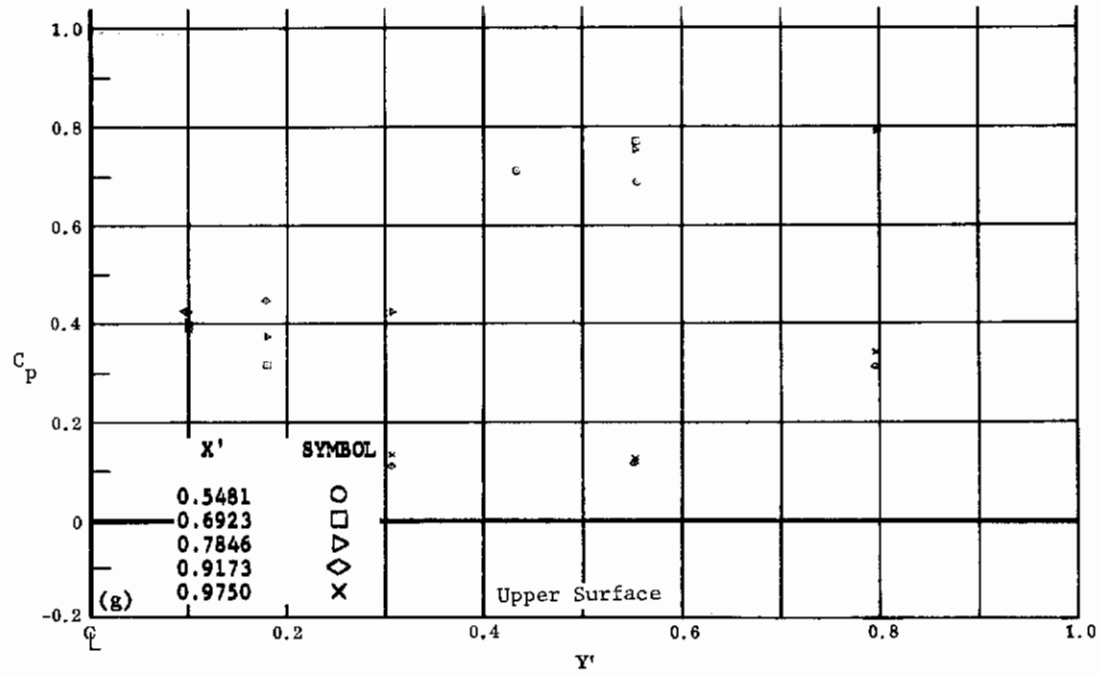

(NONDIMENSIONAL STREAMWISE DISTANCE FROM VIRTUAL APEX)

Fig. 44 Configuration IV, $\alpha = -30$, $\delta_2 = \delta_3 = +20$

g) C_p vs. Y' , upper surface

h) C_p vs. X' , upper surface

Contrails

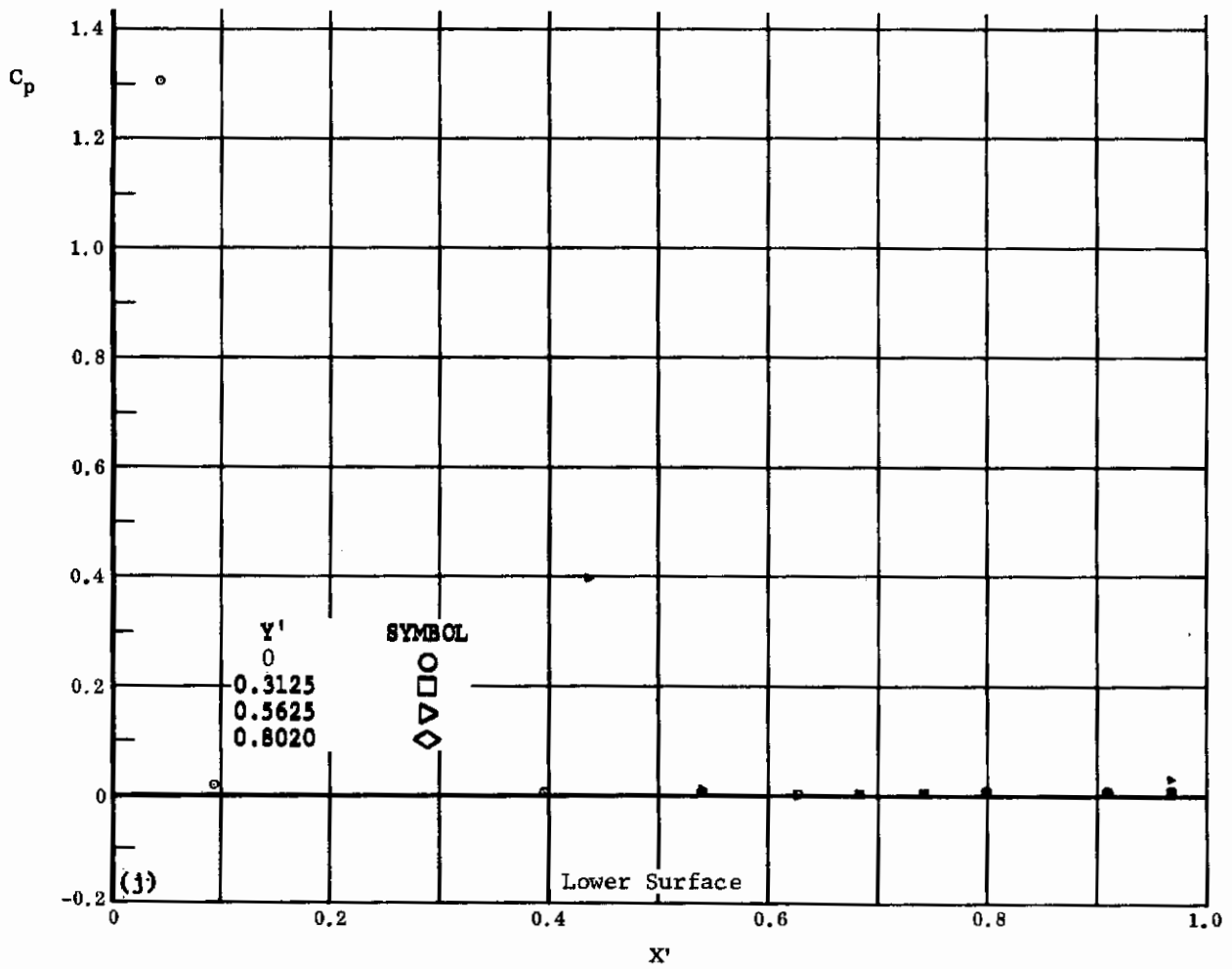
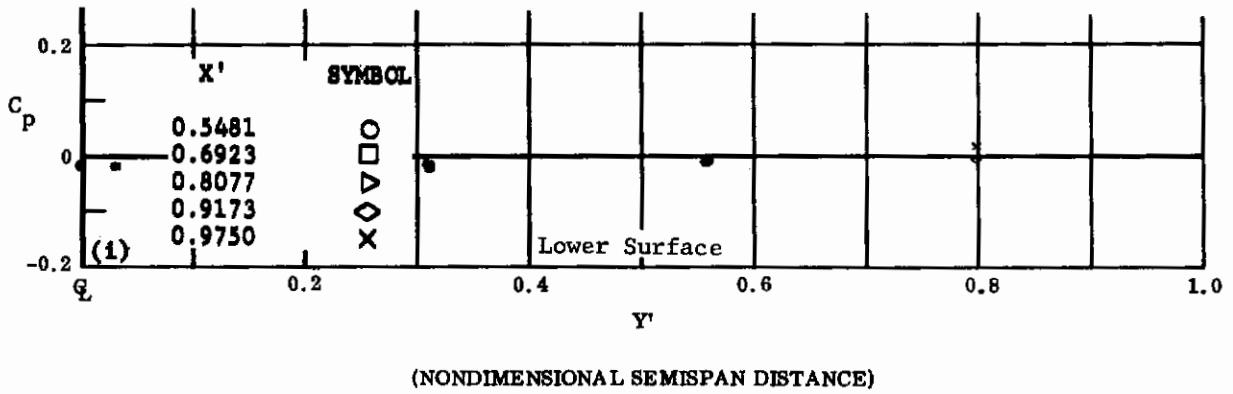
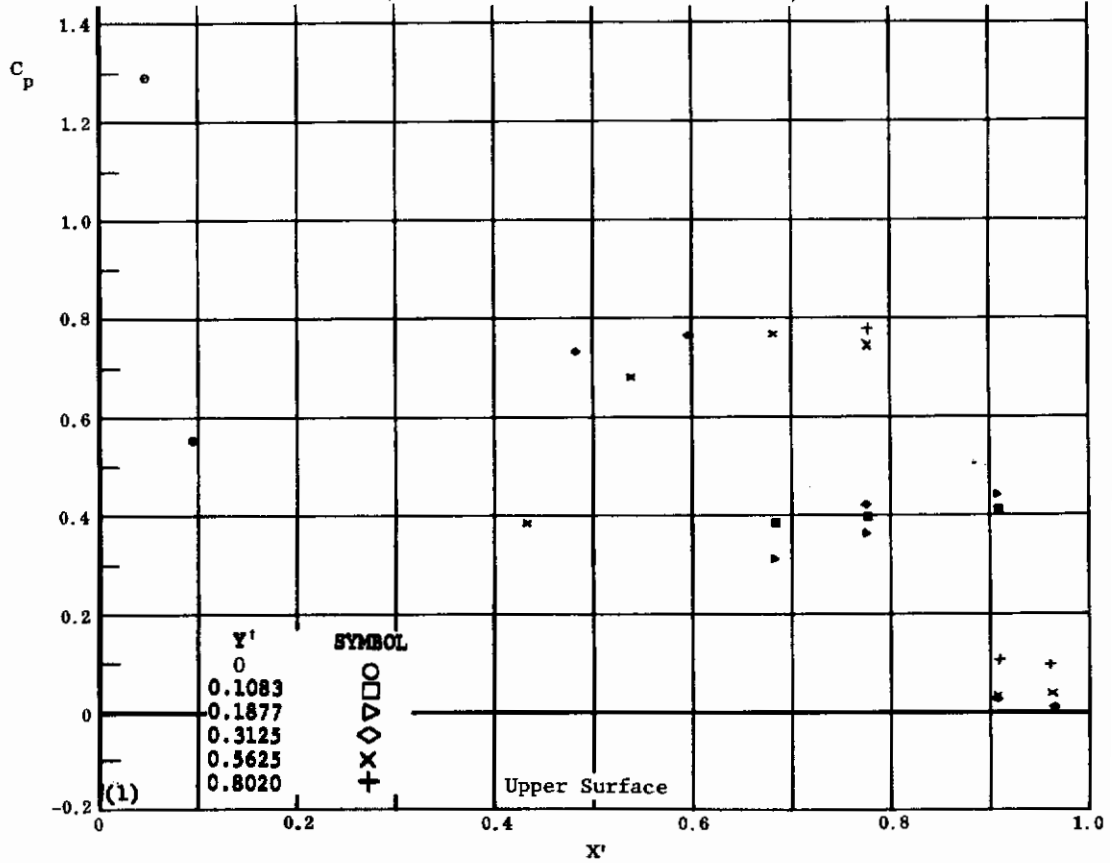
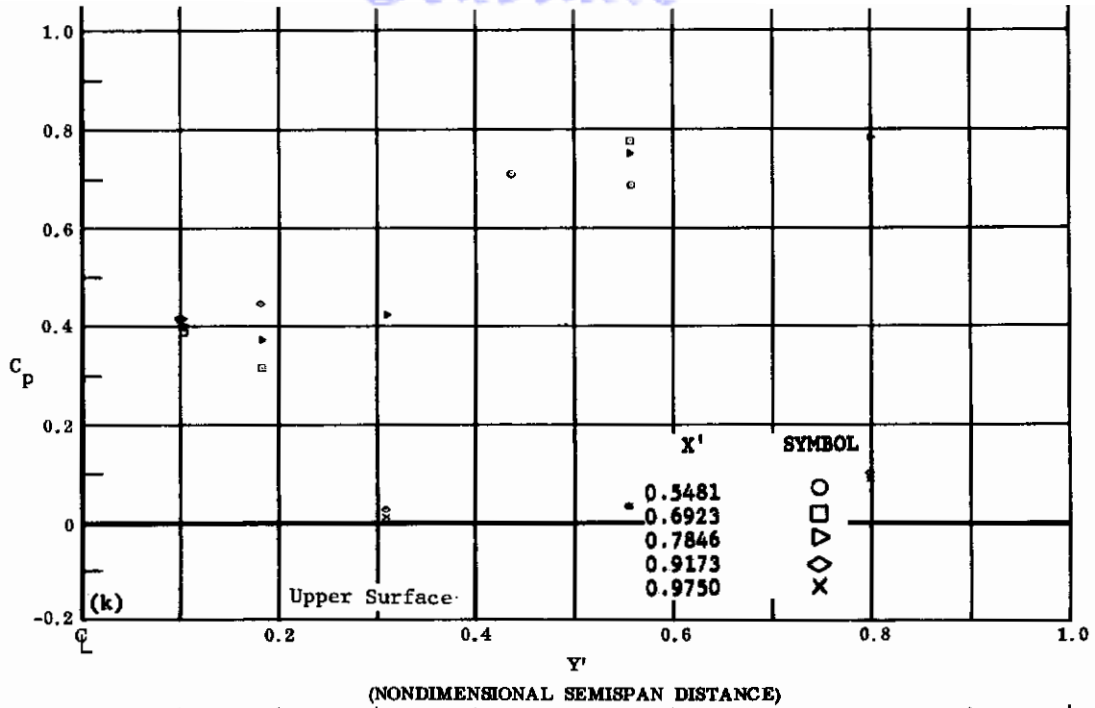

Fig. 44 Configuration IV, $\alpha = -30$, $\delta_2 = \delta_3 = +39$

i) C_p vs. Y' , lower surface

j) C_p vs. X' , lower surface

Contrails



(NONDIMENSIONAL STREAMWISE DISTANCE FROM VIRTUAL APEX)

Fig. 44 Configuration IV, $\alpha = -30$, $\delta_2 = \delta_3 = +39$

k) C_p vs. Y' , upper surface

l) C_p vs. X' , upper surface

Contrails

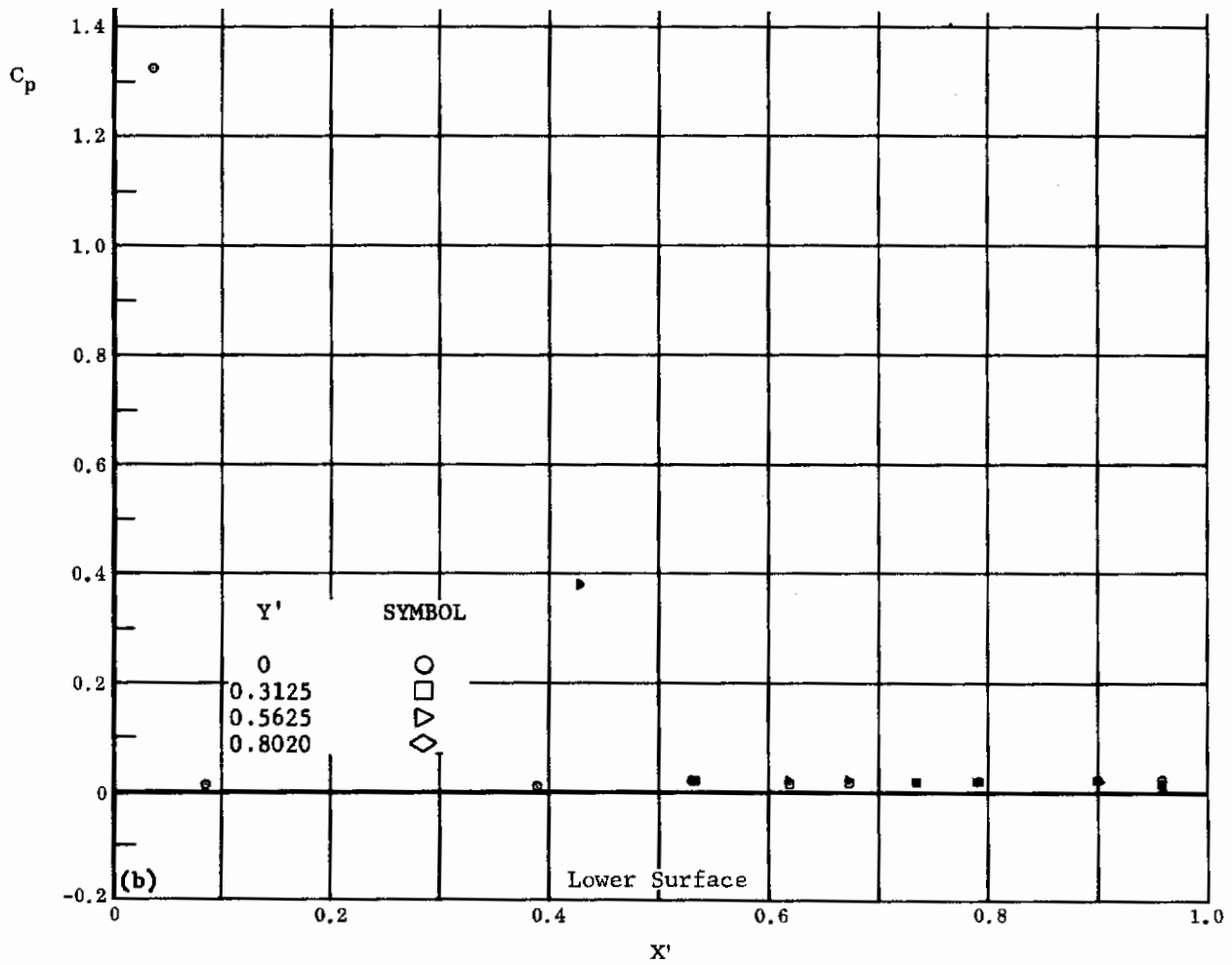
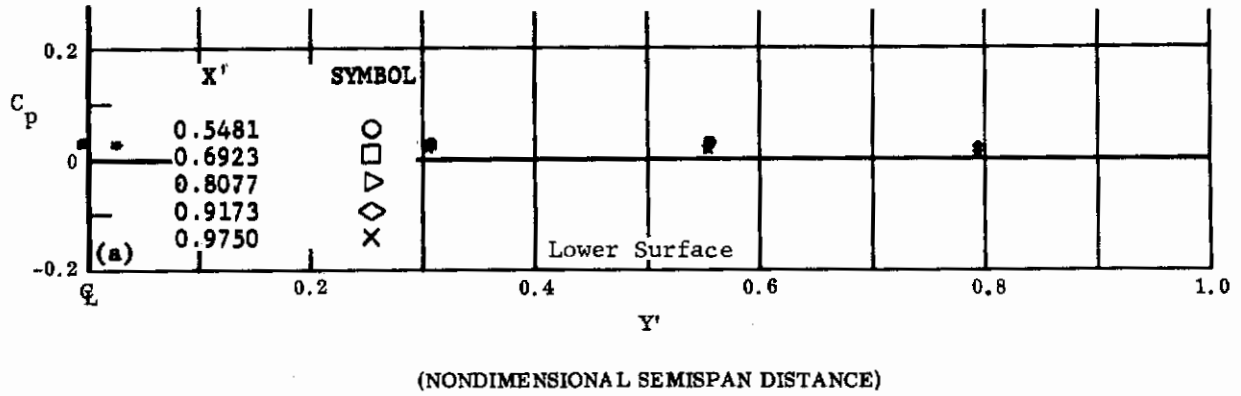

Fig. 45 Configuration IV, $\alpha = -30$, $\delta_2 = \delta_3 = -10$

a) C_p vs. Y' , lower surface

b) C_p vs. X' , lower surface

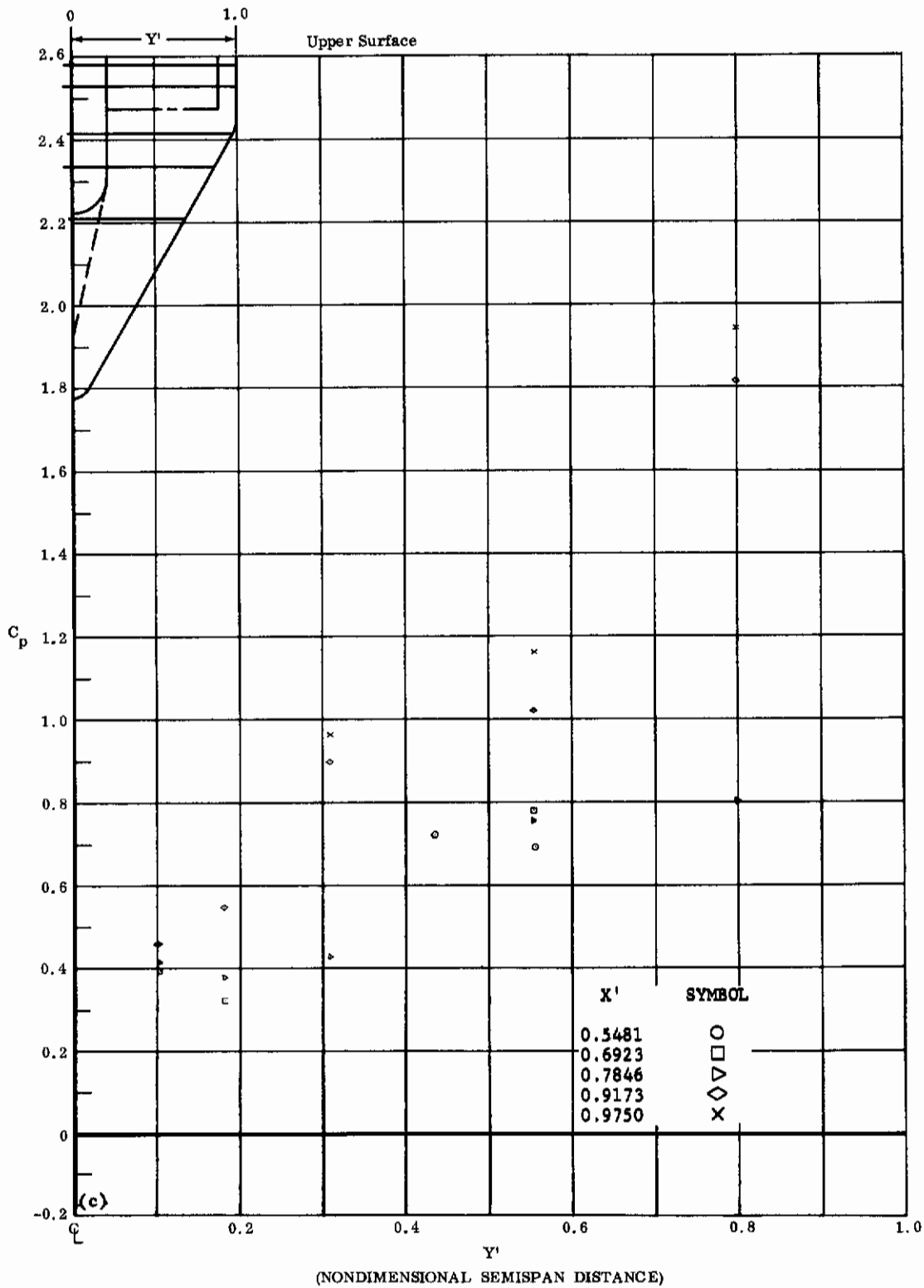
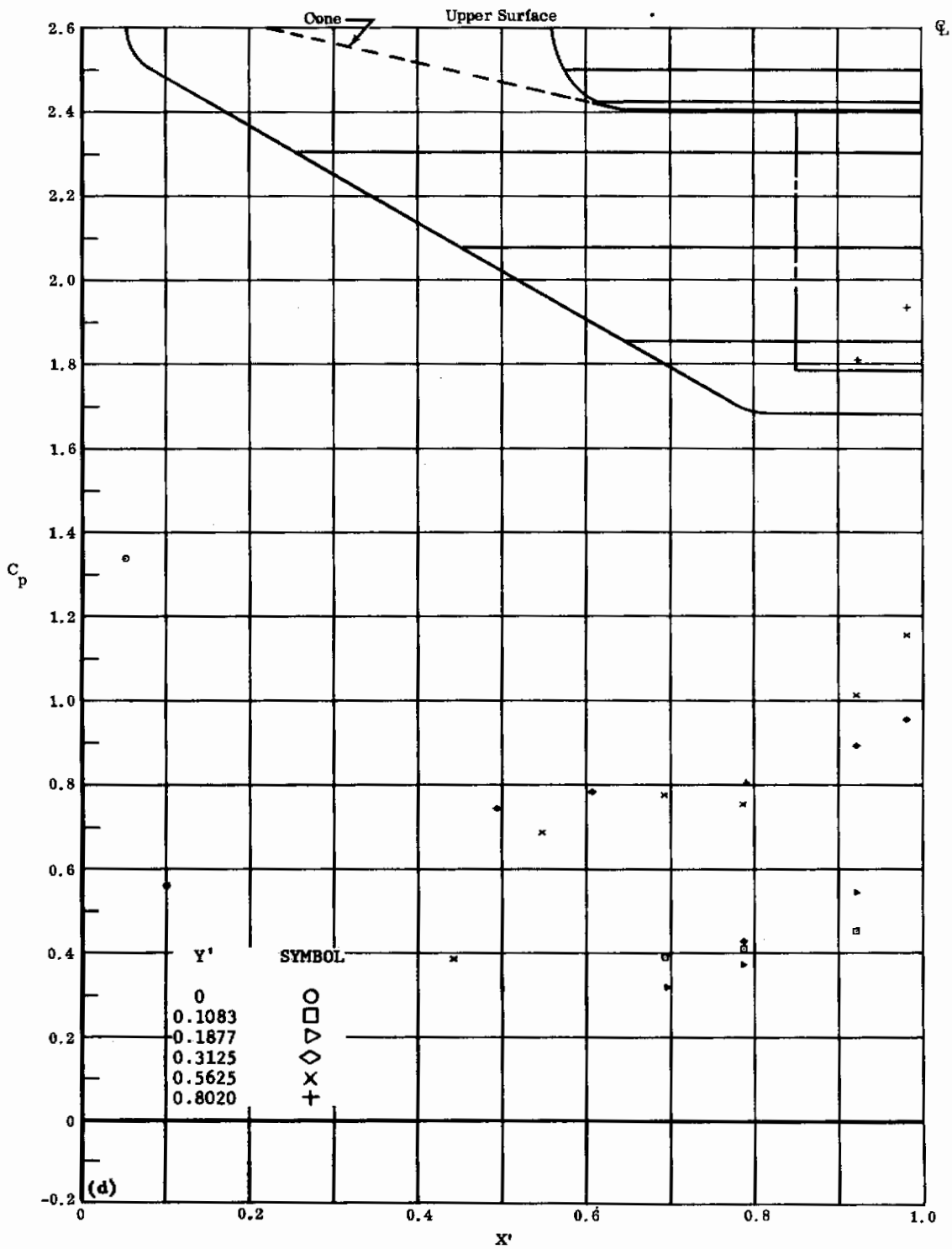

Fig. 45c Configuration IV, $\alpha = -30$, $\delta_2 = \delta_3 = -10$

C_p vs. Y' , upper surface



(NONDIMENSIONAL STREAMWISE DISTANCE FROM VIRTUAL APEX)

Fig. 45d Configuration IV, $\alpha = -30$, $\delta_2 = \delta_3 = -10$

C_p vs. X' , upper surface

Contrails

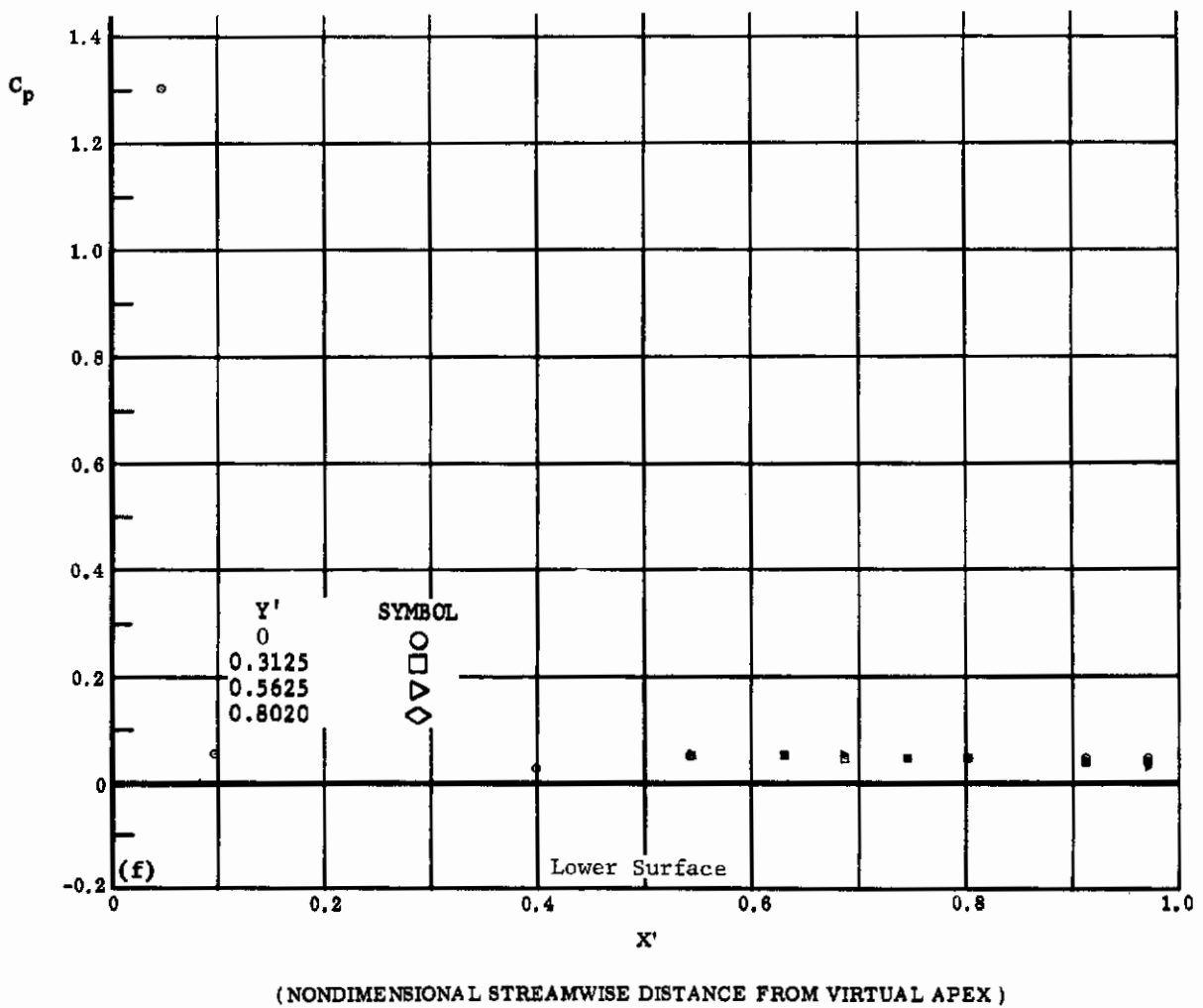
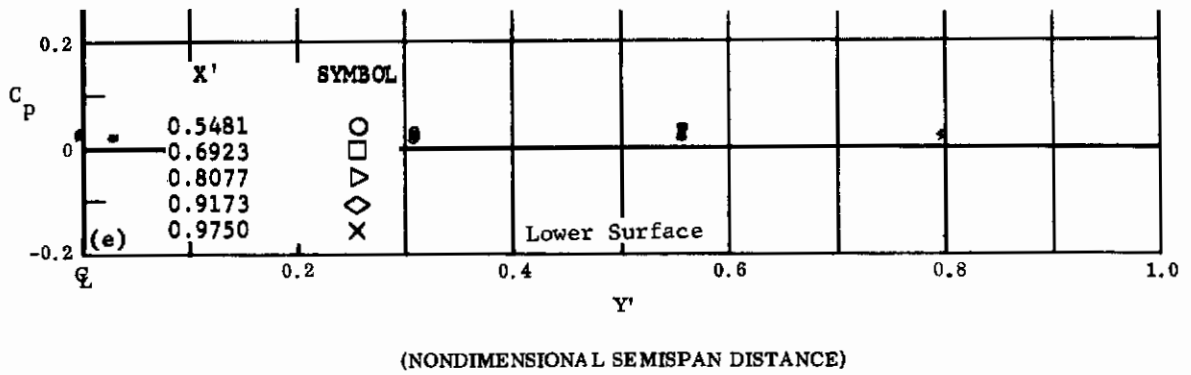

Fig. 45 Configuration IV, $\alpha = -30$, $\delta_2 = \delta_3 = -20$

e) C_p vs. Y' , lower surface

f) C_p vs. X' , lower surface

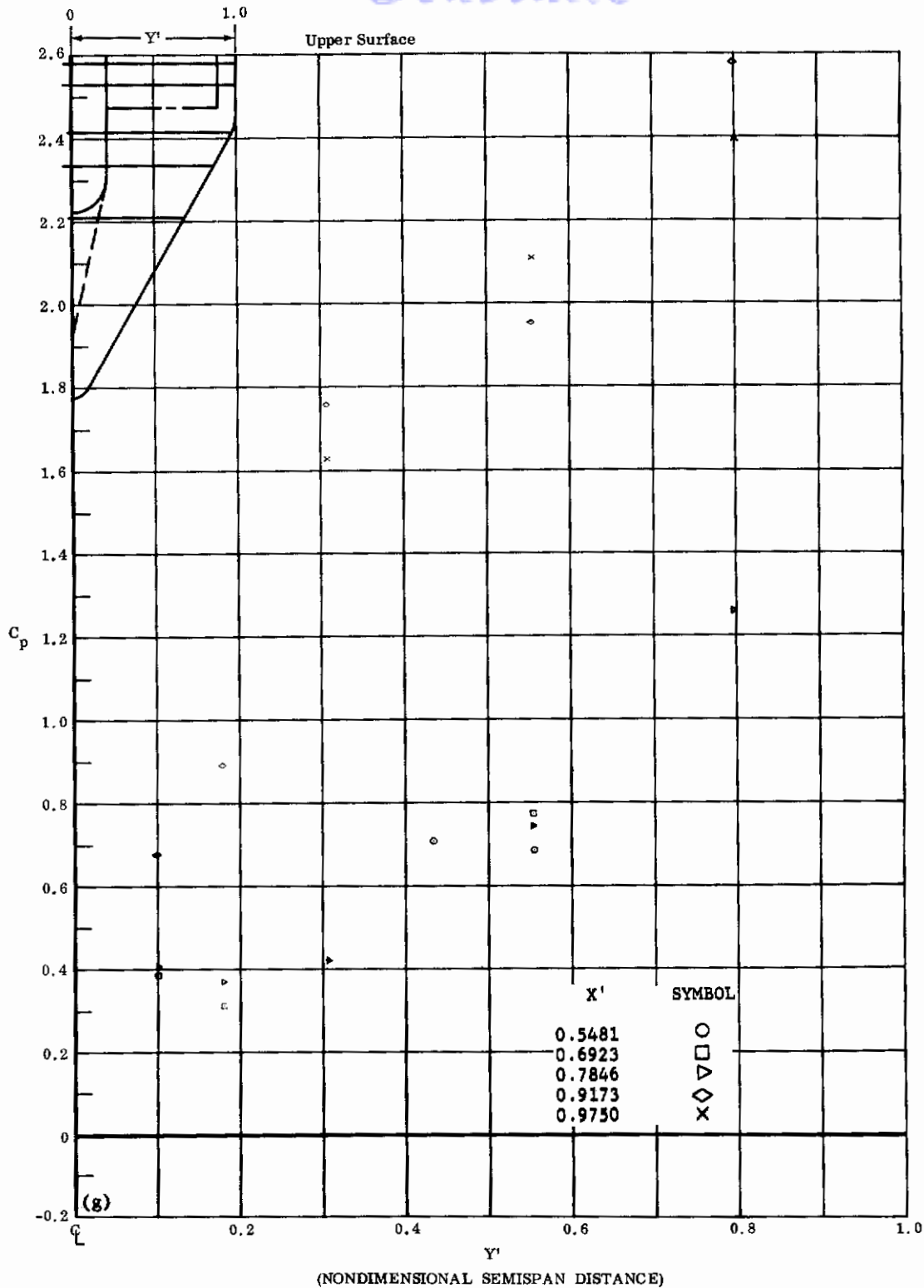
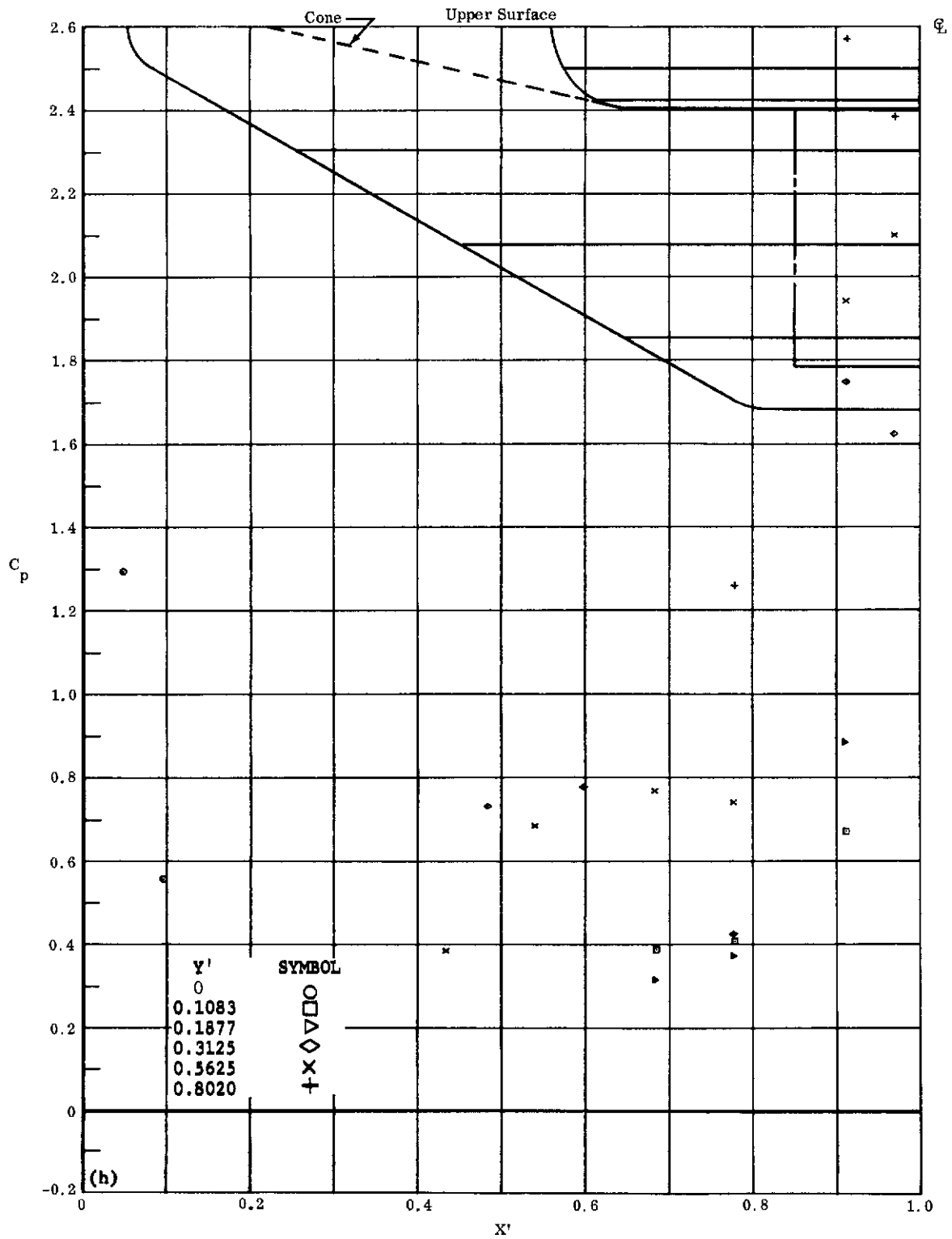

Fig. 45g Configuration IV, $\alpha = -30$, $\delta_2 = \delta_3 = -20$

C_p vs. Y' , upper surface



(NONDIMENSIONAL STREAMWISE DISTANCE FROM VIRTUAL APEX)

Fig. 45h Configuration IV, $\alpha = -30$, $\delta_2 = \delta_3 = -20$

C_p vs. X' , upper surface

Contrails

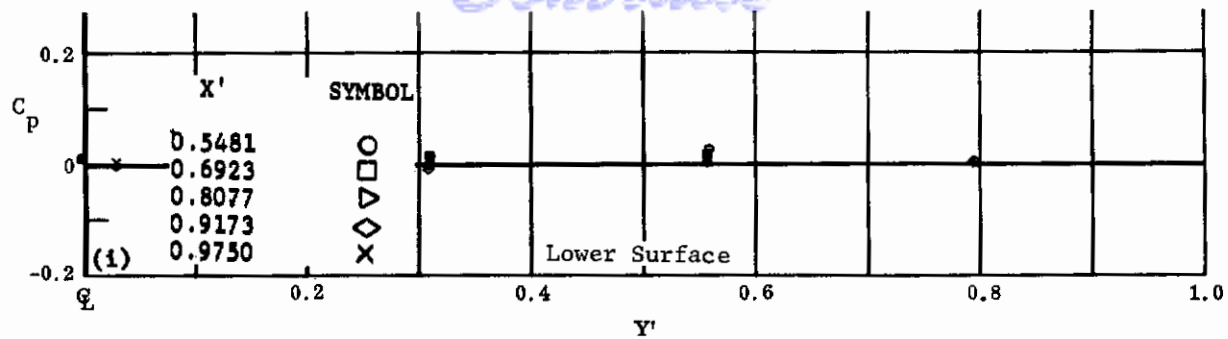

(NONDIMENSIONAL SEMISPAN DISTANCE)

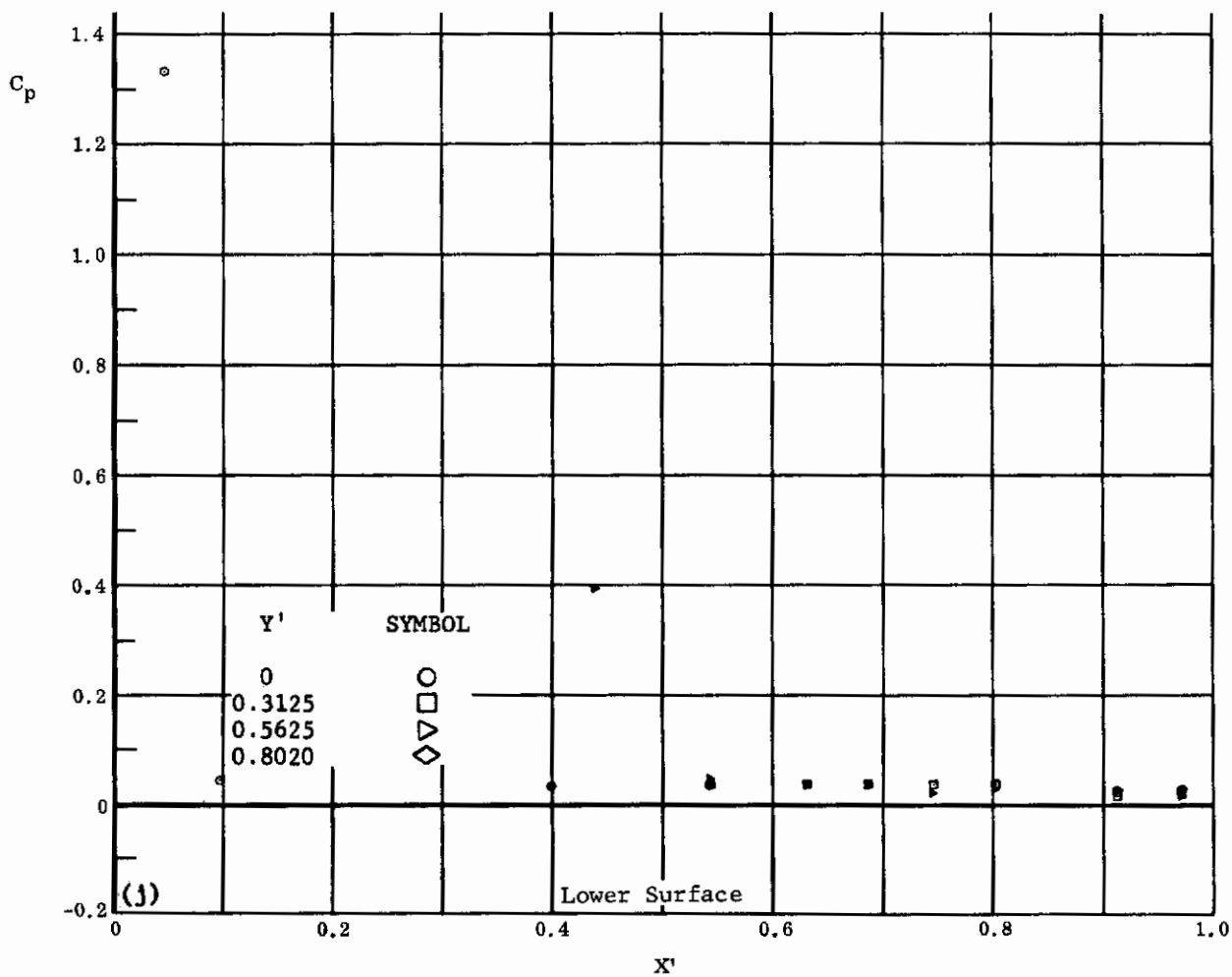

(NONDIMENSIONAL STREAMWISE DISTANCE FROM VIRTUAL APEX)

Fig. 45 Configuration IV, $\alpha = -30$, $\delta_2 = \delta_3 = -30$

- i) C_p vs. Y' , lower surface
- j) C_p vs. X' , lower surface

Contrails

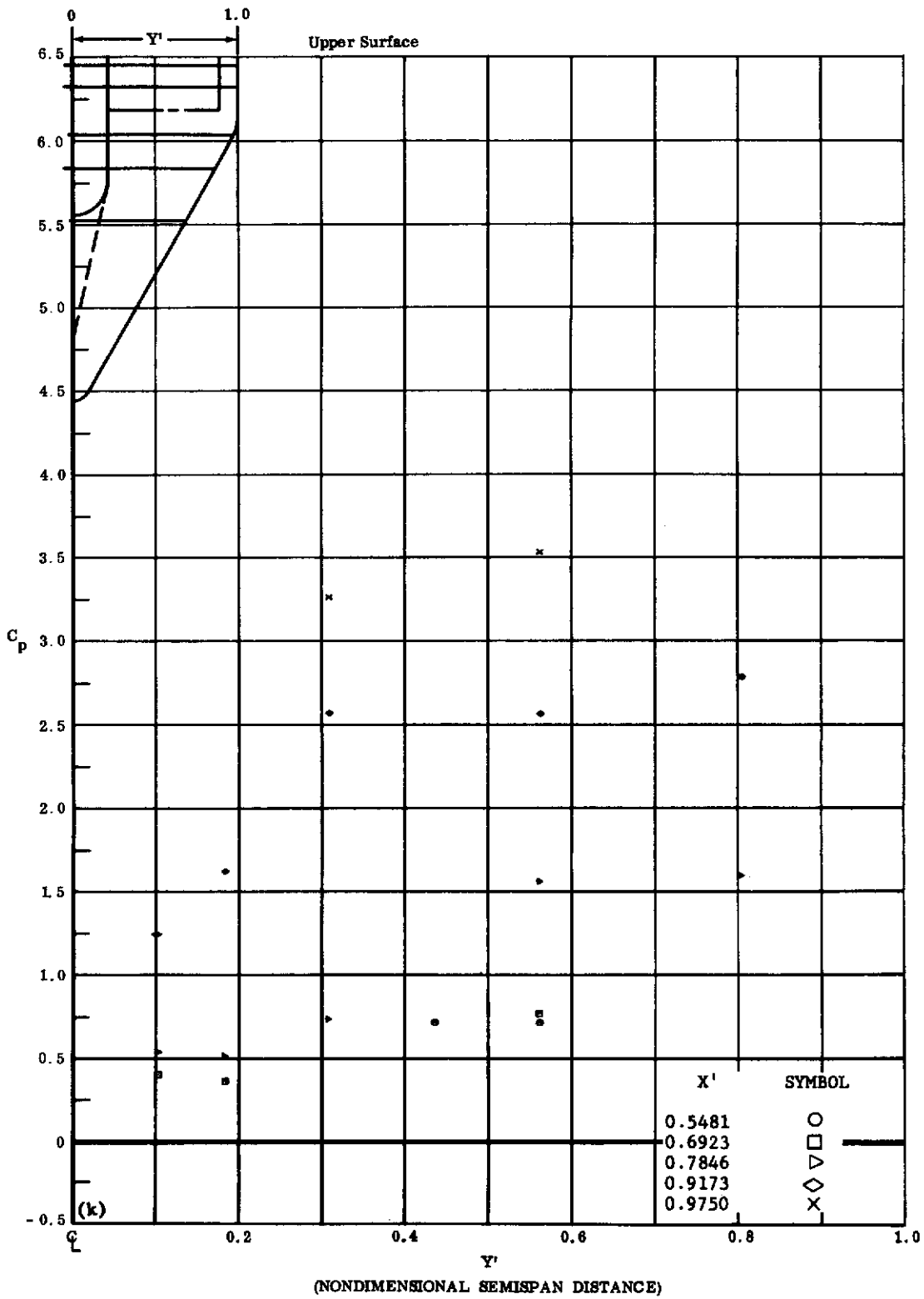
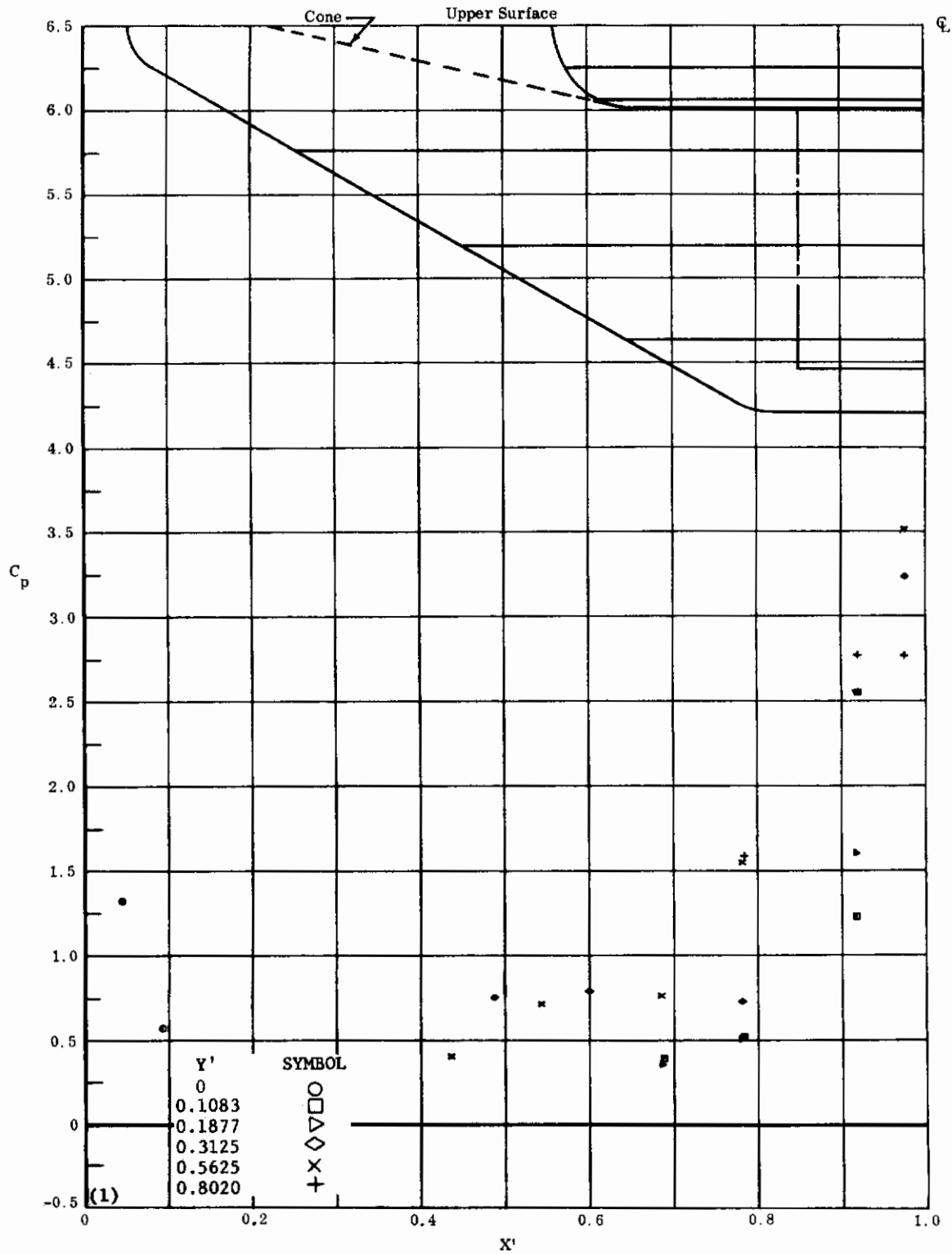

Fig. 45k Configuration IV, $\alpha = -30$, $\delta_2 = \delta_3 = -30$

C_p vs. Y' , upper surface



(NONDIMENSIONAL STREAMWISE DISTANCE FROM VIRTUAL APEX)

Fig. 451 Configuration IV, $\alpha = -30$, $\delta_2 = \delta_3 = -30$

C_p vs. X' , upper surface

Contrails

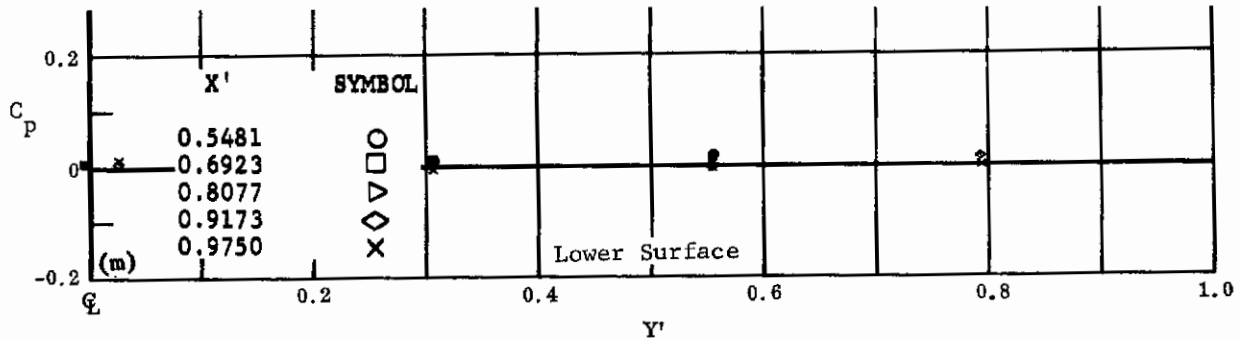

(NONDIMENSIONAL SEMISPAN DISTANCE)

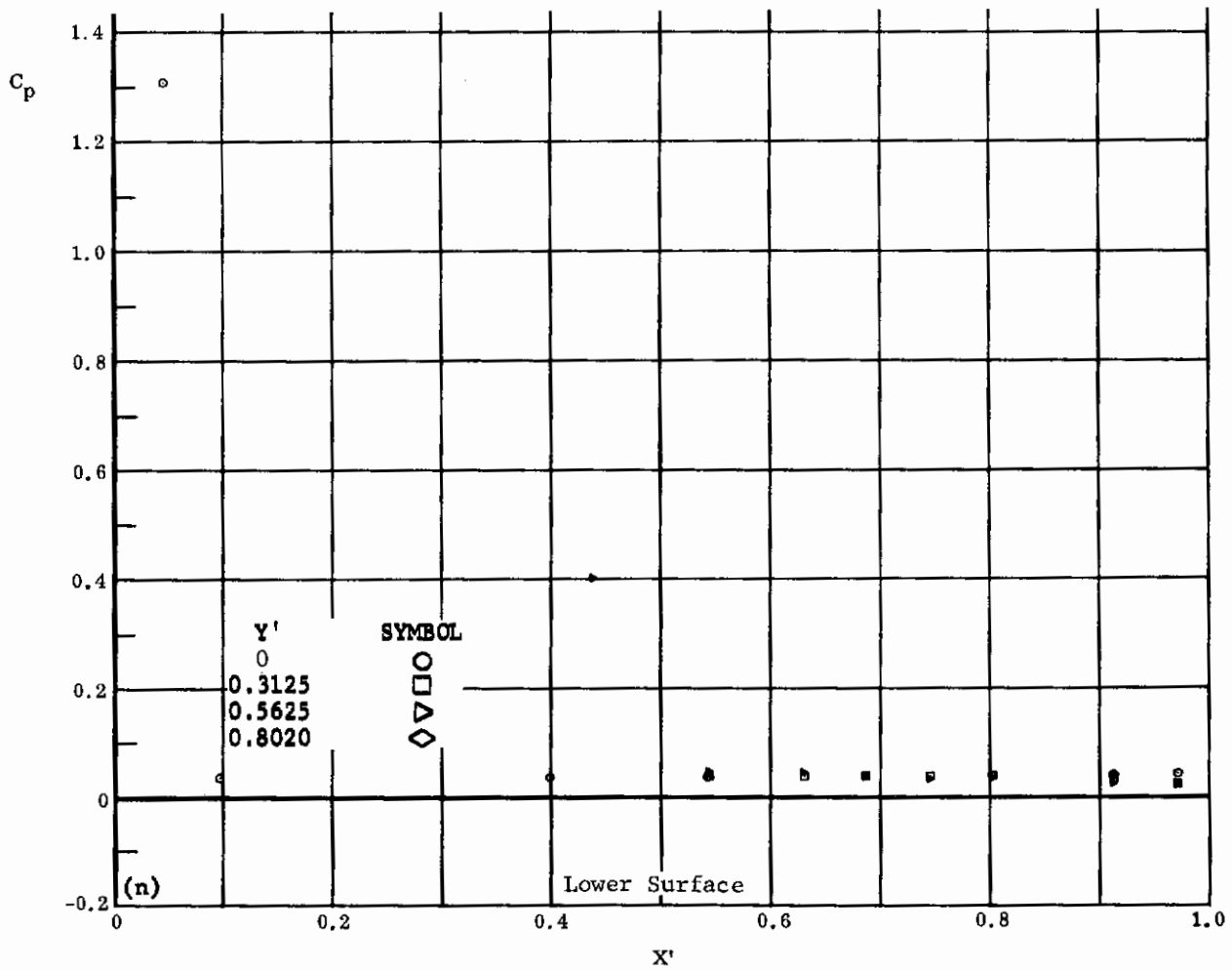

(NONDIMENSIONAL STREAMWISE DISTANCE FROM VIRTUAL APEX)

Fig. 45 Configuration IV, $\alpha = -30$, $\delta_2 = \delta_3 = -39$

m) C_p vs. Y' , lower surface

n) C_p vs. X' , lower surface

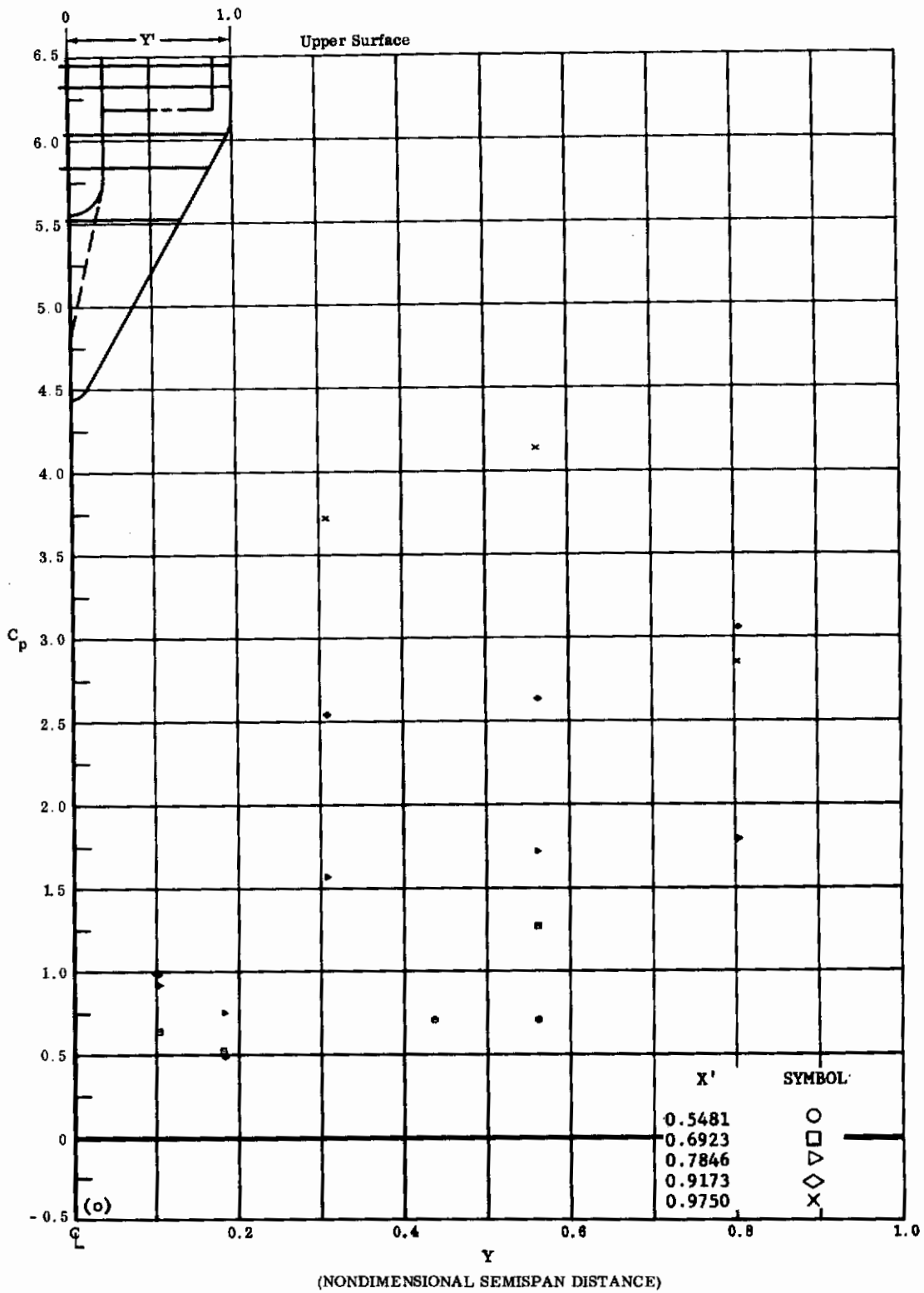
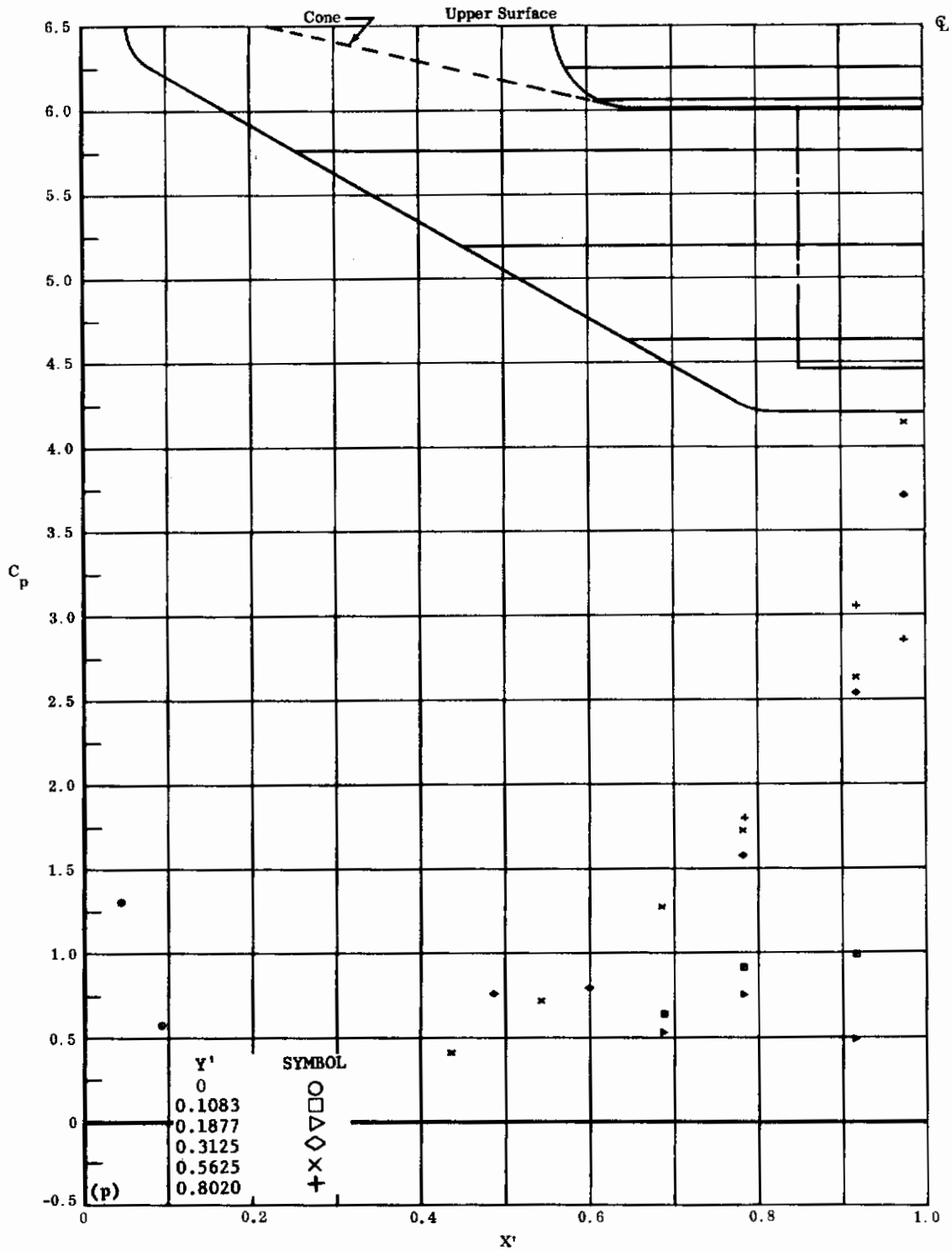

Fig. 45o Configuration IV, $\alpha = -30$, $\delta_2 = \delta_3 = -39$

C_p vs. Y' , upper surface

Contraails



(NONDIMENSIONAL STREAMWISE DISTANCE FROM VIRTUAL APEX)

Fig. 45p Configuration IV, $\alpha = -30$, $\delta_2 = \delta_3 = -39$

C_p vs. X' , upper surface

Contrails

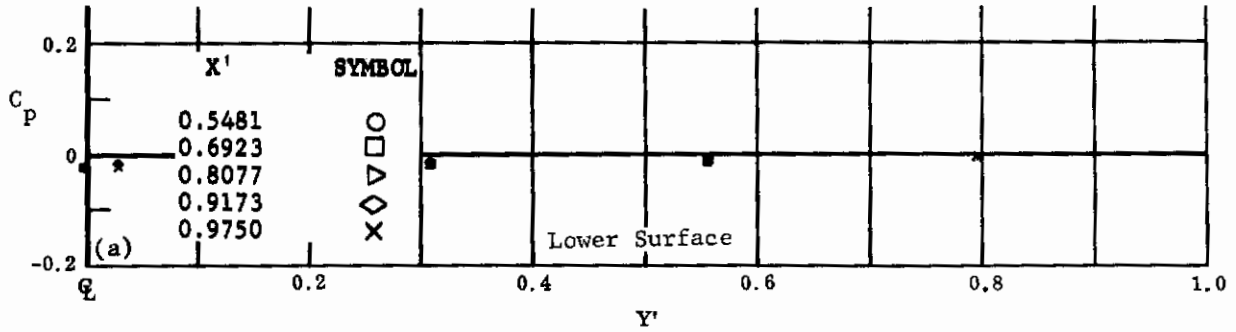

(NONDIMENSIONAL SEMISPAN DISTANCE)

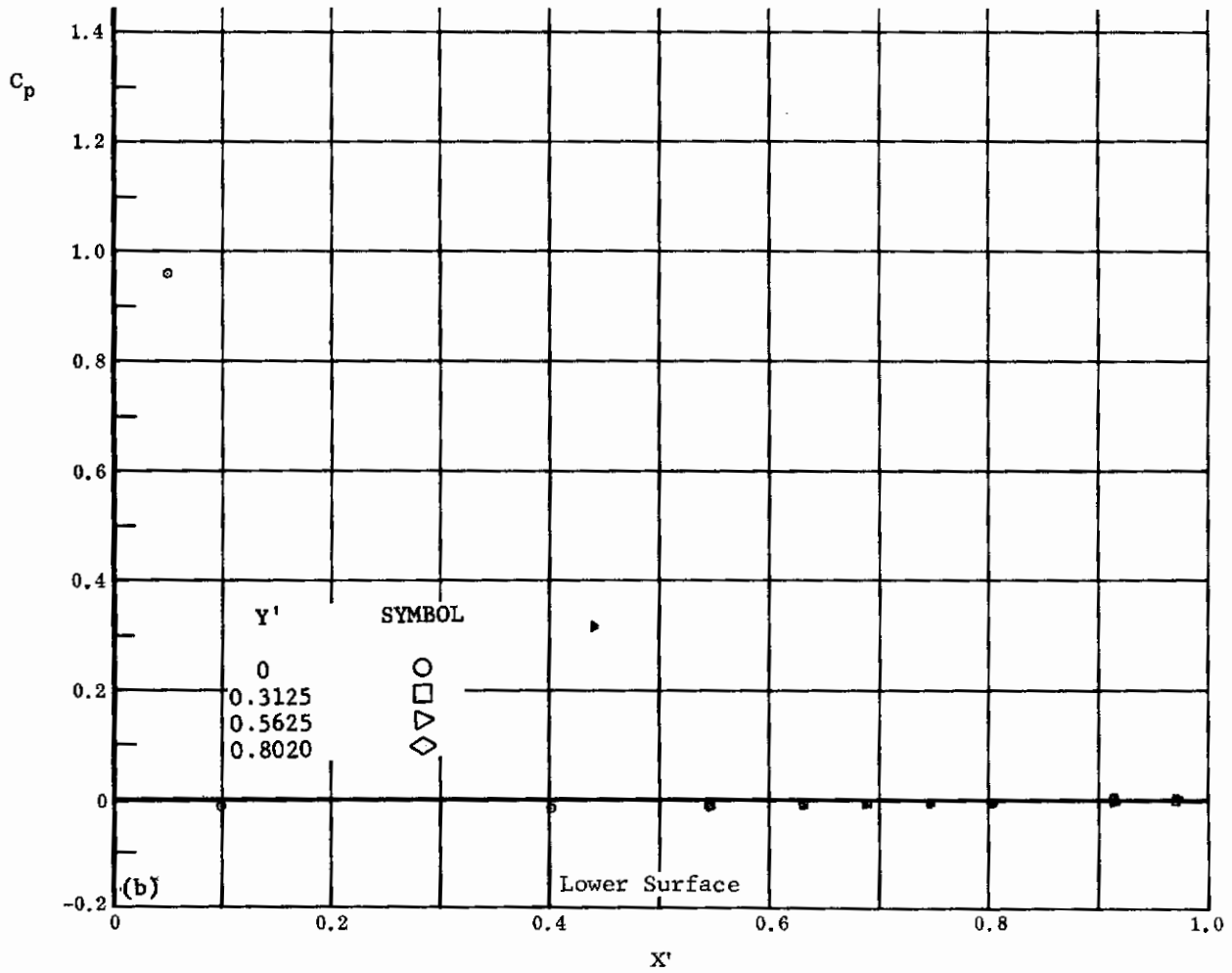

(NONDIMENSIONAL STREAMWISE DISTANCE FROM VIRTUAL APEX)

Fig. 46 Configuration IV, $\alpha = -40$, $\delta_2 = \delta_3 = 0$

a) C_p vs. Y' , lower surface

b) C_p vs. X' , lower surface

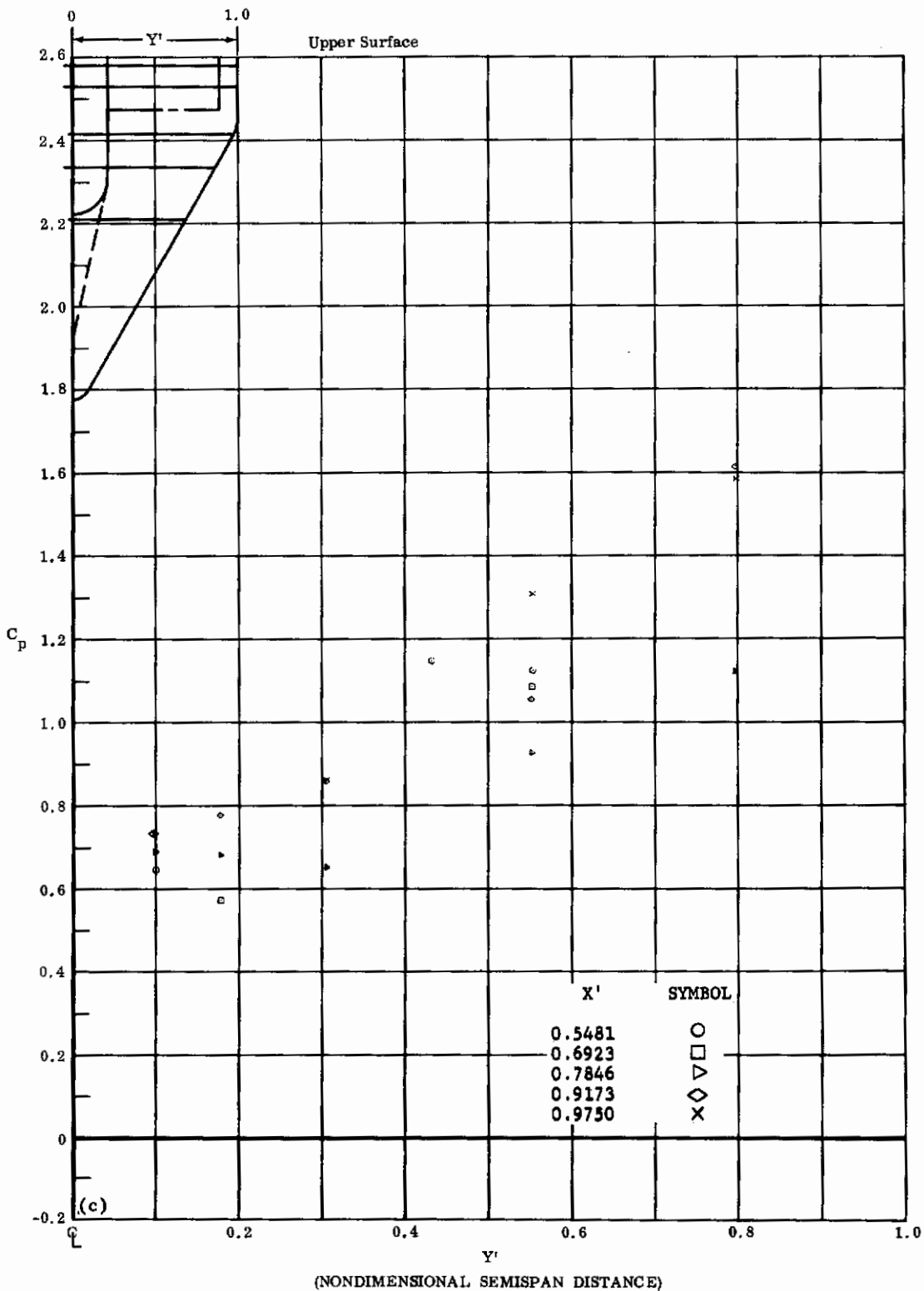
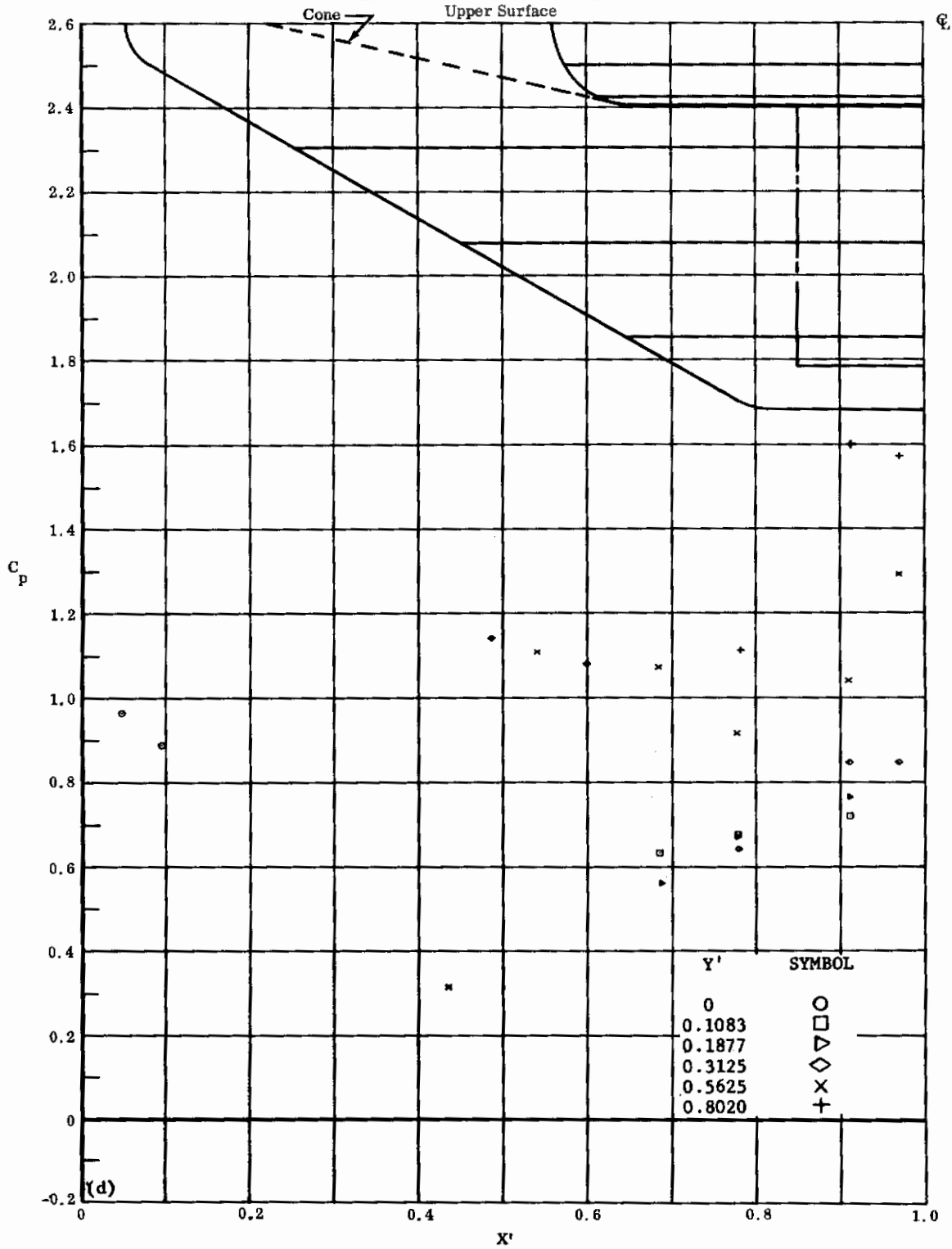

Fig. 46c Configuration IV, $\alpha = -40$, $\delta_2 = \delta_3 = 0$

C_p vs. Y' , upper surface



(NONDIMENSIONAL STREAMWISE DISTANCE FROM VIRTUAL APEX)

Fig. 46d Configuration IV, $\alpha = -40$, $\delta_2 = \delta_3 = 0$

C_p vs. X' , upper surface

Contrails

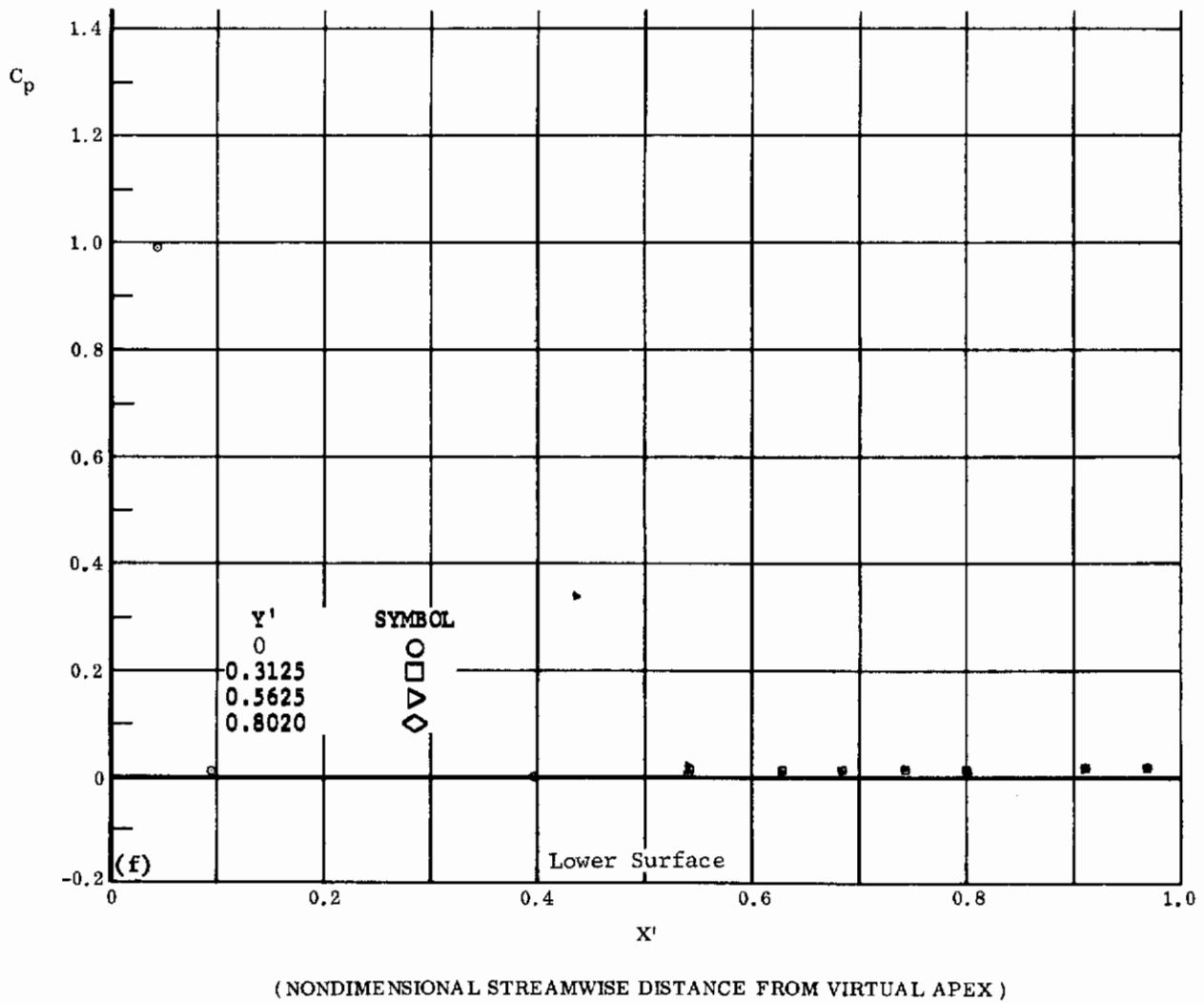
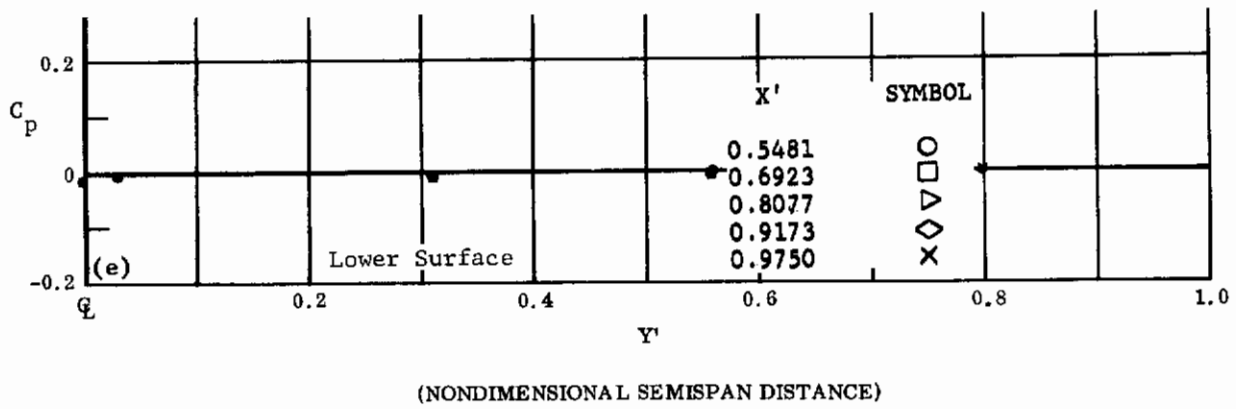

Fig. 46 Configuration IV, $\alpha = -40$, $\delta_2 = \delta_3 = +20$

e) C_p vs. Y' , lower surface

f) C_p vs. X' , lower surface

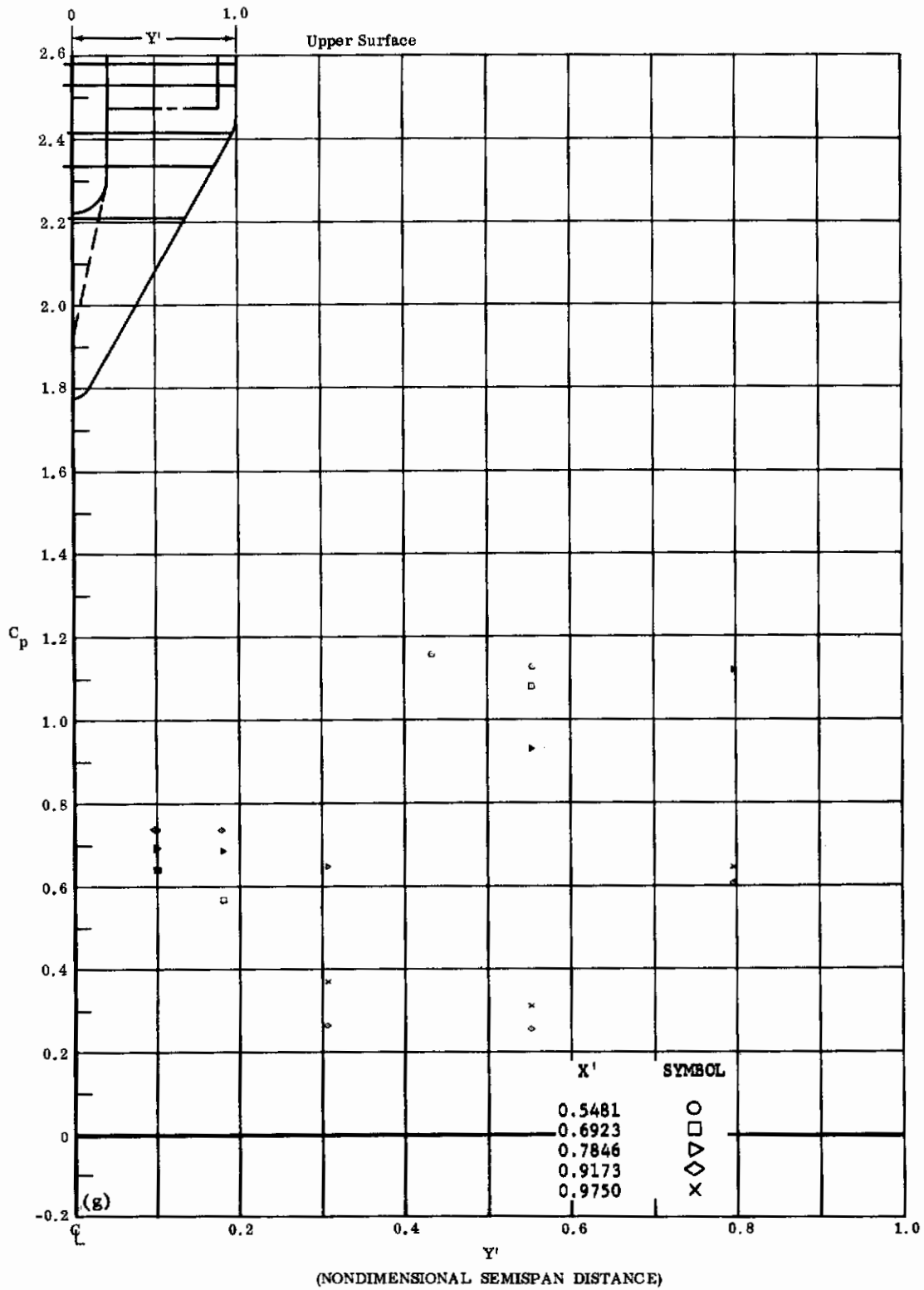
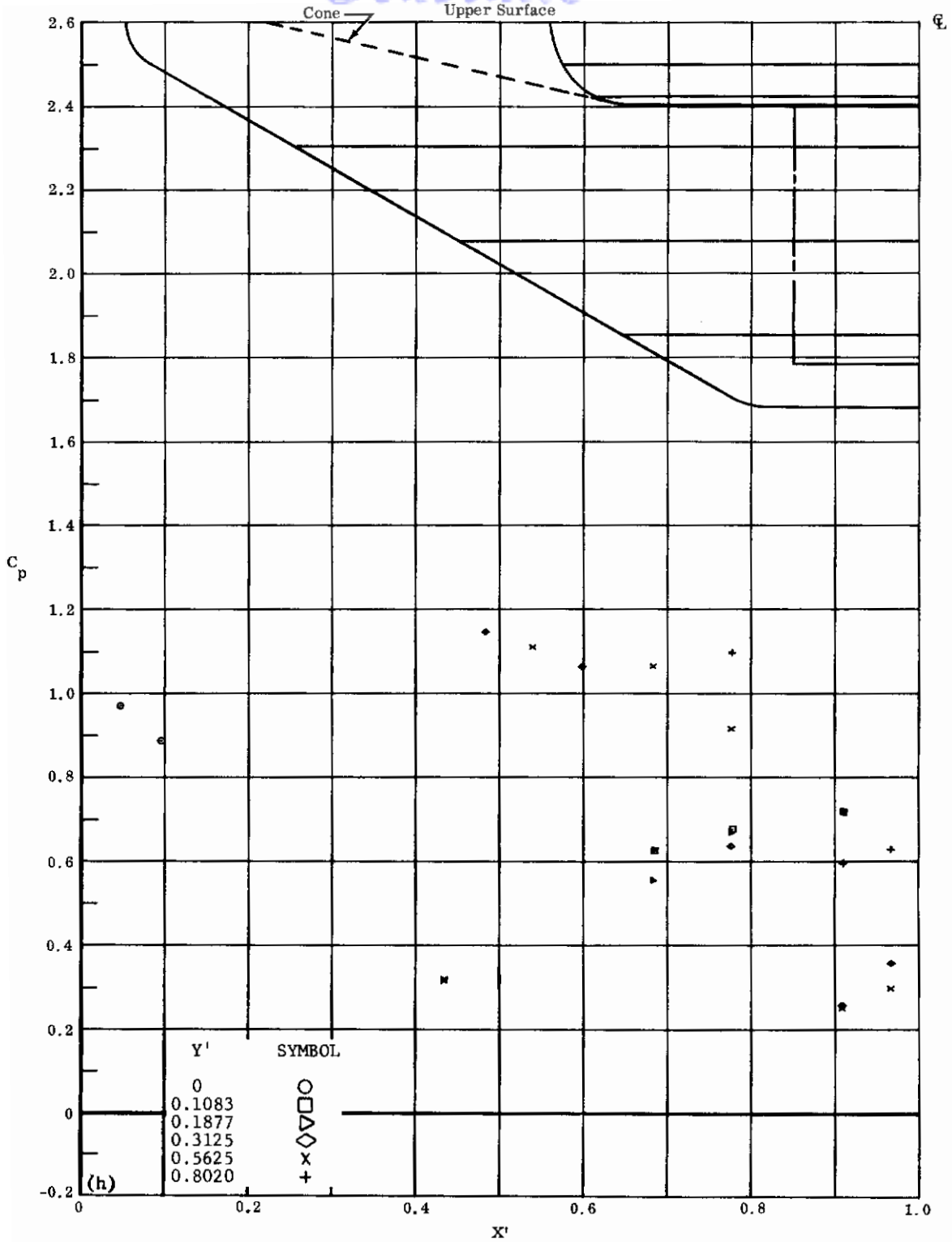

Fig. 46g Configuration IV, $\alpha = -40$, $\delta_2 = \delta_3 = +20$
 C_p vs. Y' , upper surface



(NONDIMENSIONAL STREAMWISE DISTANCE FROM VIRTUAL APEX)

Fig. 46h Configuration IV, $\alpha = -40$, $\delta_2 = \delta_3 = +20$

C_p vs. X' , upper surface

Contrails

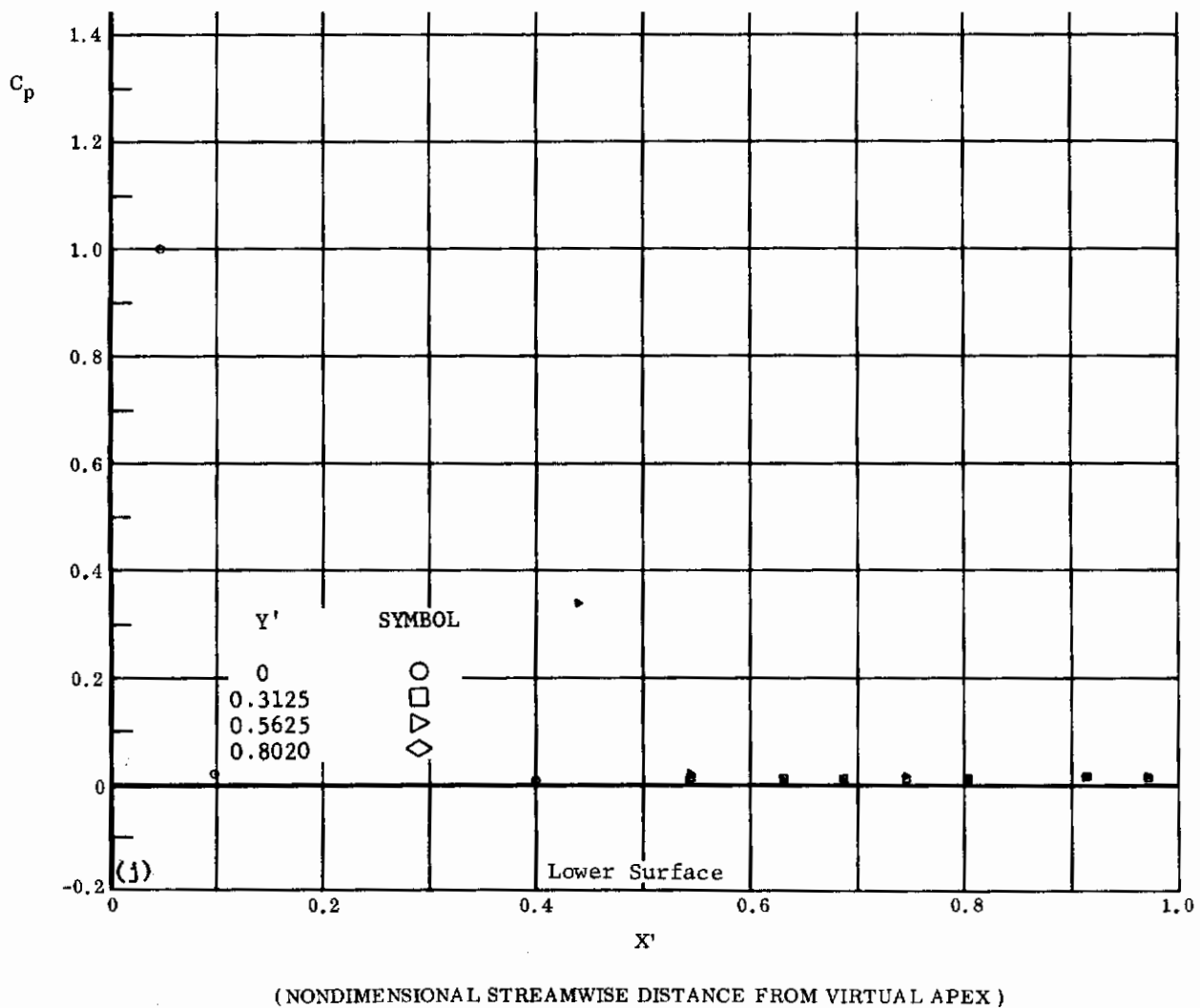
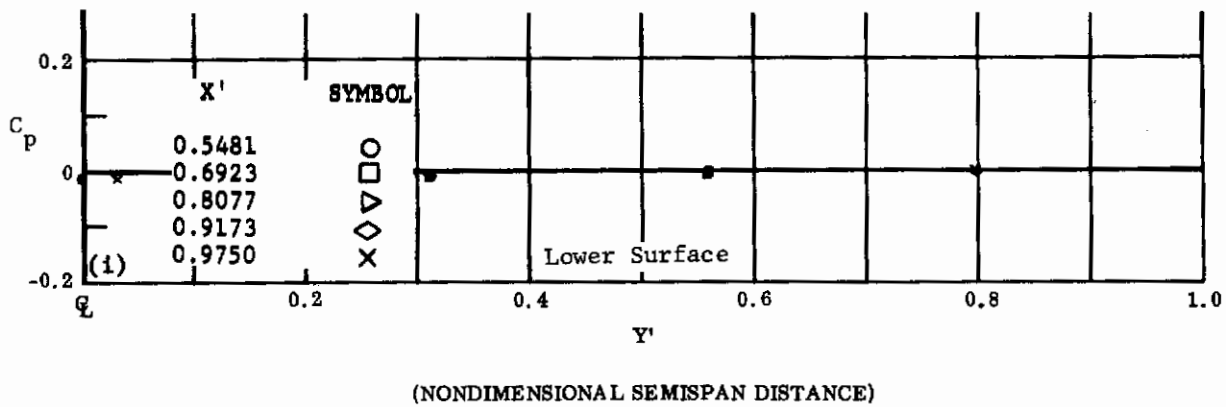

Fig. 46 Configuration IV, $\alpha = -40$, $\delta_2 = \delta_3 = +39$

- i) C_p vs. Y' , lower surface
- j) C_p vs. X' , lower surface

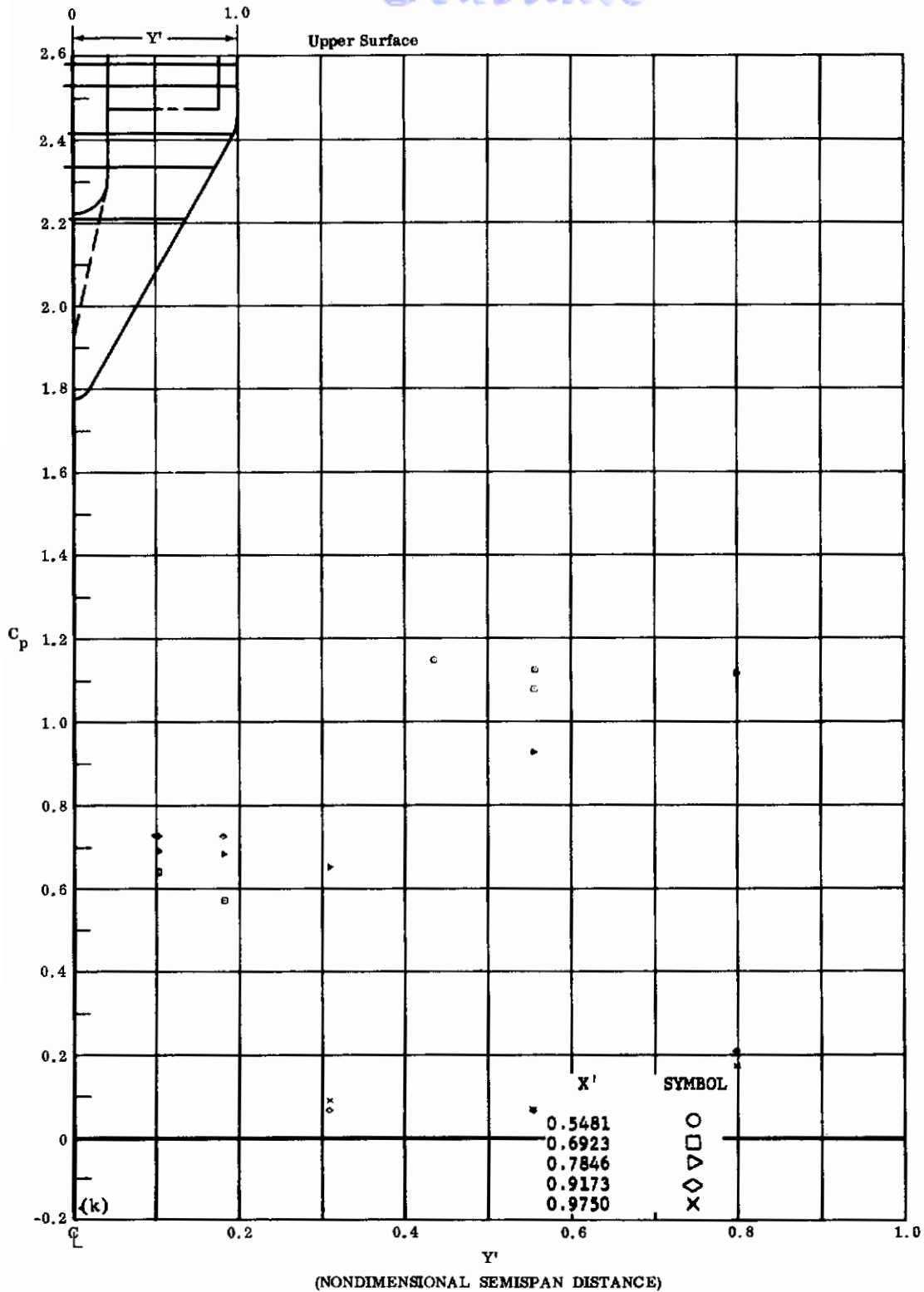
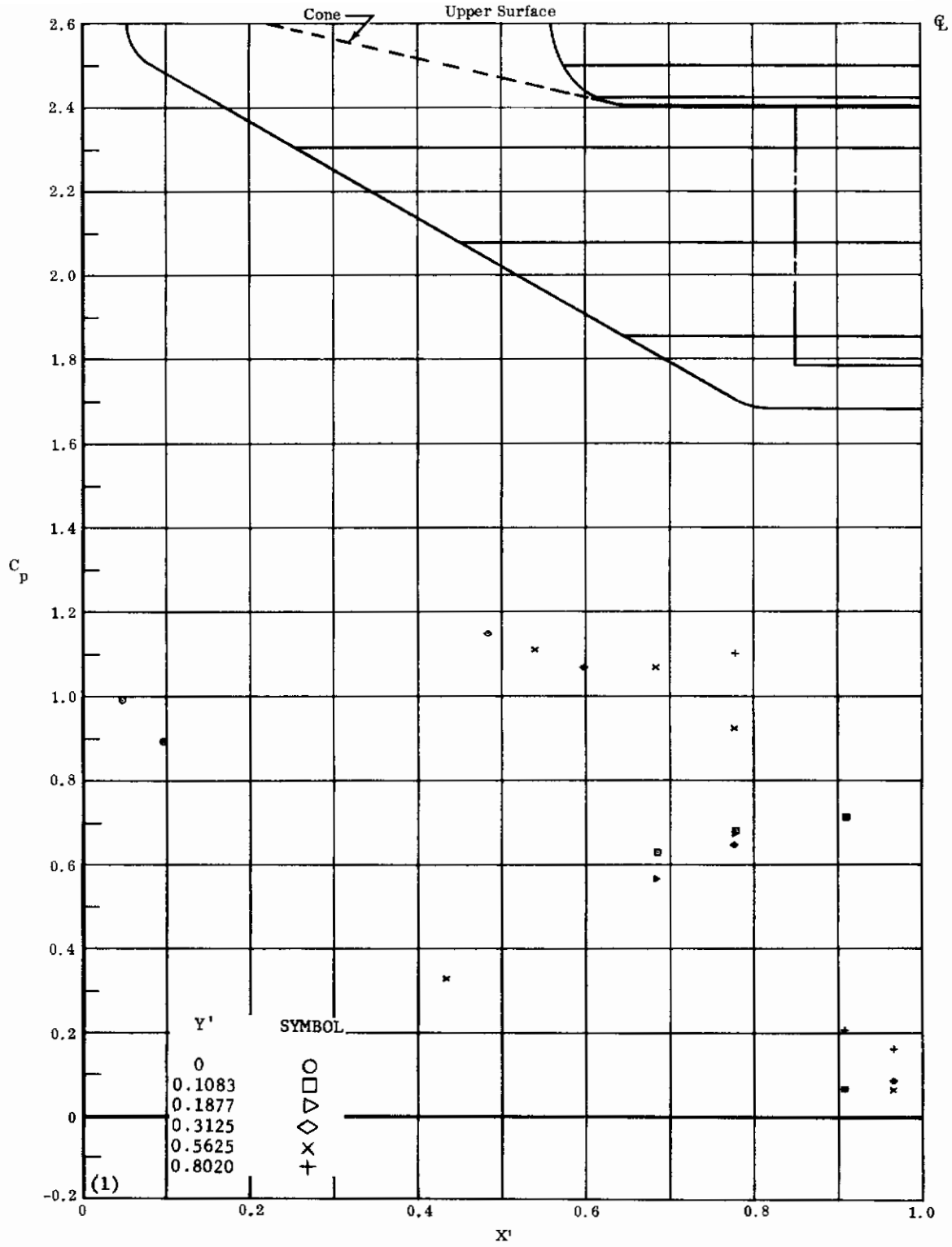

Fig. 46k Configuration IV, $\alpha = -40$, $\delta_2 = \delta_3 = +39$

C_p vs. Y' , upper surface



(NONDIMENSIONAL STREAMWISE DISTANCE FROM VIRTUAL APEX)

Fig. 461 Configuration IV, $\alpha = -40$, $\delta_2 = \delta_3 = +39$

C_p vs. X' , upper surface

Contrails

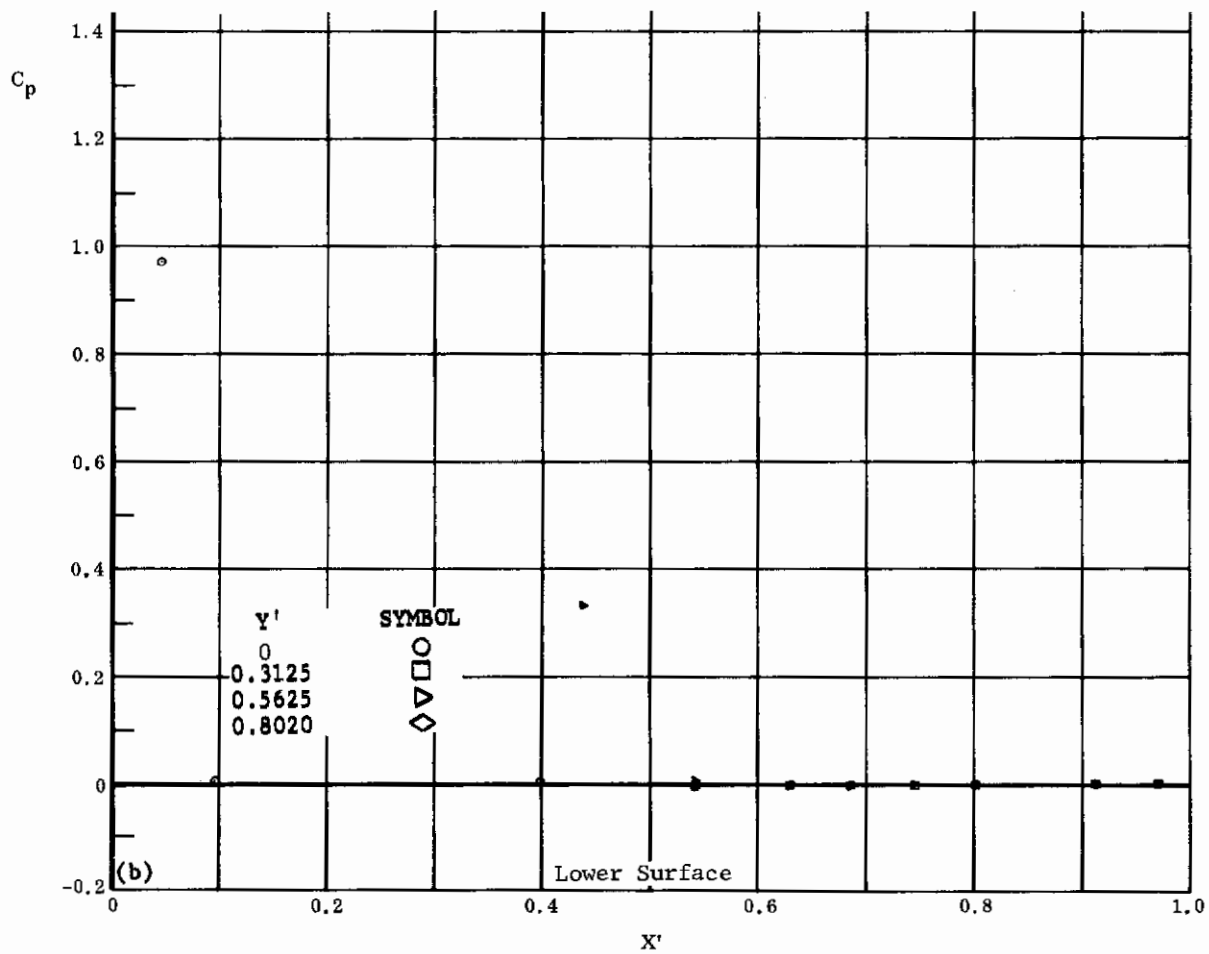
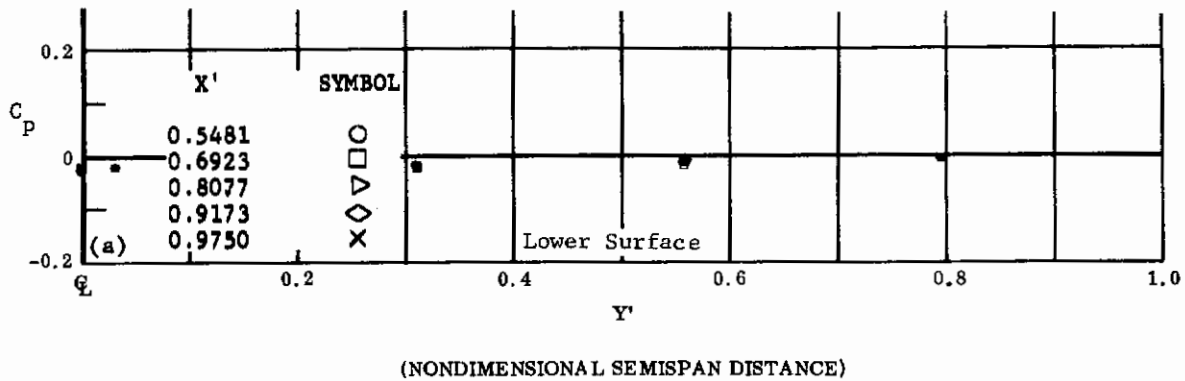

Fig. 47 Configuration IV, $\alpha = -40$, $\delta_2 = \delta_3 = -10$

a) C_p vs. Y' , lower surface

b) C_p vs. X' , lower surface

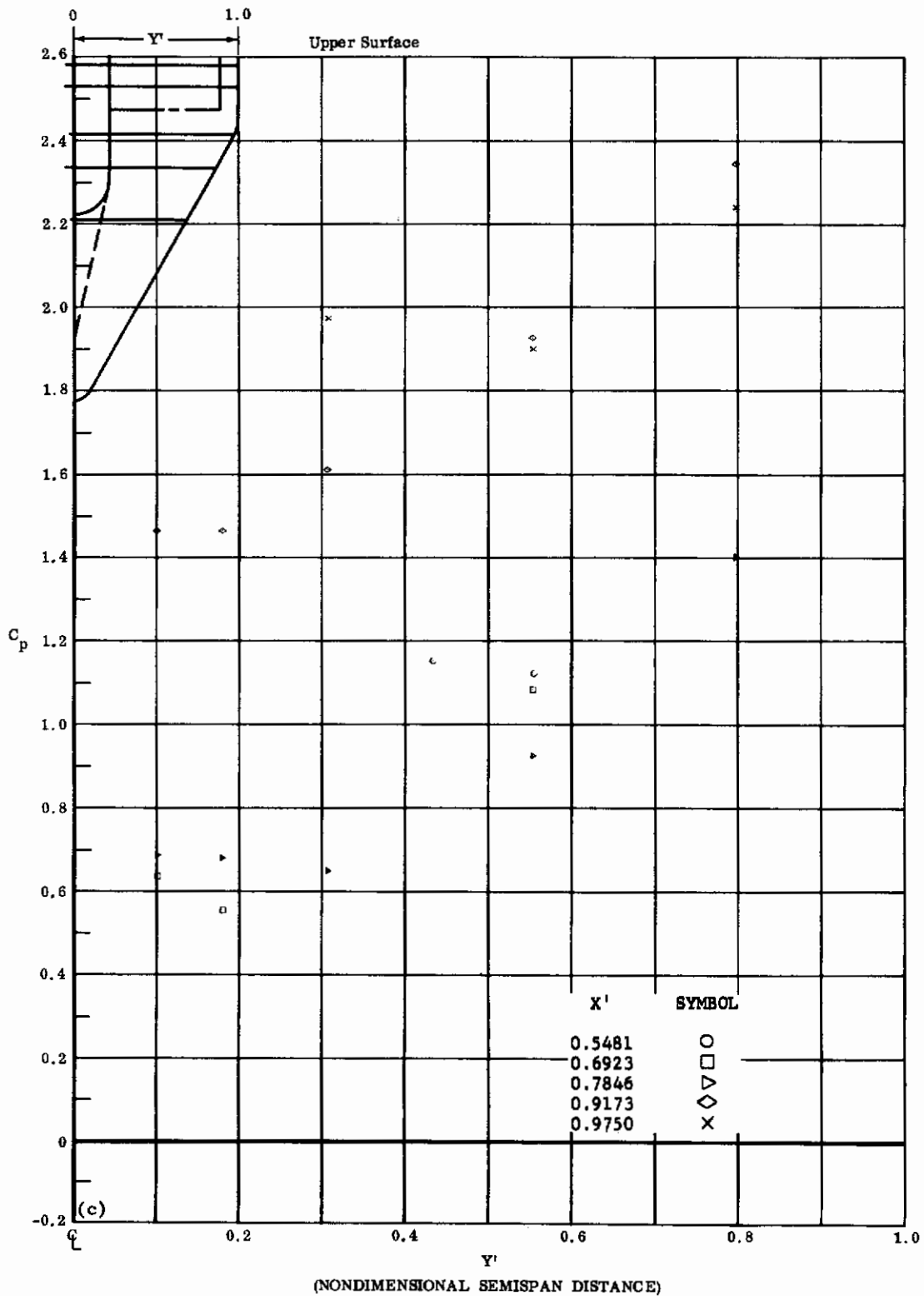
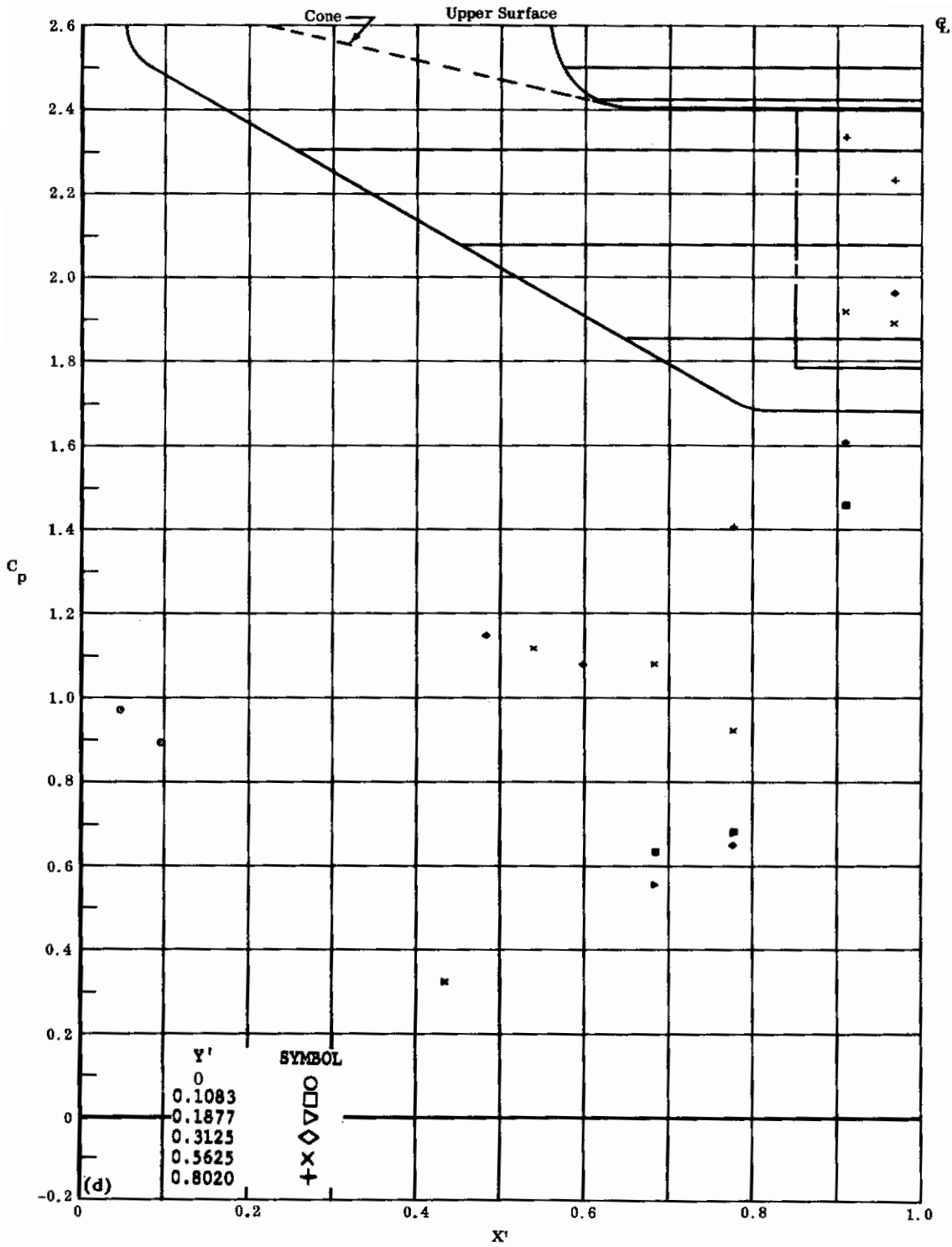

Fig. 47c Configuration IV, $\alpha = -40$, $\delta_2 = \delta_3 = -10$

C_p vs. Y' , upper surface



(NONDIMENSIONAL STREAMWISE DISTANCE FROM VIRTUAL APEX)

Fig. 47d Configuration IV, $\alpha = -40$, $\delta_2 = \delta_3 = -10$

C_p vs. X' , upper surface

Contrails

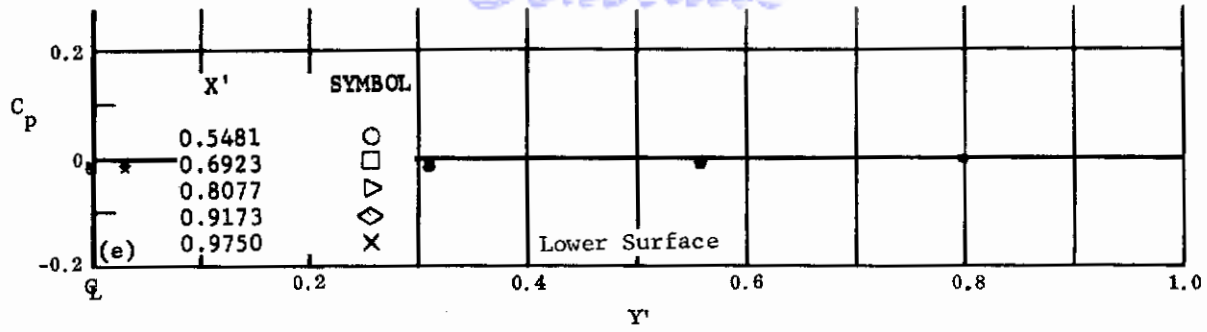

(NONDIMENSIONAL SEMISPAN DISTANCE)

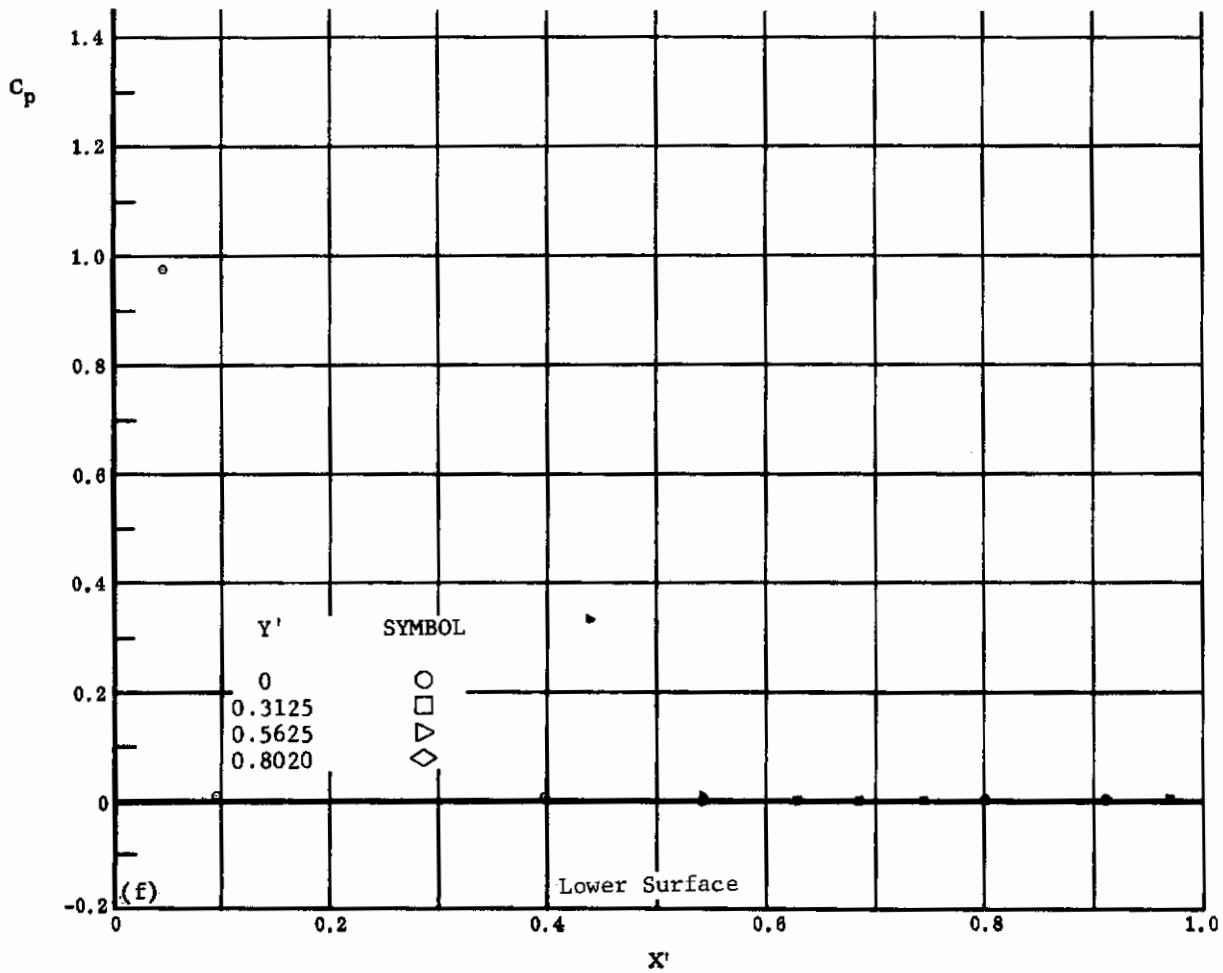

(NONDIMENSIONAL STREAMWISE DISTANCE FROM VIRTUAL APEX)

Fig. 47 Configuration IV, $\alpha = -40$, $\delta_2 = \delta_3 = -20$

e) C_p vs. Y' , lower surface

f) C_p vs. X' , lower surface

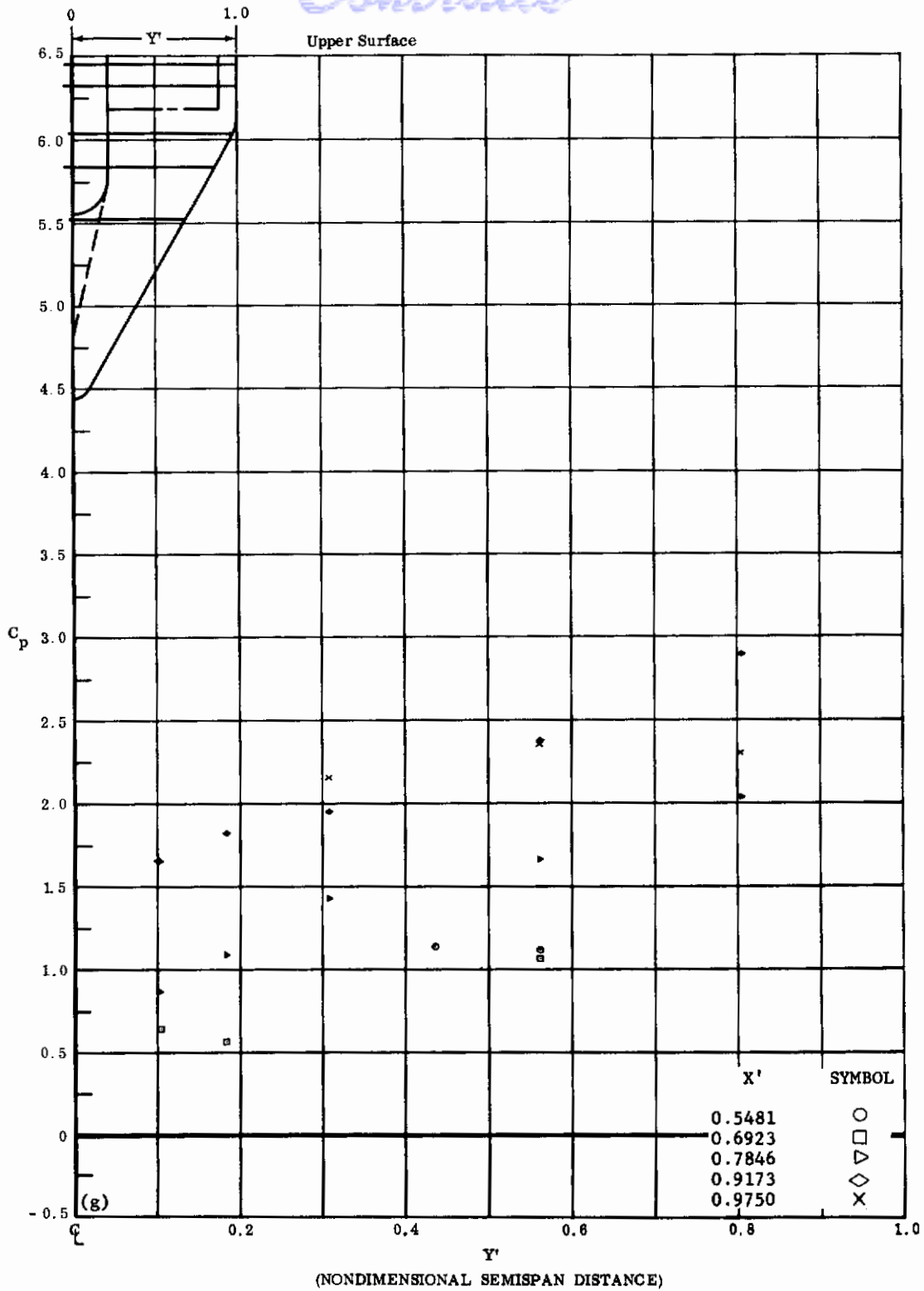
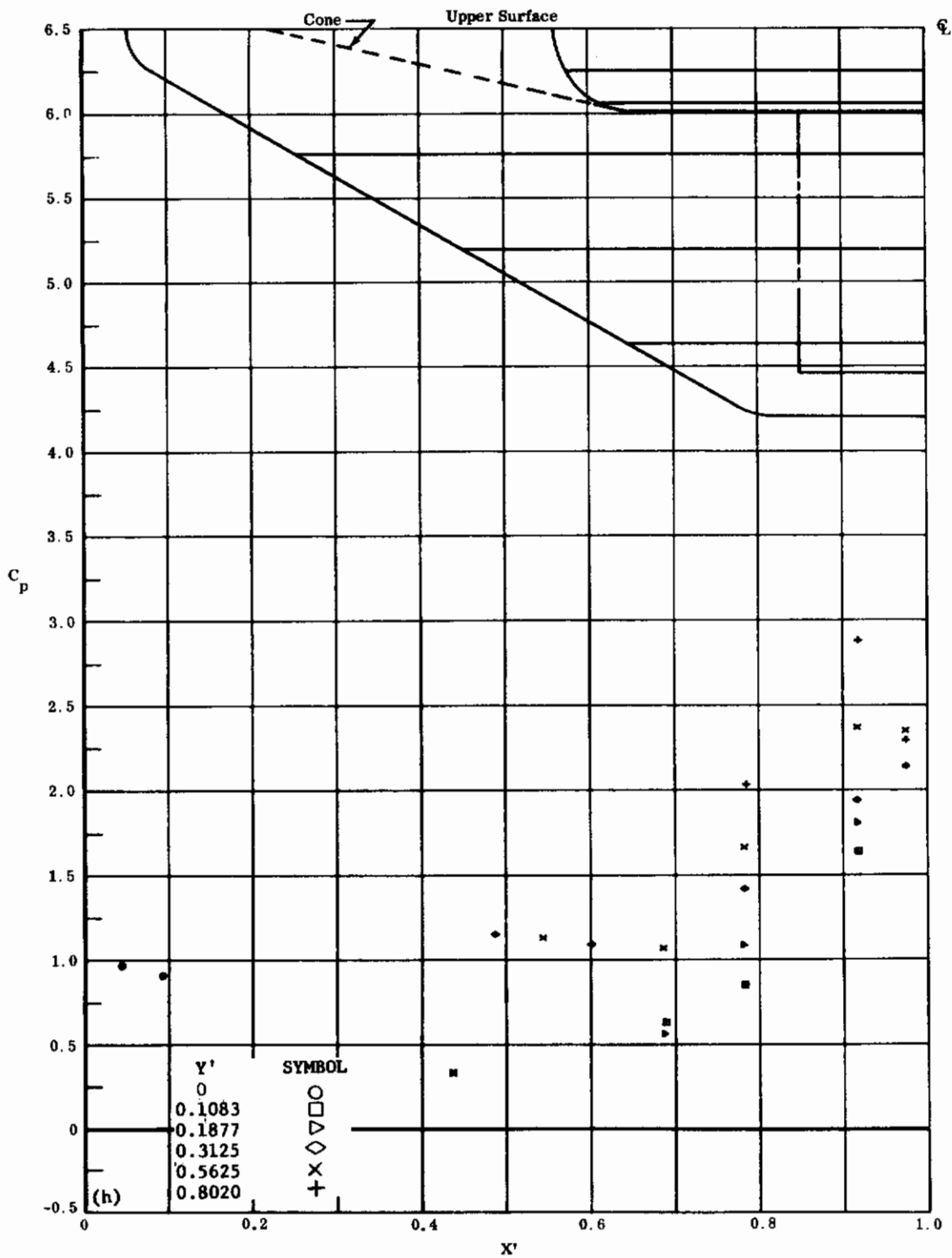

Fig. 47g Configuration IV, $\alpha = -40$, $\delta_2 = \delta_3 = -20$

C_p vs. Y' , upper surface

Contraails



(NONDIMENSIONAL STREAMWISE DISTANCE FROM VIRTUAL APEX)

Fig. 47h Configuration IV, $\alpha = -40$, $\delta_2 = \delta_3 = -20$

C_p vs. X' , upper surface

Contrails

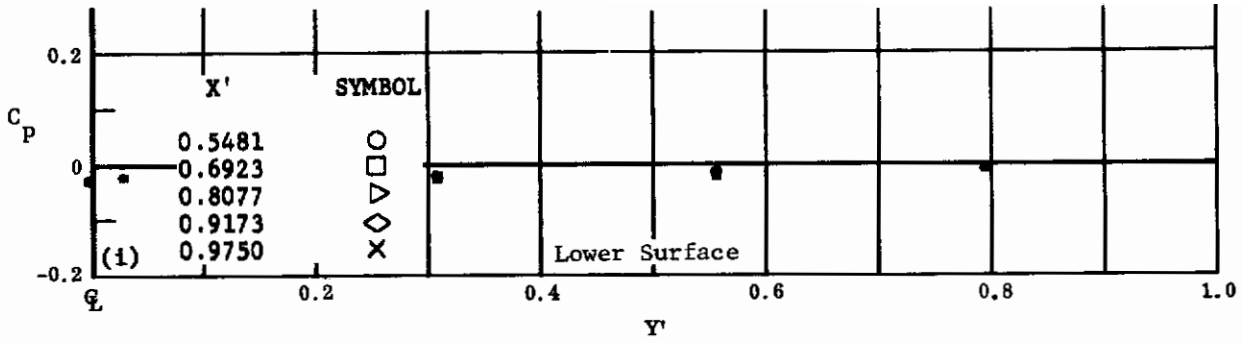

(NONDIMENSIONAL SEMISPAN DISTANCE)

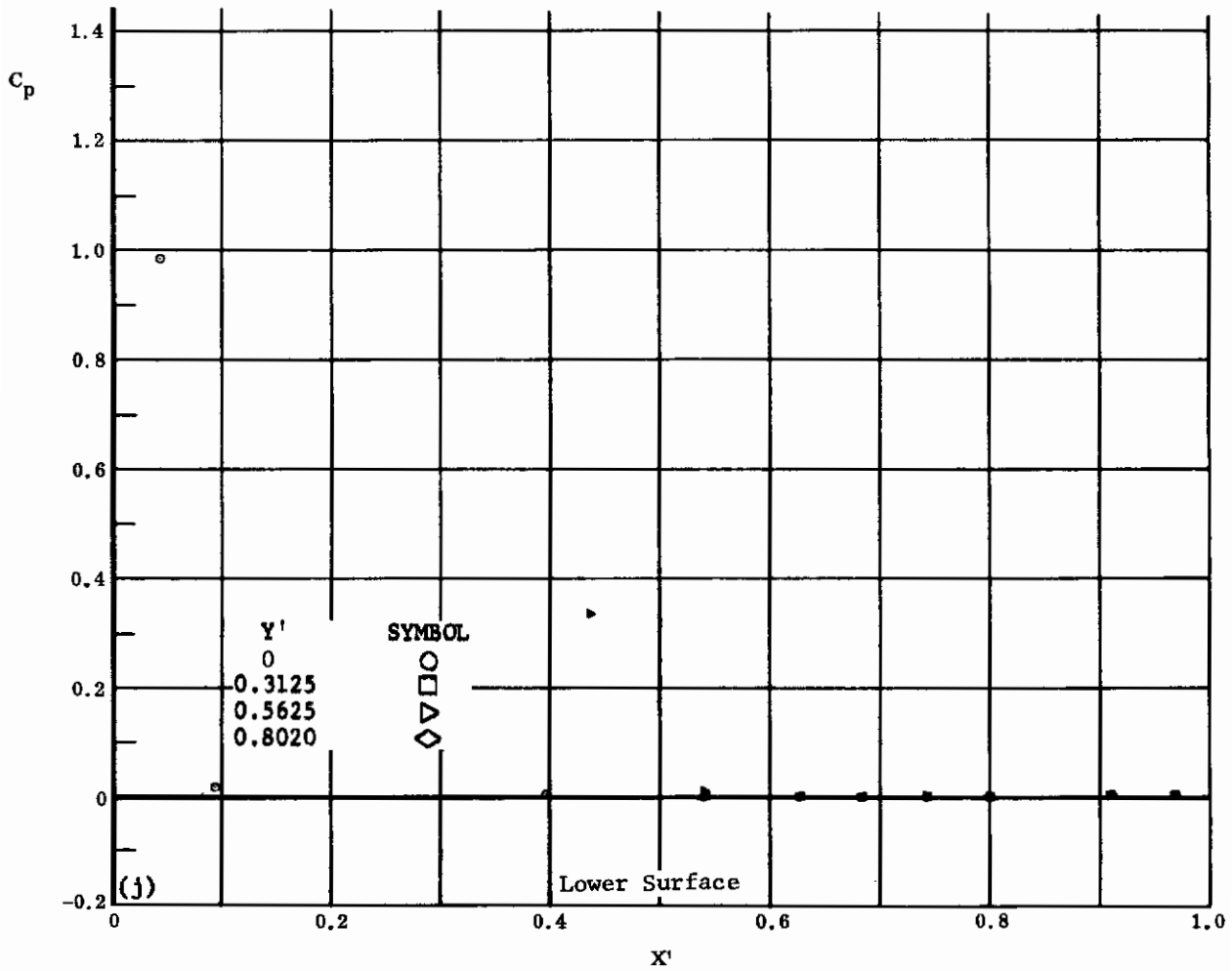

(NONDIMENSIONAL STREAMWISE DISTANCE FROM VIRTUAL APEX)

Fig. 47 Configuration IV, $\alpha = -40$, $\delta_2 = \delta_3 = -30$

i) C_p vs. Y' , lower surface

j) C_p vs. X' , lower surface

Contrails

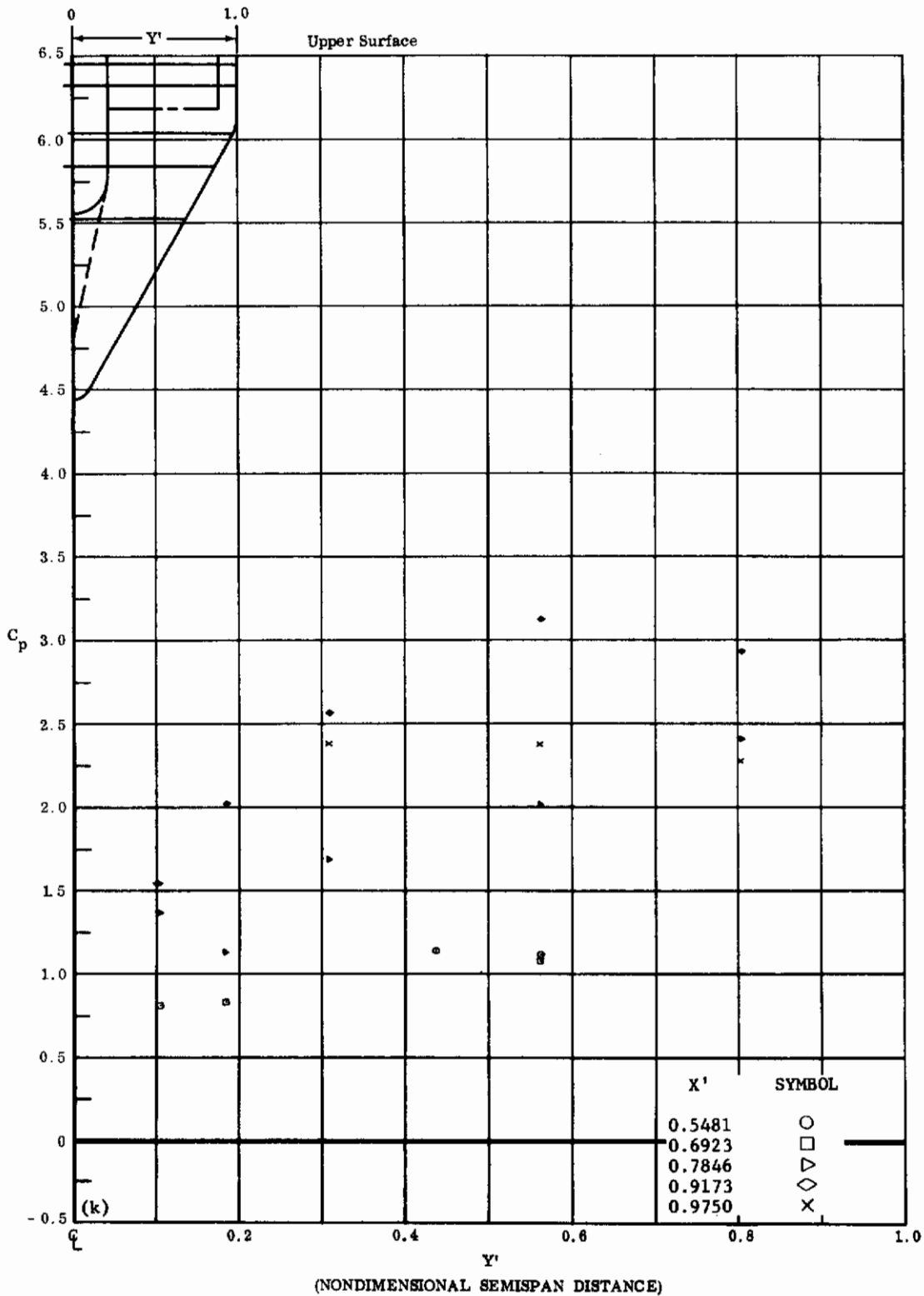
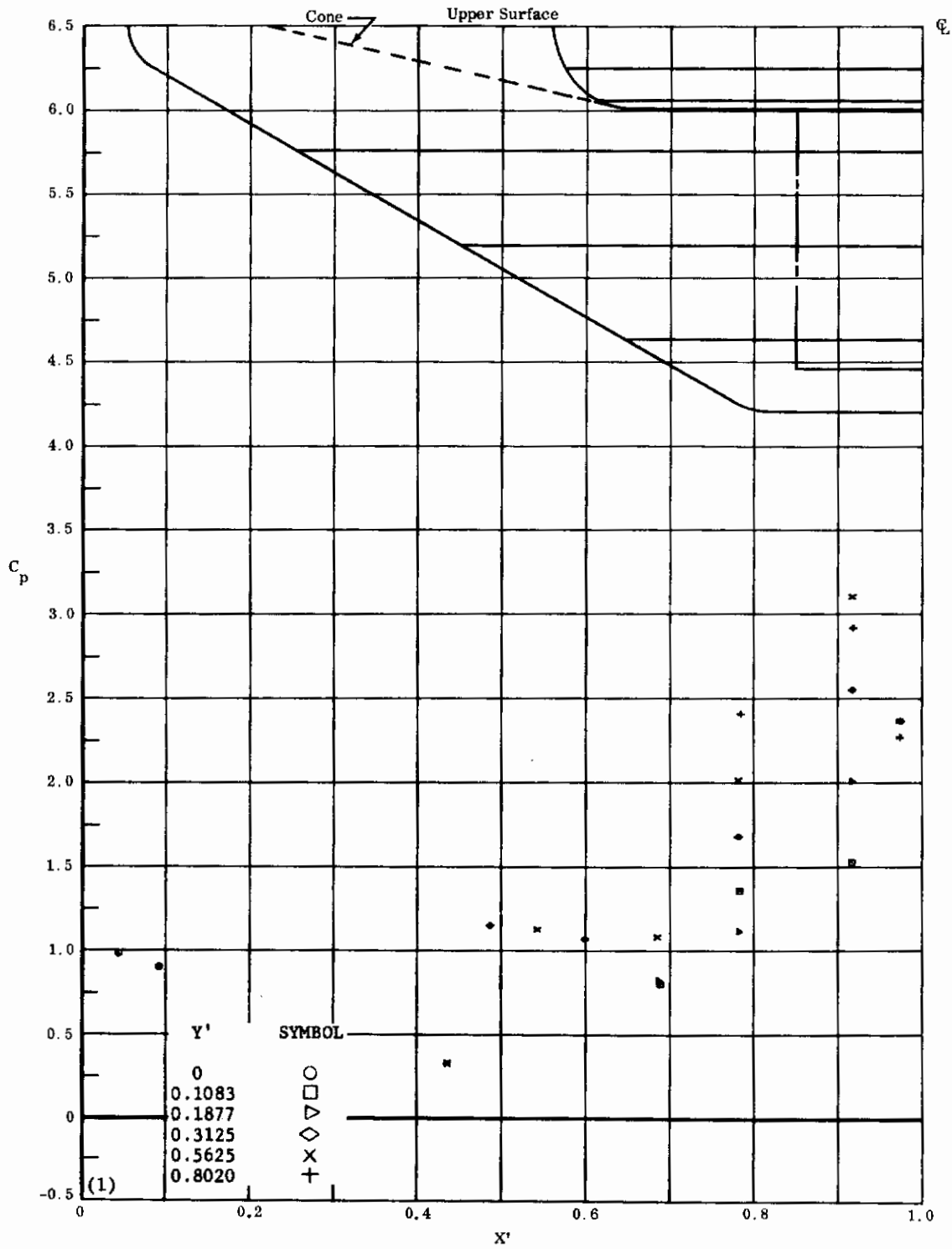

Fig. 47k Configuration IV, $\alpha = -40$, $\delta_2 = \delta_3 = -30$

C_p vs. Y' , upper surface

Contraails



(NONDIMENSIONAL STREAMWISE DISTANCE FROM VIRTUAL APEX)

Fig. 471 Configuration IV, $\alpha = -40$, $\delta_2 = \delta_3 = -30$

C_p vs. X' , upper surface

Contrails

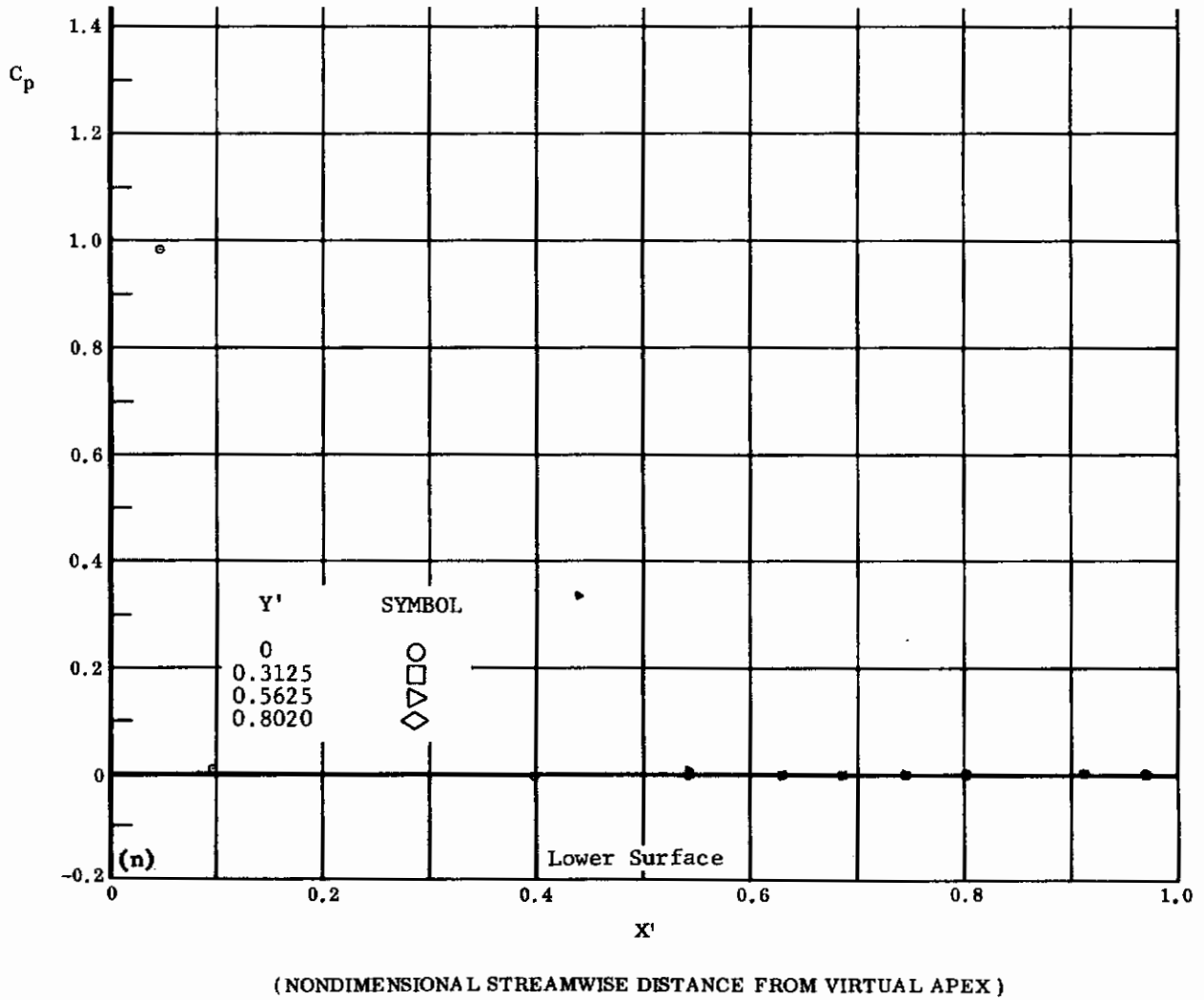
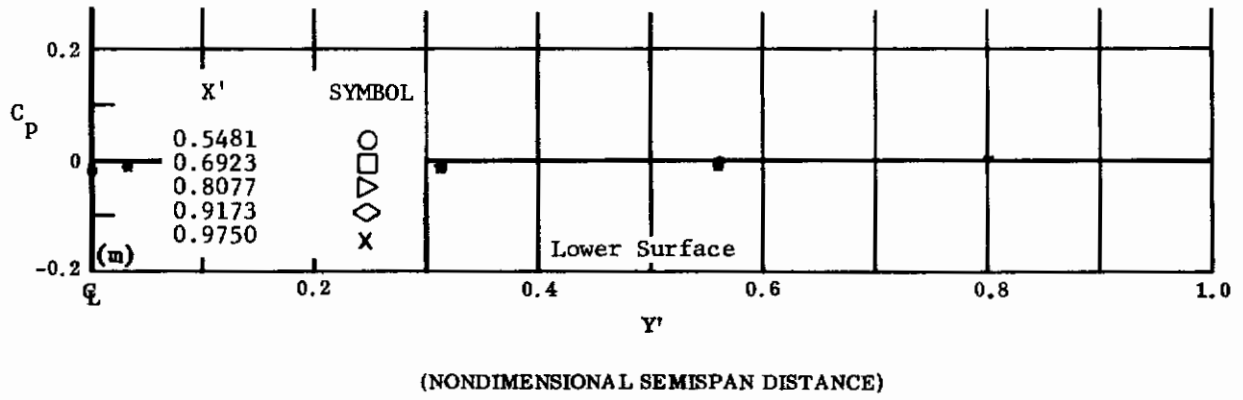

Fig. 47 Configuration IV, $\alpha = -40$, $\delta_2 = \delta_3 = -39$

m) C_p vs. Y' , lower surface

n) C_p vs. X' , lower surface

Contrails

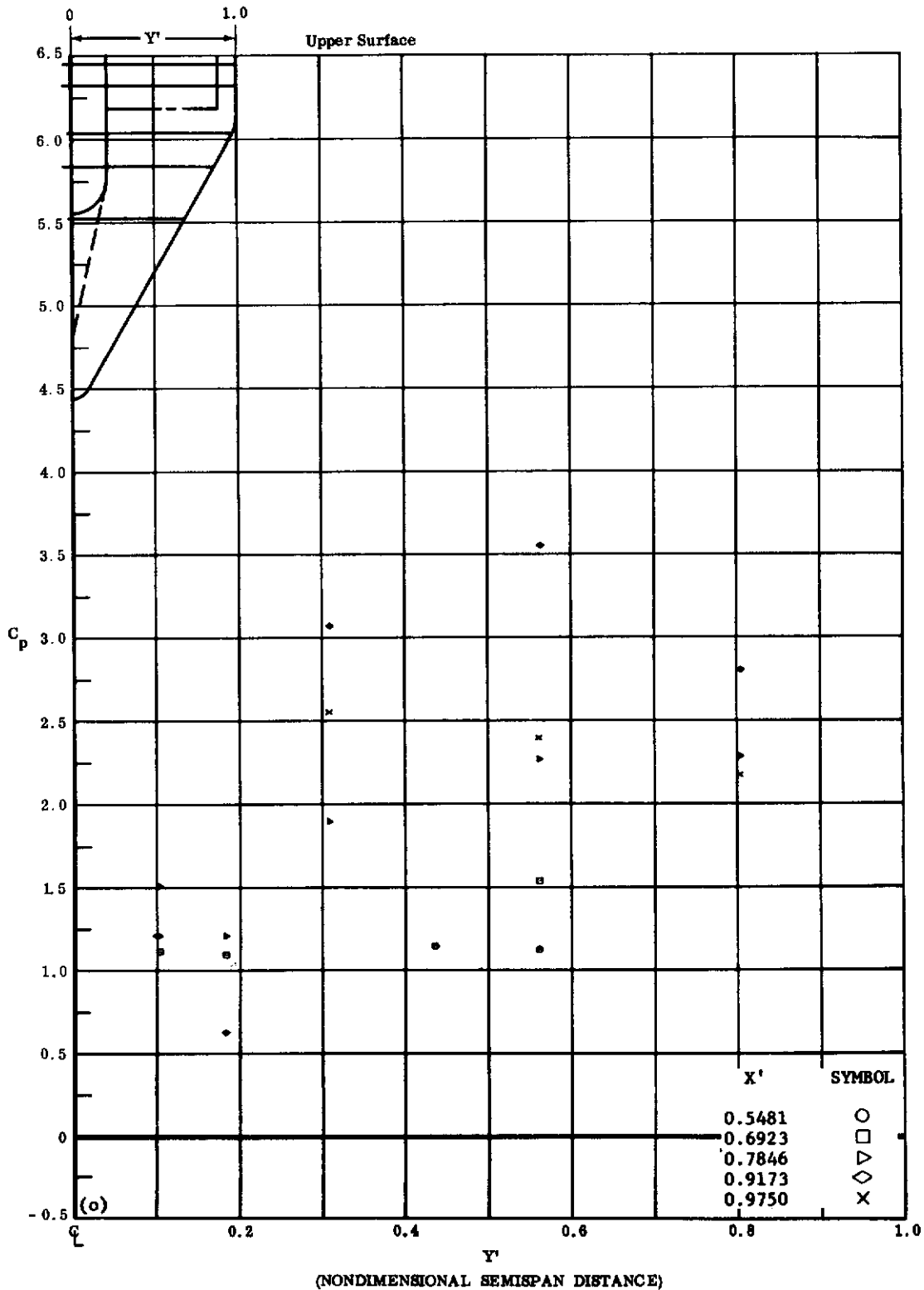
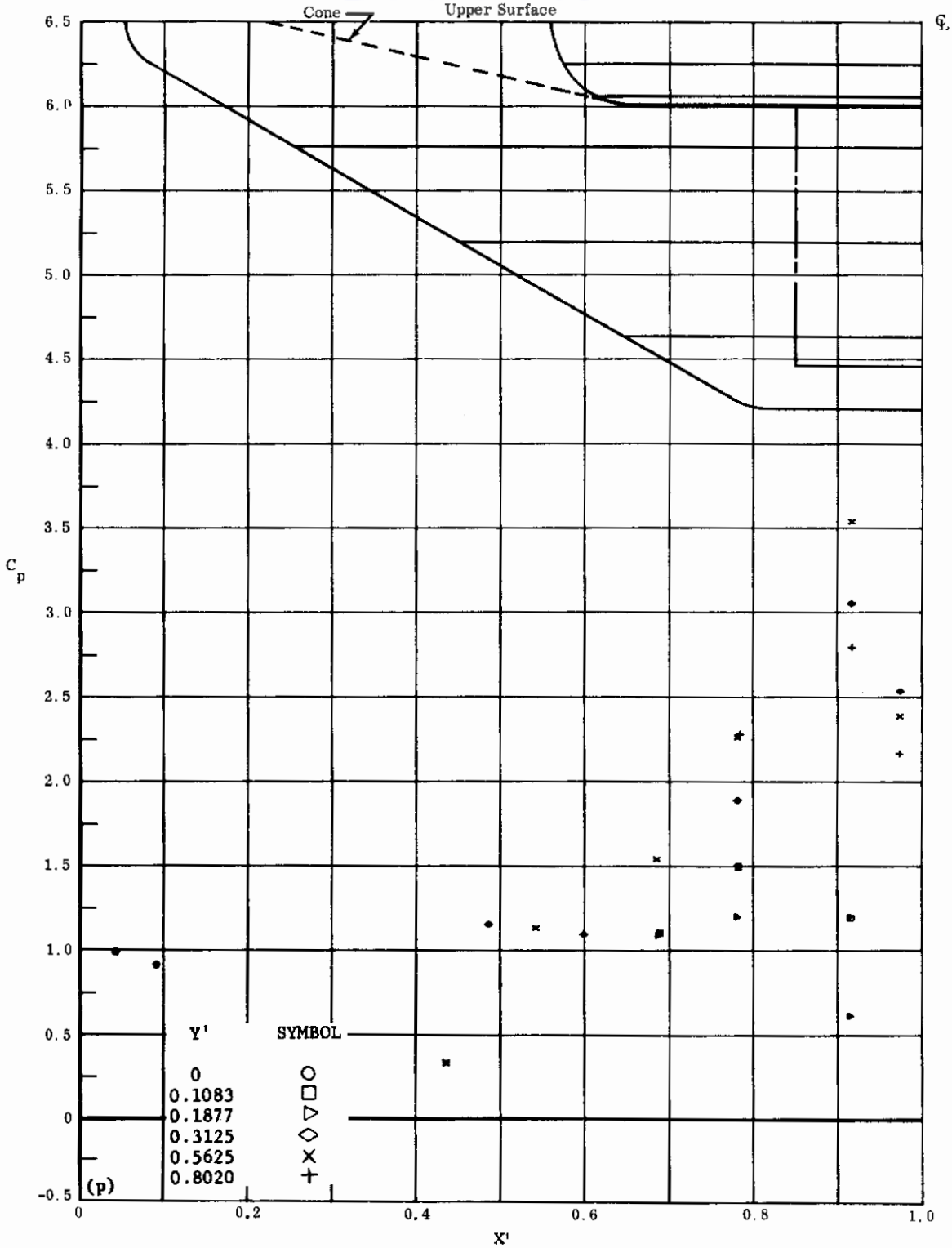

Fig. 47o Configuration IV, $\alpha = -40$, $\delta_2 = \delta_3 = -39$

C_p vs. Y' , upper surface



(NONDIMENSIONAL STREAMWISE DISTANCE FROM VIRTUAL APEX)

Fig. 47p Configuration IV, $\alpha = -40$, $\delta_2 = \delta_3 = -39$

C_p vs. X' , upper surface

Contrails

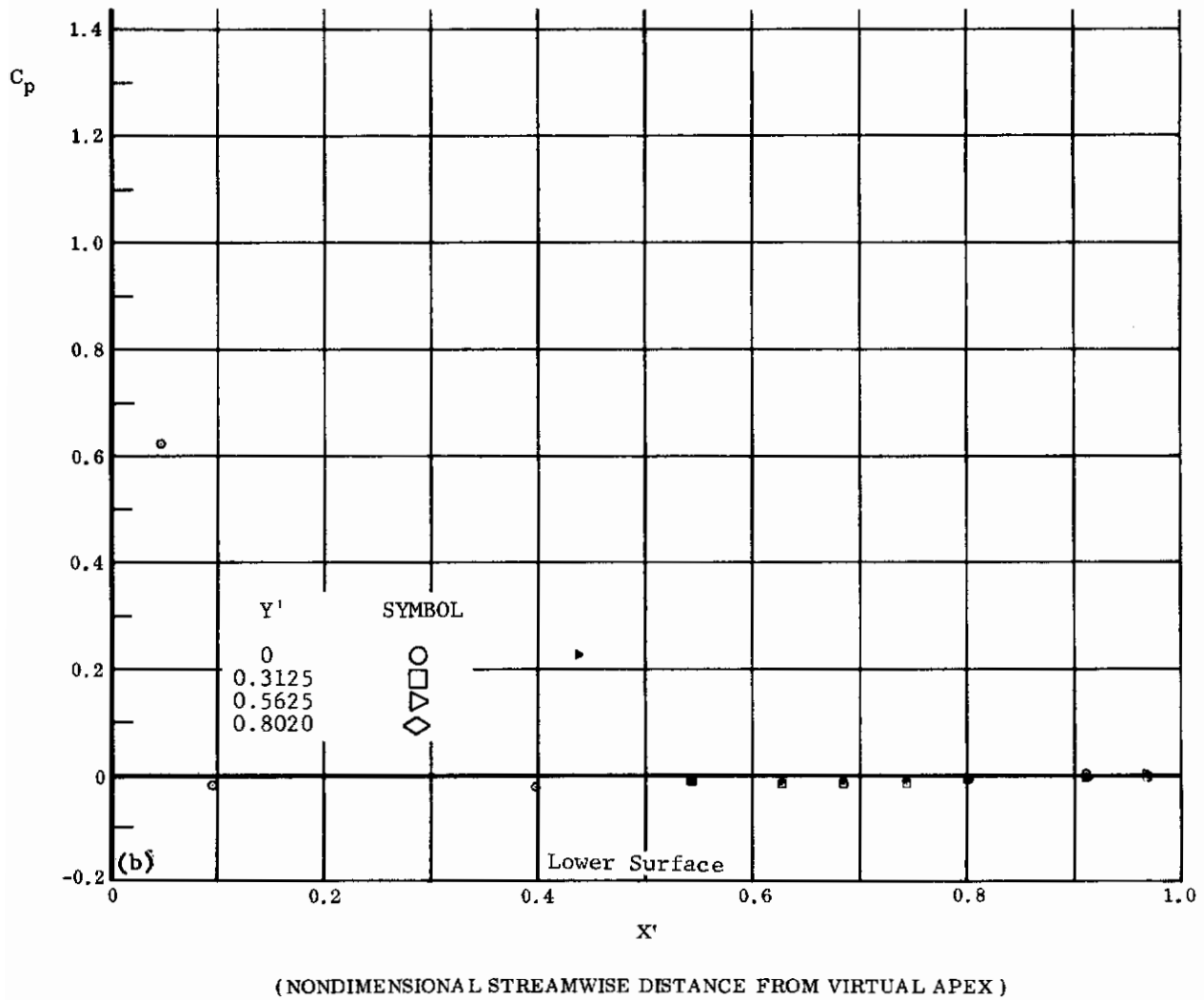
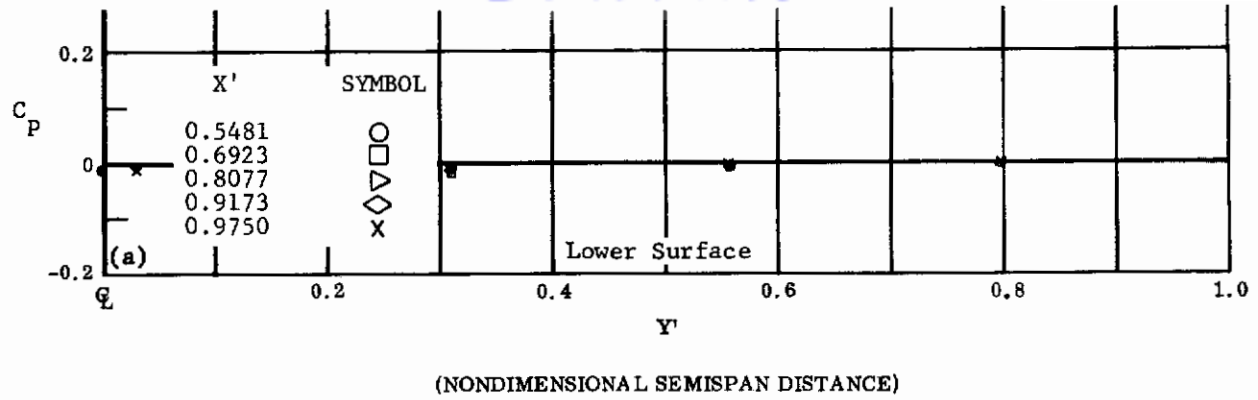

Fig. 48 Configuration IV, $\alpha = -50$, $\delta_2 = \delta_3 = 0$

a) C_p vs. Y' , lower surface

b) C_p vs. X' , lower surface

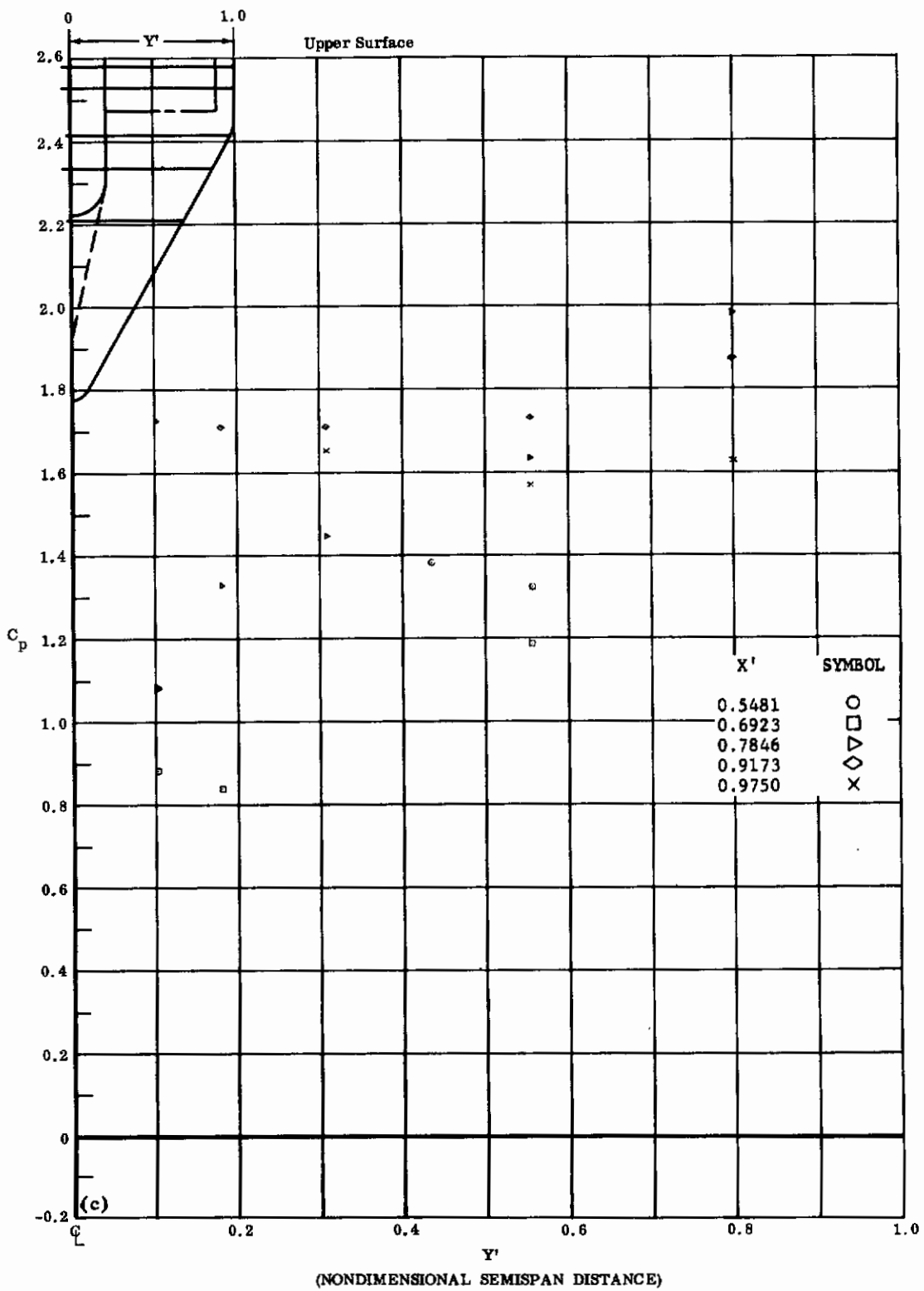
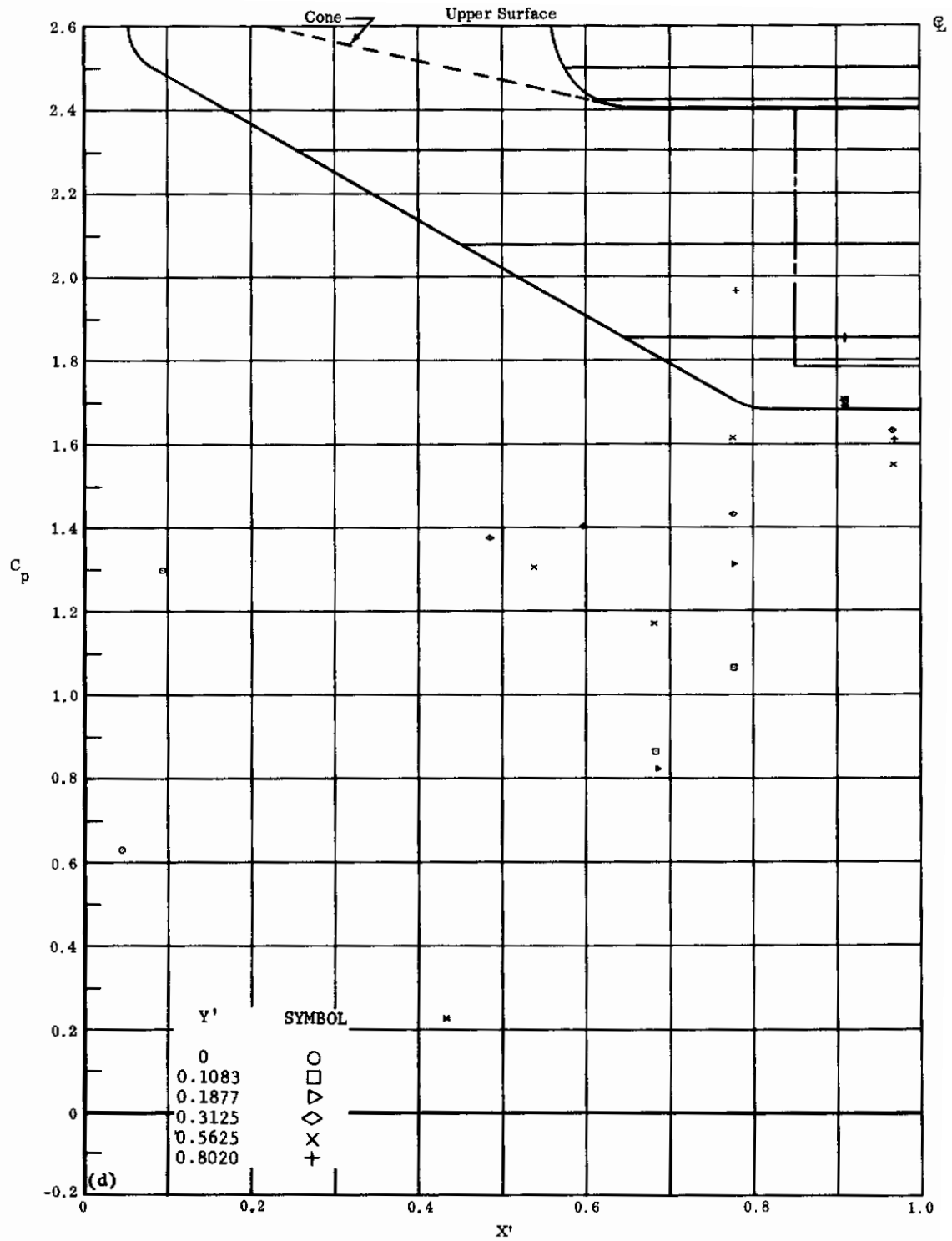

Fig. 48c Configuration IV, $\alpha = -50$, $\delta_2 = \delta_3 = 0$

C_p vs. Y' , upper surface

Contraails



(NONDIMENSIONAL STREAMWISE DISTANCE FROM VIRTUAL APEX)

Fig. 48d Configuration IV, $\alpha = -50$, $\delta_2 = \delta_3 = 0$

C_p vs. X' , upper surface

Contrails

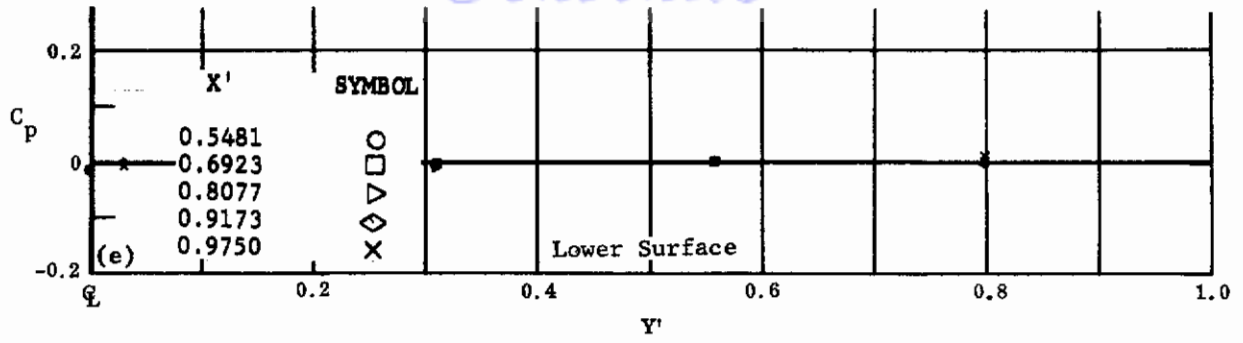

(NONDIMENSIONAL SEMISPAN DISTANCE)

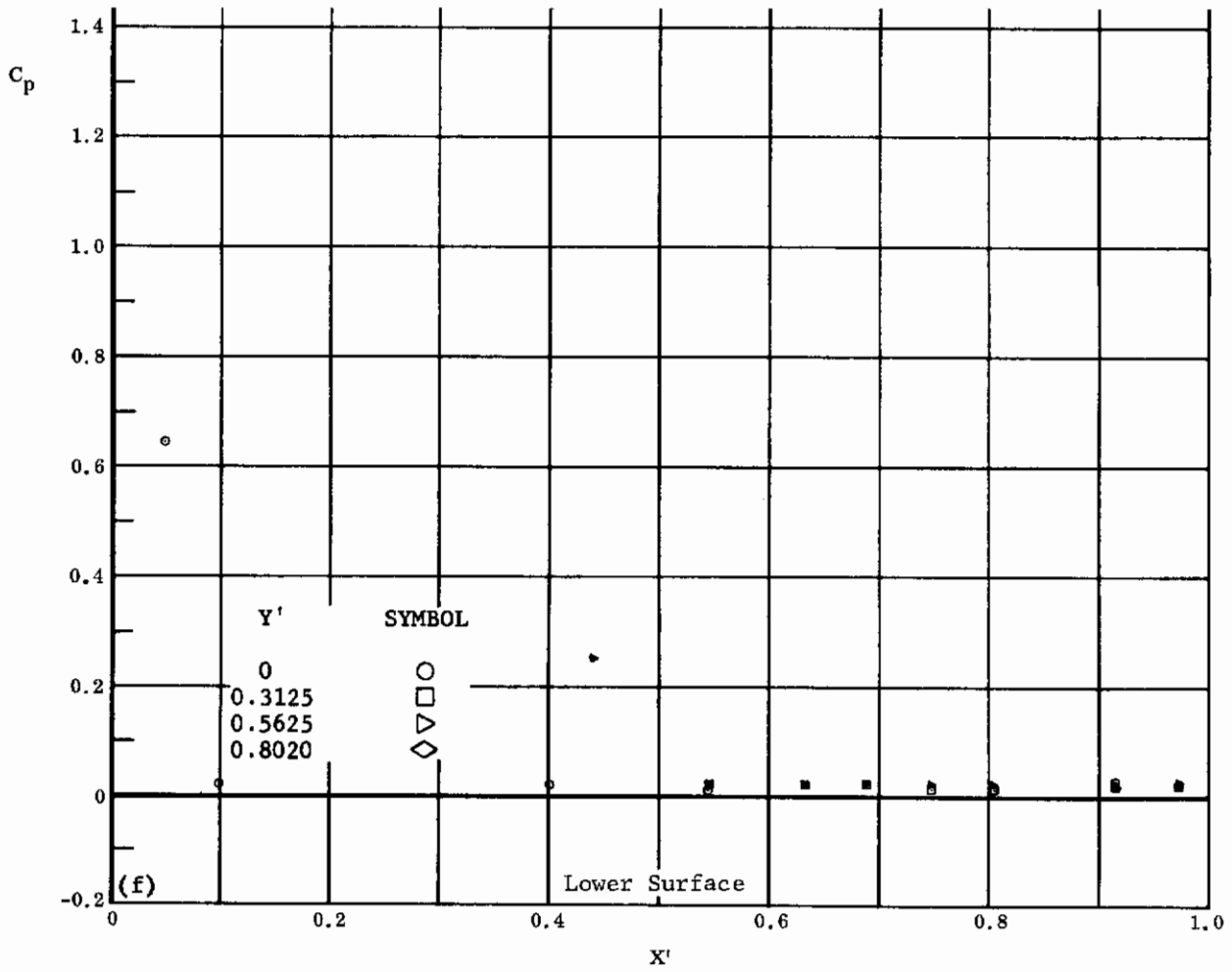

(NONDIMENSIONAL STREAMWISE DISTANCE FROM VIRTUAL APEX)

Fig. 48 Configuration IV, $\alpha = -50$, $\delta_2 = \delta_3 = +20$

e) C_p vs. Y' , lower surface

f) C_p vs. X' , lower surface

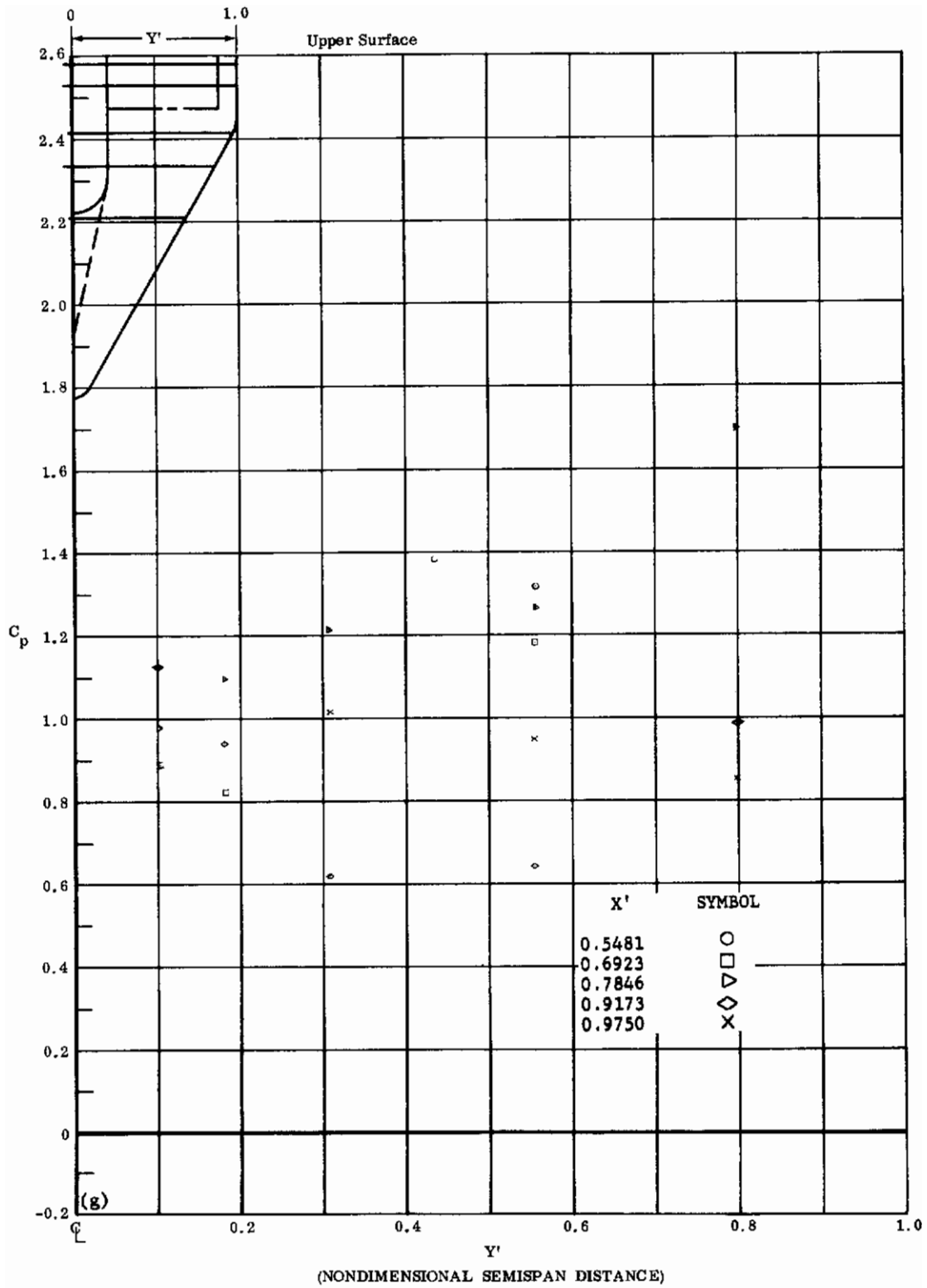
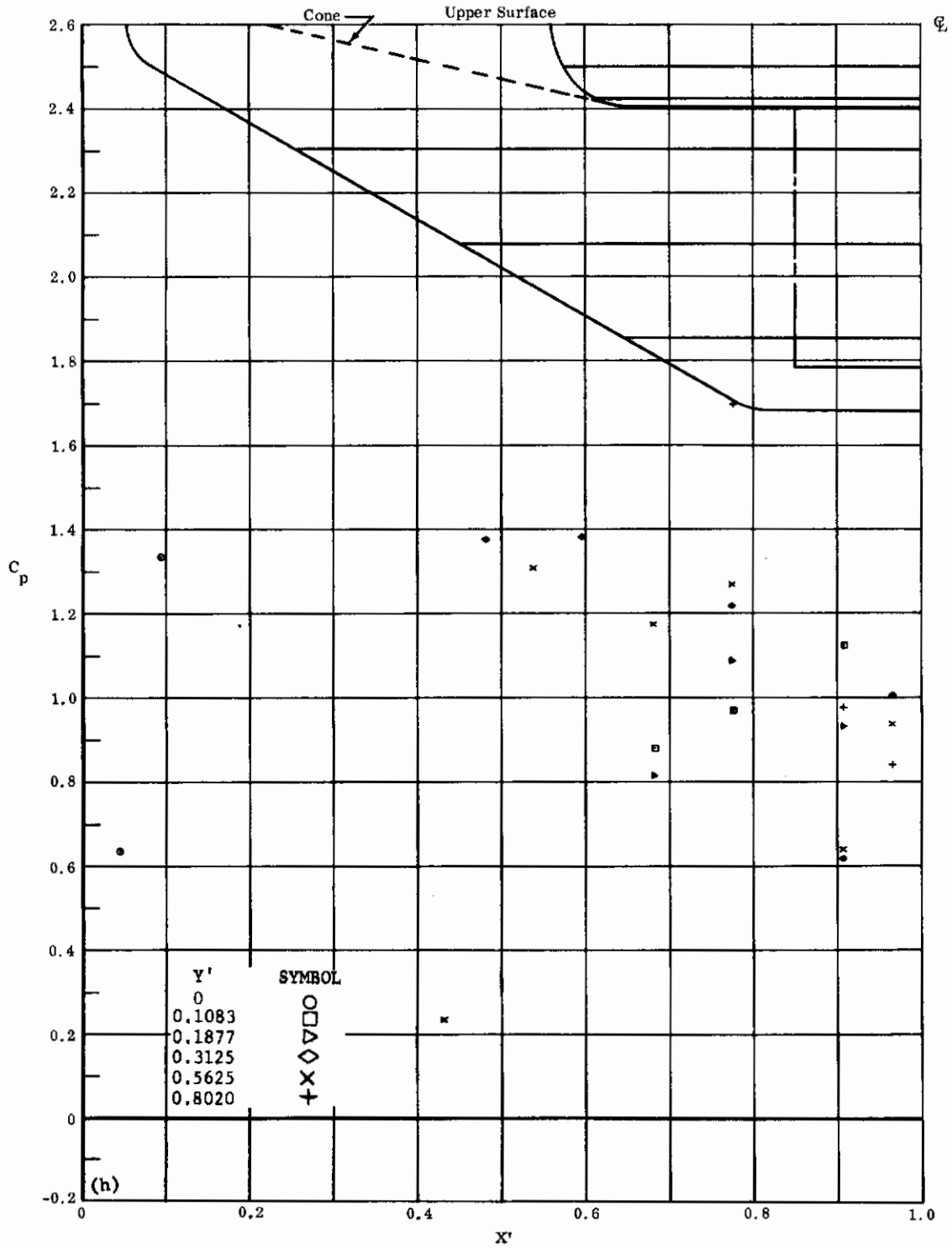

Fig. 48g Configuration IV, $\alpha = -50$, $\delta_2 = \delta_3 = +20$

C_p vs. Y' , upper surface

Contraails



(NONDIMENSIONAL STREAMWISE DISTANCE FROM VIRTUAL APEX)

Fig. 48h Configuration IV, $\alpha = -50$, $\delta_2 = \delta_3 = +20$

C_p vs. X' , upper surface

Contrails

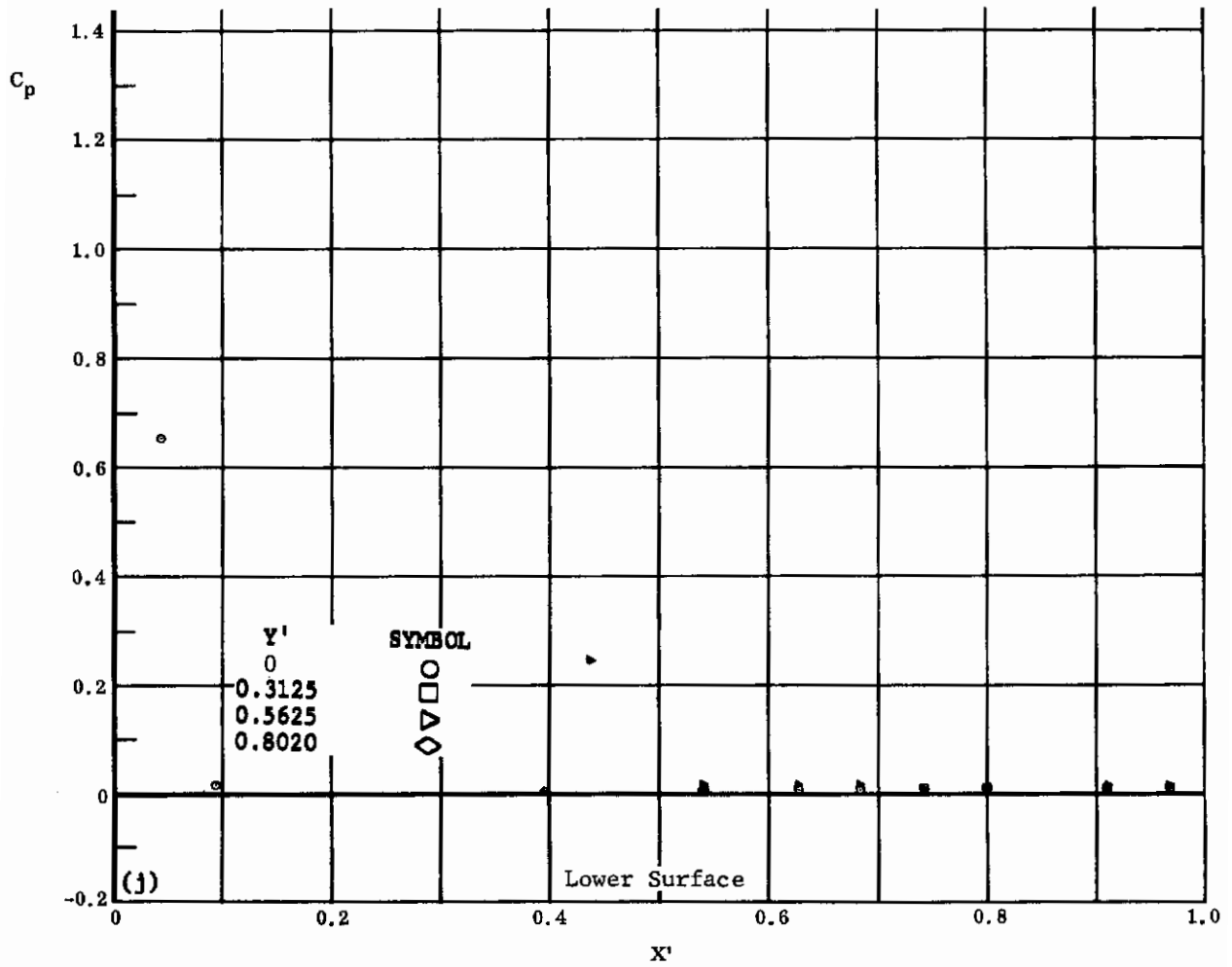
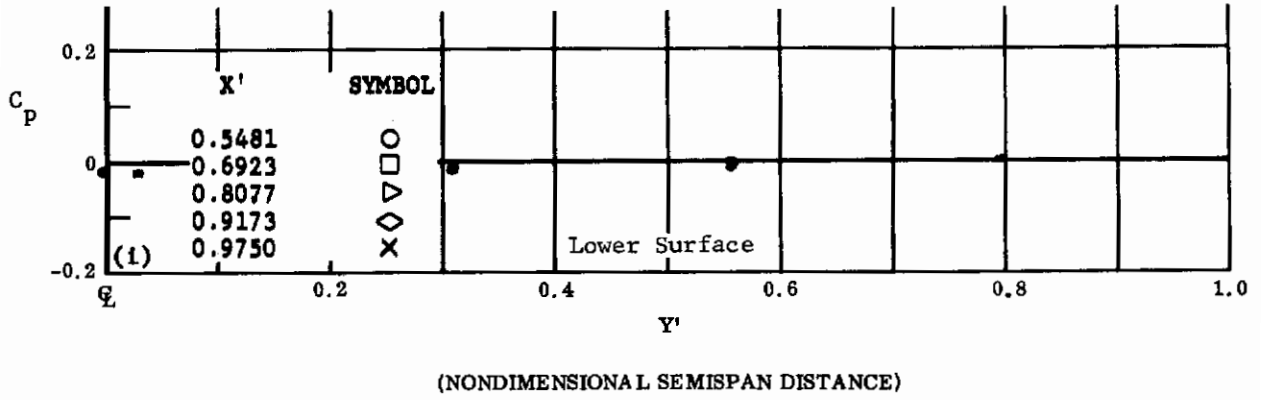

Fig. 48 Configuration IV, $\alpha = -50$, $\delta_2 = \delta_3 = +39$

i) C_p vs. Y' , lower surface

j) C_p vs. X' , lower surface

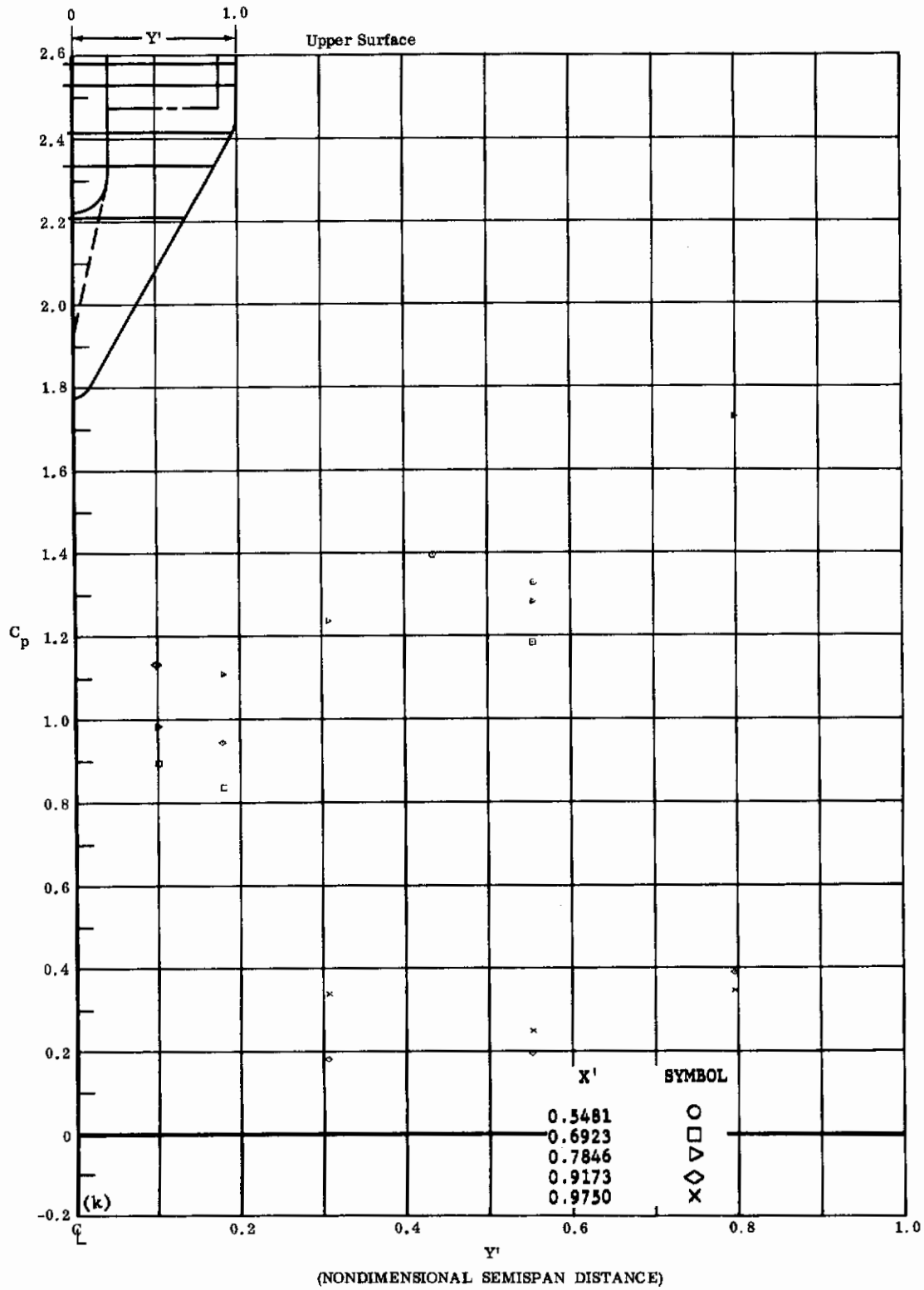
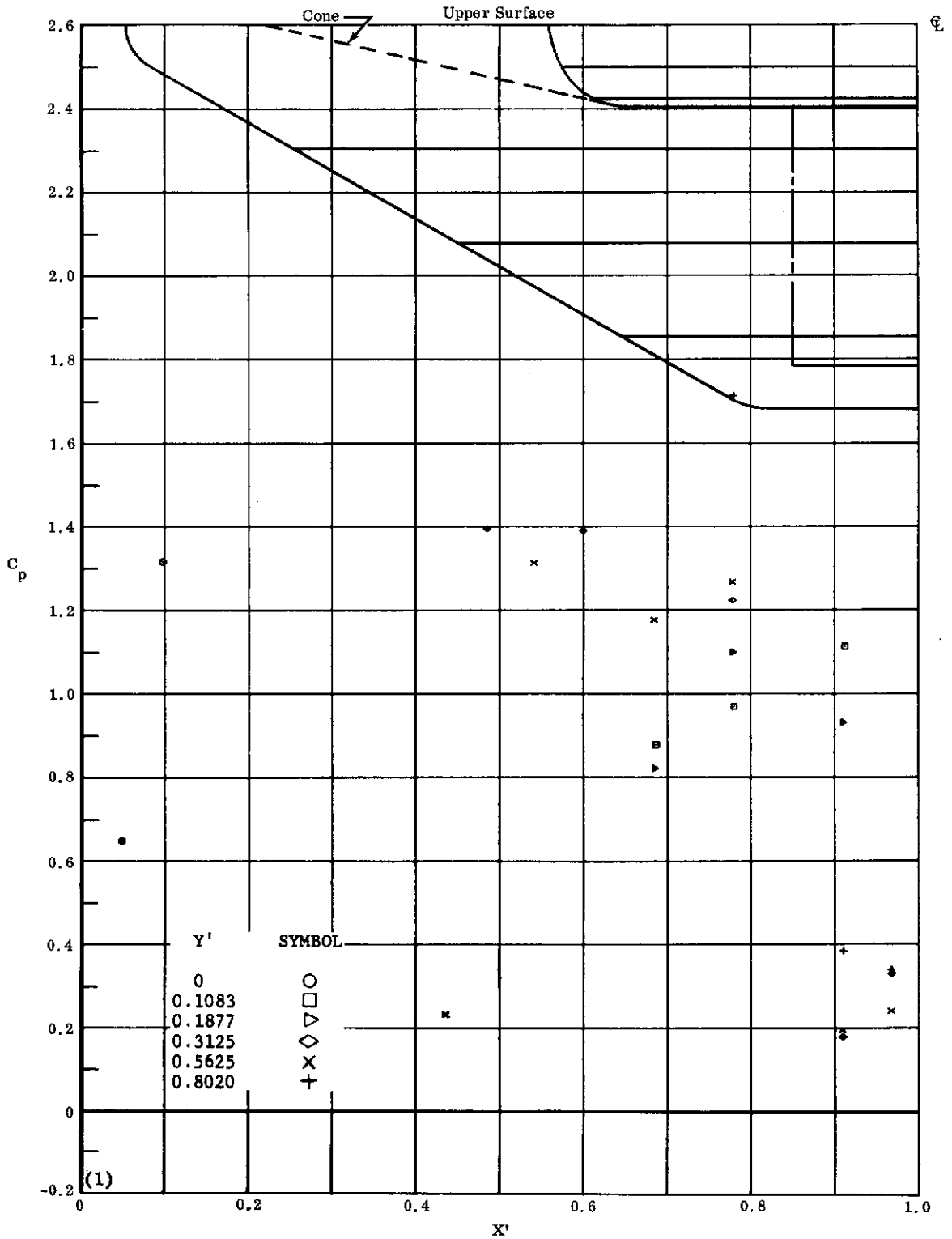

Fig. 48k Configuration IV, $\alpha = -50$, $\delta_2 = \delta_3 = +39$

C_p vs. Y' , upper surface



(NONDIMENSIONAL STREAMWISE DISTANCE FROM VIRTUAL APEX)

Fig. 481 Configuration IV, $\alpha = -50$, $\delta_2 = \delta_3 = +39$

C_p vs. X' , upper surface

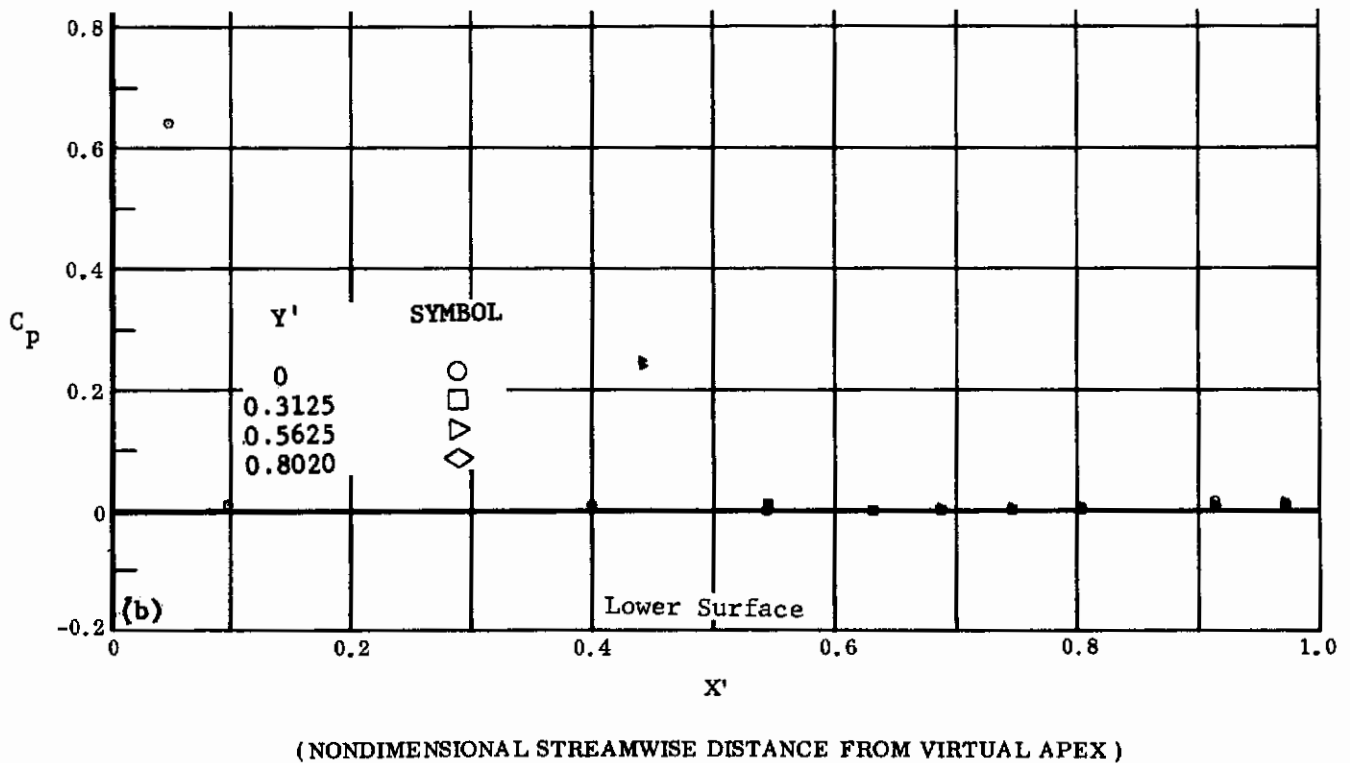
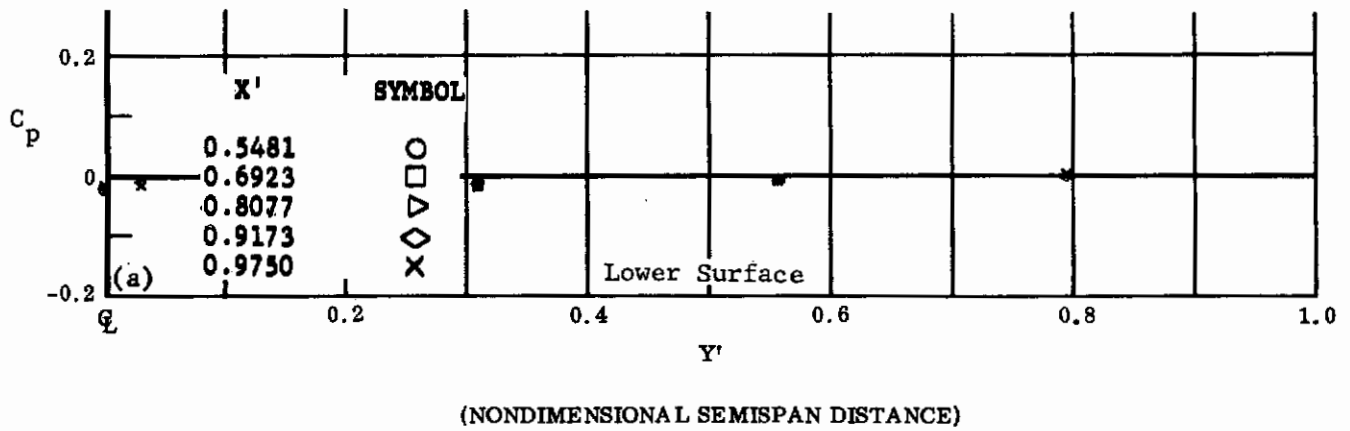

Fig. 49 Configuration IV, $\alpha = -50$, $\delta_2 = \delta_3 = -10$

a) C_p vs. Y' , lower surface

b) C_p vs. X' , lower surface

Contrails

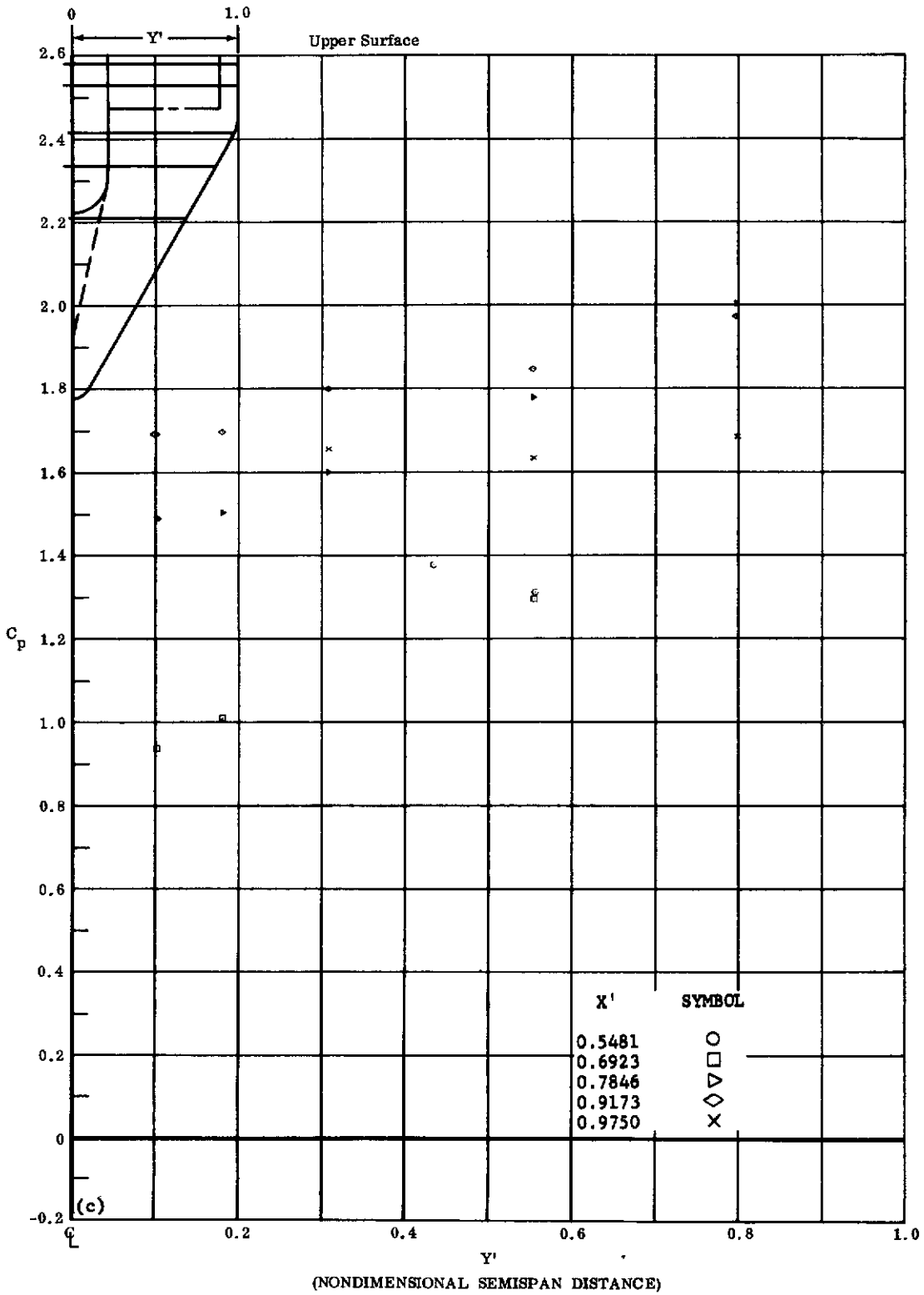
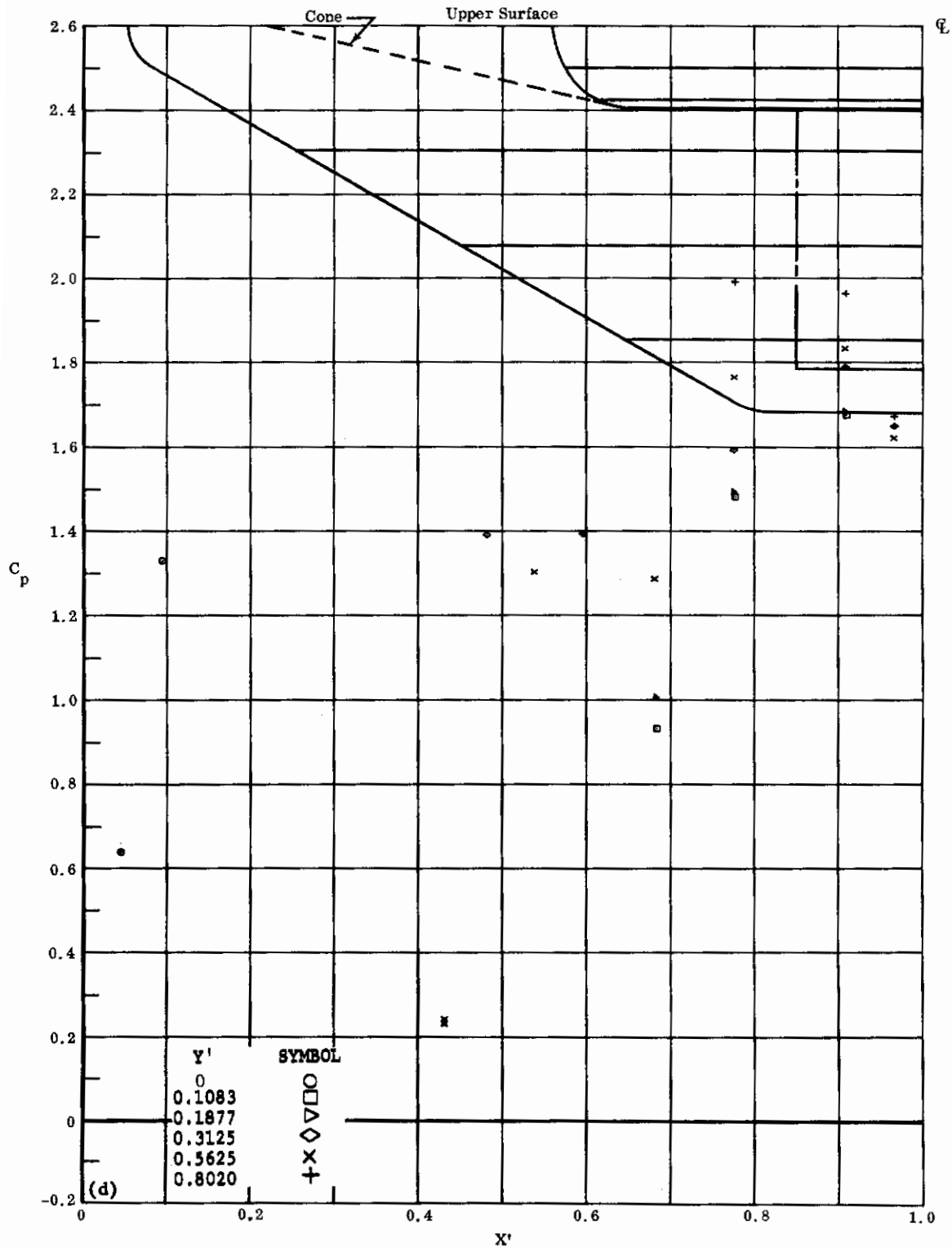

Fig. 49c Configuration IV, $\alpha = -50$, $\delta_2 = \delta_3 = -10$

C_p vs. Y' , upper surface



(NONDIMENSIONAL STREAMWISE DISTANCE FROM VIRTUAL APEX)

Fig. 49d Configuration IV, $\alpha = -50$, $\delta_2 = \delta_3 = -10$

C_p vs. X' , upper surface

Contrails

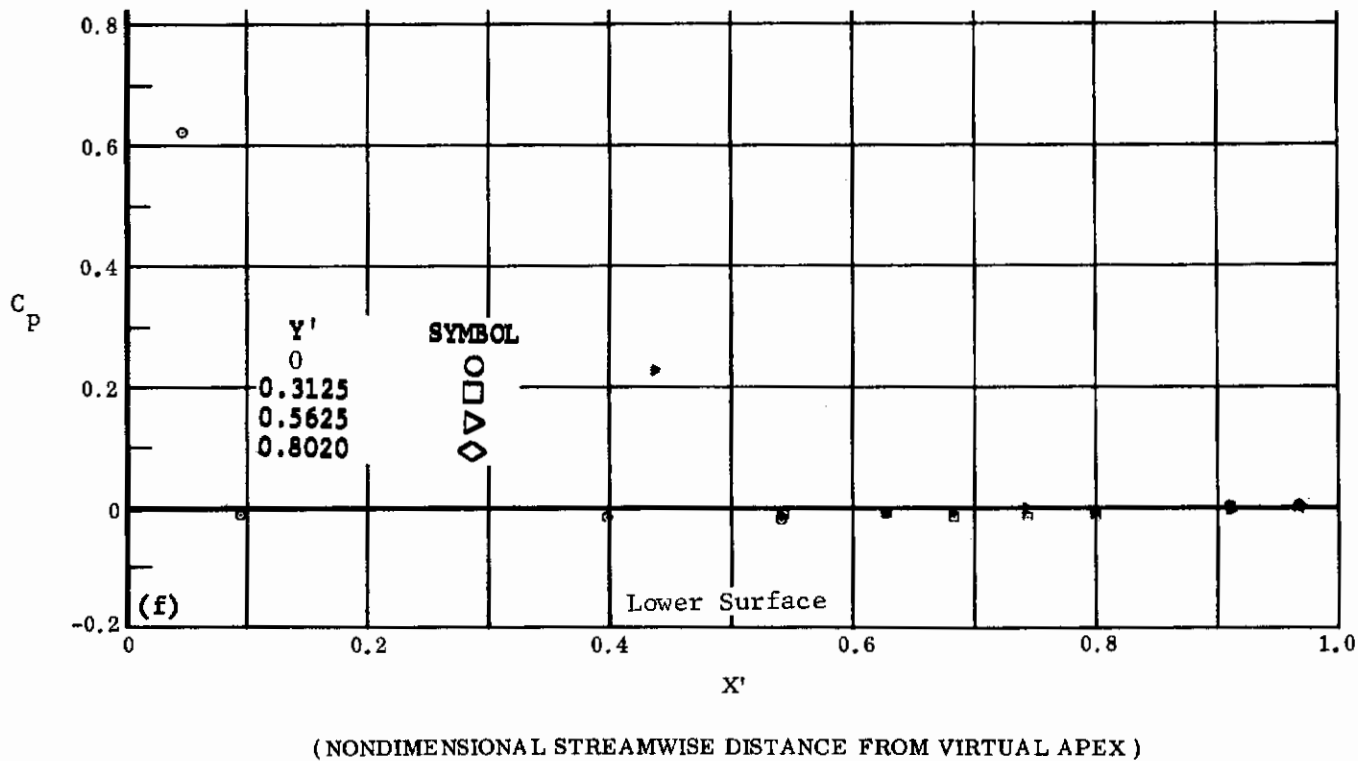
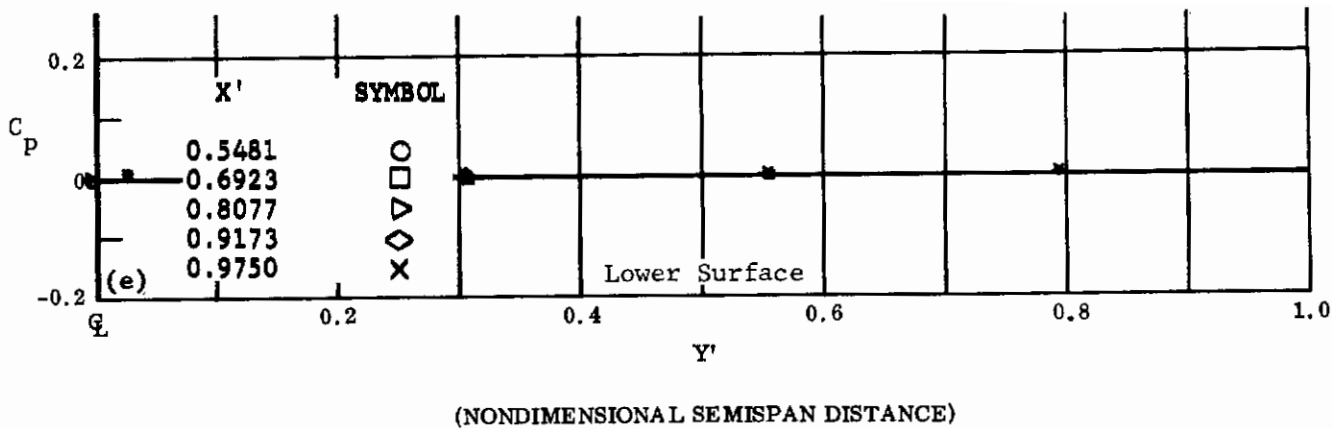

Fig. 49 Configuration IV, $\alpha = -50$, $\delta_2 = \delta_3 = -20$

e) C_p vs. Y' , lower surface

f) C_p vs. X' , lower surface

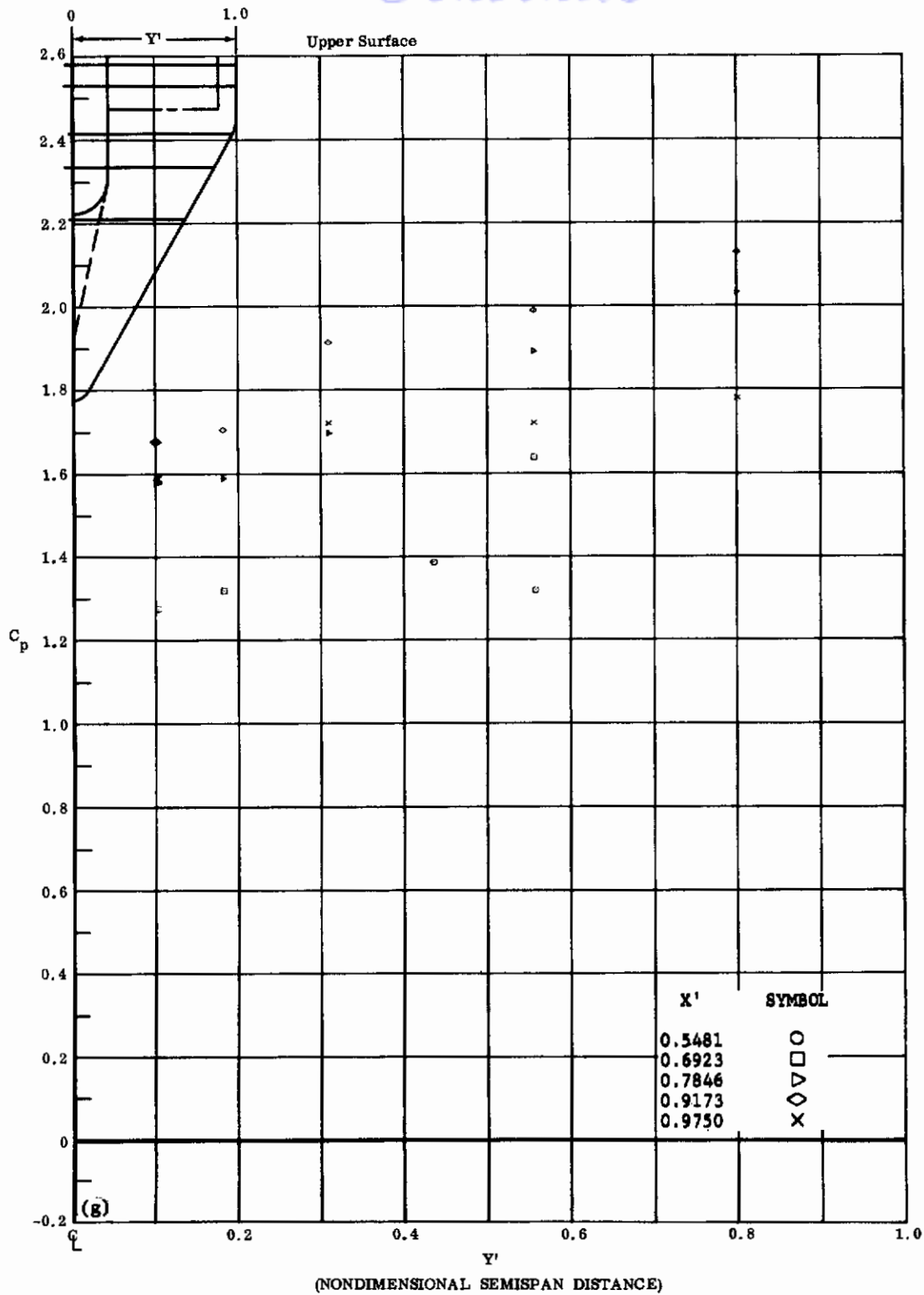
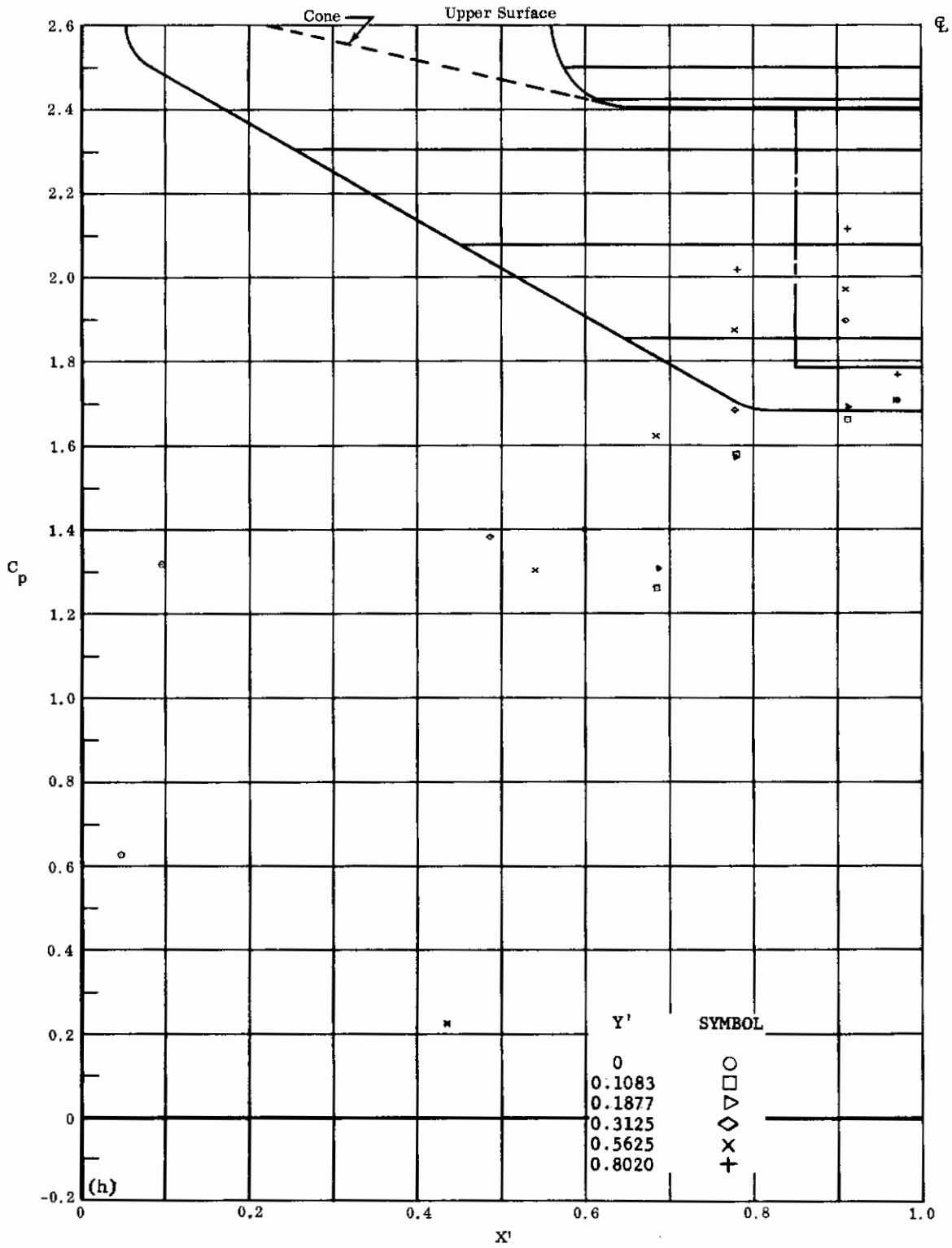

Fig. 49g Configuration IV, $\alpha = -50$, $\delta_2 = \delta_3 = -20$

C_p vs. Y' , upper surface



(NONDIMENSIONAL STREAMWISE DISTANCE FROM VIRTUAL APEX)

Fig. 49h Configuration IV, $\alpha = -50$, $\delta_2 = \delta_3 = -20$

C_p vs. X' , upper surface

Contrails

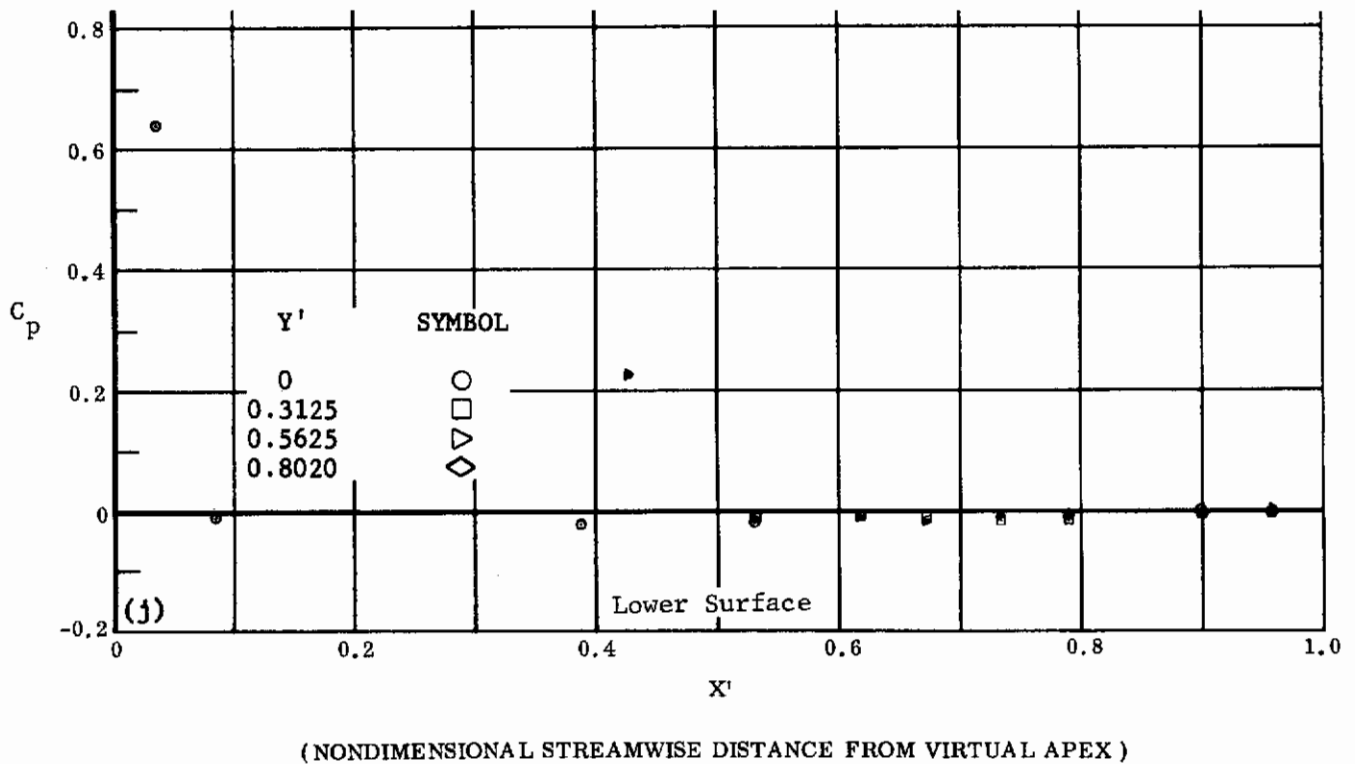
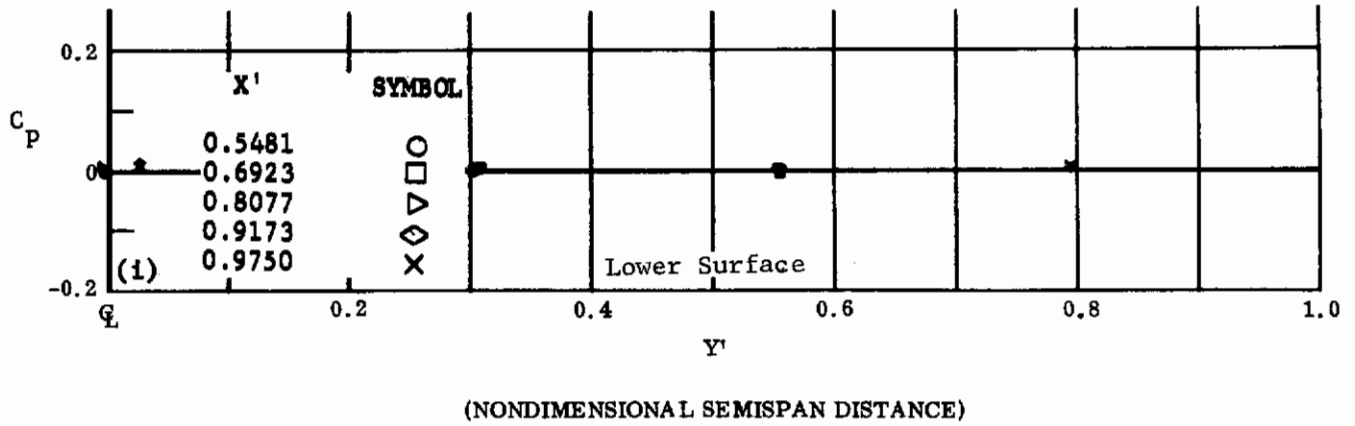

Fig. 49 Configuration IV, $\alpha = -50$, $\delta_2 = \delta_3 = -30$

- i) C_p vs. Y' , lower surface
- j) C_p vs. X' , lower surface

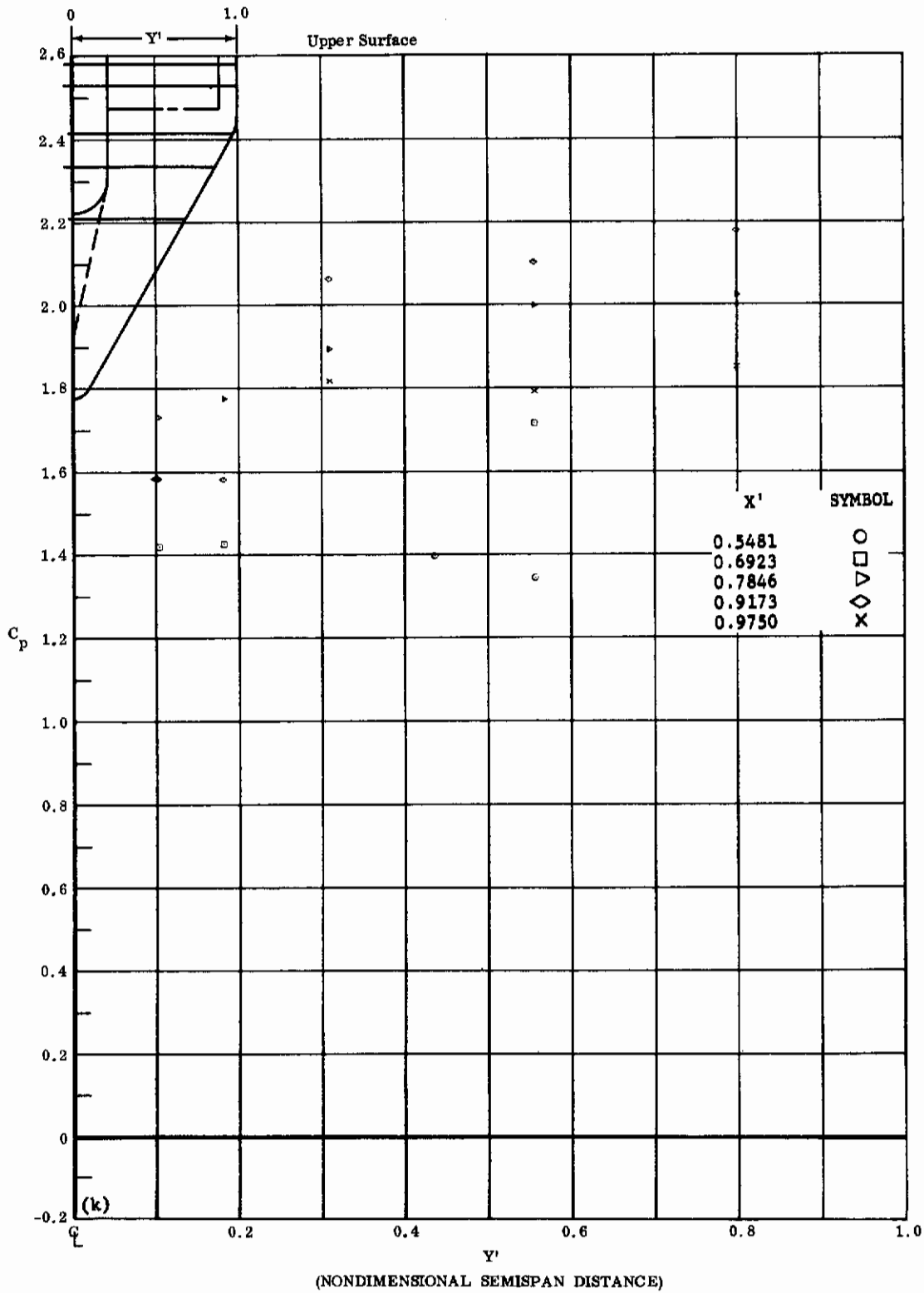
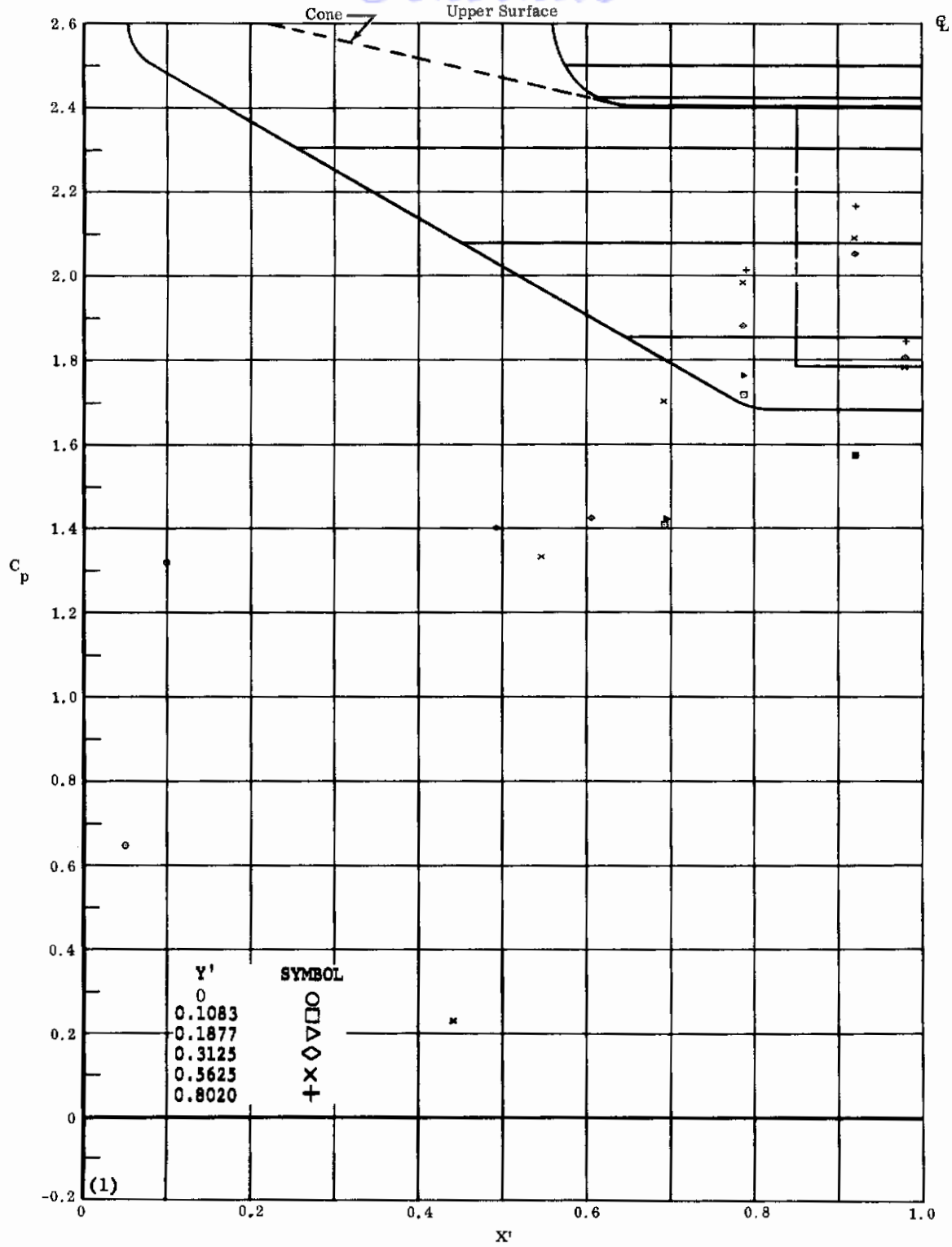

Fig. 49k Configuration IV, $\alpha = -50$, $\delta_2 = \delta_3 = -30$

C_p vs. Y' , upper surface



(NONDIMENSIONAL STREAMWISE DISTANCE FROM VIRTUAL APEX)

Fig. 491 Configuration IV, $\alpha = -50$, $\delta_2 = \delta_3 = -30$

C_p vs. X' , upper surface

Contrails

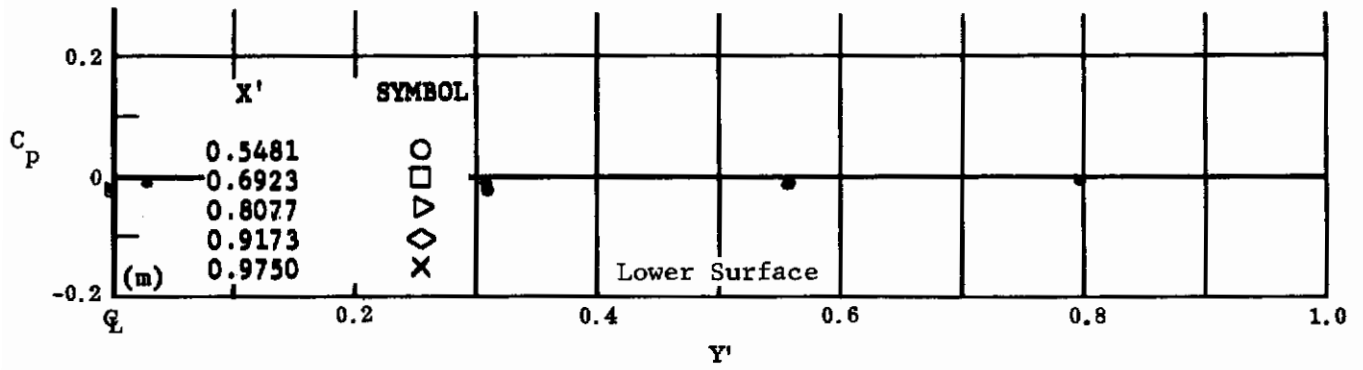

(NONDIMENSIONAL SEMISPAN DISTANCE)

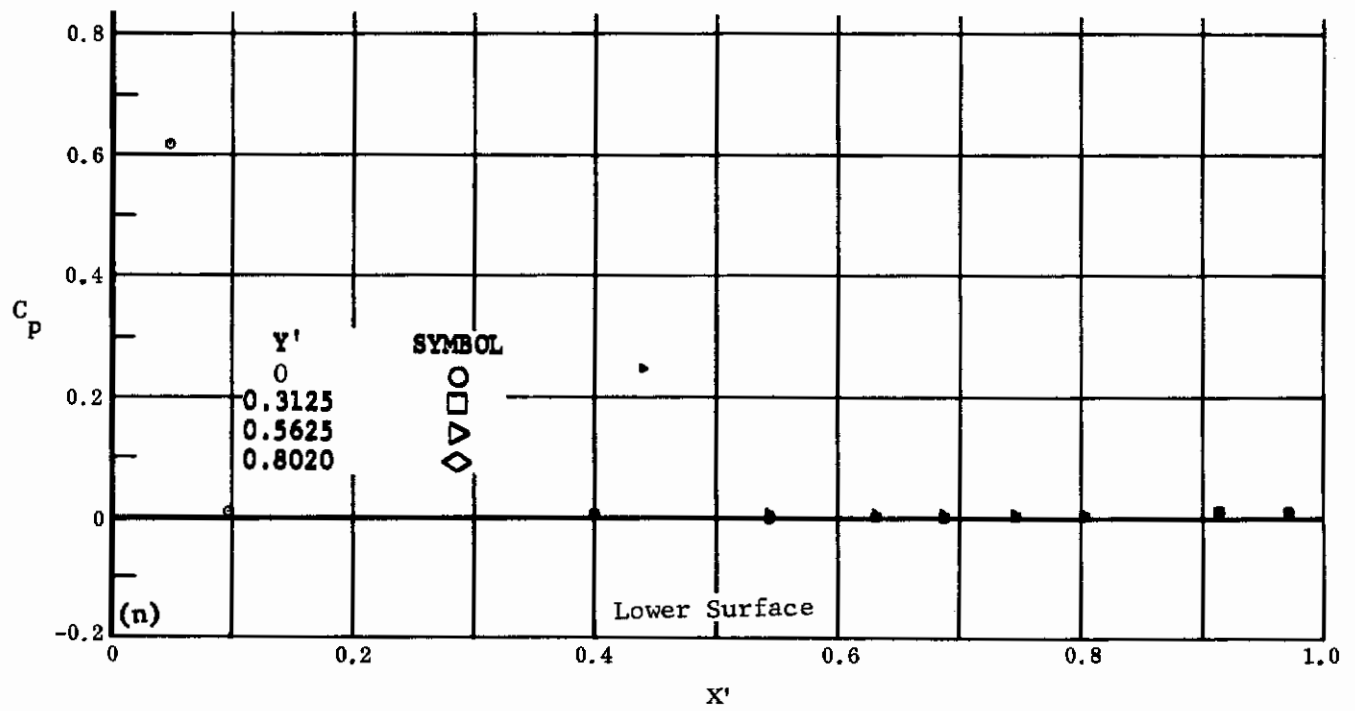

(NONDIMENSIONAL STREAMWISE DISTANCE FROM VIRTUAL APEX)

Fig. 49 Configuration IV, $\alpha = -50$, $\delta_2 = \delta_3 = -39$

m) C_p vs. Y' , lower surface

n) C_p vs. X' , lower surface

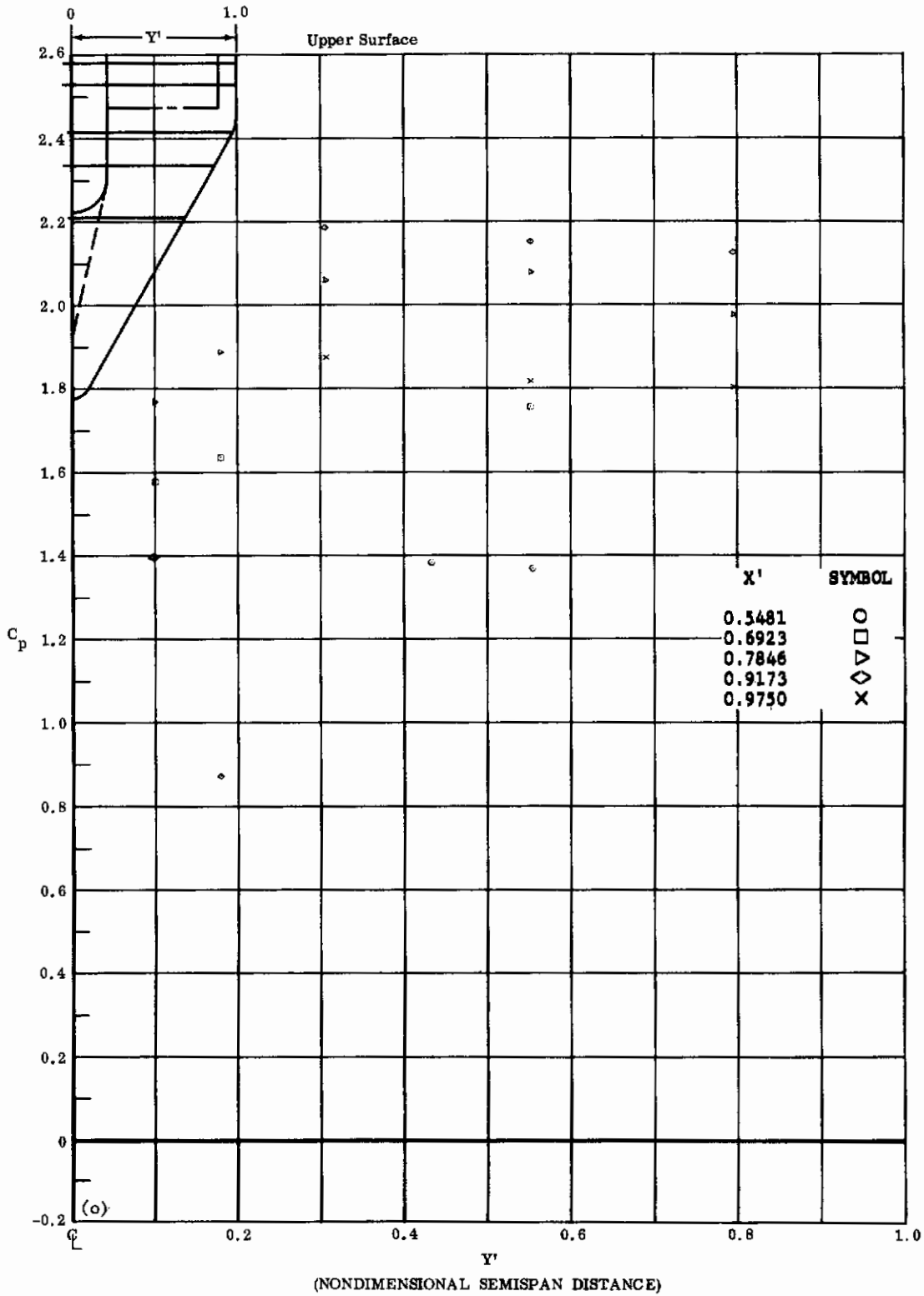
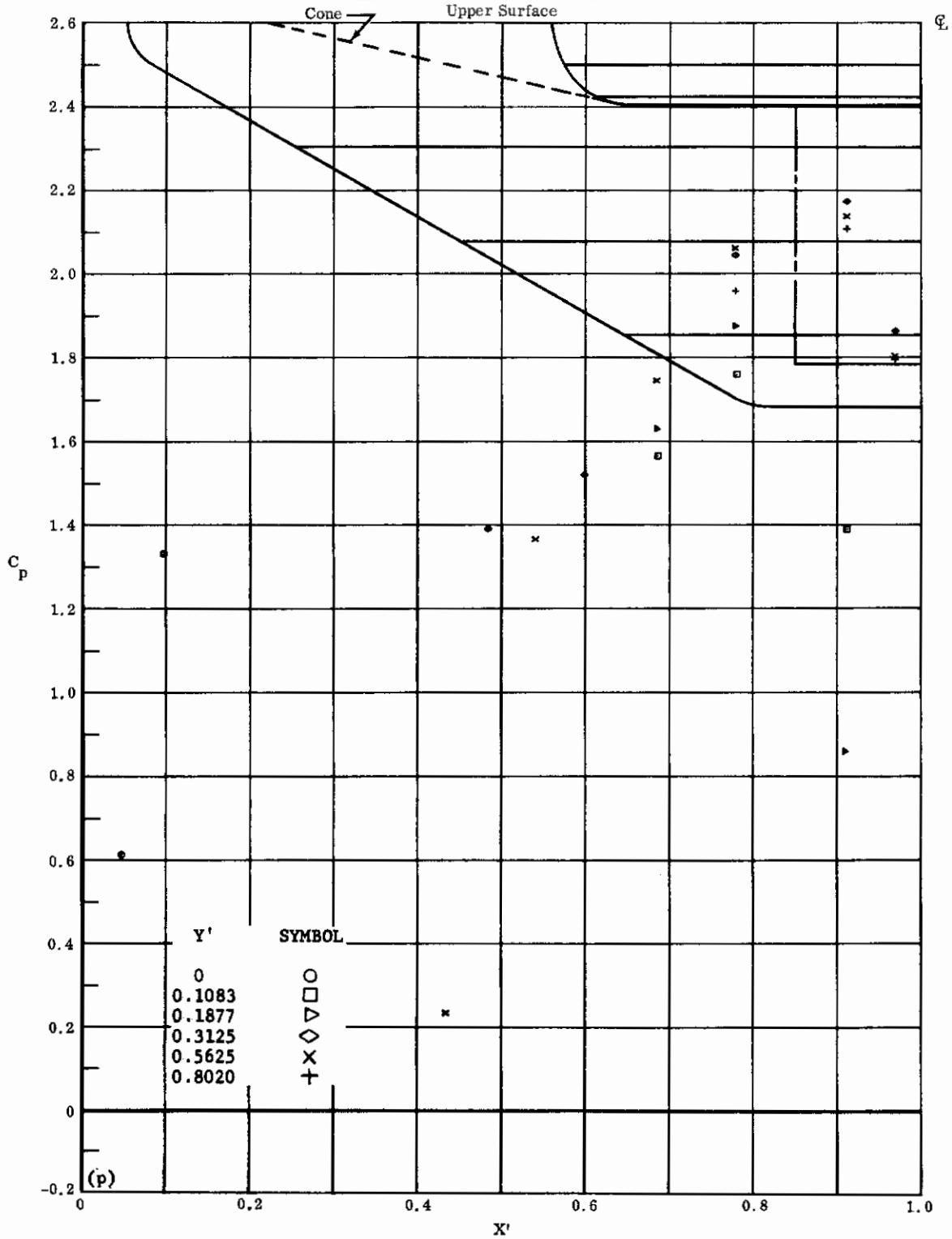

Fig. 49c Configuration IV, $\alpha = -50$, $\delta_2 = \delta_3 = -39$

C_p vs. Y' , upper surface



(NONDIMENSIONAL STREAMWISE DISTANCE FROM VIRTUAL APEX)

Fig. 49p Configuration IV, $\alpha = -50$, $\delta_2 = \delta_3 = -39$

C_p vs. X' , upper surface

Contrails

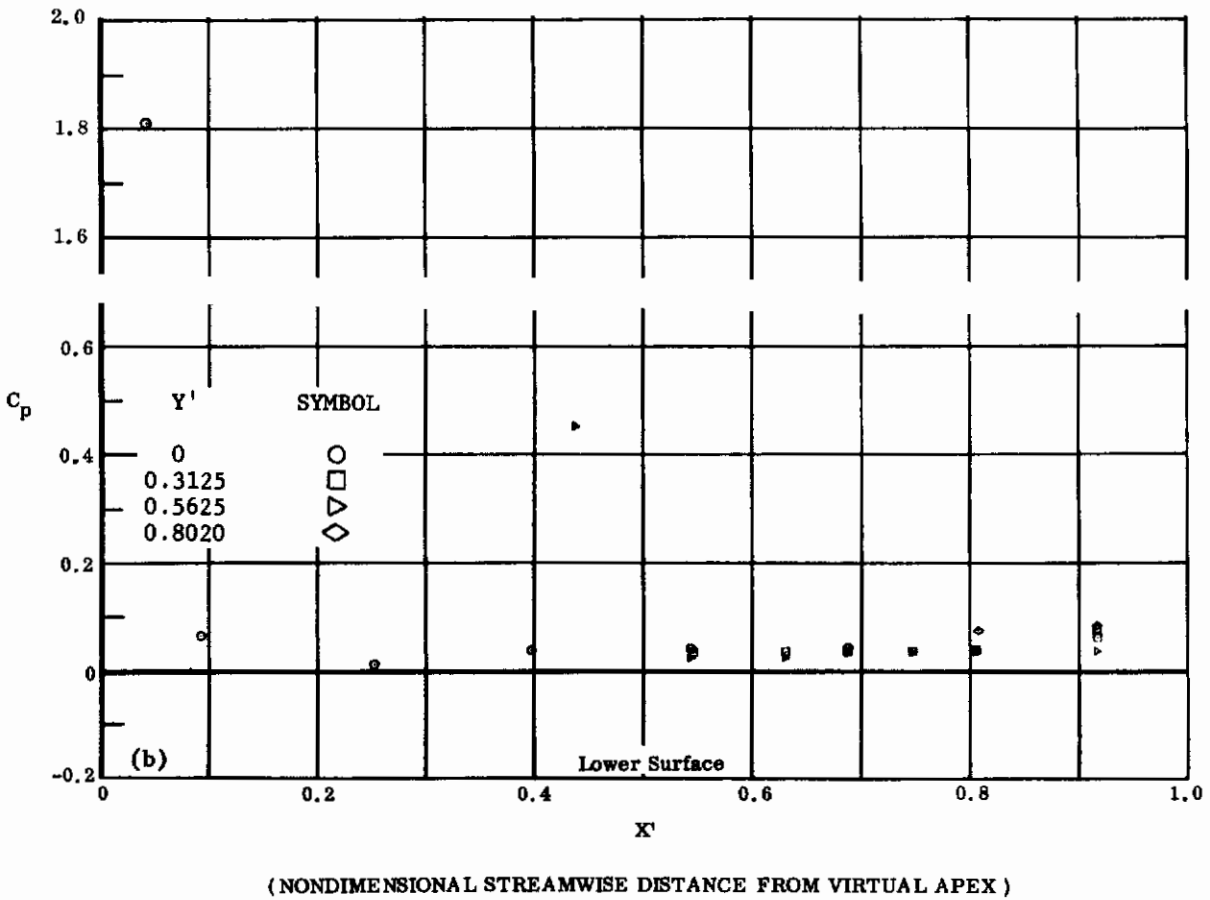
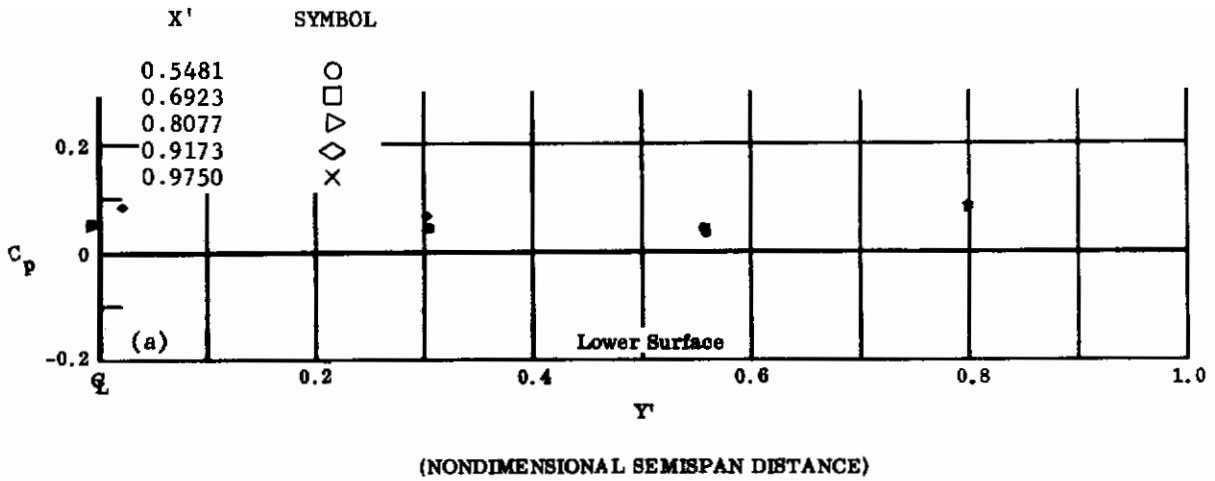

Fig. 50 Configuration VII, Spoiler On

- a) C_p vs. Y' , $\alpha = 0$, $Re_{\infty}/ft \times 10^{-6} = 3.3$, lower surface
- b) C_p vs. X' , $\alpha = 0$, $Re_{\infty}/ft \times 10^{-6} = 3.3$, lower surface

Contrails

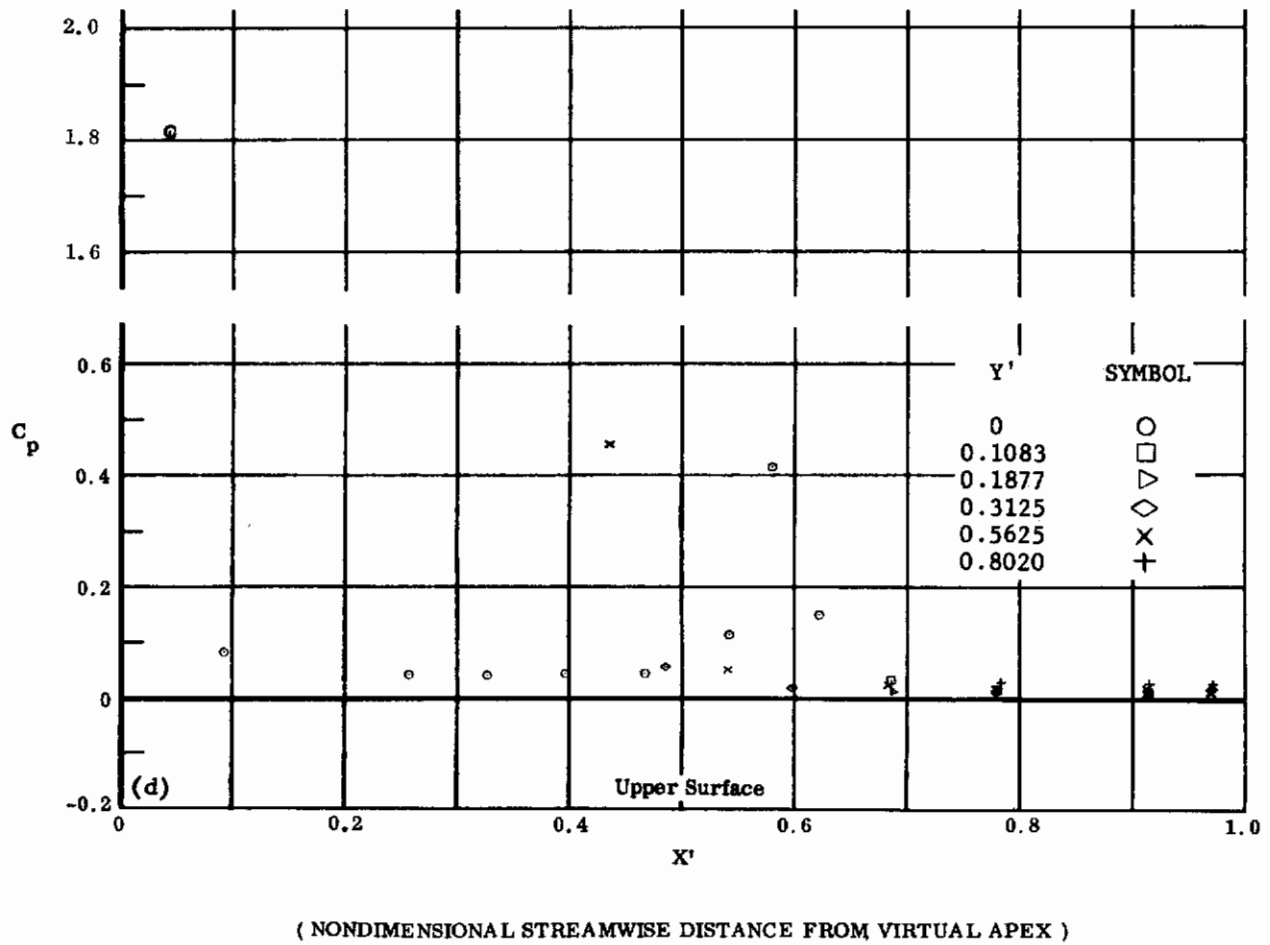
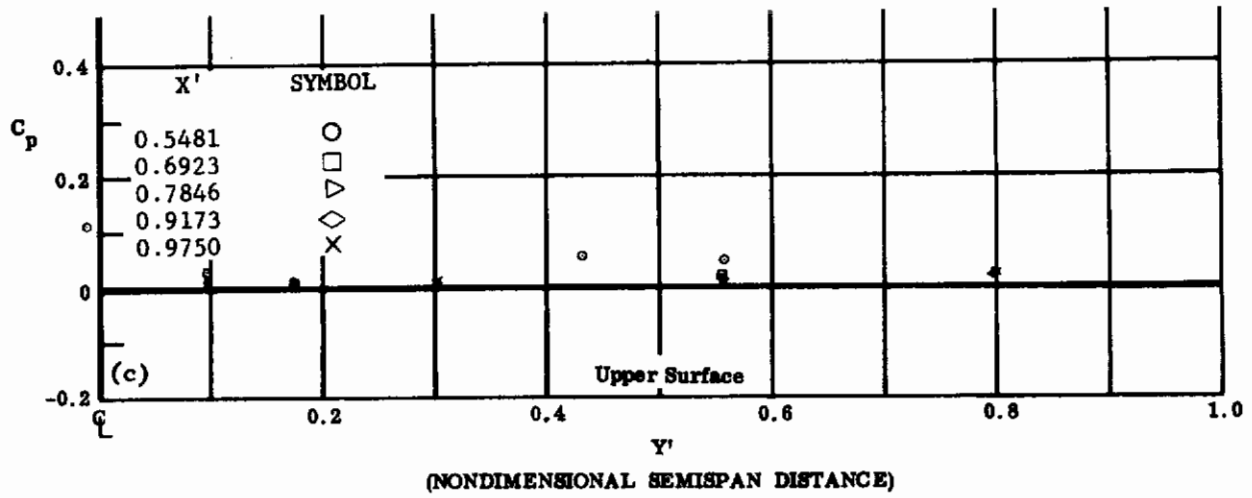
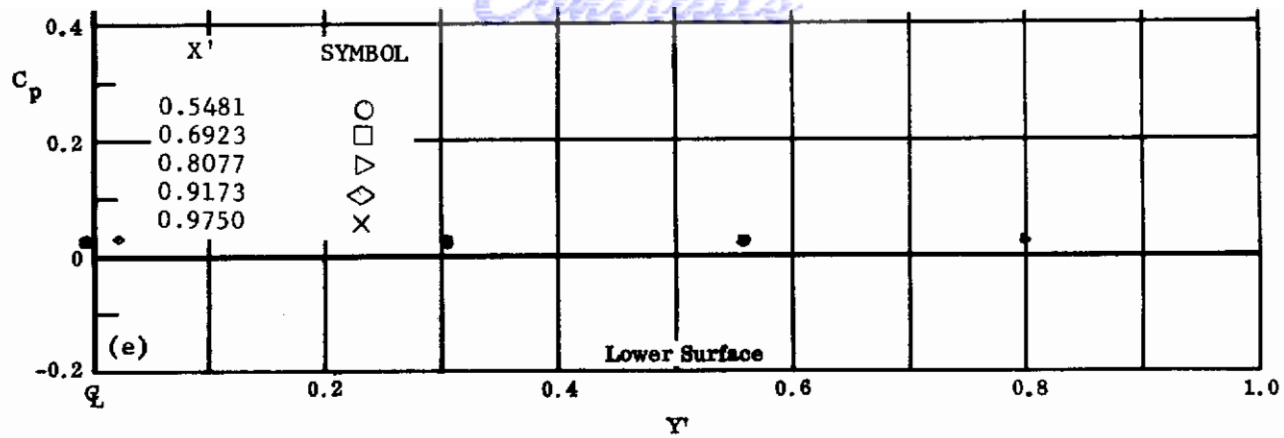

Fig. 50 Configuration VII, Spoiler On

c) C_p vs. Y' , $\alpha = 0$, $Re_{\infty}/ft \times 10^{-6} = 3.3$, upper surface

d) C_p vs. X' , $\alpha = 0$, $Re_{\infty}/ft \times 10^{-6} = 3.3$, upper surface

Controls



(NONDIMENSIONAL SEMISPAN DISTANCE)

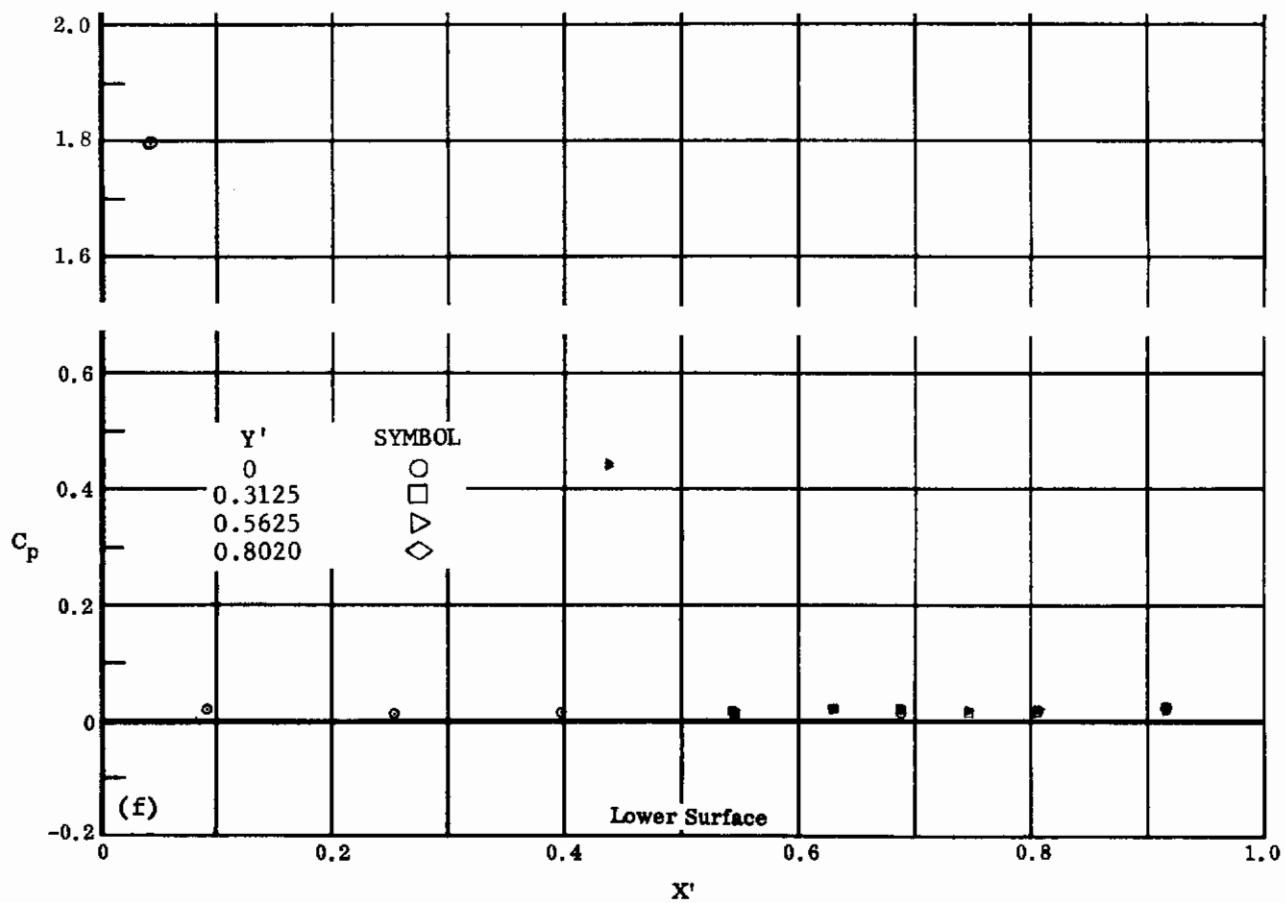

(NONDIMENSIONAL STREAMWISE DISTANCE FROM VIRTUAL APEX)

Fig. 50 Configuration VII, Spoiler On

e) C_p vs. Y' , $\alpha = -10$, $Re_{\infty}/ftx10^{-6} = 3.3$, lower surface

f) C_p vs. X' , $\alpha = -10$, $Re_{\infty}/ftx10^{-6} = 3.3$, lower surface

Contrails

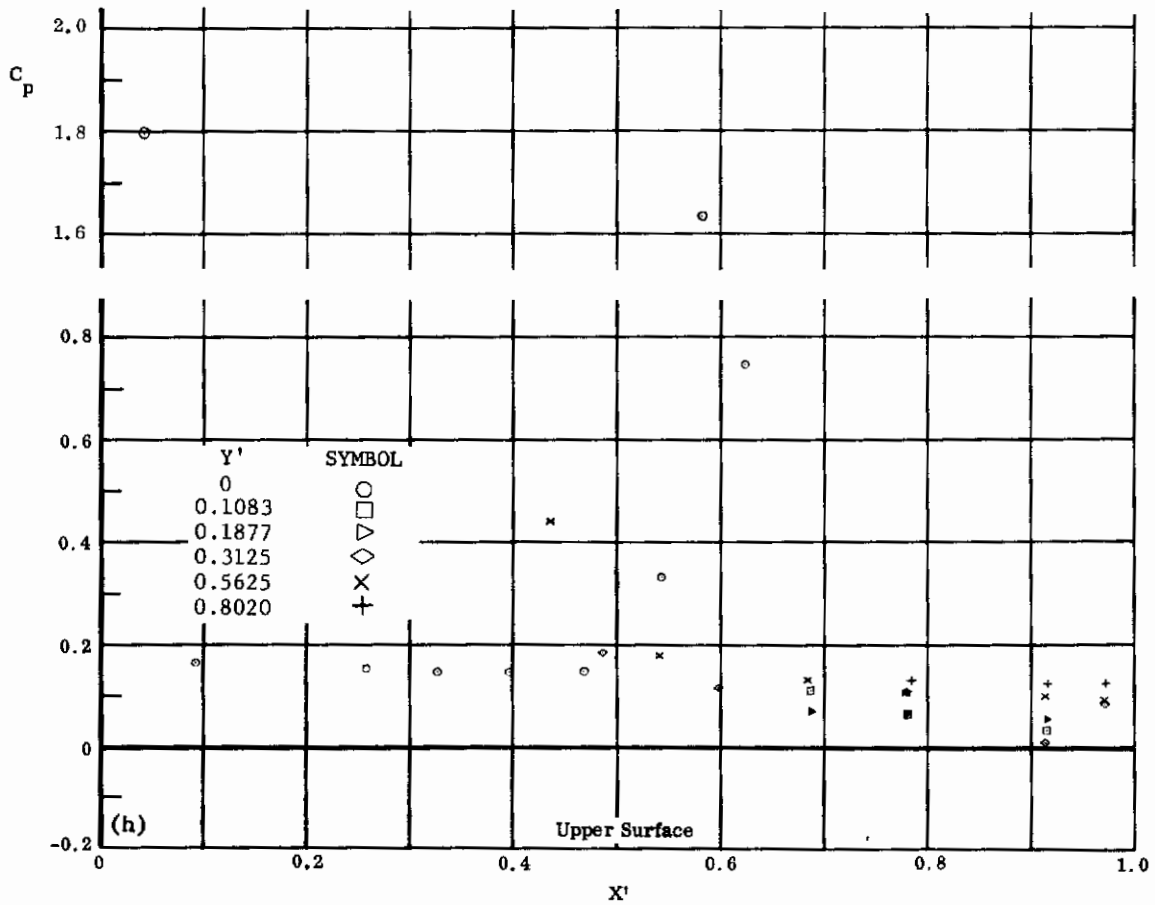
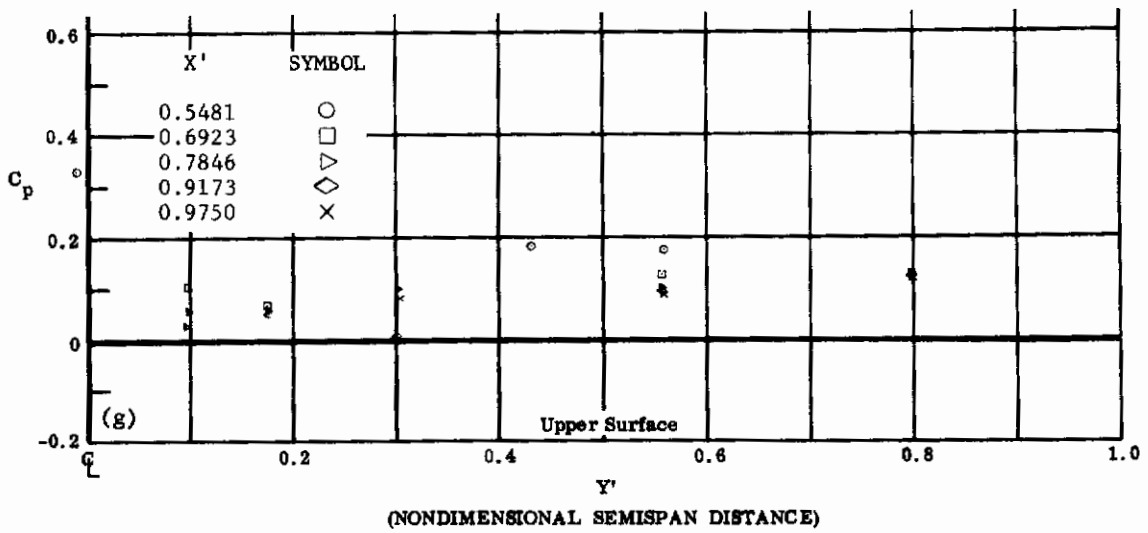

Fig. 50 Configuration VII, Spoiler On

g) C_p vs. Y' , $\alpha = -10$, $Re_\infty / ft \times 10^{-6} = 3.3$, upper surface

h) C_p vs. X' , $\alpha = -10$, $Re_\infty / ft \times 10^{-6} = 3.3$, upper surface

Contrails

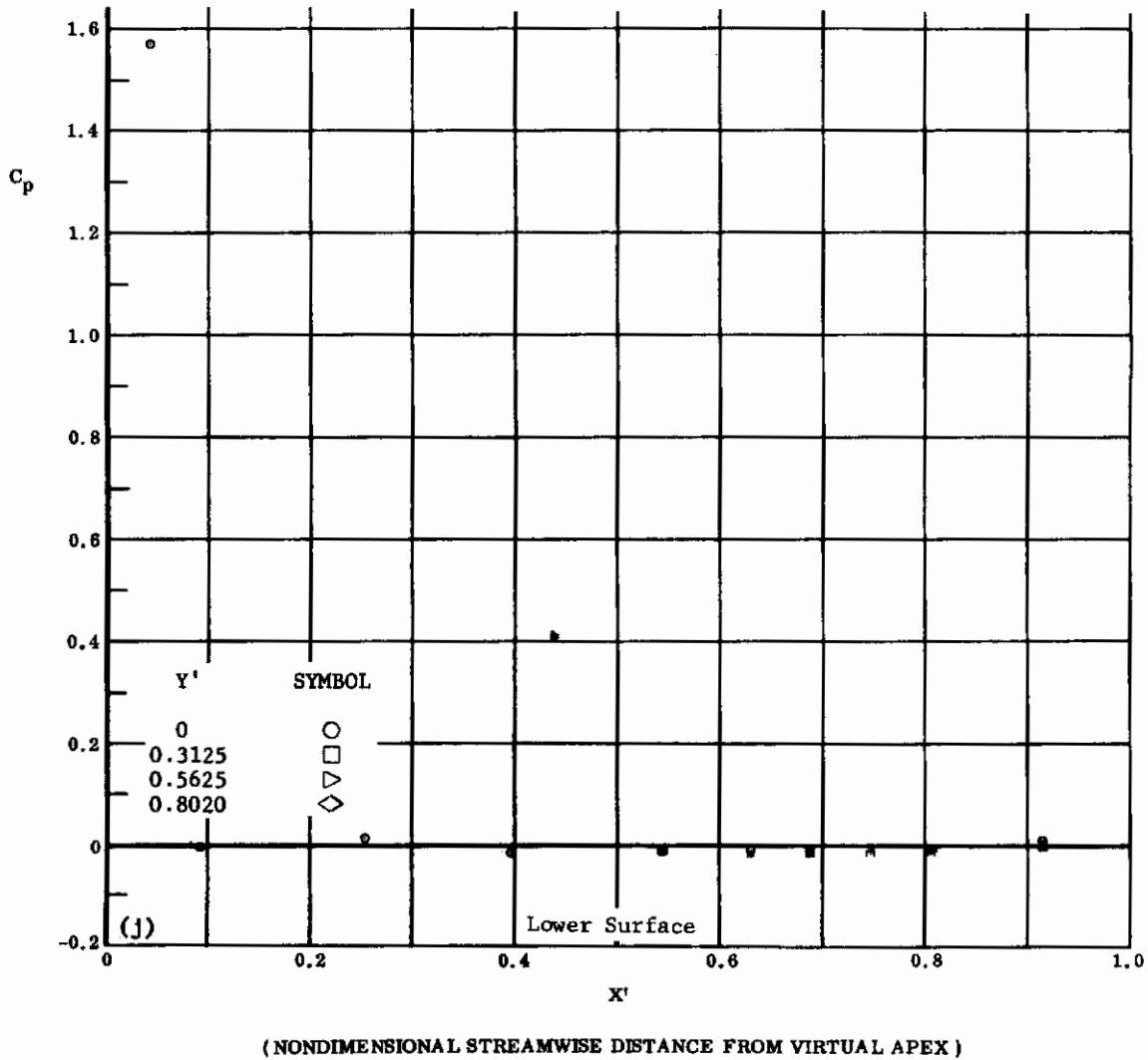
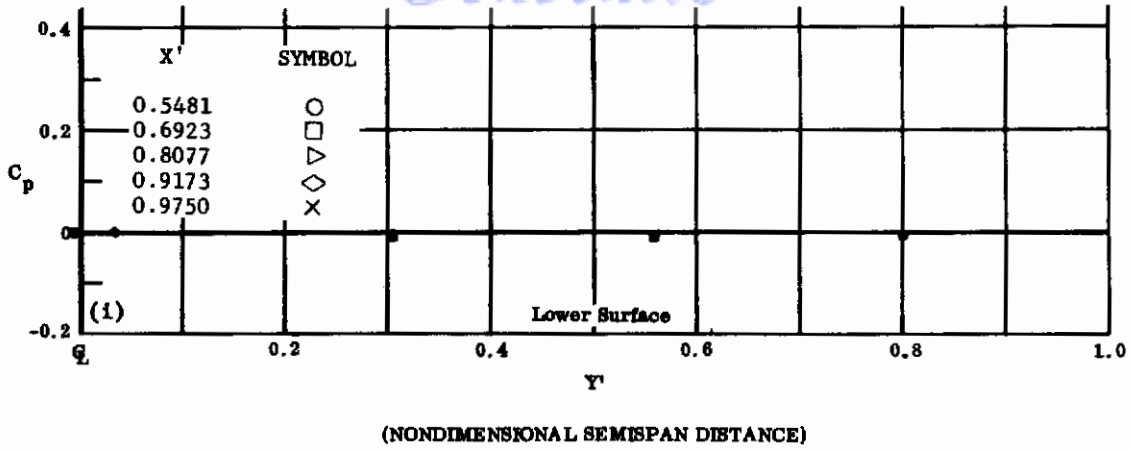

Fig. 50 Configuration VII, Spoiler On

- i) C_p vs. Y' , $\alpha = -20$, $Re_{\infty} / ft \times 10^{-6} = 3.3$, lower surface
- j) C_p vs. X' , $\alpha = -20$, $Re_{\infty} / ft \times 10^{-6} = 3.3$, lower surface

Contrails

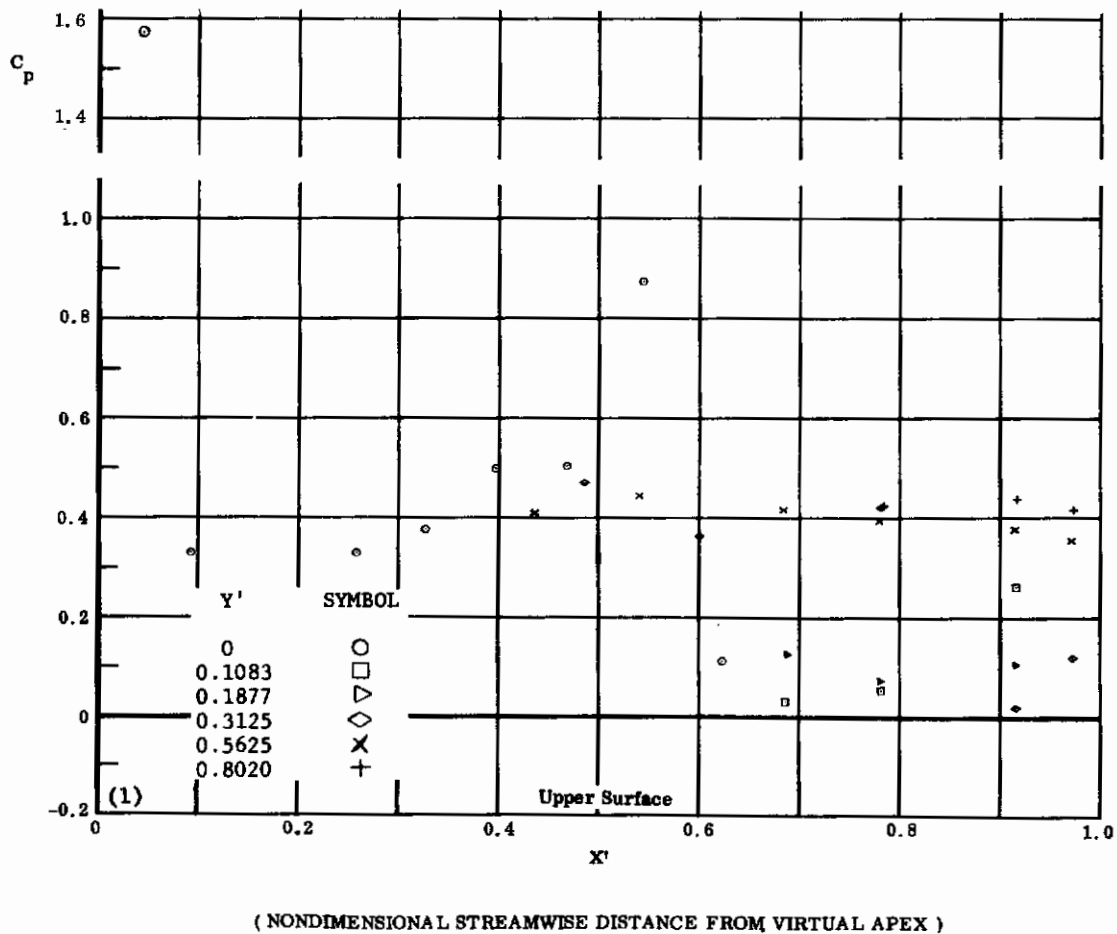
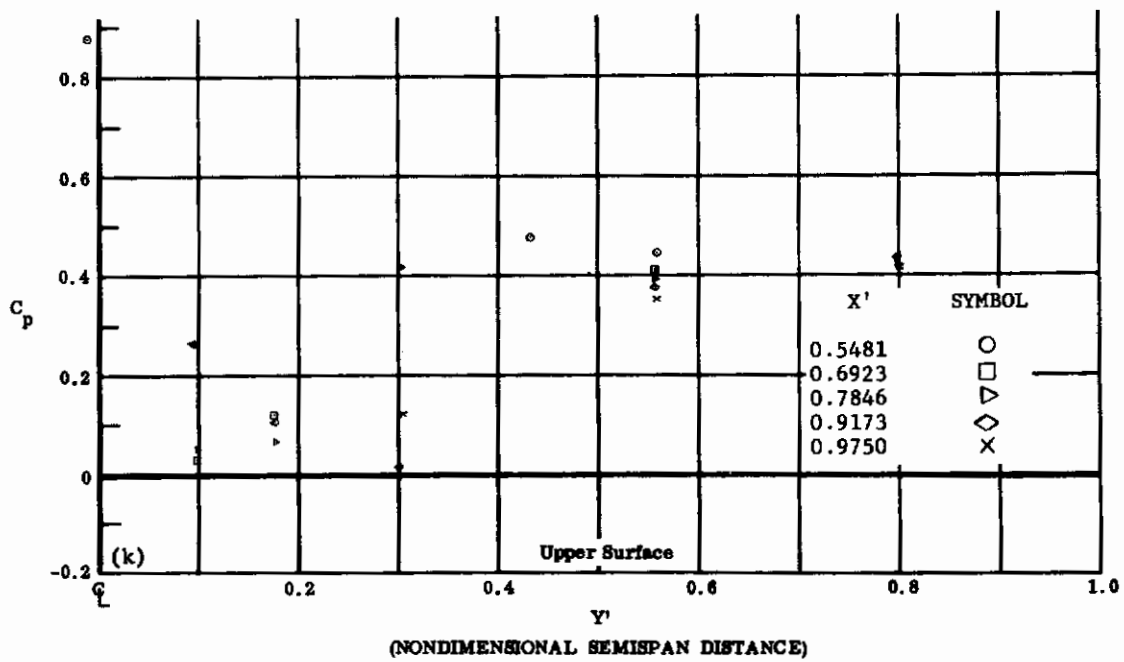

Fig. 50 Configuration VII, Spoiler On

k) C_p vs. Y' , $\alpha = -20$, $Re_\infty / ft \times 10^{-6} = 3.3$, upper surface

l) C_p vs. X' , $\alpha = -20$, $Re_\infty / ft \times 10^{-6} = 3.3$, upper surface

Contrails

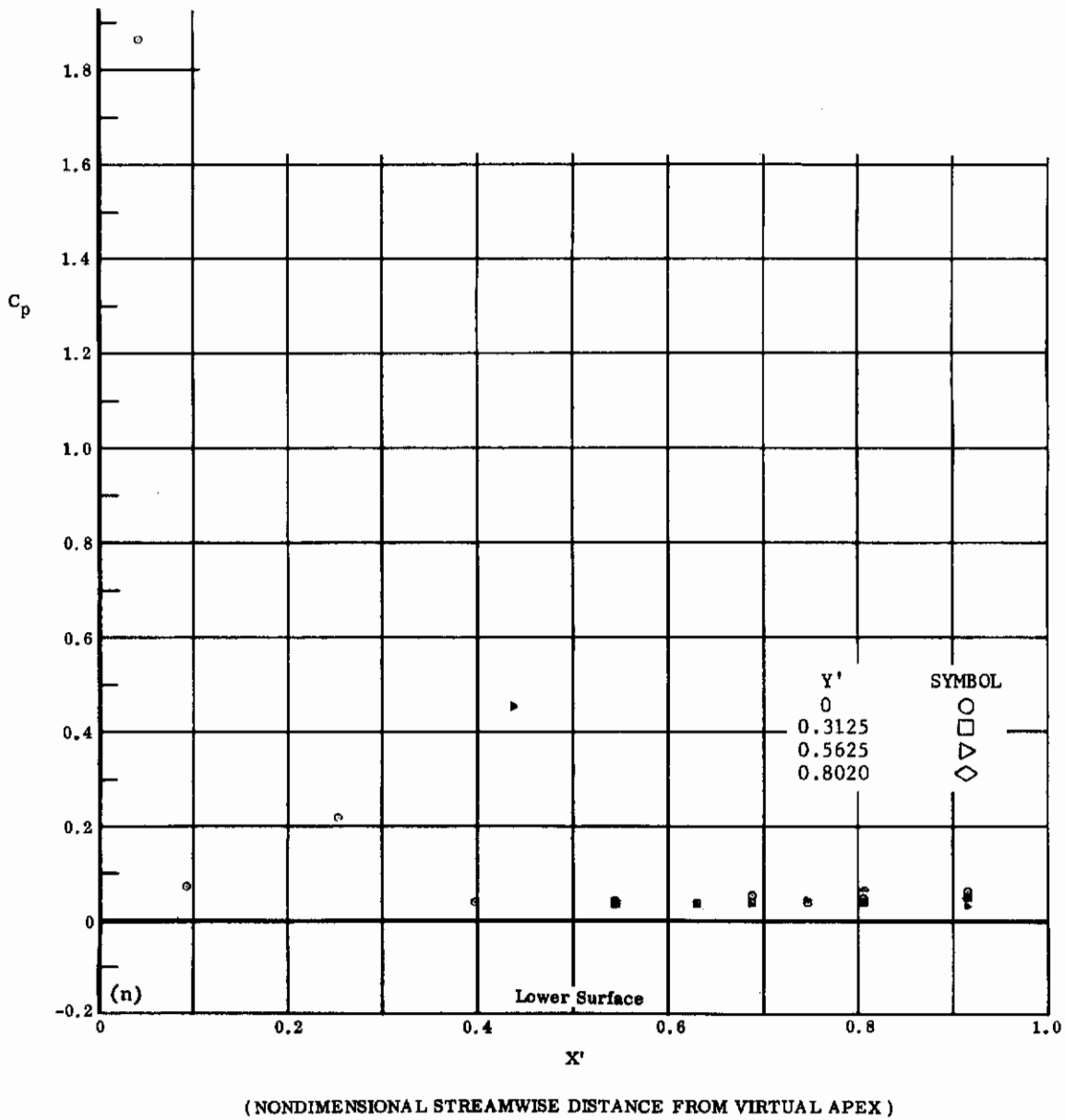
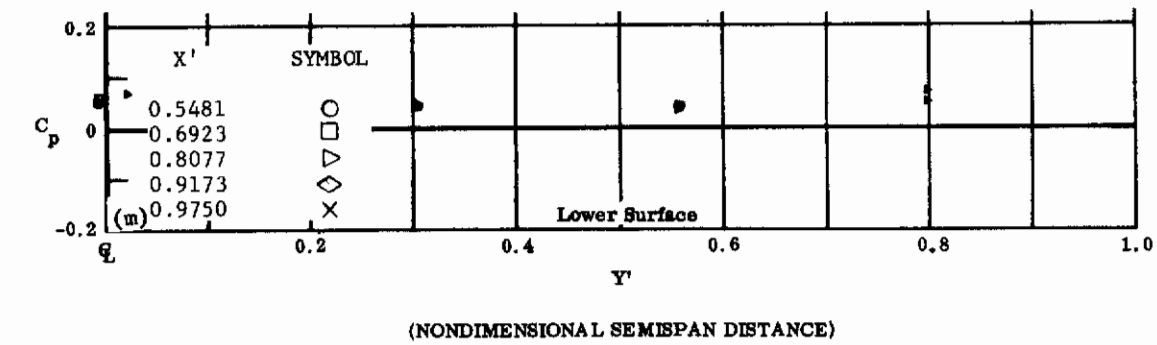
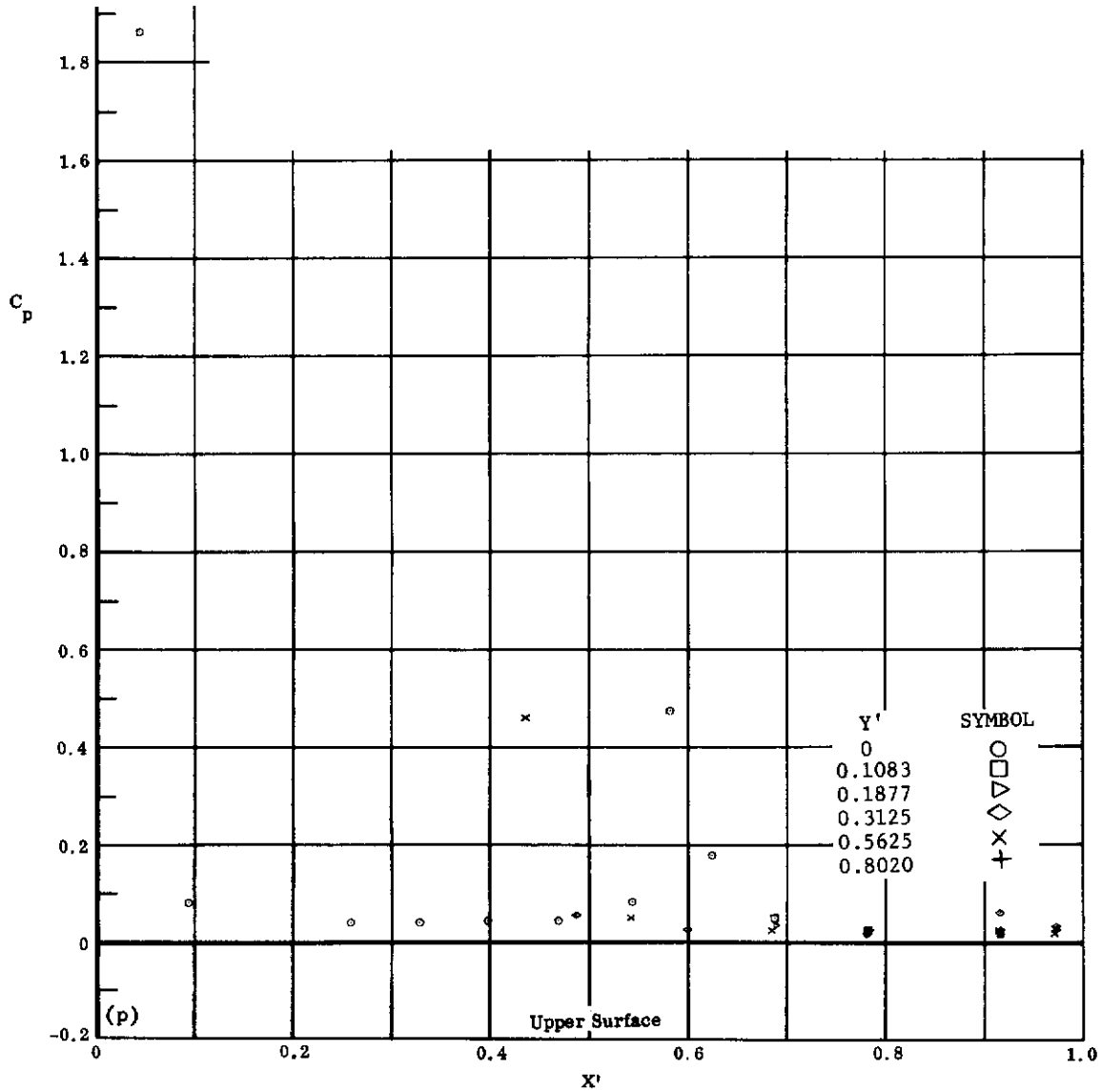
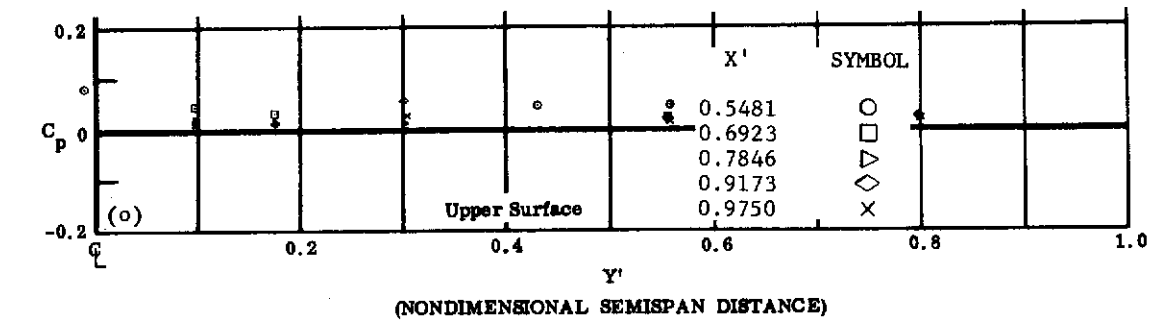

Fig. 50 Configuration VII, Spoiler On

m) C_p vs. Y' , $\alpha = 0$, $Re_{\infty}/ft \times 10^{-6} = 1.1$, lower surface

n) C_p vs. X' , $\alpha = 0$, $Re_{\infty}/ft \times 10^{-6} = 1.1$, lower surface

Contrails



(NONDIMENSIONAL STREAMWISE DISTANCE FROM VIRTUAL APEX)

Fig. 50 Configuration VII, Spoiler On

o) C_p vs. Y' , $\alpha = 0$, $Re_\infty / ft \times 10^{-6} = 1.1$, upper surface

p) C_p vs. X' , $\alpha = 0$, $Re_\infty / ft \times 10^{-6} = 1.1$, upper surface

Contrails

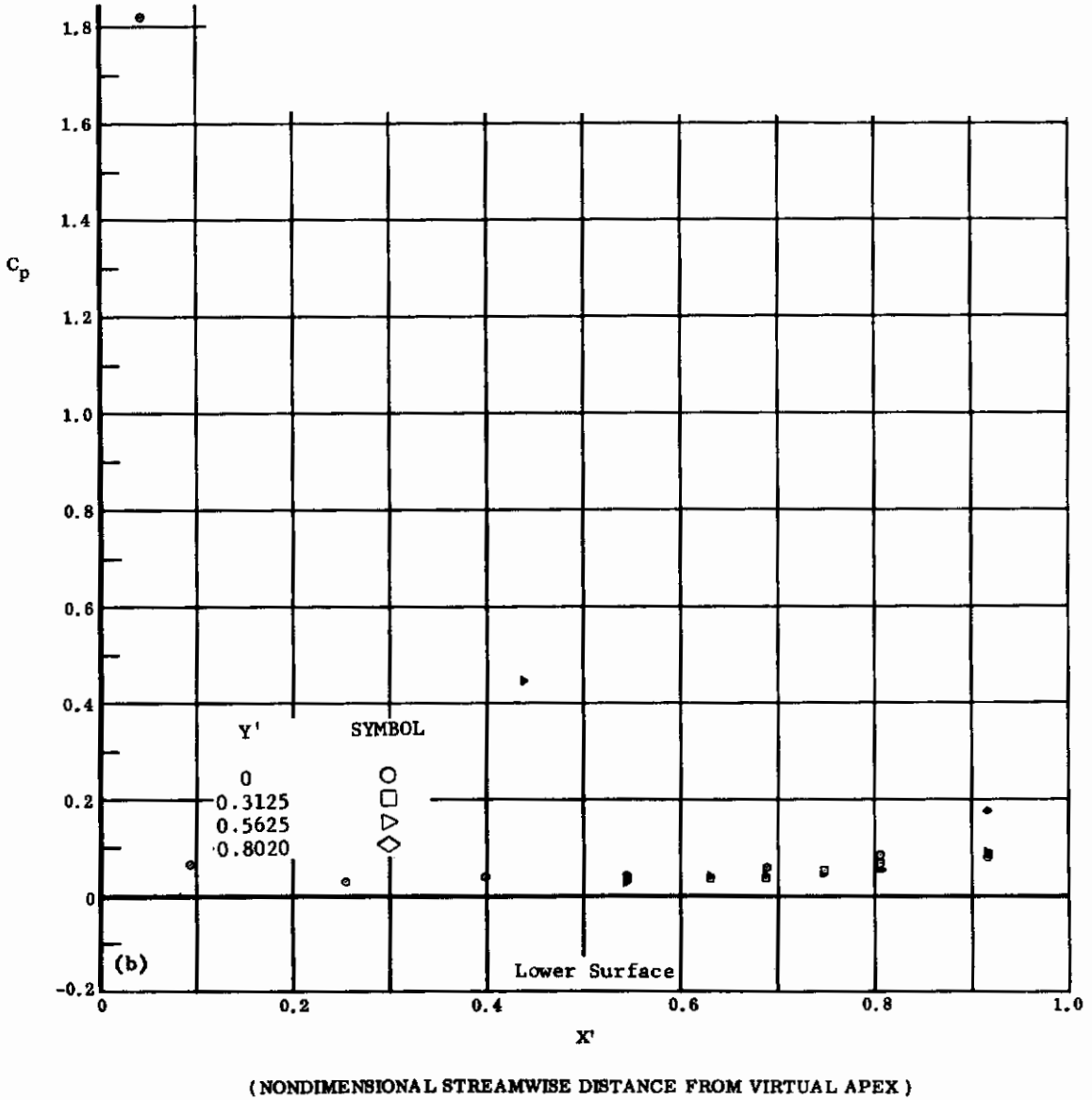
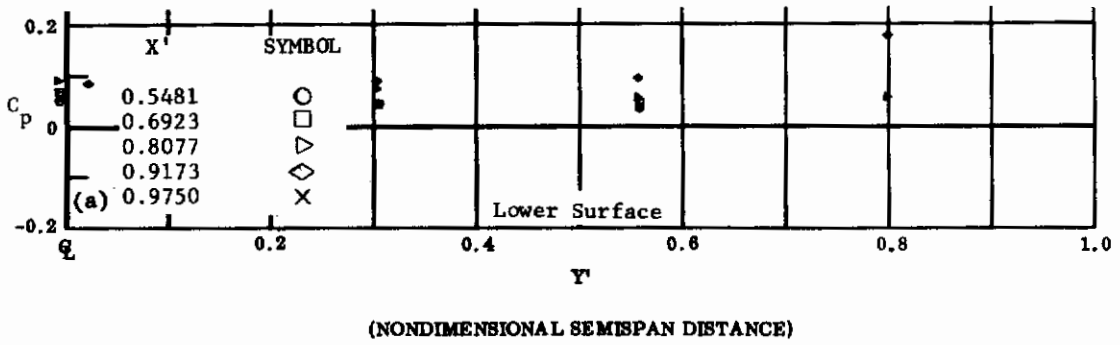

Fig. 51 Configuration VIII, Spoiler on, $Re_{\infty}/ft \times 10^{-6} = 3.3$

a) C_p vs. Y' , $\alpha = 0$, lower surface

b) C_p vs. X' , $\alpha = 0$, lower surface

Contrails

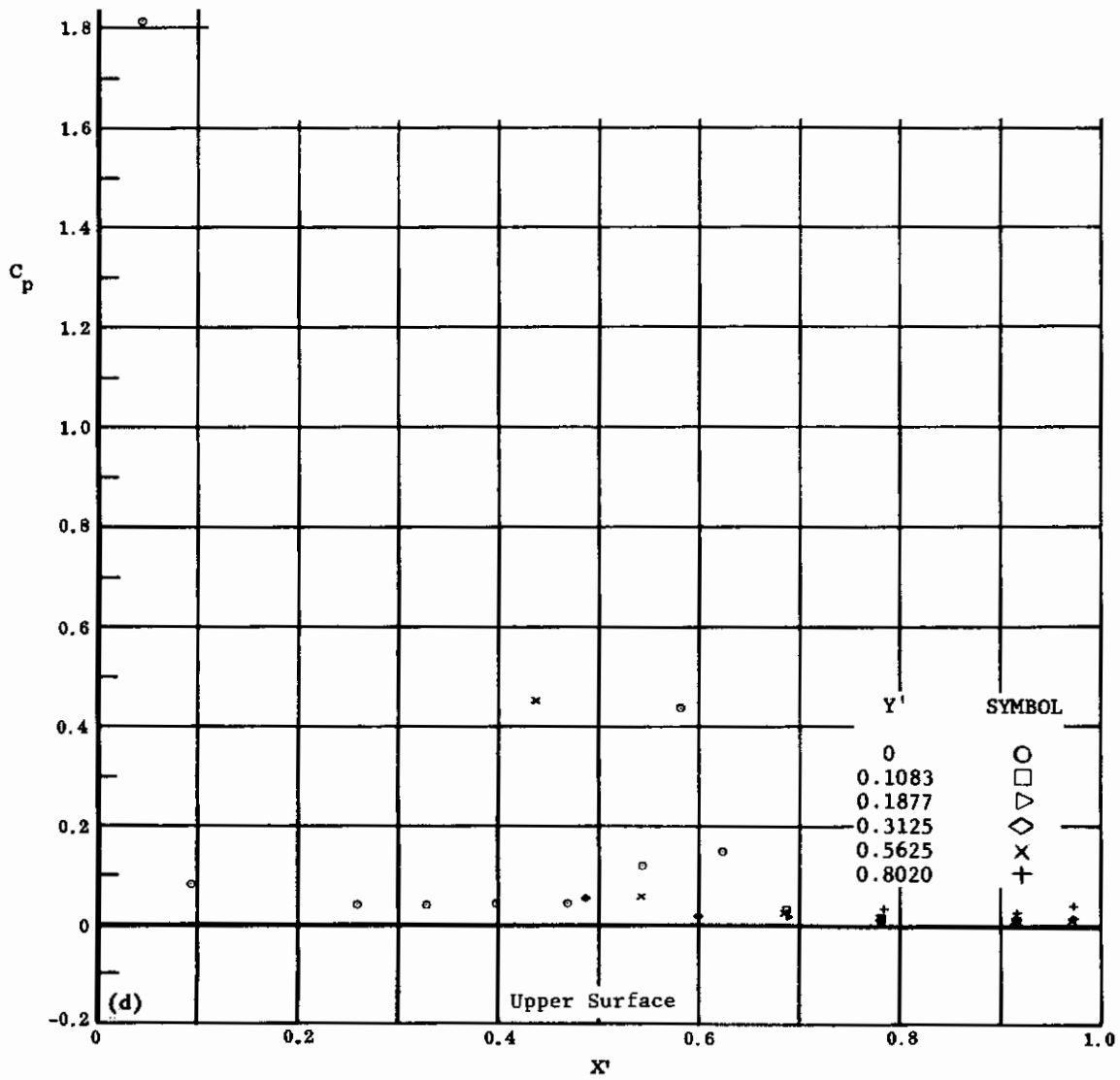
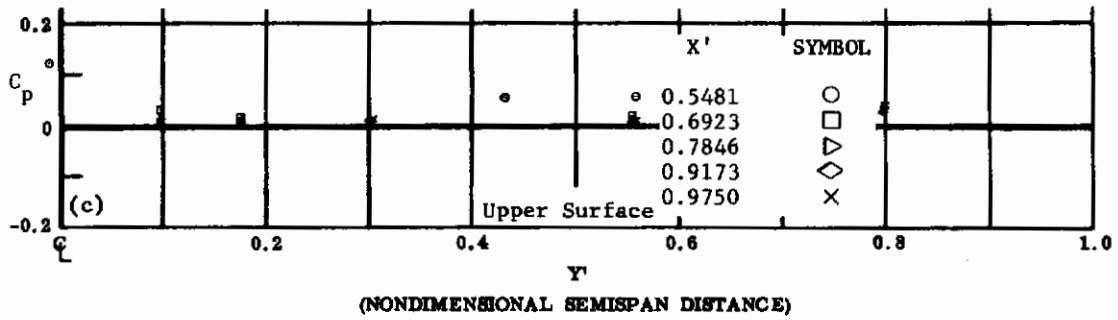
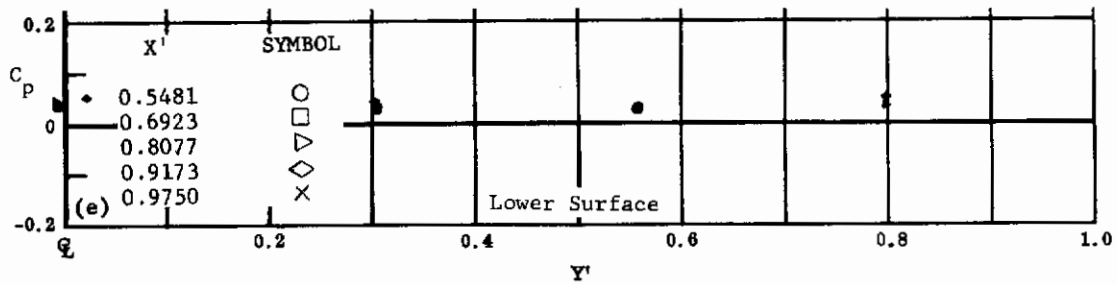

Fig. 51 Configuration VIII, Spoiler on, $Re_{\infty}/ft \times 10^{-6} = 3.3$

c) C_p vs. Y' , $\alpha = 0$, upper surface

d) C_p vs. X' , $\alpha = 0$, upper surface

Contrails



(NONDIMENSIONAL SEMISPAN DISTANCE)

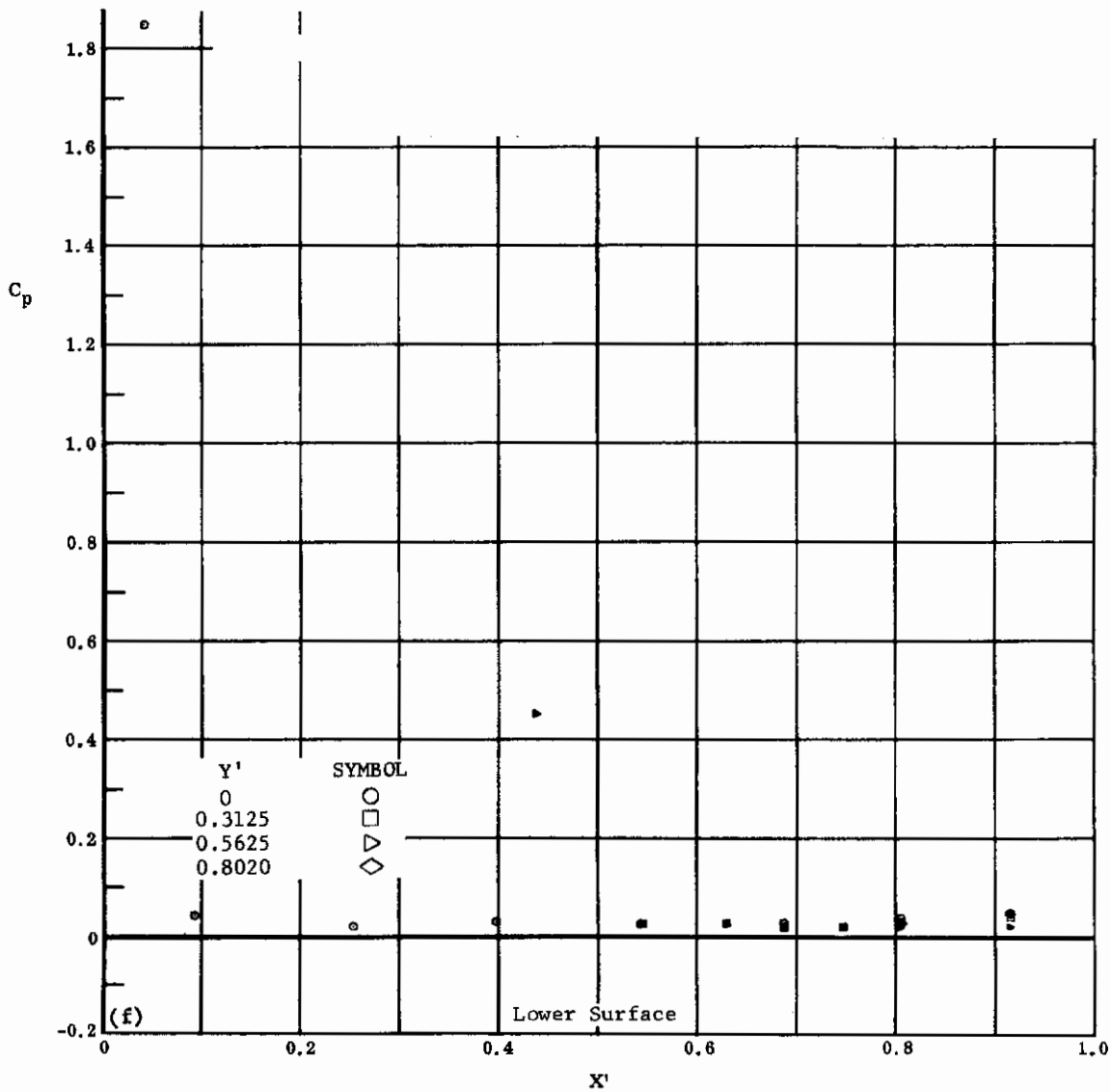

(NONDIMENSIONAL STREAMWISE DISTANCE FROM VIRTUAL APEX)

Fig. 51 Configuration VIII, Spoiler on, $Re_{\infty}/ft \times 10^{-6} = 3.3$

e) C_p vs. Y' , $\alpha = -5$, lower surface

f) C_p vs. X' , $\alpha = -5$, lower surface

Contrails

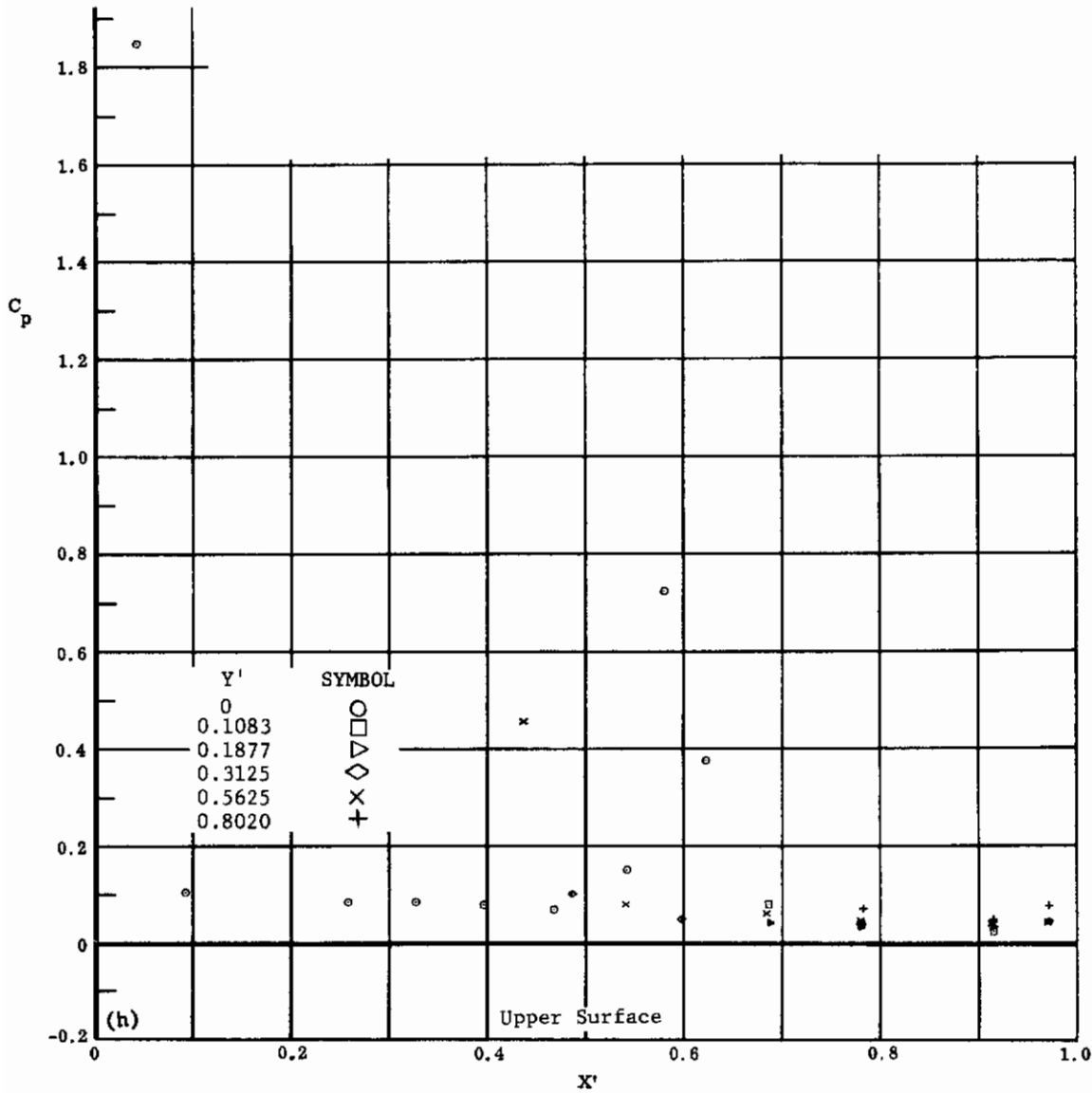
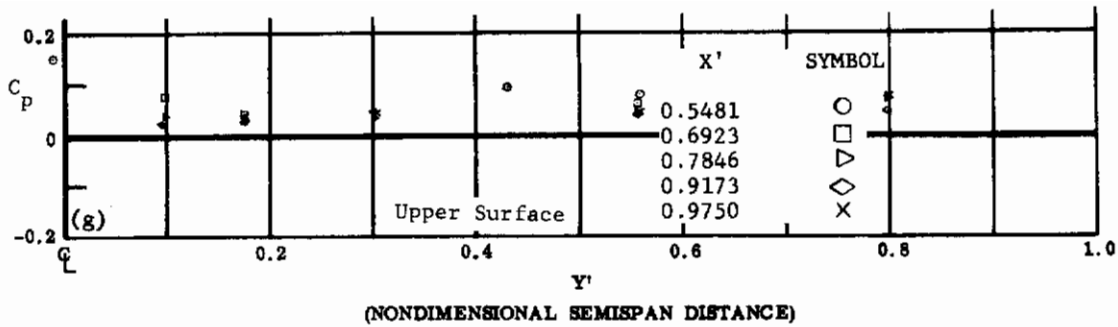
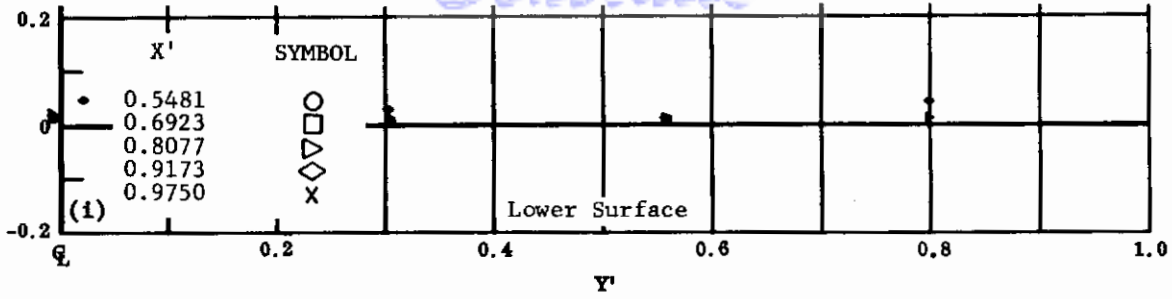

Fig. 51 Configuration VIII, Spoiler on, $Re_{\infty}/ftx10^{-6} = 3.3$

g) C_p vs. Y' , $\alpha = -5$, upper surface

h) C_p vs. X' , $\alpha = -5$, upper surface



(NONDIMENSIONAL SEMISPAN DISTANCE)

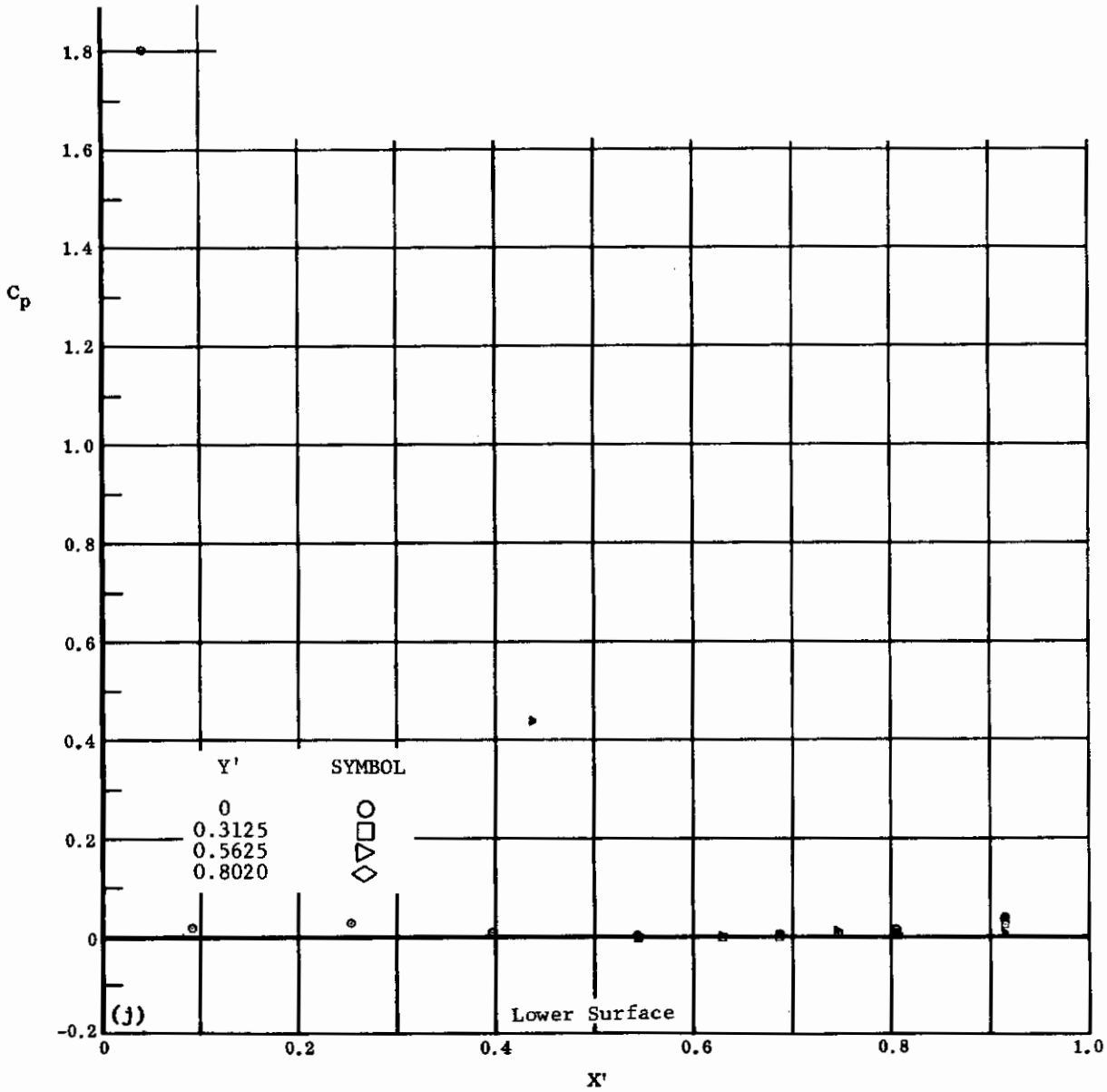

(NONDIMENSIONAL STREAMWISE DISTANCE FROM VIRTUAL APEX)

Fig. 51 Configuration VIII, Spoiler on, $Re_{\infty}/ft \times 10^{-6} = 3.3$

i) C_p vs. Y' , $\alpha = -10$, lower surface

j) C_p vs. X' , $\alpha = -10$, lower surface

Contrails

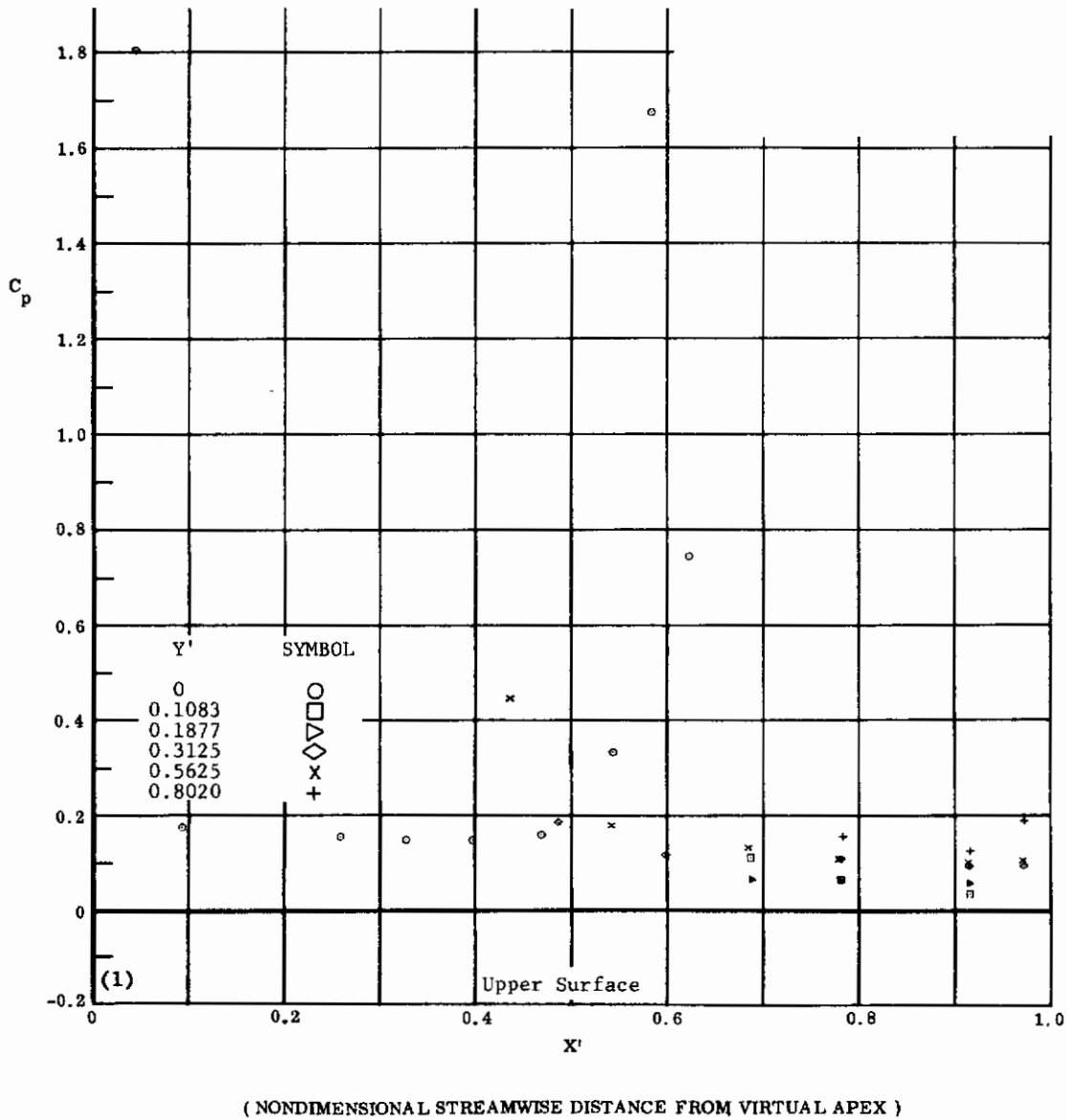
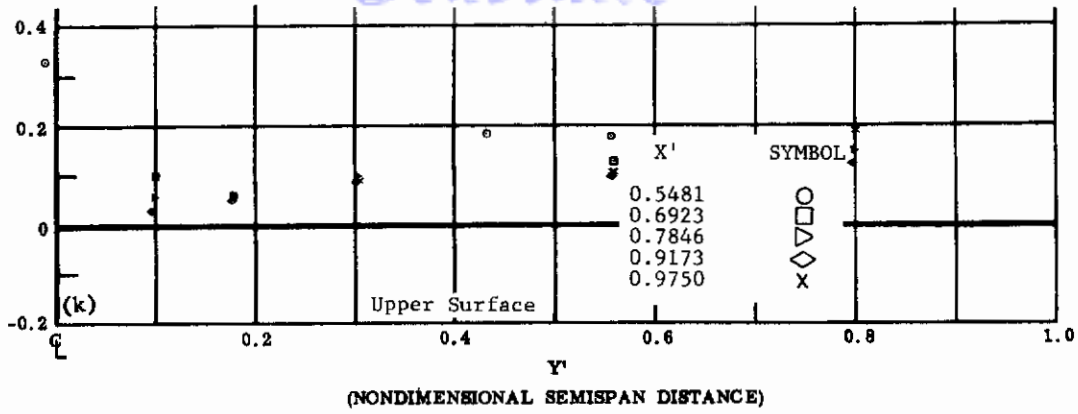
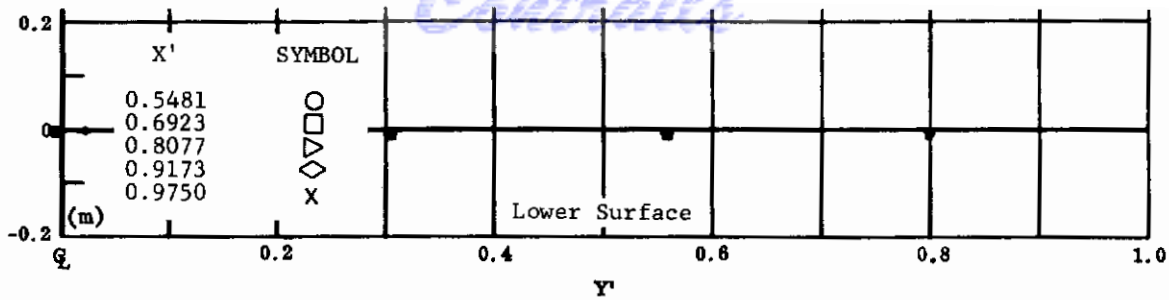

Fig. 51 Configuration VIII, Spoiler on, $Re_{\infty}/ft \times 10^{-6} = 3.3$

k) C_p vs. Y' , $\alpha = -10$, upper surface

1) C_p vs. X' , $\alpha = -10$, upper surface



(NONDIMENSIONAL SEMISPAN DISTANCE)

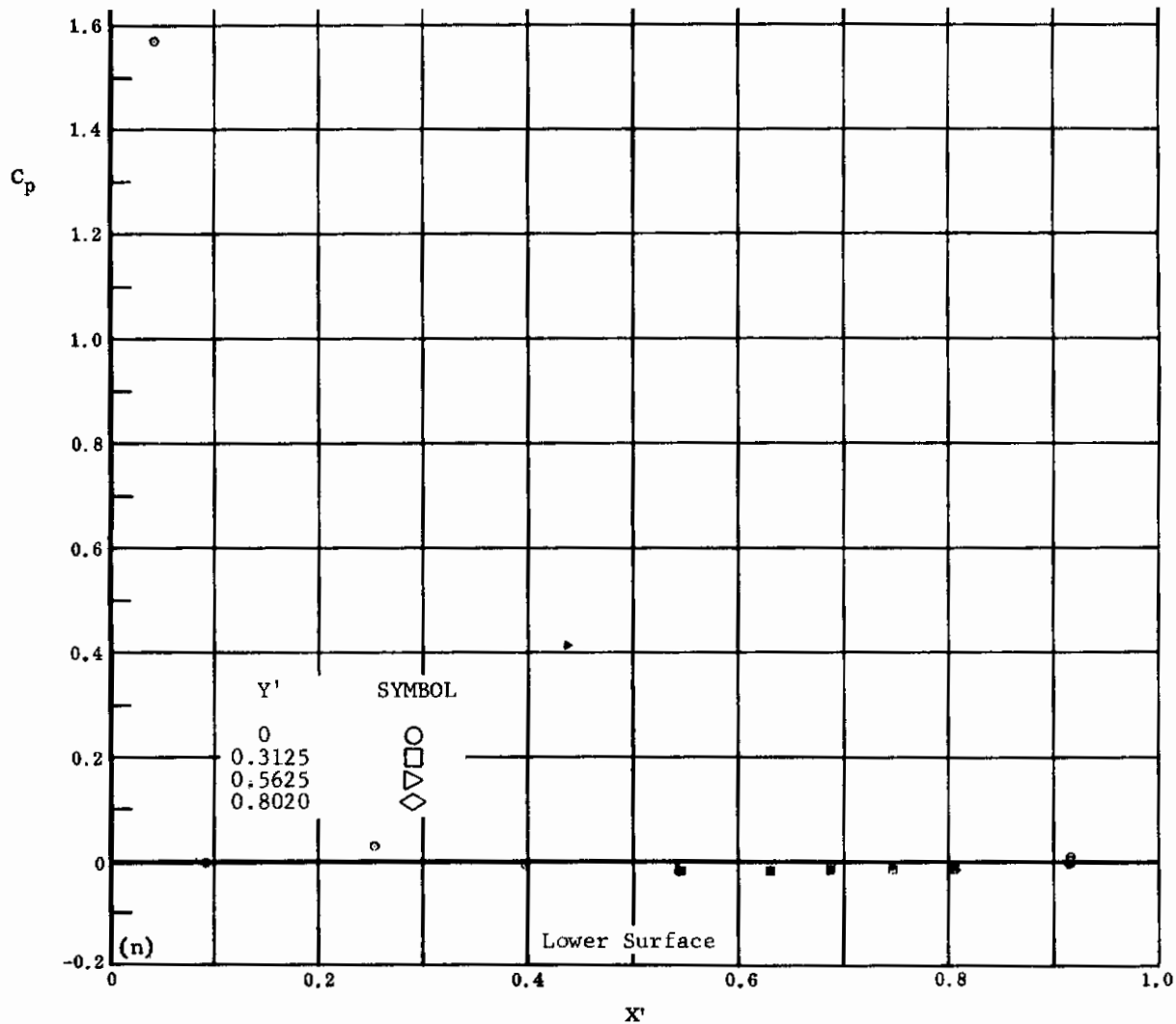

(NONDIMENSIONAL STREAMWISE DISTANCE FROM VIRTUAL APEX)

Fig. 51 Configuration VIII, Spoiler on, $Re_{\infty}/ft \times 10^{-6} = 3.3$

m) C_p vs. Y' , $\alpha = -20$, lower surface

n) C_p vs. X' , $\alpha = -20$, lower surface

Contrails

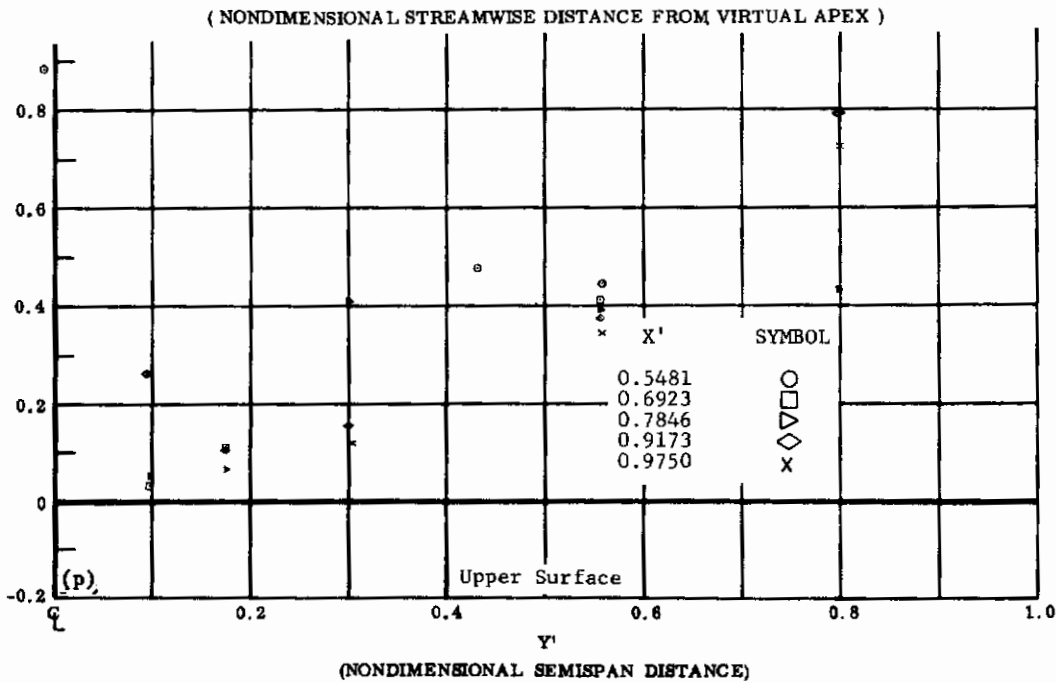
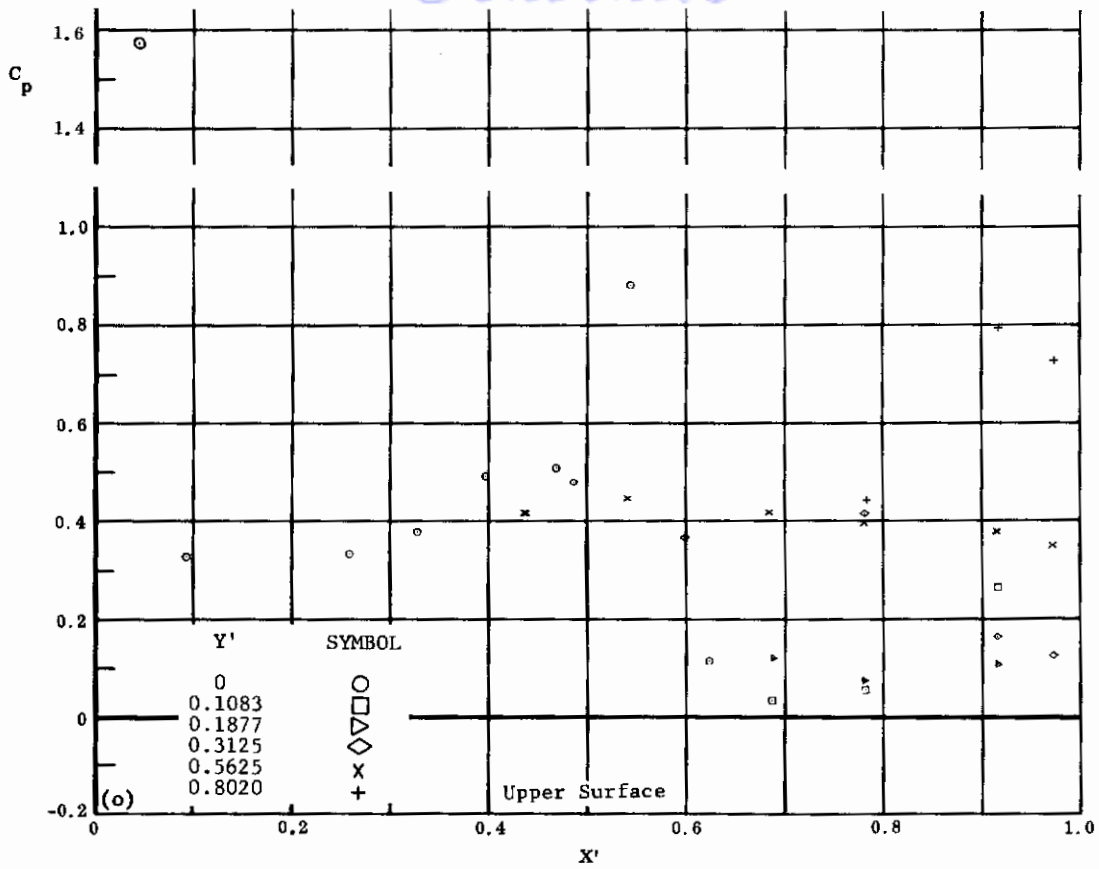

Fig. 51 Configuration VIII, Spoiler on, $Re_{\infty}/ft \times 10^{-6} = 3.3$

o) C_p vs. X' , $\alpha = -20$, upper surface

p) C_p vs. Y' , $\alpha = -20$, upper surface

Contrails

UNCLASSIFIED

Security Classification

DOCUMENT CONTROL DATA - R&D		
<i>(Security classification of title, body of abstract and indexing annotation must be entered when the overall report is classified)</i>		
1. ORIGINATING ACTIVITY (Corporate author) Grumman Aircraft Engineering Corporation Bethpage, L.I., New York		2a. REPORT SECURITY CLASSIFICATION UNCLASSIFIED
		2b. GROUP N/A
3. REPORT TITLE Pressure Measurements at Mach 8 On An Aerodynamically Controllable Winged Re-entry Configuration		
4. DESCRIPTIVE NOTES (Type of report and inclusive dates) N/A		
5. AUTHOR(S) (Last name, first name, initial) Meckler, Lawrence		
6. REPORT DATE June 1965	7a. TOTAL NO. OF PAGES 453	7b. NO. OF REFS 5
8a. CONTRACT OR GRANT NO. AF33(616)-8130	9a. ORIGINATOR'S REPORT NUMBER(S) FDL TDR 64-124	
b. PROJECT NO. 8219-821902	9b. OTHER REPORT NO(S) (Any other numbers that may be assigned this report) N/A	
c.		
d.		
10. AVAILABILITY/LIMITATION NOTICES N/A		
11. SUPPLEMENTARY NOTES N/A	12. SPONSORING MILITARY ACTIVITY AFFDL (FDCC) Wright-Patterson AFB, Ohio 45433	
13. ABSTRACT <p>Pressure data were obtained at Mach 8 for a winged re-entry configuration having aerodynamic controls. The basic model consisted of a clipped delta wing with an overslung cone-cylinder body. The main controls tested were partial span trailing edge flaps. Data were also obtained on the effect of tip fins, hemisphere-cylinder body and a trailing edge spoiler. The data were obtained over an angle of attack range of -50° to +50°. Due to load limitations on the controls the unit test section Reynolds number varied from 3.3 x 10⁶ at low angle of attack to 2.5 x 10⁶ at high angle of attack.</p>		

DD FORM 1473
1 JAN 64

UNCLASSIFIED

Security Classification

14.	KEY WORDS	LINK A		LINK B		LINK C	
		ROLE	WT	ROLE	WT	ROLE	WT
	<p>hypersonic control pressure measurements winged re-entry flow separation control characteristics</p>						

INSTRUCTIONS

1. **ORIGINATING ACTIVITY:** Enter the name and address of the contractor, subcontractor, grantee, Department of Defense activity or other organization (*corporate author*) issuing the report.
- 2a. **REPORT SECURITY CLASSIFICATION:** Enter the overall security classification of the report. Indicate whether "Restricted Data" is included. Marking is to be in accordance with appropriate security regulations.
- 2b. **GROUP:** Automatic downgrading is specified in DoD Directive 5200.10 and Armed Forces Industrial Manual. Enter the group number. Also, when applicable, show that optional markings have been used for Group 3 and Group 4 as authorized.
3. **REPORT TITLE:** Enter the complete report title in all capital letters. Titles in all cases should be unclassified. If a meaningful title cannot be selected without classification, show title classification in all capitals in parenthesis immediately following the title.
4. **DESCRIPTIVE NOTES:** If appropriate, enter the type of report, e.g., interim, progress, summary, annual, or final. Give the inclusive dates when a specific reporting period is covered.
5. **AUTHOR(S):** Enter the name(s) of author(s) as shown on or in the report. Enter last name, first name, middle initial. If military, show rank and branch of service. The name of the principal author is an absolute minimum requirement.
6. **REPORT DATE:** Enter the date of the report as day, month, year, or month, year. If more than one date appears on the report, use date of publication.
- 7a. **TOTAL NUMBER OF PAGES:** The total page count should follow normal pagination procedures, i.e., enter the number of pages containing information.
- 7b. **NUMBER OF REFERENCES:** Enter the total number of references cited in the report.
- 8a. **CONTRACT OR GRANT NUMBER:** If appropriate, enter the applicable number of the contract or grant under which the report was written.
- 8b, 8c, & 8d. **PROJECT NUMBER:** Enter the appropriate military department identification, such as project number, subproject number, system numbers, task number, etc.
- 9a. **ORIGINATOR'S REPORT NUMBER(S):** Enter the official report number by which the document will be identified and controlled by the originating activity. This number must be unique to this report.
- 9b. **OTHER REPORT NUMBER(S):** If the report has been assigned any other report numbers (*either by the originator or by the sponsor*), also enter this number(s).
10. **AVAILABILITY/LIMITATION NOTICES:** Enter any limitations on further dissemination of the report, other than those

imposed by security classification, using standard statements such as:

- (1) "Qualified requesters may obtain copies of this report from DDC."
- (2) "Foreign announcement and dissemination of this report by DDC is not authorized."
- (3) "U. S. Government agencies may obtain copies of this report directly from DDC. Other qualified DDC users shall request through _____."
- (4) "U. S. military agencies may obtain copies of this report directly from DDC. Other qualified users shall request through _____."
- (5) "All distribution of this report is controlled. Qualified DDC users shall request through _____."

If the report has been furnished to the Office of Technical Services, Department of Commerce, for sale to the public, indicate this fact and enter the price, if known.

11. **SUPPLEMENTARY NOTES:** Use for additional explanatory notes.
12. **SPONSORING MILITARY ACTIVITY:** Enter the name of the departmental project office or laboratory sponsoring (*paying for*) the research and development. Include address.
13. **ABSTRACT:** Enter an abstract giving a brief and factual summary of the document indicative of the report, even though it may also appear elsewhere in the body of the technical report. If additional space is required, a continuation sheet shall be attached.

It is highly desirable that the abstract of classified reports be unclassified. Each paragraph of the abstract shall end with an indication of the military security classification of the information in the paragraph, represented as (TS), (S), (C), or (U).

There is no limitation on the length of the abstract. However, the suggested length is from 150 to 225 words.

14. **KEY WORDS:** Key words are technically meaningful terms or short phrases that characterize a report and may be used as index entries for cataloging the report. Key words must be selected so that no security classification is required. Identifiers, such as equipment model designation, trade name, military project code name, geographic location, may be used as key words but will be followed by an indication of technical context. The assignment of links, rules, and weights is optional.