

*Contrails*

WADC TECHNICAL REPORT 54-359

PART 1

**EQUIPMENT COOLING SYSTEMS  
FOR AIRCRAFT**

**Part 1**

**Summary of Cooling System Study**

*I*

R. H. ZIMMERMAN

W. ROBINSON

THE OHIO STATE UNIVERSITY RESEARCH FOUNDATION

SEPTEMBER 1954

JUN 10 1956

~~████████████████████~~  
~~████████████████████~~  
~~████████████████████~~  
~~████████████████████~~

EQUIPMENT LABORATORY

CONTRACT No. AF 33(616)-147

TASK No. 61181

WRIGHT AIR DEVELOPMENT CENTER  
AIR RESEARCH AND DEVELOPMENT COMMAND  
UNITED STATES AIR FORCE  
WRIGHT-PATTERSON AIR FORCE BASE, OHIO

Carpenter Litho & Prtg. Co., Springfield, O.  
400 - May 1956

# Contrails

## FOREWORD

This report was prepared in the Mechanical Engineering Department of the Ohio State University. The work was performed between June 1952 and August 1954 under Contract No. AF33(616)-147 with the Ohio State University Research Foundation. It was administered under the direction of the Mechanical Branch, Equipment Laboratory, Directorate of Laboratories, Wright Air Development Center, Wright-Patterson Air Force Base, Ohio. Mr. F. R. Ebersbach was the Equipment Laboratory project engineer in charge of the work which was accomplished under Task No. 61181, "Centralized versus Individualized Cooling of Aircraft Equipment". (Formerly RDO No. 664-803F-9)

The report is presented in three parts. Part 1 is concerned with an introduction to the scope of the study, the functional classification of cooling system components and types, and a summary and comparison of the characteristics of seven types of cooling systems. Part 2 contains methods of aircraft penalty evaluation, and the performance and physical characteristics of components used in the evaluation of cooling systems. Part 3 presents details of analysis and evaluation of seven types of cooling systems for design conditions up to 65,000 feet altitude and flight speeds up to Mach 1.8.

The authors acknowledge with thanks the contributions of the following research associates to the development of subject matter and the preparation of the three parts of this report. Part 1: K. G. Hornung. Part 2: S. E. Arnett, T. C. Taylor, W. Robinson, G. D. Hudelson and D. J. Masson. Part 3: C. F. Borteck and G. D. Hudelson.

WADC TR 54-359  
PART 1

Part 1 of the report presents an introduction to the scope of the study, concerned with the analytical evaluation of equipment cooling systems for steady-state conditions of aircraft and equipment operation over ranges of altitudes from sea level to 65,000 feet, flight Mach numbers up to 1.8, equipment temperatures from 130° to 250°F, equipment dispersion up to 150 feet and system cooling capacities up to 75 kilowatts. Terminology peculiar to the study is defined. Cooling system components are classified as equipment, distribution, intermediate and ultimate. Systems are classified as direct and indirect, referring to the supply of the ultimate coolant to equipment items directly, or to an intermediate heat exchanger system, respectively. Seven types of cooling systems are defined as ram air, expanded ram-air, bleed air, blower, fuel, expendable and vapor cycle refrigeration systems. The results obtained in the evaluation of these systems of direct and indirect type are summarized with reference to physical characteristics, aircraft gross weight, penalty and other merit considerations. The penalties of the various systems are compared and the ranges of flight and design conditions in which each system appears to be superior are determined. Conclusions in reference to the applicability and suggestions for the areas of needed additional investigation are presented for several of the systems studied.

### PUBLICATION REVIEW

The publication of this report does not constitute approval by the Air Force of the findings or conclusions contained therein. It is published for the exchange and stimulation of ideas.

FOR THE COMMANDER:

  
S. T. SMITH  
for Colonel, USAF  
Chief, Equipment Laboratory

WADC TR 54-359  
PART 1

iii

*Contrails*  
TABLE OF CONTENTS

PART 1

	Page
I INTRODUCTION . . . . .	1
Scope of Study . . . . .	2
Classification of Cooling System Components and Types . . . . .	6
Availability of Air as the Ultimate Fluid . . . . .	9
Description of Cooling Systems . . . . .	10
Ram Air Cooling System . . . . .	10
Expanded Ram-Air Cooling System . . . . .	12
Bleed Air Cooling System . . . . .	16
Blower Cooling System . . . . .	18
Fuel Cooling Systems . . . . .	19
Expendable Cooling Systems . . . . .	21
Vapor Cycle Cooling Systems . . . . .	22
II SUMMARY OF COOLING SYSTEM STUDY . . . . .	24
Nomenclature . . . . .	24
Ram Air Cooling Systems . . . . .	25
Expanded Ram-Air Cooling Systems . . . . .	27
Bleed Air Cooling Systems . . . . .	28
Blower Cooling Systems . . . . .	29
Fuel Cooling Systems . . . . .	29
Expendable Cooling Systems . . . . .	31
Vapor Cycle Refrigeration Systems . . . . .	33
Comparison of Aircraft Penalty of Cooling Systems . . . . .	36
Direct Cooling Systems . . . . .	36
Indirect Cooling Systems . . . . .	51
Conclusions . . . . .	76

# Contrails

## CONTENTS OF PARTS 1, 2, AND 3 of REPORT

### PART 1

- I INTRODUCTION AND CLASSIFICATION OF COOLING SYSTEM COMPONENTS AND TYPES
- II SUMMARY OF COOLING SYSTEM STUDY

### PART 2

- III AIRCRAFT PENALTY OF COOLING SYSTEMS
- IV THE EQUIPMENT COMPONENT
- V THE DISTRIBUTION COMPONENT
- VI THE INTERMEDIATE COMPONENT
- VII THE ULTIMATE COMPONENT

### PART 3

- VIII RAM AIR COOLING SYSTEMS
- IX EXPANDED RAM-AIR COOLING SYSTEMS
- X BLEED AIR COOLING SYSTEMS
- XI BLOWER COOLING SYSTEMS
- XII FUEL COOLING SYSTEMS
- XIII EXPENDABLE COOLING SYSTEMS
- XIV VAPOR CYCLE REFRIGERATION SYSTEMS

# Contrails

## LIST OF ILLUSTRATIONS

Figure		Page
I-1	Flight altitude-Mach number range considered in the cooling system study . . . . .	3
I-2	Ambient temperature-altitude range specified for the cooling system study . . . . .	3
I-3	Variation of total temperature of air within the flight altitude-Mach number range specified for the cooling system study. Ambient temperature-altitude schedule corresponds to the basic schedule as indicated in Figure I-2 . . . . .	4
I-4	Variation of total pressure of atmospheric air within the flight altitude-Mach range specified for the cooling system study . . . . .	5
I-5	Schematic arrangement of ram air cooling system . . . . .	10
I-6	Ultimate component processes in a ram air cooling system represented in the pressure-temperature coordinate plane . . . . .	11
I-7	Schematic arrangement of an expanded ram-air cooling system . . . . .	13
I-8	Ultimate component processes of an expanded ram-air system represented on the temperature-pressure coordinate plane . . . . .	14
I-9	Schematic arrangement of bleed air cooling system for direct or indirect equipment cooling . . . . .	17
I-10	Ultimate component processes in bleed air cooling systems represented on the pressure-temperature plane . . . . .	18
I-11	Schematic arrangement of a fuel cooling system . . . . .	20
I-12	Schematic arrangement of an indirect expendable cooling system . . . . .	22
I-13	Schematic arrangement of a vapor cycle cooling system . . . . .	23
II-1	Break-even gross weight penalties and flight conditions for direct ram air (R), expanded ram-air (E) and bleed air (B) systems. $\alpha = 2$ . . . . .	37
II-2	Break-even gross weight penalties and flight conditions for direct ram air (R), expanded ram-air (E) and bleed air (B) systems. $T_{Es} = 650^{\circ}R$ . . . . .	37

# Contrails

Figure		Page
II-3	Break-even gross weight penalties and flight conditions for direct expanded ram-air versus direct bleed air systems. $\alpha = 2$ . . . . .	39
II-4	Gross weight penalty of direct ram air versus direct expanded ram-air systems. $T_{Es} = 710^{\circ}R$ . $\alpha = 4$ . . . . .	40
II-5	Gross weight penalty of direct ram air versus direct expanded ram-air systems. $T_{Es} = 650^{\circ}R$ . $\alpha = 4$ . . . . .	40
II-6	Gross weight penalty of direct ram air versus direct expanded ram-air systems. $T_{Es} = 590^{\circ}R$ . $\alpha = 4$ . . . . .	41
II-7	Gross weight penalty of direct ram air versus direct expanded ram-air systems. $T_{Es} = 650^{\circ}R$ . $\alpha = 2$ . . . . .	41
II-8	Gross weight penalty of direct ram air versus direct bleed air systems. $T_{Es} = 710^{\circ}R$ . $\alpha = 4$ . . . . .	43
II-9	Gross weight penalty of direct ram air versus direct bleed air systems. $T_{Es} = 650^{\circ}R$ . $\alpha = 4$ . . . . .	43
II-10	Gross weight penalty of direct ram air versus direct bleed air systems. $T_{Es} = 590^{\circ}R$ . $\alpha = 4$ . . . . .	44
II-11	Gross weight penalty of direct ram air versus direct bleed air systems. $T_{Es} = 650^{\circ}R$ . $\alpha = 2$ . . . . .	44
II-12	Gross weight penalty of direct expanded ram-air versus direct bleed air systems. $T_{Es} = 710^{\circ}R$ . $\alpha = 2$ . . . . .	46
II-13	Gross weight penalty of direct expanded ram-air versus direct bleed air systems. $T_{Es} = 650^{\circ}R$ . $\alpha = 2$ . . . . .	46
II-14	Gross weight penalty of direct expanded ram-air versus direct bleed air systems. $T_{Es} = 590^{\circ}R$ . $\alpha = 2$ . . . . .	47
II-15	Gross weight penalty of direct expanded ram-air versus direct bleed air systems. $T_{Es} = 650^{\circ}R$ . $\alpha = 1$ . . . . .	47
II-16	Comparison of gross weight penalty for five types of direct cooling systems. $M_{Co} = 0.9$ . Alt. = 40,000 ft. $\alpha = 4$ .	48
II-17	Comparison of gross weight penalty for five types of direct cooling systems. $M_{Co} = 0.9$ . Alt. = 40,000 ft. $T_{Es} = 650^{\circ}R$	48
II-18	Comparison of gross weight penalty for five types of direct cooling systems. $M_{Co} = 0.9$ . Alt. = 60,000 ft. $\alpha = 4$ .	48

# Contrails

Figure		Page
II-19	Comparison of gross weight penalty for five types of direct cooling systems. $M_{\infty} = 0.9$ . Alt. = 60,000 ft. $T_{ES} = 650^{\circ}R$	49
II-20	Comparison of gross weight penalty for five types of direct cooling systems. $M_{\infty} = 1.8$ . Alt. = 40,000 ft. $\alpha = 2$ .	49
II-21	Comparison of gross weight penalty for five types of direct cooling systems. $M_{\infty} = 1.5$ . Alt. = 20,000 ft. $\alpha = 2$ .	49
II-22	Variation of gross weight penalty with system temperature potential for direct ram air systems . . . . .	52
II-23	Variation of gross weight penalty with system temperature potential for direct expanded ram-air systems. $\alpha = 2$	52
II-24	Variation of gross weight penalty with system temperature potential for direct expanded ram-air systems. $\alpha = 4$	52
II-25	Variation of gross weight penalty with system temperature potential for direct bleed air systems. $\alpha = 2$ . .	53
II-26	Variation of gross weight penalty with system temperature potential for direct bleed air systems. $\alpha = 4$ . .	53
II-27	Comparison of volume of direct ram air, expanded ram-air and bleed air systems . . . . .	54
II-28	Break-even gross weight penalties and flight conditions for indirect ram air and indirect expanded ram-air cooling systems. $L_D = 200$ feet . . . . .	55
II-29	Break-even gross weight penalties and flight conditions for indirect expanded ram-air and indirect bleed air cooling systems. $L_D = 200$ feet . . . . .	55
II-30	Gross weight penalty of indirect ram air versus indirect expanded ram-air systems. $T_{ES} = 710^{\circ}R$ . $\alpha = 4$ . $L_D = 200$ ft	56
II-31	Gross weight penalty of indirect ram air versus indirect expanded ram-air systems. $T_{ES} = 650^{\circ}R$ . $\alpha = 4$ . $L_D = 200$ ft .	56
II-32	Gross weight penalty of indirect ram air versus indirect expanded ram-air systems. $T_{ES} = 590^{\circ}R$ . $\alpha = 4$ . $L_D = 200$ ft .	57
II-33	Comparison of the gross weight penalty of indirect ram air and indirect expanded ram-air systems. $L_D = 200$ ft . $\alpha = 4$ . . . . .	58



# Contrails

Figure		Page
II-34	Gross weight penalty of indirect ram air versus indirect bleed air systems. $T_{Es} = 650^{\circ}R$ . $\alpha = 2$ . $L_D = 200$ ft .	59
II-35	Gross weight penalty of indirect ram air versus indirect bleed air systems. $T_{Es} = 650^{\circ}R$ . $\alpha = 4$ . $L_D = 200$ ft .	59
II-36	Gross weight penalty of indirect ram air versus indirect bleed air systems. $T_{Es} = 590^{\circ}R$ . $\alpha = 4$ . $L_D = 200$ ft .	60
II-37	Gross weight penalty of indirect expanded ram-air versus indirect bleed air systems. $T_{Es} = 710^{\circ}R$ . $\alpha = 2$ . $L_D = 200$ ft .	60
II-38	Gross weight penalty of indirect expanded ram-air versus indirect bleed air systems. $T_{Es} = 650^{\circ}R$ . $\alpha = 2$ . $L_D = 200$ ft .	61
II-39	Gross weight penalty of indirect expanded ram-air versus indirect bleed air systems. $T_{Es} = 590^{\circ}R$ . $\alpha = 2$ . $L_D = 200$ ft .	61
II-40	Gross weight penalty of indirect expanded ram-air versus indirect bleed air systems. $T_{Es} = 650^{\circ}R$ . $\alpha = 1$ . $L_D = 200$ ft .	62
II-41	Gross weight penalty of indirect expanded ram-air versus indirect bleed air systems. $T_{Es} = 650^{\circ}R$ . $\alpha = 3$ . $L_D = 200$ ft .	62
II-42	Comparison of the gross weight penalty of indirect expanded ram-air and indirect bleed air systems. $L_D = 200$ ft	63
II-43	Comparison of the gross weight penalty of indirect fuel and indirect ram air systems. $e_{I-f1} = 0.8$ . . . . .	64
II-44	Distribution component line diameters for indirect fuel, ram air and expanded ram-air systems. $T_{Es} = 650^{\circ}R$ . $kw = 25$ . $L_D = 200$ feet . . . . .	65
II-45	Transfer fluid flow rates for indirect fuel, ram air and expanded ram-air systems. $T_{Es} = 650^{\circ}R$ . $kw = 25$ . $L_D = 200$ ft	65
II-46	Comparison of gross weight penalty for direct versus indirect systems. Alt. = 40,000 ft. $\alpha = 4$ . $M_{\infty} = 0.9$ . $e_{E-direct} = 0.75$ . $L_D = 200$ feet . . . . .	66
II-47	Gross weight penalty of direct and indirect expanded ram-air and bleed air systems. $M_{\infty} = 1.8$ . Alt. = 40,000 ft. $\alpha = 2$ . $e_{E-direct} = 0.75$ . $L_D = 200$ feet . . . . .	66
II-48	Break-even gross weight penalties and flight conditions for indirect bleed air and indirect vapor cycle cooling systems with electric or pneumatic drive. $\alpha = 2$ . $L_D = 200$ ft	67

# Contrails

Figure		Page
II-49	Gross weight penalty of indirect bleed air versus indirect vapor cycle cooling systems with electric or pneumatic drive. $T_{Es} = 710^{\circ}R$ . $\alpha = 2$ . $L_D = 200$ feet . . .	68
II-50	Gross weight penalty of indirect bleed air versus indirect vapor cycle cooling systems with electric or pneumatic drive. $T_{Es} = 650^{\circ}R$ . $\alpha = 2$ . $L_D = 200$ feet . . .	69
II-51	Gross weight penalty of indirect bleed air versus indirect vapor cycle cooling systems with electric or pneumatic drive. $T_{Es} = 590^{\circ}R$ . $\alpha = 2$ . $L_D = 200$ feet . . .	70
II-52	Comparison of the gross weight penalty of indirect vapor cycle systems with electric or pneumatic drive with indirect ram air, bleed air and expanded ram-air systems. $\alpha = 2$ . $L_D = 200$ feet . . . . .	71
II-53	Chart for determination of operating time of optimum indirect and direct expendable cooling systems with distribution component imposing at specific supersonic flight conditions the same gross weight penalty as indirect bleed air or indirect expanded ram-air systems. $T_{Es} = 710^{\circ}R$ . $\alpha = 2$ . $L_D = 200$ feet . . . . .	73
II-54	Chart for determination of operating time of optimum indirect and direct expendable cooling systems with distribution component imposing at specific supersonic flight conditions the same gross weight penalty as indirect bleed air or indirect expanded ram-air systems. $T_{Es} = 650^{\circ}R$ . $\alpha = 2$ . $L_D = 200$ feet . . . . .	74
II-55	Chart for determination of operating time of optimum indirect and direct expendable cooling systems with distribution component imposing at specific supersonic flight conditions the same gross weight penalty as indirect bleed air or indirect pneumatic-drive vapor cycle refrigeration systems. $T_{Es} = 590^{\circ}R$ . $\alpha = 2$ . $L_D = 200$ feet .	75

INTRODUCTION

The present generation of military aircraft has brought to reality a major problem of high speed flight that has long been predicted by aircraft specialists. The problem is the prevention of excessive temperatures of various component parts of an aircraft. A major factor in the manifestation and increasing severity of this problem is the advance in aircraft flight speeds. Other factors, such as higher flight altitudes and greater heat generation per unit space occupied within the aircraft, have increased the technical difficulties of maintaining temperature levels compatible with the reliable operation of available components. However, the advent of supersonic flight has undoubtedly been the strongest factor in establishing the importance of the problem. With flight speeds continuously on the increase, the obligation to minimize the aircraft's handicap because of cooling requirements is clear.

In recent years, overheating of electronic equipment has been encountered even under subsonic flight conditions. The principal causes were unrealistic thermal design specifications based on loosely defined environmental standards, and installation without adequate provisions for conditioning the equipment's environment. At greater flight speeds, cooling of electronic equipment has become more critical. The need for cooling other mechanical and electrical equipment items has increased because aircraft skin and compartment temperatures are reaching levels in excess of the allowable temperatures of many available equipment components. The development of components capable of withstanding higher environmental temperatures is lagging the rate of increase of these temperatures. Not only components generating heat or in contact with heat sources require cooling; others must be cooled to offset their heat gain from the environment. The only alternative to the development of heat-resistant components, and the second best choice from the viewpoint of aircraft performance, is the use of compact and efficient cooling systems capable of maintaining acceptable equipment temperatures. This systematic approach to temperature control of all equipment items is desirable in order to compromise aircraft performance as little as possible. Also, the design of equipment can best be coordinated with controlled thermal conditions and compatibility can so be insured. Furthermore, since future aircraft designs appear to accentuate the difference in growth of the permissible temperature level of equipment items and of the aircraft's general temperature level, the development of cooling systems appears to define the only possible solution to the prevention of equipment failure from overheating.

Cooling systems impose a penalty on the aircraft. They have dead weight, they often require shaft power or air extraction from one or several of the aircraft's powerplants and frequently introduce considerable parasitic and momentum drag. All of these factors increase the required fuel flow rate to the powerplants if the flight conditions are to

# Contrails

remain the same. If the aircraft must fly the same mission and carry the same payload, the critical fuel load and gross weight must increase; or, a reduction in payload or range of the aircraft might be accepted as the penalty resulting from the cooling system. Results of system evaluation show that quite frequently the gross weight must increase from 10 to 50 pounds per kilowatt cooling capacity in order that the aircraft with the cooling system may have the same range and payload as the aircraft without a cooling system. The penalty on an aircraft when a cooling system is added arises also from the space occupied by the cooling system, which frequently may be considerable, and possibly also from increased aircraft vulnerability and complexity. The flight penalty resulting from cooling systems, particularly in the supersonic flight range, is of an order of magnitude such that careful design and selection of the cooling system represents an important aspect of aircraft design.

## Scope of Study

The purpose of this study has been to determine operating characteristics, limitations and relative merit considerations of various equipment cooling systems to aid in the selection of a standard equipment cooling system or systems for future aircraft use. It has been intended that the study shall cover the basic types of cooling systems and various heat transfer fluids available for equipment cooling in an airplane, the problems associated with widely distributed cooling needs, the general problems of system design, and the relative merits of a centralized equipment cooling system as compared to an individualized equipment cooling system. The results of the study of various heat transfer fluids were presented in a separate report entitled Heat Transfer Fluids for Aircraft Equipment Cooling Systems, The Ohio State University Research Foundation, February 1954, WADC Technical Report No. 54-66.

The comparison of individualized versus centralized cooling systems conducted within this study is based upon direct versus indirect cooling systems, which are defined in the next sub-section. The comparison of the use of a number of cooling systems versus one centralized system has not been covered by the scope of this study.

The entire study is based on steady-state operating conditions for both the cooling system and the aircraft. The flight-speed altitude range considered in the study is shown in Figure I-1. The maximum flight Mach number is 1.8, in the altitude range from 35,000 to 45,000 feet, and the maximum altitude is 65,000 feet. The NACA standard altitude-pressure schedule is used. The atmospheric ambient temperature range specified for the study is shown in Figure I-2. The highest temperature schedule is used as the basic altitude-temperature schedule for the entire cooling system study, since the severest requirements of cooling systems would exist under these conditions. The corresponding total temperatures and total pressures of the atmospheric air within the altitude-Mach number range under consideration are presented in Figures I-3 and I-4, respectively. The total temperature has a maximum value of about

# Contrails

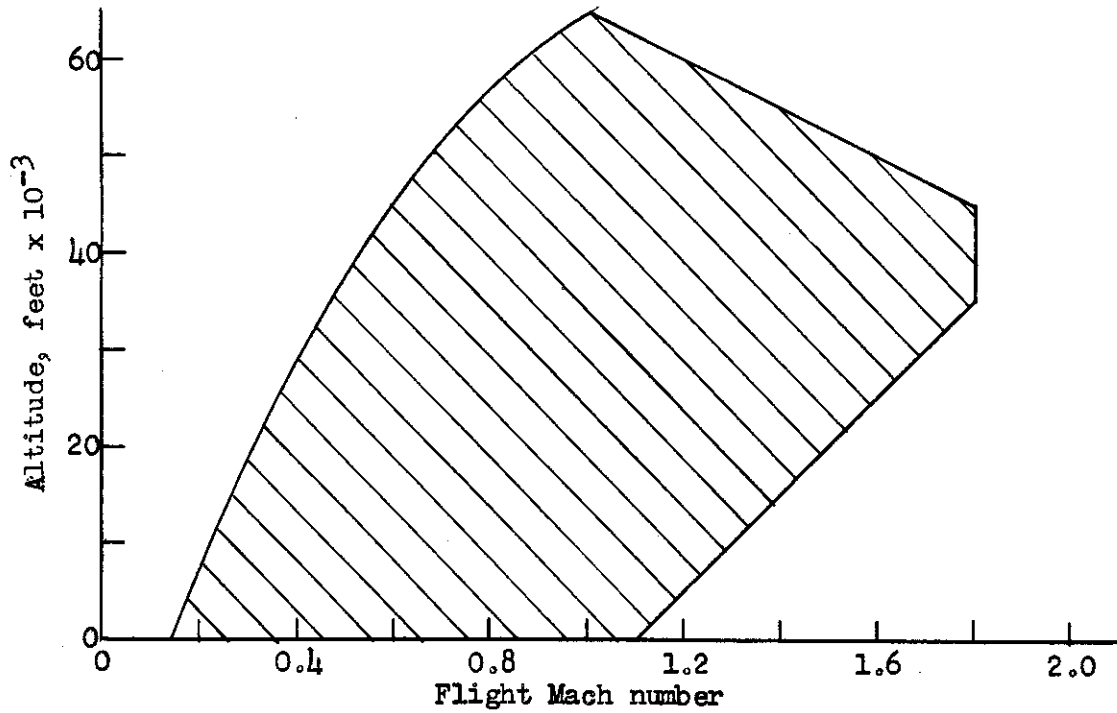

Figure I-1. Flight altitude-Mach number range considered in the cooling system study.

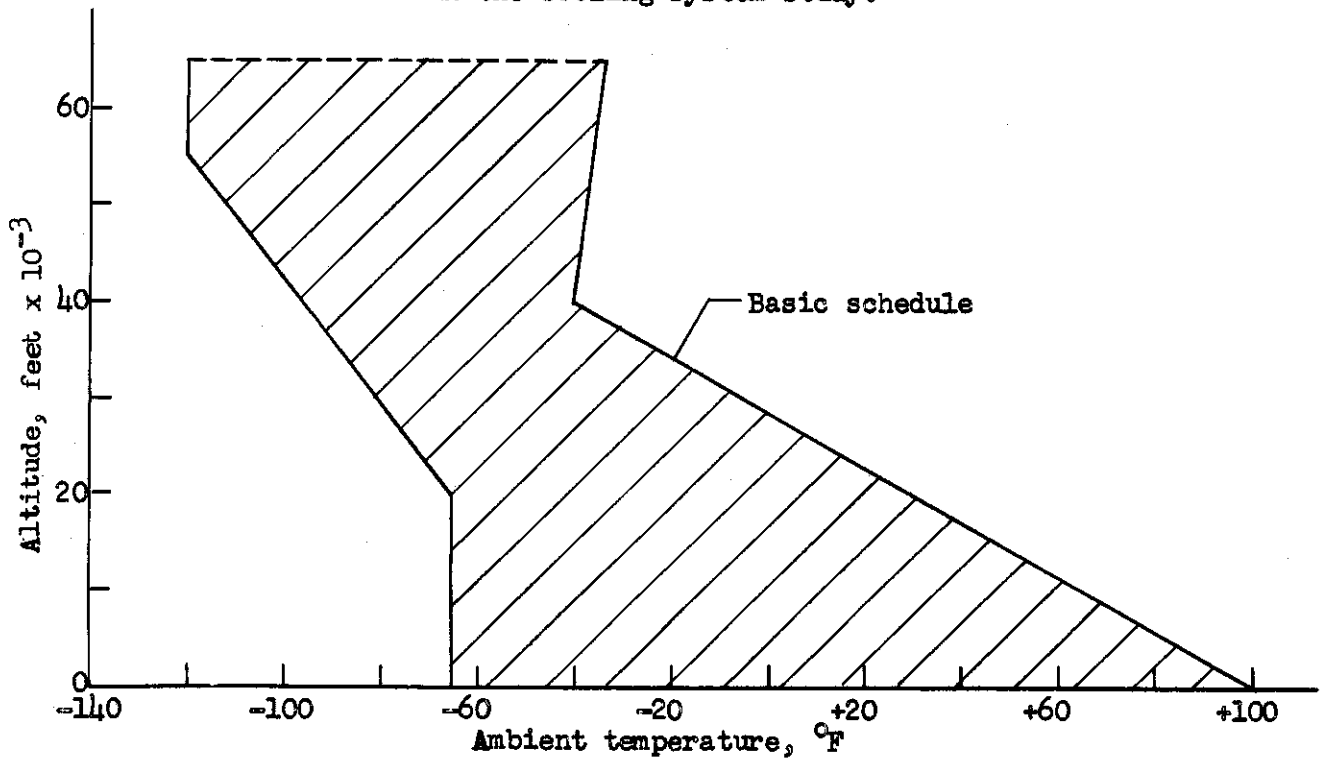

Figure I-2. Ambient temperature-altitude range specified for the cooling system study.

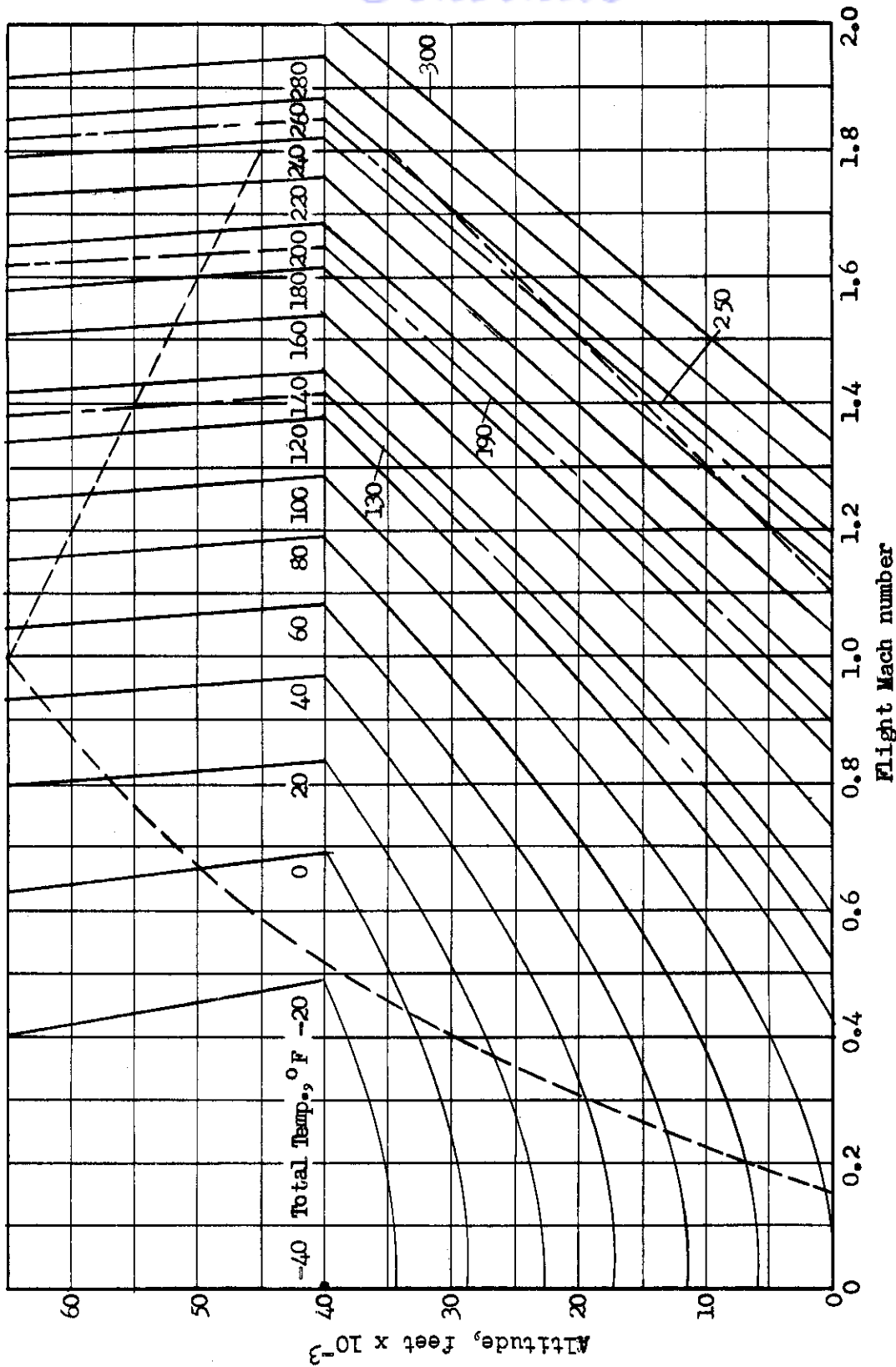

Figure I-3. Variation of total temperature of air within the flight altitude-Mach number range specified for the cooling system study. Ambient temperature-altitude schedule corresponds to the basic schedule as indicated in Figure I-2.

# Contrails

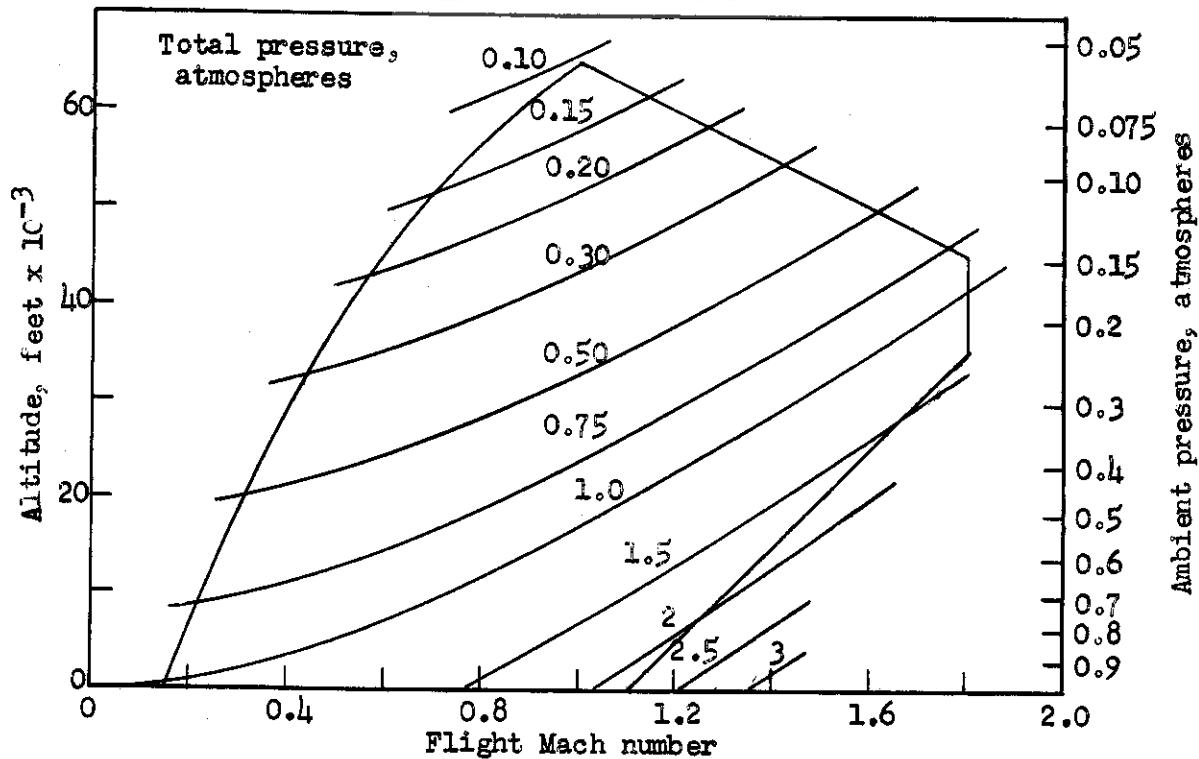

Figure I-4. Variation of total pressure of atmospheric air within the flight altitude-Mach range specified for the cooling system study.

260°F and a minimum value of around -15°F for the basic temperature schedule indicated in Figure I-2. The dashed lines in Figure I-3, corresponding to total temperatures of 130°, 190° and 250°F, are of importance since the lowest, average and highest temperature levels set for the equipment component in this study are equal to these values. The total pressure of the atmospheric air has a maximum value of about 2.8 atmospheres and a minimum value of about 0.11 atmospheres, a ratio of about 25 to 1. Throughout a very significant portion of the flight altitude-Mach number schedule the total pressure is in the general vicinity of one atmosphere. Pressures so indicated define the pressure potential of the air and not the actual total pressure the air may have once taken on board the aircraft. The ambient or static pressure of the air is defined by the altitude and may be compared with the total pressure for any flight condition by use of the auxiliary pressure scale on the ordinate of Figure I-4.

The surface temperature for heat exchange at any equipment item or group of items considered in the study is from 130° to 250°F. This surface temperature defines the temperature level at which the heat originating within the equipment items is first received by the cooling system. The required cooling capacity of any system is considered to vary from as low as one kilowatt up to the order of 100 kilowatts. Flight time is considered as a variable only in the case of expendable cooling

# Contrails

systems since only steady-state operational conditions are considered. The relative location of equipment items is varied to the point where the most distant items are 150 feet from the heat sink, corresponding to a maximum length of 300 feet for a closed circulation system. Among merit considerations for cooling systems are weight, space, reliability, simplicity, drag, energy required in the form of shaft, electrical, pneumatic or hydraulic power, overall penalty imposed on the aircraft, the ability of the system to operate while the airplane is on the ground, vulnerability, "off-design" performance, simplicity of control and ease of maintenance. The last four merit items of each system have not been analyzed in the study.

## Classification of Cooling System Components and Types

To facilitate evaluation of the performance, physical characteristics and various merit considerations of cooling systems, it has been found desirable to define basic types of cooling systems, components and fluids. The basic types of cooling systems are considered to be (1) direct cooling systems and (2) indirect cooling systems. The basic components of any cooling system are considered to be (1) the equipment component, (2) the distribution component, (3) the intermediate component and (4) the ultimate component. Heat transfer fluids associated with any cooling system are classified as (1) the ultimate fluid and (2) the transfer fluid. Definition of the classes of fluids and components are presented in the following, after which the interpretation of direct and indirect cooling systems is given.

The ultimate fluid is defined as that fluid which, when in association with a cooling system, is the last fluid to receive heat rejected by the equipment items. The ultimate fluid serves as the thermal sink for the cooling system, it is the fluid in contact with the cooling system by which heat originating in the equipment items is ultimately received. Air is a common ultimate fluid, although it may also be the aircraft's fuel or an expendable fluid such as water or ammonia.

The transfer fluid is defined as any fluid which might be used to convey heat from the equipment component to a component in the system where the heat would be rejected to the ultimate fluid. The transfer fluid is always associated with the distribution component and always passes through any or all of the equipment components in the cooling system. A suitable transfer fluid, and the type employed throughout this study, is a mixture of water and methyl-alcohol having a freezing point of  $-65^{\circ}\text{F}$ .

The equipment component is defined as a heat exchange surface which is a part of an equipment item. The heat exchange surface, having a uniform temperature in the range of  $130^{\circ}$  to  $250^{\circ}\text{F}$ , represents the surface from which heat to be disposed of by the cooling system is first received by the cooling system. Either the ultimate or the transfer fluid passes through the equipment component, depending upon the type of cooling sys-



tem. Additional details of the equipment component are presented in Section IV.

The distribution component is a flow system used for circulating the transfer fluid between the equipment and the intermediate components. The distribution component includes all tubing, valving, the circulation pump and the power supply system necessary for providing shaft power to the circulation pump. Details of the performance and physical characteristics of the distribution component are presented in Section V.

The intermediate component represents the component parts of a cooling system which serve to transfer the heat from the transfer fluid to the ultimate fluid. The physical characteristics of the intermediate component depend upon whether the temperature of the transfer fluid is greater or less than the temperature of the ultimate fluid at the intermediate component. Most commonly, within the present study, the temperature of the transfer fluid is greater than the temperature of the ultimate fluid at the intermediate component, so that heat transmission from the transfer fluid to the ultimate fluid may occur in a conventional heat exchanger. The basic type of heat exchanger which would be employed depends upon the type of cooling system. If the transfer fluid is a liquid, the intermediate component would be a liquid-to-gas heat exchanger when the ultimate fluid is air, or a liquid-to-liquid heat exchanger when the ultimate fluid is, for example, fuel. Should the temperature of the ultimate fluid be greater than that of the transfer fluid at the intermediate component, the use of a heat exchanger as the intermediate component would not be possible; or, if the temperature of the ultimate fluid is less than but near the temperature of the transfer fluid, the small temperature potential would necessitate the use of very large heat exchangers. For these cases a refrigeration device may be used as the intermediate component to provide (1) a sink at lower temperature for transfer of heat from the transfer fluid and (2) a source at higher temperature for transfer of the same energy as heat from the intermediate component to the ultimate fluid. A refrigeration device such as a vapor refrigeration machine can provide the low temperature sink for the transfer fluid in its evaporator and the high temperature source for the ultimate fluid in its condenser. Hence, the intermediate component serves as a heat pump for the cooling system, and requires, therefore, an input of mechanical energy for its operation.

The ultimate component of a cooling system is defined as all cooling system equipment associated with any conditioning of the ultimate fluid and providing a flow circuit for it. Devices commonly used as parts of the ultimate component are air inlets and outlets or diffusers and nozzles, ducts, turbines, compressors, storage tanks, heat exchangers other than those associated with the intermediate component, blowers, etc. The ultimate component has the sole function of handling and processing the ultimate fluid for delivery to and from the intermediate or equipment component. For instance, the processing may be to provide air having a total pressure greater than the atmospheric ambient pressure, or to increase the total pressure and lower the total temperature, or to store

*Contrails*

and deliver a liquid to an intermediate component.

All cooling systems have an equipment component and an ultimate component. A direct cooling system is defined as one consisting only of the equipment and ultimate components. In all direct cooling systems the ultimate fluid passes through the equipment component. Thus, for operation of a direct cooling system, the total temperature of the ultimate fluid must be lower than the surface temperature of the equipment component; otherwise, the ultimate fluid would heat rather than cool the equipment items.

An indirect cooling system is defined as one wherein an intermediate component is used, so that the ultimate fluid never flows through the equipment component but always through the ultimate side of the intermediate component. Although indirect cooling systems always have equipment, intermediate and ultimate components, they may or may not have a distribution component. However, any cooling system employing a distribution component is always an indirect system.

Whether or not a distribution component is employed essentially permits classifying the cooling system as a centralized or an individualized cooling system, regardless whether the system without a distribution component is direct or indirect, i.e., regardless whether an intermediate component is involved in a system without a distribution component. Any cooling system serving one equipment item or a highly localized group of equipment items would not, for all practical purposes, require a distribution component if the cooling system proper is located in the near vicinity of the equipment items. Hence, the system without a distribution component would be classified as an individualized system, since other cooling needs in locations remote to this single item or localized group would require separate cooling systems. Oppositely, however, when a distribution component is used the cooling system proper may be centralized and the distribution component can serve single equipment items or groups of equipment items in various locations throughout an aircraft.

The general and important exception to the above interpretation of centralized and individualized systems in terms of whether a distribution component is used would be when the ultimate fluid is distributed throughout the aircraft to serve various equipment items. For example, consider the case of direct cooling systems. The cooling system proper might be centrally located and the ultimate fluid distributed to various equipment components throughout the aircraft. This situation would define a centralized direct cooling system. Or, each equipment component or each localized group of equipment components might be served by a separate direct cooling system. This situation would define individualized direct cooling systems. A similar interpretation may be applied to indirect cooling systems when more than one ultimate component is used throughout the aircraft.

Possibly several types of cooling systems may best serve the cooling needs of an airplane, or there may exist an optimum number of the

same type of cooling systems in any specified aircraft having varying and widely separated cooling requirements. These aspects of application of centralized and individualized cooling systems are not covered within the scope of the study presented in this report.

### Availability of Air as the Ultimate Fluid

Atmospheric air represents the most natural ultimate fluid for aircraft cooling systems. How profitable it is to use air rather than some other fluid as the ultimate thermal sink depends upon many factors. The factor of prime importance is the magnitude of the air's total temperature relative to the desired temperature level of the equipment component. The temperature of the heat transfer surface of the equipment component is considered in this study to be in the range from 130° to 250°F. The total temperature of air throughout the flight altitude-Mach number range considered in this study is shown in Figure I-3. The availability of air as an ultimate fluid may be discussed by consideration of this plot.

In order to use air, in the thermal state as taken on board an aircraft, for the system's heat sink, the total temperature must be below the desired temperature level of the equipment component. Assume, for example, that a practical minimum temperature difference would be on the order of 50° to 75°F. Thus, should the desired temperature level of the equipment component be 130°F, Figure I-3 indicates that the availability of air as the ultimate fluid in an unmodified thermal state extends over about one-third of the flight range under consideration, with the greatest portion of the flight range being above an altitude of 30,000 feet. Should the desired temperature level of the equipment component be the highest considered, i.e., 250°F, then for a minimum temperature differential of 50° to 75°F, the availability of air in an unmodified thermal state extends over roughly three-fourths of the flight range under consideration, but with the high Mach number range being excluded. For an average temperature level of the equipment component at 190°F, the availability of air as the ultimate sink extends over somewhat more than one-half of the flight range.

Hence, it is clear that apart from other important limitations of cooling systems, the availability of air in its natural on-board thermal state as an ultimate fluid is seriously restricted, and consideration must be given to ultimate components which are capable of modifying the thermal state of the air, to ultimate components which do not employ air as the ultimate fluid, or to cooling systems which employ heat pumps. All of these general methods are considered in this study and evaluation of cooling systems. Ram air and blower cooling systems are examples of systems which employ air in an unmodified thermal state as the ultimate fluid. Expanded ram-air and bleed air cooling systems are examples of using air in a modified thermal state as the ultimate fluid. Expendable and fuel cooling systems are examples of using fluids other than air as the ultimate fluid and the vapor cycle cooling system is an example of using a heat pump. With the latter type of cooling system air may be

used in an unmodified or modified thermal state for the ultimate fluid. Descriptions of these cooling systems and their principles of operation are discussed in the following paragraphs.

## Description of Cooling Systems

The cooling systems considered in this study are (1) ram air, (2) expanded ram-air, (3) bleed air, (4) blower, (5) fuel, (6) expendable and (7) vapor refrigeration. The air systems are considered for both direct and indirect cooling of equipment items. The fuel, expendable and vapor refrigeration systems are considered only as indirect systems. Throughout the entire study, design characteristics are developed for steady state operational conditions only. A general description of each type of cooling system studied is presented in the following.

### 1. Ram Air Cooling System

Atmospheric air taken on board an aircraft may be used for cooling without prior conditioning as long as its total temperature is somewhat below the required temperature level of the equipment items being served. When the atmospheric air is used as the ultimate fluid without any intermediate refrigeration equipment and the source of pressure for overcoming flow resistance of the ultimate component is total pressure recovery during the intake process, the cooling system is called a ram air system. The ram air system may be a direct or indirect cooling system. When air as the ultimate fluid is conveyed directly to and passes through the equipment component, the system is classified as a direct system. When the ultimate fluid, ram air, serves the intermediate component, which would be a heat exchanger, and a transfer fluid is used to convey energy as heat from the equipment component to the intermediate component, the system is classified as an indirect cooling system. The case of a ram air system serving a heat pump is classified separately.

A schematic arrangement of a ram air cooling system is shown in Figure I-5. Atmospheric air is taken on board the aircraft through an

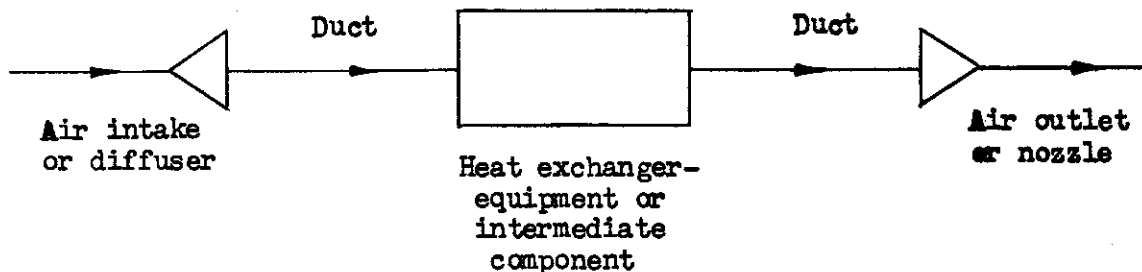

Figure I-5. Schematic arrangement of ram air cooling system.

# Contrails

intake. During this process both temperature and pressure of the air increase. At exit of the intake the total temperature of the air is equal to, for all practical purposes, the total temperature of the atmospheric air while the total pressure will be below the total pressure of the atmospheric air. Both static pressure and temperature of the air at exit of the intake are, however, above atmospheric ambient pressure and temperature, since, in general, the duct Mach number should be appreciably below the flight Mach number in order to avoid excessive flow resistance and, also, to have available a pressure potential for overcoming all resistance in the flow path. The first duct conveys the ram air from the intake to the heat exchanger; the latter being the equipment component with direct cooling systems and the intermediate component with indirect systems. The air passing through the heat exchanger undergoes an increase in total temperature, because of heat received by the air in producing a cooling effect, and a decrease in total pressure because of the flow resistance of the heat exchanger. The heated air is then conveyed by the second duct to the air outlet. Since, in general, the total pressure of the air at the entrance to the air outlet is above atmospheric pressure, a nozzle serving as the outlet may be advantageously employed to expand the air and generate thrust. Any thrust so generated will compensate for the drag imposed on the aircraft during the intake process and reduce the penalty of the cooling system.

The thermodynamic and fluid dynamic processes are illustrated in Figure I-6 in the temperature-pressure plane. State ( $\infty$ ) defines the atmospheric ambient pressure and temperature, state ( $\infty^0$ ) the total pressure and temperature of the atmosphere, state (df-e) the total pressure and temperature at exit of the diffuser or intake, state (X-i) total pressure and temperature after the first duct and at inlet to the heat

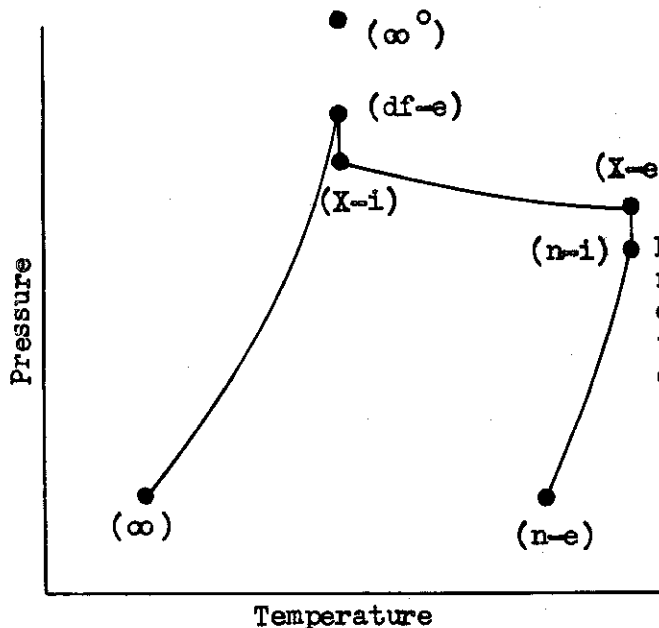

Figure I-6. Ultimate component processes in a ram air cooling system represented in the pressure-temperature coordinate plane.

exchanger, state (X-e) total pressure and temperature at exit of the heat exchanger, state (n-i) at exit of the second duct and entrance of the outlet or nozzle and state (n-e) when the air has expanded to atmospheric pressure.

The weight and volume of direct ram air systems are defined by the weight and volume of the diffuser, nozzle and the ducts connecting the heat exchanger with the diffuser and nozzle, since the equipment component is not considered as a physical component proper of the cooling system. Both weight and volume of the system represent penalties on the aircraft. In addition to these penalties, most frequently the thrust generated during escape of the ram air is not sufficient to completely cancel the drag resulting when the air is taken on board, so that a net drag is imposed on the aircraft.

Indirect systems increase the penalty on the aircraft because of the weight and volume of the intermediate and distribution components, the power required to circulate the transfer fluid in the distribution component and the somewhat larger weight, volume and drag of the ultimate component. The temperature potential available for the ram air in indirect systems can never be quite as large as with direct cooling systems for the same desired temperature level of the equipment component.

Ram air cooling systems serving low temperature equipment items, having equipment component surface temperatures around 130°F, may be seen by reference to Figure I-3 to be limited essentially to subsonic flight, except possibly at high altitudes since the total temperature of the air must be maintained somewhat below the equipment component surface temperature. However, at high altitudes the system volume and weight will be greater because of the low air density. Thus, for low equipment temperatures the system penalty may be expected to be relatively high anywhere in the supersonic region. If the equipment component temperature level is around 250°F, operation of the system to Mach numbers in the vicinity of 1.5 may be expected at altitudes above about 30,000 feet. Operation at very low altitudes would limit the flight speed to the subsonic region.

The general advantages of ram air cooling systems are simplicity, low aircraft penalty in the subsonic flight region, ease of control and the possible freedom in location of the ultimate component. Disadvantages of the system would include the relatively severe flight speed limitations, need of auxiliary equipment for ground cooling and the large spatial requirements of the ultimate component for high altitude operation.

## 2. Expanded Ram-Air Cooling System

The temperature potential on which a cooling system operates is a direct function of the total temperature of the cooling fluid at inlet to the intermediate heat exchanger with indirect systems and at inlet to the equipment component with direct cooling systems. Any reduction in

# Contrails

this temperature can serve to lower the fluid flow rate required and to increase the temperature differential for heat transfer in any heat exchange device. Thus, should this temperature be reduced by some means, one may expect smaller heat exchangers and ducts and lower external and momentum drags because of the lower flow rates, but must expect a counteracting increase in the penalty from the physical devices introduced to increase the system's temperature potential and in any way that their introduction affects the other components of the system. Furthermore, it is of considerable importance that any means by which this temperature potential can be increased permits operation of the cooling system at higher flight Mach numbers.

The general principle in lowering the total temperature of the fluid at inlet to the equipment or intermediate component, assuming the absence of any phase change, would be to remove energy, which is commonly accomplished by expanding the substance in a mechanical device such as a turbine. Thus, the ram air system may be modified to permit reduction of this temperature by introducing a turbine after the ram air intake or diffusion process and ahead of the heat exchanger. The turbine must have a load and is, therefore, directly coupled to a compressor located in the flow circuit after the heat exchanger. Thus, energy removed from the air during expansion in the turbine is delivered back to the air at a higher temperature level by the compressor. A system of this type using ram air to serve directly either the equipment or intermediate heat exchanger is called an expanded ram-air cooling system.

A schematic arrangement of an expanded ram-air cooling system is shown in Figure I-7. Air is taken on board the aircraft through an inlet which must serve as a diffuser to provide as high a total pressure as possible at exit of the diffuser, which will always be less than the total pressure of the free-stream air. The total temperature of the air at exit of the diffuser will be equal to, for all practical purposes, the total temperature of the free-stream air. The relatively high pressure, high temperature air is then conveyed by a duct to the ram air turbine, wherein the air is expanded to permit a conversion of molecular energy

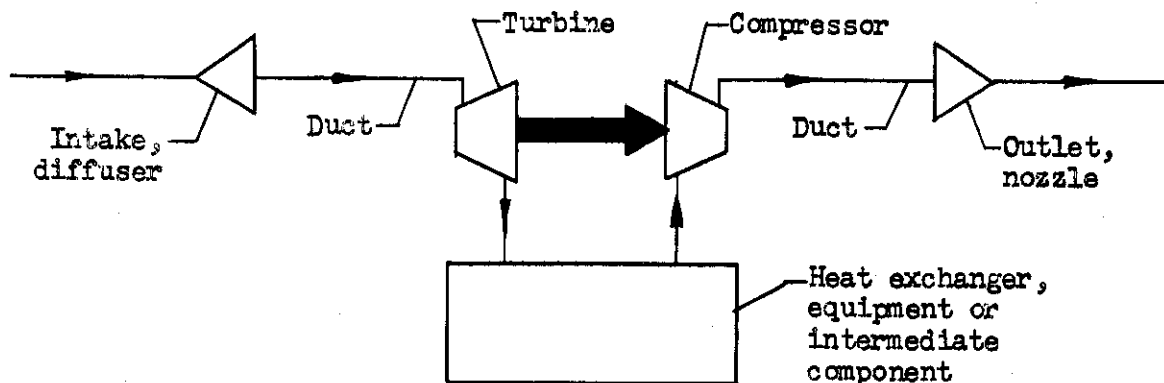

Figure I-7. Schematic arrangement of an expanded ram-air cooling system.

# Contrails

into mechanical work and a corresponding lowering of the total temperature of the ram air. Thus, it would be entirely possible to operate the system at a flight condition such that the initial total temperature of the ram air is in excess of the desired temperature level of the equipment items being served by the cooling system, a condition which would render the straight ram air cooling system impossible for use. The low pressure, relatively low temperature air then flows to a heat exchanger, which would be the equipment component in a direct cooling system and the intermediate component in an indirect cooling system, and undergoes an increase in total temperature which is proportional to the cooling produced by the system. The total temperature of the air at exit of the heat exchanger could be somewhat above or below the initial total temperature of the ram air, but will always be lower than the temperature level of the equipment component. The total pressure of the air at exit of the heat exchanger will be slightly lower than that at exit of the turbine because of the flow resistance of the heat exchanger. From the heat exchanger the heated air flows to the compressor which is directly coupled to the turbine. Except for mechanical losses in both turbine and compressor, the energy removed from the air during passage through the turbine is given back to the air during passage through the compressor. Hence, the compressor serves to increase both total pressure and total temperature of the air before being delivered to the exhaust of the system. The air is then conveyed to the outlet and would be expanded in a nozzle to atmospheric pressure for the development of thrust to counterbalance the drag associated with taking the air on board the aircraft.

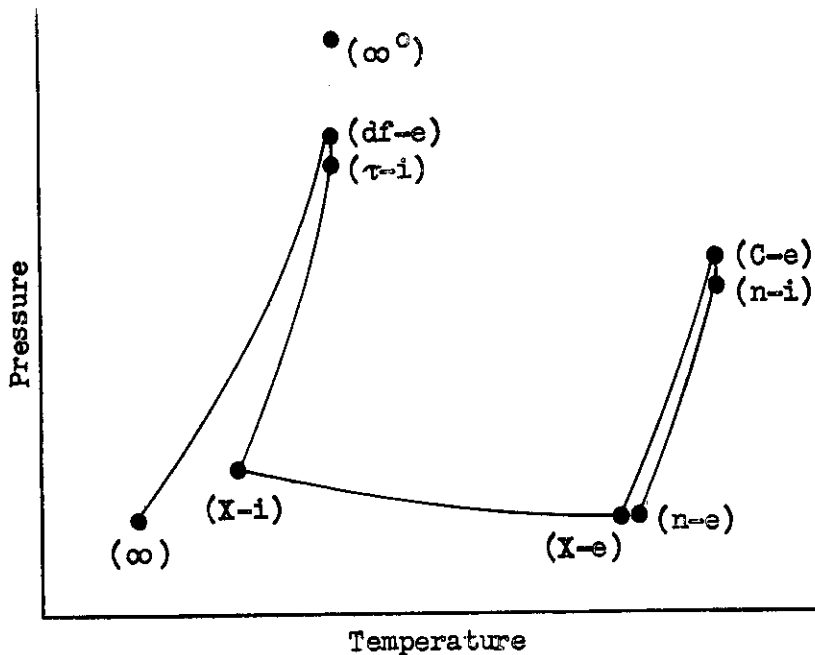

Figure I-8. Ultimate component processes of an expanded ram-air system represented on the temperature-pressure coordinate plane.



The processes and state changes of the air passing through the ultimate component of this type of cooling system are illustrated in the temperature-pressure coordinate plane in Figure I-8. State ( $\infty$ ) represents the ambient atmospheric pressure and temperature, state ( $\infty^0$ ) the total pressure of the atmospheric air, state (df-e) the total state condition of the air at exit of the diffuser, ( $\tau$ -i) at inlet to the turbine, ( $\tau$ -e) at exit of the turbine, (X-i) and (X-e) at inlet and exit of the heat exchanger, (C-i) and (C-e) at inlet and exit of the compressor and (n-i) and (n-e) at inlet and exit of the exhaust nozzle, respectively. The various states illustrated in Figure I-8 correspond to maintaining atmospheric static pressure at inlet to the compressor. The pressure level through the heat exchanger and compressor is governed by the selected back pressure of the turbine, which has an optimum value for each operational condition of the system.

Penalties on the aircraft resulting from the use of expanded ram-air cooling systems are due to weight, volume, drag, etc., as with any other system. The weight and volume of the ultimate component are defined by the weight and volume of the inlet, outlet, ducts, turbine and compressor. With indirect systems the weight and volume of the intermediate and distribution components must be included. Drag of the system arises from external and momentum drags associated with the ram air flow and the equivalent drag of the increased fuel flow to a powerplant when shaft power is extracted for circulation of the transfer fluid through the distribution component.

The effective utilization of ram air for cooling at higher flight Mach numbers than with the straight ram air system is possible with the expanded ram-air system, but, in general, at a sacrifice of the weight and drag of the system. Thus, following the usual pattern, the effective use of the same ultimate fluid at higher flight Mach numbers imposes greater penalty on the aircraft. The weight and volume of the ultimate component in expanded ram-air systems versus the weight of the ultimate component in straight ram air systems are greater because of the turbine and compressor. The weight and volume of the intermediate heat exchanger will be somewhat greater in expanded ram-air systems because of the lower average pressure level throughout the exchanger. Drag will be greater because of the inefficiencies of the turbine and compressor which introduce loss in total pressure of the air between the inlet of the turbine and the outlet of the compressor. These general comparisons apply to the effective flight Mach number ranges of application for each system rather than to the same flight Mach number for each system.

The primary advantage of the expanded ram-air system is the general possibility of using ram air for cooling at higher flight Mach numbers. A second advantage of the system would be that the ram air is conditioned without the system relying on any of the aircraft's powerplants. This allows freedom of penalty directly imposed on the powerplant and, possibly somewhat greater freedom in the location of the ultimate component. Disadvantages of the system would include the difficulty of using the system for ground cooling, the added complexity of

controlling the turbine-compressor combination, low pressure levels in the heat exchanger of the ultimate component and, in some instances, the fact that effective utilization of the system depends greatly on providing a very efficient intake diffusion process.

### 3. Bleed Air Cooling System

Like the expanded ram-air cooling system, the bleed air cooling system modifies the thermal state of the air used as the ultimate fluid before the air is delivered to the intermediate or equipment component. However, in bleed air cooling systems the availability of the air for cooling purposes is increased over that of the expanded ram-air systems since for any flight speed it is possible for the temperature of the air at exit of the turbine to be lower than the corresponding temperature in an expanded ram-air system. Thus, bleed air cooling systems may be employed at higher flight Mach numbers than either the expanded ram-air or the straight ram air cooling systems.

The general method by which the increase in availability of the air is accomplished is by compressing air, after the air has been taken on board the aircraft, by a mechanical compression device. The air at exit of the compressor has both a total pressure and total temperature greater than its total pressure and total temperature at exit of the ram air intake. Then, by virtue of its higher total temperature the compressed air may be cooled and have its total temperature lowered by ram air which does not pass through the compressor. The cooling process can take place in a conventional air-to-air heat exchanger, where by employing high effectiveness of heat exchange on the high-pressure side of the exchanger nearly all energy added to the air during passage through the compressor can be rejected to the ram air on the opposite side of the heat exchanger. Thus, at exit of the heat exchanger the total pressure of the air that flowed through the compressor can be appreciably greater than total pressure of the ram air, while its total temperature would be only slightly higher than the total temperature of the ram air. Then, the air can be expanded through a larger pressure ratio in a turbine so that with a comparable efficiency of energy conversion in the turbine as with the expanded ram-air system, the total temperature of the air at exit of the bleed-air turbine is lower and the cooling system temperature potential greater. Employing additional compression, a precooling heat exchanger and secondary ram air permits greater energy removal in the turbine than is possible in the expanded ram-air system. For cooling systems of this type, herein considered, the compressor or compressors of the aircraft powerplants are employed to provide the additional compression. Air is extracted from the compressor or compressors and conveyed to the precooling heat exchanger. For this reason, the system is referred to as a bleed air cooling system. Many other types of bleed air cooling systems have been proposed, but are not considered within the scope of this study.

A schematic arrangement of the bleed air cooling system is shown in Figure I-9. Bleed air is conveyed from the compressor or com-

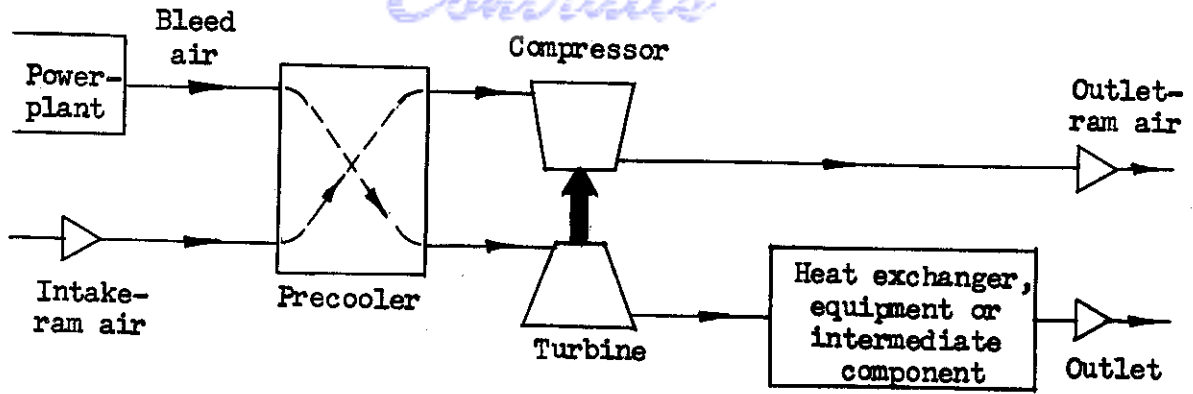

Figure I-9. Schematic arrangement of bleed air cooling system for direct or indirect equipment cooling.

pressors of the aircraft powerplants by a duct to the precooling heat exchanger and then to the turbine. After expanding in the turbine and having its total temperature reduced, the bleed air is conveyed to a heat exchanger which would be the equipment component with direct cooling systems and the intermediate component with indirect systems. The bleed air would then be discharged, probably from the aircraft through an outlet. A load must be provided for the turbine, and to utilize any mechanical energy for minimizing the penalty of the system a compressor is located in the ram air flow circuit, after the precooler, and is directly coupled to the turbine. Thus, energy removed from the bleed air by the turbine is given to the ram air by the compressor, exclusive of mechanical losses in the compressor and turbine. The ram air undergoes both an increase in total pressure and temperature through the turbine which serve to increase the possibility of developing thrust during escape from the aircraft. Any thrust so generated will aid in minimizing the penalty associated with taking the ram air on board the aircraft. The various states of the bleed and ram air throughout the system are identified on the pressure-temperature plot shown in Figure I-10.

Penalties imposed on the aircraft by bleed air cooling systems are the result of the system's weight and volume, external and momentum drags, the equivalent drag due to air and shaft power extraction of the aircraft's powerplants, etc. The weight and volume of the ultimate component are those of the ducts, precooler, turbine, compressor, air inlet and outlet and system controls. The weight and volume for the distribution and intermediate components must be included with indirect systems. A major portion of the system's drag is represented by the equivalent drag of the increased fuel flow for maintaining constant propulsive thrust when air is extracted from the aircraft's powerplants to serve as the ultimate fluid in the system.

The principal advantage of the bleed air cooling system is its

# Contrails

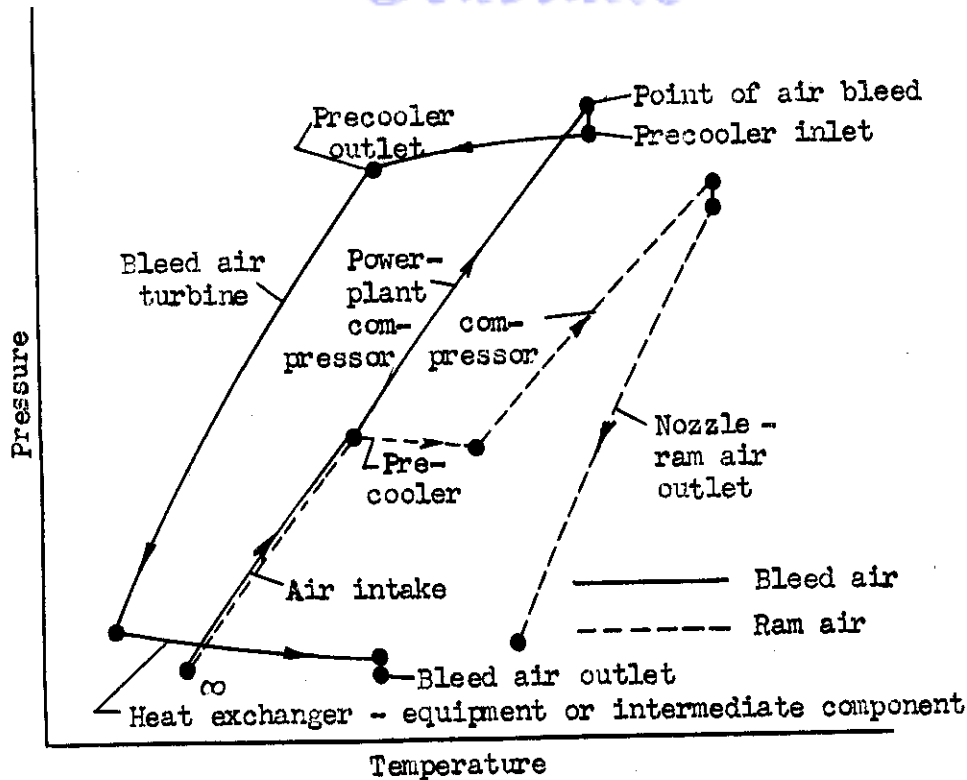

Figure I-10. Ultimate component processes in bleed air cooling systems represented on the pressure-temperature plane.

ability to provide relatively high system temperature potentials at flight speeds in the range between Mach 1 to 2. Thus, it is possible to provide cooling of equipment items requiring temperature levels in the range from 130° to 250°F without the need of excessively high ram and bleed air flow rates. To provide this primary advantage, several additional parts must be included in the ultimate component, e.g., a pre-cooler and a secondary air flow circuit, all of which increase the weight and volume of the system and the penalty imposed on the aircraft's flight performance. The system relies on the use of a mechanical compressor, which may restrict the flexibility in the location of one or several ultimate components. An important advantage of the system is that ground cooling of equipment items is possible.

#### 4. Blower Cooling Systems

Blower cooling systems cannot be considered applicable and practical for extensive ranges of aircraft and cooling system operational conditions. Blower systems are considered in this study mostly from the viewpoint of special cooling applications and for comparison with ram air

cooling systems. The principal areas of interest would be in the subsonic flight region and for cooling of equipment items located in ventilated compartments. When equipment items to be cooled are located in compartments within an aircraft having a natural throughflow of atmospheric air, external and momentum drags chargeable to a cooling system may be essentially eliminated by providing a blower to overcome the flow resistance of any heat exchangers associated with the cooling system. The penalty of this type of cooling system would result only from the blower and its power supply system for direct systems and, in addition, the intermediate and distribution components with indirect systems.

Blower cooling systems, like ram air systems, are severely limited in application by the aircraft's flight speed and altitude. The limits imposed by flight speed are, for all practical purposes, the same as discussed for ram air cooling systems. The size of the blower at high altitudes is quite large. Also, control of blower systems over wide ranges of flight altitude and speed appears unduly complicated. The advantageous application of blower cooling systems appears relegated to special cooling requirements for dispersed equipment items of relatively small heat dissipation at subsonic flight speeds and moderate altitudes. Blowers designed for high-altitude operation usually can provide more than adequate cooling on the ground.

## 5. Fuel Cooling Systems

The use of the aircraft's fuel as an ultimate fluid for cooling systems has often been proposed since it represents a sink of considerable thermal capacity. Many arrangements and types of fuel cooling systems are possible. Fuel cooling systems evaluated in this study are for (1) heat transfer to fuel flow to the powerplants, (2) steady-state operational conditions, (3) indirect systems and (4) no change in phase of the fuel.

The temperature of the fuel at inlet to the cooling system is assumed equal to the adiabatic skin temperature of the aircraft; the temperature considered most representative of the equilibrium fuel temperature for steady-state thermal conditions. Indirect systems are evaluated since it would not be considered practical nor desirable to convey fuel away from the immediate vicinity of the aircraft's fuel system. Thus, the intermediate component is located in the near vicinity of a fuel line and a distribution component is employed to transfer heat rejected in the equipment components to the intermediate heat exchanger. The fuel is considered to serve as an ultimate fluid without change in phase, so that the pressure level of the fuel in the intermediate component is assumed sufficiently high to prevent boiling.

A schematic arrangement of the type of fuel cooling system evaluated in this study is shown in Figure I-11. The system consists of the equipment component or components, a distribution component, an intermediate component and the ultimate fluid. The ultimate component would be the aircraft's fuel system which is not considered part of the

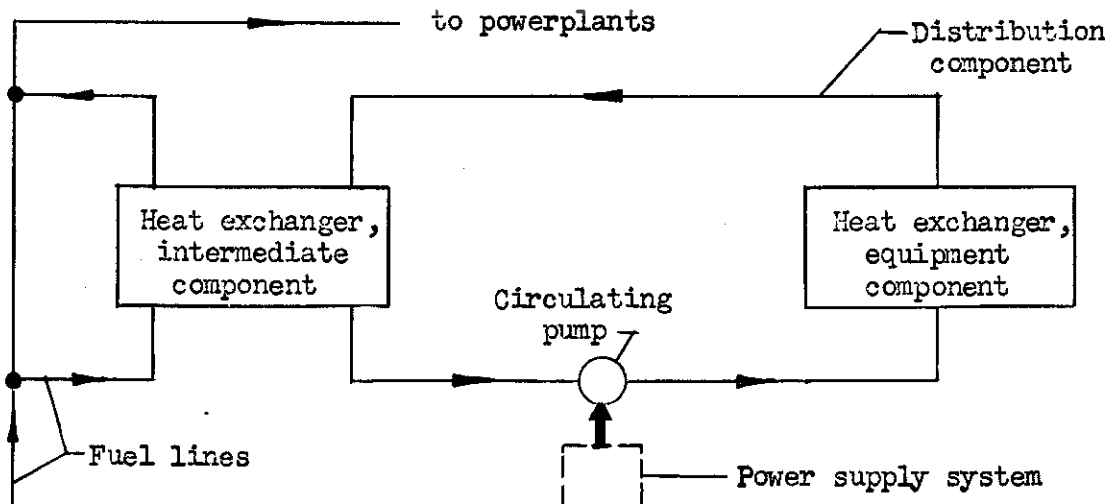

Figure I-11. Schematic arrangement of a fuel cooling system.

cooling system proper. A pump circulates a transfer fluid between the equipment and intermediate components; the transfer fluid being heated in the equipment component and cooled in the intermediate component by the fuel passing through the opposite side of the heat exchanger.

The principal advantage in using fuel as the ultimate fluid would be the relatively low penalty imposed on the aircraft by the cooling system, since weight and drag of the ultimate component is negligible. Furthermore, no air inlets or outlets would be required and, in general, operation and control of the cooling system should be relatively simple by providing the necessary fuel flow for cooling in a by-pass arrangement with one or several main fuel lines. Without change in phase, the fuel is capable of receiving heat at the rate of about 15 kilowatts for each  $100^{\circ}\text{F}$  temperature rise and for each 1000 pounds per hour of fuel flow. The available cooling capacity of the fuel is, typically, about 1.5% of the aircraft propulsive power at a flight Mach number of 0.9 for each  $100^{\circ}\text{F}$  temperature rise of the fuel; at Mach 1.5 the available cooling capacity for each  $100^{\circ}\text{F}$  temperature rise is on the order of 1% of the required propulsive power.

The primary disadvantage of fuel cooling systems for operation under conditions of thermal equilibrium is the relatively high temperature of the fuel in comparison with the desired temperature level of equipment items considered in this study. Since the equilibrium temperature of the fuel may be assumed equal to the adiabatic skin temperature, flight speed limitations on fuel cooling systems are essentially the same as for ram air cooling systems. Thus, for cooling equipment items in the temperature range of  $130^{\circ}$  to  $250^{\circ}\text{F}$  under steady-state thermal conditions, fuel cooling systems are restricted to use at relatively low flight speeds. The greatest availability of the fuel as an ultimate fluid would be for aircraft operation corresponding to the transient heating of the fuel system. Other factors such as the effect of an in-

crease in fuel temperature on the solubility of gases, fuel pumpability, volumetric expansion, fuel seals, etc., may introduce problems in the aircraft's fuel supply system. The general problem of increased fuel system vulnerability could also affect the use of fuel as an ultimate fluid for cooling systems.

## 6. Expendable Cooling Systems

Quite frequently relatively simple devices may be employed based on the acceptance of low efficiency or a low coefficient of utilization. In principle, a cooling system of this type would be one wherein the ultimate fluid is expended in absorbing heat rejected by equipment items. The use of expendable cooling systems appears more and more advantageous with increasing flight speeds because of (1) the rapidly increasing penalty with flight speed of other types of cooling systems and (2) the decreasing flight endurance of aircraft with increasing flight speed. Aircraft endurance for supersonic flight has been predicted to vary about in inverse proportion to the flight Mach number. Thus, a lower coefficient of utilization of the ultimate fluid can be justified with decreasing operational time, providing the weight and drag of the cooling system is minimized.

An expendable cooling system is defined as one wherein the ultimate fluid is carried within the aircraft, undergoes a change in phase during the process of absorbing heat to provide cooling of a thermal source and is, thereafter, expelled from the aircraft. Liquid-to-vapor phase change for the expendable fluid is considered in this study. A direct expendable system consists of the equipment and ultimate components, with the ultimate component consisting of storage and flow control equipment. The ultimate fluid in direct systems is delivered to the equipment heat exchanger, wherein boiling of the fluid occurs, and then is expelled from the aircraft. An indirect expendable system would have the intermediate and distribution components in addition to the ultimate and equipment component. Then, the expendable fluid would be evaporated on the ultimate side of the intermediate heat exchanger and a transfer fluid would be circulated in the distribution component between the equipment and intermediate components. A schematic arrangement of an indirect expendable cooling system is shown in Figure I-12.

The penalty imposed on an aircraft by an expendable cooling system is principally due to the weight of ultimate fluid required. For steady-state thermal conditions the weight of ultimate fluid required will be in direct proportion to the operating time of the cooling system, so that the "break-even" point of this system in comparison with other types of cooling systems can be evaluated in terms of operating time for the cooling system. The "break-even" time increases with increasing flight speeds because of the general increase in penalty for other types of cooling systems with flight speed. In general, expendable systems may be designed from conventional aircraft parts and would appear to be relatively simple in operation and control. The choice of expendable coolants is limited by required equipment temperatures which must be

# Contrails

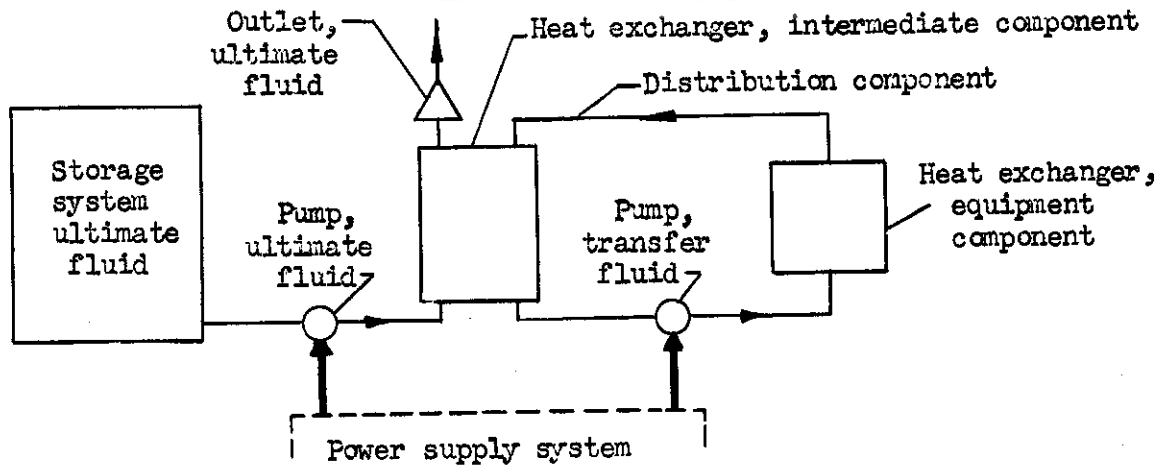

Figure I-12. Schematic arrangement of an indirect expendable cooling system.

above the boiling point of the coolant at the specified altitude of operation. Ground cooling is feasible. Widely dispersed equipment items can be cooled individually with less vulnerability than when central coolant storage is used. Loss of expendable coolant makes the system inoperative.

## 7. Vapor Cycle Cooling Systems

For the previously described cooling systems employing air as the ultimate fluid the system temperature potential is provided by limiting the aircraft flight speed or by creating an energy transfer by the use of turbines, compressors and heat exchangers to modify the thermal state of the air before serving as a thermal sink. In addition to any method by which the thermal state of the ultimate air is modified to provide a system temperature potential, there exists the general possibility of employing a heat pump while using air as the ultimate fluid in either a modified or unmodified thermal state. The purpose of employing a heat pump would be to lower the temperature level of the sink serving the equipment component or transfer fluid in a distribution component and to raise the temperature level of the source serving the ultimate fluid. Thus, the overall effective temperature potential of the system is increased. A cooling system of this type would be in direct contrast to the philosophy of expendable cooling systems, since by introducing a heat pump the temperature effectiveness, efficiency or coefficient of utilization is improved by sacrificing simplicity of the system. The ultimate component of the cooling system could be a ram air system, or an air system in which the thermal state of the ultimate air is modified prior to serving as a thermal sink for the heat pump. Fuel may also be used as the ultimate fluid in a vapor cycle cooling system. The heat pump serves as an intermediate component for the cooling system so that the system is of the indirect type regardless of whether or not the heat



pump is in the near vicinity of the equipment items being cooled.

Cooling systems employing a heat pump which are evaluated in this study use a vapor cycle refrigeration machine for the intermediate component and a ram air system as the ultimate component. The evaporator in the vapor cycle machine furnishes the low temperature sink for the transfer fluid serving the equipment component or components and the condenser of the vapor cycle machine provides a high temperature source for the ram air serving as the ultimate fluid. Shaft power for driving the compressor in the vapor cycle machine is provided by a power supply system; both electrical and pneumatic power supply systems are considered in the system study. A schematic arrangement of the system is shown in Figure I-13.

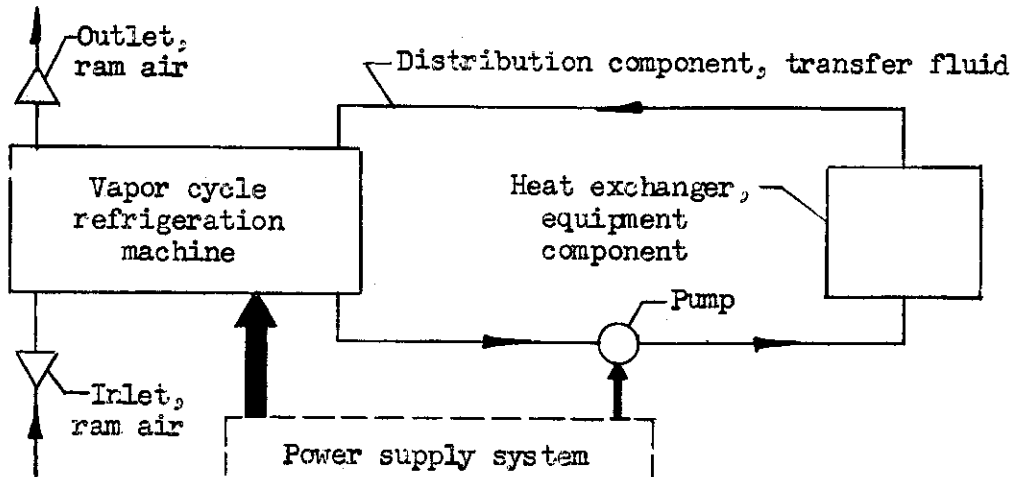

Figure I-13. Schematic arrangement of a vapor cycle cooling system.

The primary advantage of a cooling system employing a heat pump is its ability to provide cooling at high flight speeds. Theoretically, a cooling system of this type has no flight speed limitations. Practically speaking, it would be limited by its complexity, weight, power requirements and availability of suitable refrigerants, since with increasing flight speed it becomes desirable to increase the temperature differential created by the heat pump and/or to consider ultimate components capable of modifying the thermal state of the ultimate air. The desirability of employing cooling systems of increasing complexity and weight with increasing flight speeds must be considered subject to question when considering endurance variation with flight speed of present and near-future airplanes.

SUMMARY OF COOLING SYSTEM STUDY

Aircraft gross weight penalty and physical characteristics are summarized in the following for (1) ram air, (2) expanded ram-air, (3) bleed air, (4) blower, (5) fuel, (6) expendable and (7) vapor cycle cooling systems. Both direct and indirect systems have been evaluated. Direct systems employing a distribution component for the ultimate fluid have been evaluated for expendable systems only. Summary sections for each type of cooling system are presented, followed by a section comparing aircraft penalty of the various systems for direct and indirect types. All cooling system considerations apply to steady-state thermal conditions and equipment component surface temperatures in the range from 590° to 710°R.

Nomenclature

Symbol	Concept	Dimensions
d	diameter	feet
Dr	drag	pounds
e	effectiveness of heat exchange	dimensionless
kw	cooling capacity	kilowatts
L	length	feet
Lf	aircraft lift	pounds
M	Mach number	dimensionless
p	absolute pressure	pounds per square foot
S <sub>T</sub>	system temperature potential x 10 <sup>-2</sup>	°R
T	absolute temperature	°R
V	volume	cubic feet
W	weight	pounds
X	ratio of fuel weight to gross weight of aircraft at take-off	dimensionless
α	aircraft parameter defined as $(1-X) [\ln (1/1-X)] (L_f/Dr)$	dimensionless
τ	operating time	hours

Subscript	Refers to
air	air cooling system
D	distribution component
E	equipment component
g	gross weight of aircraft
i	internal
I	intermediate component
ref	reference value
s	surface of heat exchange
t	transfer fluid
T	temperature parameter
∞	free-stream atmospheric conditions

Superscript

Refers to

- " dimensions in inches
- o total or stagnation values

Ram Air Cooling Systems

Physical characteristics and aircraft gross weight penalty have been evaluated for direct and indirect ram air systems on the basis of design for minimum gross weight penalty with thrust recovery.

Minimum gross weight penalty of direct ram air systems occurs for flight conditions in the vicinity of 40,000 feet altitude and flight Mach numbers from about 0.75 to 0.95. Minimum values of the gross weight parameter  $\Delta W_g(1-X_{ref})(e_g)/kw$  are about 0.35, 0.60 and 1.0 for equipment component surface temperatures of 710°R, 650°R and 590°R, respectively. Typically, the gross weight parameter increases 3- to 5-fold by a decrease in the surface temperature from 710°R to 590°R. For a surface temperature of 650°R and 40,000 feet altitude, an increase in the flight Mach number from 0.9 to 1.5 increases the gross weight penalty roughly 4-fold. At a flight Mach number of 0.9, the gross weight penalty increases by 20 to 30% for an altitude increase from 40,000 to 60,000 feet. The gross weight parameter at Mach 0.9 is approximately doubled for an increase in the aircraft parameter  $\alpha$  from 2 to 6. Representative values of the gross weight parameter  $\Delta W_g(1-X_{ref})(e_g)/kw$  for direct systems are from about 0.5 to 3 pounds per kilowatt. The actual increase in aircraft gross weight varies, therefore, from about 1.0 to 10 pounds per kilowatt cooling capacity.

The gross weight penalty of indirect systems having a distribution component length of 200 feet is 2 to 3 times that for direct systems with thrust recovery having an effectiveness of 90%. The gross weight penalty of a direct system serving an equipment component having an effectiveness of 50% would be on the same order of magnitude as that for an indirect system having a distribution component length of 200 feet and serving equipment items so arranged that the overall effectiveness of the equipment component is about 90% or higher. From the standpoint of aircraft weight penalty, the use of an indirect system appears considerably superior to a number of direct systems. The gross weight parameter  $\Delta W_g(1-X_{ref})/kw$  increases on the order of 0.5 pounds per kilowatt for each additional 100 feet of distribution component beyond a length of about 50 feet. An indirect system appears capable of serving widely dispersed equipment items without significantly increasing the weight penalty of the cooling system. Typical values of the gross weight parameter  $\Delta W_g(1-X_{ref})/kw$  for indirect systems are in the general range of 1.5 to 5 pounds per kilowatt. The actual increase in aircraft gross weight would be, therefore, in the range of 2 to 12 pounds per kilowatt cooling capacity.

The gross weight penalty of an indirect system having a distribution component length of 200 feet, typically, is lower than the gross

weight penalty of one or several direct systems without thrust recovery.

Duct diameters in the ultimate component for direct and indirect systems range from about 2 to 6 inches for cooling capacities from 3 to 25 kilowatts and system temperature potentials in excess of  $40^{\circ}$  to  $50^{\circ}\text{F}$ . The volume of the intermediate heat exchanger for indirect systems is, most typically, in the range of 15 to 50 cubic inches per kilowatt. The optimum effectiveness of heat exchange on the transfer fluid side of the intermediate component is in the range of 40 to 60%. The optimum temperature rise of the ultimate air across the intermediate heat exchanger is on the order of 65% of the system temperature potential. Typical values of the circulation rate for the transfer fluid are in the range of 0.1 to 0.3 gpm for each kilowatt cooling capacity. Line diameters of the distribution component are, typically, in the range of 0.3 to 0.5 inch.

Ram air cooling systems appear to be well suited to cooling of equipment items in the temperature range of  $590^{\circ}$  to  $710^{\circ}\text{R}$  for the flight conditions of subsonic speed and altitudes from around 15,000 to 65,000 feet. Lower altitudes are practical for the higher surface temperatures. The system is operable at supersonic flight speeds when the altitudes are in excess of roughly 25,000 feet and the equipment component temperatures are relatively high. The maximum flight Mach number for which the system might be considered practical for steady-state cooling is around 1.5. Hence, it may be concluded that the system is essentially limited to subsonic aircraft for the conditions of equipment cooling covered in this study.

Practical limitations on the use of ram air cooling systems appear to be defined by (1) a minimum system temperature potential of around  $50^{\circ}\text{F}$ , (2) availability of space and (3) the necessity of ground cooling without the use of auxiliary equipment.

For aircraft operating on a cruise-dash-cruise basis, the indirect ram air system may represent a practical cooling system. Providing the supersonic dash is not for an extended period of time, cooling under dash conditions could possibly be handled by water injection into the ram air or an integrated expendable cooling system aided by the thermal capacity of the distribution component and transfer fluid. The indirect ram air system could furnish the necessary cooling during subsonic cruise with a minimum weight penalty imposed on the aircraft.

Additional investigation of indirect ram air cooling systems appears to be warranted for determining (1) off-design performance, (2) performance and control requirements during transient thermal conditions and (3) optimum design conditions for systems employed in aircraft operating on the cruise-dash-cruise basis.

## Expanded Ram-Air Cooling Systems

Physical characteristics and aircraft gross weight penalty have been evaluated for direct and indirect expanded ram-air systems on the basis of design for minimum gross weight penalty with thrust recovery.

Typical values of the gross weight parameter  $\Delta W_g(1-X_{ref})(e_g)/kw$  for direct systems are from about 2.5 to 15 pounds per kilowatt. Thus, the actual gross weight increase per kilowatt cooling capacity would be in the range of about 5 to 50 pounds. A decrease in the surface temperature of the equipment component from  $710^\circ$  to  $590^\circ R$  increases the gross weight penalty by a ratio of about 3 to 1. The gross weight penalty of direct systems at Mach 1.8 is about twice that at Mach 1.0. The gross weight parameter  $\Delta W_g(1-X_{ref})(e_g)/kw$  at Mach 1.8 and 40,000 feet is in the range of 3 to 7 pounds per kilowatt. Flight altitude produces major variations in the gross weight penalty. Minimum gross weight penalty occurs in the altitude range of from 15,000 to 40,000 feet. The gross weight penalty at 65,000 feet is on the order of 4- to 5-times the penalty at 40,000 feet. For altitudes above about 20,000 feet, flight Mach numbers up to 1.8 produce no major increase in the gross weight penalty. Operation of the system in the vicinity of sea level to 10,000 feet and at supersonic speeds is impossible or involves high weight penalty, except at the highest surface temperatures of the equipment component.

The gross weight penalty of indirect expanded ram-air systems is from 1.25- to 2-times greater than for direct systems, using an effectiveness of 90% for the equipment component as a basis of comparison. Around 40,000 feet altitude, the gross weight penalty of indirect systems is 1.35- to 1.5-times that for direct systems. Typical values of the gross weight parameter  $\Delta W_g(1-X_{ref})/kw$  for indirect systems are in the range of 4 to 15 pounds per kilowatt. The gross weight parameter increases by about 0.8 pounds per kilowatt for each 100 feet of distribution component length, beyond a length of about 50 feet.

Duct diameters in the ultimate component vary from around 1.0 to 10 inches; a typical duct diameter for a system capacity of 25 kilowatts is 3 inches. The volume of the intermediate heat exchanger for indirect systems is, typically, on the order of 25 to 80 cubic inches per kilowatt cooling capacity. The effectiveness of heat exchange on the ultimate side of the intermediate heat exchanger should be relatively high since the greatest portion of the weight penalty for indirect systems is due to the ultimate component. An effectiveness of 90% on the ultimate side has been used in this study. The effectiveness of heat exchange on the transfer fluid side of the intermediate component has optimum values for minimum gross weight penalty which are in the range of about 25 to 45%. The required circulation rate of the transfer fluid through the distribution component over the range of flight and system design conditions considered varies from around 0.1 to 0.6 gpm for each kilowatt of cooling capacity. Optimum values of the internal diameter for the distribution component are, typically, in the range of 0.2 to 0.6 inch.

# Contrails

Within the subsonic flight speed range, expanded ram-air systems appear to yield to ram air systems. Within the more significant portion of supersonic speeds covered in this study, Mach 1.5 to 1.8, the gross weight penalty of expanded ram-air systems is sometimes greater and never appreciably below that of bleed air cooling systems. The greatest advantage in weight penalty of the expanded ram-air system over other systems occurs in the Mach number range 1.0 to 1.5 and altitudes below about 45,000 feet. Thus, considering the generally contemplated problems of control of the turbine-compressor unit, the greatest single factor in establishing the use of expanded ram-air versus bleed air cooling systems probably will be the availability of bleed air.

Additional study of expanded ram-air systems appears warranted to determine (1) off-design performance and associated control problems, (2) the relative merits of direct systems having a distribution component versus indirect systems and (3) the performance and physical characteristics at flight Mach numbers greater than 1.8.

## Bleed Air Cooling Systems

The gross weight parameter  $\Delta W_g(1-X_{ref})(e_g)/kw$  of direct bleed air systems without a distribution component varies from around 2.5 to 15 pounds per kilowatt cooling capacity over the range of flight and design conditions considered in this study. The most typical range of values for the gross weight parameter of direct bleed air systems is 4 to 12 pounds per kilowatt. Flight conditions for lowest gross weight penalty are subsonic speeds and altitudes between 10,000 and 40,000 feet. Typical values of the gross weight parameter at Mach 0.9 are in the range of 4 to 8 pounds per kilowatt. At Mach 0.9 and  $\alpha$  equal to 2, the gross weight parameter  $\Delta W_g(1-X_{ref})(e_g)/kw$  has minimum values of 4, 5 and 6.4 pounds per kilowatt for equipment component surface temperatures of 710°, 650° and 590°R and altitudes of 20,000, 25,000 and 35,000 feet, respectively. The gross weight penalty at 60,000 feet is about 1.75-times that at 40,000 feet at Mach 0.9. At Mach 1.8,  $\alpha$  equal to 2 and 40,000 feet, the gross weight parameter for direct systems is 4.4, 5.4 and 7.3 pounds per kilowatt for equipment component surface temperatures of 710°, 650° and 590°R, respectively. At flight altitudes above 20,000 feet the gross weight penalty increases only slightly for an increase in the flight Mach number from 0.9 to 1.8. The aircraft parameter  $\alpha$  significantly affects the gross weight penalty of the system since an appreciable portion of the total penalty is due to equivalent drag of the bleed air-ram air flows. At Mach 1.8 and 40,000 feet, the gross weight penalty is about 35% greater for the system in an aircraft having a lift-to-drag ratio of 9 versus 6.

The gross weight penalty of indirect bleed air systems is, typically, about 10 to 50% greater than for direct systems. The increase in the gross weight parameter  $\Delta W_g(1-X_{ref})/kw$  due to the intermediate and distribution components is from about 1 to 4 pounds per kilowatt, for line lengths up to 300 feet.

# Contrails

Air extraction from the powerplant's compressor varies from about 40 to 200 pounds per kilowatt-hour. The volume of the precooling heat exchanger is in the range of 35 to 150 cubic inches per kilowatt cooling capacity. Duct diameters in the ultimate component vary, typically, from 1 to 6 inches, depending greatly upon the system's cooling capacity. Physical characteristics of the intermediate and distribution components are similar to those for the expanded ram-air system. The optimum effectiveness of heat exchange on the transfer fluid side of the intermediate component is around 30 to 40% for an effectiveness of 90% on the ultimate side.

For the cooling conditions investigated in this study, assuming bleed air for cooling purposes is available, and considering the developed state of this type of cooling system, bleed air systems for cooling at flight Mach numbers around 1.8 appear most favorable of the air systems investigated. The use of bleed air systems for cooling at Mach 1.8 to 2 appear to be in direct competition with expendable and vapor cycle cooling systems.

Additional investigation of bleed air cooling systems appears warranted to determine (1) off-design performance, (2) the relative merits of direct systems having a distribution component versus indirect systems and (3) the performance and physical characteristics at higher flight Mach numbers.

## Blower Cooling Systems

Blower cooling systems operating in ventilated compartments have greater gross weight penalty than ram air systems with thrust recovery over the range of flight conditions considered in this study. In general, the weight penalty of blower systems is somewhat lower than that for ram air systems without thrust recovery. The difference in penalty is relatively small for subsonic flight Mach numbers.

Blower cooling systems appear to have no distinct advantages over ram air systems, even when installed in ventilated compartments, unless there exists the need for spot cooling at locations remote to an aircraft cooling system, or when equipment items must be cooled in very-low-speed aircraft and ground cooling without the use of auxiliary equipment is important.

## Fuel Cooling Systems

For cooling under steady-state thermal conditions and equipment component surface temperatures in the range from 130° to 250°F, fuel cooling systems are essentially applicable only at subsonic flight speeds over the altitude range from sea level to 65,000 feet. Fuel cooling in the vicinity of Mach 1.5 appears practical from the cooling system's viewpoint, providing the altitude is in excess of about 30,000 feet and the surface temperature of the equipment component is 225° to 250°F, or higher. The gross weight penalty of indirect fuel cooling systems is

# Contrails

not significantly lower than that for indirect ram air systems.

A practical minimum value for the system temperature potential is about 60°F. The gross weight parameter  $\Delta W_g(1-X_{ref})/kw$  at this temperature potential varies from about 1 to 5 pounds per kilowatt, depending mostly upon the fuel side effectiveness of the intermediate component and the length of the distribution component. Values of the gross weight parameter of from 1.5 to 3 pounds per kilowatt appear most typical for flight conditions appropriate to the system.

Low effectiveness of heat exchange on the fuel side of the intermediate component minimizes the gross weight penalty of the cooling system but increases in inverse proportion the fuel flow to be by-passed through the intermediate heat exchanger. Reducing the fuel-side effectiveness from 90 to 50% lowers the gross weight penalty of the system by about one-third, but nearly doubles the required fuel flow rate to the intermediate heat exchanger.

The temperature rise of the fuel across the intermediate heat exchanger is, typically, from about 50° to 150°F. Fuel flow rates through the heat exchanger are, typically, in the range from 50 to 150 pounds per kilowatt-hour. Spatial requirement of the intermediate heat exchanger are in the range from 10 to 40 cubic inches per kilowatt. The capacity of fuel cooling systems varies appreciably with flight conditions. For Mach 0.9 at 40,000 feet and an average surface temperature of 650°R, the cooling potential is about 20 kilowatts per 1000 pounds net thrust. The circulation rate required of the transfer fluid in the distribution component is about from 2 to 4 gpm for each 10 kilowatts cooling capacity. The internal diameter of the distribution component line is, typically, in the range of 0.2 to 0.5 inch.

Fuel cooling systems for equipment cooling under steady-state thermal conditions of the equipment items and the aircraft's fuel and fuel system are applicable over a range of flight conditions similar to those for ram air systems. The gross weight penalty of fuel cooling systems is somewhat less, but on the same order of magnitude as that for indirect ram air systems. The use of fuel cooling systems for aircraft equipment cooling would appear to be defined by factors such as (1) the required cooling capacity versus the availability of fuel to a heat exchanger, (2) the general problem of the willingness or feasibility of using the fuel for additional cooling purposes and (3) the desirability of employing a fuel cooling system when a cooling system such as the indirect ram air system is independent of the aircraft's fuel system and has approximately the same aircraft gross weight penalty. The use of fuel for cooling purposes would appear to have its greatest potential during flight corresponding to the transient heating period of the fuel and its system.

Additional study of fuel cooling systems should be conducted to determine characteristics and performance of the system during (1) off-design operation and (2) the transient heating period of the fuel and its system.



## Expendable Cooling Systems

Physical characteristics and aircraft gross weight penalty have been evaluated for direct and indirect expendable cooling systems. Water, ammonia, methanol and a mixture of water and methanol having a freezing point of  $-65^{\circ}\text{F}$  have been considered as ultimate coolants. Indirect systems have been evaluated on the basis of minimum gross weight penalty of the basic system without expendable coolant, assuming use of a flooded evaporator. Direct systems with a distribution component have been evaluated assuming a pressurized coolant storage system and an equipment component consisting of forced-flow dry evaporators at individual equipment items. Coolant weight requirements are based on the fluid's change of heat content from a  $100^{\circ}\text{F}$ -liquid to a saturated vapor at altitude pressure.

Equipment component temperatures of  $590^{\circ}$  and  $650^{\circ}\text{R}$  limit the applicability of water systems to altitudes above about 50,000 and 18,000 feet, respectively. Methanol cannot cool equipment below  $620^{\circ}\text{R}$  at sea level. Ammonia has no altitude limitations for equipment between  $590^{\circ}$  and  $710^{\circ}\text{R}$ . The water-methanol mixture used in a forced-flow evaporator is limited to altitudes above 34,000 feet for  $590^{\circ}\text{R}$  equipment and cannot cool equipment below  $650^{\circ}\text{R}$  at sea level. Under conditions where all coolants meet the temperature requirements the relative weights of coolant required for water, the water-methanol mixture, ammonia and methanol are 1, 1.44, 2.17 and 2.10, based on a water weight of 3.29 pounds per kilowatt-hour. The use of ammonia in large systems is undesirable because of great coolant weight and volume. It requires storage space of about  $1/4$  cubic foot per kilowatt-hour which may be reduced with the use of methanol, the water-methanol mixture or water by approximately two-fifths, two-thirds and four-fifths, respectively.

For application in direct systems with distribution lines to dispersed equipment items water is not suitable because of its high freezing point. The water-methanol mixture is most desirable for this type of system. Its gross weight parameter  $\Delta W_g(1-X_{ref})/kw$  is about 30% smaller than for ammonia or methanol and would be for 1 hour operating time on the order of 5 pounds per kilowatt so that the actual aircraft gross weight increase may be from 9 to 15 pounds.

The base weight of indirect systems, representing the gross weight penalty parameter without ultimate component, is principally determined by system temperature potential for all coolants and transfer fluids. Typical values for  $20^{\circ}$ ,  $50^{\circ}$  and  $100^{\circ}\text{F}$  temperature potential, equipment component and transfer-fluid-side evaporator heat exchange effectivenesses of 90% each, 25 kilowatt cooling capacity and 100 feet line length are 4.2, 1.4 and 0.8 pounds per kilowatt, respectively. They are reduced by 0.2 to 0.4 pound when the cooling capacity is increased to 75 kilowatts. They increase by roughly one-half for twice the line length and one-third for one and one-half times the line length. Transfer fluid flow rates are large at small system temperature potential and reach about 1 gallon per minute-kilowatt for a temperature potential of  $1^{\circ}\text{F}$

# Contrails

per kilowatt. They are reduced 20% by a 3-fold increase of line length. Internal line diameters are relatively large for water systems and vary from 1/2 to 1 inch. Typical ammonia system transfer line diameters are near 1/4 inch. The distribution line length is a major factor in determining the gross weight penalty of systems operating with temperature potentials of less than 50°F. For a typical value of the gross weight parameter of 6 pounds per kilowatt the available operating time of an indirect water system may be reduced by one-half when the line length is increased from 100 to 300 feet. The desirability of most central location for the intermediate component is indicated and should be attainable because of the system's independence from connection to the flight atmosphere or component parts of the aircraft.

Indirect water systems have lower penalty than indirect ammonia systems at 710°R equipment temperature over practically the entire altitude range, except for very short operating times; also at 650°R at altitudes above 20,000 feet in general, and at higher altitudes for operating times less than 1/2 hour. For 590°R equipment ammonia would be used even above 50,000 feet altitude with gross weight parameters of about 10 pounds per kilowatt for 1 hour operating time. In the mentioned ranges of applicability of the indirect water system the gross weight parameter  $\Delta W_g(1-X_{ref})/kw$  is generally smaller than 10 pounds per kilowatt for 2 hours operating time.

A typical volume for a water heat exchanger in the best range of application would be 10 to 20 cubic inches per kilowatt. Ammonia heat exchanger volumes would be about 2 cubic inches per kilowatt. Under break-even conditions, in respect to total gross weight penalty, between indirect water and ammonia systems at operating times of 1/2, 1 and 2 hours, water heat exchanger volumes would be relatively large, i.e., 15, 30 and 60 cubic inches per kilowatt, respectively. However, under all design conditions the combined volume of evaporator and coolant storage system would be 3 times greater for ammonia.

The feasibility of using a direct system with a distribution component and the water-methanol mixture as expendable coolant limits the desirable range for use of an indirect water system for 710°R-equipment to operating times greater than 1/2 and 1-3/4 hours for 65,000 feet altitude and sea level, respectively, and for 650°R-equipment to operating times greater than 1 hour at altitudes above 30,000 feet. For 590°R equipment, the water-methanol direct system is superior under all practical conditions but yields to an ammonia system, probably of the indirect type, at altitudes below 34,000 feet unless a direct methanol system with distribution lines is considered acceptable from the safety standpoint, in which case it would be preferable between 34,000 and 17,000 feet altitude.

In respect to gross weight penalty, expendable systems appear to be competitive with other cooling systems principally for supersonic flight conditions at all altitudes and equipment component temperatures for flight durations less than 1-1/2 hours. At the low equipment temper-

ature of  $590^{\circ}\text{R}$ , 40,000 feet altitude and in the Mach number range from 1.5 to 1.8, expendable systems would be superior to other systems for operating times shorter than 2 hours. At altitudes above 50,000 feet expendable systems may impose less penalty for operating times up to 2-1/2 hours. Under such conditions spatial requirements are small. For low-altitude low-equipment temperature application the large storage volume required for ammonia may reduce the system's usefulness to flight times shorter than indicated from the penalty standpoint. For cruise-dash-cruise flight plans the integration of an indirect expendable cooling system into the distribution system of another system applicable to cruise conditions appears simple and offers the merit of low penalty.

Additional studies of expendable cooling systems should be concerned with (1) transient thermal conditions, (2) optimization of insulation of storage containers for coolant supplied at ground level temperature, or refrigerated to an optimum minimum temperature, and (3) optimization of integration with ram air systems for cruise-dash-cruise applications.

## Vapor Cycle Refrigeration Systems

Physical characteristics and aircraft gross weight penalty of indirect simple ram air systems with vapor cycle refrigeration intermediate components and distribution components utilizing a liquid transfer fluid have been evaluated for supersonic flight speeds. Study of cycle characteristics resulting from the use of various commercial refrigerants have indicated Freon-11 to require least compressor power, for both simple and regenerative cycles operating in the range of evaporator and condenser temperatures of significance in the study. For condenser temperatures over  $300^{\circ}\text{F}$ , the critical temperature of the refrigerant is approached and under such conditions a refrigerant of higher critical temperature, if available, would reduce power requirements. Freon-11 is assumed as refrigerant in the analysis of cooling systems using a high-speed centrifugal compressor either with electric or pneumatic drive. The systems are evaluated on the basis of thrust recovery of the ultimate cooling air and minimum gross weight penalty which includes the optimization of transfer fluid line diameter and flow rate, evaporator effectiveness, evaporator and condenser temperatures, ram air flow rate and condenser effectiveness and pressure drop. Cooling of the electric drive motor, when used, by means of the vapor cycle component is assumed. Optimum condenser temperatures for a range in the difference of total ram air temperature minus equipment component temperature from  $-25^{\circ}$  to  $+100^{\circ}\text{F}$  are, on the average,  $60^{\circ}$  to  $45^{\circ}\text{F}$  greater than the ram air temperature. The coefficient of performance of the vapor cycle is three when the ram air-equipment temperature difference is zero, and is reduced to one when  $170^{\circ}\text{F}$  temperature difference which corresponds roughly to  $590^{\circ}\text{R}$ -equipment operation at 40,000 feet altitude and Mach 1.8.

The gross weight penalty is principally determined by the overall temperature potential, defined as the difference of ram air minus equipment temperature, and decreases, at constant temperature potential, 20

to 25% between 55,000 feet altitude and sea level. Values of the gross weight penalty parameter  $\Delta W_g(1-X_{ref})/kw$  are maximum at the greatest ram air temperature occurring at 35,000 feet altitude and Mach 1.8, where, for 100 feet distribution line length and a value of the aircraft parameter  $\alpha$  of 2, and equipment temperatures of 590°, 650° and 710°R the penalty parameter is 8.6, 12.3 and 22 pounds per kilowatt, respectively, for the electric-drive system and 6.2, 9 and 16, respectively, or 27% smaller, for the pneumatic-drive system. Reducing the flight speed at constant altitude from 1.8 to 1.4 approximately halves the penalty. In the probable range of best application of the system the actual increase in aircraft gross weight would be in the range from 6 to 30 pounds per kilowatt.

On the order of 50% of the gross weight penalty may be caused by the compressor power supply system by virtue of its dead weight and the requirement for fuel flow increase to the powerplant it imposes because of shaft power extraction or air bleed. For electric-drive systems which have large dead weight, increasing the aircraft parameter  $\alpha$  from 2 to 3 would increase the penalty about 10%. For pneumatic-drive systems which have smaller dead weight but more drag due to air bleed, increasing  $\alpha$  from 2 to 3 would increase the penalty 20 to 25%.

The penalty parameter increases 0.9 to 1.8 pounds per kilowatt per 100 feet of distribution line length and is reduced by about 0.02 per kilowatt increase over 25 kilowatt cooling capacity. Smaller systems would require the use of positive displacement compressors because the indicated small dimensions and extremely high operating speeds of centrifugal compressors would be impractical.

Increase of heat dissipation to the ram air by the compressor power input tends to impose large air rate requirements which are held reasonable by design of condensers with 80% effectiveness. Design for a duct Mach number of 0.3 yields air ducts from 4 to 11 inches in diameter for 25 kilowatt system cooling capacity, varying with the square root of the capacity. Design of systems in the 75- to 100-kw capacity range should be based on very short high-velocity air in direct systems in order to yield practical duct sizes. Optimum evaporator effectivenesses vary from 70 to 82% for distribution systems 100 to 300 feet long. Combined volume of evaporator and condenser is in the range from 1/2 to 3/2 cubic foot per 25 kilowatt cooling capacity of electric-drive systems and is up to 20% smaller for pneumatic-drive systems. Bleed air rates for pneumatic compressor drive may range from 10 to 60 pounds per hour per kilowatt and may produce additional cooling capacity, however at increased bleed air rate, if a ram-air precooler is used, i.e., the vapor cycle compressor would be used as a loading device of the expansion turbine of a bleed air system.

Transfer fluid flow rates for large system temperature potentials are high and approach 1 gallon per minute per kilowatt, but are most typically half of this value. Distribution line diameters range from 1/2 to 1 inch with 25 kilowatt cooling capacity.

Under conditions of maximum difference between ram air and equipment temperature, e.g., 590°R equipment at Mach 1.8 and 40,000 feet altitude, use of the regenerative cycle employing appreciable subcooling of the liquid refrigerant by superheating the vapor before compression, will result in decrease of the total system penalty by 10 to 15% if the regenerator's vapor-side effectiveness is 50 to 60%. The regenerator would add 20 to 30% to the system volume. The relatively small percentage of penalty reduction would be very significant in this high-penalty range and should make the total penalty smaller than for any comparable cooling system.

Electric-drive vapor cycle systems appear to be too heavy to merit serious consideration in comparison to other types of cooling systems. Pneumatic-drive vapor cycle systems appear to be very competitive for supersonic flight speeds, particularly at altitudes above 40,000 feet and near sea level. Regenerative systems with optimized regenerator effectivenesses would probably yield systems imposing over the entire supersonic flight range less penalty than any other system for equipment temperatures of 590°R. A potential means of reducing the penalty of vapor cycle systems by an additional 10 to 15%, probably at the expense of some vulnerability, would be the use of the refrigerant in a distribution component and the elimination of the transfer fluid. For applications at flight speeds near Mach 1.8 a need for a refrigerant more suitable than Freon-11 exists.

Vapor cycle refrigeration systems have the same practical limitations as ram air systems which constitute their ultimate component, except that the total ram air temperature can be 150° to 200°F higher than the equipment temperature. Application of electric drive is limited by available or practically feasible generator capacity, pneumatic drive is limited by availability of a high-pressure air source.

Additional investigations in reference to the application of vapor cycle refrigeration components in aircraft equipment cooling systems should be concerned, in addition to component development problems, with (1) search for or development of a refrigerant exhibiting a higher coefficient of performance than Freon-11 when operating with evaporator temperatures from 100° to 200°F and condenser temperatures from 200° to 350°F, (2) more complete study of optimized regenerative systems, (3) off-design performance and control problems, (4) evaluation of effects on system penalty and physical characteristics resulting from the use of the refrigerant in a distribution system serving dispersed equipment items equipped with individual expansion valves and either external evaporators or with evaporation taking place at internal component surfaces, (5) study of optimized combined bleed air and vapor cycle cooling systems, using the refrigerant compressor as load on the bleed air expansion turbine, and (6) study of optimized expanded ram-air and vapor cycle cooling systems, using the refrigeration compressor as load on the ram-air turbine.

## Comparison of Aircraft Penalty of Cooling Systems

The following comparisons of the various types of aircraft cooling systems considered in this study are based principally on aircraft gross weight penalty; a few comparisons are made on the basis of system volume. The relative reliability, vulnerability, off-design performance characteristics, flexibility in location within an aircraft, etc. of the various systems are not presented. Gross weight penalty of a cooling system is defined on the basis of the required increase in aircraft gross weight at take-off when a cooling system is added to an aircraft, in order to allow the same range and payload as the same aircraft has without a cooling system. The comparisons are presented on the basis of (1) steady state thermal conditions of the equipment items being cooled, the cooling system and the aircraft in general, (2) equipment component surface temperatures in the range of 130° to 250°F, (3) altitudes to 65,000 feet, (4) flight Mach numbers to 1.8 and (5) direct and indirect cooling systems. Direct systems employing a distribution component for the ultimate fluid to serve widely dispersed equipment items have been considered in this study for expendable systems only.

Comparisons of direct cooling systems are presented in the following for (1) ram air, (2) expanded ram-air, (3) bleed air, (4) blower and (5) expendable types of systems. Indirect cooling systems compared are (1) ram air, (2) expanded ram-air, (3) bleed air, (4) fuel, (5) expendable and (6) vapor cycle refrigeration.

### 1. Direct Cooling Systems

The flight conditions corresponding to equal gross weight penalty for ram air (R) versus expanded ram-air (E) and ram air (R) versus bleed air (B) direct cooling systems are presented in Figures II-1 and II-2. For flight conditions to the right of the equal-penalty break-even lines, the gross weight penalty of ram air systems is greater than for the other systems. Also presented are values of the gross weight parameter corresponding to the "break-even" flight conditions and the equivalent operating time of direct expendable systems employing water as the ultimate fluid. The data in Figure II-1 are for equipment component surface temperatures of 590°, 650° and 710°R and the aircraft parameter  $\alpha$  equal to 2. A value of  $\alpha$  equal to 2 corresponds to aircraft lift-to-drag ratios in the range of about 5 to 8 for a representative range of values of the ratio of fuel weight to gross weight at take-off for various types of aircraft. The most representative value of the lift-to-drag ratio corresponding to  $\alpha$  equal to 2, probably, would be 6. For  $\alpha$  equal to 4 the most representative lift-to-drag ratio would be, therefore, about 12. Design conditions for the three types of cooling systems considered in Figures II-1 and II-2 are taken as the average of the ranges of all independent variables of design considered in the individual system evaluations presented in Sections VIII, IX and X. The gross weight parameter for direct systems  $\Delta W_g(1-X_{ref})(eg)/kw$  employed in these comparisons may be used to define the aircraft gross weight increase per kilowatt cooling capacity by selection of numerical values for the equipment component

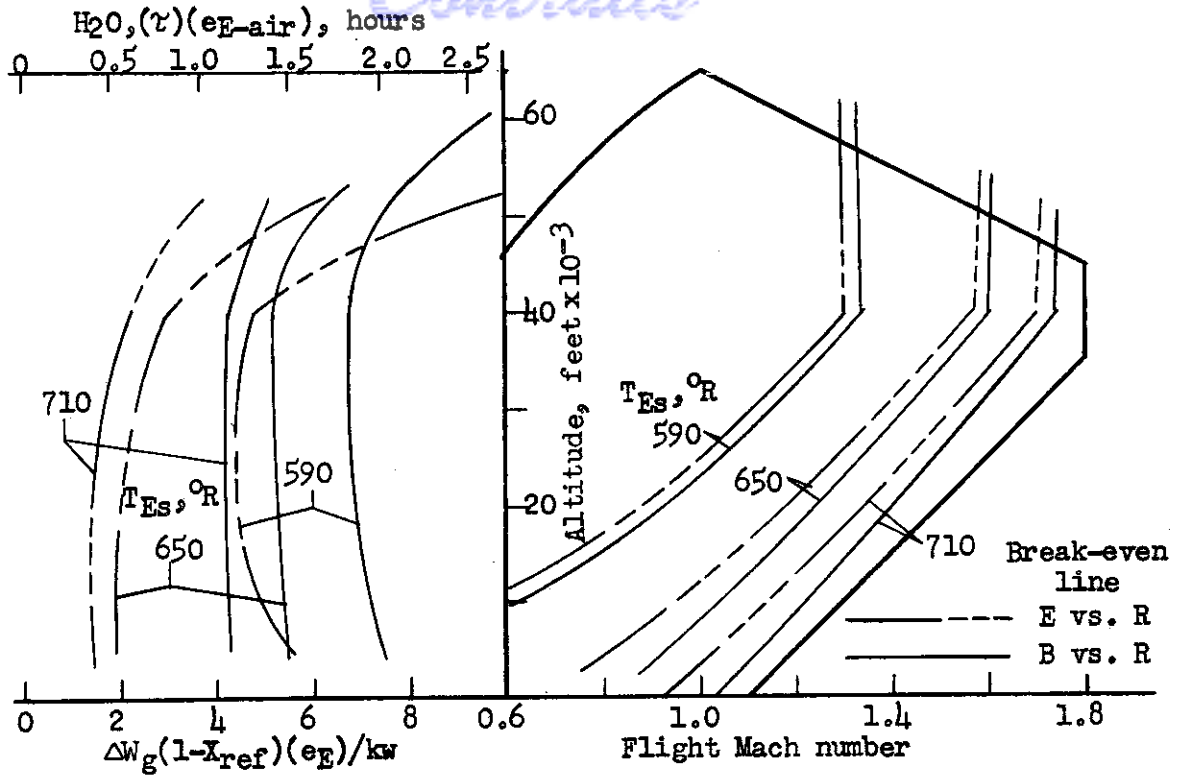

Figure II-1. Break-even gross weight penalties and flight conditions for direct ram air (R), expanded ram-air (E) and bleed air (B) systems.  $\alpha = 2$ .

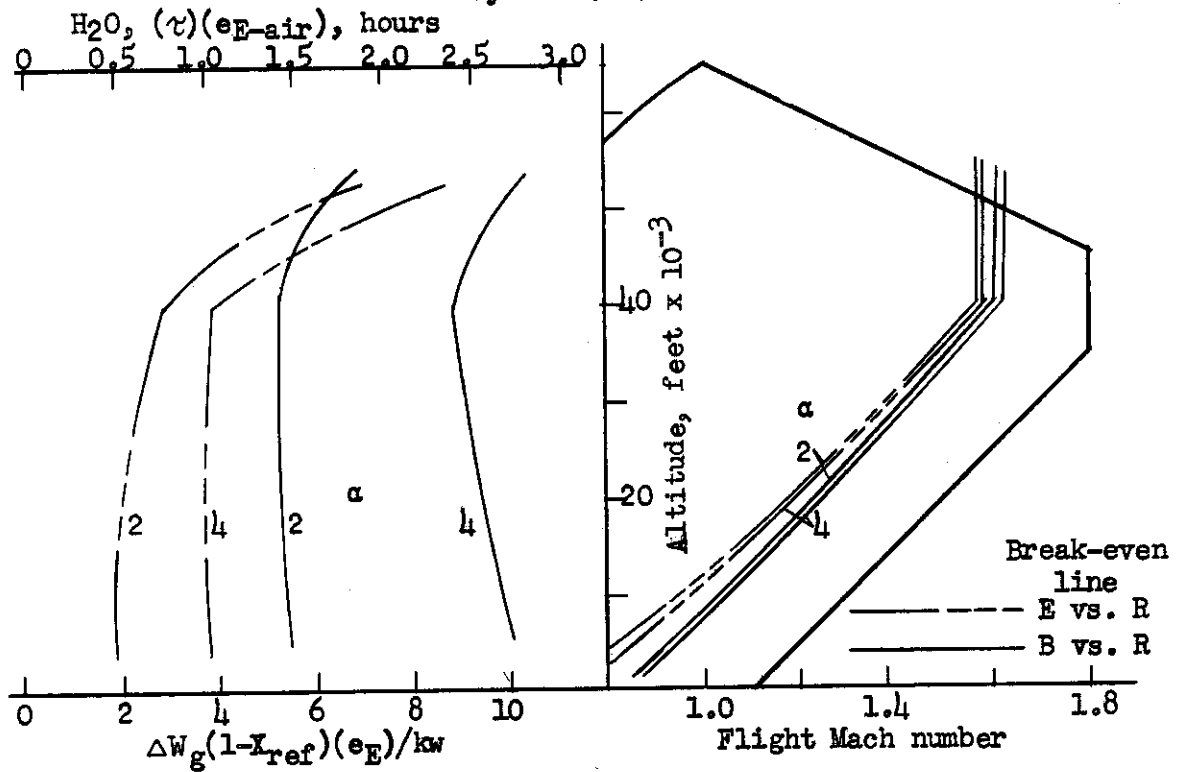

Figure II-2. Break-even gross weight penalties and flight conditions for direct ram air (R), expanded ram-air (E) and bleed air (B) systems.  $T_{Es} = 650^{\circ}R$ .

effectiveness  $e_p$  and the aircraft's fuel weight to gross weight ratio  $X_{ref}$ . The equivalent operating time for direct expendable systems employing water is obtained by dividing the value of the parameter  $(\tau)(e_{p-air})$  by the value of the effectiveness of the equipment component for the air system being compared.

The break-even flight conditions for ram air versus expanded ram air cooling systems over the equipment component temperature range of  $590^{\circ}$  to  $710^{\circ}R$  corresponds to a system temperature potential for the ram air system of from  $25^{\circ}$  to  $50^{\circ}F$ . The corresponding temperature potential of ram air systems in comparison with bleed air systems is from about  $20^{\circ}$  to  $40^{\circ}F$ . At these low temperature potentials of ram air systems, minor variations in the temperature potential produce significant changes in the gross weight penalty of ram air systems. Thus, when considering design conditions other than those employed in this study, the general flight regions corresponding to the break-even point may be considered more significant than the absolute value of the gross weight penalty. The flight conditions for break-even of ram air versus expanded ram-air are approximately the same as for ram air versus bleed air systems. At the lowest equipment temperature of  $590^{\circ}R$ , the weight penalty of expanded ram-air and bleed air systems is less than that for ram air systems over a significant portion of the flight conditions considered. At the highest temperature of  $710^{\circ}R$ , the weight penalty of ram air systems is lower than that for the expanded ram-air and bleed air systems throughout most of the flight range under consideration. The value of the parameter  $\alpha$  produces no significant change in the break-even flight conditions, but does significantly alter the break-even gross weight penalty.

The break-even gross weight penalty for ram air versus expanded ram-air systems at surface temperatures around  $650^{\circ}$  to  $710^{\circ}R$  corresponds to  $(\tau)(e_{p-air})$  for expendable water systems of about 0.5 to 1.5 hours. Thus, for an effectiveness of the equipment component equal to 75% in the ram air and expanded ram-air systems, the equivalent operating time of an expendable water system would be about in the range of 0.75 to 2 hours. The corresponding equivalent operating time for a surface temperature of  $590^{\circ}R$  is in the range of 1.5 to 3 hours. For bleed air versus ram air systems at surface temperatures of  $650^{\circ}$  to  $710^{\circ}R$ , the parameter  $(\tau)(e_{p-air})$  is on the order of 1.25 to 1.5 hours. Hence, with  $e_{p-air}$  equal to 75%, the equivalent operating time for an expendable water system is around 1.5 to 2 hours. The parameter  $(\tau)(e_{p-air})$  is equal to about 2 hours at the break-even conditions of ram air versus bleed air for a surface temperature of  $590^{\circ}R$ . An increase in  $\alpha$  from 2 to 4 at the average surface temperature of  $650^{\circ}R$  roughly doubles the equivalent operating time at the break-even conditions for ram-air versus bleed air systems; the corresponding increase in equivalent operating time for ram air versus expanded ram-air systems is by a ratio in the range of 4 to 3 to 2 to 1.

As discussed in Section XIII, direct expendable water systems are limited in application to altitudes above 50,000 and 18,000 feet for



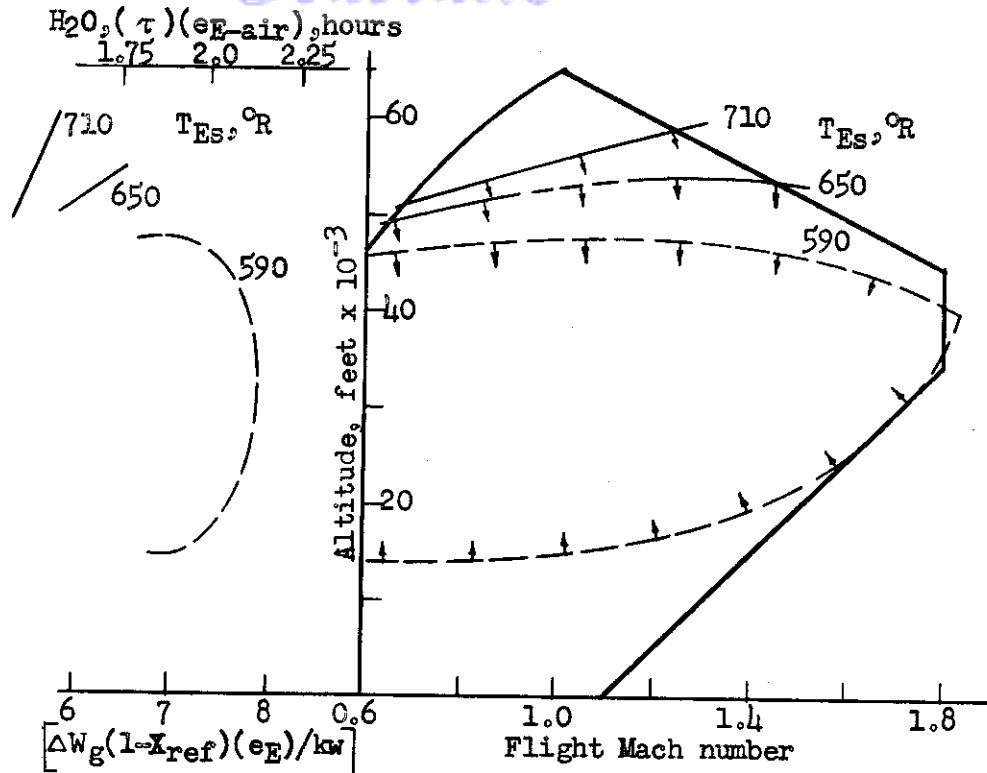

Figure II-3. Break-even gross weight penalties and flight conditions for direct expanded ram-air versus direct bleed air systems.  $\alpha = 2$ .

equipment temperatures of  $590^{\circ}$  and  $650^{\circ}\text{R}$ , respectively. Below these altitudes, an expendable ammonia or methanol would have to be used for which the parameter  $(\tau)(e_{E\text{-air}})$  indicated for an expendable water system would have to be divided by a factor equal to 2.15.

Flight conditions for equal penalty of expanded ram-air and bleed air direct cooling systems are shown in Figure II-3 for surface temperatures of  $590^{\circ}$ ,  $650^{\circ}$  and  $710^{\circ}\text{R}$  with the parameter  $\alpha$  equal to 2. The gross weight penalty of the expanded ram-air system is lower than that for the bleed air system inside of the break-even line. With surface temperatures of  $650^{\circ}$  to  $710^{\circ}\text{R}$ , the weight penalty of bleed air systems is lower only at altitudes above 50,000 to 60,000 feet over the range of flight conditions considered in this study. At Mach 0.9 and surface temperatures around  $650^{\circ}$  to  $710^{\circ}\text{R}$ , the break-even altitudes are in the range of 50,000 to 55,000 feet. The bleed air system has lower weight penalty at both high and low altitudes for the lower surface temperature of  $590^{\circ}\text{R}$ . Surface temperatures below  $590^{\circ}\text{R}$  would result in the bleed air system having lower weight penalty over the entire range of flight conditions. The weight penalties corresponding to the break-even conditions are shown on the left in Figure II-3. The parameter  $(\tau)(e_{E\text{-air}})$  is equal to from about 1.5 to 2, so that the equivalent operating time of a direct expendable water system is at least on the order of 2 hours.

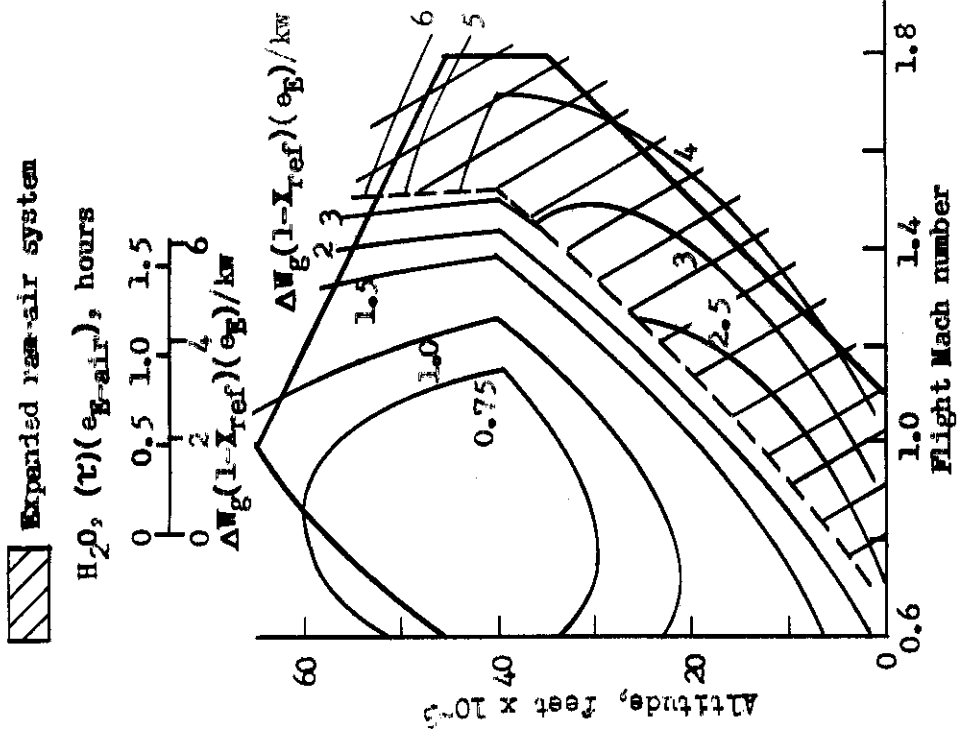

Figure II-4. Gross weight penalty of direct ram air versus direct expanded ram-air systems.  $T_{TS}=650^{\circ}R$ ,  $\alpha=4$ .

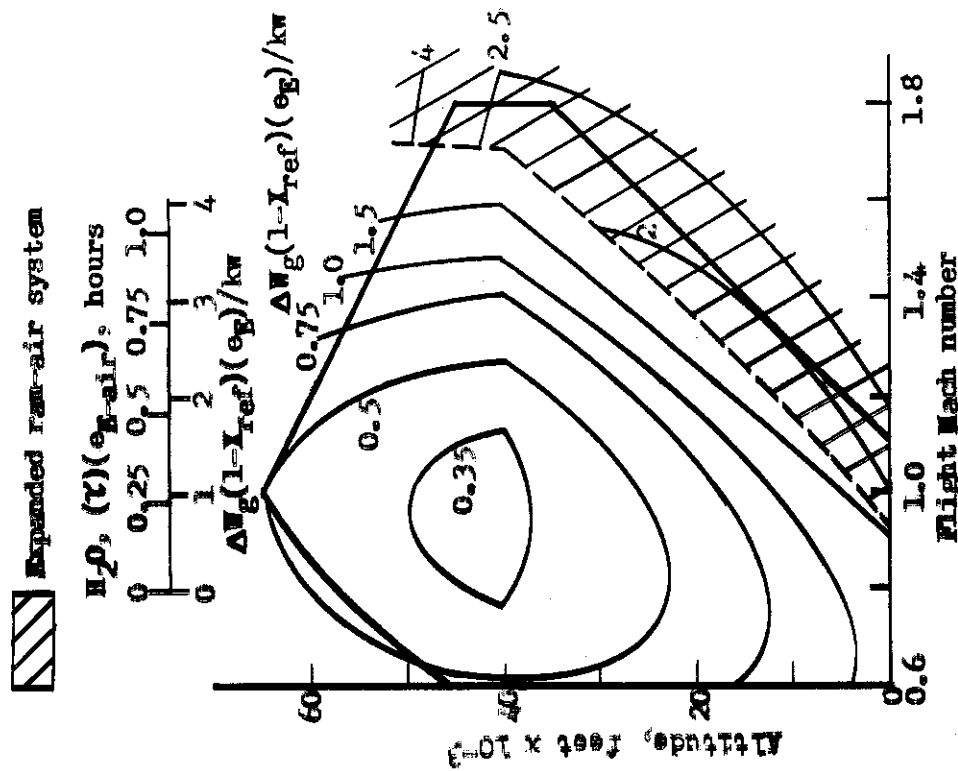

Figure II-5. Gross weight penalty of direct ram air versus direct expanded ram-air systems.  $T_{TS}=710^{\circ}R$ ,  $\alpha=4$ .

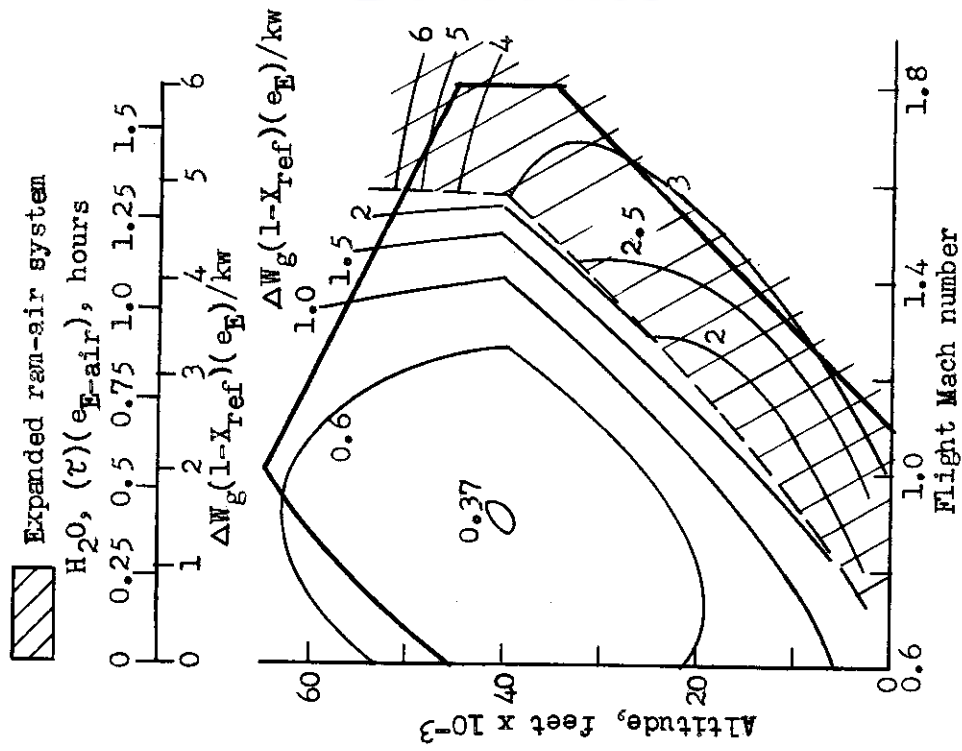

Figure II-7. Gross weight penalty of direct ram air versus direct expanded ram-air systems.  $T_{Es}=650^{\circ}R$ .  $\alpha=2$ .

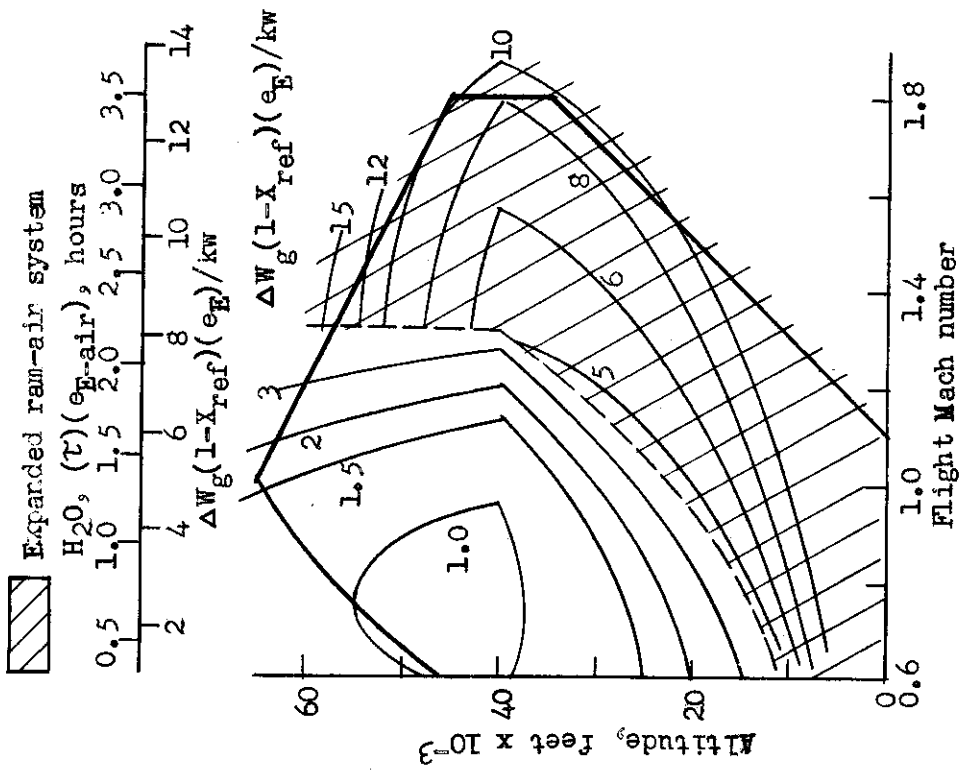

Figure II-6. Gross weight penalty of direct ram air versus direct expanded ram-air systems.  $T_{Es}=590^{\circ}R$ .  $\alpha=4$ .

# Contrails

Comparisons of the gross weight penalty of ram air and expanded ram-air cooling systems are shown in Figures II-4 through II-7. Figures II-4, II-5 and II-6 are for the parameter  $\alpha$  equal to 4 and equipment component surface temperatures of  $710^{\circ}$ ,  $650^{\circ}$  and  $590^{\circ}$ R, respectively. The comparison shown in Figure II-7 is for  $\alpha$  of 2 and an average surface temperature of  $650^{\circ}$ R. The heavy solid line denotes the range of flight conditions considered in this study. The dotted line is the break-even or equal-penalty line for the two systems and the cross-hatched area denotes the flight conditions for which the gross weight penalty of the expanded ram-air system is less than that of the ram air system. Thus, weight penalties inside the dotted line are for ram air systems. Lines of constant gross weight penalty are shown in terms of the gross weight parameter for direct systems  $\Delta W_g(1-X_{ref})(e_E)/kw$ , pounds per kilowatt. For a surface temperature of  $710^{\circ}$ R and  $\alpha$  equal to 4, Figure II-4, the gross weight penalty is relatively low for most of the flight conditions considered. Below Mach 1.5, the parameter  $(\tau)(e_{E-air})$  never exceeds roughly 0.5 hour, so that the equivalent operating time of the direct expendable water system would in most instances be less than 1 hour. The gross weight penalty of the expanded ram-air system for  $710^{\circ}$ R surface temperature is about 8-times that of the ram air system at flight conditions around Mach 0.9 to 1 and altitudes in the vicinity of 40,000 feet. At a surface temperature of  $650^{\circ}$ R and  $\alpha$  equal to 4, the weight penalty of the expanded ram-air system is lower than that for ram air systems over roughly one-third of the flight range considered. The parameter  $(\tau)(e_{E-air})$  for direct expendable systems using water varies from around 0.2 to 1.0 hour for the ram air system range and from around 0.6 to 1.5 hours for the range associated with the expanded ram-air system. At the lowest surface temperature of  $590^{\circ}$ R and  $\alpha$  equal to 4, Figure II-6, the expanded ram-air system has weight penalties lower than the ram air system for about one-half of the flight range considered. The gross weight penalties for the systems are considerably higher than at surface temperatures of  $650^{\circ}$  and  $710^{\circ}$ R. At the flight condition of minimum penalty for the ram air system and  $590^{\circ}$ R surface temperature, the weight penalty for the expanded ram-air system is greater by a ratio of about 5 to 1. The parameter  $(\tau)(e_{E-air})$  for expendable water systems corresponding to the conditions of Figure II-6 varies from around 0.25 to over 3 hours. Comparison of Figures II-5 and II-7 illustrates the effect of a change in the parameter  $\alpha$  from 4 to 2. Gross weight penalties are lower for  $\alpha$  of 2, but the range of flight conditions for which the weight penalty of ram air systems is lower than that for expanded ram-air systems is about the same as for  $\alpha$  of 4.

The gross weight penalties of bleed air and ram air systems are compared in Figures II-8 through II-11. Figures II-8, II-9 and II-10 are for equipment component surface temperatures of  $710^{\circ}$ ,  $650^{\circ}$  and  $590^{\circ}$ R, respectively, with the parameter  $\alpha$  equal to 4. Figure II-11 presents a similar comparison for an average surface temperature of  $650^{\circ}$ R and the parameter  $\alpha$  equal to 2. The dotted line in these plots defines the break-even penalty line for ram air versus bleed air systems. The cross-hatched area corresponds to bleed air systems of smaller penalty, with the area on the opposite side of the dotted line corresponding to ram

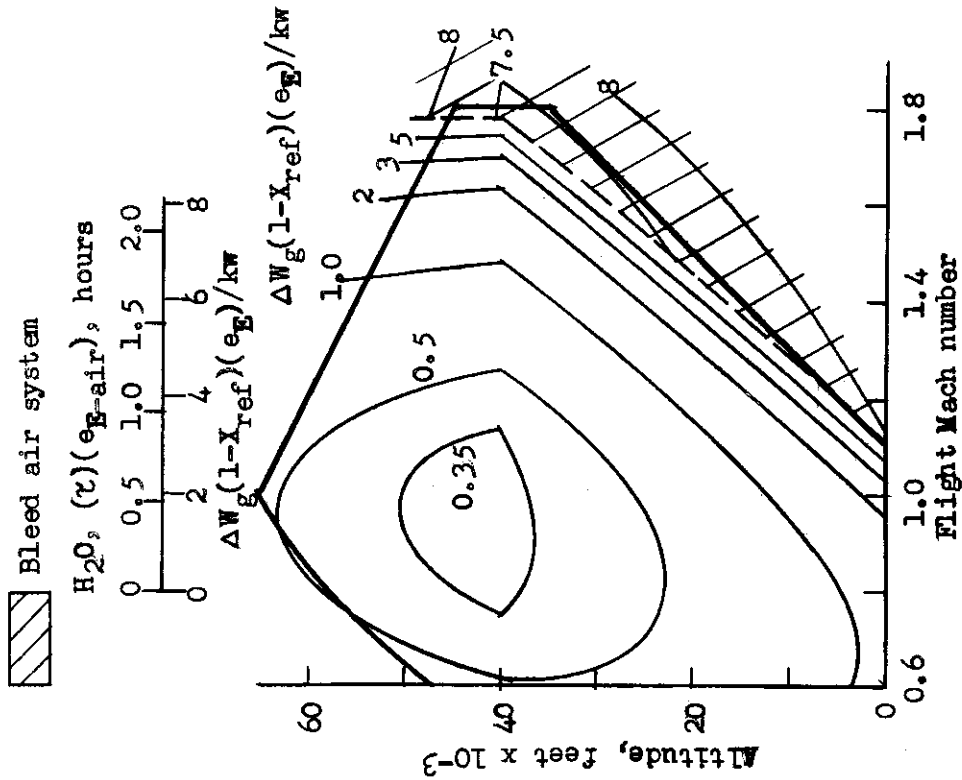

Figure II-8. Gross weight penalty of direct ram air versus direct bleed air systems.  $T_{Es}=710^{\circ}R$ .  $\alpha=4$ .

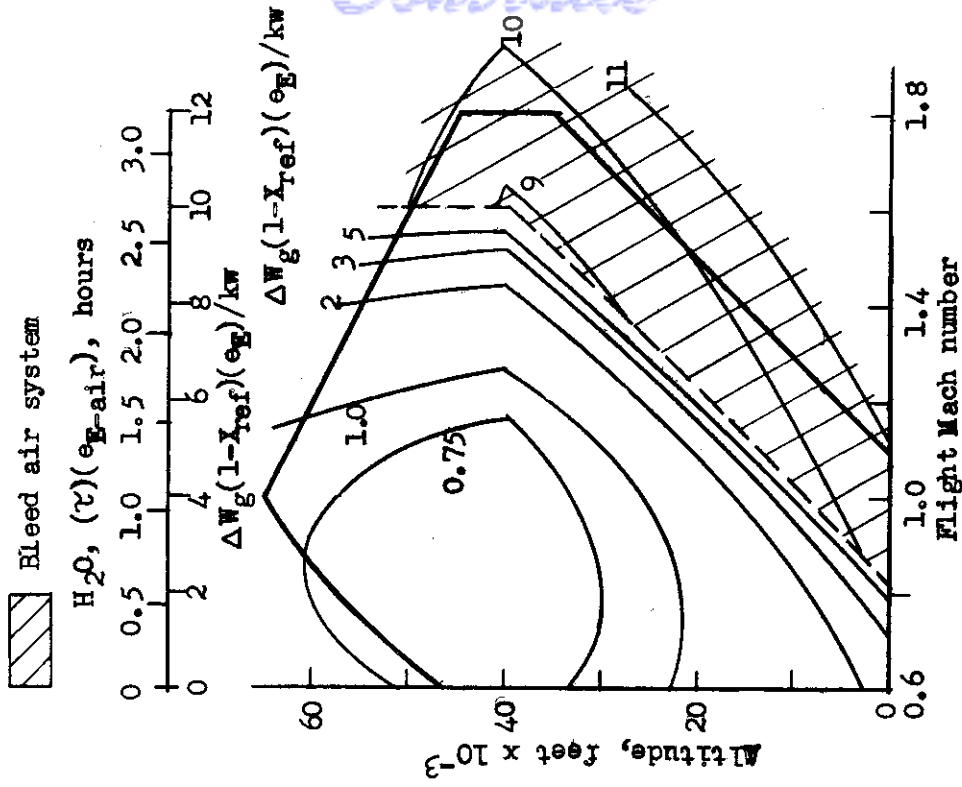

Figure II-9. Gross weight penalty of direct ram air versus direct bleed air systems.  $T_{Es}=650^{\circ}R$ .  $\alpha=4$ .

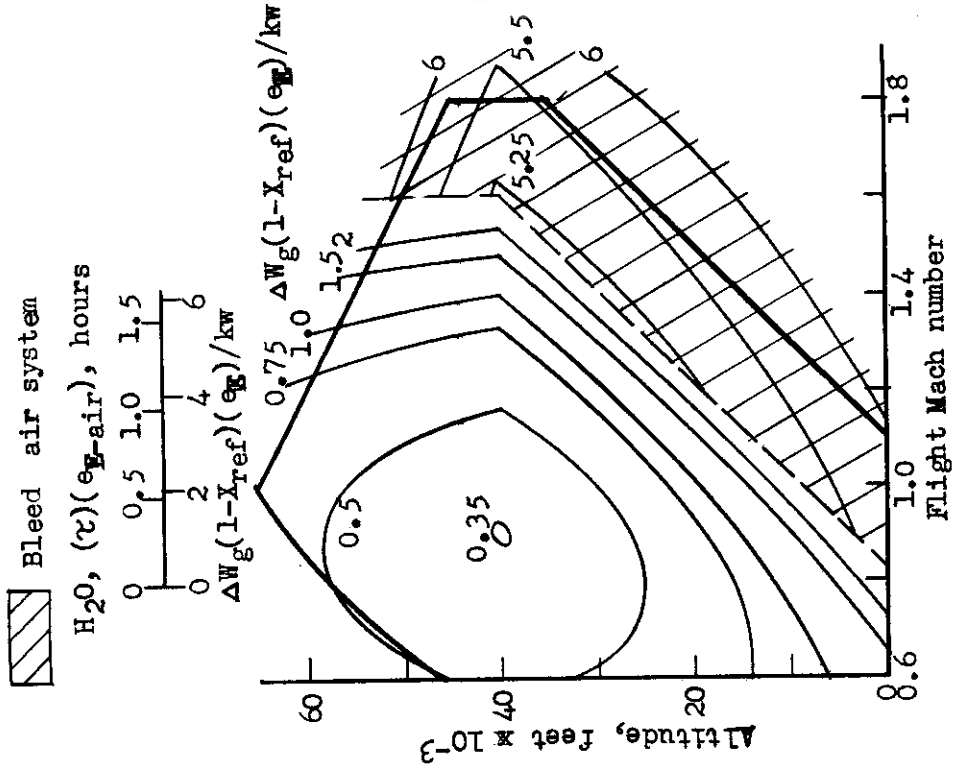

Figure II-11. Gross weight penalty of direct ram air versus direct bleed air systems.  $T_{gs}=650^{\circ}R$ .  $\alpha=2$ .

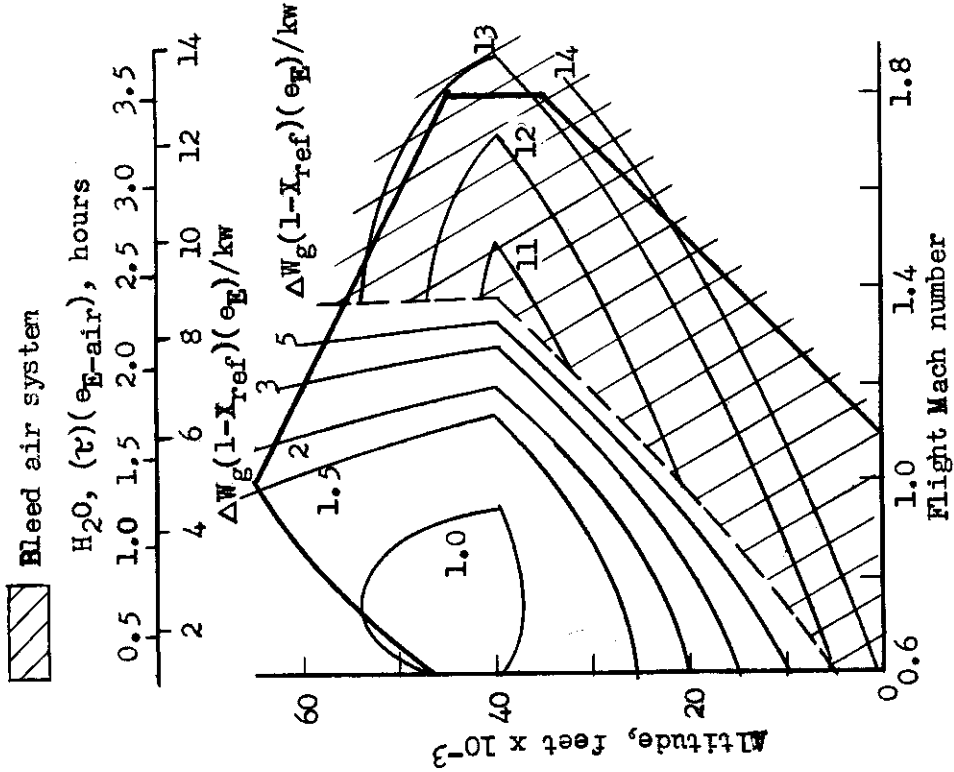

Figure II-10. Gross weight penalty of direct ram air versus direct bleed air systems.  $T_{gs}=590^{\circ}R$ .  $\alpha=4$ .

# Contrails

air systems. With reference to Figure II-8, for  $\alpha$  equal to 4 and a surface temperature of  $710^{\circ}\text{R}$ , the gross weight penalty of ram air systems is lower than that of bleed air systems for almost the entire range of flight conditions considered in this study. For flight conditions in the vicinity of Mach 1.8, the parameter  $(\tau)(e_{\text{E-air}})$  is equal to about 2 hours, so that the equivalent flight time for a direct expendable system using water would be in excess of 2 hours. For flight conditions corresponding to minimum gross weight penalty of ram air systems at  $710^{\circ}\text{R}$  surface temperature, the gross weight penalty of bleed air systems is greater by a ratio of about 20 to 1. The gross weight penalty of bleed air systems for a surface temperature of  $590^{\circ}\text{R}$  is less than that for ram air systems over roughly one-half of the flight range considered in this study. The gross weight penalty of bleed air systems for flight conditions in the vicinity of minimum penalty of ram air systems and a surface temperature of  $590^{\circ}\text{R}$  is greater by a ratio of about 10 to 1. Equivalent operating times of direct expendable water systems for  $590^{\circ}\text{R}$  surface temperature and  $\alpha$  equal to 4 are in excess of 3 hours at flight conditions corresponding to least penalty for bleed air systems. Comparing the data of Figure II-9 and II-11 illustrates that a decrease in  $\alpha$  from 4 to 2 reduces the gross weight penalty in the high-Mach-number range by a ratio of nearly 2 to 1.

The gross weight penalties of bleed air and expanded ram-air systems are compared in Figures II-12 through II-15. The cross-hatched area corresponds to flight conditions for which the gross weight penalty of bleed air systems is lower. Figures II-12, II-13 and II-14 compare the penalties of the two systems for the parameter  $\alpha$  equal to 2 and equipment component surface temperatures of  $710^{\circ}$ ,  $650^{\circ}$  and  $590^{\circ}\text{R}$ , respectively. For the range of flight conditions considered in this study, the gross weight penalty of expanded ram-air systems is lower than that of bleed air systems when the surface temperature is around  $650^{\circ}\text{R}$  and higher, except at flight altitudes above roughly 55,000 feet. At altitudes in the range of 10,000 to 40,000 feet and for surface temperatures of the equipment component in the range of  $650^{\circ}$  to  $710^{\circ}\text{R}$ , the weight penalty of the bleed air system is roughly twice that of the expanded ram-air system. The weight penalty of bleed air systems is less than that of expanded ram-air systems for a surface temperature of  $590^{\circ}\text{R}$  over a major portion of the flight range under consideration. In the altitude vicinity of 30,000 to 40,000 feet and for an equipment component surface temperature of  $590^{\circ}\text{R}$ , the gross weight penalty of bleed air systems is approximately 50% greater than that of expanded ram-air systems. The comparison of bleed air and expanded ram-air systems for the parameter  $\alpha$  equal to 1.0 and an average surface temperature of  $650^{\circ}\text{R}$  is shown in Figure II-15. A lower value for the parameter  $\alpha$  increases the flight range over which the gross weight penalty of bleed air systems is lower than that of expanded ram-air systems. The gross weight penalty of expanded ram-air systems is less than that for bleed air systems over the entire range of flight conditions under consideration when the parameter  $\alpha$  is greater than about 2.75.

The weight penalty of direct blower cooling systems is greater

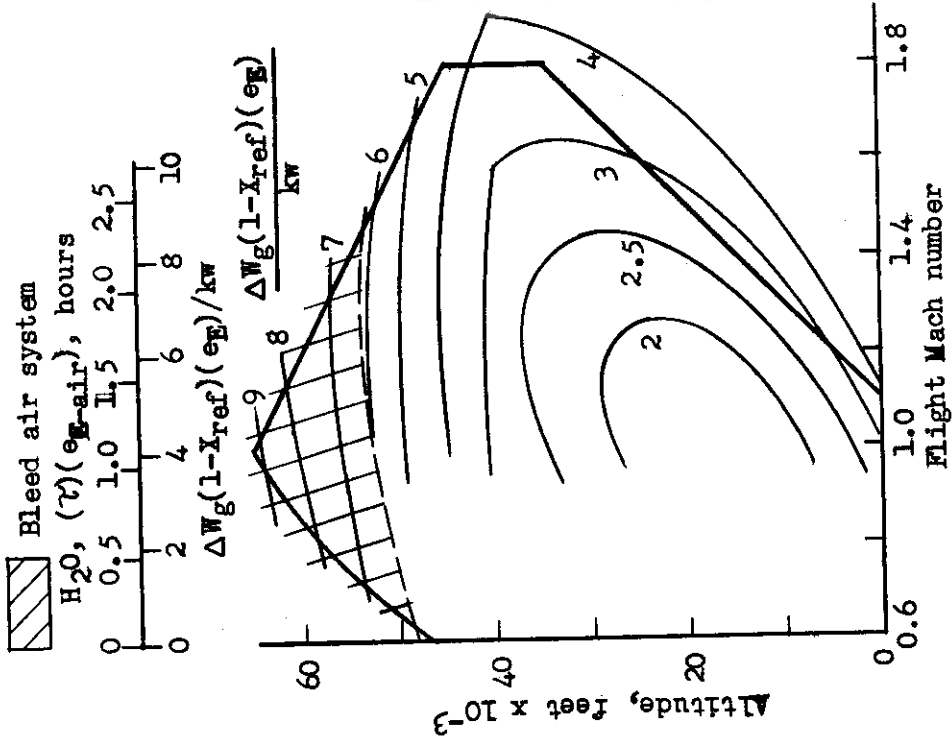

Figure II-13. Gross weight penalty of direct expanded ram-air versus direct bleed air systems.  $T_{Es}=650R$ ,  $\alpha=2$ .

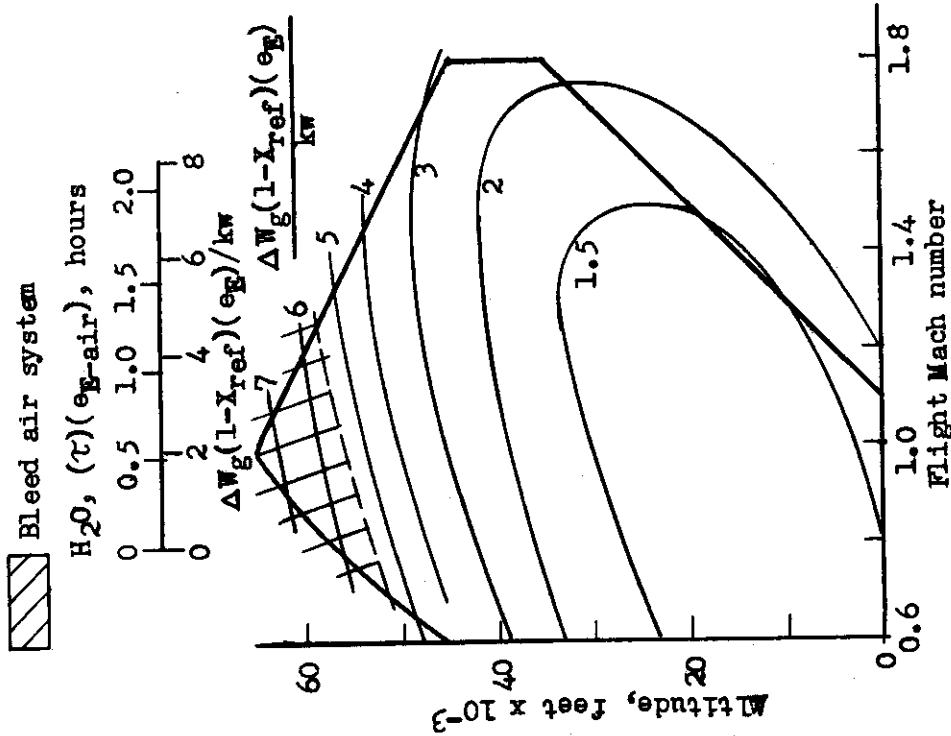

Figure II-12. Gross weight penalty of direct expanded ram-air versus direct bleed air systems.  $T_{Es}=7100R$ ,  $\alpha=2$ .



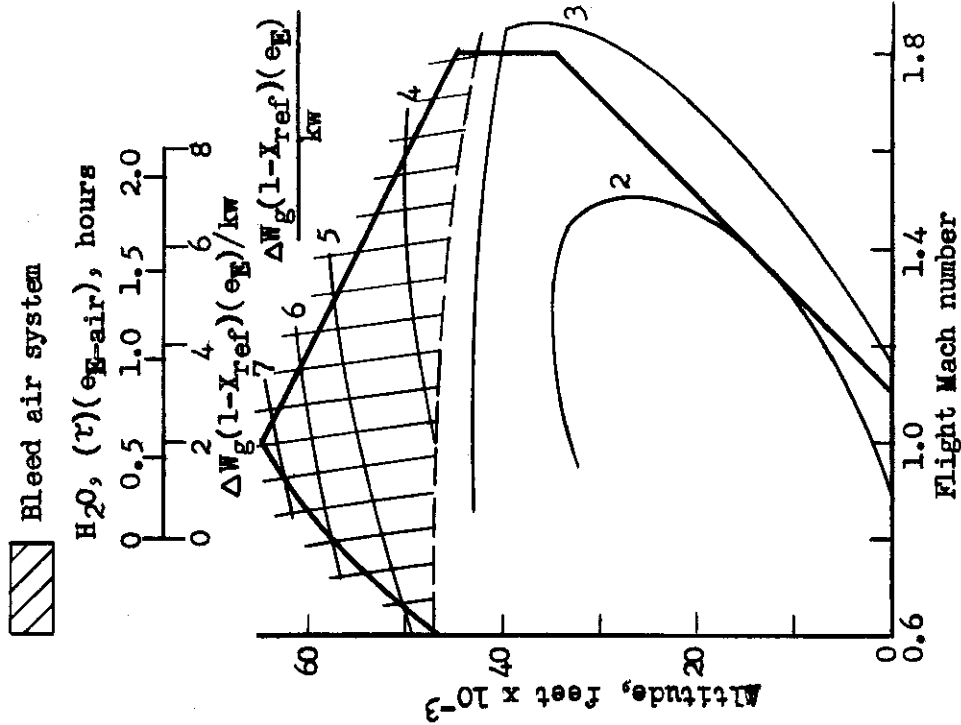

Figure II-15. Gross weight penalty of direct expanded ram-air versus direct bleed air systems.  $T_{Es}=650^{\circ}R$ ,  $\alpha=1$ .

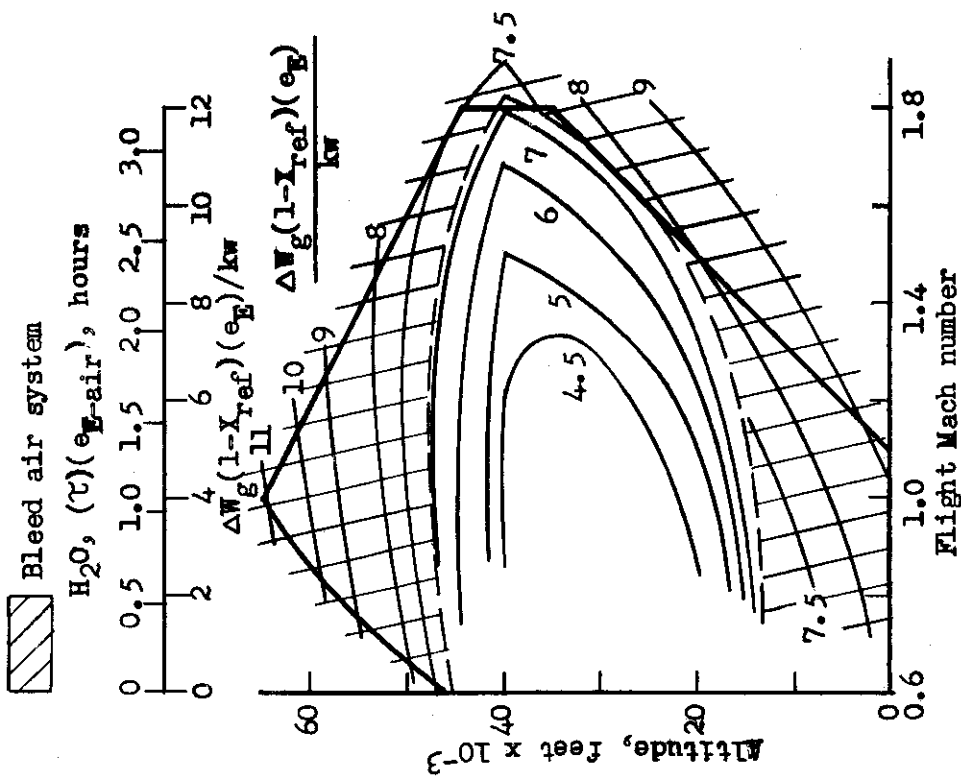

Figure II-14. Gross weight penalty of direct expanded ram-air versus direct bleed air systems.  $T_{Es}=590^{\circ}R$ ,  $\alpha=2$ .

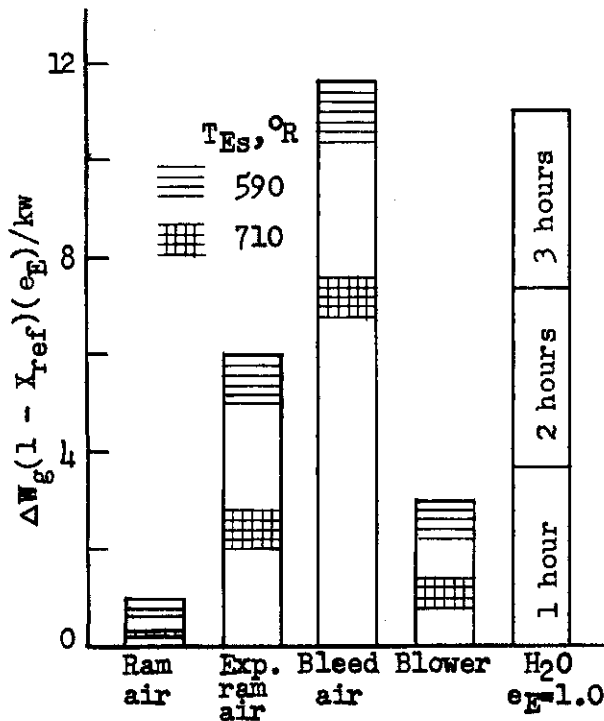

Figure II-16. Comparison of gross weight penalty for five types of direct cooling systems.  $M_{CO} = 0.9$ . Alt. = 40,000 feet.  $\alpha = 4$ .

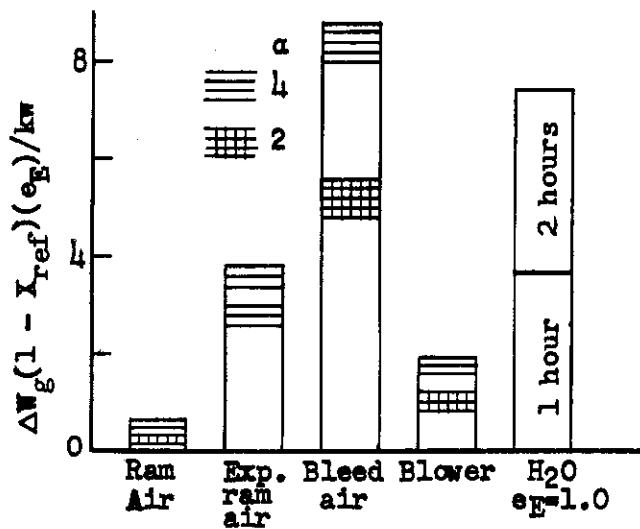

Figure II-17. Comparison of gross weight penalty for five types of direct cooling systems.  $M_{CO} = 0.9$ . Alt. = 40,000 feet.  $T_{Es} = 650^{\circ}R$ .

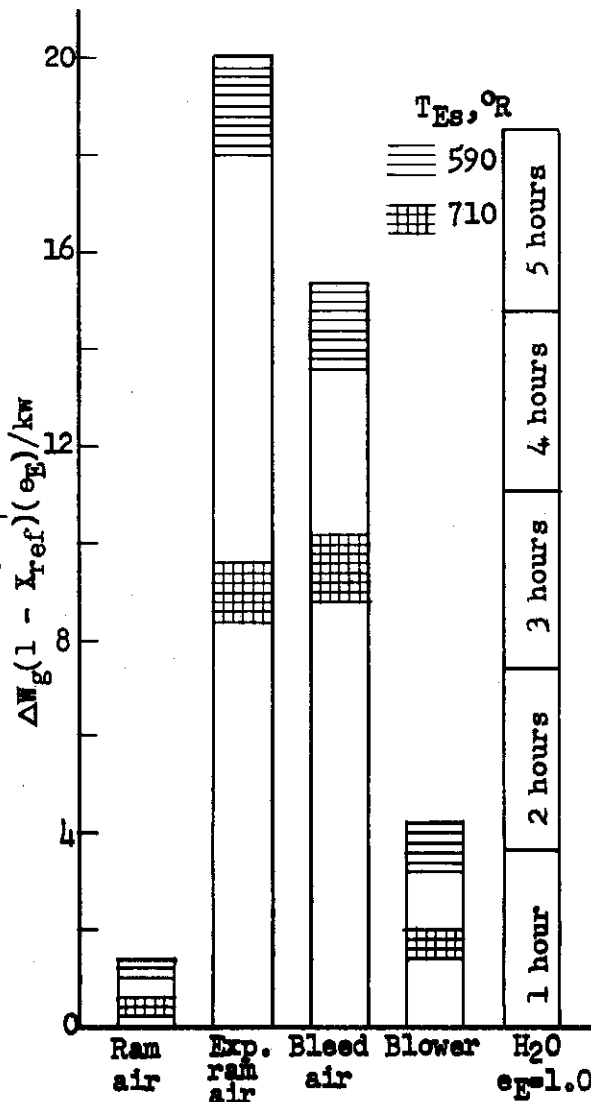

Figure II-18. Comparison of gross weight penalty for five types of direct cooling systems.  $M_{CO} = 0.9$ . Alt. = 60,000 feet.  $\alpha = 4$ .

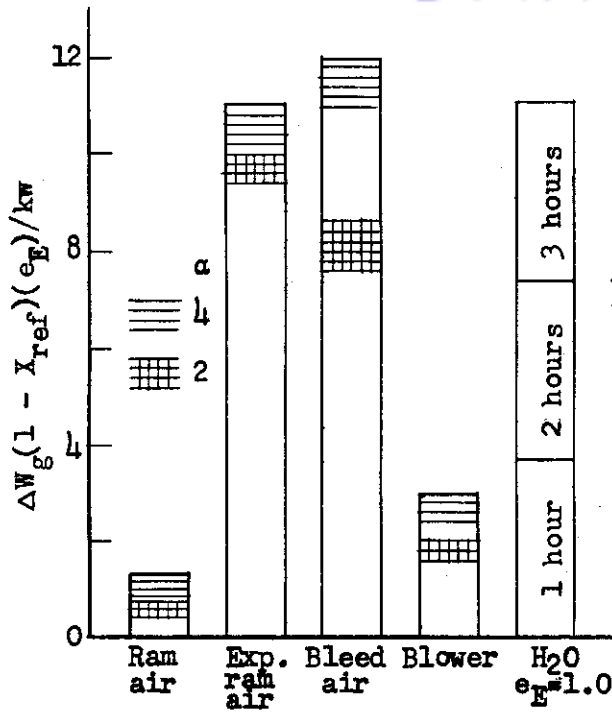

Figure II-19. Comparison of gross weight penalty for five types of direct cooling systems.  $M_{\infty} = 0.9$ . Alt. = 60,000 feet.  $T_{Es} = 650^{\circ}R$ .

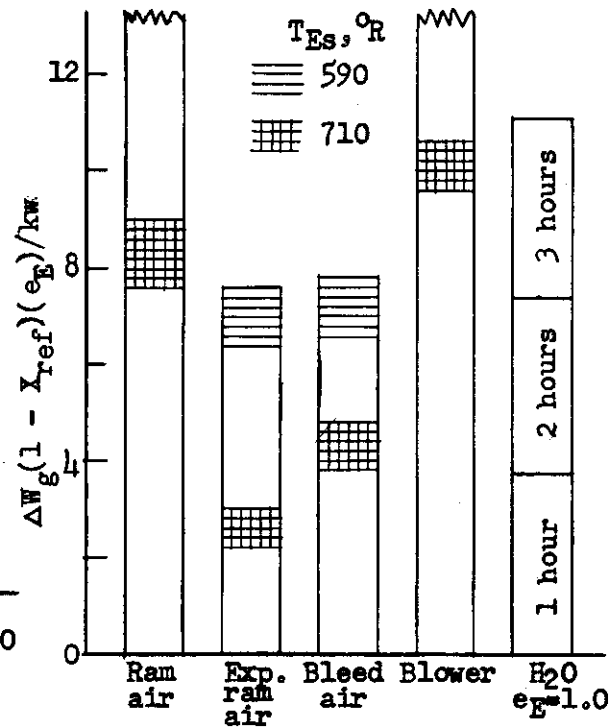

Figure II-20. Comparison of gross weight penalty for five types of direct cooling systems.  $M_{\infty} = 1.8$ . Alt. = 40,000 feet.  $\alpha = 2$ .

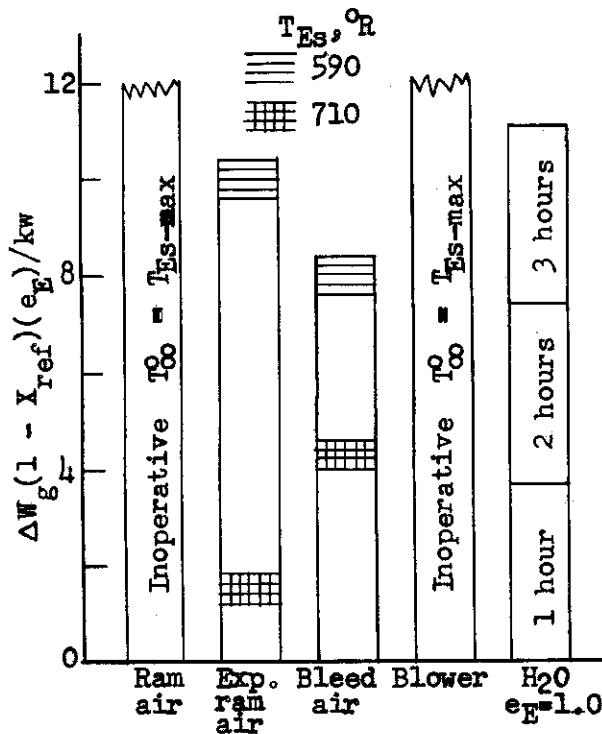

Figure II-21. Comparison of gross weight penalty for five types of direct cooling systems.  $M_{\infty} = 1.5$ . Alt. = 20,000 feet.  $\alpha = 2$ .

# Contrails

than that for direct ram air systems within the range of flight conditions under consideration. The weight penalty of blower systems is lower than that of ram air systems only at low flight Mach numbers; below about Mach 0.5 at 40,000 feet.

Comparisons of the gross weight penalty for direct ram-air, expanded ram-air, bleed air, blower and expendable water systems are presented in Figures II-16 through II-21 for various flight conditions, equipment component surface temperatures and values of the aircraft parameter  $\alpha$ . The cross-hatched areas define the approximate range on the gross weight parameter of the system resulting from consideration of the probable ranges on values of secondary design variables. The equivalent operating time of an expendable water system is obtained by dividing the indicated operating time by the effectiveness of the equipment component for the air system being compared. Figure II-16 compares the gross weight penalty of five direct systems for the flight condition of Mach 0.9 and an altitude of 40,000 feet, the parameter  $\alpha$  equal to 4 and equipment component surface temperatures of 590° and 710°R. The gross weight penalty of the ram air system is significantly below that for the other systems. The equivalent operating time for the expendable water system would be less than 0.5 hour, unless the equipment component effectiveness is below about 50%. The weight penalty of direct ram air systems without thrust recovery for this flight condition would be on the same order of magnitude as for the blower system, which is considerably below the weight penalties of the expanded ram-air and bleed air systems and corresponds to an equivalent operating time in the range of 0.5 to 1.0 hour. The comparison of the gross weight penalty for the various direct systems at the same flight condition but for  $\alpha$ -values of 2 and 4 and an average surface temperature of 650°R is shown in Figure II-17. The comparison illustrates that for this flight condition the weight penalty of ram air systems is lowest for a range of various types of aircraft represented by the lift-to-drag ratio and the ratio of fuel weight to gross weight at take-off. The comparison of the gross weight penalties for the highest and lowest surface temperatures,  $\alpha$  equal to 4, i.e., a lift-to-drag ratio in the vicinity of 12 and the flight condition of 60,000 feet at Mach 0.9, is shown in Figure II-18. A lift-to-drag ratio on the order of 18,  $\alpha$  of about 6, would present an even more favorable weight penalty comparison for ram air systems at this flight condition. At high altitudes, the gross weight penalty of expanded ram-air systems is higher than or on the same order of magnitude as that for bleed air systems.

Figure II-20 presents a comparison of the gross weight penalties for the flight condition of Mach 1.8 at 40,000 feet. The parameter  $\alpha$  is equal to 2. The weight penalty of the bleed air and expanded ram-air systems are approximately the same, and correspond to an equivalent operating time on the order of 1.0 to 2.5 hours. Blower and ram air systems are inoperable at this flight condition for the lowest surface temperature of 590°R. For the highest surface temperature of 710°R the weight penalty of ram air systems is about twice that of bleed air systems with the equivalent operating time being on the order of 3 hours.

*Continued*

Figure II-21 presents a similar comparison for the flight condition of Mach 1.5 at 20,000 feet. Ram air and blower systems are inoperable for the entire range of surface temperatures. The weight penalty for the expanded ram-air system is roughly one-half of that for the bleed air system at the highest surface temperature and about 25% greater at the lowest surface temperature. The equivalent operating time would be from less than 1.0 hour to greater than 3 hours for the range of weight penalty on the two systems.

Figure II-22 presents the variation of the gross weight parameter for direct ram air systems as a function of the system temperature potential. The band defines the range on weight penalty for all flight and design conditions investigated in this study. The system temperature potential is the difference of the equipment component surface and inlet total air temperatures divided by 100. These data may be used for estimation of the gross weight penalty at any flight condition, equipment component surface temperature and atmospheric air temperature. Similar data are presented in Figures II-23 and II-24 for the expanded ram-air system and in Figures II-25 and II-26 for the bleed air system. For any value of the system temperature potential, the gross weight parameter increases with the type of system in the order -- ram air, expanded ram-air, bleed air, except at the highest altitudes where, in general, the weight penalty of bleed air systems is somewhat lower than that of expanded ram-air systems.

Figure II-27 presents an order-of-magnitude comparison of the spatial requirements for direct ram air, direct expanded ram-air and direct bleed air systems. The flight Mach number is 0.9 and the comparisons are presented for the highest and lowest surface temperatures at altitudes of 40,000 and 60,000 feet. Spatial requirements of ram air and expanded ram-air systems are approximately the same. Spatial requirements of bleed air systems at this flight Mach number are greater by a ratio of roughly 2 to 1.

## 2. Indirect Cooling Systems

Aircraft gross weight penalty of an indirect cooling system is greater than that of a direct system because of the additional intermediate and distribution components, but the indirect system is capable of serving widely dispersed or a number of groups of equipment items. Comparisons of various indirect systems presented in the following employ a water-methyl alcohol mixture as transfer fluid, having a freezing point of  $-65^{\circ}\text{F}$ .

Figure II-28 presents the break-even flight conditions and gross weight penalty of indirect ram air versus indirect expanded ram-air cooling systems. Flight conditions to the left of the various lines shown in the altitude-Mach number plot correspond to least penalty for the indirect ram air system. Break-even flight conditions are only slightly affected by the magnitude of the aircraft parameter  $\alpha$ . Also, the length of the distribution component would only slightly alter the

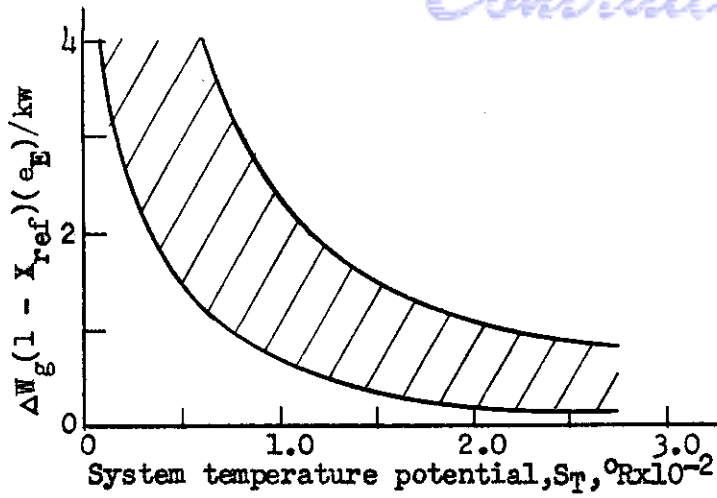

Figure II-22. Variation of gross weight penalty with system temperature potential for direct ram air systems.

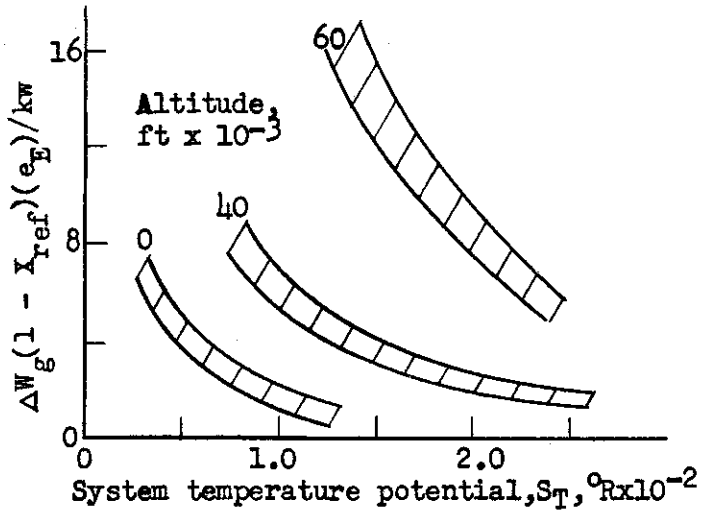

Figure II-23. Variation of gross weight penalty with system temperature potential for direct expanded ram-air systems.  $\alpha = 2$ .

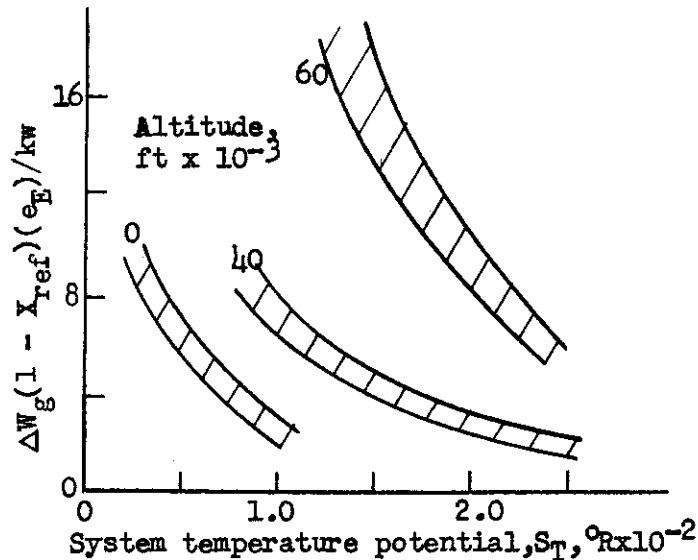

Figure II-24. Variation of gross weight penalty with system temperature potential for direct expanded ram-air systems.  $\alpha = 4$ .

# Contrails

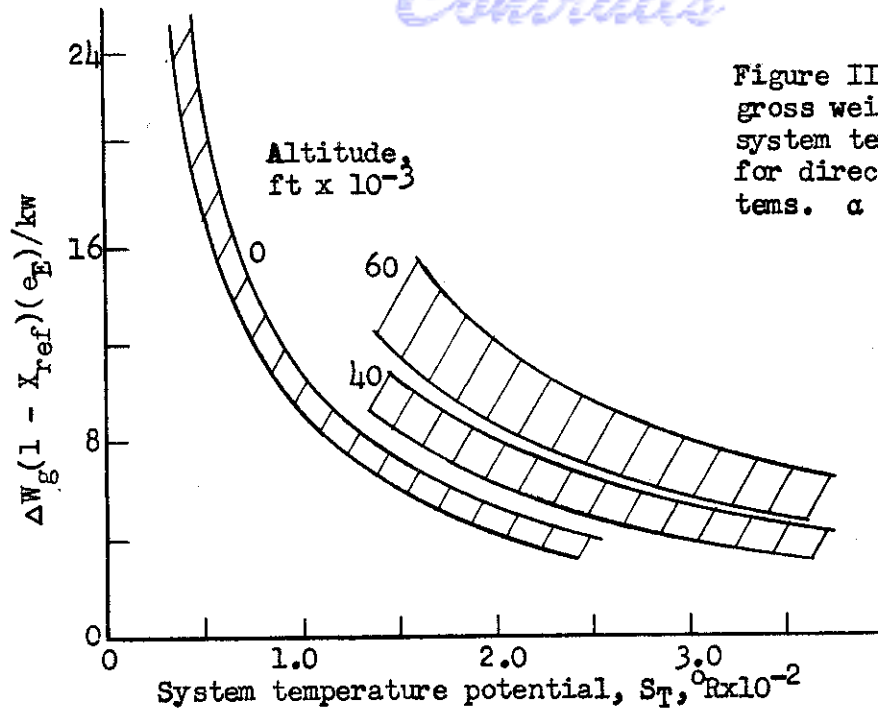

Figure II-25. Variation of gross weight penalty with system temperature potential for direct bleed air systems.  $\alpha = 2$ .

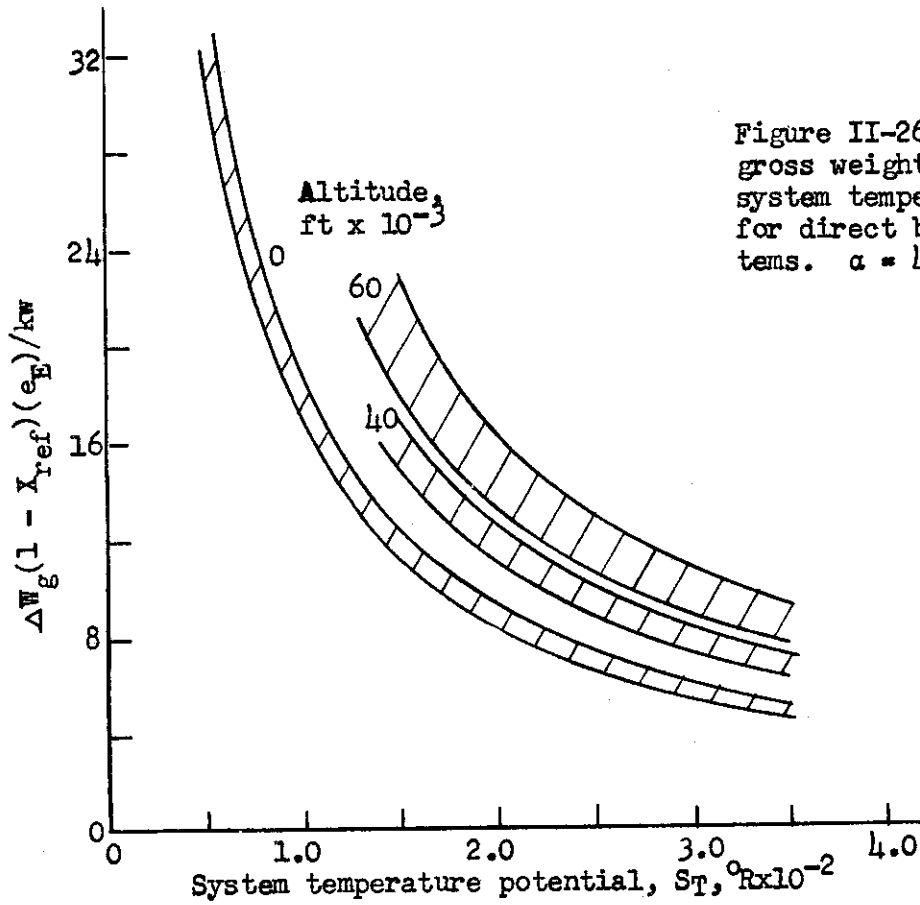

Figure II-26. Variation of gross weight penalty with system temperature potential for direct bleed air systems.  $\alpha = 4$ .

# Contrails

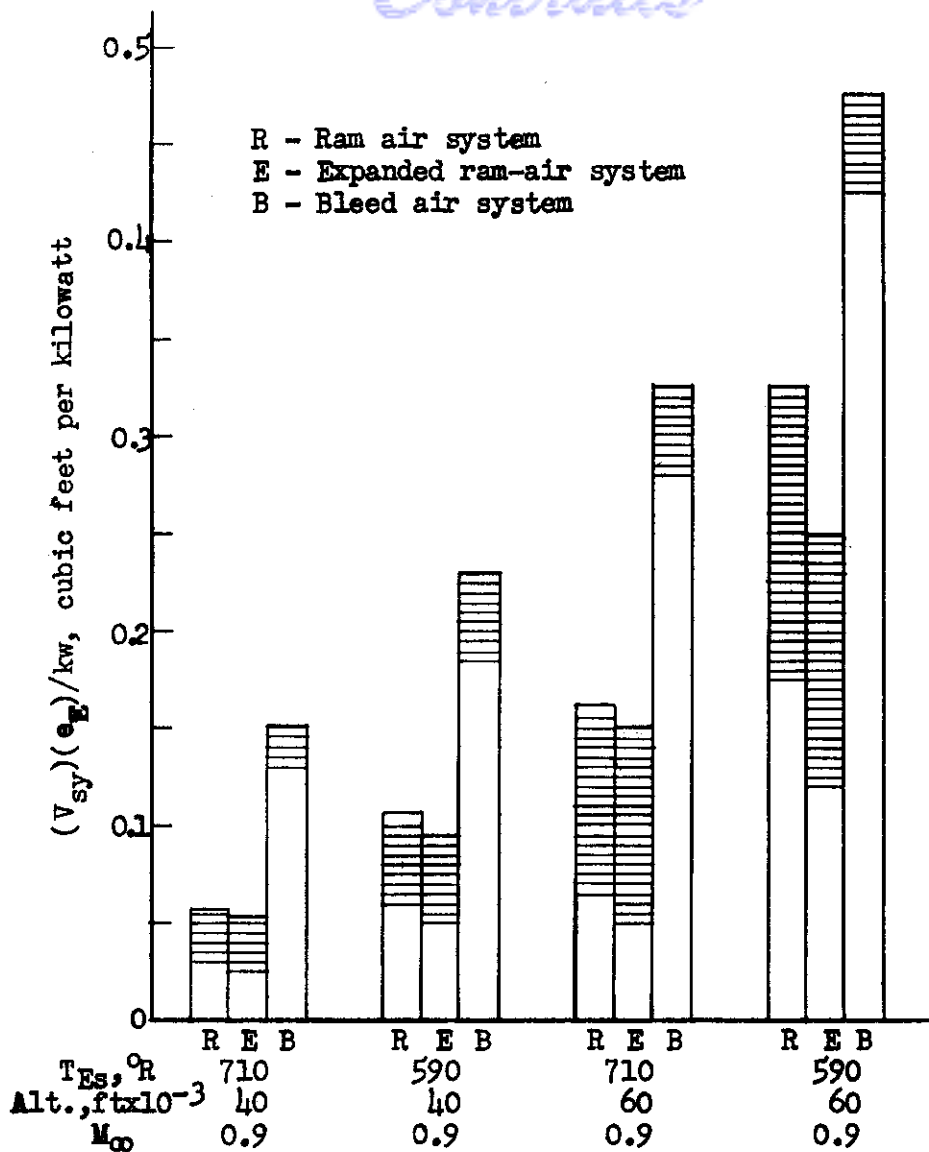

Figure II-27. Comparison of volume of direct ram air, expanded ram-air and bleed air systems.

break-even flight conditions. The aircraft penalty is least for indirect ram air systems over roughly one-half of the flight range for the lowest equipment component surface temperature of 590°R. Supersonic flight speeds of major significance for the range under consideration correspond to least penalty for indirect expanded ram air systems. Break-even values of the gross weight parameter  $\Delta W_g(1-I_{ref})/kw$  vary from about 3 to over 10 pounds per kilowatt. Thus, the equivalent operating time of a direct expendable system employing water would be from around 1.0 to over 3 hours.

Figure II-29 presents a similar break-even comparison for indirect expanded ram-air versus indirect bleed air systems. Flight condi-



# Contrails

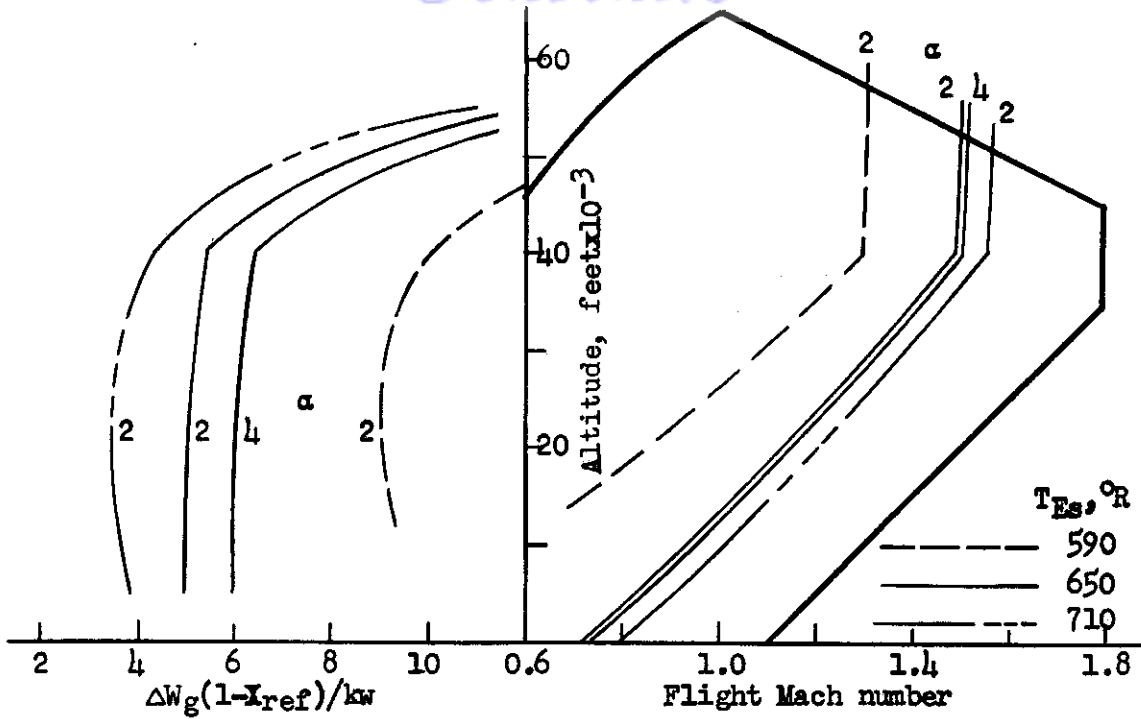

Figure II-28. Break-even gross weight penalties and flight conditions for indirect ram air and indirect expanded ram-air cooling systems.  $L_D = 200$  feet.

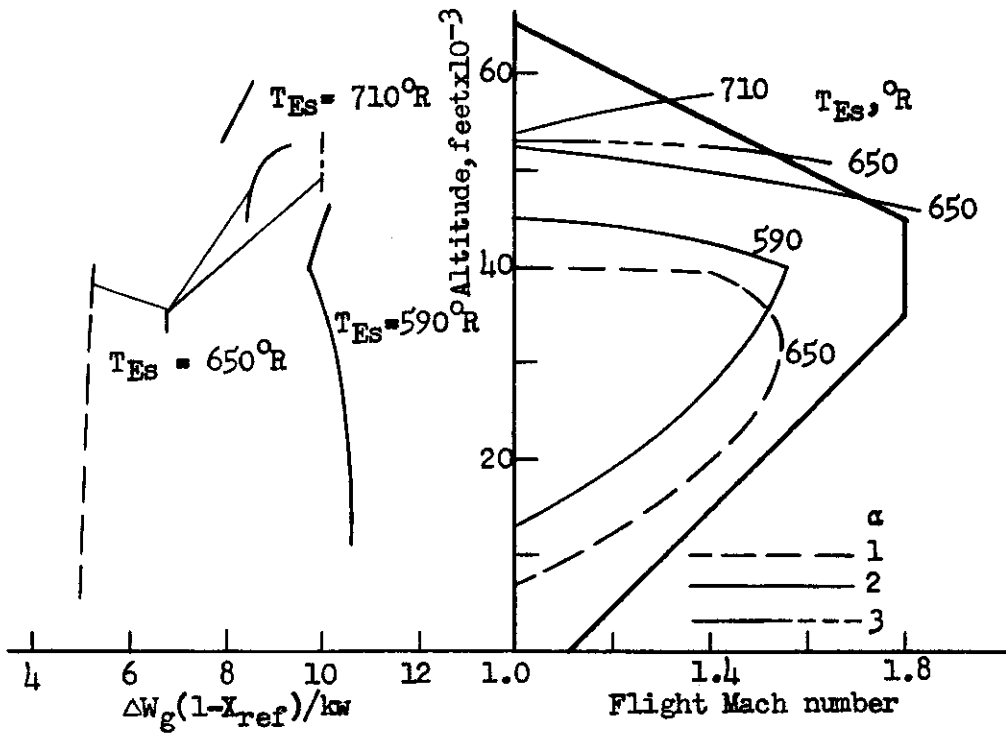

Figure II-29. Break-even gross weight penalties and flight conditions for indirect expanded ram-air and indirect bleed air cooling systems.  $L_D = 200$  ft.

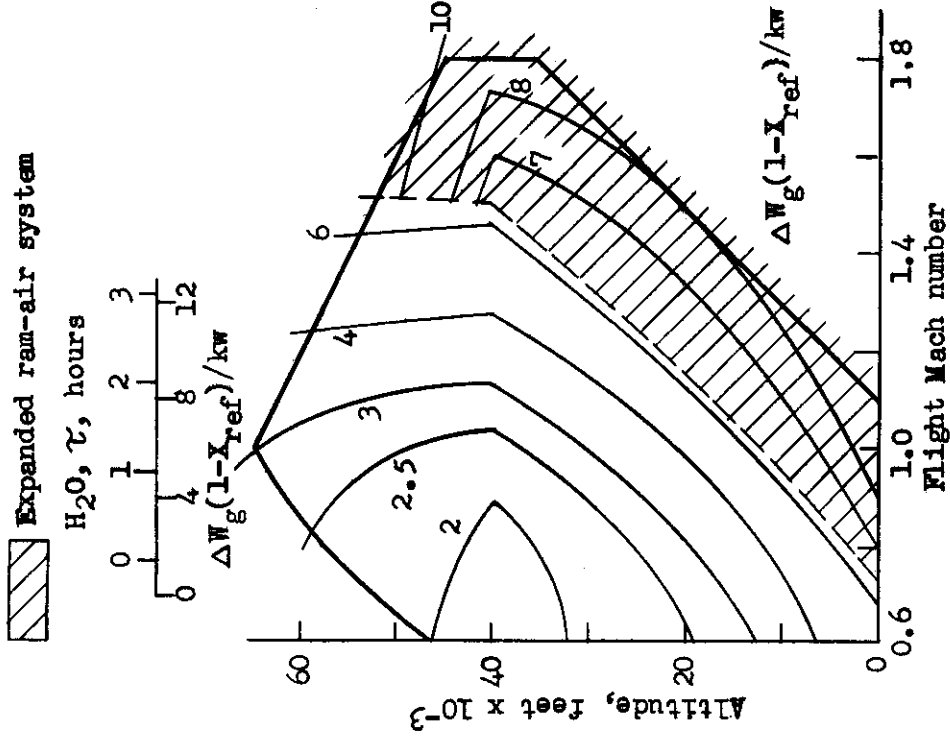

Figure II-31. Gross weight penalty of indirect ram air versus indirect expanded ram-air systems.  $T_{ES}=650^{\circ}R$ .  $\alpha=4$ .  $L_{IJ}=200$  feet.

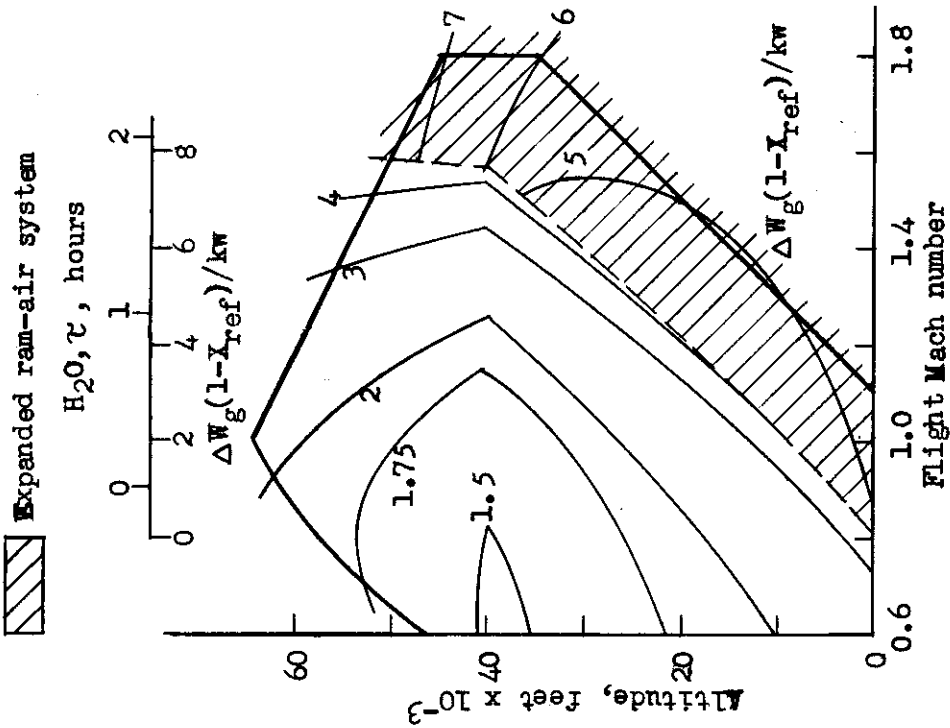

Figure II-30. Gross weight penalty of indirect ram-air versus indirect expanded ram-air systems.  $T_{ES}=710^{\circ}R$ .  $\alpha=4$ .  $L_{IJ}=200$  feet.

# Contrails

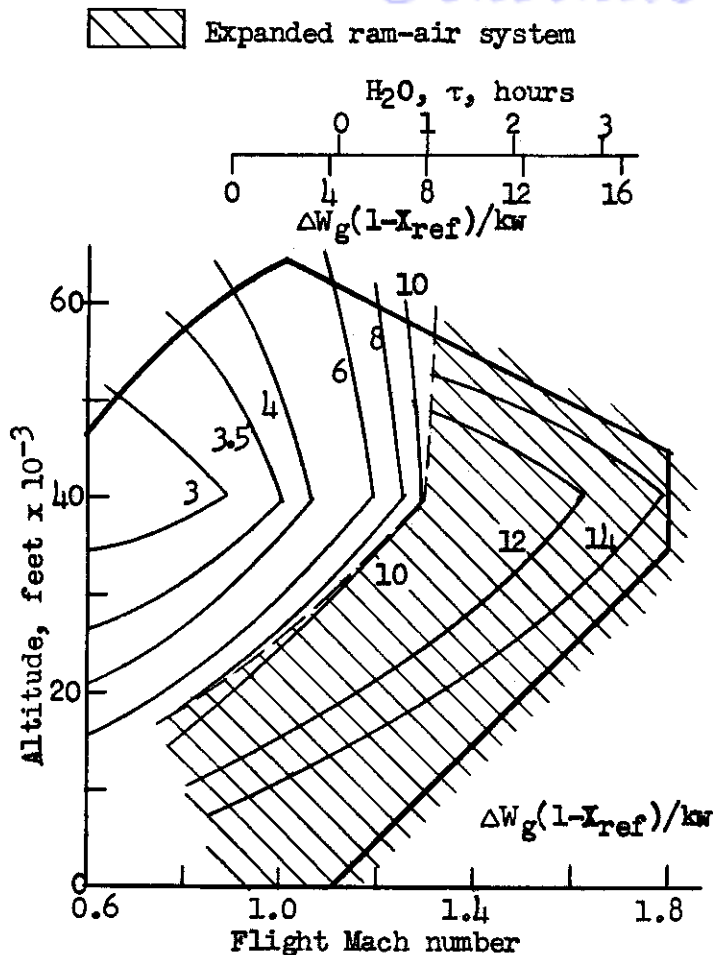

Figure II-32. Gross weight penalty of indirect ram air versus indirect expanded ram-air systems.  $T_{Es} = 590^{\circ}R$ .  $\alpha = 4$ .  $L_D = 200$  feet.

tions inside of the lines shown on the altitude-Mach number plot correspond to least weight penalty for indirect expanded ram-air systems. Except for low surface temperatures and low values of the parameter  $\alpha$ , the gross weight penalty for indirect bleed air systems over the flight range under consideration is lower only at flight altitudes above about 50,000 feet. The gross weight penalty is lower for bleed air systems over a significantly large portion of the flight range for surface temperatures around  $590^{\circ}R$ . Break-even values of the gross weight parameter  $\Delta W_g(1-X_{ref})/kw$  for indirect bleed air versus indirect expanded ram-air systems vary from about 5 to 11, which correspond to an equivalent operating time for direct expendable water systems of from about 1.5 to 3 hours.

Figures II-30, II-31 and II-32 present comparisons of the gross weight penalty of indirect ram air and indirect expanded ram-air cooling systems for equipment component surface temperatures of  $710^{\circ}$ ,  $650^{\circ}$  and  $590^{\circ}R$ , respectively. The data correspond to a distribution component length of 200 feet,  $\alpha$  equal to 4 and effectivenesses of the equipment component equal to 90% or higher. Values of the gross weight parameter  $\Delta W_g(1-X_{ref})/kw$  for indirect ram air systems at subsonic Mach numbers and altitudes in the vicinity of 40,000 feet are on the order of one-third of

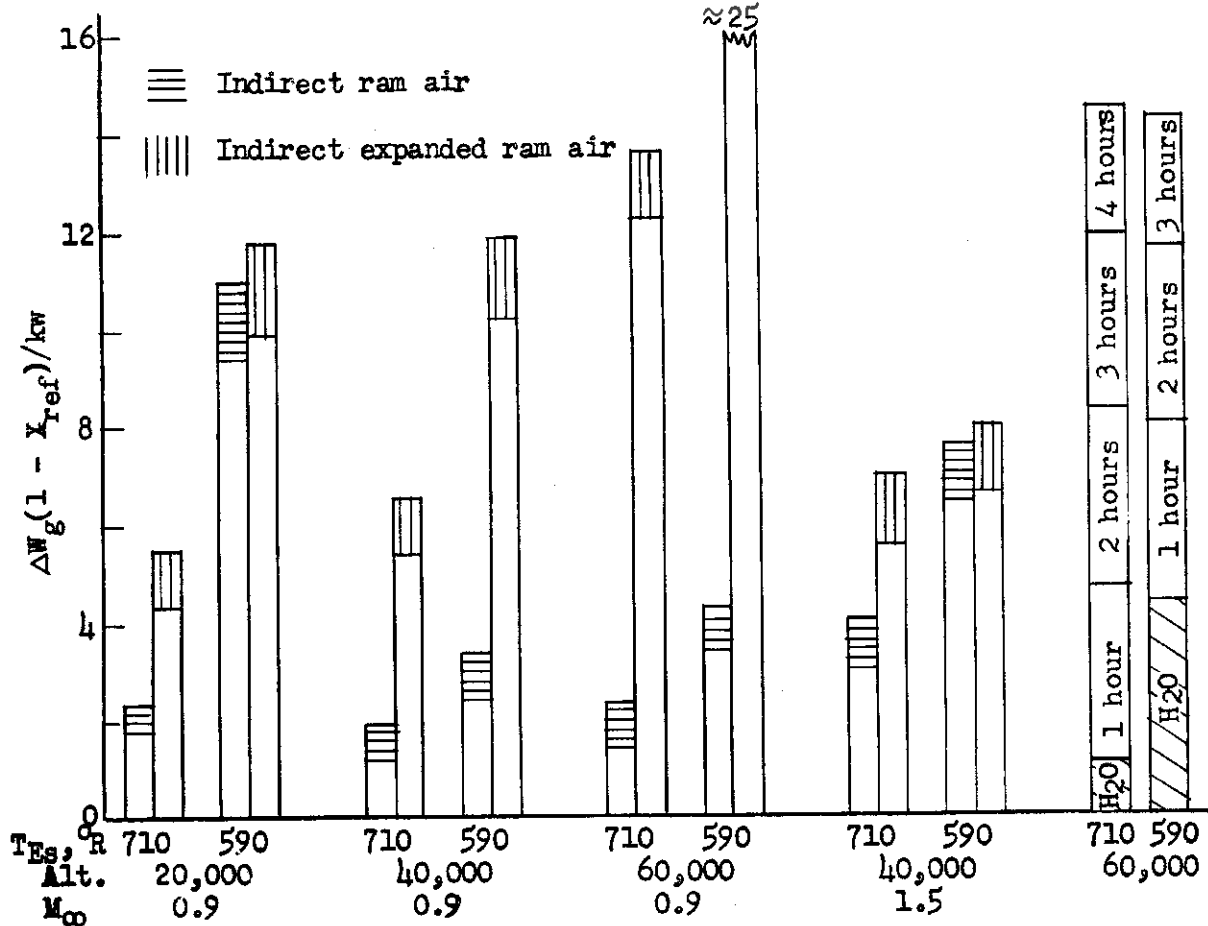

Figure II-33. Comparison of the gross weight penalty of indirect ram air and indirect expanded ram-air systems.  $L_D = 200$  ft.  $\alpha = 4$ .

the weight penalty at the break-even flight conditions. The region of least penalty for ram air systems is essentially limited to subsonic flight speeds. The equivalent operating time of an expendable water system shown on the auxiliary scale is for an indirect system at 60,000 feet and a distribution component length of 200 feet. The comparison to this system and design condition is for the purpose of convenience in presentation. Indirect expendable water systems are compared for other flight conditions and ultimate fluids in subsequent paragraphs. At Mach 0.9 and 40,000 feet the equivalent operating time for the reference water system is less than about 10 minutes for all surface temperatures considered. The equivalent operating time at Mach 1.5 and 40,000 feet is 0.7, 1.5 and 2 hours for surface temperatures of 710°, 650° and 590°R, respectively; at Mach 1.8 and 40,000 feet the corresponding values are 1.5, 2 and 2.7 hours.

Figure II-33 presents a comparison of the gross weight parameter of indirect ram air and expanded ram-air cooling systems for various representative flight conditions and equipment component surface temperatures. The range on the gross weight parameter indicated by the cross-

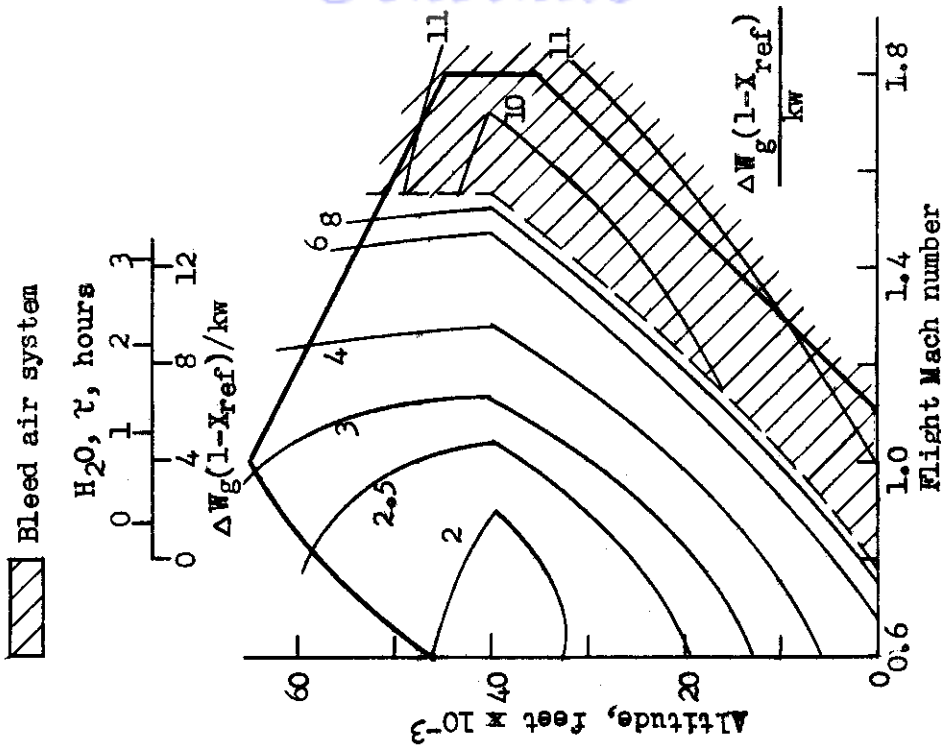

Figure II-35. Gross weight penalty of indirect ram air versus indirect bleed air systems.  $T_{ES} = 650^\circ R$ ,  $\alpha = 4$ ,  $L_{ij} = 200$  ft.

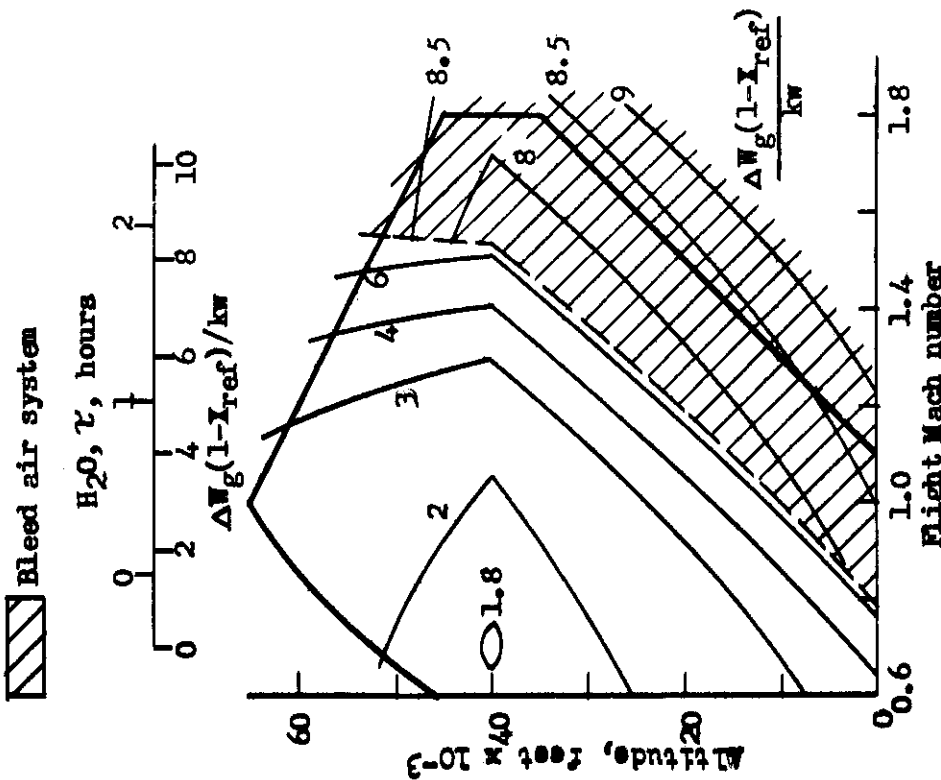

Figure II-34. Gross weight penalty of indirect ram air versus indirect bleed air systems.  $T_{ES} = 650^\circ R$ ,  $\alpha = 2$ ,  $L_{ij} = 200$  ft.

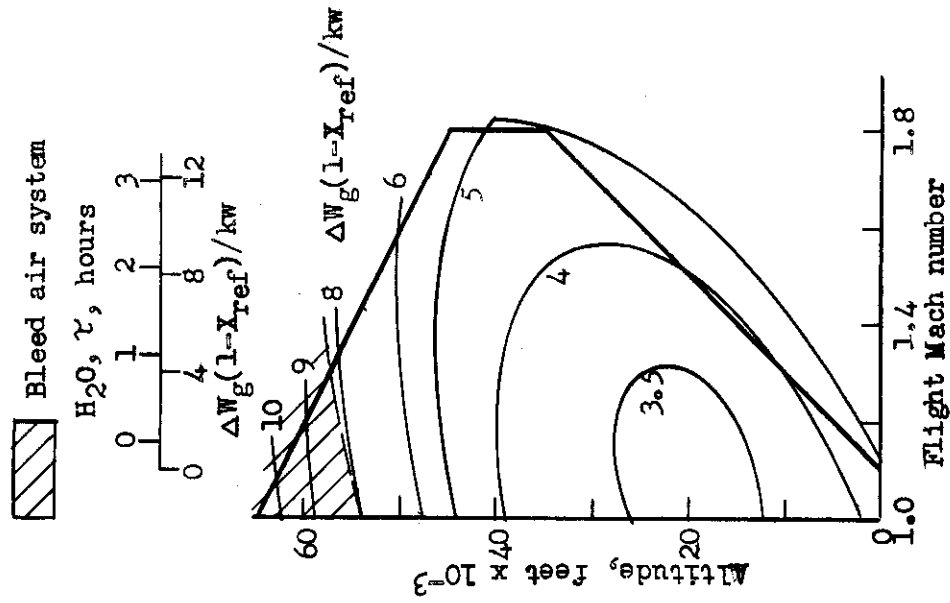

Figure II-37. Gross weight penalty of indirect expanded ram-air versus indirect bleed air systems.  $T_{ES}=710^{\circ}R$ ,  $\alpha = 2$ ,  $L_D=200$  ft.

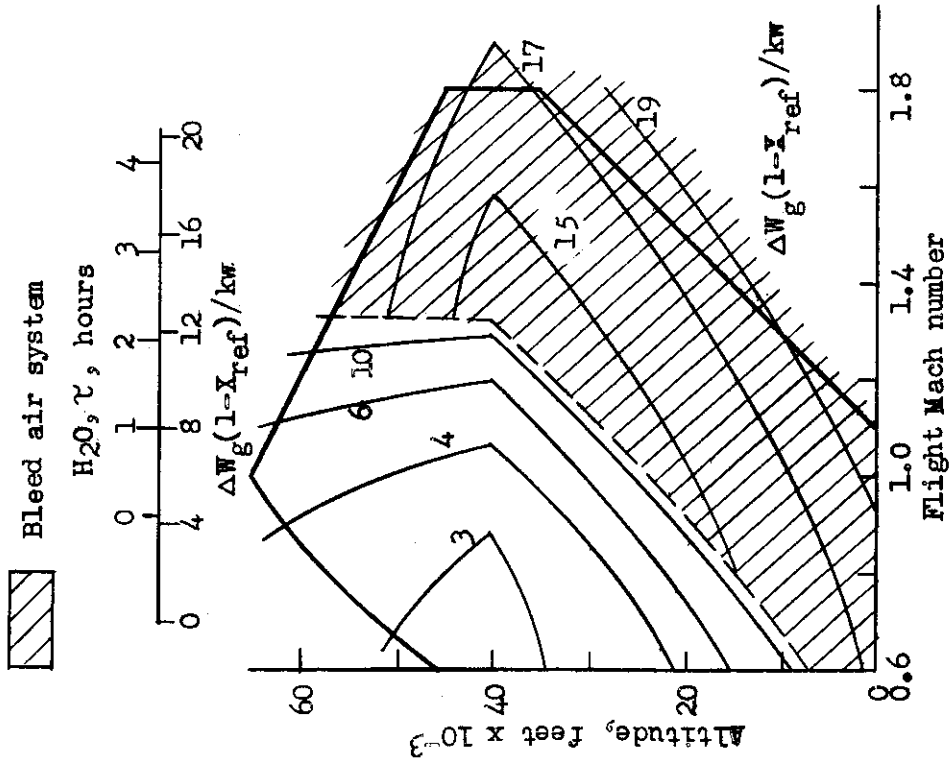

Figure II-36. Gross weight penalty of indirect bleed air versus direct ram air systems.  $T_{ES}=590^{\circ}R$ ,  $\alpha = 4$ ,  $L_D=200$  ft.

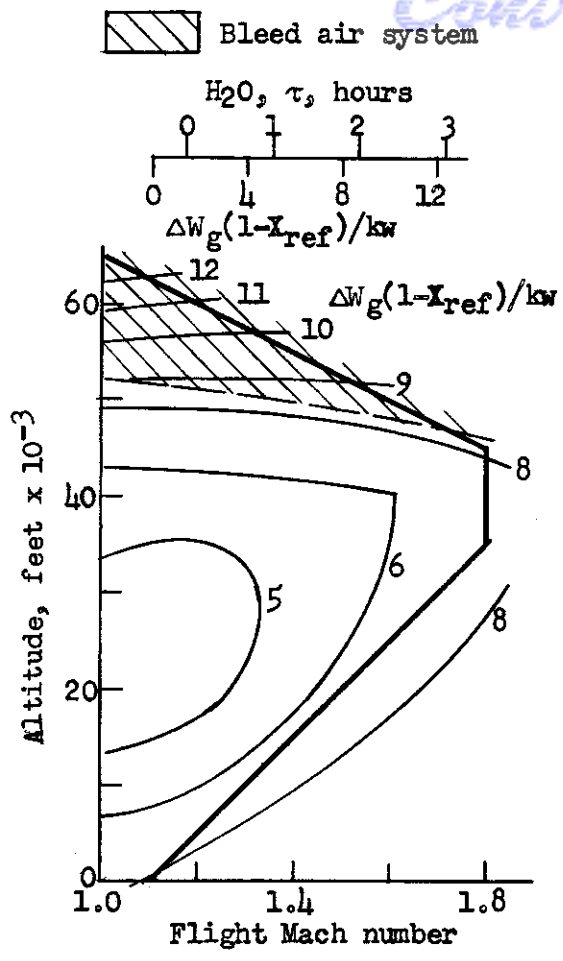

Figure II-38. Gross weight penalty of indirect expanded ram-air versus indirect bleed air systems.  $T_{Es} = 650^{\circ}R$ .  $\alpha = 2$ .  $L_D = 200$  ft.

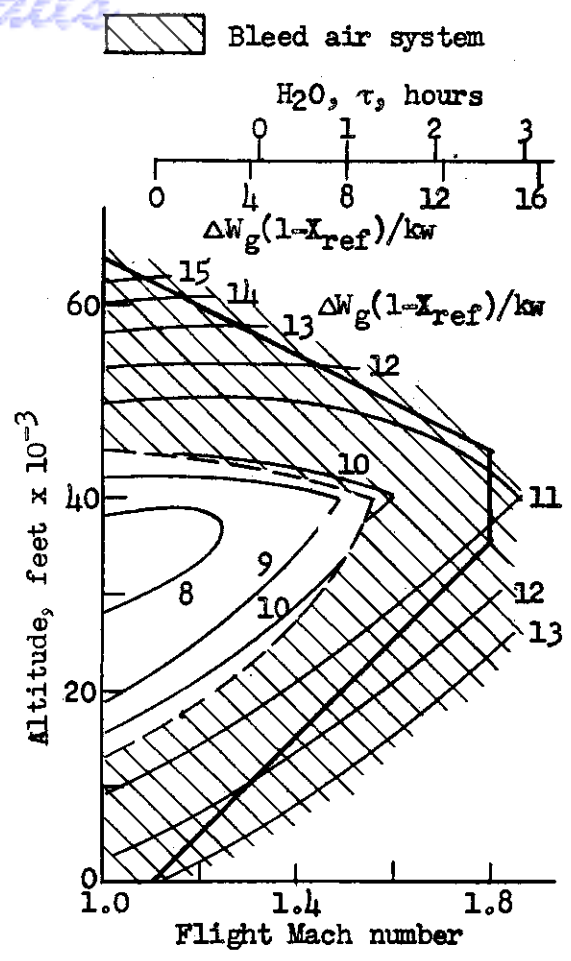

Figure II-39. Gross weight penalty of indirect expanded ram-air versus indirect bleed air systems.  $T_{Es} = 590^{\circ}R$ .  $\alpha = 2$ .  $L_D = 200$  ft.

hatched area is intended to be representative of the effects of variations in secondary design variables. At the flight Mach number of 0.9 the weight penalty of the indirect ram air system is appreciably lower except for the conditions of low altitude and low surface temperature. The gross weight penalties of the two systems are approximately the same at Mach 1.5 and 40,000 feet when the surface temperature is 650°R and higher. The equivalent operating time for the reference indirect water system varies from less than 1 hour to around 3 hours.

Comparisons of the gross weight penalty for indirect ram air and bleed air systems are presented in Figures II-34, II-35 and II-36. The distribution component length is 200 feet and the effectiveness of the equipment component is 90% or higher. The system comparisons in Figures II-34 and II-35 are for the parameter  $\alpha$  equal to 2 and 4, respectively, and an equipment component surface temperature of 650°R. The

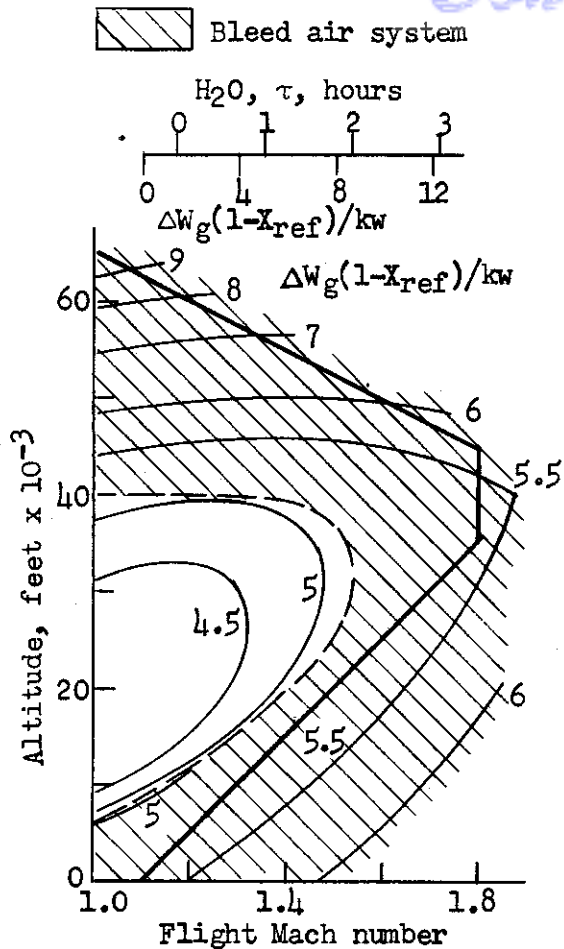

Figure II-40. Gross weight penalty of indirect expanded ram-air versus indirect bleed air systems.  $T_{Es} = 650^{\circ}R$ .  $\alpha = 1$ .  $L_D = 200$  ft.

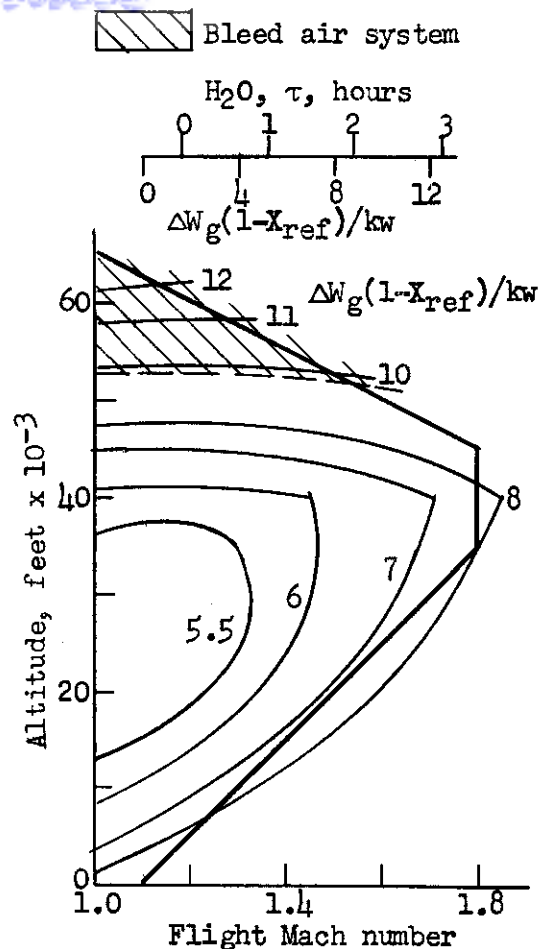

Figure II-41. Gross weight penalty of indirect expanded ram-air versus indirect bleed air systems.  $T_{Es} = 650^{\circ}R$ .  $\alpha = 3$ .  $L_D = 200$  ft.

data in Figure II-36 are for  $\alpha$  equal to 4 and  $590^{\circ}R$  surface temperature. Data for the surface temperature of  $710^{\circ}R$  are not presented since the indirect ram air penalty is lower than the bleed air for almost the entire flight range under consideration. The equivalent operating times of the reference indirect water system vary from 0 to 2.5 hours for  $650^{\circ}R$  surface temperature and from 0 to 4 hours at  $590^{\circ}R$  surface temperature.

Figures II-37 through II-41 present comparisons of indirect expanded ram-air and indirect bleed air systems having a distribution component length of 200 feet. Figures II-37, II-38 and II-39 are for  $\alpha$  equal to 2 and equipment component surface temperatures of  $710^{\circ}$ ,  $650^{\circ}$  and  $590^{\circ}R$ , respectively. Like with direct systems, the weight penalty is least for expanded ram-air systems except at high altitudes and for low surface temperatures. The equivalent operating time for the reference indirect water system ranges from about 0.6 to 3 hours for the flight



Figure II-42. Comparison of the gross weight penalty of indirect expanded ram-air and indirect bleed air systems.  $L_D = 200$  feet.

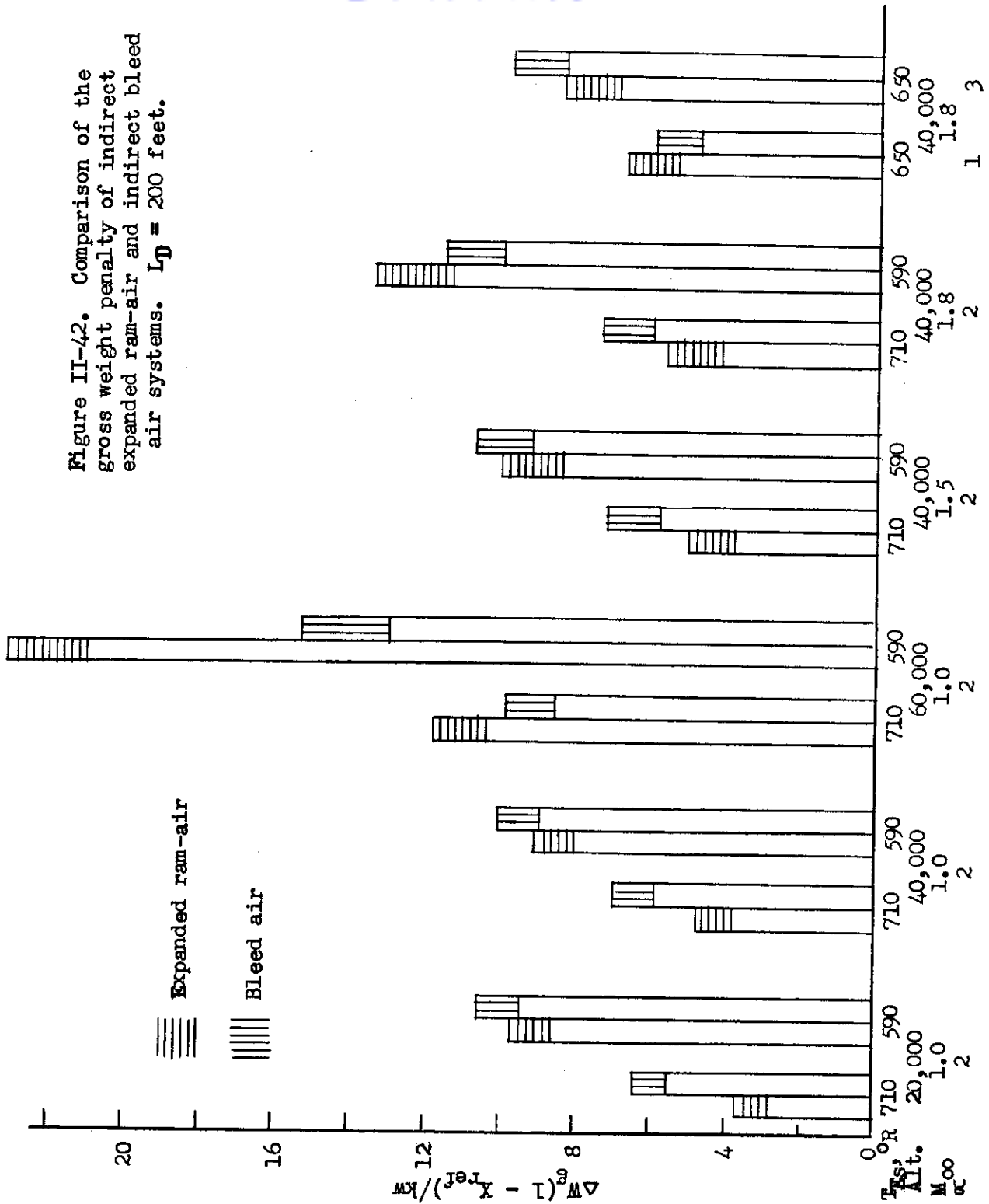

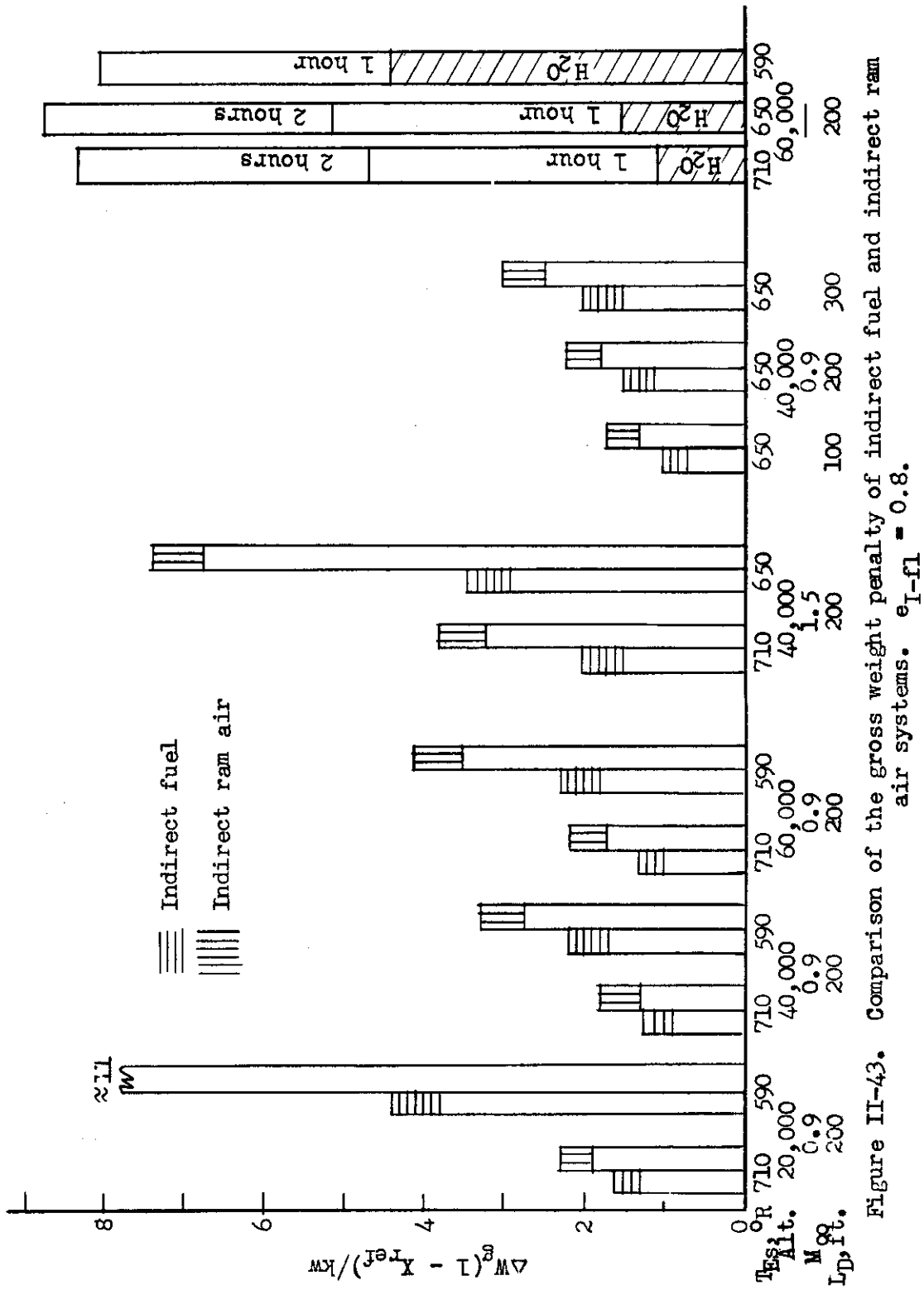

Figure II-43. Comparison of the gross weight penalty of indirect fuel and indirect ram air systems.  $e_{I-fl} = 0.8$ .

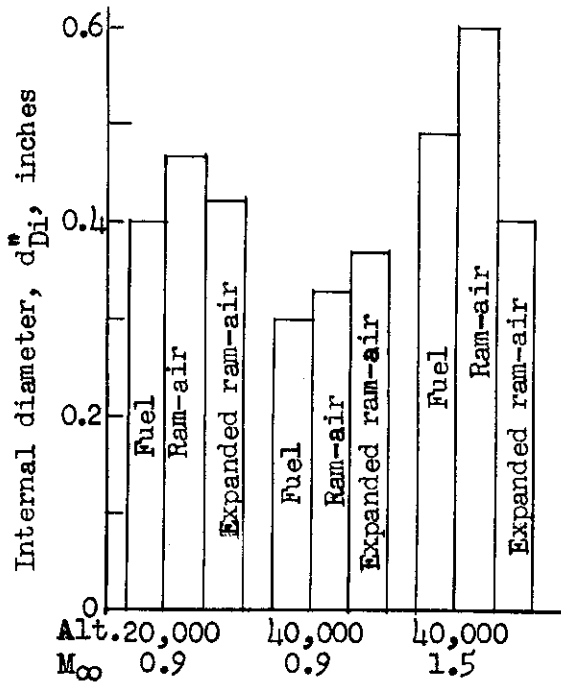

Figure II-44. Distribution component line diameters for indirect fuel, ram air and expanded ram-air systems.  $T_{Es} = 650^{\circ}R$ .  $kw = 25$ .  $L_D = 200$  feet.

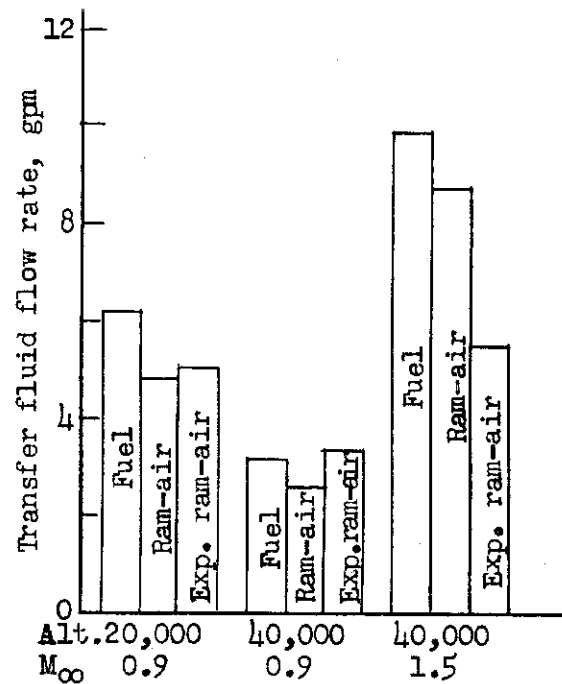

Figure II-45. Transfer fluid flow rates for indirect fuel, ram air and expanded ram-air systems.  $T_{Es} = 650^{\circ}R$ .  $kw = 25$ .  $L_D = 200$  feet.

conditions under consideration. Figures II-40 and II-41 compare the weight penalties for  $\alpha$  of 1 and 3, respectively. The general regions for least penalty of the two systems are very much alike those for the direct systems.

The gross weight penalties of indirect expanded ram-air and indirect bleed air systems are compared in Figure II-42 for various flight conditions, surface temperatures and values of the parameter  $\alpha$ . It should be observed that although the weight penalty of the indirect expanded ram-air system is frequently lower, it is not lower by a significant amount. Also, under the conditions of high altitude or low surface temperature the weight penalty is oftentimes greater than that for indirect bleed air systems. Thus, with the exception of the flight conditions for which the weight penalty of indirect ram air systems is considerably lower, the expanded ram-air system does not have a distinct advantage in gross weight penalty over the indirect bleed air system. Systems for long-range aircraft would tend to favor expanded ram-air systems for many flight conditions. Availability of bleed air for cooling purposes would appear to be a major factor in governing the use of expanded ram-air versus bleed air cooling systems.

Indirect fuel and indirect ram air cooling systems have gross weight penalties on the same order of magnitude. The weight penalty of the fuel cooling systems is always somewhat lower because of the assump-

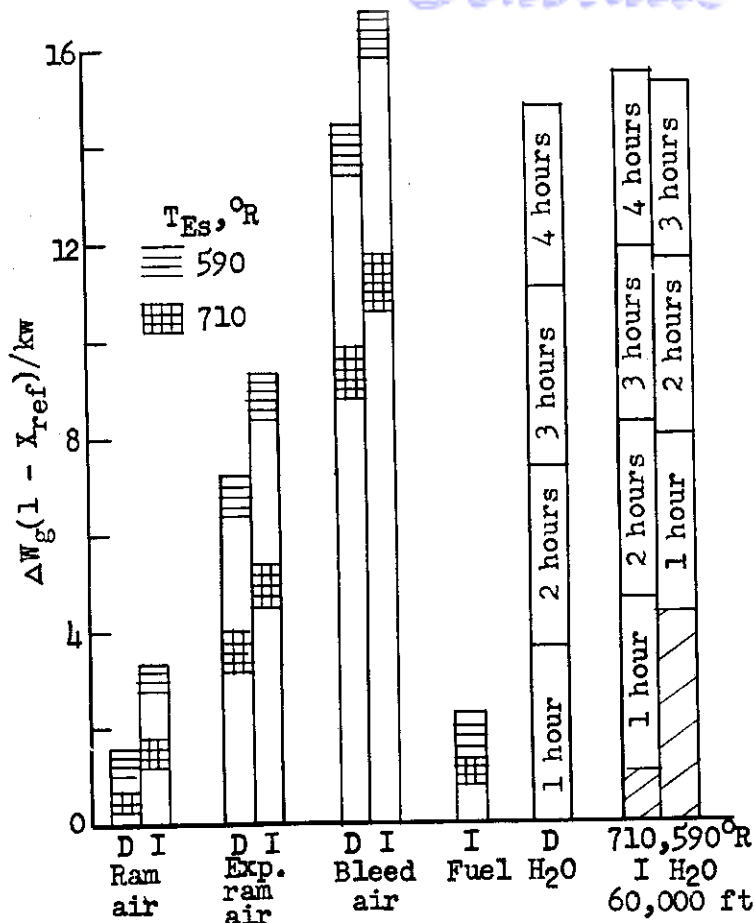

Figure II-46. Comparison of gross weight penalty for direct versus indirect systems.  $M_{\infty} = 0.9$ . Alt. = 40,000 ft.  $\alpha = 4$ .  $e_{E\text{-direct}} = 0.75$ .  $L_D = 200$  ft.

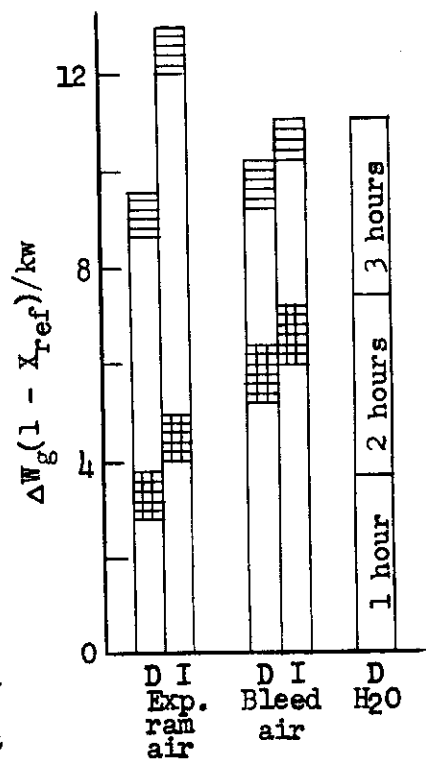

Figure II-47. Gross weight penalty of direct and indirect expanded ram-air and bleed air systems.  $M_{\infty} = 1.8$ . Alt. = 40,000 ft.  $\alpha = 2$ .  $e_{E\text{-direct}} = 0.75$ .  $L_D = 200$  ft.

tion that the equilibrium fuel temperature is defined by a recovery factor of 0.9 and because of the absence of drag for the ultimate component. Figure II-43 compares the gross weight penalty for the two systems at various flight conditions, surface temperatures and distribution component lengths. The effectiveness of heat exchange on the fuel side of the intermediate component is 80%. Lower values for this effectiveness reduce the gross weight penalty of the system but increase the fuel flow which must be by-passed through the intermediate heat exchanger. The gross weight penalty of indirect fuel systems is about 50 to 80% of that for indirect ram air systems. The equivalent operating time for the reference indirect water system is from 0 to around 1 hour.

Figures II-44 and II-45 indicate typical values of the line

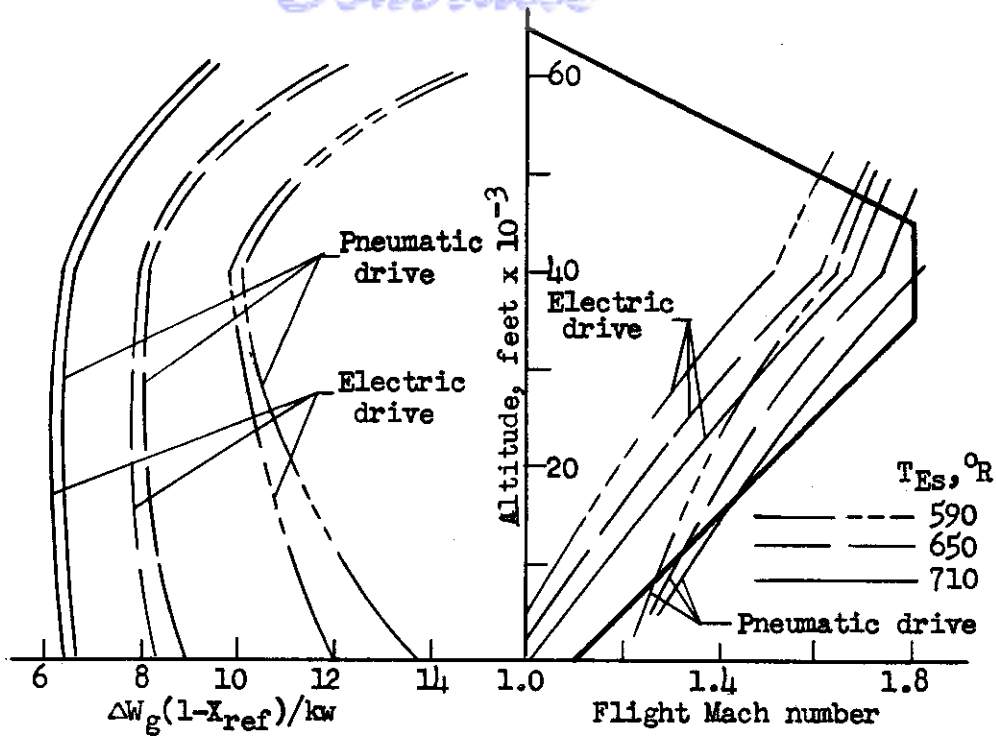

Figure II-48. Break-even gross weight penalties and flight conditions for indirect bleed air and indirect vapor cycle cooling systems with electric or pneumatic drive.  $\alpha = 2$ .  $L_D = 200$  feet.

diameter and transfer fluid flow rate in the distribution component for indirect fuel, ram air and expanded ram air systems. The surface temperature is  $650^{\circ}\text{R}$ , line length 200 feet and cooling capacity 25 kilowatts. The line diameter and flow rate vary roughly in proportion to the cooling capacity to the 0.5 and 1.0 power, respectively. For a capacity of 25 kilowatts, an internal diameter of around 0.4 inch and a flow rate of around 5 gpm are representative values for operational conditions practical for these types of cooling systems.

Gross weight penalties of several direct and indirect systems are compared in Figure II-46 for the flight condition of Mach 0.9 and 40,000 feet. The effectiveness of heat exchange for the equipment component in direct systems is 75%. The gross weight penalty of direct systems varies, for all practical purposes, in inverse proportion to the effectiveness of the equipment component. The distribution component length is 200 feet and the parameter  $\alpha$  is 4. At this flight condition the gross weight penalty of the indirect ram air system is relatively low; the equivalent operating time for the reference indirect water system never exceeds about 0.25 hour. The gross weight penalty of the indirect ram air system is greater than that for the direct system by a ratio of from 2 to 3, although the absolute increase in the gross weight parameter is only about 1.0 to 1.5 pounds per kilowatt. The weight penalty of indirect expanded ram-air and bleed air systems is greater than the direct system weight penalty by about 15 and 30%.

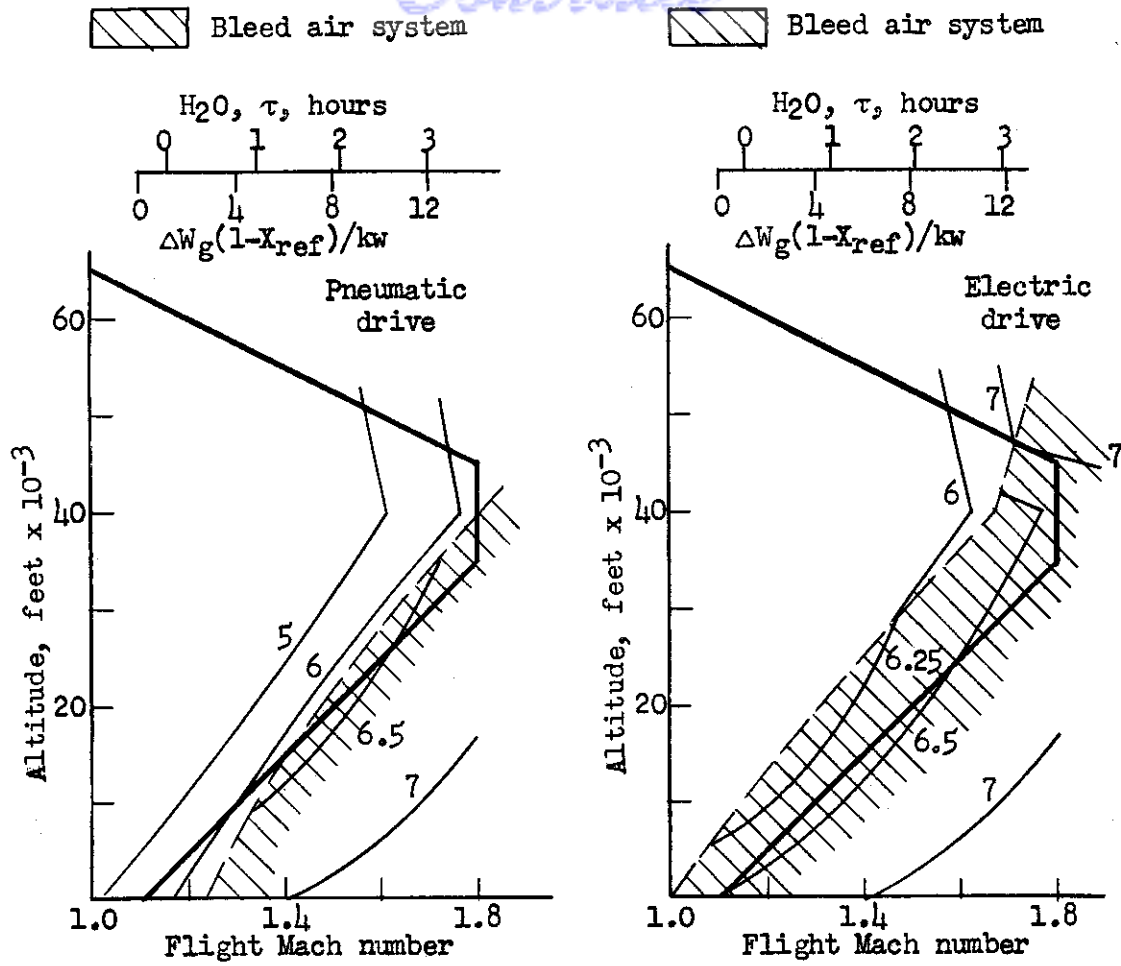

Figure II-49. Gross weight penalty of indirect bleed air versus indirect vapor cycle cooling systems with electric or pneumatic drive.  
 $T_{Es} = 710^{\circ}R$ .  $\alpha = 2$ .  $L_D = 200$  feet.

Gross weight penalties for direct and indirect expanded ram-air and bleed air systems for the flight condition Mach 1.8 and 40,000 feet are presented in Figure II-47. The aircraft parameter  $\alpha$ , distribution component length  $L_D$  and equipment component effectiveness  $e_E$  for the direct systems are 2, 200 feet and 75%, respectively. The indirect weight penalties are from 10 to 40% greater than those for the direct systems; for an effectiveness of 90% for direct systems, the indirect weight penalties would be from 25 to 60% greater. The equivalent flight time for the reference indirect water system is from about 1 to 2 hours.

Figure II-48 is a presentation of the break-even flight conditions and gross weight penalty of indirect vapor cycle refrigeration systems with pneumatic and electric drive versus indirect bleed air cooling systems. At flight conditions to the right of each of the various equal-penalty lines shown in the altitude-Mach number plot the penalty of bleed air systems would be least. For equipment temperatures in the range from

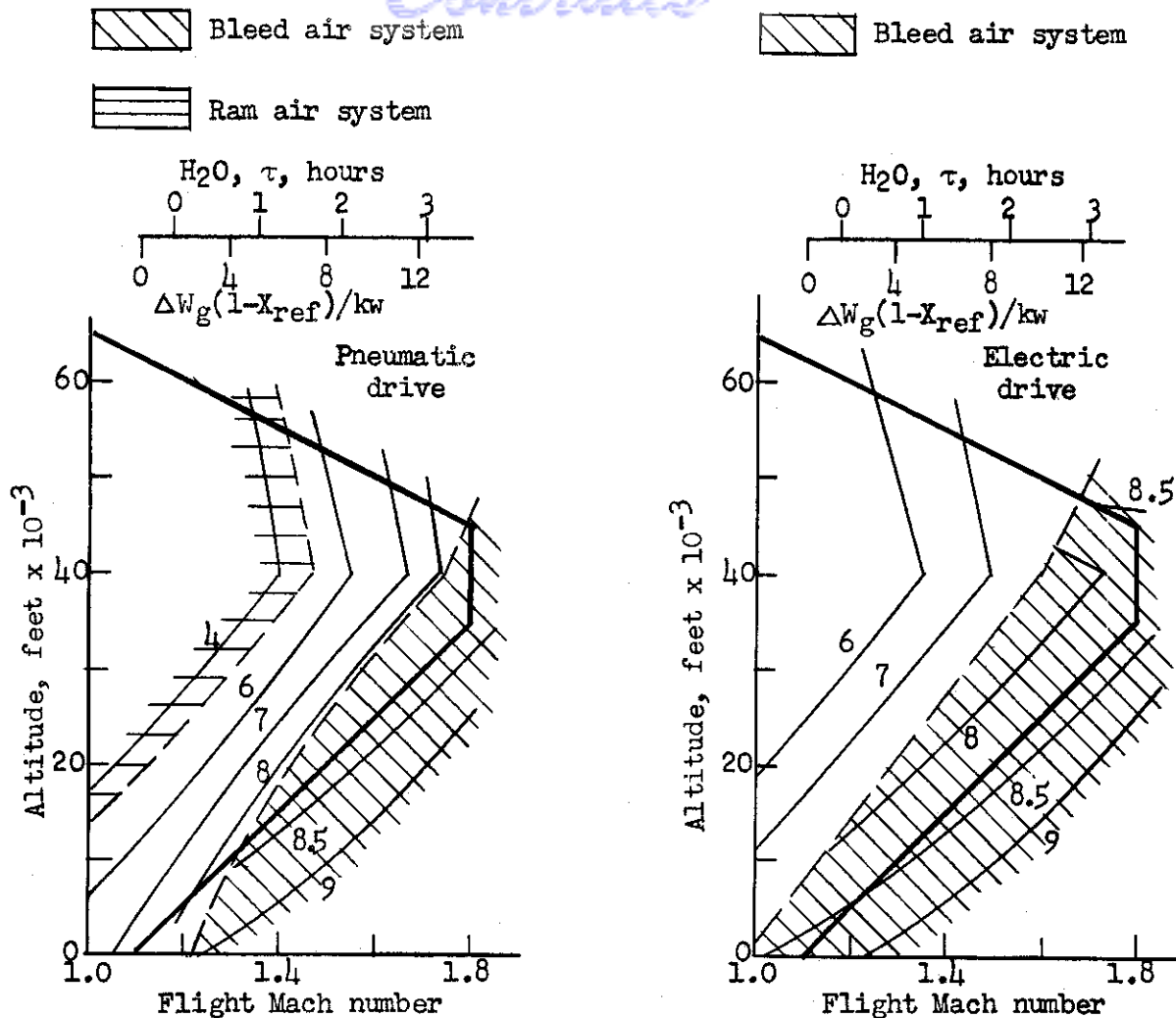

Figure II-50. Gross weight penalty of indirect bleed air versus indirect vapor cycle cooling systems with electric or pneumatic drive.

$T_{Es} = 650^{\circ}R$ .  $\alpha = 2$ .  $L_D = 200$  feet.

590° to 710°R, vapor cycle systems with electric drive tend to break even with bleed air systems at flight conditions corresponding to system temperature potentials, i.e., the difference between equipment component and total ram air temperature, between -50° to +25°F at 50,000 feet altitude, -22° to +50°F at 40,000 feet, and -53° to +47°F at 10,000 feet. The corresponding temperature potentials for the vapor cycle system with pneumatic drive are -80° to -20°, -88° to +10°, and -105° to 0°F. For supersonic flight speeds of major importance, i.e., between Mach 1.5 and 1.8, in the altitude range between 35,000 and 55,000 feet the electric drive systems have a smaller penalty over a small portion of the lower end of the speed range when the equipment temperature is 710°R. In this operating range, pneumatic drive systems have a smaller penalty than bleed air systems for equipment temperatures of 590°R, but mainly at altitudes above 40,000 feet. At an equipment temperature of 710°R, pneumatic drive

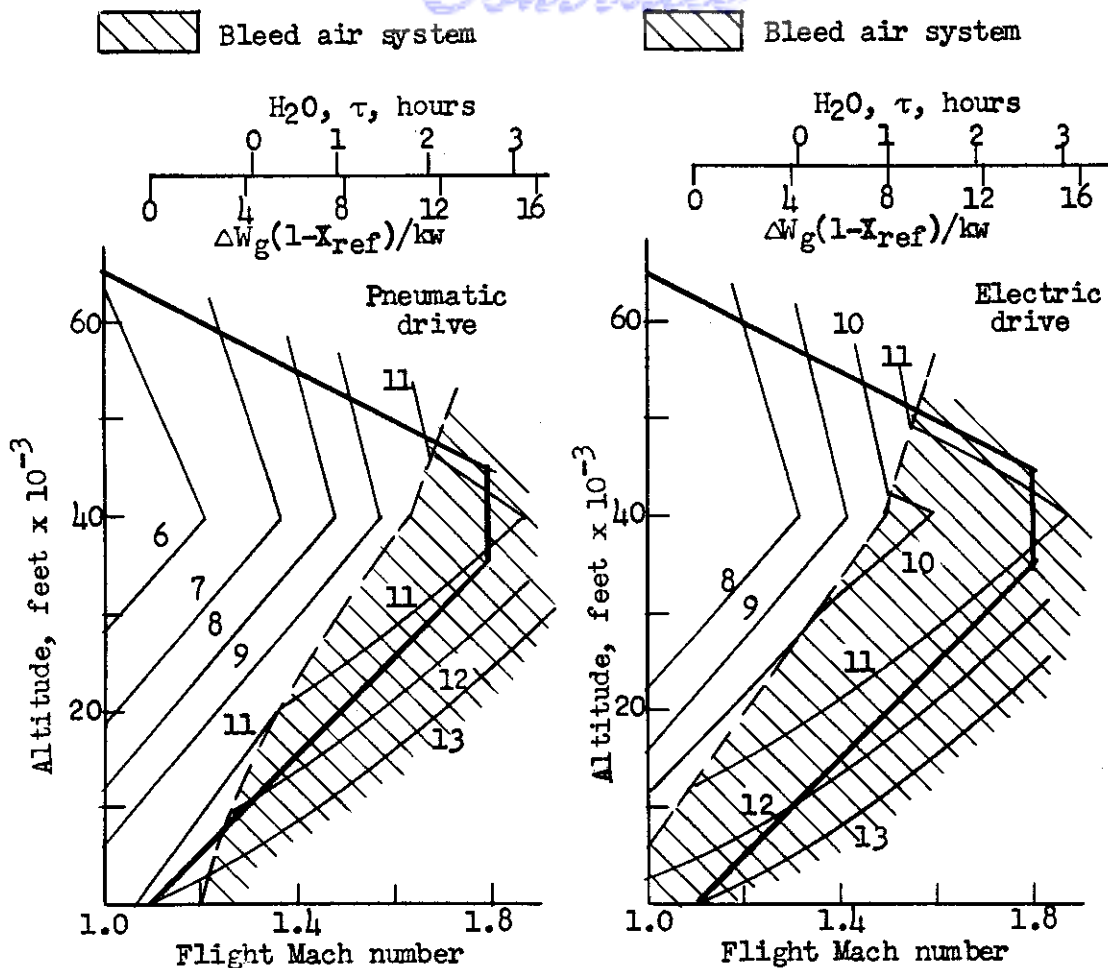

Figure II-51. Gross weight penalty of indirect bleed air versus indirect vapor cycle cooling systems with electric or pneumatic drive.  
 $T_{Es} = 590^{\circ}R$ .  $\alpha = 2$ .  $L_D = 200$  feet.

systems have a smaller penalty over practically the entire flight range. Break-even values of the gross weight parameter  $W_g(1-X_{ref})/kw$  vary from 6 to 14 pounds per kilowatt for equipment temperatures from  $710^{\circ}$  to  $590^{\circ}R$ .

Figures II-49, II-50 and II-51 present comparisons of the gross weight penalty for the same systems as Figure II-48 for equipment temperatures of  $590^{\circ}$ ,  $650^{\circ}$  and  $710^{\circ}R$ , respectively, for 200 feet distribution component line length, aircraft parameter  $\alpha$  equal to 2, and equipment component effectivenesses of 90% or higher. In general, the break-even lines for the systems with electric drive occur at flight Mach numbers lower by about 0.2 than those for the systems with pneumatic drive. This shows the penalties of electric-drive systems to be generally higher than of bleed air systems in the most important ranges of supersonic flight speeds and altitudes. For  $710^{\circ}R$ -equipment pneumatic drive systems are in the flight range under consideration superior



# Contrails

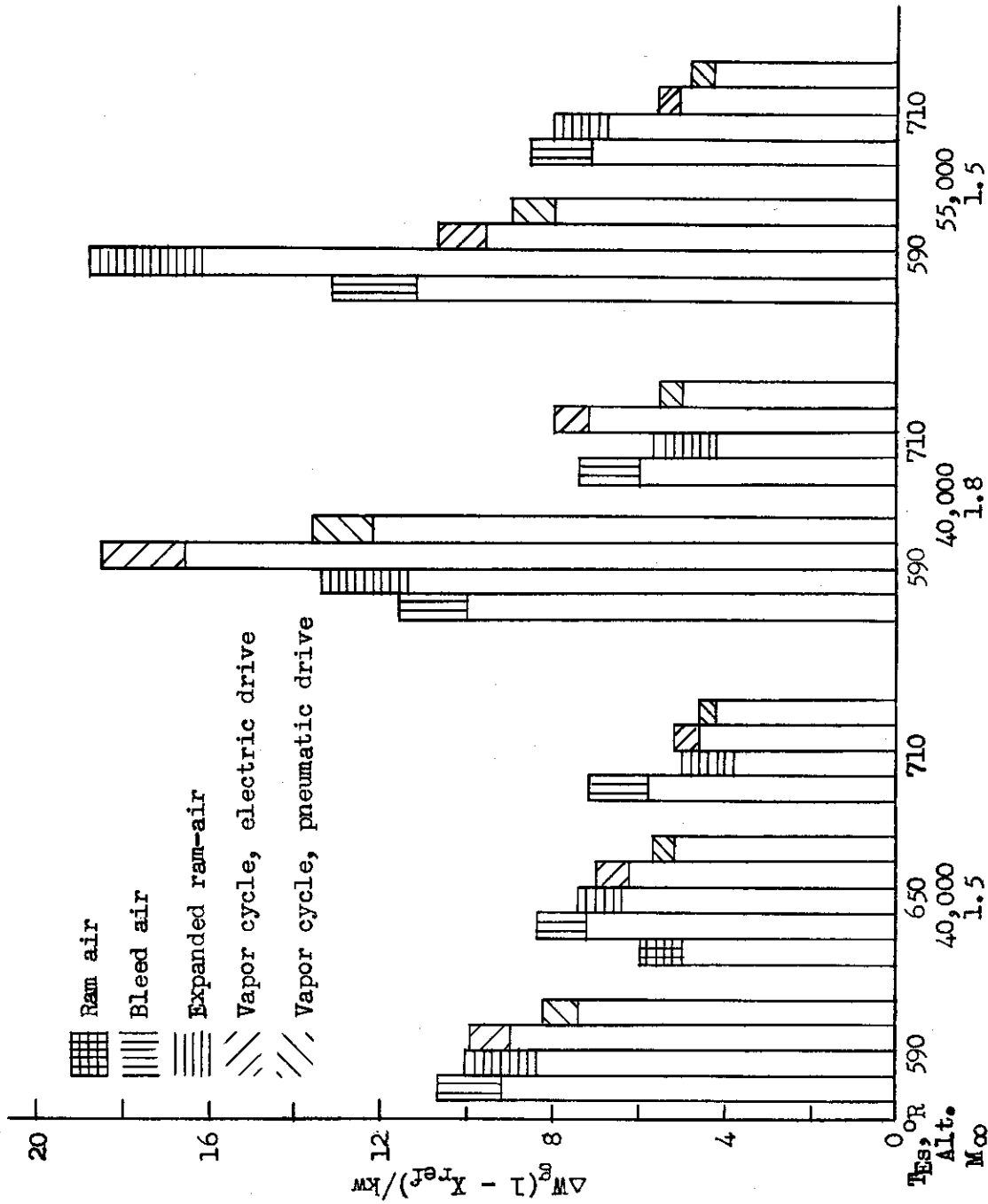

Figure II-52. Comparison of the gross weight penalty of indirect vapor cycle systems with electric or pneumatic drive with indirect ram air, bleed air and expanded ram-air systems.  $\alpha = 2$ .  $L_D = 200$  feet.

# Contrails

to bleed air systems, but not to the expanded ram air systems. For 650°R equipment, the range of superiority of pneumatic-drive vapor cycle systems is reduced to somewhat lower flight speeds. They have an area of least penalty between simple ram air systems and bleed air systems at flight speeds greater than Mach 1.45 at altitudes above 40,000 feet and at lower altitudes at decreasing flight speed in a range of Mach numbers differing by about 0.3. However, in this general region of flight conditions, which is probably of minor significance, expanded ram air systems have lower penalty. For 590°R equipment, the pneumatic-drive vapor cycle systems have lower penalty above 40,000 feet altitude at flight speeds lower than Mach 1.65 and lower altitudes at still lower flight speeds decreasing to Mach 1.2 at sea level. For these ranges of conditions expanded ram-air systems have greater penalty and there would be a band of Mach numbers differing by about 0.4 where the vapor cycle system with pneumatic drive would have a lower penalty than either the bleed air or the simple ram air system. At the conditions of equal penalty for pneumatic-drive vapor cycle and bleed air systems the operating times of the reference water system range, in general, from 1.4 to 1.8 hours.

The gross weight penalties of indirect ram air, expanded ram-air, bleed air, pneumatic-drive vapor cycle and electric-drive vapor cycle cooling systems are compared in Figure II-52 for three supersonic flight conditions of principal importance. The probable maximum and minimum values shown for the vapor cycle systems are based on the assumption that compressor power requirements have been evaluated conservatively and that sufficient improvement in efficiency and development of more suitable refrigerants would be possible to reduce the calculated penalties by 10%. At high altitude and Mach 1.5 the vapor cycle systems show decided superiority over both bleed air and expanded ram-air systems in the entire temperature range. At the lower altitude of 40,000 feet and Mach 1.5 some superiority of pneumatic-drive vapor cycle systems is indicated at the lowest temperature only. However, bleed air systems, the principal competitors from the practical development standpoint, have generally higher penalty. This is also the case at Mach 1.8 and 710°R equipment temperature, but not at 590°R.

In Figures II-53, II-54 and II-55 are presented three charts which permit the comparison of operating time of expendable cooling systems of optimum type and coolant selection with two other indirect types of cooling systems of apparent superiority for supersonic flight speed at one equipment temperature of 710°, 650° and 590°R, respectively. For specified flight speed and altitude the gross weight parameter of the reference system is shown which, at the same altitude, will correspond to a certain operating time of an expendable system. In Figures II-53 and II-54 the optimum expendable systems are indirect water systems and direct water-methanol systems with distribution components, the latter applicable at altitudes below the dotted line. In Figure II-55 the indirect water expendable system has a small range of applicability at operating times longer than 2 hours and altitudes above 60,000 feet. Down to an altitude of 34,000 feet the direct water-methanol system is superior and the gross weight parameter values given at lower altitudes

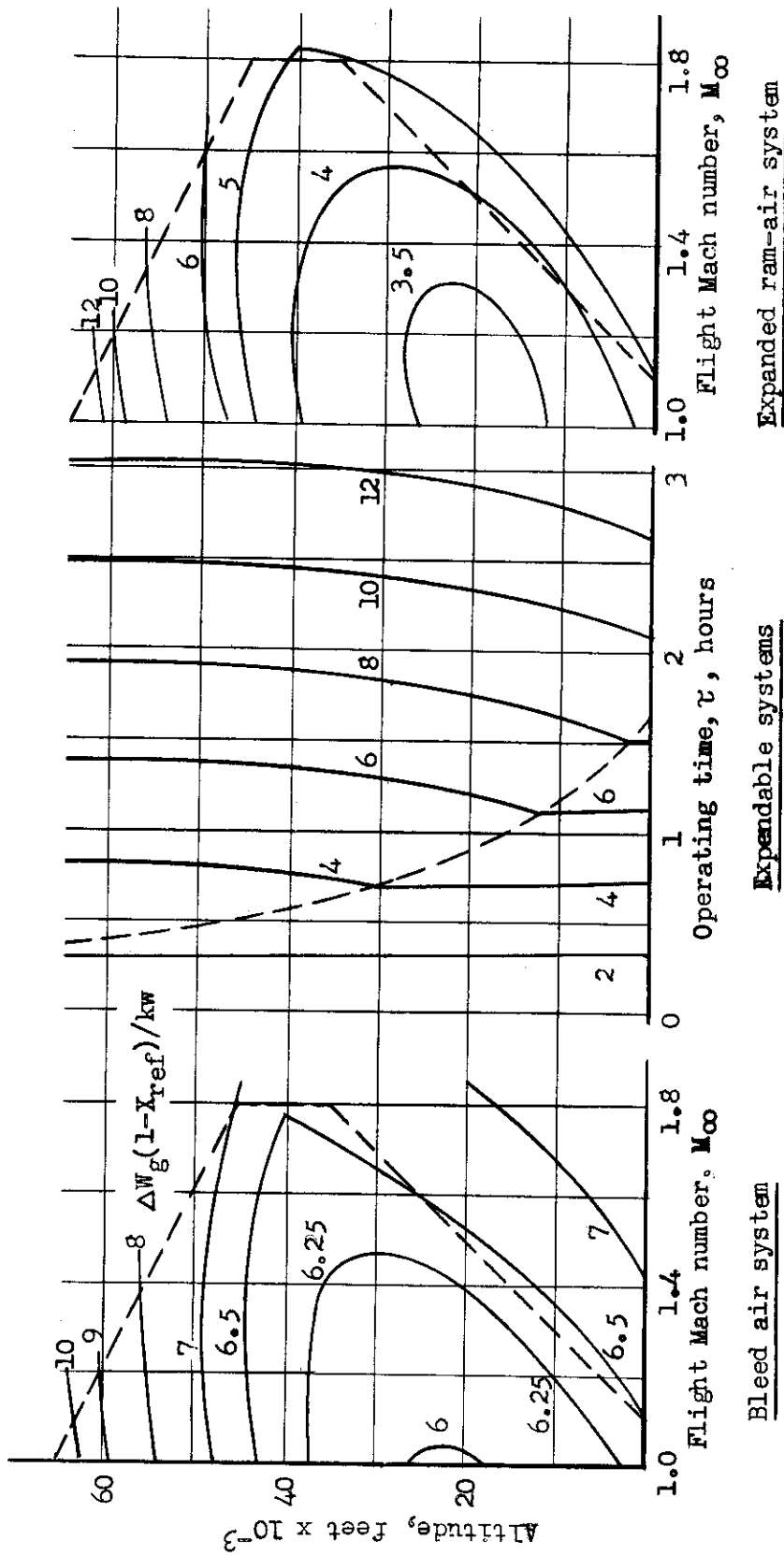

Figure II-53. Chart for determination of operating time of optimum indirect and direct expendable cooling systems with distribution component imposing at specific supersonic flight conditions the same gross weight penalty as indirect bleed air or indirect expanded ram-air systems.  $T_{Es} = 710^{\circ}R$ ,  $\alpha = 2$ ,  $L_D = 200$  feet.

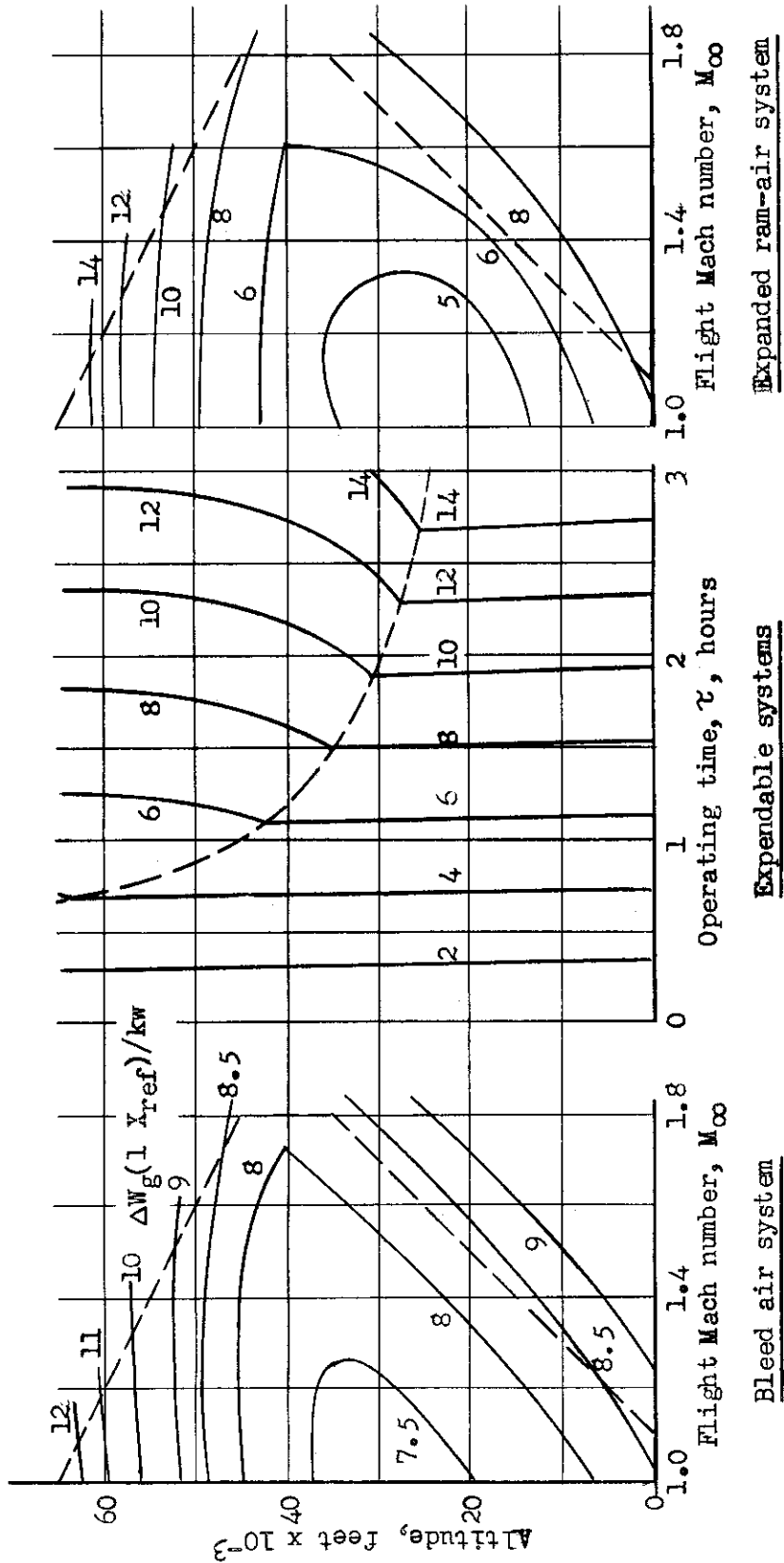

Figure II-54. Chart for determination of operating time of optimum indirect and direct expendable cooling systems with distribution component imposing at specific supersonic flight conditions the same gross weight penalty as indirect bleed air or indirect expanded ram-air systems.  $T_{Es} = 650^{\circ}R$ .  $\alpha = 2$ .  $L_D = 200$  feet.

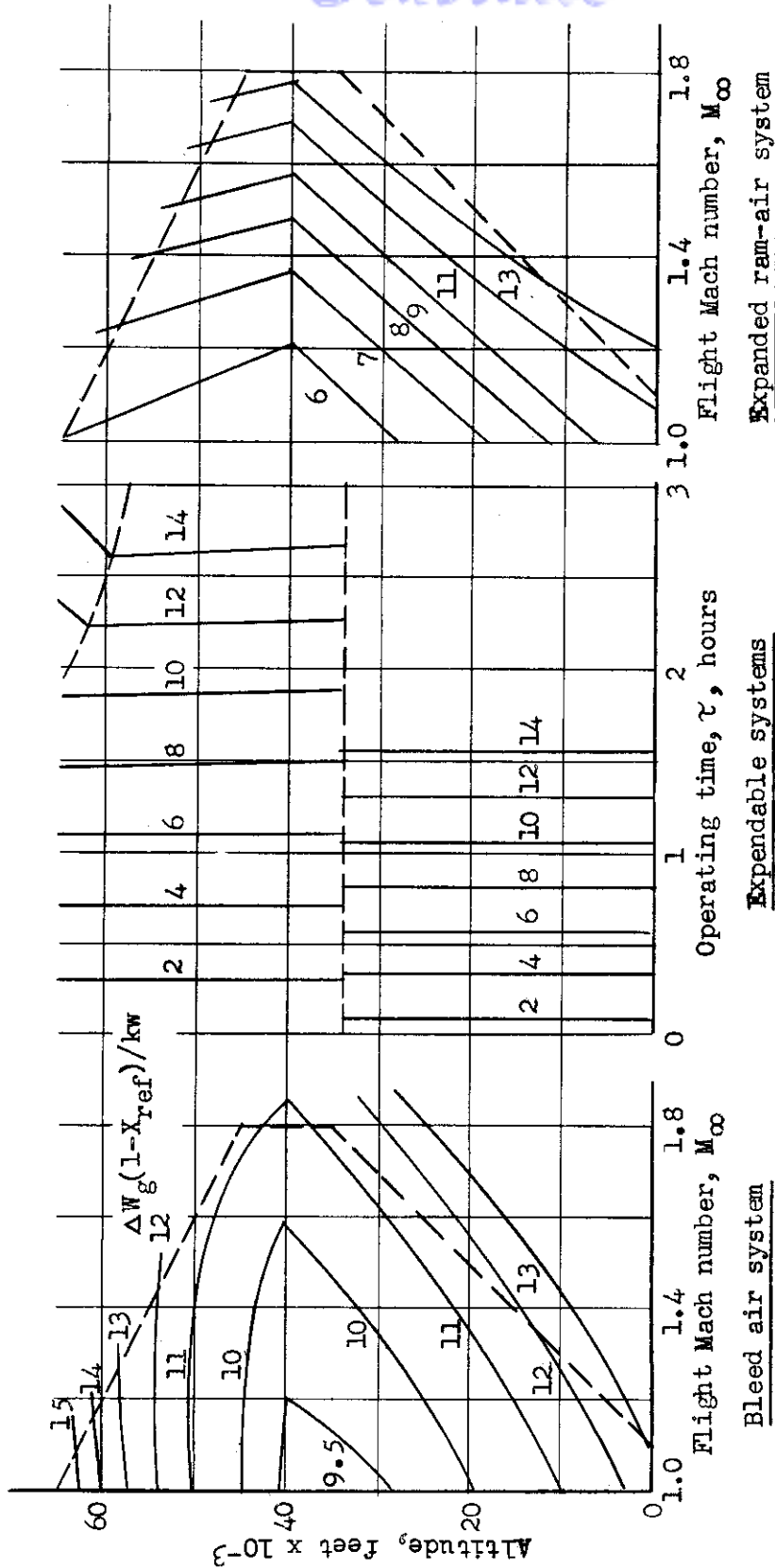

Figure II-55. Chart for determination of operating time of optimum indirect and direct expendable cooling systems with distribution component imposing at specific supersonic flight conditions the same gross weight penalty as indirect bleed air or indirect pneumatic-drive vapor cycle refrigeration systems.  $T_{Es} = 590^{\circ}R$ ,  $\alpha = 2$ ,  $L_D = 200$  feet.

# Conclusions

correspond to the indirect ammonia system which would probably be most practical for this range of operating conditions and preferable to direct ammonia or methanol systems with distribution components because of appreciable reduction in hazard. For example, at 55,000 feet and Mach 1.5 corresponding to equipment temperatures of  $710^{\circ}$ ,  $650^{\circ}$  and  $590^{\circ}\text{R}$  and compared to the bleed air system operating times of equal penalty are found as 1.85, 2.25 and 2.3 hours, respectively. Analogous values for 40,000 feet and Mach 1.8 are: 1.55, 1.7 and 1.5 hours, and for 20,000 feet and Mach 1.5: 1.35, 1.6 and 1.25 hours. All these break-even times represent appreciable endurance at these supersonic flight speeds and exceed greatly 1 hour even at the lowest altitude and equipment temperature which require the use of ammonia. The expanded ram-air system compares more favorably for equipment temperatures of  $710^{\circ}$  and  $650^{\circ}\text{R}$  at 20,000 feet altitude and Mach 1.5, the corresponding operating times being: 0.7 and 1.25 hours. The comparative plots show that the highly competitive position of expendable cooling systems is not limited to operating conditions where water with its high latent heat can be used as coolant.

## Conclusions

For cooling of equipment items in the temperature range of  $130^{\circ}$  to  $250^{\circ}\text{F}$  and for steady state thermal conditions, ram air cooling systems appear superior to all other types investigated in this study for the flight Mach number range of 0.5 to 1.0 and altitudes from around 15,000 to 65,000 feet. For aircraft designed for short duration flights at high altitudes and Mach numbers less than 1.5 expendable cooling systems may be preferable to ram air systems from the viewpoint of spatial requirements for the cooling system. For steady-state cooling of low-temperature equipment items at altitudes below about 15,000 feet and high subsonic flight Mach numbers, ram air systems would appear to yield to cooling systems of the bleed air or expendable type. Practical limitations on the use of ram air cooling systems appear to be defined by (1) a minimum system temperature potential of around  $50^{\circ}\text{F}$ , (2) availability of space and (3) the necessity of ground cooling without the use of auxiliary equipment. Indirect ram air cooling systems employing thrust recovery and a distribution component length of 200 feet have, in general, lower gross weight penalty than one or a number of direct systems operating without thrust recovery. The indirect ram air system having an integrated expendable cooling system appears practical for equipment cooling in aircraft operating on a cruise-dash-cruise basis.

Expanded ram-air cooling systems appear to yield to ram air cooling systems at subsonic flight speeds. For flight speeds from Mach 1.5 to 1.8, the gross weight penalty of expanded ram-air systems is sometimes greater and never appreciably below that of bleed air cooling systems. The greatest advantage in weight penalty of the expanded ram-air system over other systems occurs in the Mach number range 1.0 to 1.5 and altitudes below about 45,000 feet. Thus, considering the generally contemplated problems of control of the turbine-compressor unit, the greatest single factor is establishing the use of expanded ram-air versus

# Contrails

bleed air cooling systems probably will be the availability of bleed air.

Bleed air cooling systems, assuming bleed air for cooling purposes is available and considering the developed state of this type of cooling system, appear most favorable of the air systems investigated for flight Mach numbers around 1.8. The use of bleed air systems for cooling at Mach 1.8 to 2 appear to be in direct competition with expendable and vapor cycle cooling systems.

Blower cooling systems have no distinct advantages over ram air systems, even when installed in ventilated compartments, unless there exists the need for spot cooling at locations remote to an aircraft cooling system, or when equipment items must be cooled in very low speed aircraft and ground cooling without the use of auxiliary equipment is important.

The use of fuel for steady-state cooling of equipment items appears to have no significant advantage over indirect ram air cooling systems, except from the viewpoint of spatial requirements.

Vapor cycle cooling systems with electric drive appear to be too heavy to warrant serious consideration. Vapor cycle cooling systems with pneumatic drive are superior to all other systems investigated at supersonic flight speeds greater than Mach 1.5 and altitudes above 40,000 feet. The expanded ram-air cooling system appears to be the principal competitor at lower altitudes, except at equipment temperatures near 590°R, or lower, where bleed air systems have slightly lower penalty over a portion of the higher flight speed range. The superiority of bleed air systems would be overcome by regenerative vapor cycle systems of optimized design. The developmental and control problems of expanded ram-air systems appear to be more severe so that for applications with wide range of operating conditions vapor cycle systems should warrant serious consideration in all supersonic applications, particularly where the availability of bleed air is limited. In their best ranges of application vapor cycle systems are superior to expendable cooling systems mainly for operating times longer than 2 hours. The distribution of refrigerant to dispersed equipment items, introducing the problem of reduced reliability, but no more vulnerability than a liquid transfer fluid distribution system, should reduce system penalty to that of indirect expanded ram-air cooling systems. Development of a refrigerant having a higher coefficient of performance than Freon-11 in the temperature range of 200° to 300°F should make the penalty of vapor cycle systems of suitable cycle arrangement smaller than that of systems in which the thermal state of atmospheric air is modified.

Expendable cooling systems are generally superior to other cooling systems studied under conditions of supersonic flight for operating times less than 1-1/2 hours. At altitudes above 50,000 feet the superiority of expendable systems extends to operating times of up to 2-1/2 hours. The competitive position of expendable systems is not limited to flight conditions and equipment temperatures where water is a useable ultimate

# Contrails

coolant in indirect systems. Direct systems using a water-methanol mixture of  $-65^{\circ}\text{F}$  freezing point supplied from a pressurized source to dispersed equipments operating as forced-flow dry evaporators are superior to indirect water systems over a major range of operating conditions. Indirect systems with ammonia as ultimate coolant must be used at altitudes below 34,000 feet for 590 R-equipment and are competitive at supersonic flight speeds and low altitude for flight times on the order of 1 hour but are limited by availability of space. Central location of the intermediate component and coolant storage in serving dispersed equipment items with an indirect water system appreciably reduces system penalty. Flexibility in location of coolant storage justifies consideration of individualized expendable cooling systems for dispersed equipment items under flight conditions in which other systems have lower penalty. For supersonic aircraft operation at speeds greater than Mach 1.5 expendable cooling systems deserve first consideration in the selection of a cooling system not only from the standpoint of penalty but also because of great freedom in location within the aircraft and independence from the powerplant.

The use of an indirect system, i.e., one employing an intermediate and distribution component, appears to represent a compact and economical method of cooling widely dispersed or groups of equipment items. Line diameters would be in the range from about 0.2 to 1.0 inch, transfer fluid flow rates in the range from about 2 to 10 gpm for each 10 kilowatts cooling capacity and transfer fluid pressure drops on the order of 50 to 200 psi.