

FOREWORD

This work was conducted by the National Carbon Company, a Division of Union Carbide Corporation, under USAF Contract AF 33(616)-6915. This contract was initiated under Project No. 7350 "Refractory Inorganic Non-Metallic Materials", Task No. 735002 "Graphite Materials Development"; Project No. 7381 "Materials Application", Task No. 738102 "Materials Preproduction Process Development"; and Project No. 7-817 "Process Development for Graphite Materials". The work was administered under the direction of the Directorate of Materials and Processes, Deputy Commander/Technology, Aeronautical Systems Division, with Captain R. H. Wilson, L. J. Conlon and W. P. Conrardy acting as Project Engineers.

The work covered in this report was performed between November 1960, and November 1962, primarily by the Armour Research Foundation of Illinois Institute of Technology, Chicago, Illinois, under Subcontract No. 1960-R2 from National Carbon Company. Some materials and direction of the program were supplied by the Research Laboratory of National Carbon Company, Parma 30, Ohio.

Prior reports issued under USAF Contract AF 33(616)-6915 have included:

WADD Technical Notes 61-18 and 61-18, Part II, progress reports covering work from the start of the Contract on May 1, 1960, to October 15, 1961, and the following volumes of WADD Technical Report 61-72 covering various subject phases of the work:

- Volume I Observations by Electron Microscopy of Dislocations in Graphite, by R. Sprague.
- Volume II Applications of Anisotropic Elastic Continuum Theory to Dislocations in Graphite, by G. B. Spence.
- Volume III Decoration of Dislocations and Low Angle Grain Boundaries in Graphite Single Crystals, by R. Bacon and R. Sprague.
- Volume IV Adaptation of Radiographic Principles to the Quality Control of Graphite, by R. W. Wallouch.
- Volume V Analysis of Creep and Recovery Curves for ATJ Graphite, by E. J. Seldin and R. N. Draper.
- Volume VI Creep of Carbons and Graphites in Flexure at High Temperatures, by E. J. Seldin.
- Volume VII High Density Recrystallized Graphite by Hot Forming, by E. A. Neel, A. A. Kellar, and K. J. Zeitsch.
- Volume VIII Electron Spin Resonance in Polycrystalline Graphite, by L. S. Singer and G. Wagoner.

Contrails

- Volume IX Fabrication and Properties of Carbonized Cloth Composites, by W. C. Beasley and E. L. Piper.
- Volume X Thermal Reactivity of Aromatic Hydrocarbons, by I. C. Lewis and T. Edstrom.
- Volume XI Characterization of Binders Used in the Fabrication of Graphite Bodies, by E. de Ruiter, A. Halleux, V. Sandor and H. Tschamler.
- Volume XII Development of an Improved Large Diameter Fine Grain Graphite for Aerospace Applications, by C. W. Waters and E. L. Piper.
- Volume XIII Development of a Fine-Grain Isotropic Graphite for Structural and Substrate Applications, by R. A. Howard and E. L. Piper.
- Volume XIV Study of High-Temperature Tensile Properties of ZTA Grade Graphite, by R. M. Hale and W. M. Fassell, Jr.

ABSTRACT

Because alumina-condensed furfuryl alcohol resins offer several advantages over analogous acid-condensed resins, the work described in this report has been directed toward gaining a more complete understanding of their physical and chemical properties, both prior to and during thermosetting and pyrolysis. The work also includes a study of the interactions of the resin when used as a binder with certain filler materials.

Equipment and methods used in preparing resins of different viscosities are briefly discussed as is the equipment used in making the necessary analyses.

In the discussion of results, data obtained from fractional distillation, gas chromatography, differential thermal analysis, thermogravimetric analysis, X-ray studies, shrinkage measurements, and dynamic elastic modulus measurements are presented, interpreted and correlated. Also included is information on the use of low viscosity resin as an impregnant, resin modifications, cured resin yield, and microstructures.

This report has been reviewed and is approved.

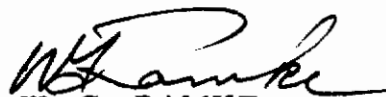

W. G. RAMKE

Chief, Ceramics and Graphite Branch
Metals and Ceramics Laboratory
Directorate of Materials and Processes

TABLE OF CONTENTS

	PAGE
1. INTRODUCTION	1
2. SUMMARY AND CONCLUSIONS	1
3. EXPERIMENTAL APPARATUS AND PROCEDURES . . .	2
3.1. Preparation of Furfuryl Alcohol Resins by Alumina Condensation	2
3.1.1. High-Viscosity Resins	2
3.1.2. Low-Viscosity Resins	2
3.2. Resin Composition.	3
3.3. Pyrolysis Studies by Gas Chromatography	3
3.4. Differential Thermal Analysis	7
3.5. Shrinkage Characteristics.	7
3.6. Dynamic Elastic Properties.	9
3.7. X-Ray Studies	9
4. RESULTS AND DISCUSSION	11
4.1. Preparation of Furfuryl Alcohol Resins by Alumina Condensation	11
4.2. Composition of Low-Viscosity Resins	15
4.3. Resin Derivatives as Impregnants	26
4.4. Resin Modifications	32
4.5. Pyrolysis Studies of Furfuryl Alcohol Resins by Gas Chromatography.	32
4.6. Differential Thermal Analysis	43
4.7. Cured Resin Yields	46
4.8. Thermogravimetric Analysis	48
4.9. Shrinkage Characteristics.	48

TABLE OF CONTENTS (cont'd.)

	PAGE
4.10. Microstructure	48
4.11. Dynamic Elastic Properties	52
4.12. X-Ray Diffraction Studies	52
5. REFERENCES	60
6. APPENDIX - STRUCTURAL FORMULAS OF FURFURYL ALCOHOL RESIN COMPONENTS	61

LIST OF ILLUSTRATIONS

FIGURE		PAGE
1	Schematic Diagram of Pyrolysis Furnace and Chamber	4
2	Schematic Diagram of Pyrolysis Chamber Used for Collection of Products for Analysis by Mass Spectrometry	5
3	Dynamic Modulus Apparatus	10
4	High Viscosity Polymer vs. Temperature	12
5	14.5 per cent Resin - Viscosity vs. Temperature.	14
6	Infrared Absorption Spectrum of Low Viscosity Furfuryl Alcohol Resin (13 per cent Water of Condensation) - Fraction 2, Boiling Point 86° - 88° C at 2.1-2.2 mm Hg	16
7	Infrared Absorption Spectrum of Difurfuryl Ether. Modified Zanetti Method.	18
8	Infrared Absorption Spectrum of Difurfuryl Ether. Nielsen's Method	19
9	Infrared Absorption Spectrum of Esters of 5-Furfurylfurfuryl Alcohol.	20
10	Infrared Absorption Spectrum of 5-Furfurylfurfuryl Alcohol	21
11	Mixture of Levulinic Acid and Homologues	22
12	Infrared Absorption Spectrum of Furan	23
13	Infrared Absorption Spectrum of Furfuryl Alcohol	24
14	Infrared Absorption Spectrum of Low Viscosity Furfuryl Alcohol Resin (13 per cent water of Condensation).	25
15	Furfuryl Alcohol Resin Distillate Viscosity at 25° C vs. Time for Catalyzed Samples	27
16	Furfuryl Alcohol Resin Distillate Viscosity at 20° C vs. Time for Catalyzed Samples	28

LIST OF ILLUSTRATIONS (cont'd.)

FIGURE		PAGE
17	Furfuryl Alcohol Resin Distillate, Catalyzed with 0.5 per cent Methyl p-toluenesulfonate. Viscosity vs. Time at 50°, 65° and 75°C	30
18	Equal Mixtures of Furfuryl Alcohol Resin (257 cps), and Resin Distillate (4.75 cps), Catalyzed with 0.5 per cent Methyl p-toluenesulfonate. Viscosity vs. Time at 50° and 60°C	31
19	Elution Profiles of Pyrolysis Products from Alumina Condensed Resin	35
20	Elution Profiles of Pyrolysis Products from Alumina Condensed Resins Containing 80.7 per cent Alumina Filler	36
21	Elution Profiles of Pyrolysis Products from Alumina Condensed Resin Containing 60 per cent Petroleum Coke Filler (Resin No. 3)	37
22	Composite of Elution Profiles of Pyrolysis Products from Resin 1 (bottom), 2 (middle), and 3 (top) Exhibiting Less than 0.24×10^{-8} m mol of Product per Degree	38
23	DTA Trace of Alumina Condensed F. A. Polymer 850 cps, 13 per cent H ₂ O Removed	44
24	DTA Trace of Alumina Condensed F. A. Polymer 8150 cps, 15.2 per cent H ₂ O Removed	45
25	Composite DTA Trace of Quaker Oats "Monomer-Free" Furfuryl Alcohol Polymer, 1 per cent Toluene Sulfonic Acid	47
26	Thermogravimetric Analysis of Alumina Condensed Resins of Medium and High Conversion	49
27	Change in Length of Alumina Condensed Polymer During Pyrolysis. 850 cps, 13 per cent H ₂ O Removed	50
28	Photomicrograph of F. A. Polymer Coked to 1000° C Showing Macrofissures and "Glassy" Appearance of Interfissure Coke Reflected Light, X50	51

LIST OF ILLUSTRATIONS (cont'd.)

FIGURE		PAGE
29	General Elastic Properties of Coke Filled Resin During Pyrolysis	53
30	General Elastic Properties of Alumina Filled Resin During Pyrolysis	54
31	Flat Cassette Transmission Photograph of Molded Sample. (100 parts petroleum coke, 55.4 parts resin coke).	56
32	Flat Cassette Transmission Photograph of Physical Mixture of Petroleum and Resin Cokes (100 parts petroleum coke, 55.4 parts resin coke).	57
33	Flat Cassette Transmission Photograph of Resin Coke (100 per cent).	58
34	Flat Cassette Transmission Photograph of Petroleum Coke (100 per cent)	59

LIST OF TABLES

TABLE		
1	Conditions Used for Analysis of Gaseous Pyrolytic Products	8
2	Gaseous Products from the Thermal Decomposition of Furfuryl Alcohol Polymer	33
3	Results of Analysis of Furfuryl Alcohol Resin and Aluminum Oxide Resin Mixture by Mass Spectrometry	40
4	Distribution of Pyrolysis Products Based on Weight Per Cent of Total Weight Loss of Each Polymer	41

1. INTRODUCTION

Furfuryl alcohol and resins derived therefrom have attracted the attention of a number of investigators, both in the United States and abroad, as a binder for making carbon and graphite. During the course of previous binder investigations, (Ref. 1) it came to our attention that resins, which were completely polymerized, reproducible, and storage stable, could be produced from furfuryl alcohol by catalytic condensation employing activated alumina. (Ref. 2)

The principal purpose of this investigation has been to arrive at a detailed understanding of the chemical and physical properties of this alumina-condensed resin in the liquid, thermoset, and pyrolyzed states, both by itself and in combination with inert and active fillers.

2. SUMMARY AND CONCLUSIONS

Furfuryl alcohol resins of extremely high polymeric conversion and having viscosities ranging from 200 to 300,000 cps have been produced by alumina condensation. Conversion for the low viscosity material is in excess of 95 per cent and for the medium to high viscosity material (5000-300,000 cps) is virtually 100 per cent. Liquid condensation of the resins has been carried to a point where thermosetting is accomplished essentially by addition polymerization and crosslinking.

The composition of the resins, although complicated, appears to consist of various esters of polyfurfuryl alcohol together with appreciable amounts of difurfuryl ether. For all practical purposes, OH groups are absent.

The pyrolysis sequence consists of three basic steps. The first step involves dehydration and decarboxylation in the temperature range from 150° to 350° C; the second step involves carbon-carbon scission with the formation of free radicals which, by disproportionation, produce a series of low molecular hydrocarbons over a temperature range of 375°-600° C. The third step involves dehydrogenation which increases abruptly above 600° C. However, interpretation of the pyrolysis mechanism is difficult because degradation products, such as formaldehyde, may be reabsorbed by the base polymer to act as crosslinking agents and because further resin polymerization can be accomplished during pyrolysis. In addition, there is probably some overlap in the three basic steps.

In studying the use of the alumina-condensed resin as a binder, mixtures were prepared with both alumina and petroleum coke as the filler. It was found that at least certain types of fillers can have an appreciable effect upon the thermal degradation of the base resin. Use of gas chromatography as an analytical tool, was found to offer a convenient

Manuscript released by the authors November 1962 for publication as a WADD Technical Report.

way of observing filler-related changes in decomposition of the binder.

X-ray evidence indicates that a highly crosslinked coke, such as is derived from the resin, has a greater tendency to graphitize when used as a binder in conjunction with petroleum coke than when graphitized alone.

On the basis of stability, viscosity, thermosetting yield, and coking yield, alumina-condensed furfuryl alcohol resins offer advantages that are not attainable with analogous acid-condensed resins. As a binder for the manufacture of carbon and graphite articles, there is little doubt that the resin should be superior to currently available commercial furfuryl alcohol resins.

3. EXPERIMENTAL APPARATUS AND PROCEDURES

3.1. Preparation of Furfuryl Alcohol Resins by Alumina Condensation

A number of liquid furfuryl alcohol resin intermediates were prepared by condensation with activated gamma alumina. The degree of resinification and the viscosity of the intermediates were purposely varied to determine the effect of these variables on subsequent resin properties. Alcohol used for this work was supplied by the Quaker Oats Company; the activated alumina (grade F-10) was supplied by the Aluminum Company of America.

3.1.1. High-Viscosity Resins

A high-viscosity resin or condensate was prepared by heating furfuryl alcohol (F. A.) in continued contact with activated alumina. In practice, 1500 grams of F. A. and 170 grams of alumina (8-14 mesh) were placed in a two-liter, three-neck flask provided with a mechanical stirrer, a thermometer, an inlet for return of the F. A., a vertical 22-inch air-cooled condenser, and a heating mantle. The air-cooled condenser was connected to a water-cooled down-flow condenser which fed into a decanter where water of condensation, low boiling condensates, and some furfuryl alcohol were collected and separated as organic and water strata. Periodically, the organics were fed back into the reaction flask. Heating of the agitated mixture of furfuryl alcohol and suspended catalyst was continued until 16 per cent water of condensation had been collected. Total reaction time was four hours; end point reaction temperature was 220°C. The resin mixture was cooled with agitation to 100°C, and the catalyst removed by screening. Room-temperature viscosity of the resin prepared in this way was approximately 300,000 cps.

3.1.2. Low-Viscosity Resins

The combination of relatively low viscosity with high conversion, i. e., little or no unconverted monomer, was achieved by limiting the contact time between the catalyst and the condensates. This was accomplished by distilling furfuryl alcohol into a column containing the

alumina catalyst. The water of condensation was removed from the top of the column as an azeotropic mixture of furfuryl alcohol and low boiling condensates, with the main portion of the resin condensate being returned to the reservoir containing the boiling alcohol. The azeotrope, condensed and collected in a decanter, separated into water and organic layers, and the organic layer was intermittently returned to the reservoir.

Distillations were allowed to proceed until 13 to 15 per cent water of condensation was collected. End point temperatures were approximately 220° and 260° C, respectively.

3.2. Resin Composition

The composition of an alumina-condensed resin from which 13 per cent water of condensation had been collected was studied by fractional distillation at reduced pressures. Five fractions of the resin were obtained and were examined by infrared absorption to determine species present in the fractions.

3.3. Pyrolysis Studies by Gas Chromatography

Thermoset resins, both with and without fillers, were pyrolyzed and the gaseous products continuously sampled through the temperature range 150° to 850° C and analyzed by gas chromatography. Reduction of the accumulated data yielded curves showing the quantitative elution of the different gases.

These analyses were conducted on a Burrell Kromotog model K-1 gas chromatograph. The instrument was modified slightly so that the gas samples from the pyrolysis chamber were injected directly onto the column, thus bypassing the sampling unit of the instrument.

The pyrolysis furnace (Figure 1) consisted of a 31-cm Vycor tube fitted at each end with a silicone connector seal. The upper 14.5 cm was made of 7-mm OD tubing, while the lower portion consisted of 3-mm ID heavy-walled tubing. The sample tray, located in a slightly enlarged area directly in the center of the tube, measured 1.0 cm in width and 2.5 cm in length. The sample (10 to 15 mg) was inserted through the top of the tube. When the sample was in the vertical position, it rested on a tungsten coil supported by an indentation in the furnace wall which also served as a thermocouple well. The tungsten coil was 3.5 mm in diameter and 3.0 mm deep.

A mass spectrometer analysis was performed to check the identity of the different components. The pyrolysis tube (Figure 2) used for collecting samples for this analysis resembled the gas-analysis furnace with the omission of the silicone seals at each end and the tungsten sample platform. In this case, the top half of the Vycor tube contained a standard-taper 19/30 joint for sample introduction, while the bottom part of the tube was connected to a high-vacuum, oblique-base, 2 mm hollow vacuum-cup stopcock. The stopcock was connected to the Vycor

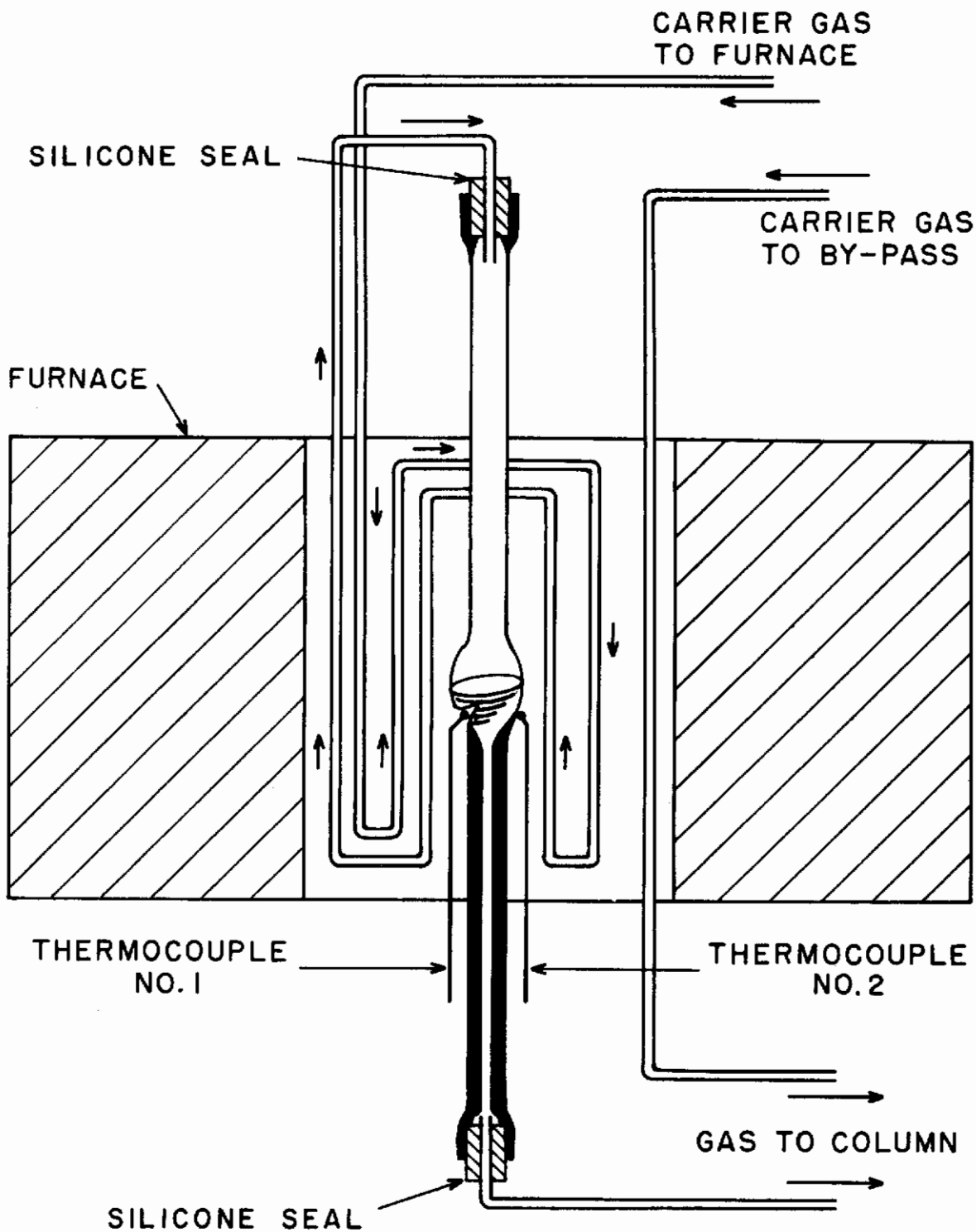

FIG. 1 SCHEMATIC DIAGRAM OF PYROLYSIS FURNACE AND CHAMBER

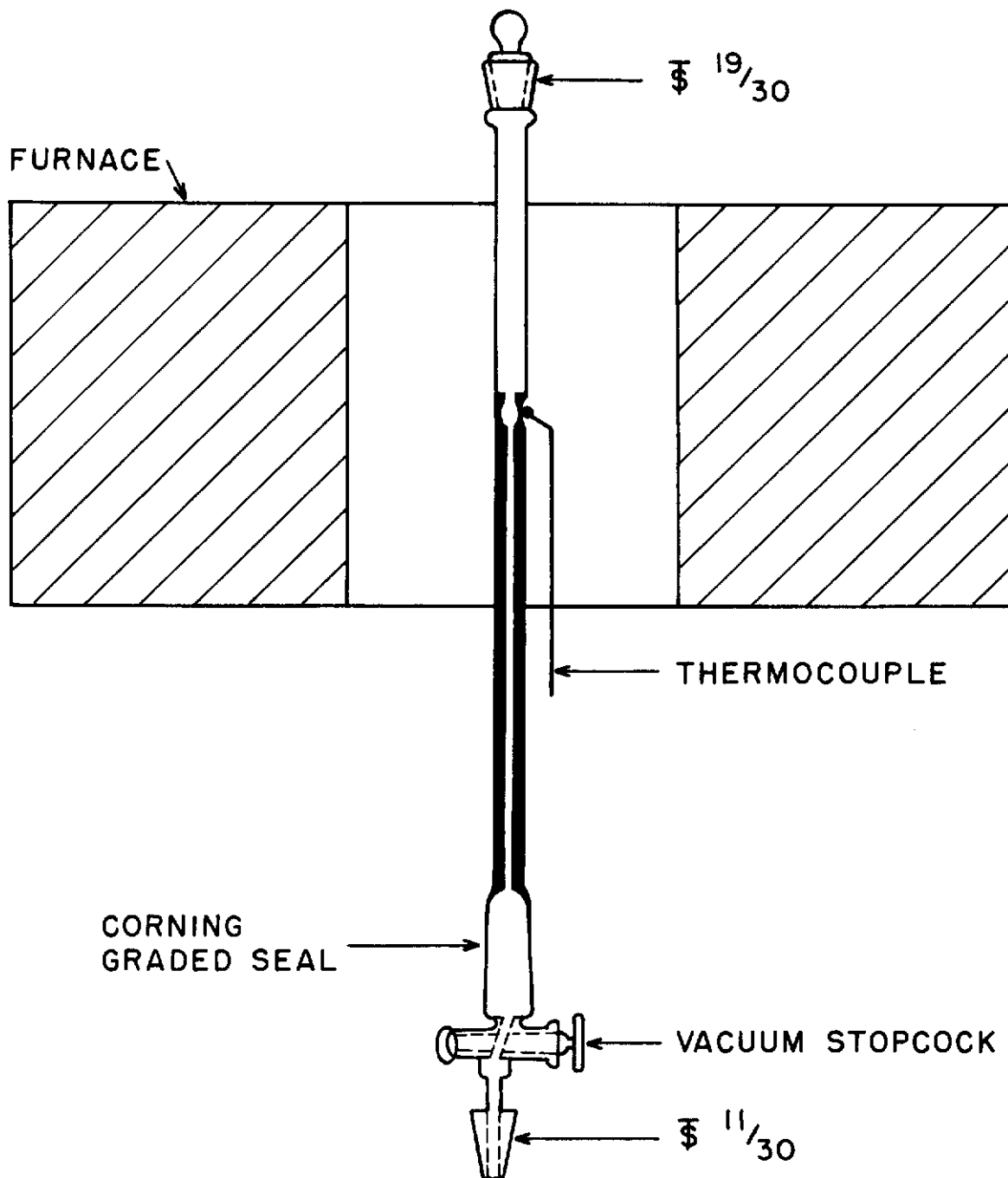

FIG. 2 SCHEMATIC DIAGRAM OF PYROLYSIS CHAMBER USED FOR COLLECTION OF PRODUCTS FOR ANALYSIS BY MASS SPECTROMETRY

Contrails

furnace by means of a Corning graded seal. The stopcock was then attached through a standard-taper 10/30 ground-glass joint to a 100 ml evacuated gas-sampling flask. The two ends of the pyrolysis tube were exposed approximately 7.0 cm outside the enclosed heating zone.

The heater used for the pyrolysis studies contained an inner circular bank of heating coils 3.5 cm in diameter and 16.0 cm in length. The pyrolysis tube was positioned in the center of the heater. During the heating cycle it was closed at both ends with asbestos mats. The temperature was increased at a predetermined rate (7° to 9° C/min) against Variac settings to maintain a linear and reproducible heating schedule from run to run. An Iron-Constantan thermocouple was located in a recessed well directly under the sample.

Quantitative standardization of the individual gaseous components was accomplished by calibrating against known volumes of each component and plotting calibration curves for measurements of area vs. volume. The liquid components were calibrated by a similar method. Standard solutions were prepared from reagent-grade materials, and known volumes were analyzed. Calibration curves were then plotted in the ranges required for the analysis.

The samples used in this study were:

Resin 1

Alumina-condensed furfuryl alcohol resin, catalyzed with 0.5 per cent p-toluenesulfonic acid; 850 cps; thermoset at 125° C.

Resin 2

Alumina-condensed furfuryl alcohol resin, catalyzed with 2.5 per cent p-toluenesulfonic acid; 8000 cps; thermoset at 125° C. This sample contained 100 parts of angular alumina grain (200 to 325 mesh) to 24 parts of resin.

Resin 3

Alumina-condensed furfuryl alcohol resin, catalyzed with 2.5 per cent p-toluenesulfonic acid; 8000 cps; thermoset at 125° C. This contained 150 parts of petroleum coke (200 to 325 mesh) to 100 parts of resin.

The sample was introduced into the pyrolysis furnace, and residual air was flushed out with the carrier gas, either nitrogen or helium. The pyrolysis chamber was then closed off and the carrier gas switched to a bypass tube which was preheated in the same furnace. The furnace temperature was increased at the predetermined rate, and the off-gases were swept into the gas chromatograph with the preheated carrier gas. Analyses were performed at intervals of 50° C during the pyrolysis.

In view of the extremely low quantities of gases appearing below 100° C in initial runs, sampling was initiated at 150° C and continued through 850° C. For the complete distribution of all the off-gases it was necessary to use three different separatory columns and four different runs at each temperature interval to get a complete analysis (Table 1).

The fact that the constituents found in the off-gases were relatively few in number (13) simplified the work. There were, however, small amounts of other pyrolysis products of higher molecular weight which were not identified.

3.4. Differential Thermal Analysis

Use of DTA (Ref. 3) as an aid in characterizing physical and chemical phenomena has proved to be a valuable tool in the study of polymerization and pyrolysis reactions of both synthetic and natural binders commonly used in the carbon industry. For this reason, the technique was applied to the study of both acid-condensed and alumina-condensed furfuryl alcohol polymers and derivatives.

Basically, the apparatus consists of a three-cup system in which the temperature difference between the sample and an opposed reference standard is accurately measured while being heated uniformly at a constant rate. In this work, the heating rate was 10° C/min and the sample size was approximately 0.5 gram.

It was decided that the most effective way to discern either small differences in reactivity or rearrangements within the polymers would be to charge the test cups with binder only. The polymers were first activated with one per cent p-toluenesulfonic acid (TSA), poured into the sample test cup and immediately analyzed. While this procedure gave good results through most of the thermosetting stage, the exotherm generated was sufficient to cause frothing and overflowing. This effectively destroyed contact with the thermocouple and resulted in indistinct pyrolysis curves above 175° C. It was found necessary to fill two cups, one of which was immediately analyzed through the thermoset stage and discontinued; the second was aged at 40° C for 24 hours, and cured at 150° C for two hours prior to analysis. This procedure yielded two curves, one of the thermosetting stage, and one of pyrolysis, which then could be joined.

3.5. Shrinkage Characteristics

Samples of thermoset resin approximately 1/4 x 1/4 x 2 inches with pyramidal ends were suspended in a vertical Vycor tube within a resistance wound furnace. Sample length was measured optically, and sample temperature was measured by means of a thermocouple located adjacent to the specimen. Measurements were taken at 10° C intervals while the specimen was heated at a rate of 10° C/min to a maximum temperature of 1000° C.

Table 1. Conditions Used for Analysis of Gaseous Pyrolytic Products

Columns	Conditions	Components Analyzed
Squalane 25 w/o on 30- to 40-mesh Celite (AW); 1/4 in x 20 ft U-shaped copper tubing.	Temperature 25° C; helium carrier gas; flow rate 54 ml/min; detector temperature 50° C.	Carbon dioxide Ethylene Ethane Propylene Propane
Carbowax (4000) 5 w/o on 30- to 60-mesh Haloport F; 5 mm x 1 m U-shaped Pyrex column.	Temperature 40° C; helium carrier gas; flow rate 36 ml/min; detector temperature 150° C. ^a	Furan Methanol Ethanol n-Propanol Water
Molecular sieve (5A) 30- to 60-mesh 1/4 in x 3-1/2 ft U-shaped copper tubing.	Temperature 25° C; helium carrier gas; flow rate 82 ml/min; detector temperature 50° C. ^b	Methane Carbon monoxide
Molecular sieve (5A) same as above	Nitrogen flow rate 20 ml/min.	Hydrogen

^a Exit line from furnace chamber to detector heated to 85° C.

^b Water and carbon dioxide removed from pyrolysis eluate before entering column by means of water adsorption.

3.6. Dynamic Elastic Properties

Figure 3 shows the apparatus used for determining the flexural dynamic Young's modulus of elasticity. In this sketch, the numbered units are as follows:

1. a speaker type driver with collet chuck attached
2. 1/8 inch diameter lampblack base carbon driver rod
3. the pickup rod, identical to the driver rod
4. accelerometer, used as a vibration detector, mounted on the pickup rod
5. cathode follower which converts the accelerometer output into a signal which can be read on the oscillograph. When the Lissajou pattern, indicative of the resonant frequency, is obtained, the fundamental frequency of the specimen is read on a frequency counter.
6. the apparatus, enclosed in a plastic hood, is mounted on the furnace by screws extending upward from the matching flange of the water-cooled turret. A thick rubber sponge gasket provides mechanical isolation and permits leveling adjustment and vertical movement to compensate for the thermal expansion of the driver and pickup rods. The 2 x 1/2 x 1/8 inch specimen (7) is loosely restrained between positioning pins (8) and is supported on a carbon boat (9). The integral knife edge supports are spaced at the nodal positions for a rectangular beam vibrating in its fundamental flexural frequency.

3.7. X-Ray Studies

It is well known that cokes derived from furfuryl alcohol resins are either non-graphitizing or, at best, graphitize to only a limited degree. It is of interest to determine whether or not this is also true when the resin, used as a binder, is in intimate contact with an easily graphitized aggregate such as petroleum coke.

Four samples were, therefore, prepared for X-ray examination:

1. a specimen molded from 100 parts petroleum coke and 100 parts of resin; pyrolysis of the resin yielding 55.4 parts of resin coke.
2. a physical mixture of 100 parts of petroleum coke and 55.4 parts of resin coke.
3. resin coke (100 per cent)
4. petroleum coke (100 per cent).

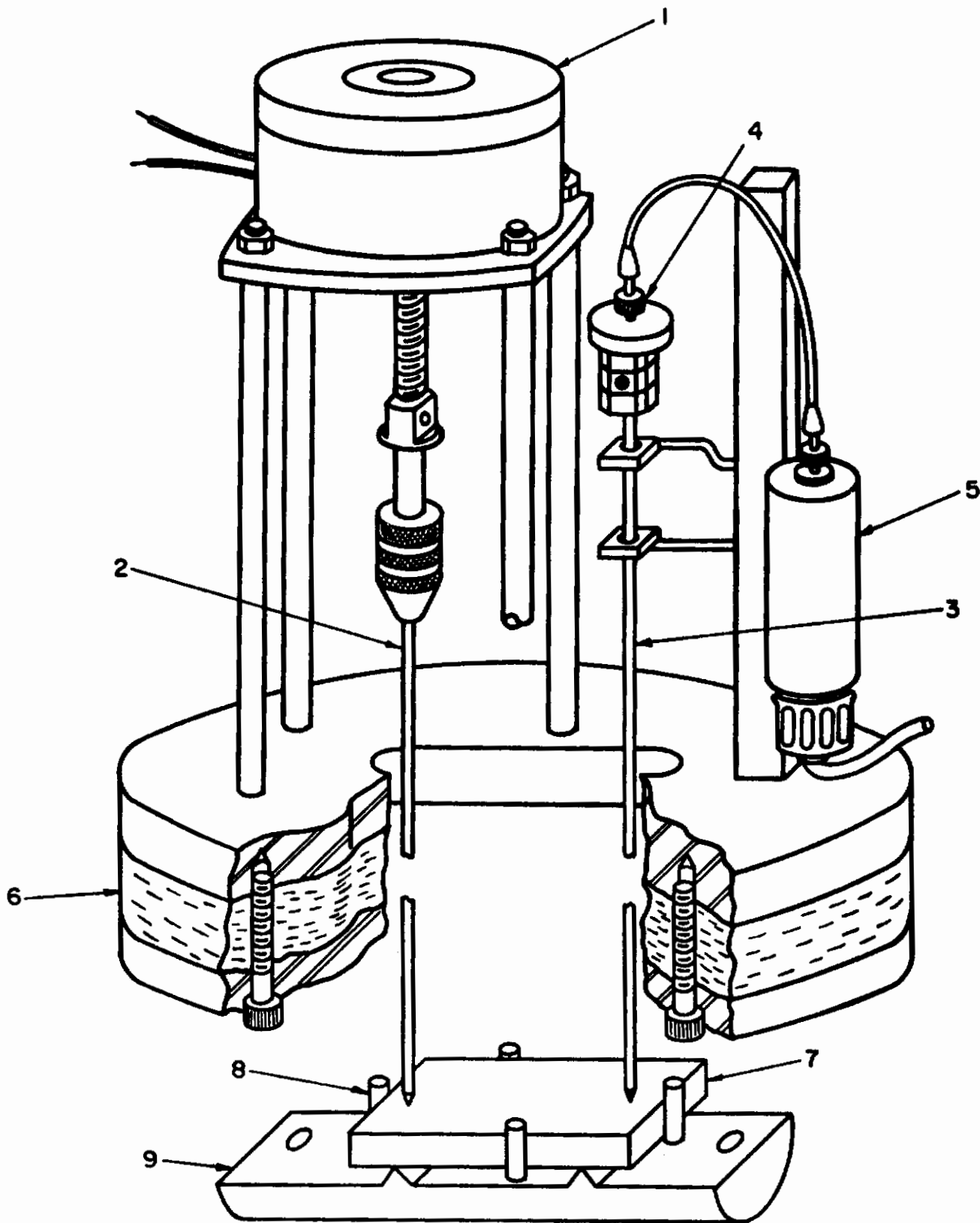

FIG. 3 DYNAMIC MODULUS APPARATUS

These four samples were loaded on a graphite boat and simultaneously heated to 2850° C.

Two X-ray diffraction techniques were used in this study: diffractometry and flat cassette transmission photographs. In each case CuK α radiation was used.

4. RESULTS AND DISCUSSION

4.1. Preparation of Furfuryl Alcohol Resins by Alumina Condensation

Two methods of condensing furfuryl alcohol by alumina catalysis were employed for this study. In one of these, the alumina was suspended in the alcohol bath. Under this condition, resinification can proceed to any desired degree of condensation up to complete solidification which occurs shortly after 16 per cent water of condensation has been split out. This technique yields high-viscosity resins (10^4 - 10^6 cps) after about 13 per cent water is collected. These resins are highly temperature dependent as shown in Figure 4 where viscosity has been plotted against temperature. All points are on a straight line except the one corresponding to 145° C. Compared with the other values, the viscosity at this temperature (163 cps) is higher than might be expected and indicates that some heat-polymerization has occurred during viscosity determinations. The viscosities from room temperature up to and including 124° C were all made on the same sample. After the 75° C determination, the sample was held overnight at temperature, and measurements at 99° and 124° C were made the following day. Up to this point, the sample underwent no measurable change. The thermoregulator for the bath was then set for 150° C, and the sample was again left overnight. By the next morning, it was skinned over so badly that it was replaced with a fresh sample which, on reaching 145° C, again formed a skin. This time, the skin was removed and the viscosity immediately measured. Next, the sample was left at 145°-150° C over the week-end with an argon purge. The purpose of the purge was to prevent skin formation by oxidation which is known to occur very slowly when the liquid resins are exposed to air. By Monday, the sample had become a rubbery solid. The critical temperature for heat polymerization, then, appears to be somewhere between 125° and 145° C.

In the second method, where the furfuryl alcohol is distilled into a column containing the catalyst, low-viscosity resins of complete conversion can be produced. The initial batch size was increased gradually from 1-1/2 to 10 liters, and a cooling coil was placed in the reservoir to quickly cool the resin below the heat polymerization temperature. For a given apparatus, it was found that batches having similar viscosities and similar amounts of water of condensation could be produced by stopping the reaction at the same final pot temperature (220°-260° C), and cooling below the heat polymerization temperature. As some water of condensation is retained in the apparatus and on the catalyst, the actual degree of condensation is higher than that indicated by the water collected. For resins with 13 per cent water split out, the Brookfield

Contrails

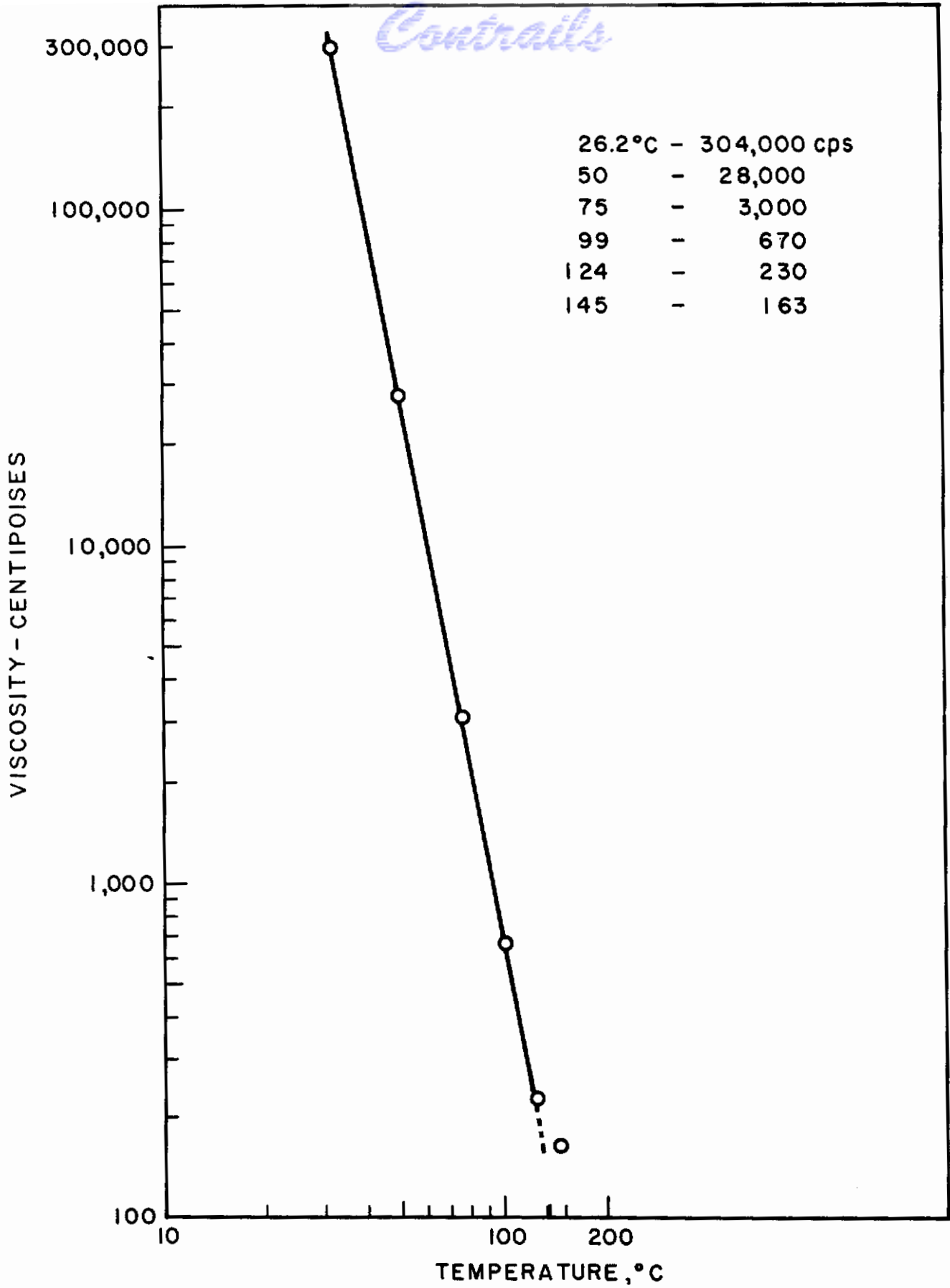

FIG.4 HIGH VISCOSITY POLYMER VS. TEMPERATURE

Contraails

viscosity at 25°C is in the 300-500 cps range; for resins with 14 to 15 per cent water split out, viscosities are about 2000-6000 cps. The liquid resin yields from the condensation procedure are from 75 to 80 per cent depending on how far the reaction is allowed to proceed.

Attempts to produce medium-viscosity resins beyond the point of 15 per cent water removal resulted in considerably higher viscosity. In one case, the latter part of the condensation was carried out at reduced pressure to lower the distillation temperature which in turn would permit a lower final pot temperature and, therefore, reduce the viscosity increase caused by heat polymerization. Under these conditions, the catalyst bed could not be maintained at a high enough temperature to get a reasonable rate of condensation, even when externally heated. In another approach, the time of reaction was considerably shortened by increasing the amount of catalyst, but the resins still had high viscosity when more than 15 per cent water was split out. This finding is consistent with results obtained in the past for resins produced by boiling furfuryl alcohol in contact with the alumina catalyst. Under this condition, the viscosity rises rapidly when more than 13 per cent water has been removed, and shortly beyond 16 per cent removal, the resin becomes a rubbery mass. Since the cured (thermoset) yield of a resin with 15 per cent water removed is at least 99 per cent, the maximum amount of water of condensation which can be formed on setting is one per cent. When the condensation reaction has been substantially completed, cross-linking with formaldehyde becomes the predominant reaction resulting in a rapid viscosity build-up. The formaldehyde is produced by the breakdown of difurfuryl ether to difurylmethane and formaldehyde. Furthermore, chain lengthening caused by an unknown addition polymerization mechanism probably takes place. It is understandable, then, that 15 per cent water of condensation removed is a practical limit for resins with moderate viscosity.

In the following discussion, the resins will be referred to as numerical percentages indicative of the amount of water of condensation collected.

Viscosities of the low and medium viscosity resins are also highly temperature dependent. This is illustrated in Figure 5, which is a plot of viscosity vs. temperature for a 14.5 per cent resin. When this resin was held at 100°C for 24 hours, the viscosity rose from 35 to 41 cps. A 12.4 per cent resin (257 cps at 25°C) held at 120°C for 16 hours rose from 5.5 to 7.7 cps. The low-viscosity resins appear to be more susceptible to heat polymerization than the high-viscosity resin discussed earlier.

The lowest degree of conversion considered during this program corresponds to the collection of about 13 per cent water of condensation. This is the point where practically all of the monomeric furfuryl alcohol has been converted. Thus, when a 13 per cent resin is distilled at reduced pressure, a fraction amounting to five to six per cent of the resin comes off between room temperature and 50°C at a pressure of 2.5 to 3.0 mm Hg. This fraction contains the low boiling difurylmethane

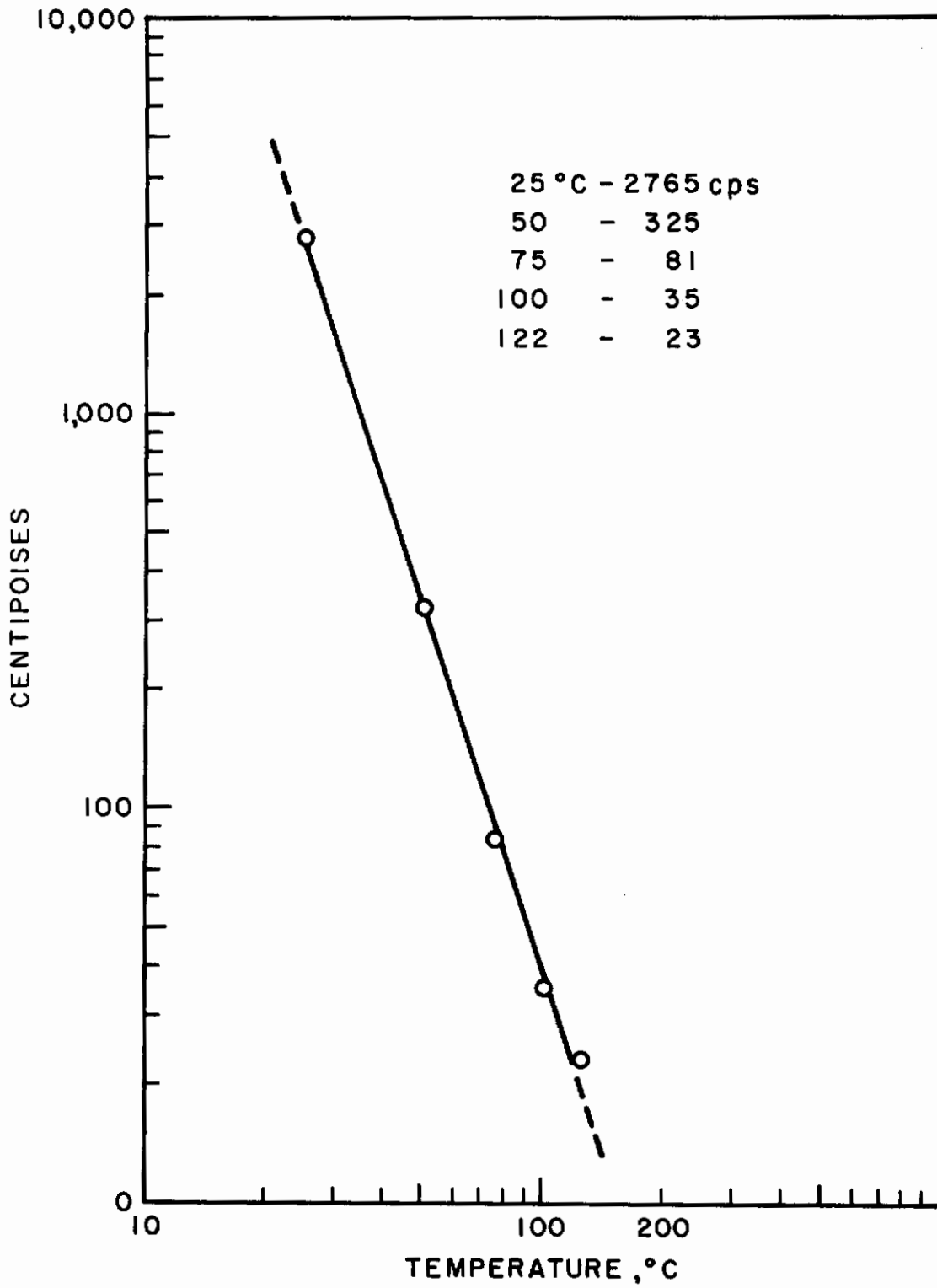

FIG.5 14.5 % RESIN - VISCOSITY VS. TEMPERATURE

(78° C at 12 mm Hg), any furfuryl alcohol present, and some of the next higher boiling component, difurfuryl ether. An unsuccessful attempt was made to apply infrared techniques to the quantitative determination of residual monomer. However, preliminary gas chromatography experiments indicate that a method could be developed on this basis. In any case, it is evident that the amount of residual furfuryl alcohol in a 13 per cent resin is small. It should be pointed out that for somewhat lower conversions, resins with very low viscosity can be obtained. Thus, for a conversion corresponding to 10 to 11 per cent water split out, the viscosity range is 40-60 cps at 25° C. Such resins would, of course, contain appreciable amounts of monomeric furfuryl alcohol.

4.2. Composition of Low-Viscosity Resins

The composition of the alumina-catalyzed furfuryl alcohol resin, corresponding to 13 per cent water of condensation, has been studied by means of fractional distillation at reduced pressure. The purpose of this study was to get an insight into the resin composition and to obtain pure samples of some of its components.

Two series of fractionations were carried out. In the first series, two main fractions were obtained, one of which was mainly difurfuryl ether, but the other could not be identified. The second fraction had been expected to contain the dimer (5 furfuryl furfuryl alcohol), but infrared analysis showed that OH groups were absent whereas CO groups were present. Tentatively, it was assumed that oxidation had changed the dimer to a ketone or an acid. The fractionation experiments were repeated with the modification that distillations were carried out under nitrogen to prevent oxidation. The following fractions were obtained:

Fraction 1 - This fraction, which amounted to 5.8 per cent of the resin taken, boiled from room temperature to 47.5° C at a pressure of 2.5 to 2.8 mm Hg. It was not investigated further because it was presumed to contain furfuryl alcohol, difurylmethane, and some of the next higher boiling fraction, difurfuryl ether.

Fraction 2 - This fraction, which amounted to 14.2 per cent of the resin taken, boiled from 86° to 88° C at a pressure of 2.1 to 2.2 mm Hg. Infrared analysis (Figure 6) showed that OH and CO groups were absent. Although there were definite indications that the fraction was difurfuryl ether, the boiling point differed from the 101° to 102° C at 2 mm Hg reported by Zanetti (Ref. 4) who prepared difurfuryl ether from furfuryl bromide and furfuryl alcohol. To check the identity of the fraction, difurfuryl ether was prepared by two other methods, one of which was a modification of Zanetti's method, in that the more stable furfuryl chloride was used in place of furfuryl bromide. The other was an unpublished method by Nielsen in which sodium furfurylate and furfural are reacted to give difurfuryl ether and sodium furoate. The product obtained by the modified Zanetti method had a boiling point of 78.5° C at 1.2 mm Hg, and the product obtained by the Nielsen method had a boiling point of 75° -77° C at 1 mm Hg. In both cases, the infrared spectrum

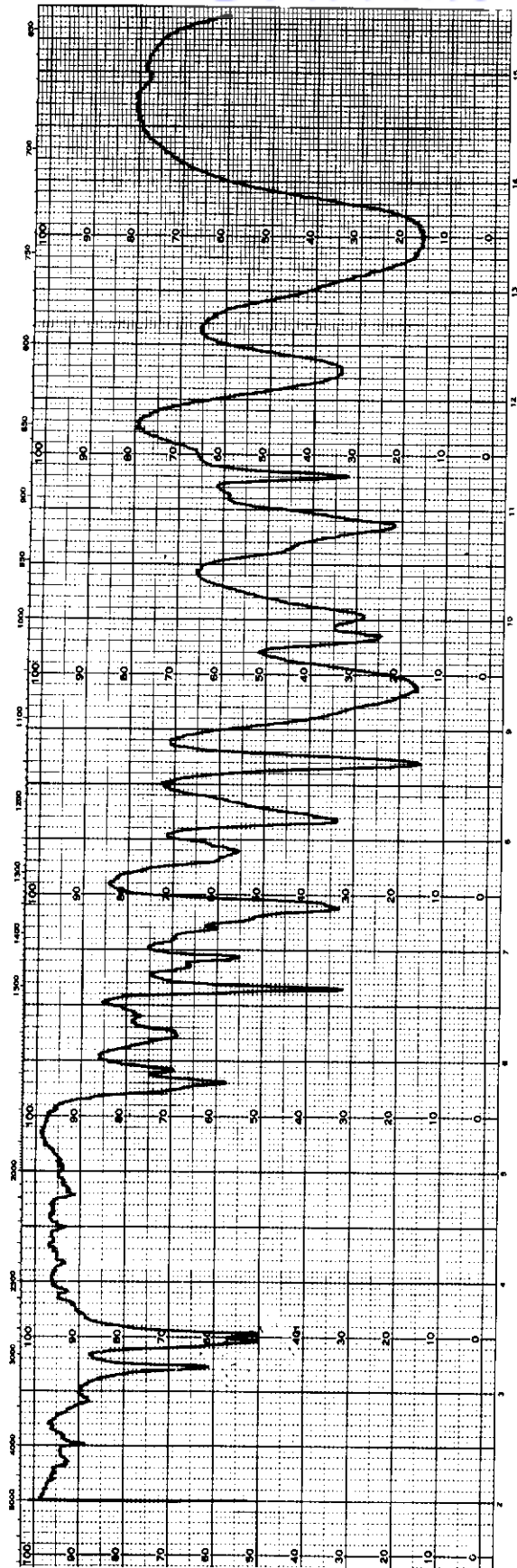

FIG. 6 INFRARED ABSORPTION SPECTRUM OF LOW VISCOSITY FURFURYL ALCOHOL RESIN (13% WATER OF CONDENSATION) - FRACTION 2, BOILING POINT 86° - 88°C AT 2.1 - 2.2 mm Hg.

matched that of Fraction 2 (Figures 7 and 8). On the basis of these results, it is safe to assume that Fraction 2 actually is difurfuryl ether. The viscosity of difurfuryl ether was found to be 5.1 cps at 25° C.

Fraction 3 - This fraction, which amounted to 6.1 per cent of the resin taken, boiled from 113° to 118° C at 1.7 to 2.2 mm Hg. Although Fraction 3 was expected to contain the dimer, infrared analysis again showed the absence of OH groups but did show the presence of CO groups (Figure 9). Since the fraction had been isolated under non-oxidizing conditions, it was concluded that the CO groups were due to the presence of esters, i. e., the dimer had been esterified with the levulinic acid (and perhaps homologue acids) which had been formed during production of the resin. To check this assumption, a part of Fraction 3 was saponified by refluxing with aqueous sodium hydroxide and then extracted with ether both before and after acidification. The ether extract of the alkaline mixture gave a liquid which boiled at 110°-111° C at 1 mm Hg. Infrared analysis showed that OH groups were present (Figure 10), and the alpha-naphthylurethane derivative melted at 107°-108° C, which is the melting point reported in the literature for this derivative of the dimer (Ref. 5). On the basis of these findings, it is believed that the isolated alcohol is the dimer and that it is present in the resin, at least in part, as an ester. The ether extract of the acidified reaction mixture produced a liquid which boiled from 164° to 188° C at 0.7 to 1.1 mm Hg. Infrared analysis showed the presence of CO groups (Figure 11), and it is assumed that this extract comprises levulinic and related acids.

To aid in the interpretation of the IR spectra discussed above, spectra also were prepared for furan and furfuryl alcohol (Figures 12 and 13). The spectrum for the resin used in the above fractionation study is shown in Figure 14.

Fraction 4 - This fraction, which amounted to 5 per cent of the resin taken, boiled from 130° to 170° C at 0.6 to 1.6 mm Hg. It has not been investigated but is assumed to be comprised of esters of the trimer.

Residue - After Fraction 4 had been recovered, the remaining material was extremely viscous at room temperature. It amounted to 63.5 per cent of the resin taken and probably contained the tetramer, either as such or as an ester, and low-molecular-weight polymers which had been formed from difurfuryl ether by way of difurylmethane.

The above investigation of the composition of the low-viscosity resin produced from furfuryl alcohol with activated alumina as the catalyst is incomplete. However, it has brought out two important points:

1. The formation of difurfuryl ether is an important part of the furfuryl alcohol resinification process. Although only 14 per cent of the ether was isolated the amount actually formed probably was much higher.

Contrails

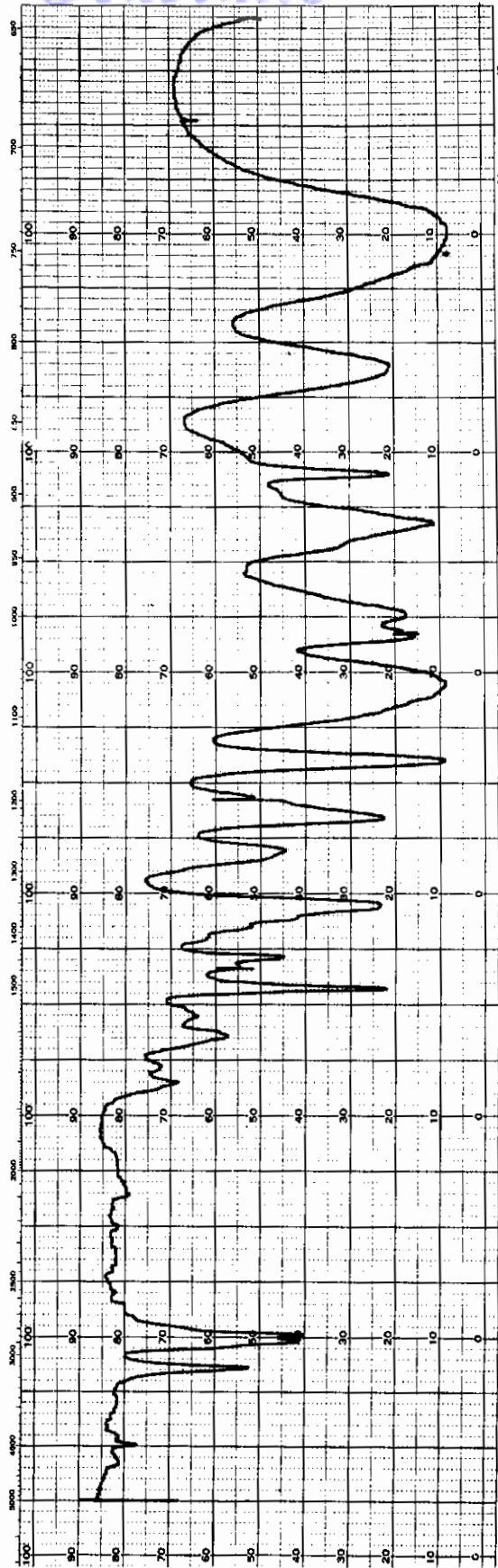

FIG. 7 INFRARED ABSORPTION SPECTRUM OF DIFURFURYL ETHER.
MODIFIED ZANETTI METHOD.

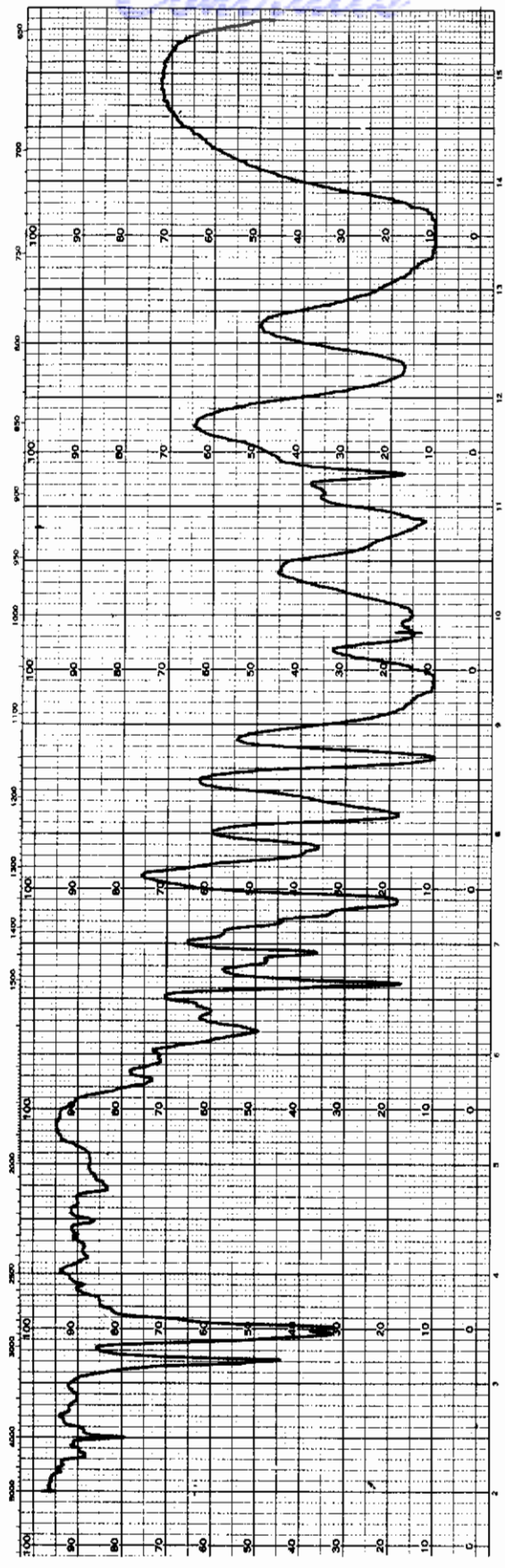

FIG.8 INFRARED ABSORPTION SPECTRUM OF DIFURFURYL ETHER.
NIELSEN'S METHOD.

Control

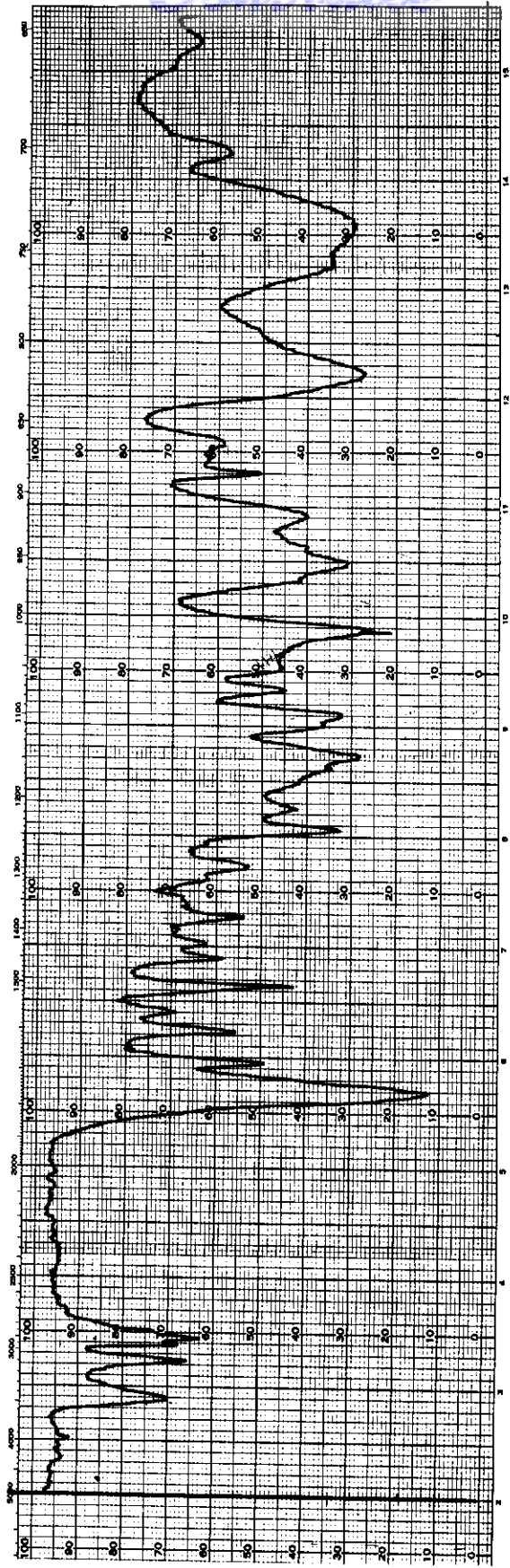

FIG.9 INFRARED ABSORPTION SPECTRUM OF ESTERS OF
5 - FURFURYL FURFURYL ALCOHOL.

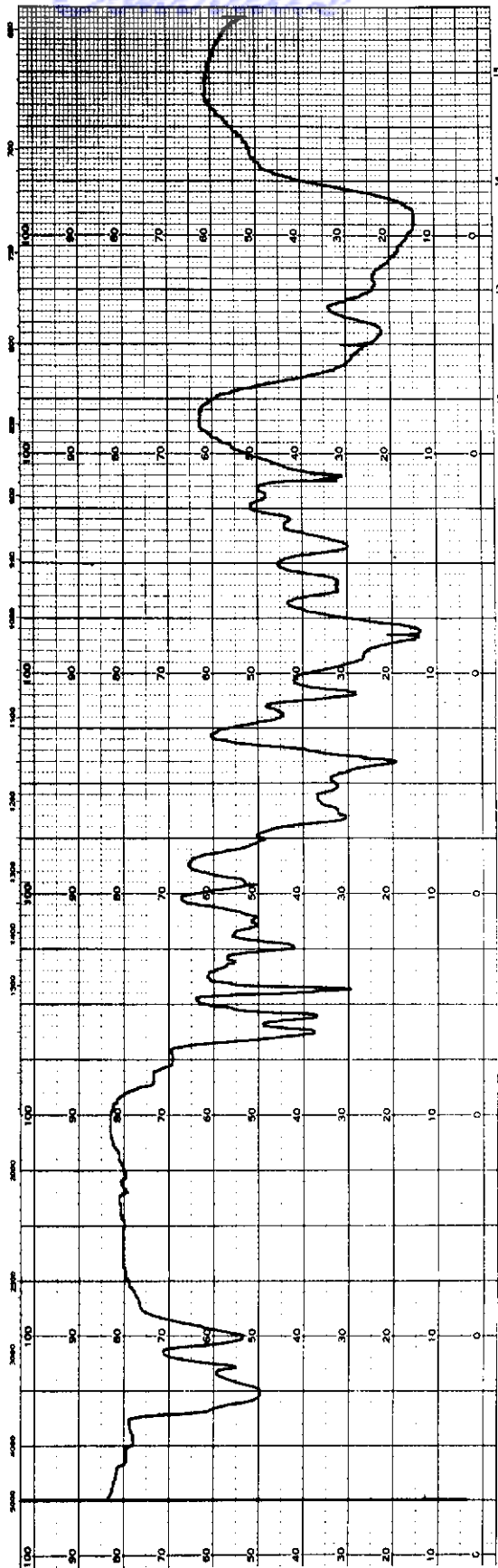

FIG. 10 INFRARED ABSORPTION SPECTRUM OF 5-FURFURYL FURFURYL ALCOHOL.

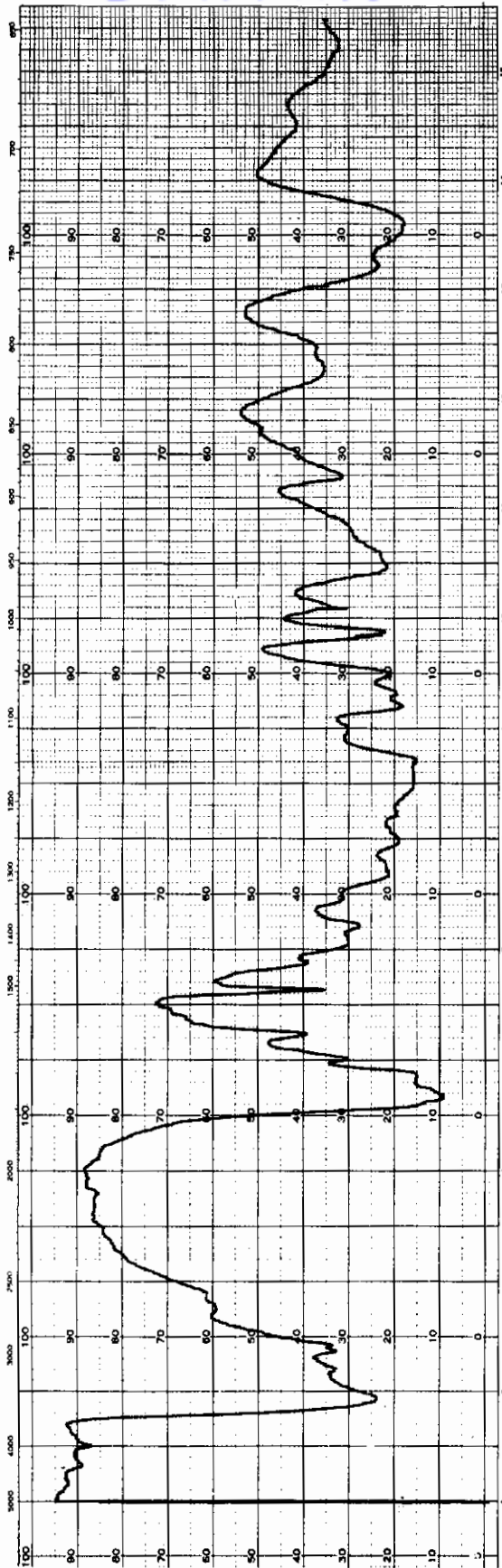

FIG. II MIXTURE OF LEVULINIC ACID AND HOMOLOGUES.

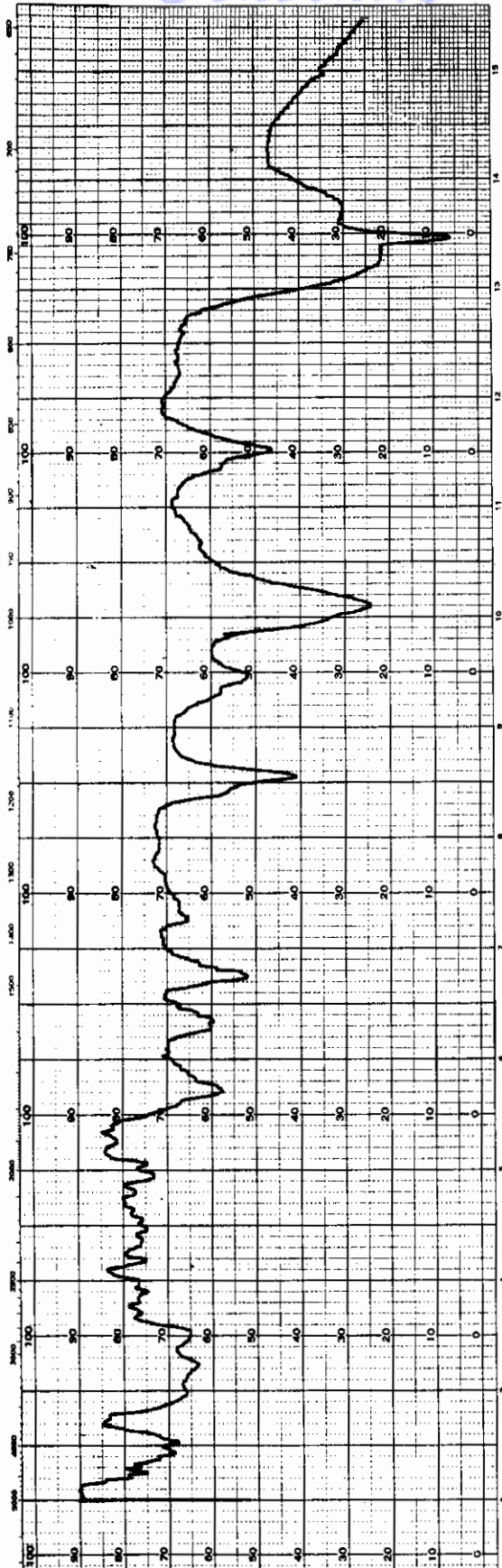

FIG.12 INFRARED ABSORPTION SPECTRUM OF FURAN.

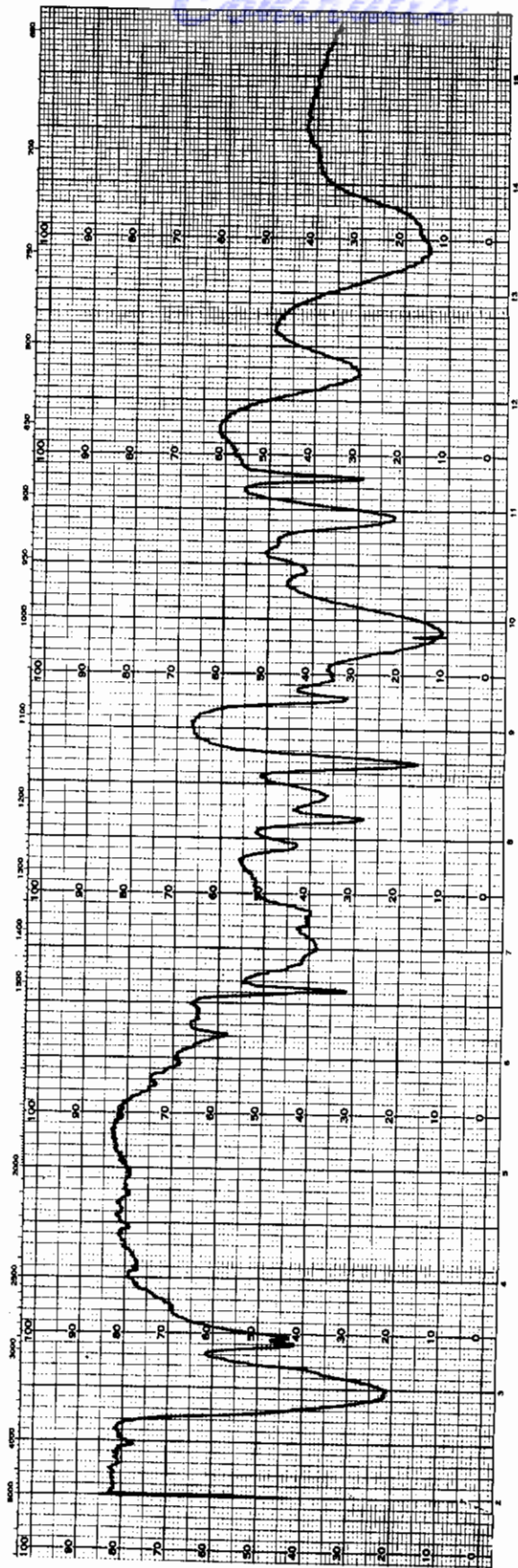

FIG. 13 INFRARED ABSORPTION SPECTRUM OF FURFURYL ALCOHOL.

Confidential

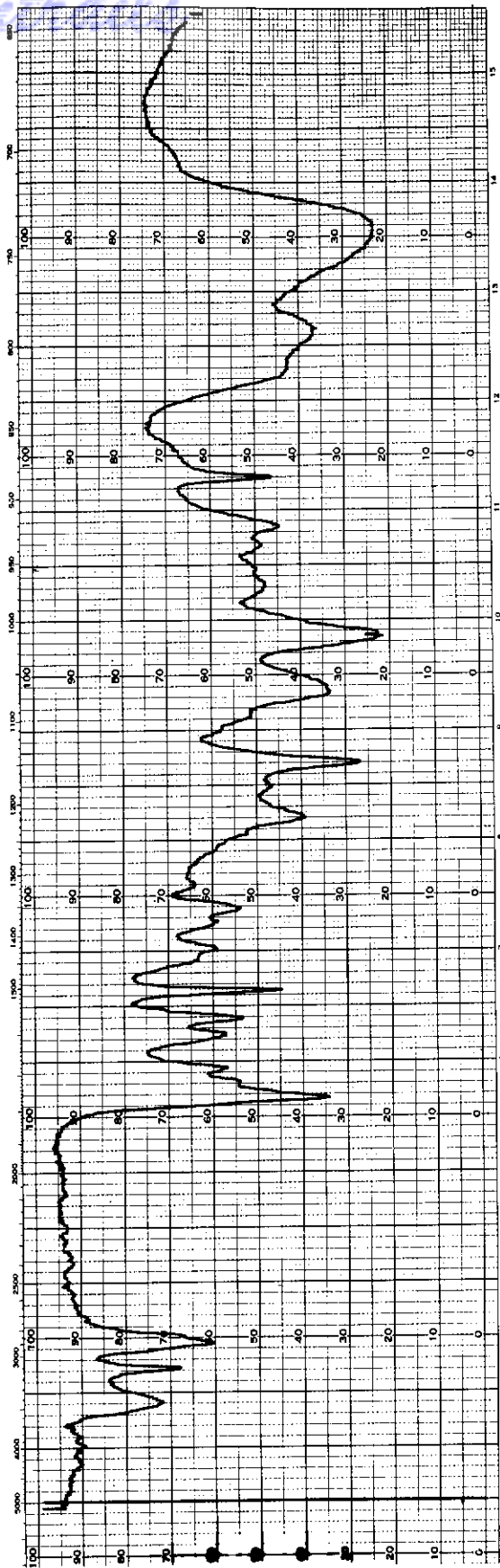

FIG. 14 INFRARED ABSORPTION SPECTRUM OF LOW VISCOSITY FURFURYL ALCOHOL RESIN (13% WATER OF CONDENSATION).

2. The alumina-catalyzed resin does not contain the dimer (5 furfuryl furfuryl alcohol) as such, but as an ester or esters.

In the past, it was assumed that the resinification of furfuryl alcohol with an acidic catalyst resulted mainly in poly (furfuryl) alcohols, with minor amounts of difurfuryl ether and levulinic acid as a consequence of side reactions (Ref. 6). While these assumptions were not supported by experimental evidence, they have recently been more or less confirmed by Takano, (Ref. 7) who treated furfuryl alcohol with dilute hydrochloric acid for 30 minutes, washed the reaction product, and then by fractionation isolated difurylmethane, difurfuryl ether, dimer, and trimer. In the abstract of Takano's paper, the amounts of difurylmethane and difurfuryl ether are given as 2.3 and 4.3 per cent respectively. The amounts of dimer and trimer are not given, but from the abstract they appear to be considered the main products. Thus, it appears that furfuryl alcohol resins produced with activated alumina as the catalyst have a composition very much different from that of a resin produced with an acidic catalyst.

4.3. Resin Derivatives as Impregnants

In the vacuum distillations of the 13 per cent resin discussed in the preceding section, it was notable that the distillate was a clear liquid of very low viscosity. Since it was thought that this material might be useful as an impregnant, several batches were prepared. The first, distilled until the vapor temperature reached 120°C at 0.9 mm Hg, produced 33 per cent distillate with a viscosity of 4.33 cps at 25°C. In a second distillation, a 46 per cent yield was obtained with a viscosity of 5.29 cps at 25°C. At this point, the still pot residue set to a rubbery mass. In a third experiment, a 30 per cent yield of a distillate of 4.75 cps at 25°C was obtained.

The thermal stability of such distillates in the presence of acid or acid-generating catalysts also was investigated. Dichloroacetic acid was used in one instance, but in all other instances the catalysts were p-toluenesulfonic acid (pTSA) and the methyl ester of this acid (ME-pTSA). It can be seen in Figure 15 that two per cent dichloroacetic acid has very little effect upon the viscosity of the resin.

Figures 15 and 16 show the viscosity-time relationships for distillate samples catalyzed with varying amounts of pTSA. The sample catalyzed with one per cent pTSA doubled in viscosity in less than seven hours. Comparison of the curves for 0.5 per cent pTSA at 20° and 25° C shows that even a 5-degree difference has a decided effect on the rate of increase in viscosity and, therefore, presumably on the rate of polymerization. Even a small amount of pTSA, such as 0.125 per cent, doubles the viscosity in 24 hours. It should be understood that the curves presented here are valid only if the polymerizing mass is maintained at the temperature designated for the curve. The polymerization is exothermic, and therefore, the rate of polymerization may increase rapidly if the heat of polymerization is not dissipated. To illustrate, a

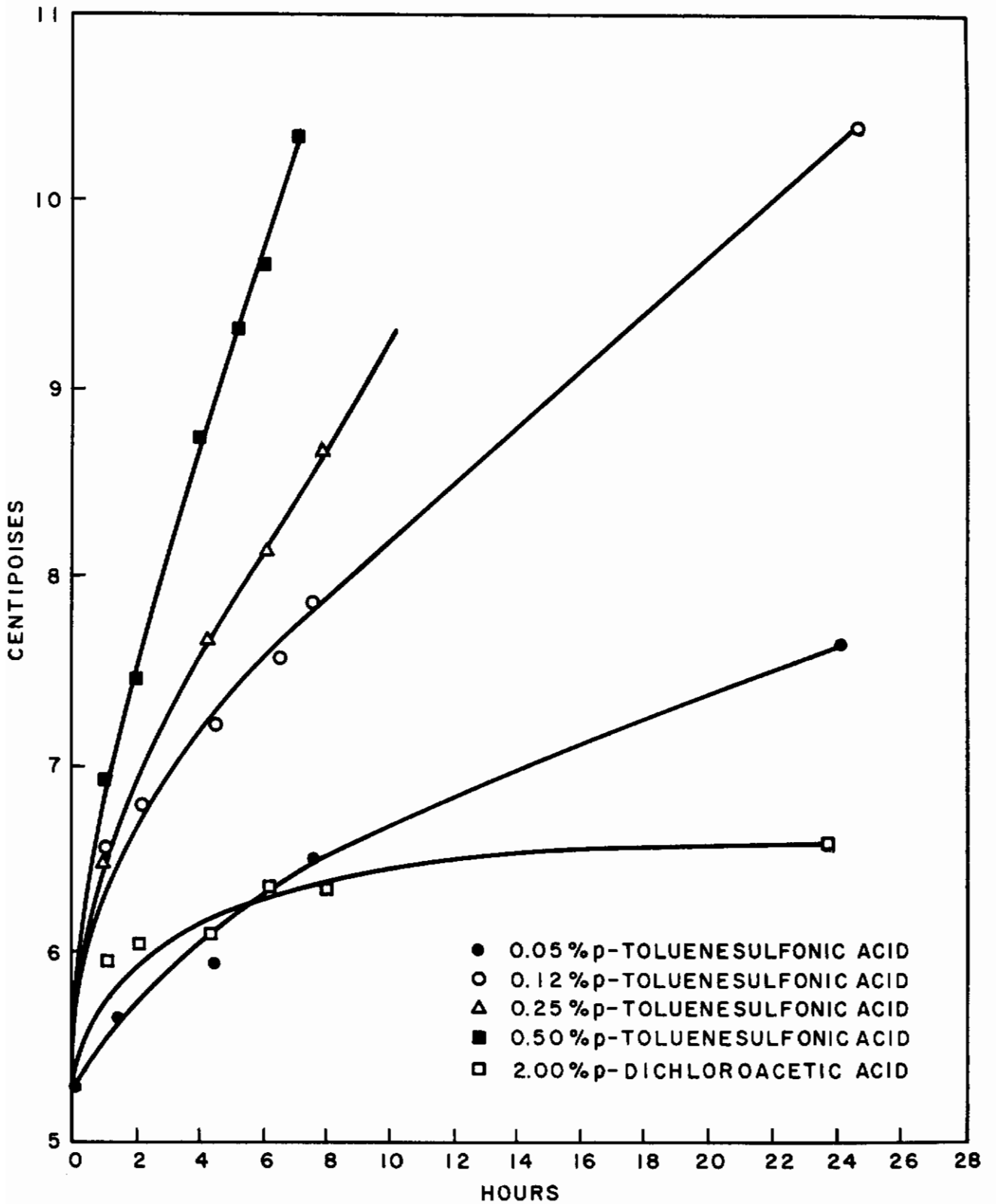

FIG. 15 FURFURYL ALCHOL RESIN DISTILLATE VISCOSITY AT 25°C VS. TIME FOR CATALYZED SAMPLES

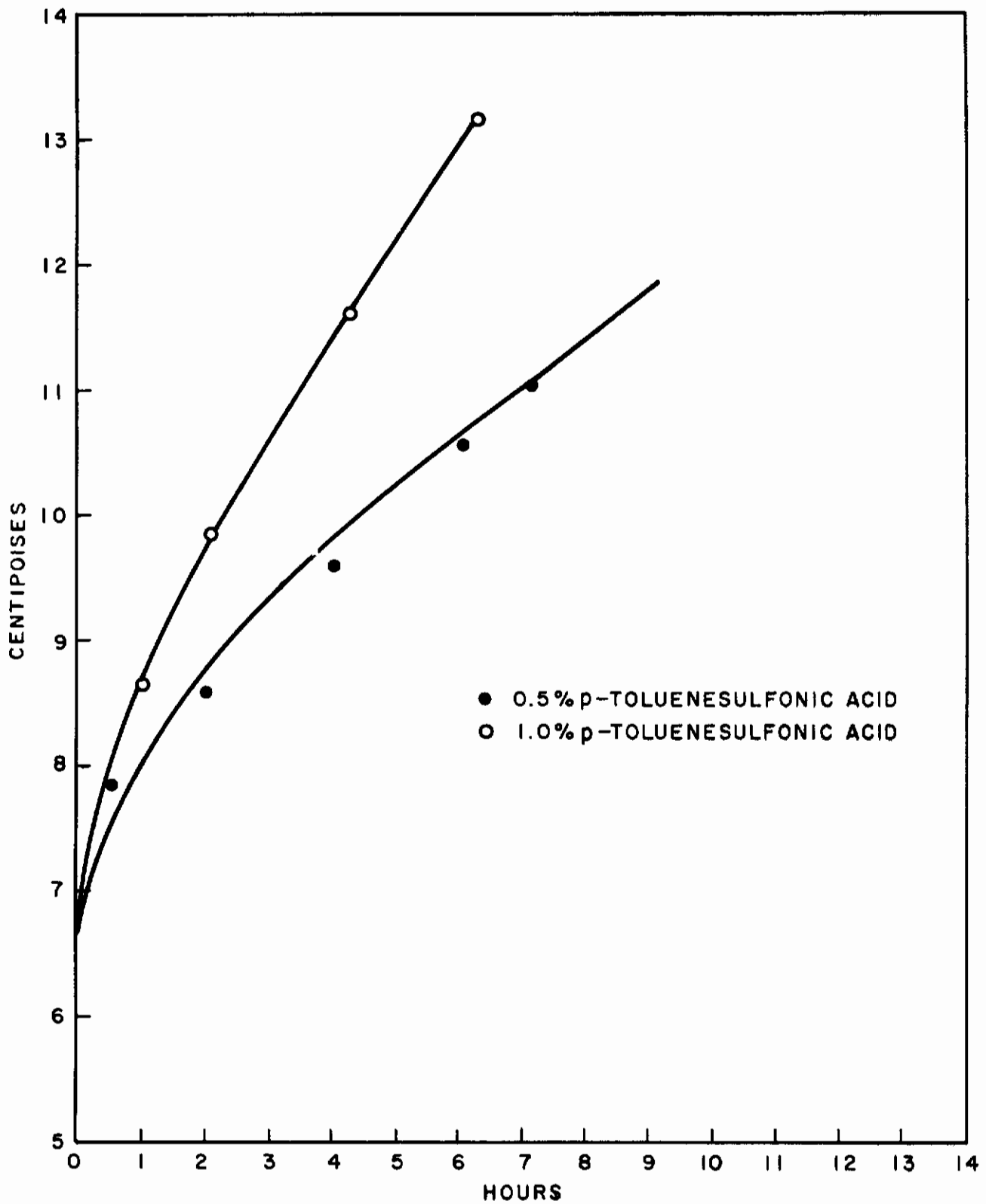

FIG.16 FURFURYL ALCHOL RESIN DISTILLATE VISCOSITY AT 20°C VS. TIME FOR CATALYZED SAMPLES

Contrails

sample of 100 grams distillate catalyzed with one per cent pTSA, when set aside at room temperature, polymerized violently within one-half hour. The viscosity experiments discussed here pertain to the lower boiling constituents of the regular liquid furfuryl alcohol resin. However, the viscosity changes would have been only slightly different if the original resin had been used instead.

It will be seen that, while pTSA is an excellent catalyst for the thermosetting of furfuryl alcohol resins, a careful balance must be achieved between batch size, amount of catalyst, and pot life desired. The use of a latent catalyst is essential, if a long pot life is required.

A great number of latent catalysts have been proposed for use with furfuryl alcohol most of which are of limited applicability here because they are insoluble in the liquid furfuryl alcohol resins. ME-pTSA is one latent catalyst which is soluble in the resins, and this catalyst has been investigated during this program.

Viscosity data for a furfuryl alcohol resin distillate (4.75 cps at 25° C), catalyzed with 0.5 per cent ME-pTSA, are shown in Figure 17. At 25° C, viscosity has increased only by 0.05 cps after six hours. This is insignificant. The sample was tested also after 22-1/2 hours, at which time the viscosity was 5.14 cps, an increase of only 0.39 cps over the starting viscosity. Thus, this catalyst assures ample pot life. The small viscosity increase observed at room temperature (25° C) was caused by the small amount of free acid present in the ester as purchased. If this acid could be either neutralized or removed, the catalyzed resin probably would be permanently stable at room temperature. When the temperature is raised, the methyl ester starts to hydrolyze to produce free acid. As this happens, the viscosity builds up at an increasing rate as demonstrated by the 50°, 65°, and 75° C curves.

The resin distillates are believed to contain a high percentage of difurfuryl ether because (1) the boiling point range excludes the presence of much of the 5-furfuryl furfuryl alcohol ester fraction, and (2) the average number of monomer units per molecule has been found to be 2.4. The first step in the resinification of difurfuryl ether is its conversion to difurylmethane and formaldehyde. In the case of a regular furfuryl alcohol resin, where the difurfuryl ether content is much smaller than in the distillate, the liberated formaldehyde is recombined in the cross-linking process. For the resin distillates, it is postulated that the amount of formaldehyde liberated during the resinification step would be more than could be recombined in the crosslinking process. On this basis, it was decided to study the viscosity behavior of a distillate cut back with regular resin.

An equal mixture by weight was prepared of the 4.75 cps distillate and a 257 cps resin. This mixture was catalyzed with 0.5 per cent ME-pTSA and the viscosity changes at 50° and 60° C measured. Figure 18 shows the curves obtained. The 50° C curve is similar to, but steeper than, the 50° C curve for the distillate alone (Figure 17), indicating that

Contrails

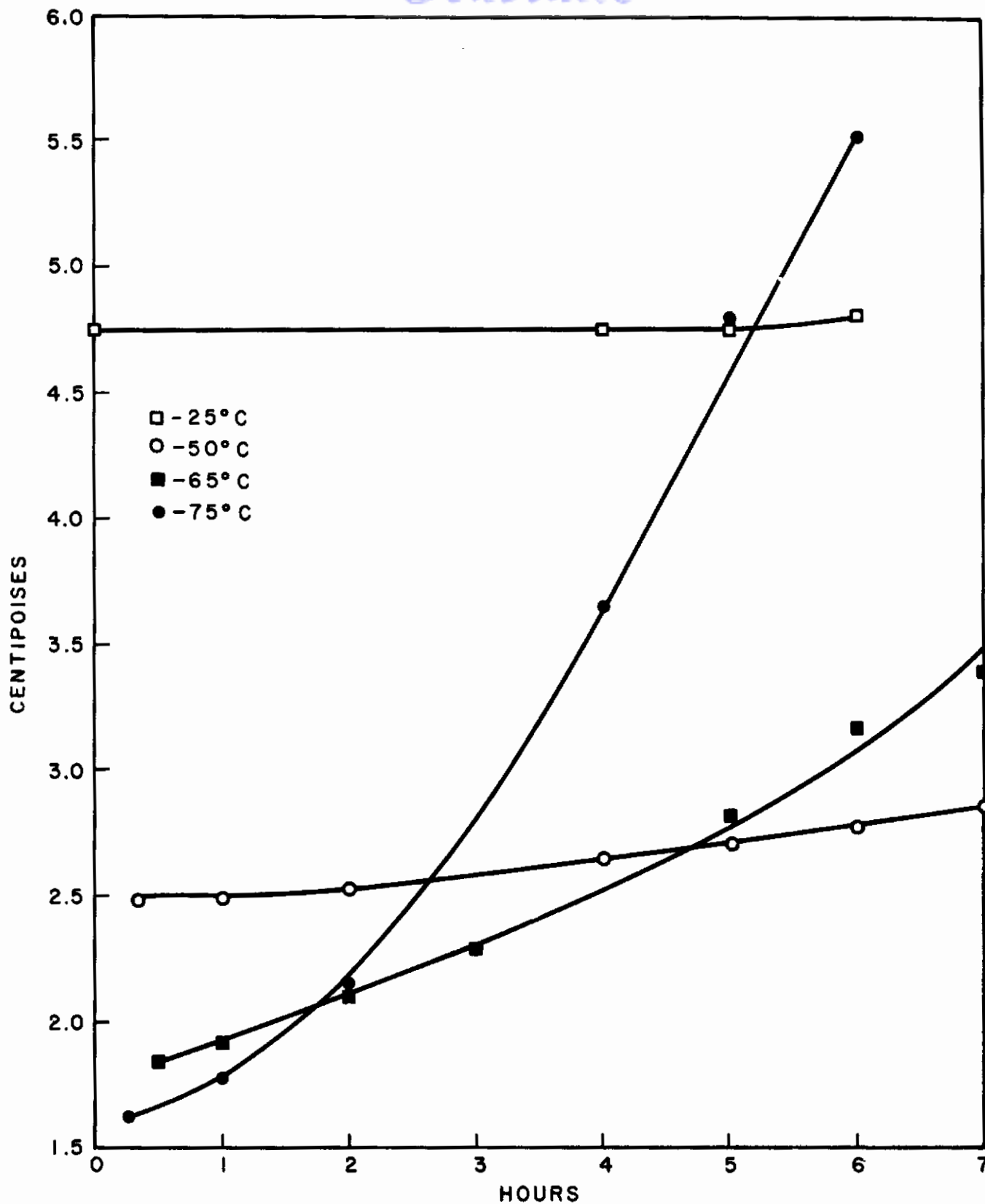

FIG.17 FURFURYL ALCHOL RESIN DISTILLATE, CATALYZED WITH 0.5% METHYL p-TOLUENESULFONATE. VISCOSITY VS. TIME AT 50, 65 AND 75 °C

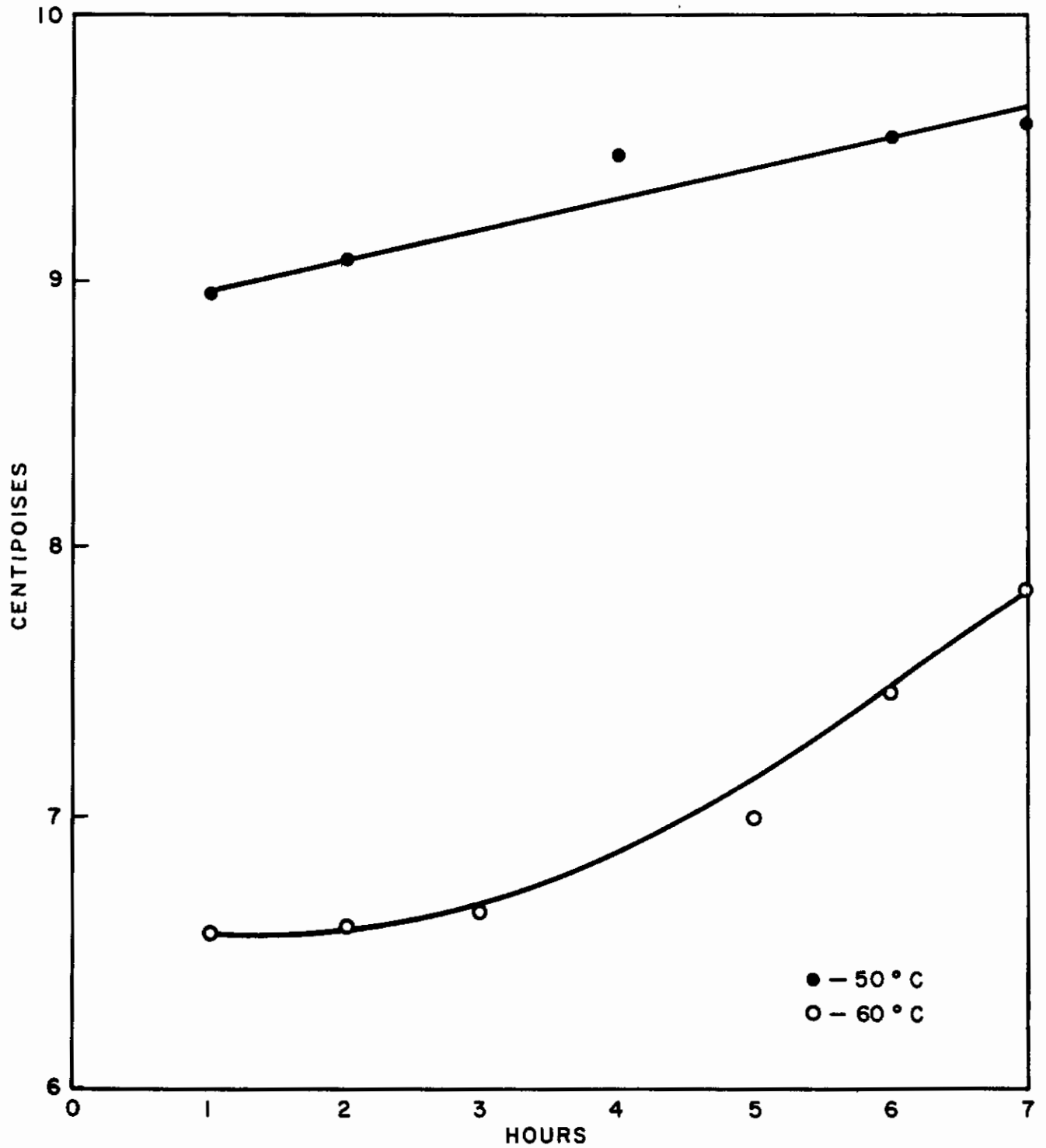

FIG.18 EQUAL MIXTURES OF FURFURYL ALCHOL RESIN (257 cps), AND RESIN DISTILLATE (4.75 cps), CATALYZED WITH 0.5 % METHYL p - TOLUENE - SULFONATE. VISCOSITY VS. TIME AT 50 AND 60° C.

the mixture polymerized at a faster rate. This indication is supported by the fact that the 60° C curve for the mixture has practically the same shape as the 65° C curve for the distillate. These experiments show that it is feasible to use distillate-resin mixtures, if so desired, but the room-temperature viscosity for the mixture will be much higher than for the distillate itself. Also, it is indicated, as previously assumed, that the resin and the distillate differ only by degree in their speed of resinification, the resin being the faster.

Unfortunately, the thermoset yields for this distillate are only about 89 per cent, and the best coking yield obtained was 45.3 per cent, based on the liquid starting weight. This is little better than monomeric furfuryl alcohol.

4.4. Resin Modifications

Two different modifications were examined very briefly -- that is, the introduction of cyclopentadiene and of a phenolic compound in a furfuryl alcohol resin.

It was proposed that cyclopentadiene, C_5H_6 , might be made to react with furfuryl alcohol condensates, either through one of the double bonds of cyclopentadiene or through its CH_2 group. The advantage of such a modification would be that the carbon content of the resin would be raised due to the high carbon content of cyclopentadiene. In a series of experiments, from 5 to 25 per cent of dicyclopentadiene were added to samples of a 13 per cent furfuryl alcohol resin. The mixtures were catalyzed with 0.25 per cent pTSA and cured at gradually increasing temperatures up to 105° C. The cured samples had a faint odor of cyclopentadiene, but when they were cut in half, the odor became quite strong. Most of the cyclopentadiene was lost simply by heating the sample halves. It was concluded that the cyclopentadiene had been trapped in, but not reacted with the furfuryl alcohol resin. In another experiment, 10 per cent dicyclopentadiene was added to the furfuryl alcohol used in the preparation of resin by alumina catalysis. Indications were that at least part of the cyclopentadiene had taken part in the reaction, but further experiments are needed to substantiate this.

One exploratory experiment also was carried out in which 10 per cent resorcinol was added to the furfuryl alcohol used in the preparation of the resin. The rate of condensation was about four times faster than normal. That the resorcinol should take part in the condensation reaction is not surprising in view of the great number of references in the literature to the effect that phenolic compounds can be incorporated in furfuryl alcohol resins. The interest in this type of modification is that the aromatic nuclei introduced in this manner might have a favorable effect upon graphitization of the furfuryl alcohol resin.

4.5. Pyrolysis Studies of Furfuryl Alcohol Resins by Gas Chromatography

Data obtained for the gas analyses at the various temperature intervals are presented in Table 2. However, to present the data in a more

Table 2. Gaseous Products from the Thermal Decomposition of Furfuryl Alcohol Polymer

COMPONENT	POLYMER SAMPLE #	5 · 10 ⁻⁷ IMOLES / INDICATED TEMPERATURE RANGE (°C)											TOTAL				
		100	150	200	250	300	350	400	450	500	550	600		650	700	750	800
HYDROGEN	1							TRACE	0.095	0.294	0.703	0.626	2.22	2.96	2.38	3.58	12.86
	2							TRACE	0.075	0.312	0.657	1.22	1.67	2.74	2.43	2.18	11.28
	3							TRACE	0.122	0.330	0.695	1.43	1.84	3.21	2.74	2.95	13.32
CARBON MONOXIDE	1							0.356	0.905	0.685	0.385	0.278	TRACE				3.94
	2						TRACE	0.427	1.34	0.683	0.440	0.346	0.210				4.90
	3						0.137	1.01	0.548	0.283	0.133	0.109					2.22
CARBON DIOXIDE	1			0.009	0.136	0.437	0.543	1.02	0.373	0.068	0.060	0.030	0.027				3.05
	2			TRACE	0.022	0.198	0.434	0.384	0.230	0.108	0.067	0.034	0.023	0.014			1.84
	3		TRACE	0.014	0.152	0.523	0.695	0.590	0.320	0.192	0.052	0.070	0.060	0.030			3.16
METHANE	1							0.105	0.638	1.40	1.04	0.669	0.260	0.143			5.96
	2							TRACE	0.672	1.05	0.777	0.495	0.330	0.185	0.052		4.86
	3							TRACE	0.547	1.40	1.04	0.482	0.181	0.205		0.108	5.36
ETHANE	1							0.032	0.226	0.476	0.068						0.802
	2							TRACE	0.069	0.246	0.111	0.022					0.448
	3							0.014	0.140	0.360	0.189	0.073					0.776
ETHYLENE	1								TRACE	0.098	0.060	0.015					TRACE
	2								0.038	0.023	0.018						0.211
	3								0.023	0.018							0.041
PROPANE	1							TRACE	0.179	0.016	0.023	0.016					0.217
	2								0.016	0.023	0.016						0.055
	3								0.035	0.082	0.012						0.129
PROPYLENE	1								TRACE	0.038	0.038						TRACE
	2								0.015	0.060	0.038						0.113
	3								0.006	0.018							0.024
FURAN	1							0.012	0.050	0.029	TRACE						0.095
	2							0.008	0.019	0.031	0.048	0.022	0.004				0.201
	3				TRACE	0.004	0.011	0.015	0.038	0.034	0.009						0.111
METHANOL	1			TRACE	0.029	0.049	0.034	0.029	0.021	0.007							0.169
	2	0.015	0.021	0.045	0.136	0.116	0.092	0.072	0.030	0.017							0.544
	3	0.012	0.041	0.068	0.062	0.058	0.042	0.031	0.007								0.321
ETHANOL	1																0.015
	2								0.015								
	3																
PROPANOL	1																0.032
	2								0.006	0.017	0.009						
	3																
WATER	1	0.149	0.309	0.434	0.614	0.683	0.625	0.718	0.924	0.970	0.867	0.920	1.036	1.09	0.524		9.86
	2	0.008	0.148	0.206	0.433	0.683	0.683	0.455	0.740	1.32	1.86	1.10	0.570	0.445	0.165	0.056	8.87
	3	0.096	0.186	0.348	0.387	0.532	0.608	0.865	0.955	0.880	1.09	1.03	0.970	1.21	0.536	0.504	10.20

* POLYMER SAMPLES 1=BASE FURFURYL ALCOHOL POLYMER 2=ALUMINA-FILLED RESIN 3=COKE FILLED RESIN

illustrative manner, the results were calculated on a molar basis and plotted against temperature. The actual units are moles of gas per milligram of base polymer per degree centigrade. The results of these plots are shown in Figures 19, 20, and 21. The distribution of the low levels of hydrocarbons from the same three polymers are plotted on an expanded scale, Figure 22.

These profiles (Figures 19-22) clearly illustrate the relative rate and temperature at which the various pyrolysis products are obtained. For example, in the base furfuryl alcohol polymer (Resin 1), the only component released below 200°C is water. Carbon dioxide begins to evolve at 200°C and continues to rise in quantity until it is a major component at 325°C; water is present in approximately the same quantity.

Water continues to increase in quantity to another maximum at 425°C, and at this temperature carbon monoxide is the predominant peak, but it is not much greater than the water component. Some carbon dioxide, methane, and a little ethane are present. At 475°C, methane is the major component with water still present in considerable quantity; ethane, although at its peak, is a minor component -- about one-third the quantity of methane. Hydrogen is present but only to the extent of a few per cent.

Methane continues to be the major component to about 550°C. At 600°C there are almost equal quantities of water, hydrogen, and methane, with small quantities of other gases. After 650°C, hydrogen becomes the major constituent and shows a rapid increase up to 725°C. Between 725° and 825°C a small dip in the curve is obtained, after which the hydrogen content continues to increase rapidly. Water and methane continue to fall off to low values after 700°C.

Two polymer-filler samples were investigated using the procedures outlined for the study of the base polymer. Furfuryl alcohol resin was used as the binder for both samples, one of which contained a coke filler while the other contained an aluminum oxide filler. For this work, gas chromatography analyses were performed on a portion of the specimens, and the results were calculated on the basis of the binder content or millimoles of gas per milligram of actual resin.

The results obtained for the resin-coke specimen exhibited much similarity in the over-all elution profile to the profile for the base polymer. This is easily justified in that the coke filler would not be expected to initiate any gross catalytic effect during pyrolysis. Rather, one might expect the coke to behave more as a diluent or, at best, a surface site for moderating the degradative processes. This would be borne out by the smooth curves obtained for carbon dioxide and methane which, for the base polymer, showed very abrupt variations. However, this generalization would not be applicable to the evolution of water, which in the coke-filled sample exhibits a jagged sawtooth-like profile in contrast to the three rather smooth maxima obtained for the base resin. In spite of

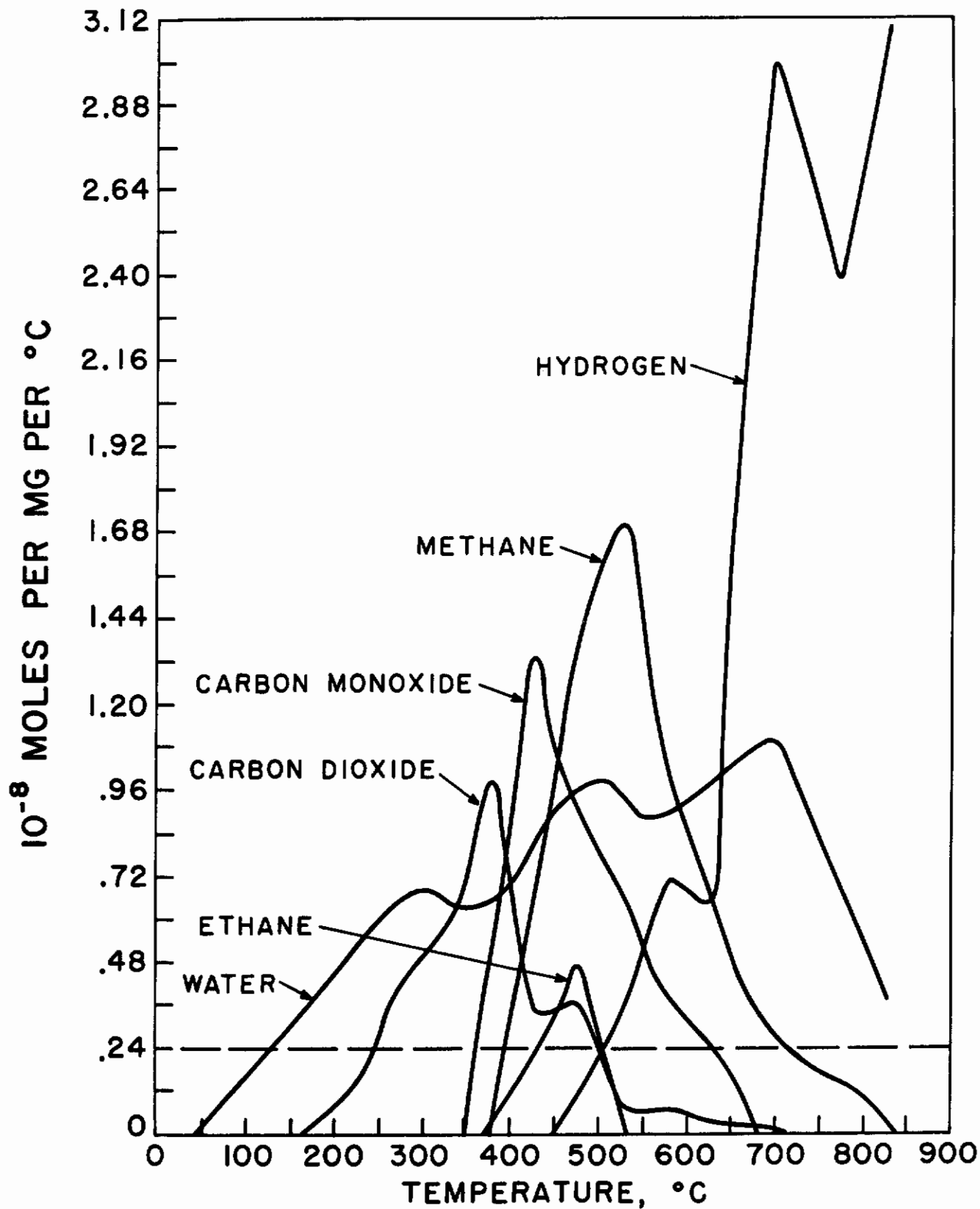

FIG. 19 ELUTION PROFILES OF PYROLYSIS PRODUCTS FROM ALUMINA CONDENSED RESIN

Continued

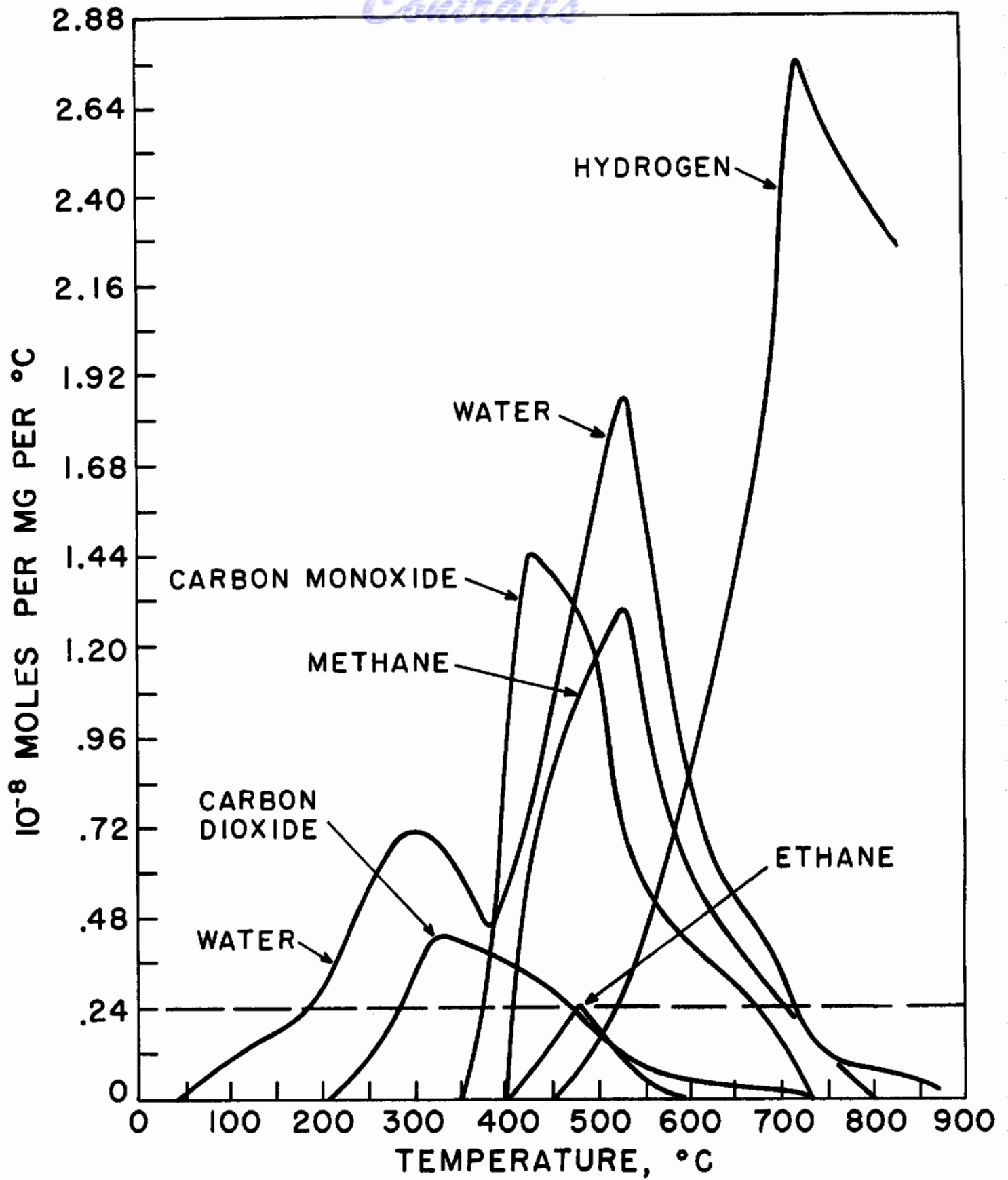

FIG. 20 ELUTION PROFILES OF PYROLYSIS PRODUCTS FROM ALUMINA CONDENSED RESINS CONTAINING 80.7 % ALUMINA FILLER

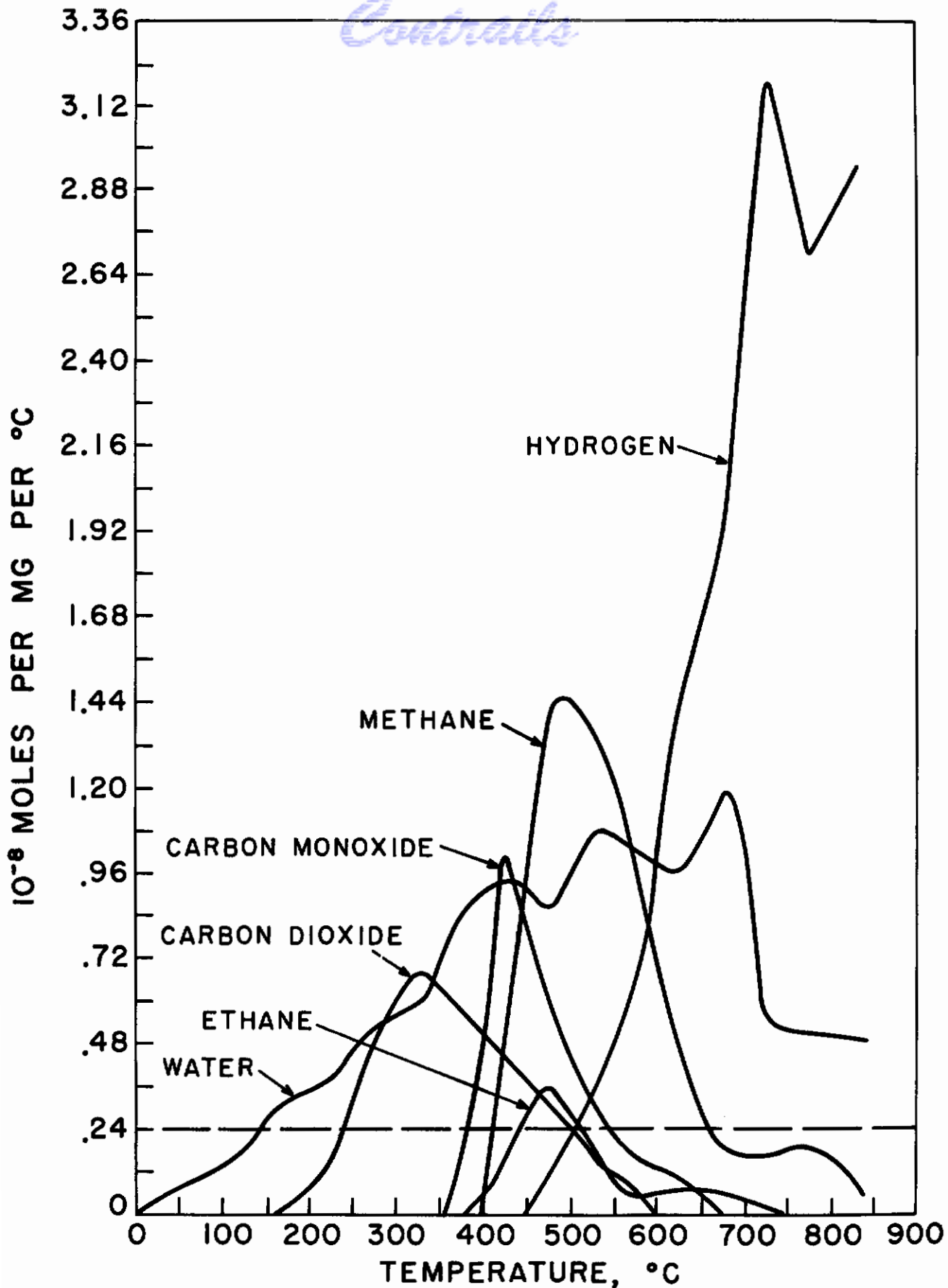

FIG. 21 ELUTION PROFILES OF PYROLYSIS PRODUCTS FROM ALUMINA CONDENSED RESIN CONTAINING 60% PETROLEUM COKE FILLER (RESIN NO. 3)

Contrails

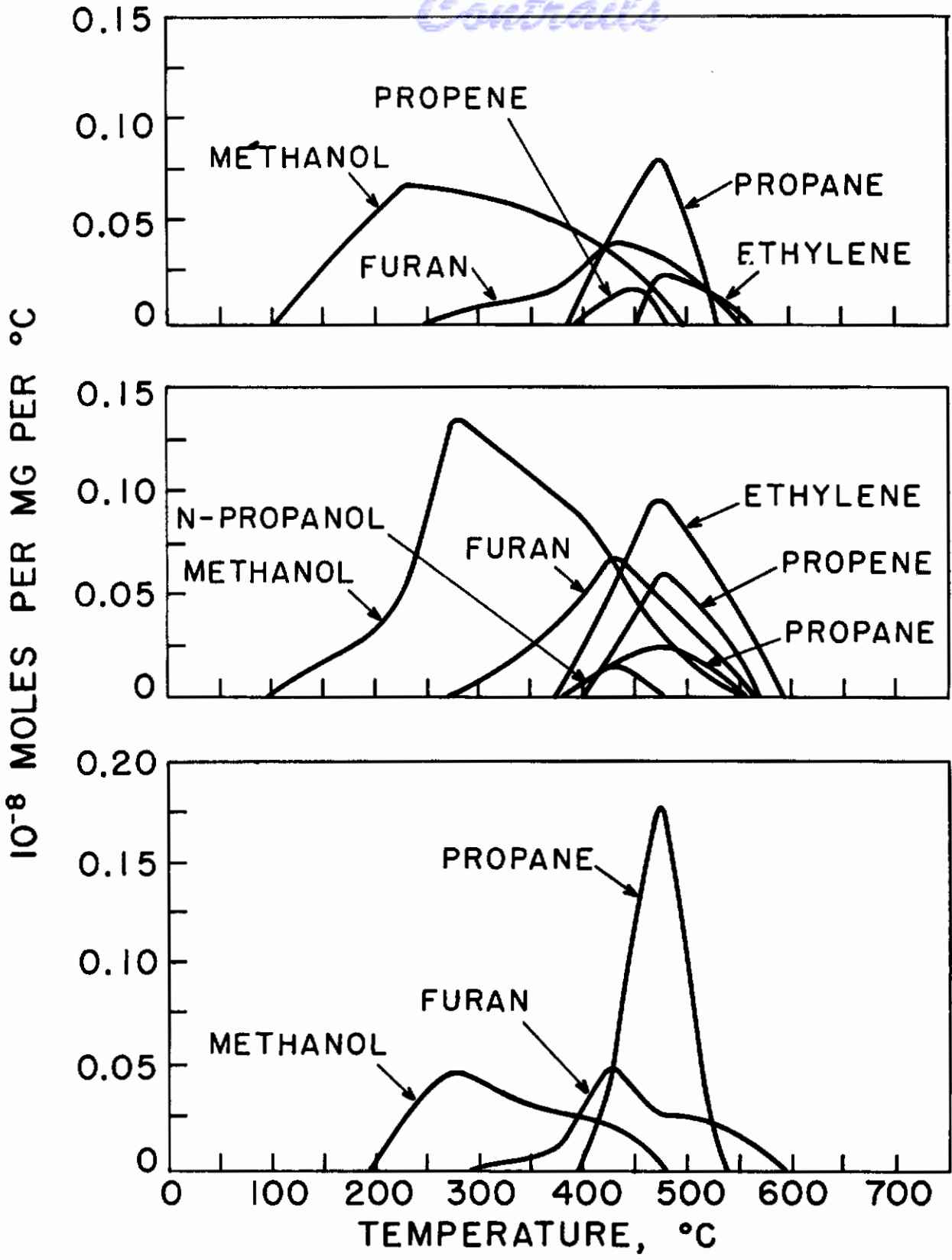

FIG. 22 COMPOSITE OF ELUTION PROFILES OF PYROLYSIS PRODUCTS FROM RESIN 1 (BOTTOM), 2 (MIDDLE), AND 3 (TOP) EXHIBITING LESS THAN 0.24×10^{-8} MMOL OF PRODUCT PER DEGREE.

Conclusions

these minor differences, all three of the above components, carbon dioxide, methane and water produce almost identical quantities of evolved material.

In contrast to the coke-filled resin, the aluminum oxide-filled sample showed a completely different release distribution for the same off-gases. This difference, which is attributed to a catalytic effect introduced by the alumina filler, is most pronounced for the major components, i. e., water, carbon monoxide, and methane. Of particular interest is the lack of a water maximum at 700°C and the variation in the hydrogen evolution at about 775°C. There is also a marked change in the percentages of certain gases compared to those of the base polymer. Carbon dioxide, ethane, and propane show decreases of 39.5, 44 and 77 per cent, respectively, while furan, carbon monoxide, and methanol show increases of 53, 20 and 69 per cent, respectively. Also, low levels of substituted furans, such as 2-methyl furan and 2,5-dimethyl furan, were detected solely from the alumina-filled resin.

The last two components were identified qualitatively from mass-spectrometry analysis and were not part of the off-gas analysis by gas chromatography. This procedure involves subjecting a separate sample of the base polymer to the entire temperature range and collecting all the gases as a single sample. The temperature in this case was not raised above 650°C because all the hydrocarbons show up before this temperature is reached, and continued heating to 850°C would merely dilute the sample with large quantities of hydrogen.

Results of the mass-spectrometry analysis, which was performed solely to check the qualitative identification of the various components of the base binder and the aluminum oxide-filled resins, are presented in Table 3. In view of the differences in the actual heating and sampling techniques between the gas-chromatography and the mass-spectrometry procedures, one cannot directly correlate the values.

A summary of the total weight percentage of the identifiable degradation products for each polymer is present in Table 4 along with the weight per cent loss per weight of base polymer in each sample.

Information from a series of controlled pyrolyses can be useful not only for the identification of the individual components present in the pyrolysates but also to give some insight as to the general types of reactions and temperatures involved in their formation. It may also aid in interpreting differential thermal analyses performed on the same resin mixtures.

Profile tracings of the off-gas compositions as presented in Figures 19-22 indicate three basic steps to the pyrolysis mechanism. The first step, starting at temperatures as low as 150°C and continuing up through approximately 350°C, involves dehydration and decarboxylation reactions.

Table 3. Results of Analysis of Furfuryl Alcohol Resin and Aluminum Oxide Resin Mixture by Mass Spectrometry

Component	Base Resin, mol %	Aluminum Oxide Resin, mol %
Hydrogen	8.2	10.1
Carbon monoxide	27.1	35.7
Carbon dioxide	19.3	13.8
Methane	32.2	24.7
Ethane	4.5	2.8
Propane	6.6	4.0
Propene		0.9
Furan		0.6
2-Methyl furan		2.8
2,5-Dimethyl furan		1.4
Methanol	0.8	1.1
Residual gases	1.3	2.1

Table 4. Distribution of Pyrolysis Products
Based on Weight Per Cent of Total
Weight Loss of Each Polymer

Component	Furfuryl Alcohol Polymer		
	No Filler	Aluminum Oxide Filler	Coke Filler
Hydrogen	3.100	2.380	3.214
Carbon monoxide	13.300	14.340	7.107
Carbon dioxide	16.100	8.602	16.409
Methane	11.830	8.381	9.998
Ethane	2.900	1.354	2.730
Ethylene		0.623	0.143
Propane	1.150	0.266	0.658
Propene	Trace	0.504	0.105
Furan	0.788	1.498	0.852
Methanol	0.658	2.092	1.273
Ethanol	0.053	0.071	Trace
n-propanol	Trace	0.226	
Water	<u>21.200</u>	<u>17.054</u>	<u>22.120</u>
Total	71.17*	57.39*	64.1*
Total weight per cent loss per weight of base polymer (mg/mg)	41	43	47

* Represents weight per cent of identified pyrolysis products per total weight loss of base polymer of each sample.

Contrails

The second, or intermediate, step involves carbon-carbon scission with the formation of free radicals which produce by disproportionation a series of low molecular hydrocarbons as typified by the relatively large volume of methane. This phase occurs in all the resin mixtures in the temperature range of 375° to 600° C with a sharp maximum at 500° C. The third step involves dehydrogenation of the resin mixture and has an abrupt increase after 600° C.

Regardless of these characteristic reproducible evolution patterns, the mechanism involved in the pyrolysis of furfuryl alcohol resins is neither simple nor straightforward. Adding to the difficulty of a mechanistic interpretation is the fact that there are degradation products such as formaldehyde which are capable of being reabsorbed by the base polymer to act as crosslinking agents. In addition, the resins can further polymerize not only during thermal degradation but also through nuclear double bonds and can undergo major nuclear rearrangements. The presence of these factors, plus the fact that there can be considerable overlapping between the three general steps, are indicative of the uncertainty which would be associated with designating the origin of each component.

In spite of this ambiguity, the profile curves exhibit definite variations or shifts for certain components which can be directly attributed to the particular filler or aggregate used with the base binder. In comparing the two fillers used, aluminum oxide gave the greatest variation. For instance, in the base polymer, water peaks were observed at 300°, 500°, and 700° C, while the alumina-filled resin had peaks only at 300° and 525° C. However, the total water removed (2.06×10^{-8} mmol) during the latter two maxima in the base polymer was almost equal to the total quantity of water removed at the 525° C single maximum from the alumina resin (1.86×10^{-8} mmol). Therefore undoubtedly, alumina effectively catalyzes the final stages of pyrolysis (ring opening) by dehydration of the resin mixture at a temperature nearly 200° C below that of the base binder.

Another variation noted in the alumina-resin mixture as opposed to both the base and the coke-filled resin is an increase in the amount of unsaturated hydrocarbons over that of the saturated homologues. For instance, with the alumina filler ethylene was increased fivefold over the coke-filled resin, while ethane was correspondingly reduced by almost 50 per cent. Only trace quantities of ethylene could be detected in the base binder. The same was true for propylene which was also increased fivefold in the alumina-resin mix with a corresponding decrease in propane of approximately 50 and 75 per cent for the coke-filler and base polymer, respectively. Increases in furan and methanol were also noted. However, since the latter component was added exogenously as a diluent for the p-toluenesulfonic acid catalyst in the curing procedure, its presence must be qualified even though traces of other alcohols, such as ethanol and propanol, were also detected.

It is apparent that certain filler materials used in furfuryl alcohol resins can exhibit an appreciable effect on the thermal degradation of the

base binder and the effect can be demonstrated by this pyrolysis procedure. It is unlikely that an analysis of the total off-gas products collected as a single specimen could exhibit such a variation.

4.6. Differential Thermal Analysis

The technique of differential thermal analysis was employed to follow both the thermosetting and the pyrolysis reactions. Although the thermograms are difficult to interpret directly, correlating them with the gases evolved on pyrolysis lends support to an interpretation of the overall pyrolysis reactions. Figures 23 and 24 show the composite thermosetting and pyrolysis curves obtained for a 13 and a 15 per cent resin.

The thermosetting reaction (25°-150° C) is seen to be generally exothermic with a small endotherm near the top of the peak representing the final condensation in going from the liquid to the solid state. The large pyrolysis exotherm starting at 175° C coincides with the initial appearance of CO₂ and methanol; this represents a major structural change. There is no indication of formaldehyde in the pyrolysis gases; thus, any evolved formaldehyde (from terminal methylol groups) could either undergo polymerization or be reabsorbed by the resin in a crosslinking reaction, possibly involving the β -hydrogen of the furan ring. This mechanism would also give rise to the elimination of water and may account for the continuity of the first water peak.

Formaldehyde elimination during this exothermic reaction might also be correlated with the evolution of carbon dioxide, since both steps would require carbon-carbon cleavage. Carbon dioxide could arise either from the decarboxylation of various acidic components, such as levulinic acid, or by means of some nonspecific oxidation process. All three of the peaks for carbon dioxide evolution fall in close proximity to the three intermediate exothermic reactions of the differential thermal analysis curve.

The third exothermic reaction, at 360° C, may then represent additional intermolecular polymerization along the nuclear double bonds. This is reasonable in view of the lack of any appreciable quantities of new elimination products in the off-gases up to this temperature although trace quantities of furan begin to show at 275° to 300° C.

The exothermic reaction at 450° C possibly represents a continuation of the exothermic reaction at 360° C, with an interruption by strong gas evolution as indicated by the abrupt increase in carbon monoxide at 425° C.

The presence of large quantities of carbon monoxide could be associated with the depolymerization of homopolymers of formaldehyde, which yield predominantly carbon monoxide and hydrogen. This depolymerization could occur simultaneously with the intermolecular polymerization of the furan rings. However, the absence of hydrogen in this region would tend to eliminate this mechanism.

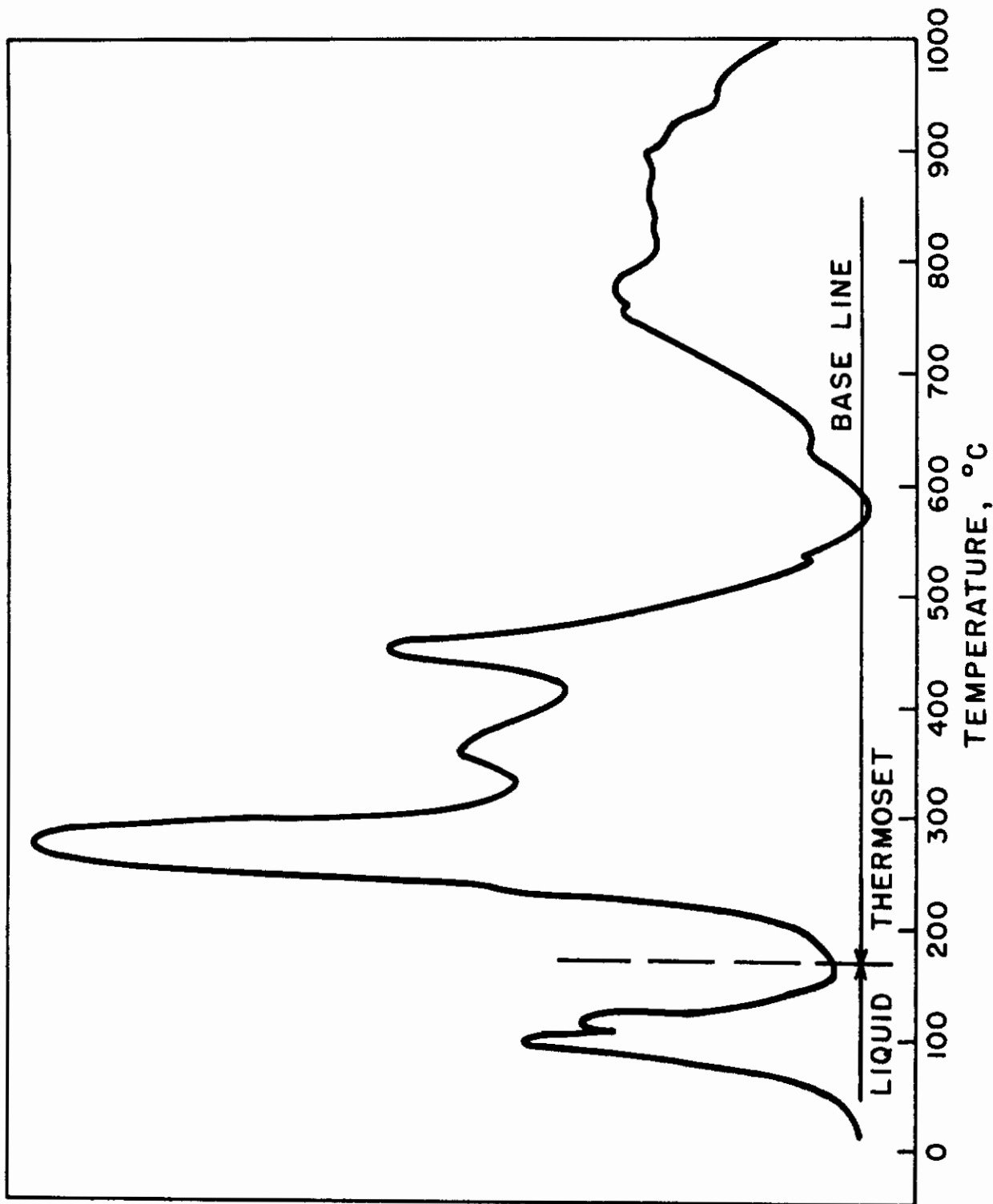

FIG. 23 DTA TRACE OF ALUMINA CONDENSED F. A. POLYMER
850 CPS, 13% H₂O REMOVED

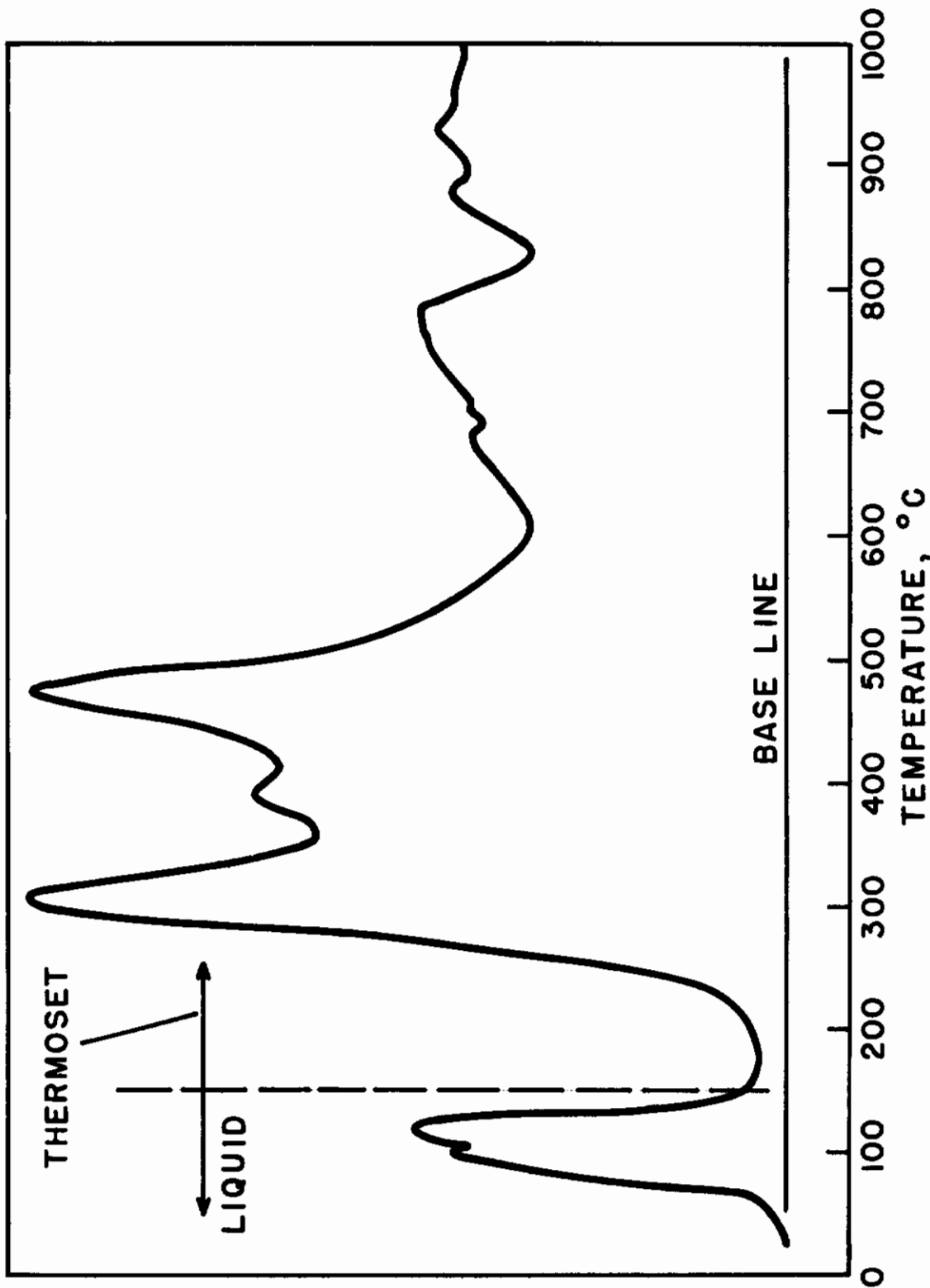

FIG. 24 DTA TRACE OF ALUMINA CONDENSED F. A. POLYMER
8150 CPS, 15.2% H₂O REMOVED

Alternately, if gas evolution does interrupt, a change in the overall mechanism may be indicated. For instance, the exothermic reaction at 360°C may well represent an ethylenic type polymerization along the nuclear double bonds. However, the exothermic reaction at 450°C is located directly in the center of the region where disproportionation reactions are taking place through a free-radical mechanism. This is evident from the rapid increase in methane and the various low-molecular-weight hydrocarbon gases. Undoubtedly, carbon-carbon scission is occurring. The ratio of methane in respect to the other hydrocarbon gases indicates scission of the crosslinking methylene groups. Following the release of the bridge methylene groups, the furan nuclei could either recombine, yielding directly connecting furan nuclei, or, as suggested by the slight water maximum just behind this exothermic reaction at 500°C, also give rise to ring opening where the furan nucleus can either be cleaved with the release of water or rearranged to larger six-membered rings. The steep return to the base line following the exothermic reaction at 450°C may be accounted for, at least in part, by the large methane evolution with its maximum at about 525°C.

The fact that ring opening and subsequent pyrolysis is not confined solely to this region is demonstrated by the third and largest water maximum at 700°C, which in addition also corresponds to an extremely vigorous hydrogen evolution. This would be expected to represent the main bulk of the ring oxygen and hydrogen. The base polymer and the coke-filled resin both exhibit a momentary dip in hydrogen evolution at around 775°C, just after the last water maximum at 700°C. However, the alumina-filled resin mixture does not show either of these characteristics, which suggests that the latter undergoes ring opening through the catalytic effect of the alumina at much lower temperatures.

Figure 25 shows the DTA trace of a monomer-free, acid-condensed resin. This resin also shows the exotherm generated in thermosetting. At about 100°C, an overriding endotherm is developed caused by the condensation reaction which endothermically expels water and other volatiles. Recovery from the endotherm into another exothermic region at 150°C gives the appearance of two separate thermosetting exotherms. In all probability, the thermosetting reactions are a single exotherm, interrupted by the volatile expulsion. The pyrolysis curve above 200°C is generally exothermic, with ill-defined peaks at 310°C and 360°C and a pronounced peak at 430°C.

Several attempts were made to determine possible binder-filler reactions by this technique. Unfortunately, the filler tends to obliterate all detail except for a general exothermic drift. Heat sink damping and different thermal diffusivities obscure the otherwise sharp binder reactions.

4.7. Cured Resin Yields

In the curing or thermosetting of furfuryl alcohol monomer, condensation reactions limit the cured resin residue to about 78 per cent of its starting weight. By converting the monomer to liquid polymers, sub-

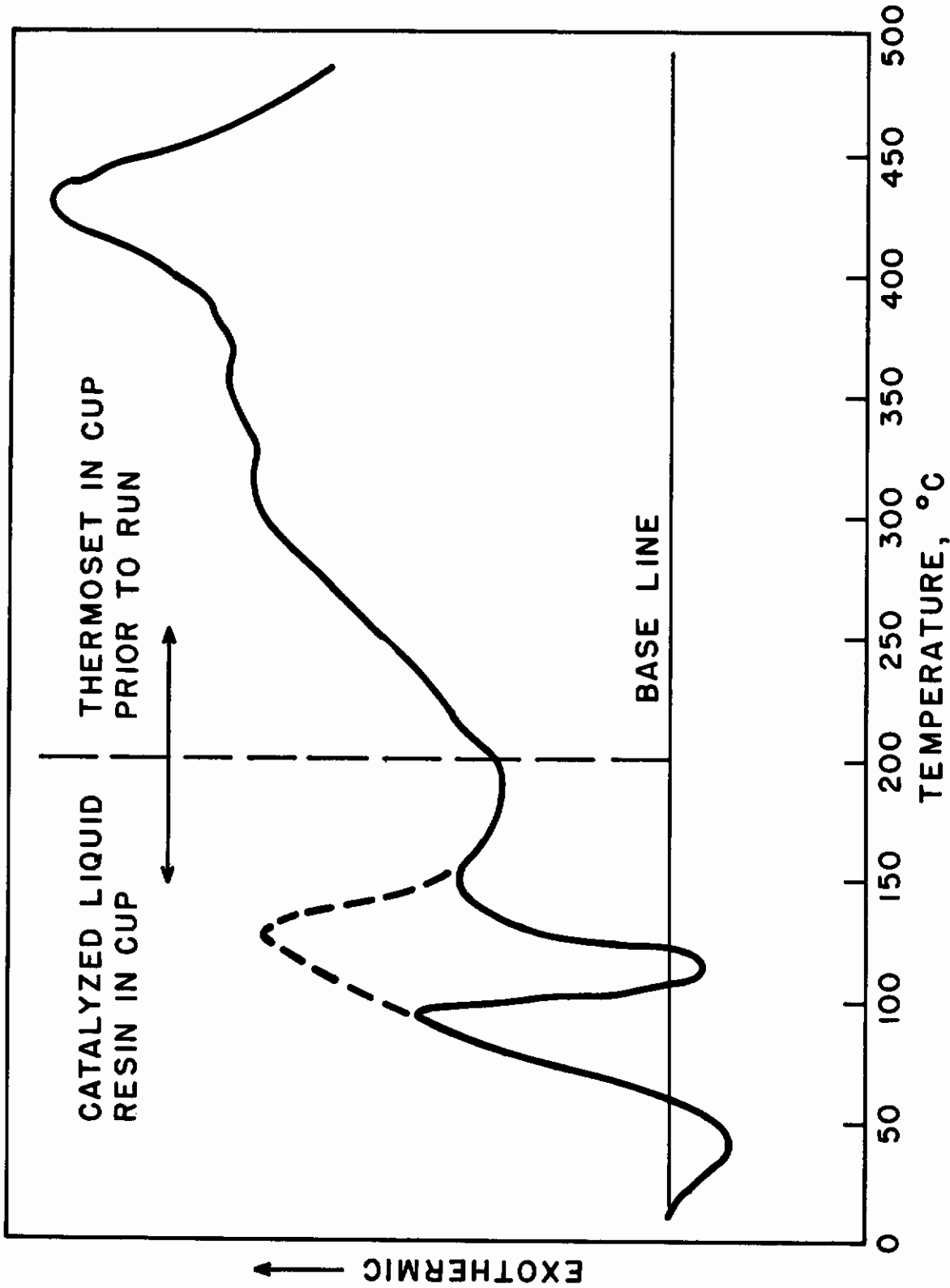

FIG.25 COMPOSITE DTA TRACE OF QUAKER OATS " MONOMER - FREE " FURFURY ALCOHOL POLYMER, 1% TOLUENE SULFONIC ACID

stantial amounts of the condensation products, such as water, can be removed prior to its use as a binder. This prepolymerization improves both the cured resin yield and the coking residue.

In the normal acid-condensed commercial resins, some short chain polymers are formed, but the resins still contain considerable amounts of unreacted monomer. On curing, these resins undergo condensation, split out water and other noncondensables, and in general have cured yields of about 90 per cent. Even in highly converted acid-condensed resins there is still a quantity of water generated in curing due to terminal OH groups. The conversion of monomer to polymer by alumina condensation, by removing large percentages of noncondensable liquids, and the fact that terminal OH groups are absent, result in cured resin yields of up to 99 per cent. Removal of the noncondensables also results in an increase in resin density from approximately 1.15 g/cc to 1.30 g/cc.

4.8. Thermogravimetric Analysis

Thermogravimetric studies were made on the alumina-condensed resins to determine both the shape of the weight-loss curves, and the percentage of coking residues. Figure 26 shows the weight-loss curves of 13 and 15 per cent resins on a two-hour linear coking schedule. The 13 per cent resin had a coke residue of 56 per cent; and the 15 per cent resin, 58 per cent, based on the original liquid resin weight. Carbonized densities, determined by mercury intrusion, were 1.52 g/cc. Samples of a 13 per cent resin, coked in atmospheres of argon, helium, hydrogen, carbon monoxide, nitrogen, and stagnant air, all had coke residues of 56-57 per cent. It is apparent that pyrolysis is not sensitive to atmosphere as far as yield is concerned.

4.9. Shrinkage Characteristics

Figure 27 shows length changes that occur during pyrolysis on a two-hour linear heating schedule. The 13 per cent resin (850 cps) which had previously been cured at 150°C, gradually expands until a maximum is reached at 250°C, where an abrupt reversal occurs and the sample begins to shrink. This reversal is about at the start of pyrolysis and is coincident with the first visual notice of water evolution. At this point, the cured resin also is in the softest stage in its thermal history, as evidenced by elastic properties determined on filled specimens. The coincidence of maximum softening and the pyrolysis threshold at roughly 250°C argues for great care in passing through this stage.

4.10. Microstructure

Coke produced from pyrolyzed resins has the general appearance of a black "glass." Each specimen carbonized had a visual network of fissures (Figure 28) but the carbon between fissures appeared very uniform and nonporous. Very small spots visible in the photomicrograph are probably air bubbles trapped during thermosetting.

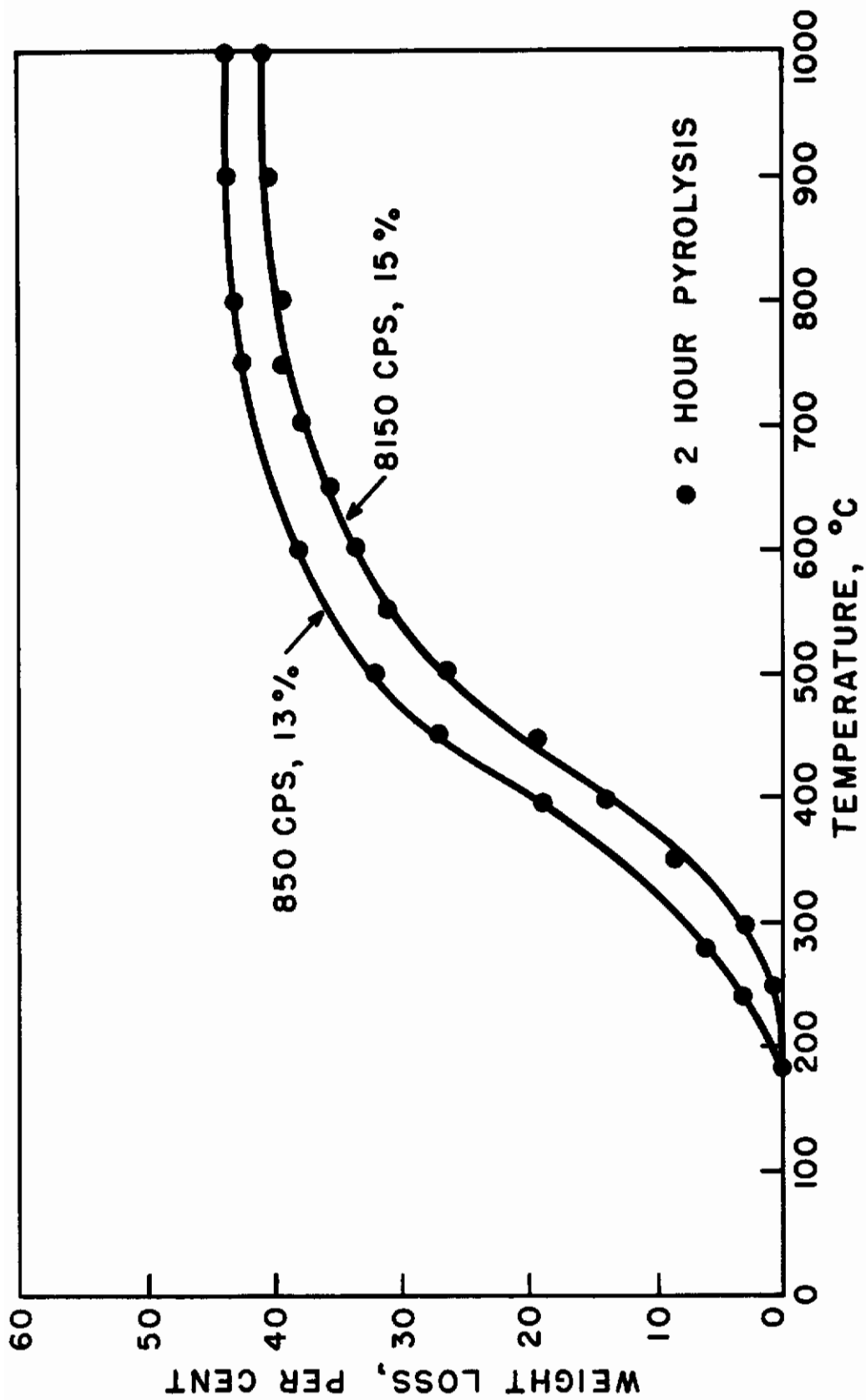

FIG. 26 THERMOGRAVIMETRIC ANALYSIS OF ALUMINA CONDENSED RESINS OF MEDIUM AND HIGH CONVERSION

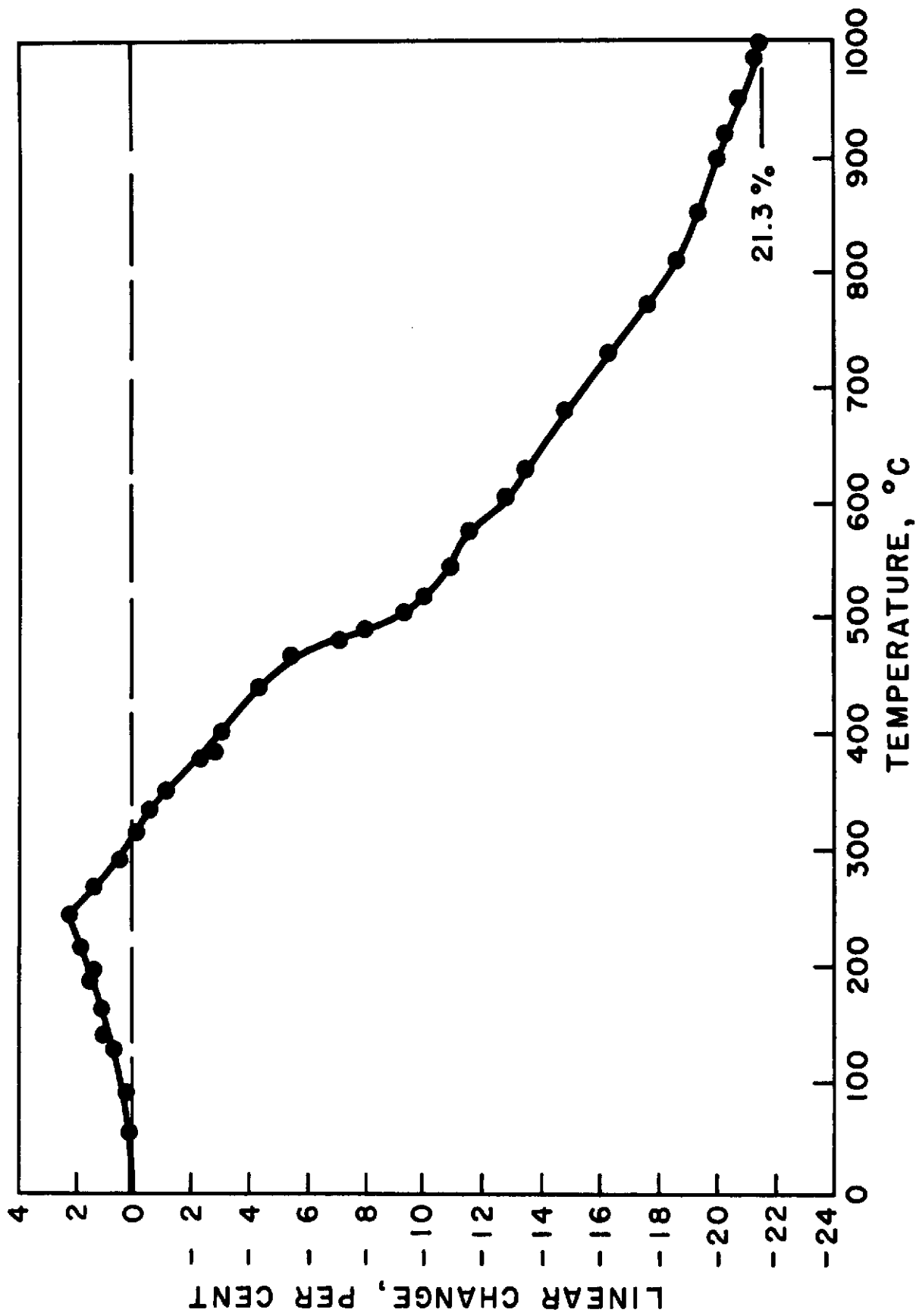

FIG. 27 CHANGE IN LENGTH OF ALUMINA CONDENSED POLYMER DURING PYROLYSIS. 850 CPS, 13% H₂O REMOVED

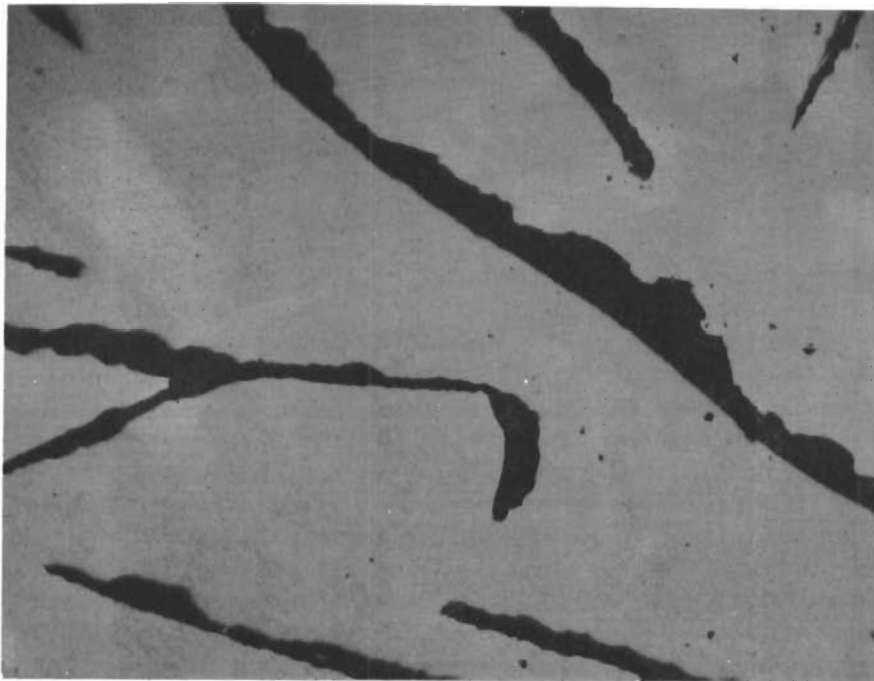

FIG. 28 PHOTOMICROGRAPH OF F. A. POLYMER COKED TO
1000°C SHOWING MACRO-FISSURES AND "GLASSY"
APPEARANCE OF INTER-FISSURE COKE REFLECTED
LIGHT, X 50

Distance between the macrocracks is considerably greater than the distance between packed particles; these cracks are not in evidence in molded composites. That the coke itself is nonporous is evidenced by mercury porosimeter measurements; such curves are very flat, indicating five per cent or less voids. However, even this small amount of porosity is questionable since similar curves have been obtained from smooth glass balls. The most reasonable explanation of the indicated voids is the final filling of the macrofissures by pressurized mercury.

The mercury density of a graphitized piece is slightly lower than that of the carbonized piece; 1.51 vs. 1.52 g/cc. This lower density is attributed to loss of hydrogen still retained in the carbonized state.

4.11. Dynamic Elastic Properties

The dynamic elastic properties of thermoset mixtures of resin with fillers of coke and alumina powders were continuously monitored from 25° to 1000°C. The elastic modulus of the coke-filled specimen (Figure 29) gradually decreased to a minimum value at about 225°C, after which it rose to a value higher than its starting point. As it cooled, it showed the typical flat trace observed for carbons and graphites over the temperature range. The rounded shape of the low values at 225°C is in direct contrast to the steep "V" shape of the alumina-filled sample (Figure 30). Also, the modulus of the alumina-filled specimen did not return to its starting point, and the piece was weak and friable after testing, whereas the carbon-filled specimen was still strong. It seems that a good chemical bond is established in the coke-filled sample, but that the alumina sample is simply held together by particle packing and some physical cementation. That a chemical bond is not established is evidenced by the clean surface of the alumina particles on a fracture surface. It seems likely that the bond is essentially destroyed during the interval represented by the low temperature "V."

4.12. X-Ray Diffraction Studies

In attempting to determine any difference in the graphitizability of furfuryl alcohol resins when used as a binder for petroleum coke as opposed to the resin by itself, the masking effect of the predominant petroleum coke phase tends to obscure the binder coke phase completely. In this examination, we have used an excess of binder (100 parts coke to 100 parts resin) in order to have an appreciable amount of binder coke (35 per cent) in the molded sample, thereby reducing the masking-effect of the filler coke.

The literature suggests that the semi-lattice spacing obtained from the position of (002) graphite peak may be selected as a measure of graphitization. Natural graphite with an (002) spacing of 3.36 A. U. could serve as an ultimate standard of comparison at one end, and some almost nongraphitizable material having an (002) spacing of approximately 3.45 A. U. could serve as the other end. Using this criterion, all the samples described in Section 3.7 except the resin coke alone would appear

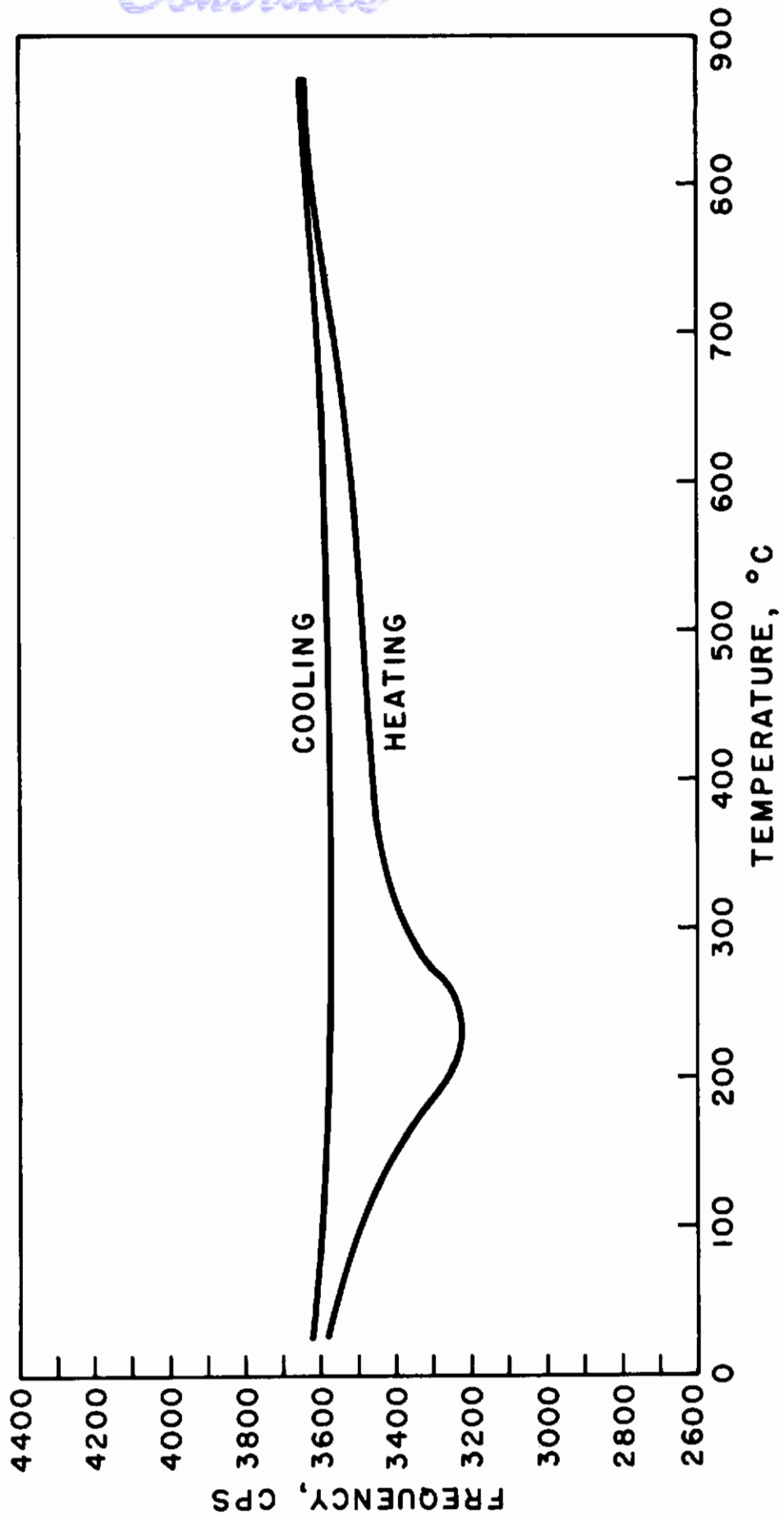

FIG. 29 GENERAL ELASTIC PROPERTIES OF COKE FILLED RESIN DURING PYROLYSIS

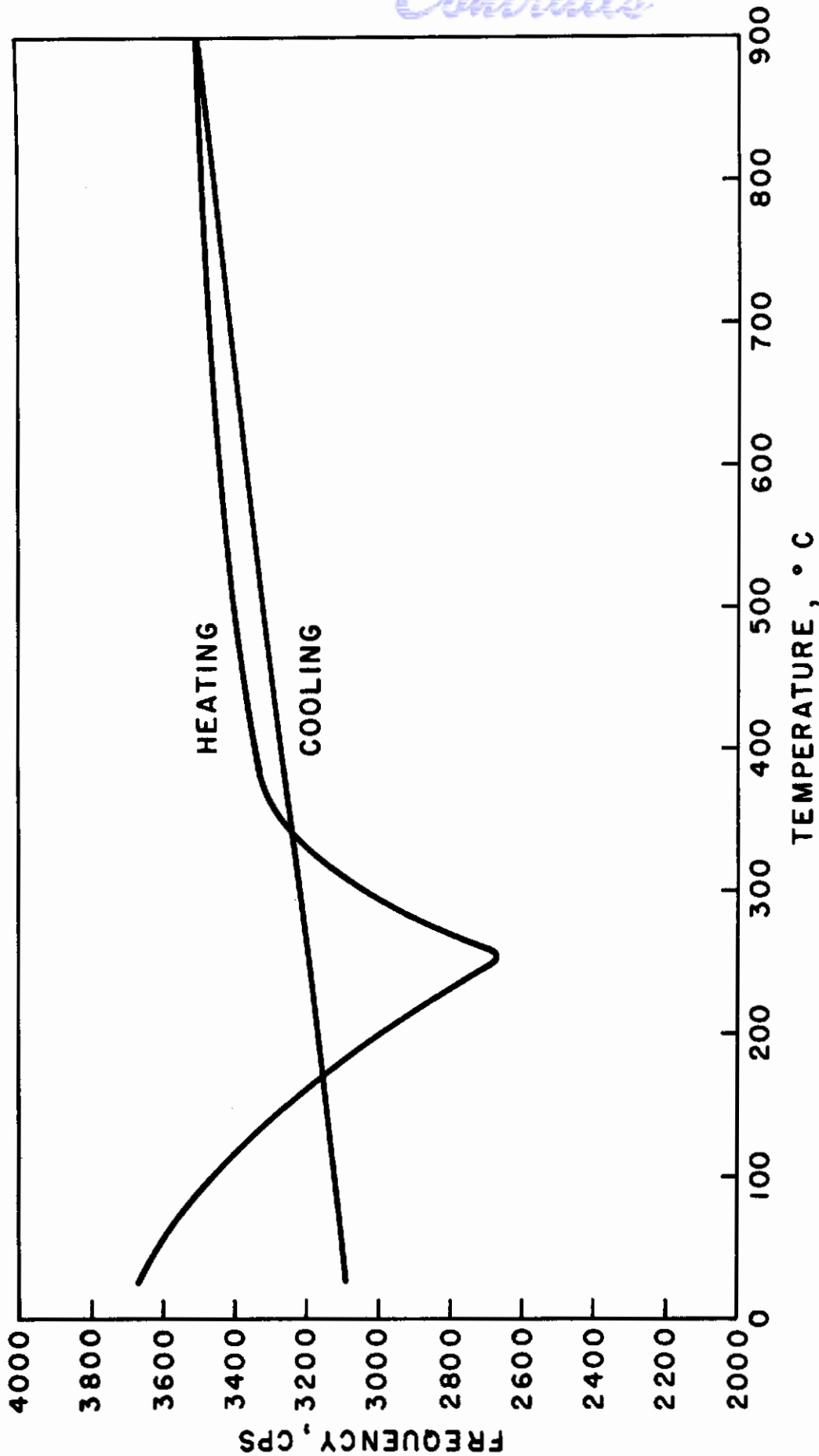

FIG. 30 GENERAL ELASTIC PROPERTIES OF ALUMINA FILLED RESIN DURING PYROLYSIS

Contrails

to be equally graphitized, while the resin coke is virtually nongraphitized. Obviously, for this case at least, the (002) spacing alone is not a sufficient measure of the difference in degree of graphitization.

Another indication of graphitization is modulation of the two-dimensional(hk) reflections. When the (10) and (11) reflections start to split into (100)-(101) and (110)-(112), it indicates that the parallel layer groups are beginning to assume ordered or graphitic relationships. Examination of the (10) and (11) reflections in the three samples containing petroleum coke all showed a definite indication of the splitting up into (100)-(101) and (110)-(112). This is expected as the petroleum coke graphitizes easily. What we were looking for primarily were slight or even subtle differences in the (hk) reflections between the molded coke-resin sample and the coke-resin mixture. The diffractometer tracings showed better resolution of the (100)-(101) lines for the molded sample than for the mixture. The line widths at half maximum, which in this case are only a very rough measure of the sharpness of the lines and hence the crystallinity, are also slightly smaller in the molded sample -- 1.3 to 1.6 cm for (100) and 4.4 to 4.8 cm for (101).

In order to check whether any other differences indicating changes in graphitization might be observed, flat cassette transmission photographs were made of each sample. These photographs (Figures 31-34) show the (002), (100)-(101), and (004) reflections for all the specimens containing petroleum coke, and only the (002) and (10) for the resin coke.

The chief difference between the patterns of the molded sample and the physical mixture was in the profile of the (002) reflection. This reflection in the molded sample was a very intense sharp ring. The same reflection of the mixture was also an intense ring, but in this instance it was superimposed on a broad diffuse ring, such as the (002) reflection from the resin coke. A photometer tracing or profile of the (002) in the molded sample appears to be a symmetrical curve, while in the mixture it is somewhat asymmetrical, tailing out toward the lower 2Θ (higher d-value) direction. This is consistent with the higher d-value of the (002) spacing for the poorly graphitized resin coke.

The superposition of patterns, such as apparently is present in the physical mixture of the two cokes, and the absence of an observable diffuse (002) contribution from the resin coke in the molded sample are evidence of an increased degree of graphitization when the resin is used as a binder in conjunction with an easily graphitized aggregate.

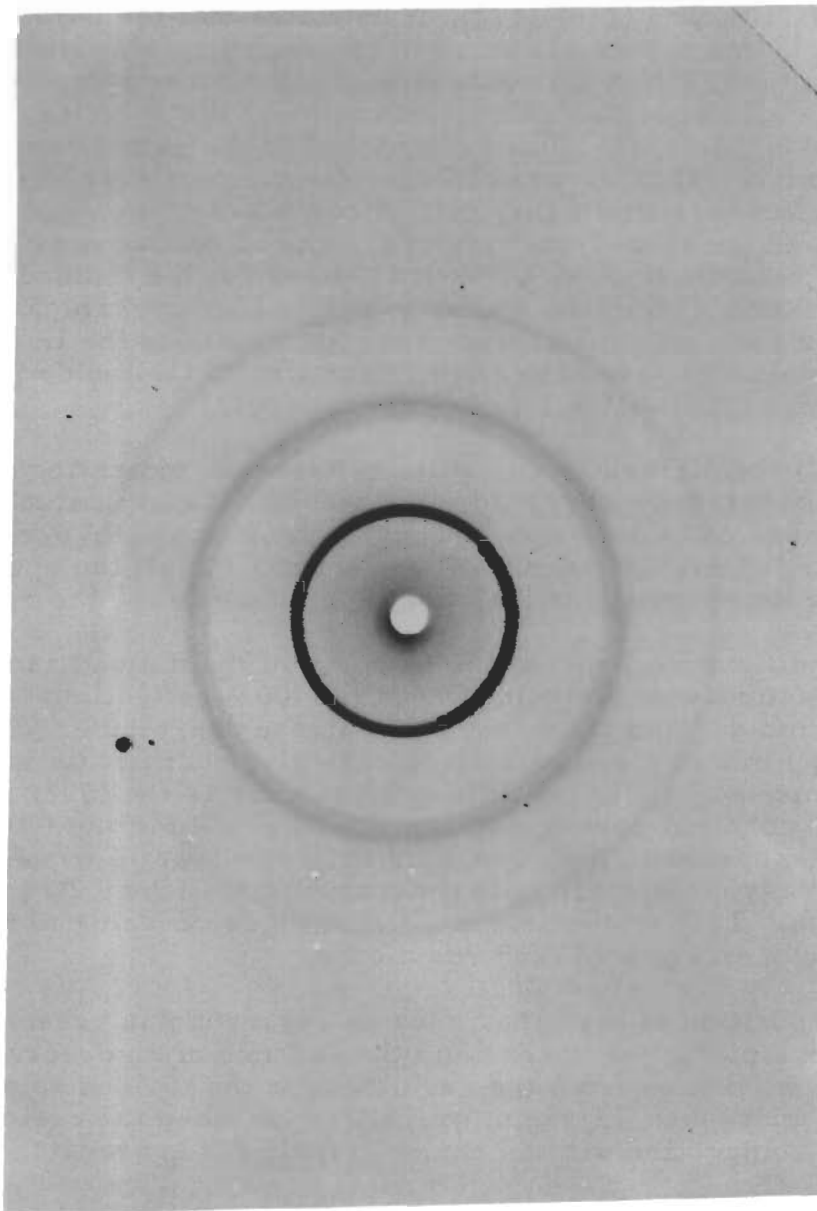

FIG.31 FLAT CASSETTE TRANSMISSION PHOTOGRAPH OF MOLDED SAMPLE.
(100 PARTS PETROLEUM COKE, 55.4 PARTS RESIN COKE).

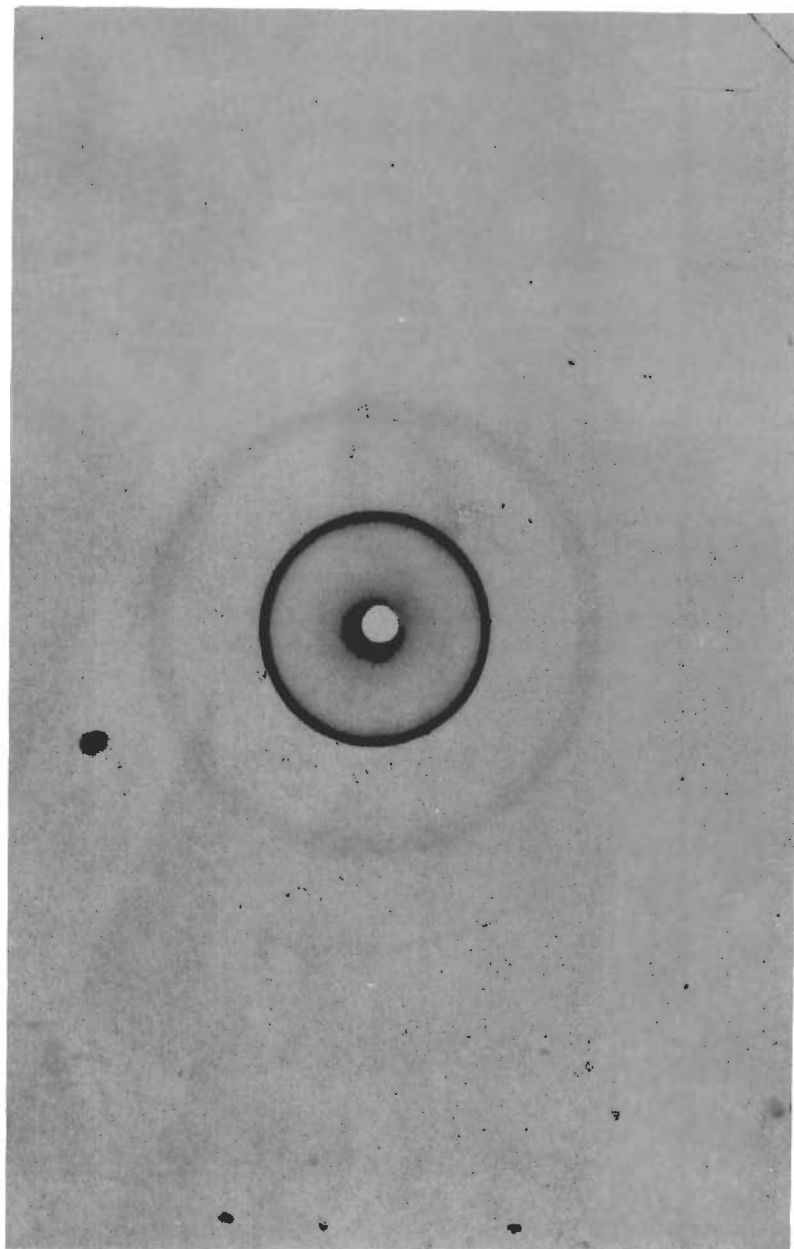

FIG. 32 FLAT CASSETTE TRANSMISSION PHOTOGRAPH OF PHYSICAL MIXTURE OF PETROLEUM AND RESIN COKES. (100 PARTS PETROLEUM COKE, 55.4 PARTS RESIN COKE).

2025 RELEASE UNDER E.O. 14176

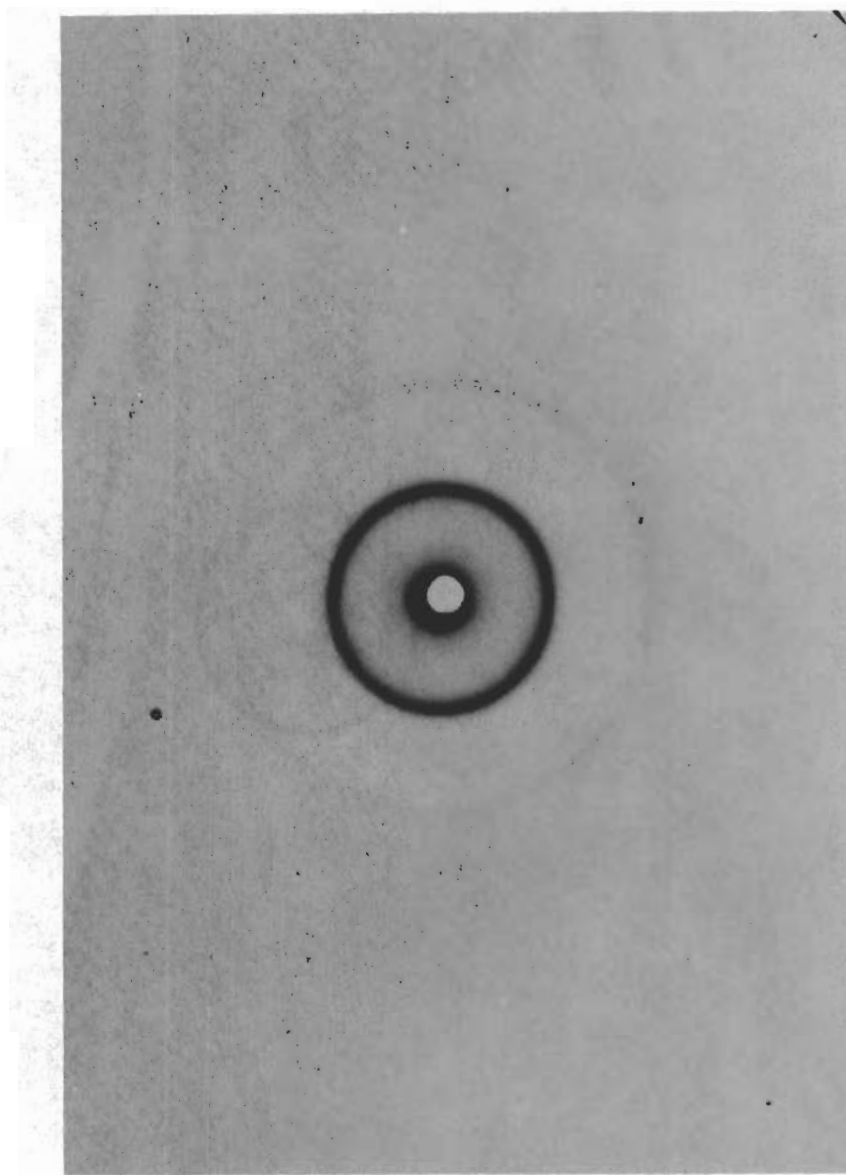

FIG. 33 FLAT CASSETTE TRANSMISSION PHOTOGRAPH OF RESIN COKE (100%).

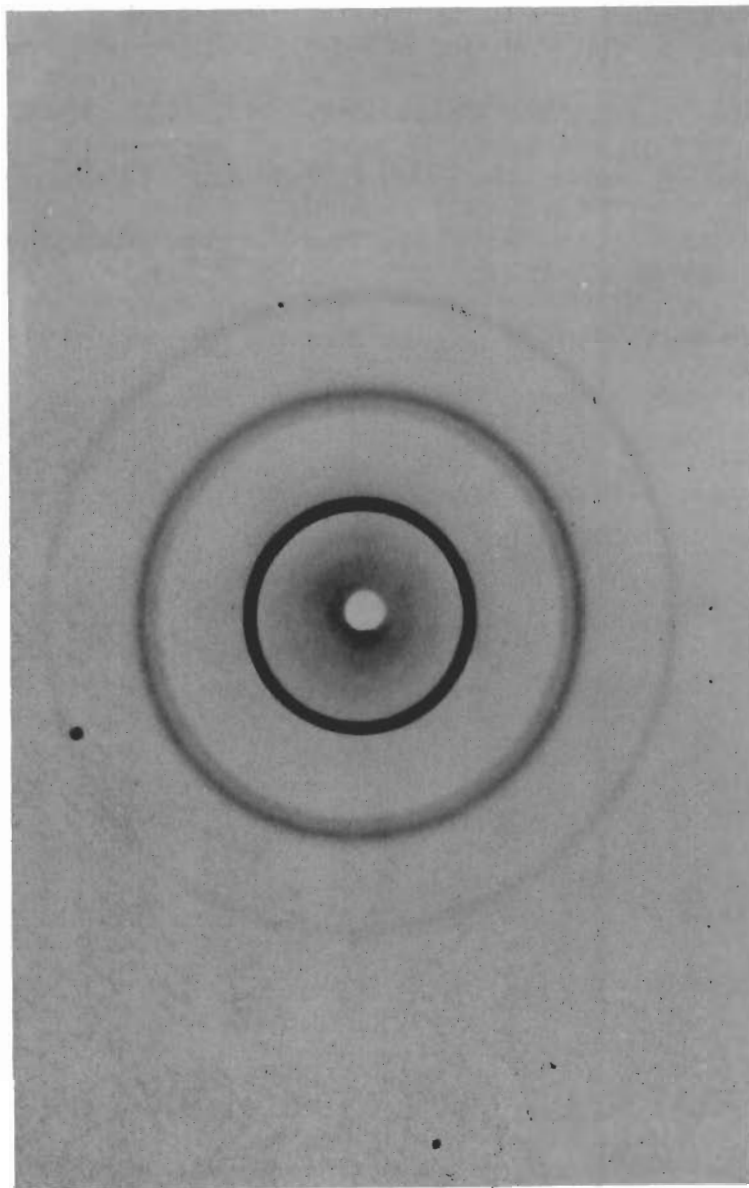

FIG. 34 FLAT CASSETTE TRANSMISSION PHOTOGRAPH
OF PETROLEUM COKE (100 %).

5. REFERENCES

1. A. E. C. Contract No. AT (33-3)-4, Task II, Mod. 1.
2. U. S. Patent No. 2,681,896, Erik R. Nielsen.
3. H. H. Nakamura and L. M. Atlas, "Proceedings of the Fourth Conference on Carbon" pp. 625-637, Pergamon Press, 1960.
4. J. E. Zanetti, J. Am. Chem. Soc., 49, 1065, 1927.
5. A. P. Dunlop and F. N. Peters, Ind. Eng. Chem., 34, 814, 1942.
6. A. C. S. Monograph No. 119, The Furans, Am. Chem. Soc., 1953, Washington, D. C.
7. Kenzo Takano, Nippon Kagaku Zasshi, 79, 955, 1958: C. A. 54, 4530e.

6. APPENDIX

Structural Formulas of Furfuryl Alcohol Resin Components

