

Contrails

AFAPL-TR-79-2095

② LEVEL II

DYNAMIC, HOT SURFACE IGNITION OF AIRCRAFT FUELS AND HYDRAULIC FLUIDS

Donald J. Myronuk
San Jose State University
San Jose, California

DTIC
ELECTE
FEB 2 1981
S B

October 1980

Technical Report AFAPL-TR-79-2095
Final Report for Period January 1977 - December 1979

Approved for Public Release; Distribution Unlimited

AERO PROPULSION LABORATORY
AIR FORCE WRIGHT AERONAUTICAL LABORATORIES
AIR FORCE SYSTEMS COMMAND
WRIGHT-PATTERSON AIR FORCE BASE, OHIO 45433

ENGINEERING DIVISION
BEECH AIRCRAFT CORPORATION
1-7-82

81 2 02 174

Approved for Public Release

AD A094382

#6.50

FILE COPY

7/2/82

-5-82

NOTICE

When Government drawings, specifications, or other data are used for any purpose other than in connection with a definitely related Government procurement operation, the United States Government thereby incurs no responsibility nor any obligation whatsoever; and the fact that the government may have formulated, furnished, or in any way supplied the said drawings, specifications, or other data, is not to be regarded by implication or otherwise as in any manner licensing the holder or any other person or corporation, or conveying any rights or permission to manufacture use, or sell any patented invention that may in any way be related thereto.

This report has been reviewed by the Office of Public Affairs (ASD/PA) and is releasable to the National Technical Information Service (NTIS). At NTIS, it will be available to the general public, including foreign nations.

This technical report has been reviewed and is approved for publication.

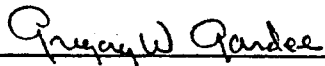

GREGORY W. GANDEE
Fire Protection Branch
Fuels and Lubrication Division
Aero Propulsion Laboratory



ROBERT G. CLODFELTER
Chief, Fire Protection Branch
Fuels and Lubrication Division
Aero Propulsion Laboratory

FOR THE COMMANDER

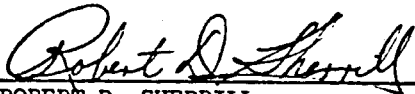

ROBERT D. SHERRILL
Chief, Fuels and Lubrication Division
Aero Propulsion Laboratory

"If your address has changed, if you wish to be removed from our mailing list, or if the addressee is no longer employed by your organization please notify AFWAL/POSH, W-PAFB, OH 45433 to help us maintain a current mailing list".

Copies of this report should not be returned unless return is required by security considerations, contractual obligations, or notice on a specific document.

AIR FORCE/56780/24 December 1980 — 200

SECURITY CLASSIFICATION OF THIS PAGE (When Data Entered)

19 REPORT DOCUMENTATION PAGE		READ INSTRUCTIONS BEFORE COMPLETING FORM	
1. REPORT NUMBER AFAPL-TR-79-2095	2. GOVT ACCESSION NO. AD-A094382	3. RECIPIENT'S CATALOG NUMBER	
4. TITLE (and Subtitle) Dynamic, Hot Surface Ignition of Aircraft Fuels and Hydraulic Fluids.		5. TYPE OF REPORT & PERIOD COVERED Final rept. Jan 77 - Dec 79.	
7. AUTHOR(s) Donald J./Myronuk		8. CONTRACT OR GRANT NUMBER(s) MIPR FY1455-77-00615	
9. PERFORMING ORGANIZATION NAME AND ADDRESS NASA Ames Research Center Mountain View CA 94035		10. PROGRAM ELEMENT PROJECT, TASK AREA & WORK UNIT NUMBERS P.E. 62203F, Project 3048 Task 304807, W.U. 30480769	
11. CONTROLLING OFFICE NAME AND ADDRESS Aero Propulsion Laboratory ATTN: G. W. Gandee (AFWAL/POSH) Wright-Patterson AFB OH 45433		12. REPORT DATE October 1980	
14. MONITORING AGENCY NAME & ADDRESS (if different from Controlling Office) NSA-3165 NSA-3329		13. NUMBER OF PAGES 40	
16. DISTRIBUTION STATEMENT (of this Report) Approved for: Public Release; Distribution Unlimited		15. SECURITY CLASS. (of this report) Unclassified	
17. DISTRIBUTION STATEMENT (of the abstract entered in Block 20, if different from Report)		15a. DECLASSIFICATION DOWNGRADING SCHEDULE	
18. SUPPLEMENTARY NOTES			
19. KEY WORDS (Continue on reverse side if necessary and identify by block number)			
Aircraft	Fire	Fuel	Oil
Autoignition	Flame	Heat	Propagation
Combustion	Flame Holder	Hot Surface	Reignition
Dynamic	Flammability	Hydraulic	Safety
Experiments	Fluid	Ignition	Sprays
20. ABSTRACT (Continue on reverse side if necessary and identify by block number)			
<p>The dynamic surface ignition characteristics of aircraft fuels and hydraulic fluids were investigated on heated stainless steel and titanium surfaces. Local air flow (0.8 to 50 meters per second) (2.4 to 152.4 ft/sec) effects were measured. Aircraft fuels evaluated on titanium surfaces ignited (25° to 75° C) (77° to 167° F) lower (500° to 600° C) (932° to 1112° F) than values required to ignite the fuels on a heated stainless steel surface. Higher local surface air speeds necessitated higher surface temperatures for ignition of an applied fluid.</p>			

374900

Cataloged on Computer 2/19/87 5002

SECURITY CLASSIFICATION OF THIS PAGE (When Data Entered)

The same trends were noted for hydraulic fluids sprayed on the heated surfaces.

One of the Air Force nonflammable hydraulic fluids, a fluoro alkyl ether, E.6.5, produced by the Du Pont Company could not be ignited on heated surface under any imposed conditions. Another nonflammable candidate, Halocarbon A0-8, from Halocarbon Corporation was the second best performer. Without airflow A0-8 ignited to produce transitory visible flame sites, at about 750°C (1382°F); at local air speeds of 1 m/sec (3.05 ft/sec), the surface had to have a temperature value of at least 925°C (1697°F) to produce a feeble discontinuous flame.

The commonly used commercial airline phosphate ester hydraulic fluid, represented by Skydrol 500b, resisted ignition until surface temperatures approached 725°C (1337°F) but proceeded to burn quite vigorously at 900°C (1652°F) at air speeds up to 30 to 40 m/sec (91.4 to 121.2 ft/sec).

The standard Air Force hydraulic fluid, Mil-H-5606, a mineral oil type, and the synthetic hydrocarbon based Mil-H-83282 fluid ignited at 575°C (1065°F) and 500°C (932°F), respectively. Vigorous burning occurred at 825°C (1517°F) and 800°C (1472°F), respectively with air velocity of 30 to 40 m/sec (91.4 to 122 ft/sec). An experimental silicone oil based fluid, MS-6 performed in an unexpected manner. While it resisted ignition at temperatures approaching 900°C (1625°F) and air velocity of about 10 m/sec (30.5 ft/sec) it would ignite at temperatures as low as 425°C (797°F) with very low air speeds. An anti wear lubricant added to the silicone oil made the mixture easier to ignite on a hot surface. The phosphate ester and silicone oil based fluids, in the process of thermal decomposition and burning, produced a tenacious tar-like material that adhered to the surface and formed a char or deposit that proceeded to act as its own flame holder. This action resulted in the generation of many additional flame sites and in a nacelle space or wheel-well these could increase the potential for local burn-through and/or structural damage.

SECURITY CLASSIFICATION OF THIS PAGE (When Data Entered)

FOREWORD

The experimental data summarized in this report, are the result of the combined efforts of several participants; the apparatus fabrication specialists Art Cooper, Ray Brindos and Clark Roessler at the San Jose University Machine Shop; the technical advisors who provided significant guidance in acquiring and interpreting the experimental observations, Richard Fish and Sal Riccitiello of the Ames Research Center and Gregory Gandee of the Air Force Wright Aeronautical Laboratories at Wright Patterson Air Force Base; and finally the very capable student research assistants Louis Salerno, Richard Sandkuhle, Jay Robinson and Victor Karpenko.

This experimental study was funded under Air Force project 3048 and a MIPR with NASA which in turn issued grants NSG-2165 and NSG-2219 to San Jose State University. The Fire Simulation Facility described in this report is located at the NASA Ames Research Center in Mountain View, California.

Accession For	
DTIC CRA&I	<input checked="" type="checkbox"/>
DTIC TAB	<input type="checkbox"/>
Unannounced	<input type="checkbox"/>
Justification	
By	
Distribution/	
Availability Codes	
Dist	Avail and/or Special
A	

TABLE OF CONTENTS

	<u>Page</u>
INTRODUCTION	1
I. Objectives	2
TEST FACILITY APPARATUS AND PERFORMANCE PARAMETERS	3
I. Description of Facility Apparatus	3
Table 1 - Ranges of Operational Parameters for Experimental Facility	8
GENERAL PROCEDURES USING HIGH PRESSURE SPRAY INJECTION	15
I. Injection Pressures and Surface Parameter Observations	15
EXPERIMENTAL RESULTS AND DISCUSSION	16
I. Aircraft Fuels and Hydraulic Fluids	16
II. Reduction of Fire Resistance of Silicone Oils by an Antiwear Additive	28
CONCLUSIONS	30
RECOMMENDATIONS	32
REFERENCES	33
APPENDIX	34

LIST OF ILLUSTRATIONS

<u>Number</u>		<u>Page</u>
1.	Schematic of Simulator for Nacelle Fires	9
2.	Enlarged View of Heated Surface with Multiple Fire Sites	10
3.	Schematic Section of Fire Simulator Heated Surface	11
4.	Hot Surface Ignition Temperature v.s. Ignition Delay Times with Air Flow Speed as a Parameter	12
5.	Photograph of Facility Hot Surface Showing Flame Holders and Fuel Delivery Tubes	13
6.	Photograph of Facility Hot Surface with JP-4 Fuel Burning in an Air Flow (Air Speed approx. 10 meters/sec)	14
7.	Air Speed and Surface Material Effects on Hot Surface Ignition Temperature of Aircraft Fuels (stainless steel surface)	20
8.	Air Speed and Surface Material Effects on Hot Surface Ignition Temperature of Aircraft Fuels (Titanium Surface)	21
9.	Air Speed and Surface Material Effects on Hot Surface Ignition Temperature of Aircraft Fuels (General Results)	22
10.	Air Speed and Surface Material Effects on Hot Surface Ignition Temperature of Aircraft Hydraulic Fluids (Stainless steel surface)	26
11.	Air Speed and Surface Material Effects on Hot Surface Ignition Temperature of Aircraft Hydraulic Fluids	27
12.	Air Speed Effects on Hot Surface Ignition Temperature of Silicone Base Fluids and Additives	29
A-1	Hot Surface Ignition Temperature for JP-4 as a Function of Material and Air Flow	39
A-2	Air Speed and Surface Material Effects on Hot Surface Ignition Temperature of Aircraft Fuels	40

INTRODUCTION

In 1977, the Air Force Systems Command initiated a program for the development of a nonflammable hydraulic fluid for use in future aircraft systems. The overall program is being executed as a cooperative venture between the Aeronautical Systems Division (ASD) and the Air Force Wright Aeronautical Laboratories (AFWAL) at Wright-Patterson Air Force Base in Dayton, Ohio.

Prior experimental investigation, sponsored under this program via NASA-Ames Research Center Grants NSG 2165 and NSG 2219 to San Jose University involved design and fabrication of an Engine Nacelle Fire Simulation Facility. The Facility is being used to experimentally test and quantify the fire behavior of aircraft fuels and hydraulic fluids applied to the heated surface under a variety of dynamic conditions.

The need for cautious interpretation of conventional flammability screening test results, such as auto ignition temperature tests, flame propagation tests, wick tests, hot manifold tests -- (FTM-6053), and spraying fluids at open flames, for categorizing flame resistance of combustible fluids has always been a concern. Consequently, flammability assessment under simulated dynamic environment fire scenario conditions often becomes necessary. The Fire Simulation Facility provides controlled air flow over the heated surface from very low speeds (0.8 m/sec) (2.4 ft/sec) to more vigorous values as high as 50 m/sec (152.4 ft/sec). These ranges encompass air flows which can be encountered in aircraft engine nacelles or wheel-well areas during the take-off or landing. Heated engine component surfaces, hot by-pass air ducts, and frictionally heated wheel/brake assemblies, are potential ignition sources for

combustible fluids accidentally released. The ignition would require the proper combination of surface temperature, air flow and local flame holder geometry.

The determination of the temperature values which result in hot surface ignition of various combustible fluids could be valuable in establishing engineering design criteria for fire prevention or control in potentially vulnerable areas.

I. OBJECTIVES

The objectives of the experimental study were to (1) design, fabricate and operate a laboratory sized, engine nacelle-type fire simulator. It would duplicate the condition of a combustible fluid contacting a heated surface, ignition and burning in the air flows above the surface. (2) Determine the minimum temperature for hot surface ignition and subsequent burning characteristics of conventional aircraft fuels, hydraulic fluids and candidate nonflammable hydraulic fluids as influenced by:

- (a) heated surface material
- (b) air flow values for dynamic burning conditions
- (c) fluid application/injection pressures
- (d) type of fluid leakage -- drips to highly atomized sprays
- (e) heated surface configurations and surface obstacles

TEST FACILITY APPARATUS AND PERFORMANCE PARAMETERS

I. DESCRIPTION OF FACILITY APPARATUS

A simple laboratory sized engine nacelle fire simulation system built at the Ames Research Center was used to observe contact and ignition of a combustible fluid on a heated surface capable of holding flames while air speeds over the surface ranged from about 0 to 50 m/sec. The Figure 1 shows a schematic overview of the experimentally evolved fire simulator system. Enlarged views of the heated surface and flame holders/surface stagnation zone generators are shown in Figures 2 and 3. Combustible fluids were brought to the heated surface in several ways. They were applied as solid streams or slow dribbles via several capillary tubes leading to each potential flame holder as shown in Figures 2 and 3. The high pressure fluid delivery system was pressurized to 6.9M Pa (1000 psig) with dry nitrogen. Fluids were sprayed through a free-jet, critical flow nozzle into the air flow channel about 1 meter upstream of the fire sites on the heated surface. Under these conditions, there is a freely expanding jet of finely dispersed fluid particles contacting the active heated surface. (A nonexpanding jet or fluid would simply squirt a high velocity stream above the heated surface). Limited testing at injection pressures of 3.5M Pa (500 psig) and 14M Pa (2000 psig) resulted in similar fluid sprays. Therefore, the 6.9M Pa (1000 psig) value was adapted as a reference injection pressure. The final choice for the fire simulator heated surface utilized a one meter long, 7.62 cm diameter schedule 80 stainless steel or titanium pipe internally heated with a premixed propane-air flame. The propane heater has a separate exhaust/ejector system. The target area (the upper outer surface of the stainless steel or titanium pipe) was extensively drilled and threaded to accept 1.3 cm diameter threaded rods. These rods projected 2 cm inward for the pipe surface, into the interior of the pipe. Acting as internal

pin fins, the rods assisted in the conduction of heat from the hotter regions of the air-propane flame to the pipe outer surface through the pipe interior insulating boundary layer. Without the interior pin fins, the relatively low value of thermal conductivity values of stainless steel and titanium allowed a much more rapid cooling of the target area of the pipe when air was flowing over the surface and convective surface film coefficients were high. The fins made it possible to keep the heated target area of the pipe hot enough to allow a combustible fluid to contact the heated surface and the local evaporative and convective cooling processes did not significantly alter the thermal energy transfer to the fluid vapor/air mixture which resulted in ignition and sustained combustion.

The combination of exterior plate fins which were welded on the target area to form a V trough (as shown in Figure 2) and the numerous threaded holes in the pipe upper surface (as shown in Figure 3) served to minimize the pipe warpage due to enormous thermal stress loads. These "loads" occurred when the target area was "red-hot" and repeatedly sprayed with the cold, combustible fluid as well as being scoured or cooled by a high speed surface air flow. In spite of some thermal stress relief of the heated surface, the thermal shock loads eventually peripherally cracked the pipe. Additionally, the problem of thermal distortion of the assembly was minimized by using smoothly curved sections or surfaces for their inherent strength while undergoing rapid thermal expansion or contraction. All sections were laterally supported yet unconstrained in a longitudinal sense to allow the thermal breathing of the segments. Air flow over the heater surface were limited to the upper third of the pipe surface only due to a limited blower size. The entire heated pipe surface could easily have been swept by a higher volume air supply.

A simple trough, formed by two parallel rods welded to the outer pipe surface, confined the combustible fluid droplets in intimate contact with the heated surface for an adequate period until the combustion processes were established.

A major system design problem involved the selection of appropriate surface stagnation zone generating devices or flame holders. The selection of appropriate flame holders was predicted on the characteristic behavior of fluids igniting on a heated surface. First, the temperature of the surface on which a combustible fluid sprayed or squirted is not dependent on the Autoignition Temperature (AIT) for the particular fluid. The AIT of a flammable liquid is determined in a closed or nearly closed container (usually a borosilicate glass flask). The small quantity of liquid is vaporized in a uniformly heated container and the temperature at which it spontaneously ignites and burns is the AIT. Time lags of a minute or more are frequently involved in the standard method of tests for AITs as described in A.S.T.M.D-2155, Auto-ignition Temperature of Liquid Petroleum Products. For common jet fuels, JP-4, or JP-5, the AIT values lie between 218° to 232°C (425° to 450°F). Under static, no air flow conditions, the same fuels applied to heated stainless steel surface of the test section, did not ignite until the surface temperature was in the neighborhood of 500°C . As air speeds over the heated surface were increased (a slightly more "dynamic" situation), higher surface temperatures were required for ignition.

Initial tests were conducted with room-temperature air velocities in excess of a few meters per second and a visibly red hot e.g. (600 to 700°C) stainless steel or titanium surface with no flame holders. It was virtually impossible to ignite the JP-4 fuel by simply spraying it on the hot, smooth

surface as a liquid column, as a pre-mixed air/fuel mist, or a high pressure spray. In order to ignite the fuel stream (without any external spark or open flame source), a stagnation mixing region for the combustible mixture of fuel and air was required. This mixture had to be retained in contact with the hot surface for a second or longer to obtain threshold ignition temperatures and continuous combustion of the fuel. Sheet metal strips projecting through the boundary layer of the air flows over the heated surface provided a simple means of generating combustible-mixture stagnation, retention, and ignition zones on the heated surface.

A combination of perforated re-entrant and overlapped, downstream facing cavities or conics were selected for use on the heated surface. A typical section view of the flame holders is shown in Figure 3. The photographs of the surface, Figure 5 and Figure 6, clearly show the surface boundary layer separators, the rails to hold fuel on top of the curved heated surface, the fuel channel tubes to each separator and the surface thermocouples. Small metal troughs discussed in the appendix were located just downstream of the two re-entrant boundary layer separators on the left side of the heated surface photograph. The air flows over the surface from left to right. The second photograph shows an actual flame pattern burning in the open atmosphere. The average air speed over the surface was of the order of 10 meters per second. Combustible fluids were conducted directly into the flame holders at multiple locations. High pressure sprays injected upstream of the flame holders and parallel to the air flow impacted the boundary layer separators and upon passing through the perforations in the holders, came into intimate contact with the heated surface. With the surface temperature at a specific value, the liquids ignited in a repeatable fashion. Figure 4 shows the

behavior of JP-4 fuel sprayed onto the heated stainless steel surface with surface air flow speeds 5 to 50 m/sec. In these tests the fuel did not ignite immediately upon contacting the heated surface. The liquid first vaporized and then the air/vapor mixture required adequate contact time with the hot surface where catalytic agents, carbon and metallic oxides and compounds, promoted the combustion reaction and finally the formation of visible flames.

Higher air flow velocities created turbulent wakes and eddies. Even with the flame holders generating stagnation regions on the hot surface, these conditions resulted in significant ignition delay times. If the ignition delay time exceeded a few seconds at any air flow, the combined effect of local surface evaporative cooling and enhanced surface convective heat transfer appeared to prevent air/vapor mixtures in the hot surface boundary layer, from ever attaining a threshold ignition temperature; no ignition was observed. Therefore, increasing air speeds required corresponding higher surface temperatures to produce visible flames. Finally, ignition temperatures and air velocity relationships became quite independent above 850°C to 900°C when JP-4 was used as a fuel. Other fuels and hydraulic fluids behaved in a similar fashion. The absolute values of the ignition delays were the most difficult parameter to measure. They could vary by several seconds as surface temperatures were being increased.

The trend of results was very typical for all combustible fluids tested. The ignition temperature values ($\pm 20^\circ\text{C}$) were significantly higher than the AIT values and the increased air flows required surface temperatures in excess of 1000°C for ignition of some hydraulic fluids. The nonflammable AO-8 hydraulic fluids, for example, exhibited transitory visible flames at low air flows, but when air flows exceeded a few meters per second, the

fluids failed to ignite for the maximum surface temperature attainable (about 1050°C).

The following tabulations are representative of the ranges of local conditions that have been experimentally observed in the fire simulation system.

TABLE 1. RANGES OF OPERATIONAL PARAMETERS FOR EXPERIMENTAL FACILITY

Air Flow:

20°C, 1 ATM Absolute: Velocity - 0 to 50 meters/sec
Mass Flow - 0 to 450 grams/sec

100°C, 1 ATM Absolute: Velocity - 0 to 15 meters/sec

Fluid Delivery:

Range: 0 to 1 liter/min

Atmospheric Pressure: 0 to 0.25 liter/min via capillary tube

High Pressure (6.9 M Pa): 15 to 25 cc/sec via spray injection

Target Area:

Surface Area: 200 cm²

Material: Stainless Steel 321 or Titanium B 265-58T

Temperature: 1050°C, maximum

Combustible Fluids:

Jet Fuels: JP-4, JP-TS, JP-5, JP-5 + FM9, JP-5+ 0.2% AMI, and Jet A

Hydraulic Fluids: Mil-H-5606, Mil-H-83282, Skydrol 500B

Halocarbon A0-8, Freon E6.5, and MS-6

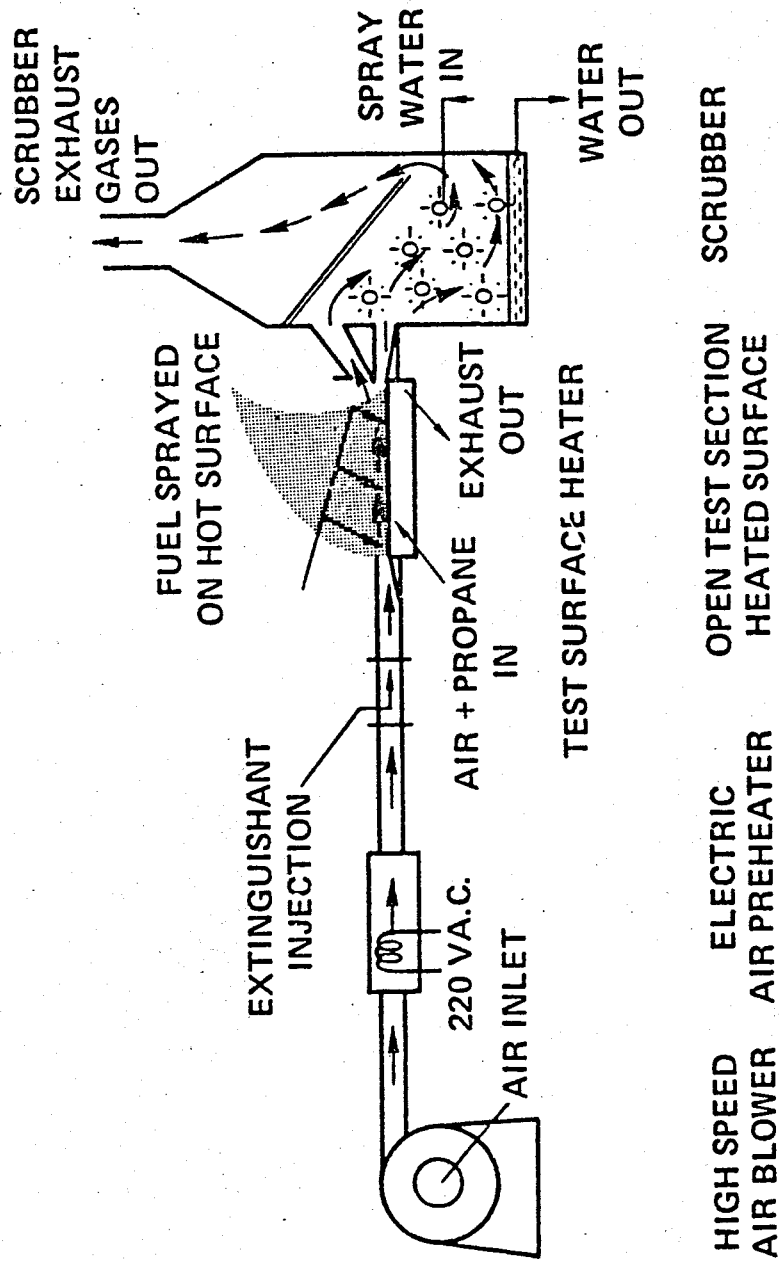

FIGURE 1 SCHEMATIC OF SIMULATOR FOR NACELLE FIRES

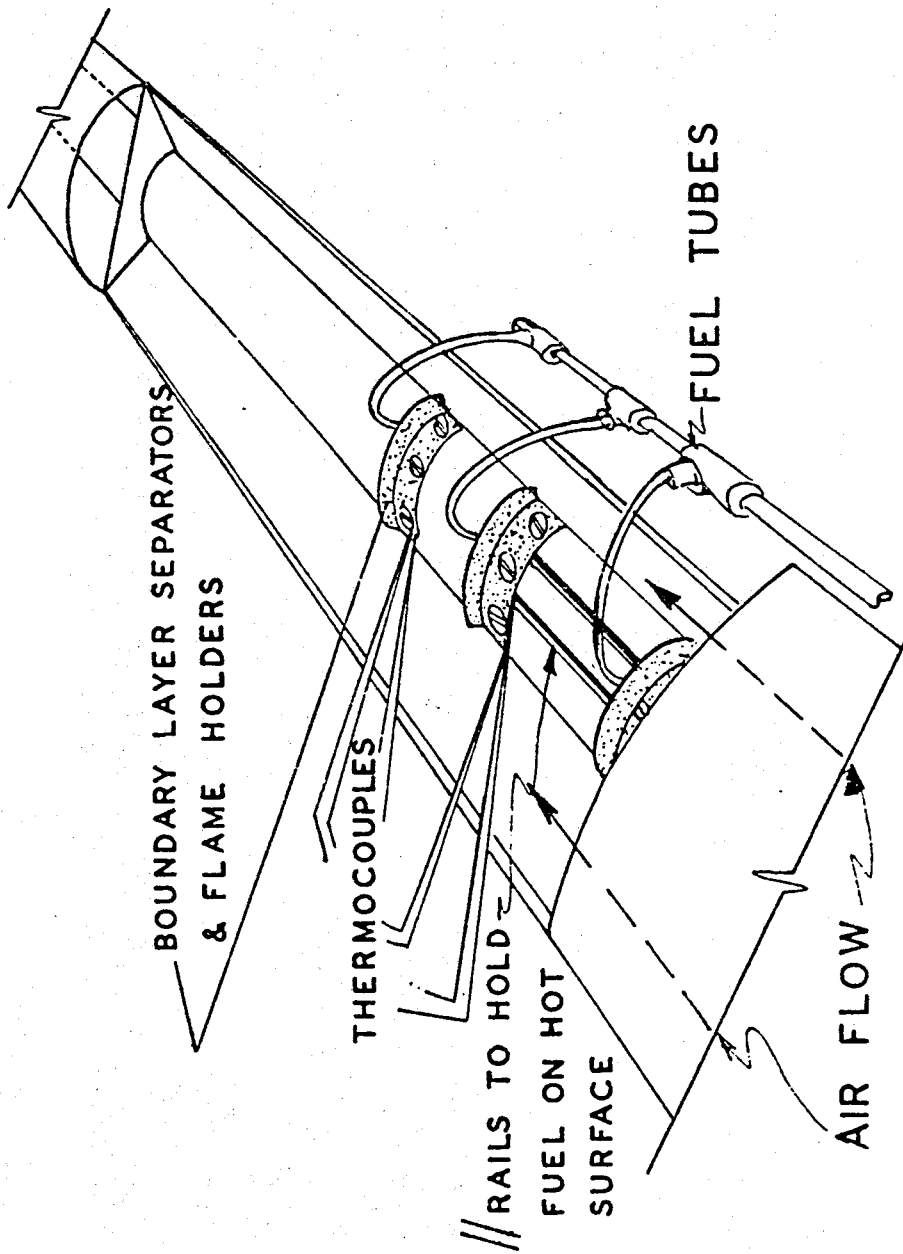

FIGURE - 2 ENLARGED VIEW OF HEATED SURFACE
WITH MULTIPLE FIRE SITES

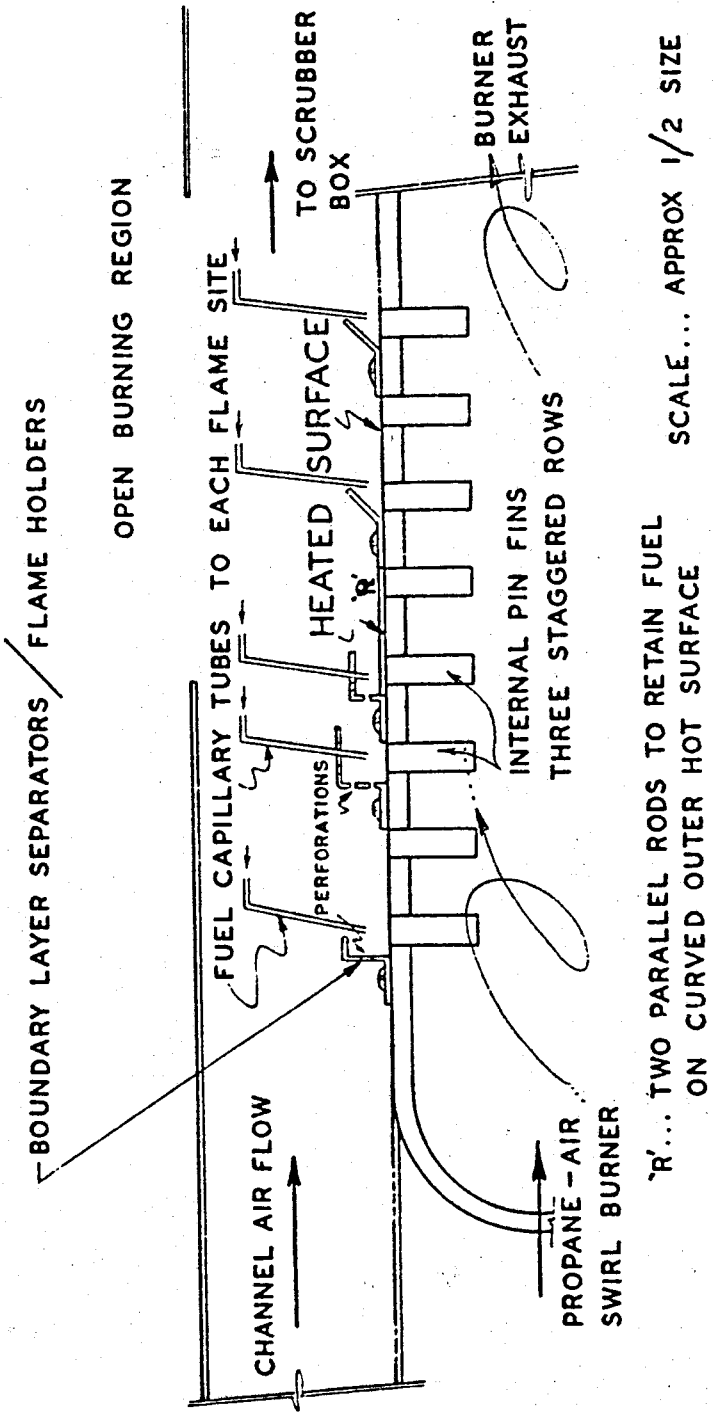

FIGURE-3 SCHEMATIC SECTION OF FIRE SIMULATOR HEATED SURFACE

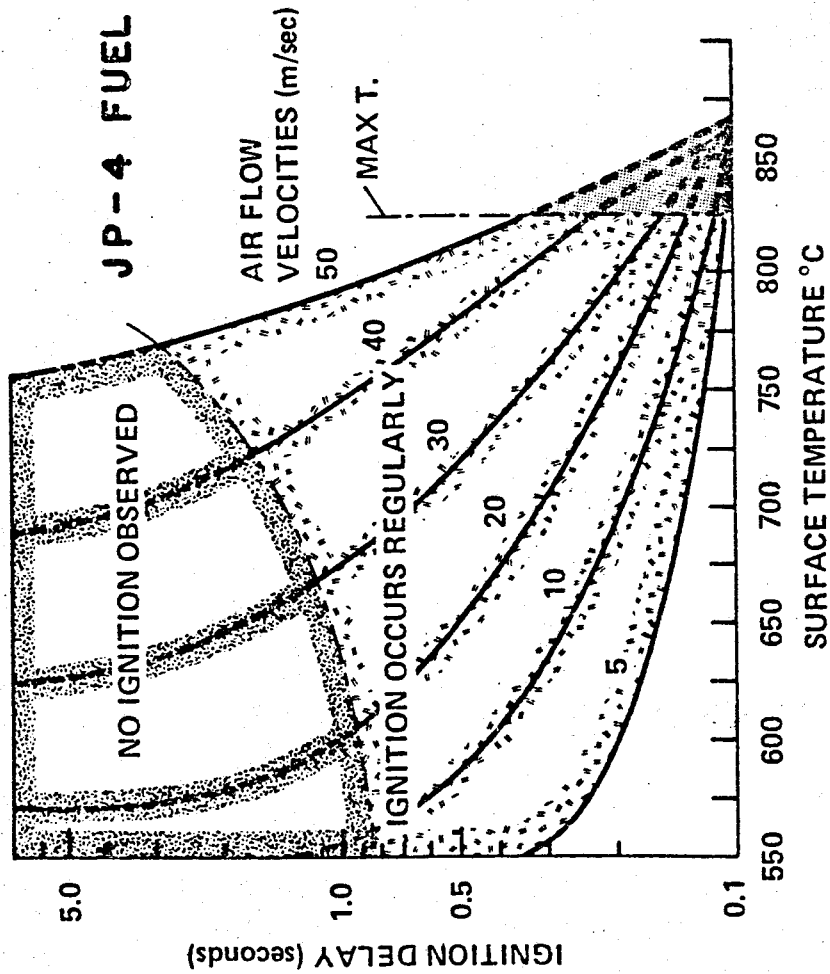

FIGURE 4 HOT SURFACE IGNITION TEMPERATURE VS IGNITION DELAY TIMES WITH AIR FLOW SPEED AS A PARAMETER

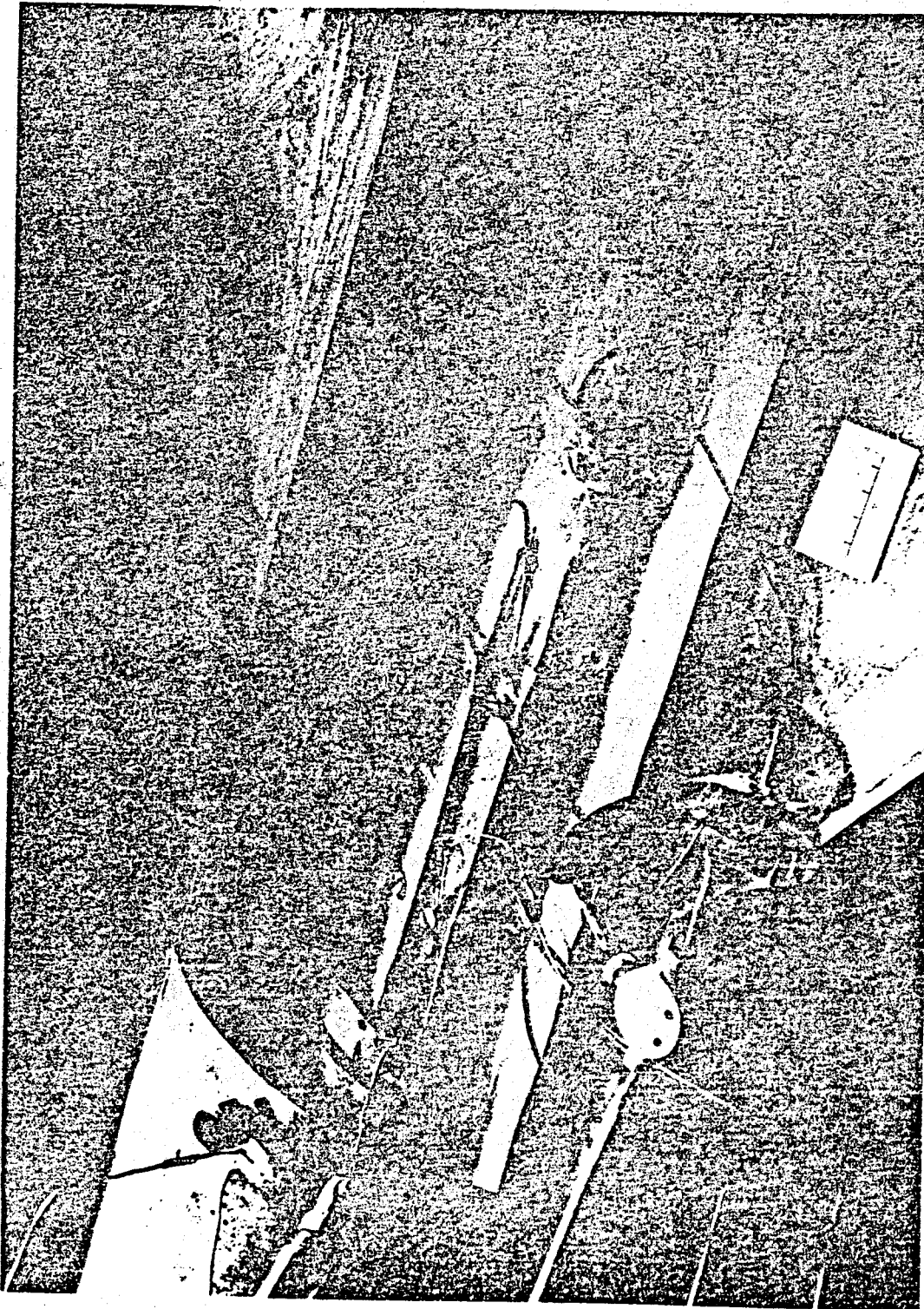

FIGURE 5 PHOTOGRAPH OF FACILITY HOT SURFACE SHOWING
FLAME HOLDERS AND FUEL DELIVERY TUBES

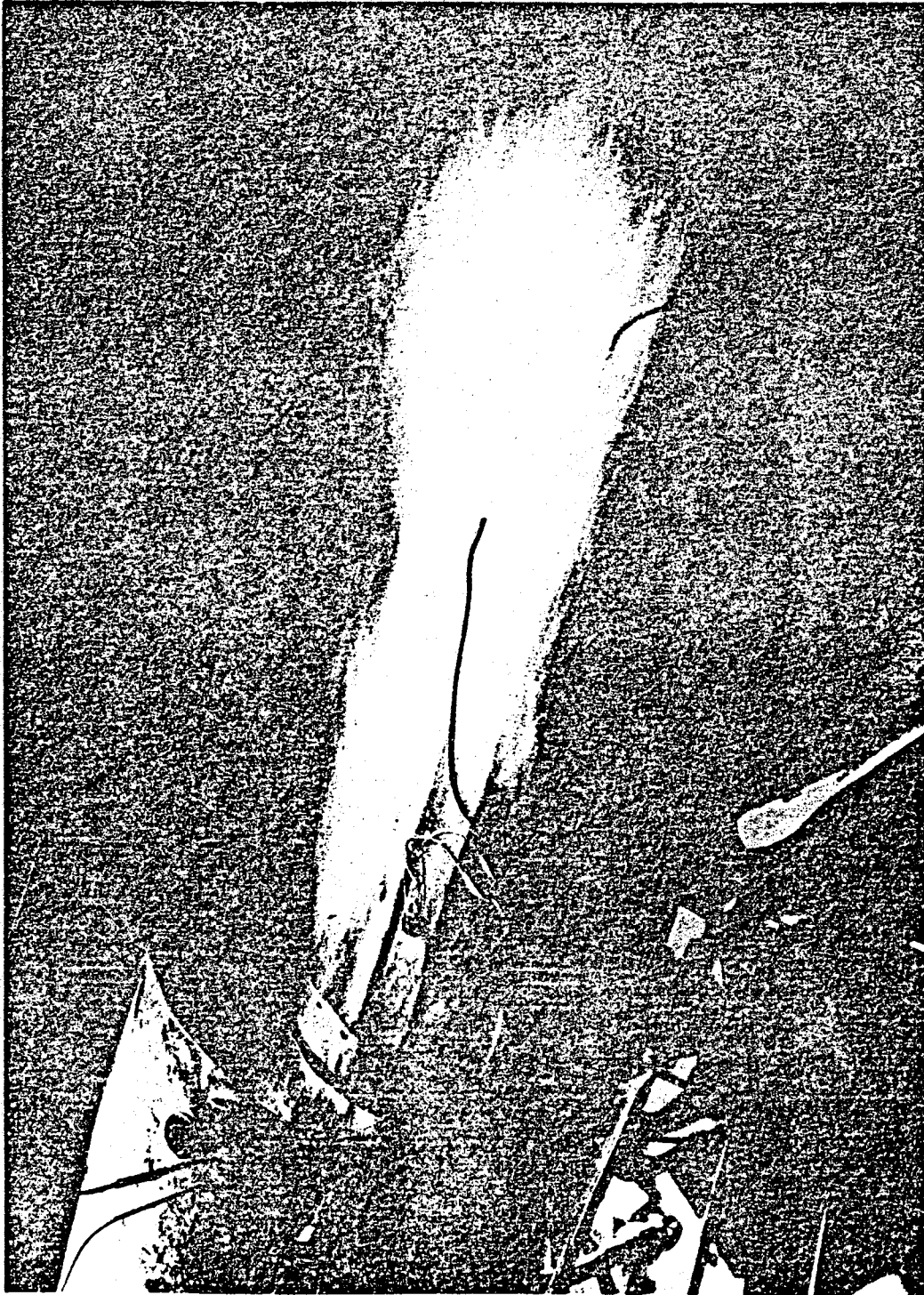

FIGURE 6 PHOTOGRAPH OF FACILITY HOT SURFACE WITH JP-4 FUEL BURNING IN AN AIR FLOW (AIR SPEED APPROX. 10 M/SEC)

GENERAL PROCEDURES USING HIGH PRESSURE SPRAY INJECTION

I. INJECTION PRESSURES AND SURFACE PARAMETERS OBSERVATIONS

All injected fluids were sprayed through a precalibrated critical flow nozzle located about 1 meter upstream of the flame holders. A driving pressure of about 6.9M Pa (1000 psig) was used. The divergent free jet of atomizing liquid was observed to encounter the boundary layer separators/flame holders attached to the heated surface. The combustible sprays ignited when, as a function of the local surface air speed, the heated surface temperatures were adequate to initiate the combustion processes. At each channel air speed (0.8, 6, 16, 23 and 36 meters/sec), the temperature of the surface was slowly increased to reach the ignition threshold values. The heated surface of the Simulator, fabricated from austenitic stainless steel type 321, was given the general designation of "Heated Stainless Steel Surface" on the graphical results. An identical heated surface was fabricated from titanium (B265-58T) and results using this surface material were designated "Heated Titanium Surface" on the graphical results.

Approximately 15 cubic centimeters of the fluids passed through the nozzle during the injection period. An electronic timer was used to trigger the high pressure pneumatically activated control valve feeding the nozzle hence quantities of fluid injected were very repeatable. During the calibration period for a particular fluid, the ease with which the expanding jet formed a spray and the amount of air entrainment to form a foam was noted. The rate at which the foam coalesced was also noted. These observations provided assurance that the free jet of expanding fluid mist did indeed contact the heated surface and the boundary layer separators. Resulting vapors were

well mixed with air and ignition on the heated surface, providing the mixture was combustible in the first place, did indeed occur in a repeatable fashion.

EXPERIMENTAL RESULTS AND DISCUSSION

I. AIRCRAFT FUELS AND HYDRAULIC FLUIDS

The Ames Fire Simulation Facility has been used to observe the ignition characteristics of a wide variety of fuels (JP-4, JP-5, Jet A, JP-TS and JP-5 plus anti-misting additives AM-1 and FM-9). Hydraulic fluids included Mil-H-5606, a mineral oil; Mil-H-83282, a synthetic hydrocarbon; Skydrol 500B, a phosphate ester; MS-6, an experimental silicone fluid; and nonflammable candidates Halocarbon A0-8 and DuPont E 6.5.

The nonflammable fluid E6.5, described as a fluoro-alkyl ether, did not ignite under any circumstances encountered in the facility. The Halocarbon fluid produced only the sparsest flickers of yellowish flame when ignited by the heated surface. The results also include data and discussions on another experimental silicone oil based fluid, MS-5 (similar to the MS-6) as well as the potential loss of ignition/fire resistance of the silicone based fluids caused by an additive (DBC, dibutylchloroendate) used for improvement of the load carrying capability of the hydraulic oil film.

Figure 7 is a semi-logarithmic plot of ignition temperatures for a variety of aircraft fuels igniting on a heated stainless steel surface as a function of surface temperature and average channel air speed. Ignition delays in general were of the order of one or two seconds. The fluids were applied in a one second burst of spray. The precalibrated volume applied was about 15 cubic centimeters. If ignition delays were longer than one or two seconds, the fuel droplets that arrived at the surface would simply have boiled away

on the hot surface with forming visible flames. As shown, the higher the volatility of the fuel, the more difficult it was to ignite on the open heated surface. Fuels like the more volatile JP-4 would tend to form a vapor more readily than the lower volatility fuel JP-TS. With the presence of an air stream, a combustible vapor-air mixture would be formed in many regions of the flow field. However, for high volatility fluids, it appeared that these regions were well away from the source of thermal energy, and did not acquire sufficient energy to yield a self sustaining combustion process.

Less volatile fluids evaporating less rapidly on the heated surface, produced local vapor air mixtures nearer to the source of thermal energy and they in turn ignited at lower temperatures. The very non volatile silicone oils for example, ignited at surface temperatures lower than any other hydraulic fluids tested. Hence, from a design safety point of view, when combustible fluids accidentally contact a heated surface, the more volatile fluid may represent less of a hazard than the lower volatility candidates. With basic design criteria in mind, however, the results pointed out the limitation using AIT values as absolute upper limits for heated surfaces in nacelle spaces. More specifically if JP-5 fuel with an AIT of about 232°F were to be used in an engine whose hot air bypass ducts were expected to reach 260°C , current design safety requirements specify isolation of the hot surfaces from potential fuel contact to avoid ignition of the fuel. Yet the experimental results show it was not possible to ignite the JP-5 fuel on a surface whose temperature was less than 500°C let alone 260°F . These tests were very low air flows; at higher local air speeds hot surface ignition values were even more remote from the AIT values. These results further suggested that when the safety aspects of ignition of

fuels on a heated surface were considered, design values for unprotected heated metal surfaces could exceed the maximum AIT value by 75 to 100°F with no problems. This would eliminate unnecessary insulation weight currently being used to thermally isolate hot ducts in nacelle spaces and hot engine surfaces. An interesting observation involved the use of JP-5 with anti misting (AM) additives. In the first case, the addition of 0.2% AM-1 additive actually reduced the ability of the fuel to resist hot surface ignition by about 50°C. Yet considering the ability of the additive to prevent accidentally released fuel from misting (and obviously being more easily ignited by external local sources) by enhancing surface tension effects and inhibiting droplet formation, these same effects were precisely those needed to promote easier dynamic hot surface ignition of a fluid. The use of another anti misting agent, FM-9, with JP-5 fuel did not result in as great a lowering of the hot surface ignition temperature value of the JP-5 (about 10 to 15°C). It is possible the ability of an additive to lower the threshold hot surface ignition temperature of a fuel may be a simple way to measure its ability to perform as an effective anti misting agent. (On the basis of this suggestion the AM-1 should perform as a better anti misting agent than the FM-9 additive.)

When the jet engine fuels were sprayed over the heated titanium surface, in general the temperatures required to ignite the fuels were of the order of 50 to 75°C lower than for the heated stainless steel surface. These results shown in Figure 8 confirmed the similar trend of behavior observed when using small titanium boats or troughs as reported in the Appendix A-1. For the titanium surface, the trend of increased temperature required for ignition as a function of local air speed was similar to the trend established on the stainless steel surface. Figure 9 demonstrates the average performance bands

for fuels on the two hot surface materials. With the increased usage of titanium in modern aircraft, especially in nacelle spaces and wheel wells, a more rigorous test of a combustible fluid's ability to resist hot surface ignition must include testing on heated titanium surfaces. This test would be particularly applicable to hydraulic and lubricating fluids as well as fuels.

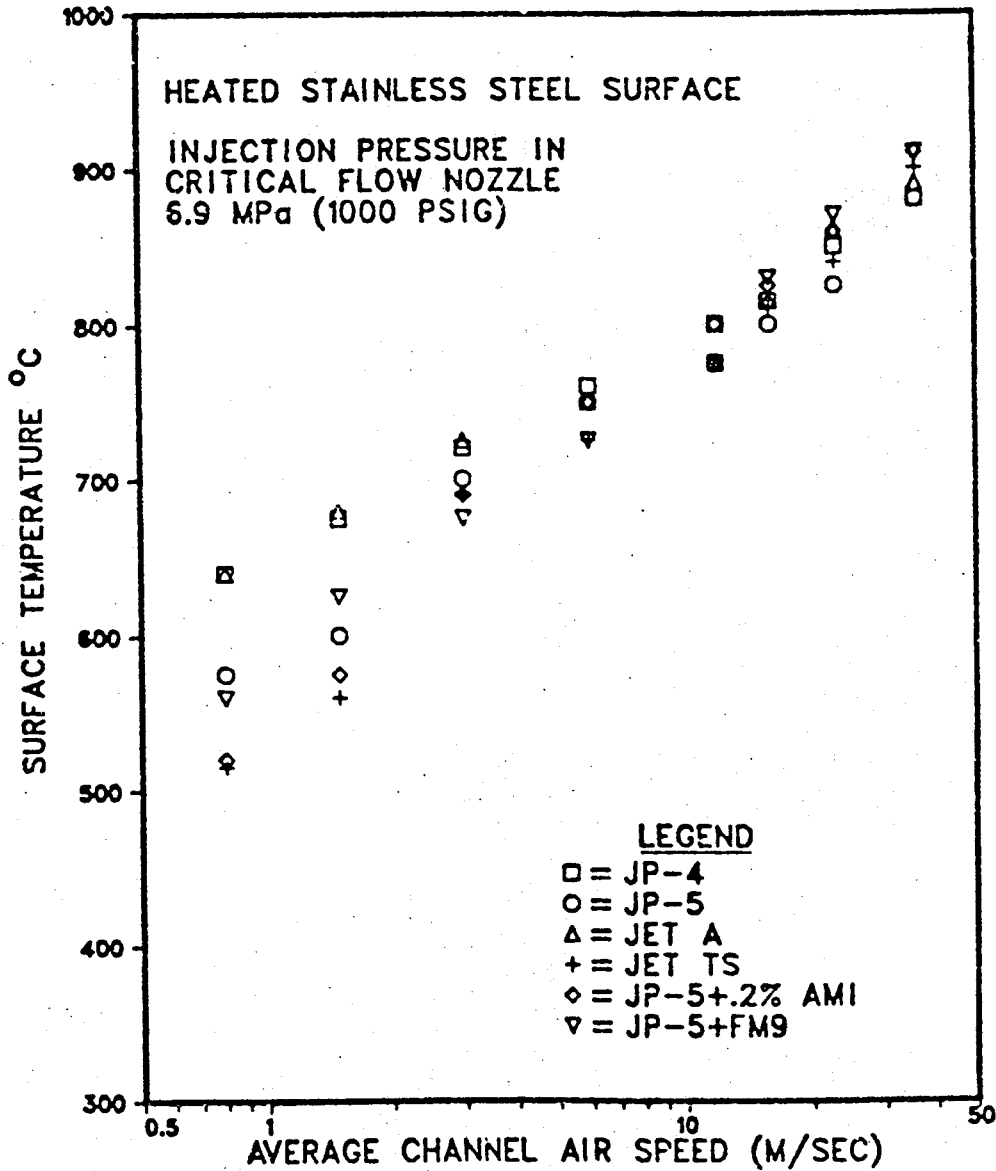

FIGURE 7 AIR SPEED AND SURFACE MATERIAL EFFECTS
ON
HOT SURFACE IGNITION TEMPERATURE
OF
AIRCRAFT FUELS

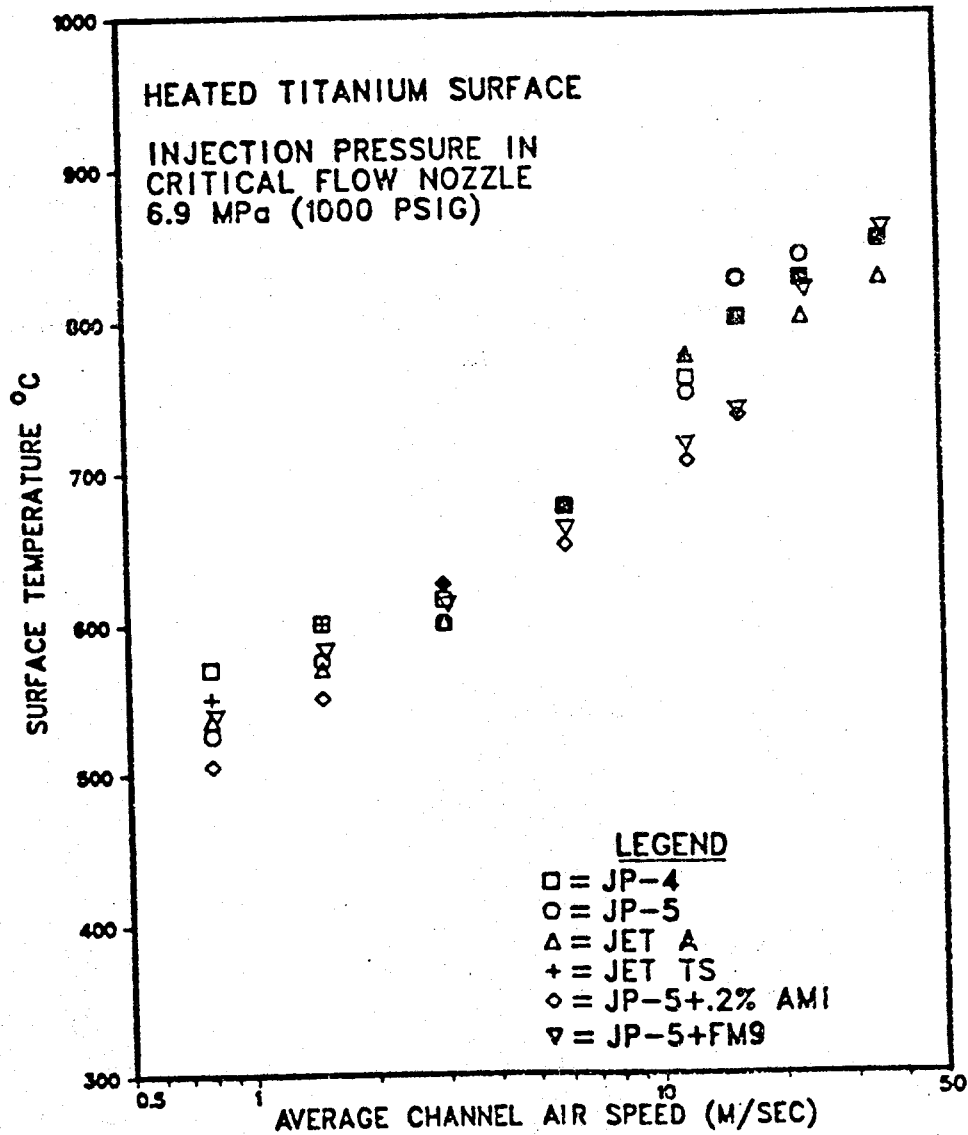

FIGURE 8 AIR SPEED AND SURFACE MATERIAL EFFECTS
ON
HOT SURFACE IGNITION TEMPERATURE
OF
AIRCRAFT FUELS

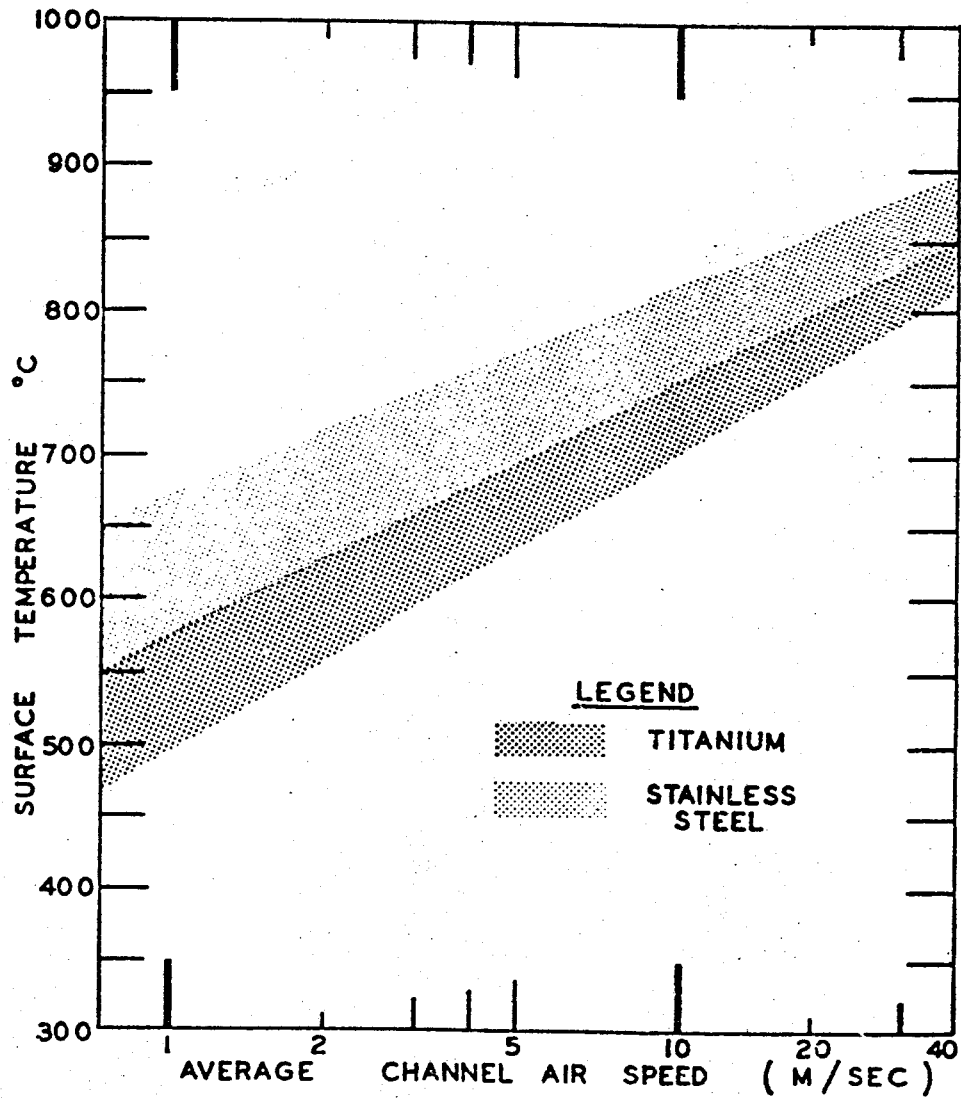

FIGURE 9 AIR SPEED & SURFACE MATERIAL EFFECTS
ON
HOT SURFACE IGNITION TEMPERATURE
OF
AIRCRAFT FUELS

The results of hydraulic fluids spray-injected into the air flows upstream of the heated surface exhibited a considerably broader range of results as shown on figures 10 and 11 for the different surface materials. As may be observed, the combustible liquids appeared to ignite at somewhat lower temperatures on a heated titanium surface compared to ignition temperature values on the stainless steel surface. Enhanced catalytic activity of the heated titanium surface compared to the catalytic activity of the stainless steel surface appears to be the primary reason for this behavior.

The synthetic hydrocarbon based fluid, MIL-H-83282, had a higher auto ignition temperature than MIL-H-5606 (338°C vs 225°C) and by virtue of these values, the MIL-H-83282 may be considered as being more flame resistant than MIL-H-5606. However, for these test conditions, as figure 10 data shows, the MIL-H-83282 ignited easier than the MIL-H-5606 (500°C vs 575°C for 5606 at low air speeds; 800°C vs 825°C for 5606 at the highest channel air speeds.) The data reflects that 83282 was more flammable than 5606 from a hot-surface-contact ignition point of view. This was one of several instances that revealed a significant potential error in assuming flammability characteristics could be simply extrapolated from AIT data. The Silicone oil based fluids (AIT about 410°C) yielded unexpected results. While they appeared to resist ignition for surface air speeds above 10 meters per second and surface temperatures about 900°C, at low air speeds they ignited at about 425°C. While MS-6, tetrachlorophenyl methyl silicone oil, was more flame resistant than another silicone fluid (dichlorophenyl methyl silicone oil) it appeared the presence of different quantities of an anti wear additive tended to reduce the hot surface ignition resistance of these very low volatility oils even more than for the base fluids alone. This problem is discussed in further detail later in this report.

The most widely used commercial airline hydraulic fluid is a phosphate ester as represented by Skydrol 500 B. At about 700°C at low air flows it burned quite sparsely, yet as temperatures and surface air speeds increased, the 500 B burned very vigorously. For the silicone oil and the phosphate ester fluids, there was notable ignition delay following spray injection -- at least 3 or 4 seconds. In this period, the clear liquid droplets thermally decomposed into dark-colored tarry liquids. The secondary products then acquired enough thermal energy to burn with visible flames. The tarry liquids appeared to cling tenaciously to any available surfaces in the test section where they acted as their own flameholders. Projections of silicone dioxide from the burned MS-6 or char from decomposed 500 B littered the entire heated test section. Subsequent fluid injections were trapped in these growing inert deposits where they proceeded to burn vigorously in the self-generated flame holders. This is particularly noteworthy in that vigorous flame sites with potential for local burn-through and/or structural damage could occur at engine nacelle locations or smooth duct areas that were normally free of local fire sites by virtue of the vigorous local air flows that swept away ordinary combustible liquids. The 500 B liquid characterized as a "self-extinguishing" liquid when a high pressure spray plume was subjected to an open flame, or the silicon oil characterized as "does not ignite under the same circumstances really did not behave in those fashions in the hot surface ignition facility. This serious behavior discrepancy was due to the fact that for spray over an open flame, the fluids had no time to undergo the change to the secondary tar-like fluids that could burn vigorously. On the heated surface adequate time was available for the thermal decomposition and subsequent vigorous combustion. For both fluids small visible flame sites continued to erupt on the heated surface many seconds after the one second injection period and initial burst of flame. These post injection

eruptions were very visible in the 16 mm motion pictures taken of the test sequences.

The Air Force nonflammable candidate fluid, Halocarbon A0-8, was very resistant to ignition on a heated surface. At low air speeds, 0.8 meters per second, the applied liquid or spray resisted forming visible flames until the hot surface temperature reached 750°C. The resulting flame burned very sparsely and randomly within the vapor space above the heated surface. The flames were highly localized, and did not display any tendency to ignite any adjacent vapor pockets in any continuous type of flame front. This behavior of the A0-8 to resist forming continuously burning vapors persisted even with surface temperatures in excess of 1000°C. While there were a few more of the flame pockets at the higher temperature, the flames were not visibly different from the initial flame flickers. At air speeds above 1 m/sec, the A0-8 ceased to produce visible flames. On the titanium surface, as shown on Figure 11, the A0-8 burned with sparse visible flames for a higher range of air speeds. Flickers were observed with air speeds up to 10 meters/second. It was suspected chlorine stripped from the A0-8 molecules and reacted with the heated titanium oxides to catalyze the combustion reaction to a greater degree than in the case of A0-8 contacting the heated stainless steel surface.

A truly fire resistant fluid, the Air Force nonflammable candidate, DuPont E 6.5, a fluoro-alkyl ether, did not yield a visible flame under any circumstances in the test facility. At most a grey-white vapor/smoke cloud was released following contact of the spray on the hot surface.

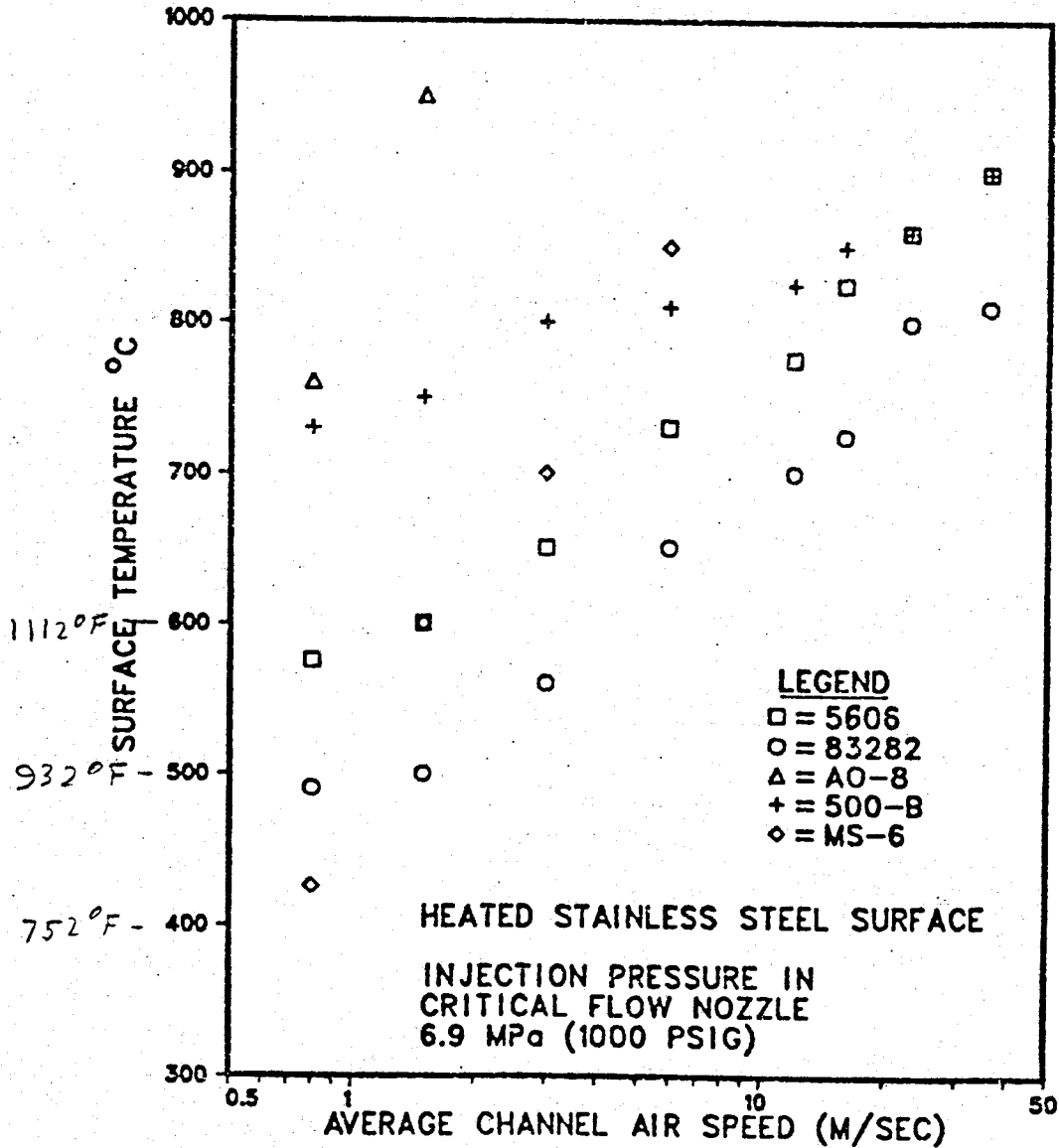

FIGURE 10 AIR SPEED AND SURFACE MATERIAL EFFECTS ON HOT SURFACE IGNITION TEMPERATURE OF AIRCRAFT HYDRAULIC FLUIDS

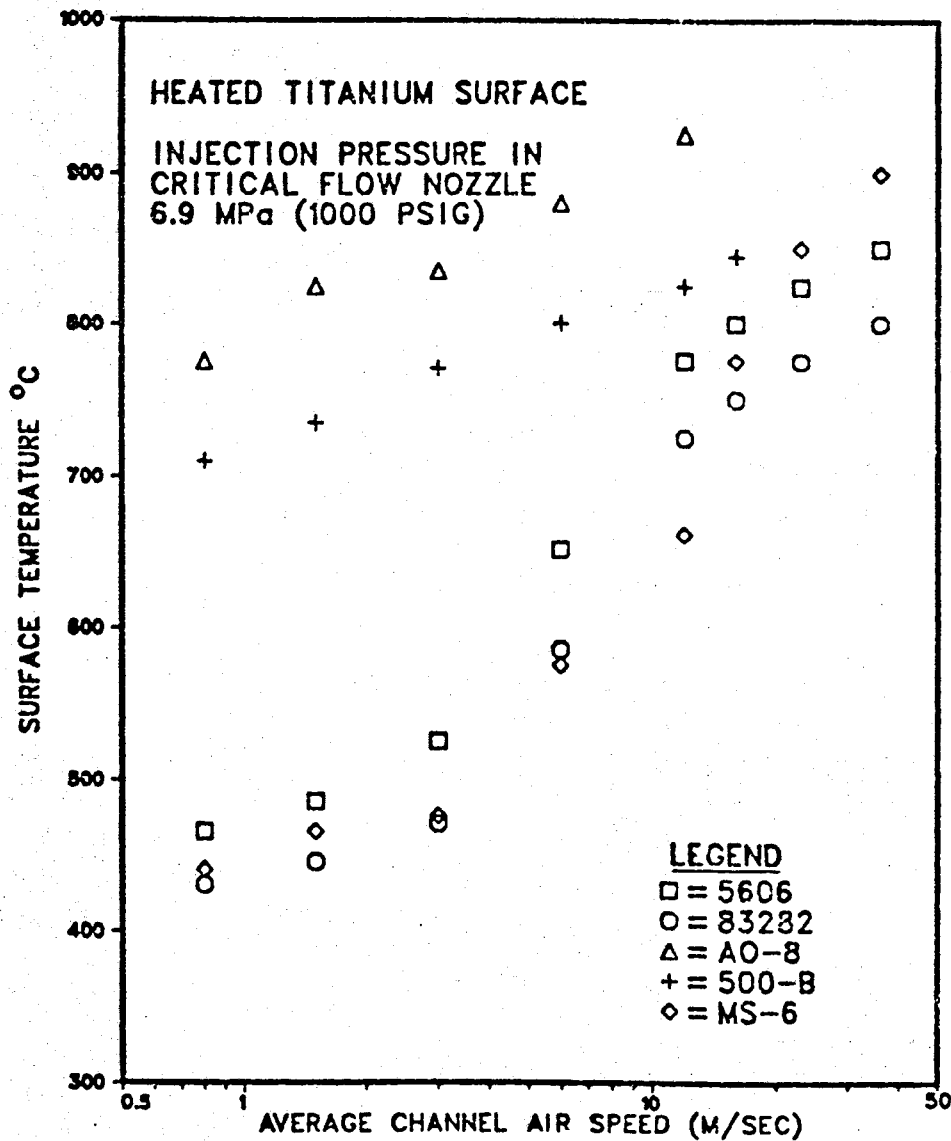

FIGURE II AIR SPEED AND SURFACE MATERIAL EFFECTS
ON
HOT SURFACE IGNITION TEMPERATURE
OF
AIRCRAFT HYDRAULIC FLUIDS

II. REDUCTION OF FIRE RESISTANCE OF SILICONE OILS BY AN ANTIWEAR ADDITIVE

Figure 12 yields results of some experimental work with silicone oil based hydraulic fluids. The M.S.-6 fluid consisted of tetrachlorophenylmethyl silicone oil base plus 4% dibutyl chlorendate, (DBC), as an anti wear additive. It was noted the base fluid was more fire resistant than the mixture. The same behavior was noted for the MS-5 mixture (dichlorophenylmethyl silicone oil plus 10% DBC) and the MS-5 base alone. The DBC alone ignited at 350°C at low air speeds as shown. In brief, the data on figure 12 indicated a need to be very cautious when mixing additives in hydraulic fluids. While the DBS enhanced anti wear performance of silicone oils, at the same time the addition had inadvertently altered and reduced a salient feature of the fluid, the ability to resist hot surface ignition.

In general air speeds higher than 5 meters per second the silicone oil based fluids demonstrated good resistance to ignition on a heated surface.

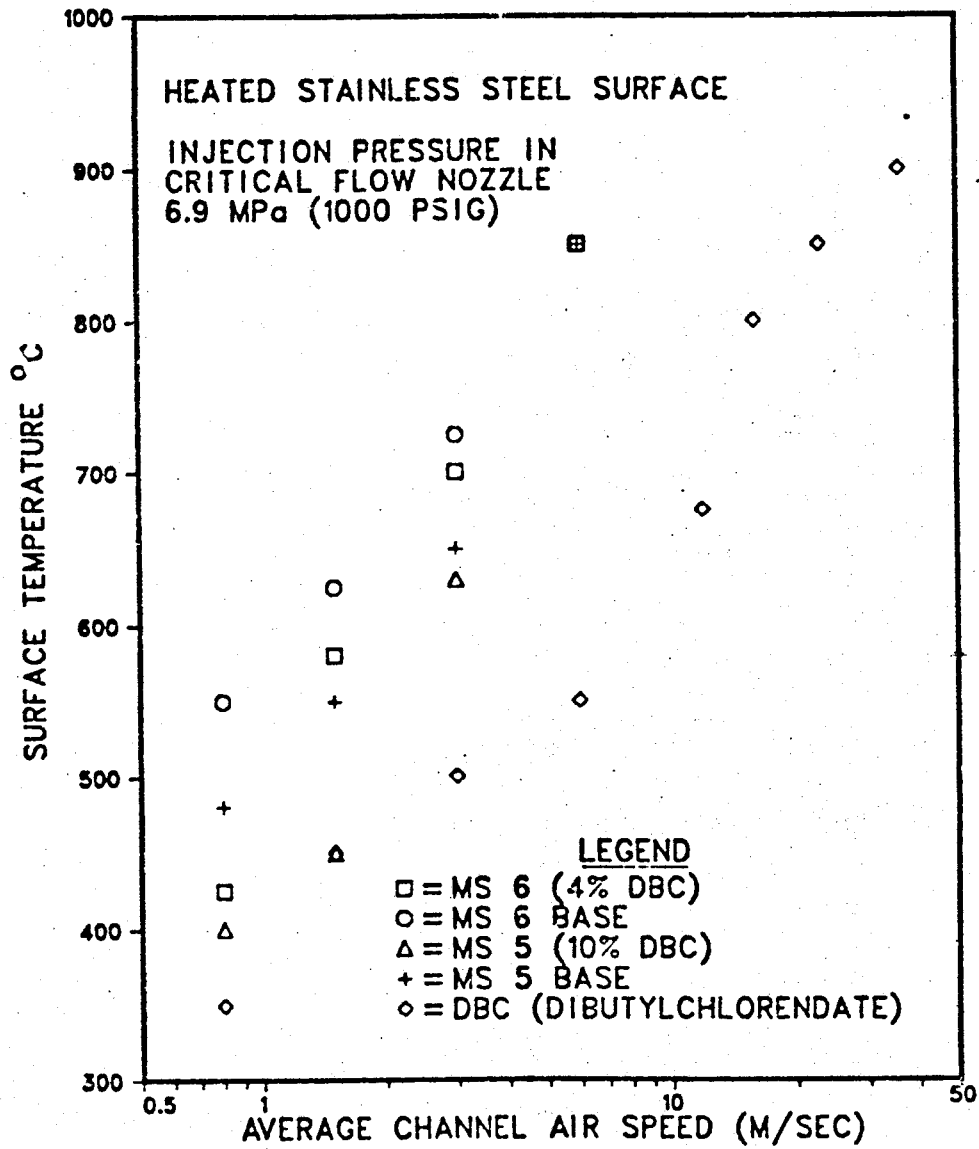

FIGURE 12 AIR SPEED EFFECTS ON HOT SURFACE IGNITION TEMPERATURE OF SILICONE BASE FLUIDS AND ADDITIVES

CONCLUSIONS

1. From a design safety viewpoint, the ignition temperature of a combustible fluid on a heated surface with some local air flows over the surface, cannot be extrapolated or even inferred from the Auto Ignition Temperature Value for the fluid.
2. With simple air flows over a heated surface, a more volatile fluid applied to the surface was more difficult to ignite (it required a higher local surface temperature) than a much less volatile combustible liquid.
3. Dynamic conditions (definable local air flows) must become a major parameter in tests used to ascertain the fire resistance ability of a combustible fluid.
4. The Halocarbon A0-8 demonstrated a high degree of resistance to ignition on a heated surface. While some very sparse flames did occur, they did not show any tendency to ignite adjacent vapor pockets. With local air flows above a few meters per second it was virtually impossible to ignite the fluid on the heated surface.
5. The fluid E6.5, a fluoroalkylether, did not produce visible flame under any imposed circumstances hence would be labelled totally fire resistant.
6. The "fire resistant" phosphate ester hydraulic fluids, while demonstrating an initial resistance to hot surface ignition, upon reaching a threshold ignition temperature of the order of 750°C, burned with extreme vigor. When

ignited the phosphate ester as well as the silicone based fluids presented additional complications by forming their own flame holders and thus allowed vigorous combustion processes to occur in regions where due to high local air flows, potentially combustible mixtures would normally have been swept away.

7. Additives to improve a feature of a fuel (anti misting) or hydraulic fluid (anti wear) must be carefully investigated as to their potential deterioration of the ability of the fluid to resist ignition on a heated surface.

8. Hot surface ignition of combustible fluids occur at lower surface temperatures in general (25 to 75°C less) for heated titanium surfaces as compared to stainless steel surface.

9. A measure of the capability of a particular metal alloy to promote hot surface ignition of a combustible fluid may be ascertained by observing ignition behavior of the fluid on a small heated trough (the technique is described in the appendix of this report).

RECOMMENDATIONS

1. In aircraft hydraulic fluid applications, it appears that a significant improvement in fire safety can be achieved by simply changing to another fluid in regions where fire risk is high. Further investigations should be considered in the feasibility of two fluid hydraulic systems, e.g., using a very fire resistant fluid like Halocarbon A0-8 in the hydraulic lines only in the immediate vicinity of the wheel well brake assemblies. Conventional fluids would be used throughout the remainder of the hydraulic system.

2. Federal Test Standards Number 791, Method 6052 investigating High Pressure Spray Ignition and Number 791, Method 6053 investigating Hot Manifold Drip Ignition Temperatures should be modified to include local air flows, 0 to 30 meters per second, as one of the imposed test conditions.

REFERENCES

Information and/or suggestions from the following references have been used to provide directions for the experimental portions of this report.

1. S. R. Riccitiello et al, "Conference on Hydraulic Fluids: A Compilation of Presentations and Papers", NASA Report MX-73, 142. August 1976.
2. A Strasser, N. C. Waters, J. M. Kuchta, "Ignition of Aircraft Fluids by Hot Surfaces Under Dynamic Conditions", WPAFB/Report/AFAPL, TR-71-86, November 1971.
3. "Standard Test Method for Autoignition Temperature of Liquid Petroleum Products", ASTM D 2155-66, Annual Book of ASTM Standards, Part 24 1976.

Other test methods reviewed were ASTM D-92 for Flash and Fire Points; FTS-791-6052 using a high pressure spray; AMS-3150 C using a low pressure spray; and MIL-H-83282 to establish flame propagation properties of combustible fluids.

APPENDIX

In initial experimental work, the nacelle fire simulator system was employed as a simple heater for small metal troughs (4 cm by 1 cm) into which a small quantity of JP-4 fuel was intermittently injected via a hypodermic needle system. The trough temperature was slowly increased until visible flames were observed. The trough was located in the wake of one of the boundary layer separators fastened to the simulator heated surface; and while the trough was fully exposed to the local atmosphere, the air flow rate over the small trough was regulated from about 0 to about 4 meters per second in this preliminary investigation. The fuel was added in small drops so as to avoid excessive evaporative cooling of the trough surface. Two chromel-alumel thermocouples were spring-loaded against the trough to ensure good contact with the trough surface as well as holding it in place on the main heater surface.

The following sheet metals were used to fabricate the troughs for the initial hot surface ignition observations:

- stainless steel 304
- stainless steel 321
- carbon steel, 1040
- aluminum, 2024
- chrome moly alloy, 4130
- titanium alloy, 9046
- incone1 X 750
- pure molybdenum

The following behavior trends were noted. The aluminum trough at very low air flows structurally sagged and melted prior to an observed ignition of the JP-4 fuel on the heated aluminum surface (average trough temperature was about 620°C). Stainless steels and ordinary carbon steel had a hot surface ignition threshold temperature of about 575°C which rose, as shown on figure A-1 as the air flow speed over the metal trough was increased. The titanium alloy demonstrated

a significantly lower hot surface ignition capability at low air flows as did the inconel X material. With regards to the mechanics of igniting JP-4 the titanium alloys appeared to be capable of igniting combustible liquids at temperatures at least 50 to 100°C below those required for hot surface ignition of JP-4 on a stainless steel alloy.

It was believed that part of the explanation for the behavior of these alloys involved the formation of surface catalysts in the form of oxides of the parent metal, iron, nickel, and chromium, on the heated surfaces. Some confirmation of this opinion was given by the behavior of a pure molybdenum surface as well as a chrome-moly alloy as shown on figure A-1. The initial formation of a molybdenum oxide on the clean moly surface lead to a quite low (470°C) surface ignition temperature. However the initial, easily melted oxide was rapidly evaporated and in its place was observed a yellowish trioxide with a definite crystal structure that rapidly formed a thick coating which now acted as a thermal resistance and in turn effectively insulated the metal surface from the applied fuel. The temperature required for hot surface ignition after the formation of the yellow trioxide layer then exceeded the temperature required for JP-4 ignition on stainless steel.

For stainless steels and inconel X, the formed oxides or spinels (e.g. $(\text{FeO})_{0.25}(\text{Cr}_2\text{O}_3)_{1.75}$) were quite stable and while protecting the heated surface from further oxidation they proceeded to catalze the combustion reaction of fuel contacting the surface. For heated titanium surface, the oxide layer formed is much thinner, and the catalytic ability of the oxide layer coupled with a reduced thermal insulation resistance apparently enhanced the capability of Titanium to ignite JP-4 fuel on the heated trough surface. The slight differences in thermal conductivity values between the

Titanium and Stainless steel were not sufficient in themselves to justify the difference in ignition behavior. As air velocities increased, the hot surface ignition temperature for stainless steel approached about 800°C for air speeds in the order of 40 meters per second; a similar value was noted for titanium.

These very preliminary results for alloys other than stainless steels pointed out the necessity of considering surface material metallurgical properties as yet another parameter in the general investigation of hot surface initiated, nacelle-type fires. Two avenues of additional investigation were indicated by these results:

(i) easier ignition on a simple titanium boat implied a greater potential safety hazard could be present on a prototype heated surface made of titanium rather than stainless steel. This resulted in construction of a full-sized titanium heated surface for the fire simulator.

(ii) the results of burning combustible fluids on simple indirectly heated boats of different alloys (including high temperature alloys like Inconel, Rene 41, Inco 601, Udimet 700) could be used to predict with reasonable accuracy, the ignition behavior of much larger size heated surfaces of the same materials under more dynamic conditions. The initial results of ignition of JP-4 on stainless steel and titanium boats at low air speeds and the subsequent results on the larger prototype fire simulator surface yielded good probability of success of such predictions.

A full size titanium alloy heated surface was constructed for the Fire Simulator System and the specified fuels were sprayed over the heated surface. As initially indicated by the simple titanium boat test, the

combustible fuels did indeed ignite and burn at lower temperatures (50° to 75°C lower on the average) than the same fuels contacting a heated stainless steel surface. The experimental data of figure 7 graphically supports these conclusions. Figure 7 depicts ignition performance bands fuels ignited on the two heated surfaces with average surface temperature and average surface air speeds over the surface boundary layer projections as parameters.

When hydraulic fluids were injected into the air stream the same trend prevailed -- a combustible fluid ignited at lower temperatures on a heated titanium surface.

The potential application of using small inexpensive boats of special alloys to ascertain behavior of larger more expensive and geometrically complex surfaces of the same material was made evident by the data of figure A-2. Actual tests were possible using the simple boats and the full size stainless steel and titanium surfaces fabricated for the Ames Fire Simulator System. The boats were located in a relatively quiescent region just downstream of the major re-entrant boundary layer separators and were surrounded by a layer of ceramic wool to prevent vapors from sweeping off the boat and being ignited on the heated surface below or adjacent to the boat. The local surface air flows in general served to maintain a good supply of air such that for the drops of fluid carefully placed with a hypodermic syringe onto the boat surface, when they evaporated, the air-vapor mixture approached stoichiometry and burned with visible flame after having been ignited by the heated boat surface.

There was no doubt the boat results graphed on figure A-2 coupled with a simple temperature displacement factor could have been employed to predict the behavior of JP-4 sprayed at high pressure over a full sized heated

surface. At higher average air speeds (hence higher surface temperatures required for ignition), results for the two full sized surfaces converged. Of greater importance, however, was the lower average air-speed/fuel-ignition threshold values; conditions that would result in ignition of a fuel accidentally released and contacting heated surfaces with their stagnation zones so commonly found in actual nacelle spaces.

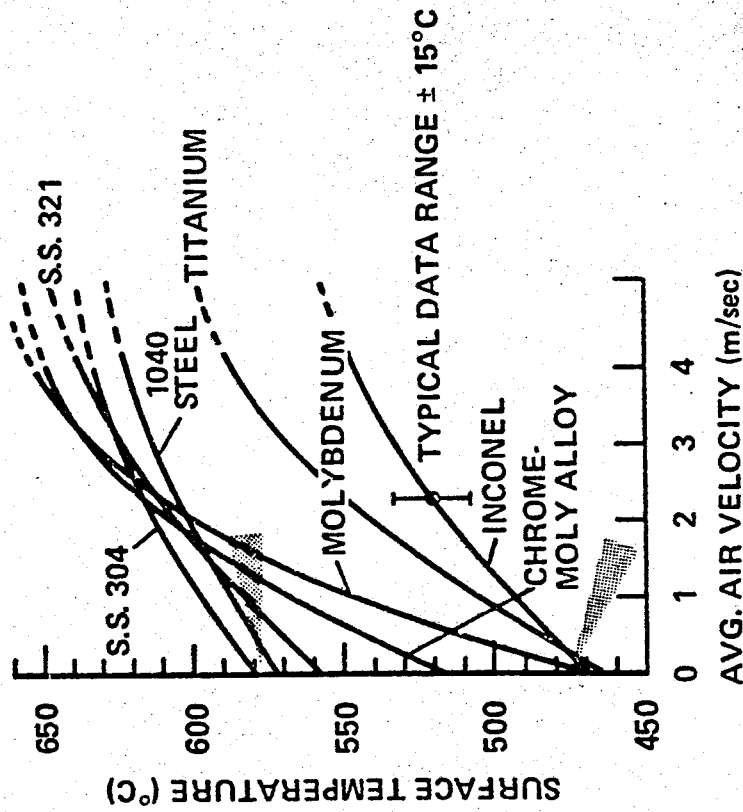

FIGURE A1 HOT SURFACE IGNITION TEMPERATURE FOR J. P.-4 AS A FUNCTION OF MATERIAL AND AIR FLOW

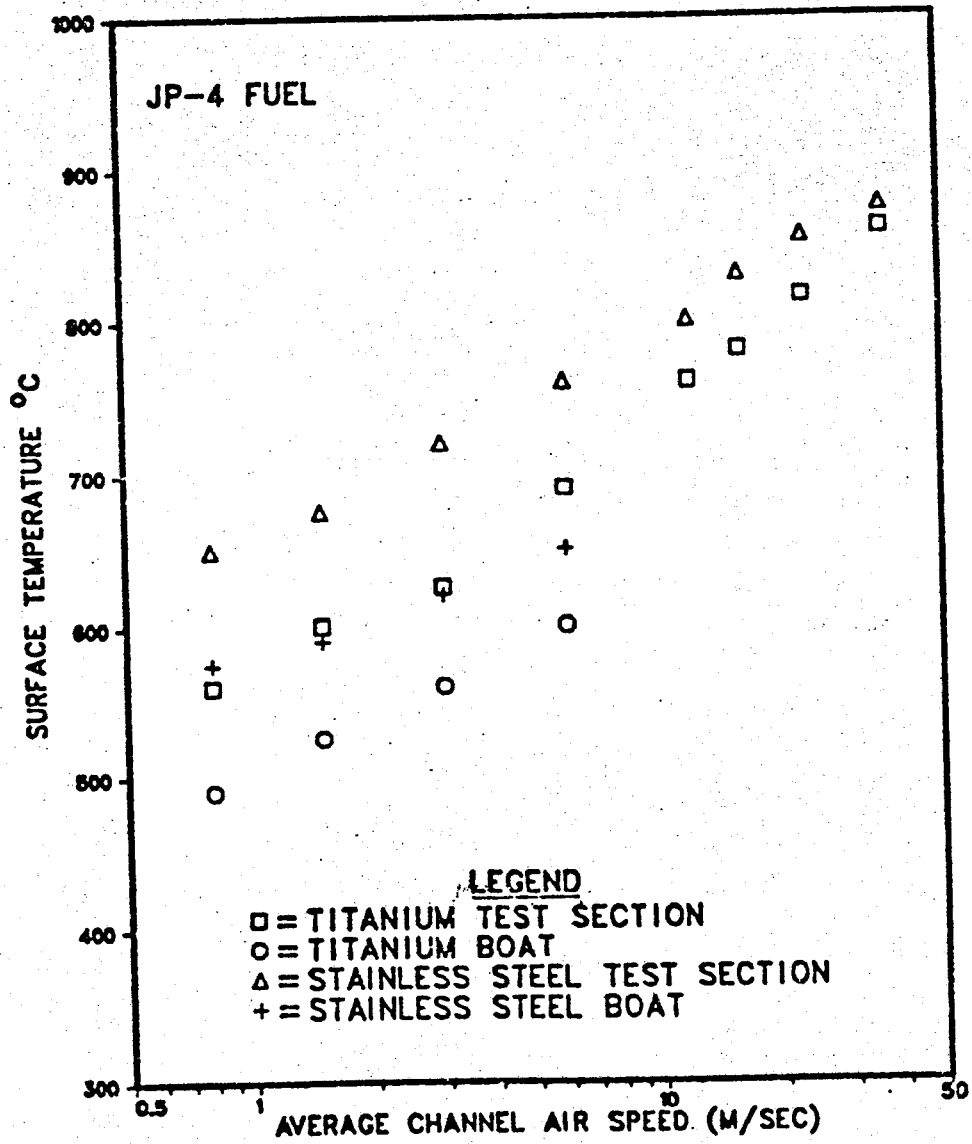

FIGURE A-2 AIR SPEED AND SURFACE MATERIAL EFFECTS ON HOT SURFACE IGNITION TEMPERATURE OF AIRCRAFT FUELS