

WADC TECHNICAL REPORT 52-35

RESEARCH ON THE FLAMMABILITY CHARACTERISTICS OF AIRCRAFT FUELS

*G. W. Jones
M. G. Zabetakis
J. K. Richmond
G. S. Scott
A. L. Furno*

United States Department of the Interior

June 1952

*Materials Laboratory
Contract No. AF 33(038) 50-1293E
RDO No. 601-301*

**Wright Air Development Center
Air Research and Development Command
United States Air Force
Wright-Patterson Air Force Base, Ohio**

McGregor & Werner, Dayton, O.
250 March, 1953

Contrails

FOREWORD

This report was prepared by the Gaseous Explosions Branch, Explosives and Physical Sciences Division of the U. S. Bureau of Mines on Contract Number AF 33(038) 50-1293E, RDO No. 601-301, Aircraft Fuels and Engine Oils. This project was initiated at the Bureau of Mines under Air Materiel Command supervision and completed under Wright Air Development Center supervision. It was administered under the direction of Mr. R. W. Altman and Capt C. M. Murray of Materials Laboratory, **Directorate of Research, WADC**. Drs. Bernard Lewis and Glenn H. Damon were the administrators for the U. S. Bureau of Mines. Mr. G. W. Jones was project engineer. Messrs. G. W. Jones, M. G. Zabetakis, J. K. Richmond, G. S. Scott, and A. L. Furno were the authors of this report.

Those who were engaged in the experimental work for this project included Messrs. G. W. Jones, M. G. Zabetakis, J. K. Richmond, A. L. Furno, G. S. Scott, and F. E. Donath.

WADC TR 52-35

ABSTRACT

The results of limit of flammability, limit of ignitibility, and ignition temperature tests conducted on aircraft fuel vapor-air mixtures by the U. S. Bureau of Mines Gaseous Explosions Laboratory between February 19, 1950 and February 19, 1952 are presented. Two aviation gasolines grades 100/130 and 115/145, and two jet fuels grades JP-1 and JP-3, were investigated. A limited amount of work was done on the ignitibility of JP-1 mists and sprays, and on the ignition temperatures of aircraft hydraulic fluid AN-O-366.

In addition to the above results, sections are included on definitions and theory, and apparatus used for the investigation is described.

PUBLICATION APPROVAL

This report has been reviewed and is approved.

FOR THE COMMANDING GENERAL:

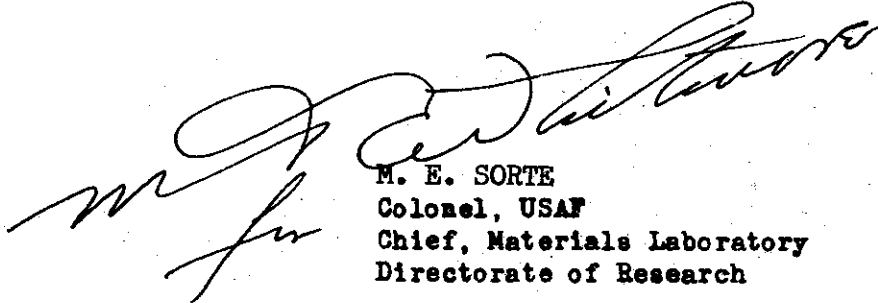

M. E. SORTE
Colonel, USAF
Chief, Materials Laboratory
Directorate of Research

Contrails

TABLE OF CONTENTS

		<u>Page</u>
SECTION I	Purpose of the Project - - - - -	1
SECTION II	Definitions and Theory - - - - -	5
2.1	Flammable Gaseous Mixture - - - - -	5
2.2	Nonflammable Gaseous Mixture - - - - -	5
2.3	Limit Mixture - - - - -	5
2.4	Concentration Limits of Flammability - - - - -	5
2.5	Limits of Ignitibility - - - - -	7
2.6	Temperature or Equilibrium Concentration Limits of Flammability - - - - -	7
2.7	Low Pressure Limit of Flammability - - - - -	11
2.8	Spontaneous Ignition Temperature and the Corresponding Time Lag Before Ignition - - -	11
2.9	Minimum Spontaneous Ignition Temperature - -	11
2.10	Flammability Characteristics of Combustible Gases and Vapors - - - - -	11
2.11	Combustion of Flammable Mixtures - - - - -	14
2.12	Mists and Sprays - - - - -	17
SECTION III	Experimental Results - - - - -	19
3.2	Limits of Flammability - - - - -	19
3.3	Spark Ignition Energy Measurements - - - - -	32
3.4	Ignition Temperatures - - - - -	39
3.5	Sprays and Mists - - - - -	40
SECTION IV	Proposed Future Investigations - - - - -	46
SECTION V	Conclusions - - - - -	47

Contracts

TABLE OF CONTENTS (Cont'd.)

	<u>Page</u>
BIBLIOGRAPHY - - - - -	49
APPENDIX I The F-1 Limit-of-Flammability apparatus - - - - -	52
APPENDIX II The I-8 Ignition Temperature apparatus - - - - -	54
APPENDIX III The F-9 Limit-of-Flammability Apparatus - - - - -	56
APPENDIX IV The F-10 Limit-of-Flammability Apparatus - - - - -	59
APPENDIX V The F-11 Limit-of-Flammability apparatus - - - - -	59
APPENDIX VI The F-12 Limit-of-Flammability apparatus - - - - -	73
APPENDIX VII The F-21 Limit-of-Flammability Apparatus - - - - -	73
APPENDIX VIII The F-24 Limit-of-Flammability Apparatus - - - - -	74
APPENDIX IX Spray and Mist Apparatus - - - - -	74
APPENDIX X Ignition Sources - - - - -	80
INDEX - - - - -	90
INITIAL DISTRIBUTION LIST - - - - -	93

Contrails

LIST OF ILLUSTRATIONS

<u>FIGURE</u>		<u>Page</u>
1.	A.S.T.M. distillation curves for (a) aviation gasoline grade 100/130, (b) aviation gasoline grade 115/145, (c) aviation jet fuel grade JP-1, and (d) aviation jet fuel grade JP-3 - - - - -	2
2.	Reid vapor pressure curves for (a) aviation gasoline grades 100/130 and 115/145, (b) aviation jet fuel grade JP-1, and (c) aviation jet fuel grade JP-3 - - - - -	3
3.	Ignitibility curve for butane-air mixtures at one atmosphere and 78°F. - - - - -	8
4.	General form of limit-of-flammability curves at constant pressure - - - - -	9
5.	General form of temperature limits of flammability curve for equilibrium (saturated) vapor-air mixtures - -	10
6.	A general flammable volume of a combustible vapor-air mixture - - - - -	13
7.	Comparison of the variations in the concentration limits of flammability of six hydrocarbons with temperature for one atmosphere pressure using (a) units of volume, (b) units of weight to express the lower limit concentrations	15
8a.	Concentration limits of flammability for aviation gasoline grade 100/130 vapor-air mixtures at $78 \pm 1^\circ\text{F}$. -	20
8b.	Concentration limits of flammability for aviation gasoline grade 100/130 vapor-air mixtures at $78 \pm 1^\circ\text{F}$. (curve obtained from Figure 8a taking average molecular weight of this fuel to be 100) - - - - -	21
9a.	Concentration limits of flammability for aviation gasoline grade 115/145 vapor-air mixtures at $78 \pm 2^\circ\text{F}$. - - -	22
9b.	Concentration limits of flammability for aviation gasoline grade 115/145 vapor-air mixtures at $78 \pm 2^\circ\text{F}$. (curve obtained from Figure 9a taking average molecular weight of this fuel to be 100). - - - - -	23
10a.	Concentration limits of flammability for aviation jet fuel grade JP-3 vapor-air mixtures at $79 \pm 2^\circ\text{F}$. - - - -	24
10b.	Concentration limits of flammability for aviation jet fuel grade JP-3 vapor-air mixtures at $79 \pm 2^\circ\text{F}$. (curve obtained from Figure 10a taking average molecular weight of this fuel to be 100) - - - - -	25

Contrails

ILLUSTRATIONS (Cont'd.)

<u>FIGURE</u>		<u>Page</u>
11.	Equilibrium concentration limits of flammability of the 0 to 5% fraction of aviation gasoline grade 100/130 vapor-air mixtures over the temperature range -100 to 0°F. (the 0 to 5% fraction of this fuel was distilled under the temperature and pressure conditions of each test). - - - - -	28
12.	Equilibrium concentration limits of flammability of the 0 to 10% fraction of aviation gasoline grade 115/145 vapor-air mixtures over the temperature range -100 to 0°F. (the 0 to 10% fraction of this fuel was distilled under the temperature and pressure conditions of each test). - - - - -	29
13.	Equilibrium concentration limits of flammability of the 0 to 30% and 60 to 90% fractions of aviation jet fuel grade JP-1 vapor-air mixtures over the temperature range 60 to 200°F. (the 0 to 30 and 60 to 90% fractions of this fuel were distilled under the temperature and pressure conditions of each test). - - - - -	30
14.	Equilibrium concentration limits of flammability of the 0 to 5% and 80 to 90% fractions of aviation jet fuel grade JP-3 vapor-air mixtures over the temperature range -100 to +200°F. (the 0 to 5% and 80 to 90% fractions of this fuel were distilled under the temperature and pressure conditions of each test). - - - - -	31
15.	Oscillograms of the (a) voltage across and (b) current through a spark discharge gap in an aviation gasoline grade 115/145 vapor-air mixture at -73°F. and 27 inches Hg absolute. (See Figure 16 for the analysis of these oscillograms - - - - -	34
16.	Analysis of oscillograms 551-3 and 551-4 given in Figures 15a and 15b - - - - -	35
17.	Limits of ignitibility of aviation gasoline grade 115/145 vapor-air mixtures at low temperatures and pressures for three ignition sources superimposed on the equilibrium concentration limit-of-flammability curves for the 0 to 10% fraction of the fuel - - - - -	36
18.	Low pressure ignitibility curves (minimum pressure at which ignition occurs plotted as a function of spark energy and time duration) for the concentrations of aviation gasoline grade 100/130 vapor in air noted on each set of graphs - - - - -	37

Contrails

ILLUSTRATIONS (Cont'd.)

<u>FIGURE</u>		<u>Page</u>
19.	Low pressure ignitibility curves (minimum pressure at which ignition occurs, plotted as a function of spark energy) for different concentrations of aviation gasoline grade 100/130 vapor-air mixtures and for two electrode configurations. Duration of sparks is between 500 and 2500 microseconds. - - - - -	38
20.	Variations in spontaneous ignition temperatures with time lag before explosion and quantity of combustible for, (a) aviation jet fuel grade JP-1, (b) aviation jet fuel grade JP-3 and, (c) aircraft hydraulic fluid AN-O-366 in contact with magnesium (FS-1, Spec. QQ-M, 44) in air at atmospheric pressure. - - - - -	41
21.	Lines of equi-ignition probability for aviation jet fuel grade JP-1 spray in air using powerful spark ignition source (30-50 watts). - - - - -	42
22.	Total air velocities due to the primary air from a two-fluid nozzle plus the entrained secondary air for three exit chambers attached to the nozzle, (large circles represent chamber outlets, numbers in small circles are velocities in hundreds of feet per minute). - - - - -	44
23.	Photomicrographs of impressions made on a carbon coated microscope slide by aviation jet fuel grade JP-1 spray formed with a two-fluid nozzle. - - - - -	45
24.	Schematic diagram of the F-1 limit-of-flammability apparatus. - - - - -	53
25.	Detailed drawing of the I-8 ignition temperature apparatus. - - - - -	55
26.	Schematic diagram of the F-9 elevated temperature equilibrium concentration limit-of-flammability apparatus. -	57
27.	Close-up view of the F-9 and F-11 explosion chambers installed in the oven. - - - - -	58
28.	Schematic diagram of the F-10 limit-of-flammability apparatus. - - - - -	60
29.	General view of the F-10 limit-of-flammability apparatus.	61
30.	Close-up view of the F-10 explosion chamber installed in the CO ₂ cold chamber. - - - - -	62

Contrails

ILLUSTRATIONS (Cont'd.)

<u>FIGURE</u>		<u>Page</u>
31.	Schematic diagram of the F-11 limit-of-flammability apparatus. - - - - -	63
32.	General view of the liquid feed device, air feed assembly, and photoelectric temperature controller (TC-19) used with the F-11 limit-of-flammability apparatus. - - - - -	64
33.	Schematic diagram of the TC-19 photoelectric temperature controller used with the F-9 and F-11 limit-of-flammability apparatus. - - - - -	65
34a.	an improved model of the liquid feed service used with the F-11 limit-of-flammability apparatus. - - - - -	66
34b.	Schematic diagram of the electrical portion of the liquid feed device (improved model). - - - - -	66
35.	Schematic diagram of the F-24 limit-of-flammability apparatus. - - - - -	75
36.	General view of the F-24 limit-of-flammability apparatus with the surge generator and its associated measurement apparatus in place for an actual test. - - - - -	76
37.	Schematic diagram of the F-26 continuous flow-type spray ignition apparatus. - - - - -	77
38.	The F-26 continuous flow-type spray ignition apparatus -	78
39.	Block diagram of the F-27 solid injection-type spray ignition apparatus. - - - - -	79
40.	Block diagram of the U. S. Bureau of Mines surge generator and spark ignition energy measurement apparatus. - -	81
41.	Circuit diagram of the U. S. Bureau of Mines power supply and surge generator used in making spark energy measurements. - - - - -	82
42.	Circuit diagram of the dual-pulse time delay network for synchronizing the surge generator and the oscillograph sweeps. - - - - -	84
43.	Circuit diagram of the surge clipper - - - - -	85
44.	Circuit diagram of the "Slave" cathode-ray oscilloscope to operate with Dumont type 304-H oscilloscope.	87
45.	Typical surge waves of voltage and current generated by the U. S. Bureau of Mines surge generator (cf. insert) -	89

Contrails

INTRODUCTION

The limits of flammability of various combustible-air mixtures have been the subject of extensive research. However, few investigators have considered limits of flammability at reduced temperatures and pressures. As high altitude flying involves explosion risks from combustible-air mixtures, the Wright Air Development Center has been led to initiate a program for the investigation of fire and explosion hazards in aircraft. Information obtained from experiments and literature surveys in the course of this investigation indicate a great need for a systematic research program on various flammability characteristics of aircraft fuels. The work reported here is an outgrowth of the original WADC investigation.

x

WADC TR 52-35

Contracts

SECTION I

PURPOSE OF THE PROJECT

1.1 The present project involves the determination of various flammability characteristics of aircraft fuels under flight conditions. Its purpose may be determined best by considering the program undertaken and the fuels studied.

1.2 Program

1.2.1 The program for the study of flammability characteristics of aircraft fuels may be separated into two phases.

1.2.2 PHASE 1: (1) Determine the limits of flammability of various USAF fuels over the temperature range -100 to $+160^{\circ}\text{F.}$ and the pressure range 1 to 30 inches mercury (Hg). (2) Determine how the energy of the spark and the material, size and shape of the spark electrodes affect the limits of ignitibility at various temperatures (-100 to 160°F.) and pressures (1 to 30 inches Hg). (3) Study the effect of the type and strength of the ignition source (spark, hot wire, gun cotton, etc.) on the limits of ignitibility at low pressures with the view of establishing the low pressure limit of flammability.

1.2.3 PHASE 2: (1) Using a flow system, determine the limits of ignitibility (expressed as a fuel-air ratio) as a function of temperature, pressure and mixture velocity of various USAF fuel vapor-air mixtures. The ignition source should be a continuous spark or heated element of varying size, shape and material, as specified by the contractor. If a heated element is used, the contact time between the combustible mixture and the heated element should be determined in all cases. (2) Using a flow system, determine the effect of various USAF fuel spray patterns and fuel droplet size ranges on the limits of ignitibility under the conditions outlined above. (3) Investigate the flammability characteristics of various USAF fuel components.

1.3 Fuels

1.3.1 The following USAF fuels were used in this investigation:

- (1) Aviation gasoline, grade 100/130
- (2) Aviation gasoline, grade 115/145
- (3) Aviation jet fuel, grade JP-1
- (4) Aviation jet fuel, grade JP-3

In addition, a limited amount of work was performed on (5) aircraft hydraulic fluid AN-O-366. The ASTM distillation and vapor pressure curves of the above fuels are given in Figures 1 and 2. The data for these

Contrails

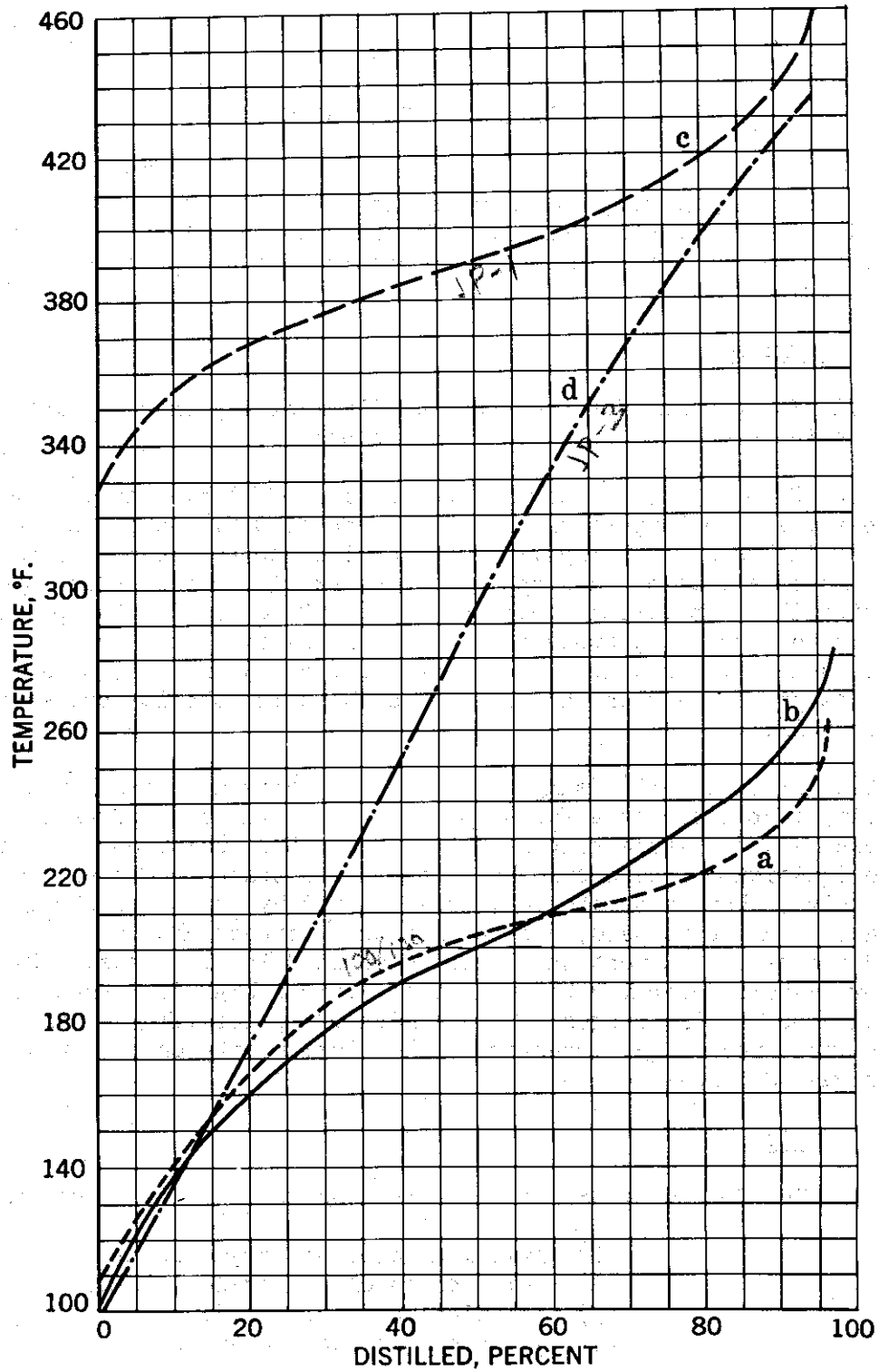

Figure 1.—A.S.T.M. distillation curves for (a) aviation gasoline grade 100/130, (b) aviation gasoline grade 115/145, (c) aviation jet fuel grade JP-1, and (d) aviation jet fuel grade JP-3.

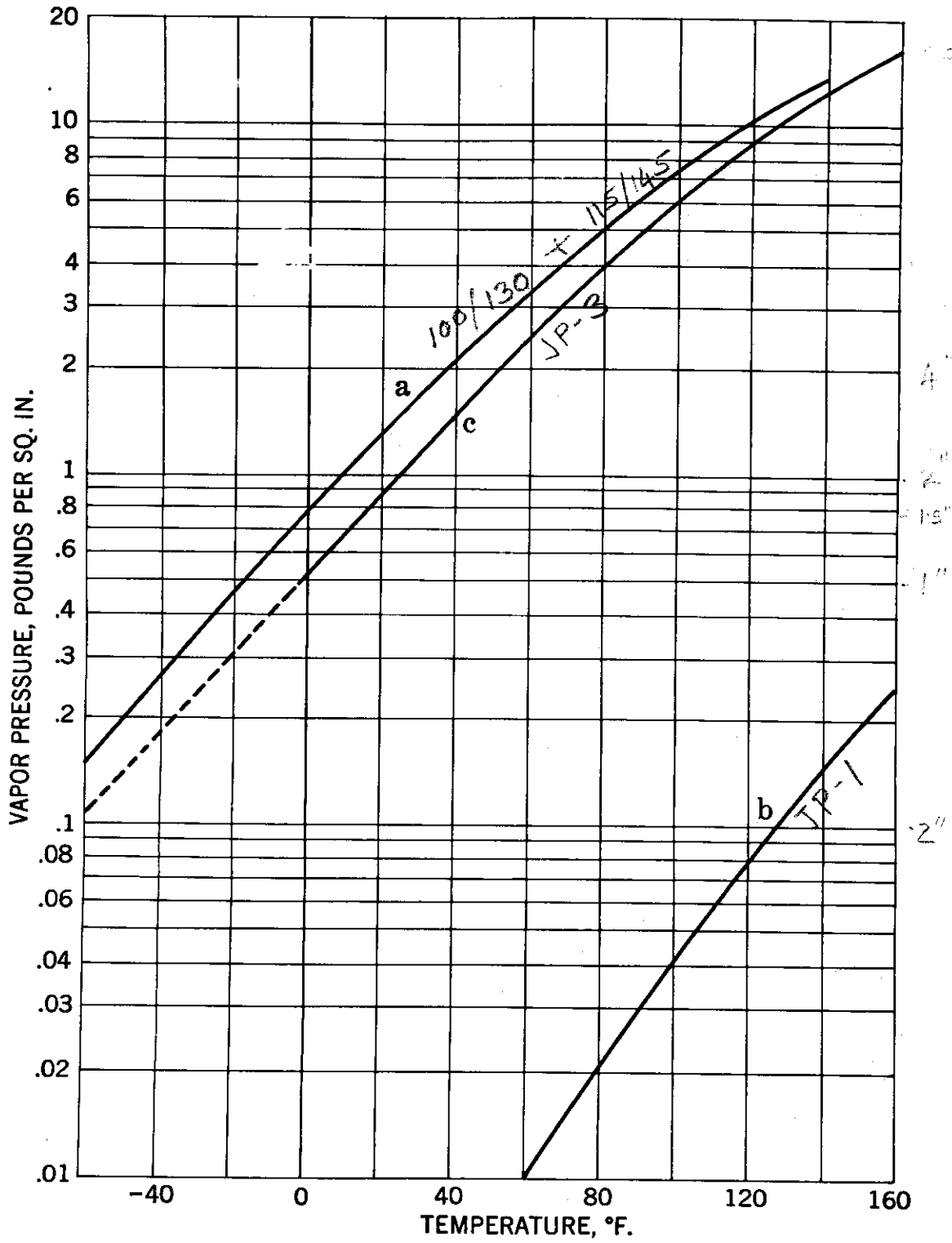

Figure 2.—Reid vapor pressure curves for (a) aviation gasoline grades 100/130 and 115/145, (b) aviation jet fuel grade JP-1 and (c) aviation jet fuel grade JP-3.

Contrails

curves were obtained from WADC. The dashed portion of curve C in Figure 2 is not part of the WADC data, but is an extrapolation of the data lying above 0°F. This extrapolation was made in order to account for the explosive saturated JP-3 vapor-air mixtures which exist below -40°F. (temperature below which no explosions should occur according to the original WADC data). The specifications for the above fuels and the hydraulic fluid are covered in Specifications MIL-F-5572, MIL-F-5624A, MIL-F-5616 and MIL-O-5606.

SECTION II

DEFINITIONS AND THEORY

2.1 Flammable Gaseous Mixture

2.1.1 A "flammable gaseous mixture" is a mixture of gases through which flame is capable of propagating.

2.2 Nonflammable Gaseous Mixture

2.2.1 A "nonflammable gaseous mixture" is a mixture of gases through which flame fails to propagate.

2.3 Limit Mixture

2.3.1 A mixture of gases whose composition lies in the transition region between mixture compositions corresponding to flammable and nonflammable mixtures may be loosely termed a "limit mixture." A flammable mixture may be rendered apparently, or perhaps truly, nonflammable by a change in one or more of the following factors associated with the mixture or its surroundings: (Ref. 38)

- (1) Temperature
- (2) Pressure
- (3) Ratio of combustible to oxygen
- (4) Ratio of inert or other foreign gas to oxygen
- (5) Characteristics of the ignition source
- (6) Geometry and size of the confining vessel
- (7) Physical state and surroundings of the gaseous mixture

It should be noted that even though a suitable change in any one of the above factors may render a flammable mixture nonflammable, the converse is not necessarily true. The above factors are interrelated in such a manner that before deciding whether or not a mixture is truly nonflammable an observer should determine the effects of each of these factors on his observations. This point will be discussed more fully in the following sections.

2.4 Concentration Limits of Flammability

2.4.1 As the combustible mixtures considered in this report were composed of combustible vapors and air, the ratio of inert or other foreign gas to oxygen (4) will be considered constant for all mixtures discussed. If in addition to (4) all items except (3) are held constant while (3) is varied for a flammable mixture by diluting the mixture with air, the combustible content of the flammable mixture eventually becomes so low that the

Contrails

mixture fails to propagate flame. If at this point a number of similar tests are made in which (5), (6) and (7) are also varied, the gaseous mixture being homogeneous and quiescent during the period of application of the ignition source as well as the subsequent period of observation, the lowest concentration of combustible in air at a particular temperature and pressure that is capable of propagating flame through a homogeneous quiescent mixture of the combustible and air being tested may be expressed as:

$$L_{t,p} = 1/2 [\bar{C}_{fl} + C_{ng}] \quad (1)$$

2.4.2 Similarly, if a flammable gaseous mixture is rendered nonflammable by the addition of an excess of combustible, the upper limit of flammability may be expressed as:

$$U_{t,p} = 1/2 [\bar{C}_{fg} + C_{nl}] \quad (2)$$

$L_{t,p}$ and $U_{t,p}$ being respectively the lower and upper concentration limits of flammability at a specified temperature and pressure; C_{ng} and C_{nl} are the greatest and least concentrations of combustible in air which are nonflammable, and \bar{C}_{fl} and \bar{C}_{fg} are the least and greatest concentrations of combustible in air which are flammable at the specified temperature and pressure of the test.

2.4.3 The concentration limits of flammability are conventionally termed limits of flammability, limits of inflammability, flammable (or inflammable) limits, or explosive limits. These terms are considered synonymous.

2.4.4 An important experimental criterion in determining the limits of flammability of a particular combustible vapor or gas in air at a specified temperature and pressure is the following: The limits of flammability of any combustible are widened — that is, the lower limit is decreased and the upper limit is increased — with moderate increases in temperature and pressure. As most ignition sources instantaneously increase both the temperature and pressure in their immediate vicinity, in going from a flammable to a nonflammable mixture at a specified temperature and pressure, there must be a small range of concentrations (the transition region) that are able to propagate flame a short distance away from the ignition source due to the instantaneous increase in temperature and pressure. However, these mixtures will not propagate flame once the effects of the ignition source are no longer felt. If this transition region is not observed, then the limits of flammability have probably not been attained; instead, these apparent limits are merely limits of ignitibility or ignition limits that depend on the ignition source and are therefore not a function of the combustible, temperature and pressure alone as are the limits of flammability.

2.5 Limits of Ignitibility

2.5.1 The limits of ignitibility have been briefly defined in paragraph 2.4.1. A better way of visualizing the relationship between the limits of ignitibility and the true limits of flammability is to plot the limits of ignitibility as a function of the ignition source energy. To be consistent let us assume that the source energy is delivered as a single square wave pulse whose duration is the same in each case, that is, we will assume the time of delivery of the ignition energy to be constant. If we then plot the limit of ignitibility as abscissa against the energy of the ignition source as ordinate, we obtain a curve such as that in Figure 3. (Refs. 3 and 7). The actual shape of the curve is not important here. The important thing is that for a certain optimum range of ignition source energies (and an associated range of time durations for delivery of the energy to the test mixture) the limits of ignitibility depend only on the combustible tested (assuming the temperature and pressure to be constant). This means that the important experimental criterion described in paragraph 2.4.4 is applicable. Thus these unique limits of ignitibility are, by definition, the limits of flammability of the material tested at the temperature and pressure specified for the test.

2.6 Temperature or Equilibrium Concentration Limits of Flammability

2.6.1 If the temperature of a flammable mixture corresponding to the upper limit of flammability^x is gradually decreased while the pressure is held constant, a temperature is finally reached such that the upper limit of flammability coincides with the dew point of the combustible (or of one of its constituents in the case of a mixture of combustibles). This temperature is the upper temperature limit of flammability at the constant pressure specified for the test. If the temperature is decreased further, all concentrations lying on the equilibrium vapor-air curve (dew-point curve) represent flammable mixtures until a point is reached on this curve that coincides with the lower limit of flammability at that temperature and pressure. This temperature represents the lower temperature limit of flammability; it also corresponds roughly to the flash point of the combustible if the pressure is one atmosphere. (If the U. S. Bureau of Mines F-9 apparatus is used, the lower temperature limit at atmospheric pressure could be defined as the flash point). The vapor concentration for temperatures below the lower temperature limit of flammability is too low (at the specified constant pressure of the tests considered) to give an explosive limit (Figure 4). Obviously the lower temperature limit will decrease for a moderate decrease in pressure (Figure 5).

2.6.2 It should be noted also, in conjunction with the temperature limits of flammability (Figure 5), that these limits may be converted to concentration limits when the vapor pressure of the combustible is known as a function of temperature.

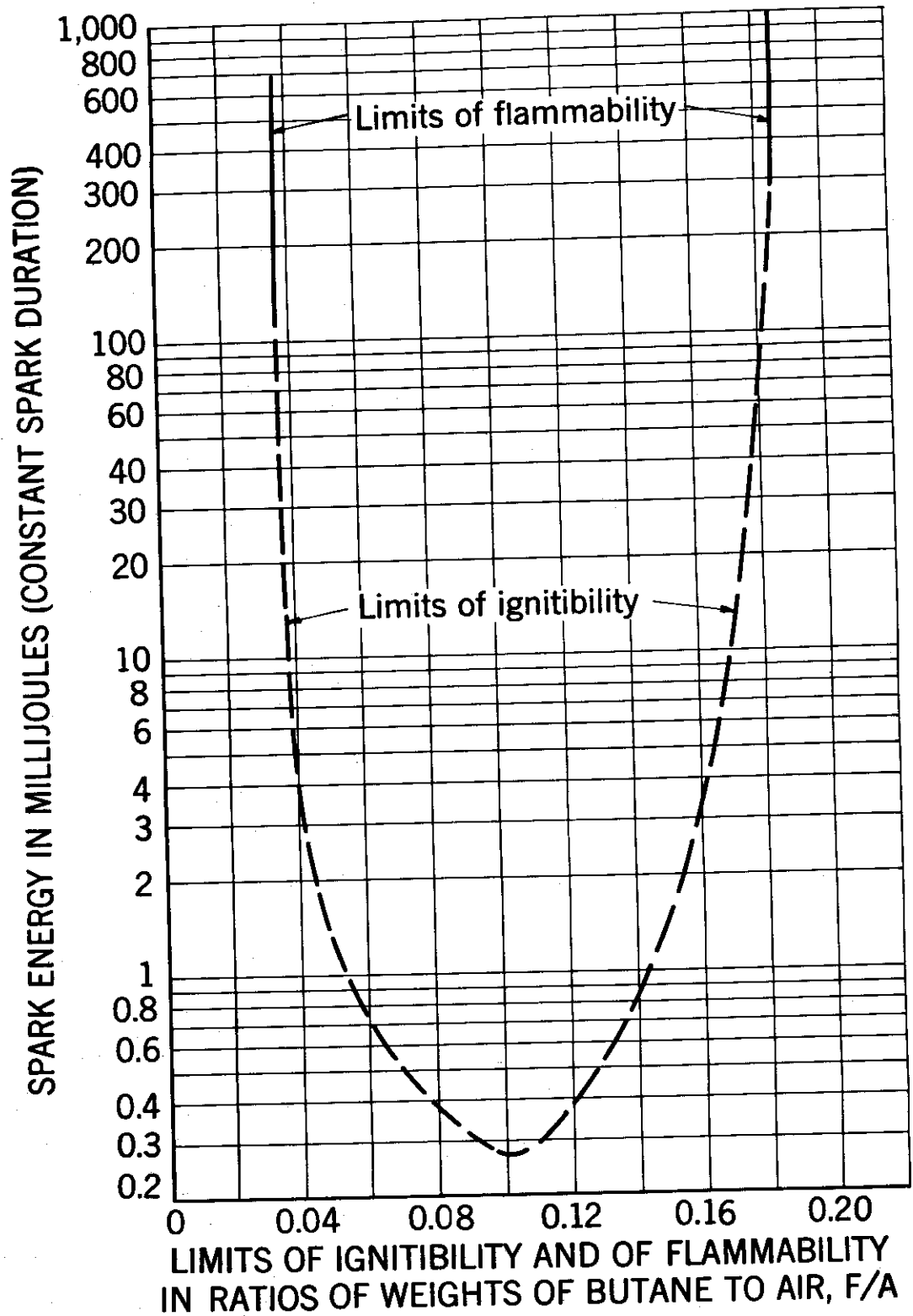

Figure 3. - Ignitability curve for butane-air mixtures at one atmosphere and 78° F.

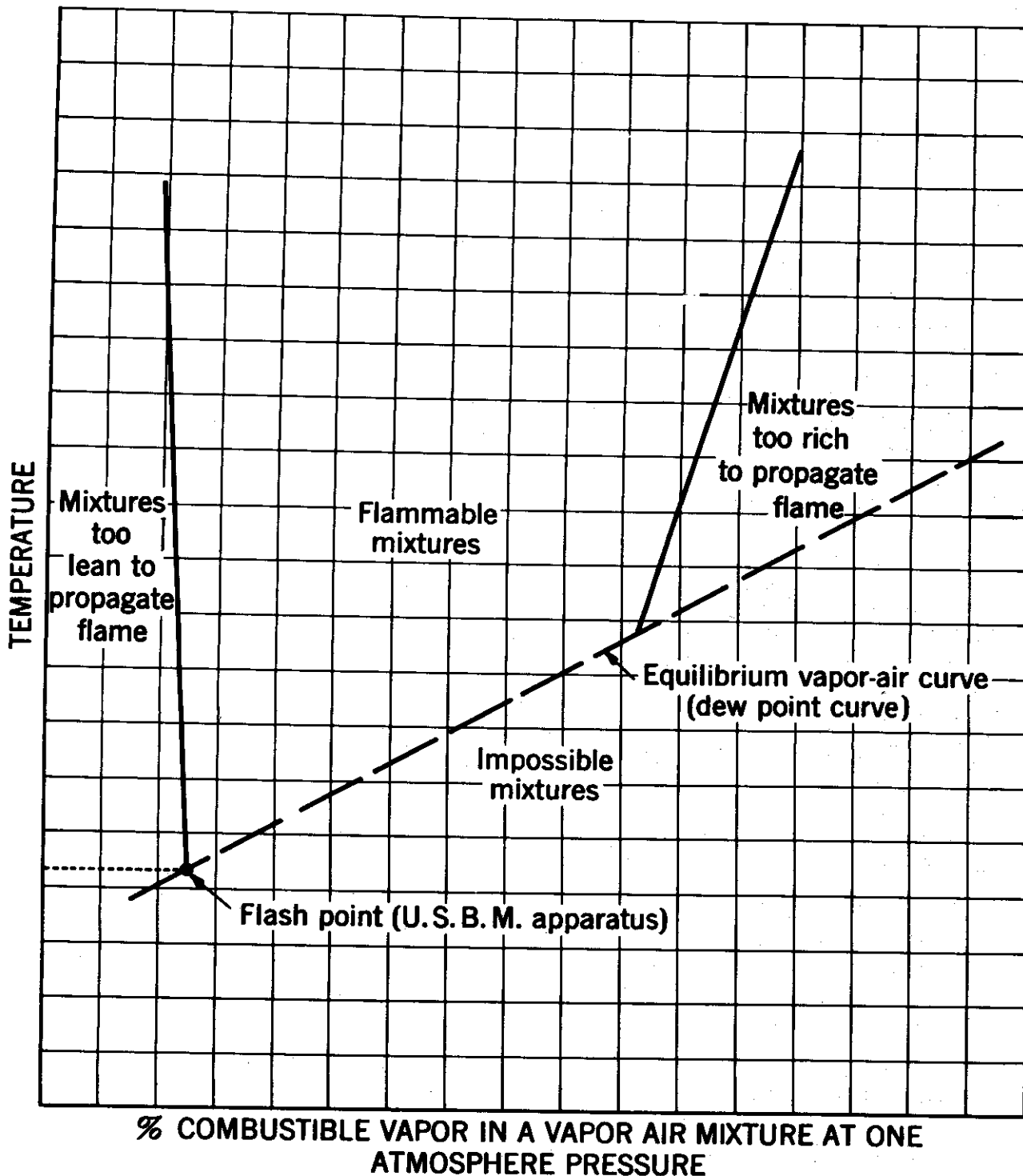
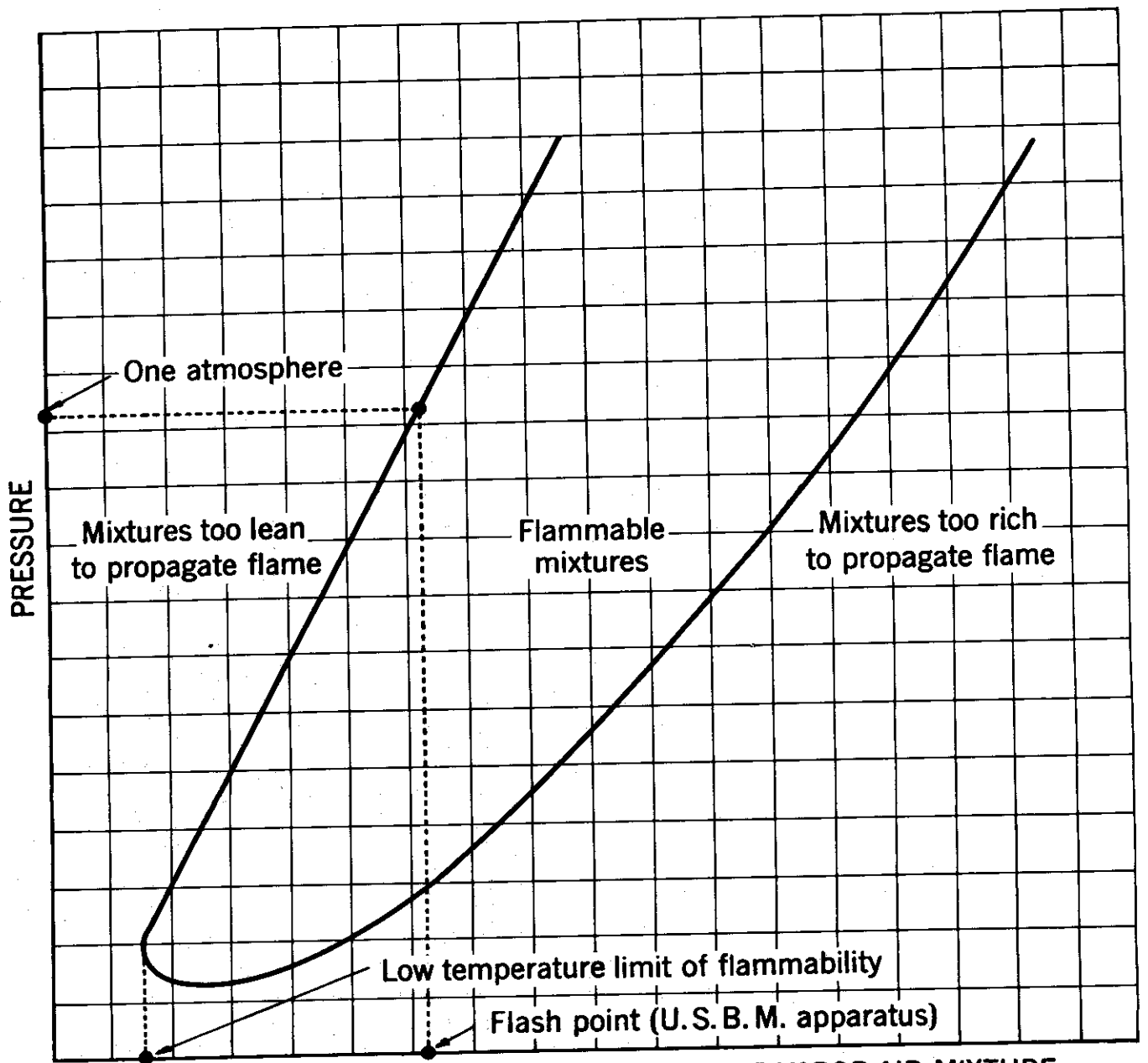

Figure 4. - General form of limit of flammability curves at constant pressure.



TEMPERATURE OF SATURATED COMBUSTIBLE VAPOR-AIR MIXTURE
Figure 5. - General form of temperature limits of flammability curve for equilibrium (saturated) vapor-air mixtures.

Contrails

2.6.3 The limits discussed above refer only to vapor-air mixtures. It should not be assumed that an explosion hazard does not exist at temperatures below the lower temperature limit of flammability, as finely divided droplets of combustible liquid may form sprays at temperatures below the lower temperature limit. In such cases the problem is complicated in that the vapor pressure then is also a function of the droplet size; moreover to determine whether the vapor-air mixture surrounding any particular droplet is explosive or not we need to know the heat-transfer rate from the surroundings to the droplet and the vaporization rate of the droplet. As all available data indicate that the burning process associated with combustible liquids occurs in the vapor state, the problem of flammable sprays appears to be an extension of the burning of vapor-air mixtures.

2.7 Low Pressure Limit of Flammability

2.7.1 No mention has been made yet of the lowest pressure at which a flammable mixture can propagate flame. This lowest pressure could perhaps be considered the region where the lower limit meets the upper limit of flammability. It is in general very difficult to get a satisfactory ignition source for experiments in this low pressure region (especially for pressures below about one inch Hg absolute). In many experiments the criterion for determining the true limits of flammability, as outlined in paragraph 2.4.4., is not attained. When this criterion has not been met the experiments yield limits of ignitibility; this is indicated when it occurs in the figures included in this report by a broken line and an appropriate label (e.g., cf. Figures 8a-10b).

2.8 Spontaneous Ignition Temperature and Corresponding Time Lag Before Ignition

2.8.1 The spontaneous ignition temperature at a specified pressure of a particular combustible-air mixture in contact with a specified surface is the temperature at which this mixture will ignite spontaneously in a finite time interval t , the corresponding time lag before ignition.

2.9 Minimum Spontaneous Ignition Temperature

2.9.1 At a specified pressure of a combustible in contact with a specified surface, the minimum spontaneous ignition temperature for all possible concentrations of combustible in air that corresponds to some finite time lag sufficiently long to assure a minimum value of ignition temperature is known as the minimum ignition temperature of the combustible in air. This minimum temperature depends on the surroundings and their geometry as well as on the history of the combustible-air mixtures tested, and on the velocity of the mixture tested.

2.10 Flammability Characteristics of Combustible Gases and Vapors

2.10.1 PURE LIQUIDS. The limits of flammability and spontaneous ignition temperatures (S.I.T.) corresponding to a time-lag long enough to give the

Contrails

lowest S.I.T. for a particular mixture, pressure and surface, constitute the flammability characteristics of a combustible gas or vapor. Experimentally we obtain temperature limits of flammability as a function of pressure, concentration limits of flammability as a function of temperature, and also as a function of pressure (Figures 4 and 5) and spontaneous ignition temperatures as a function of concentration for a fixed surface, pressure, and time lag. All these values may be plotted on a three-dimensional coordinate system with concentration, pressure, and temperature as the three variables. If the limits of flammability are plotted in this space, there results a flammable volume as in Figure 6. Mixtures in this volume are flammable when an appropriate ignition source is used. For elevated temperatures and a specified surface, pressure and composition, spontaneous ignition results if the time of contact between the heated surface and the combustible mixture is greater than a certain specified time interval. For completeness this S.I.T. curve has been included in Figure 6 for one atmosphere pressure.

2.10.2 LIQUID MIXTURES. As actual aircraft fuels consist of mixtures of combustibles we will digress at this point to consider the effects of these mixtures on the over-all picture of the flammability characteristics of the fuels. Everything discussed to this point applies to pure liquids as well as mixtures of pure liquids, however when working with mixtures the flammability characteristics may vary considerably depending on the history of the mixture. The fuel mixtures we will consider are actually solutions composed of a large number of hydrocarbons.

2.10.3 The vapor pressure at equilibrium of any component of the hydrocarbon mixtures that make up the aircraft fuels considered here may be determined for the vapor above the liquid in a closed container by Raoult's Law: (Ref. 19)

$$P_x = \frac{n_x p_x^0}{\sum_{s=1}^N n_s} \quad (3)$$

where p_x and p_x^0 are the partial pressure and vapor pressure respectively of component x ; n_x and n_s are the number of moles of components x and s respectively. Thus, if we know the mole fraction of each hydrocarbon constituent in a fuel we can determine its limits of flammability in a closed container at any temperature, assuming that the limits of flammability and vapor pressure of each constituent at that temperature are known by means of LeChatelier's Law, which has been shown to hold quite well for many hydrocarbons. (Ref. 8) For example, the lower limit would be:

$$L_{t,p} = \frac{100}{\sum_n \frac{P_n}{L_{n,t,p}}} \% \quad (4)$$

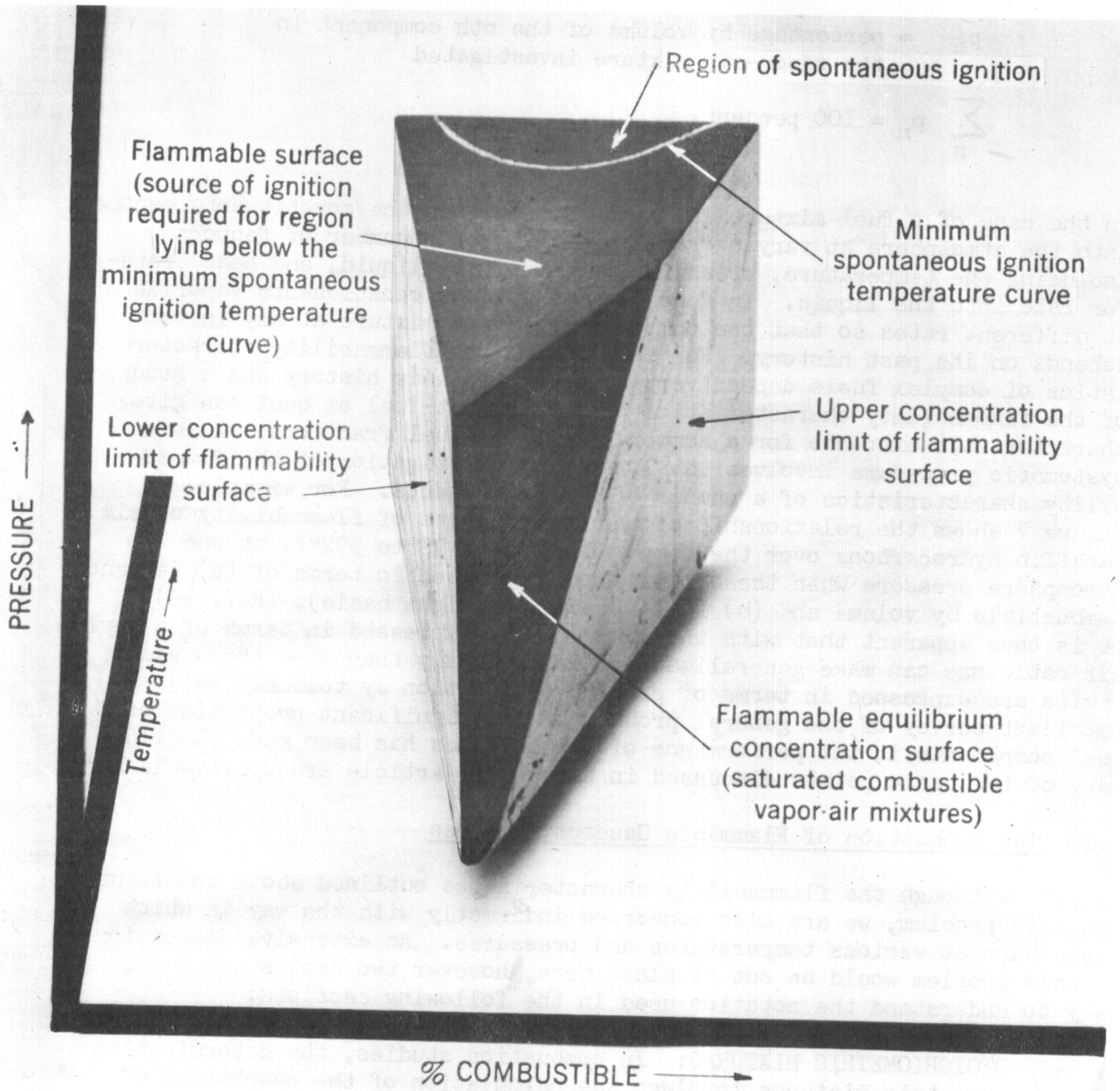

Figure 6. A general flammable volume of a combustible vapor air mixture.

where

$L_{t,p}$ = lower limit of the mixture at the specified temperature and pressure,

$L_{nt,p}$ = lower limit of the nth component at the specified temperature and pressure,

p_n = percentage by volume of the nth component in the vapor-air mixture investigated

$$\sum_n p_n = 100 \text{ percent.}$$

In the case of a fuel mixture in an open container, the constituents escape into the atmosphere at varying rates depending on a number of factors including the temperature, pressure, motion of the liquid, and heat transfer rate into the liquid. In general, the various constituents vaporize at different rates so that the composition of the mixture at any instant depends on its past history. For this reason the flammability characteristics of complex fuels depend very markedly on their history and a study of the flammability characteristics of an aircraft fuel at best can give characteristic extremes for a number of various fuel fractions. A more systematic procedure involves the long-term investigation of the flammability characteristics of a number of fuel components. For example, Figure 7 shows the relationship of the lower limits of flammability of six paraffin hydrocarbons over the temperature range 78 to 392°F. at one atmosphere pressure when these limits are expressed in terms of (a) percent combustible by volume and (b) fuel-air ratio (weight basis). (Ref. 38) It is thus apparent that with the lower limits expressed in terms of a fuel-air ratio one can make generalizations more readily than when these same limits are expressed in terms of percent composition by volume. An excellent survey of the general problem of the significant properties of fuel components in the performance of gas turbines has been made (Ref.16); many of the basic points discussed in the survey article are applicable here.

2.11 The Combustion of Flammable Gaseous Mixtures

2.11.1 Although the flammability characteristics outlined above constitute the main problem, we are also concerned indirectly with the way in which fuels burn at various temperatures and pressures. An extensive discussion of this problem would be out of place here, however two topics are necessary to understand the notation used in the following sections.

2.11.2 **STOICHIOMETRIC MIXTURES:** In combustion studies, the determination of stoichiometric mixtures involves the calculation of the quantities of combustible and oxygen necessary for complete combustion. In case air is the oxygen supplier, the amount of air necessary in any reaction is obtained

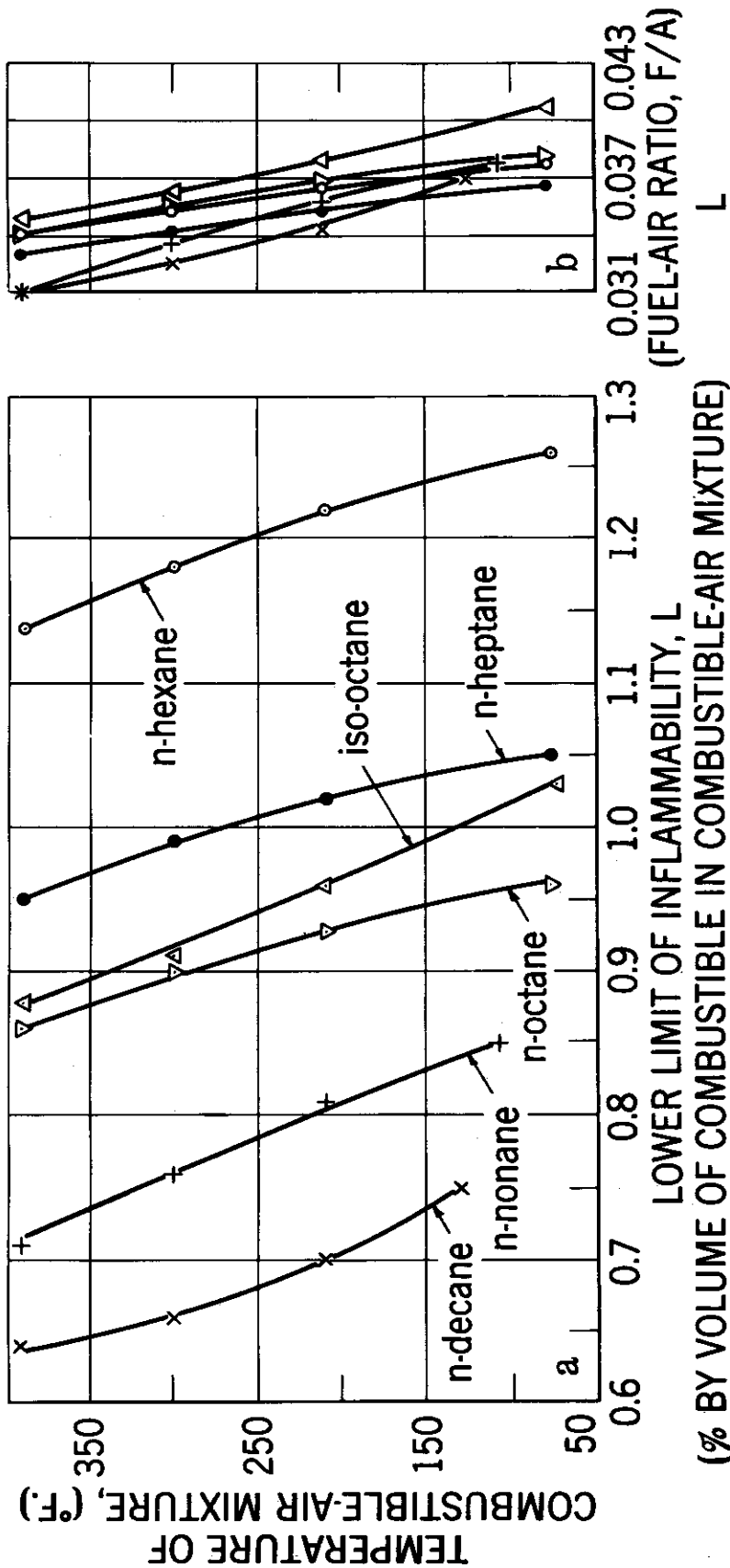
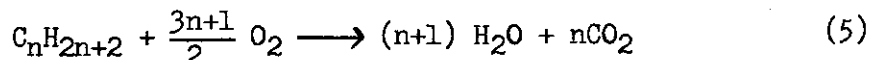

Figure 7. - Comparison of the variations in the concentration limits of flammability of six hydrocarbons with temperature for one atmosphere pressure using (a) units of volume (b) units of weight to express the lower limit concentrations.

Contrails

by considering the other gases* in the air to be inert with respect to the main reaction. Thus, the theoretical percentage of one of the paraffin hydrocarbons required for complete combustion (T.C.C.), that is, the stoichiometric composition, is determined by first writing the general equation for complete combustion of any paraffin hydrocarbon. This is:



$$\therefore \text{T.C.C.} = \frac{100\%}{1 + \left(\frac{3n+1}{2}\right)\left(\frac{1}{0.2093}\right)} = \frac{100}{7.166n+3.389} \% \quad (6)$$

2.11.3 UNITS: The most common units used for T.C.C. (and also for the limits of flammability) are (1) percentage combustible by volume in a flammable gaseous mixture, as above; (2) weight of combustible per unit volume of air; (3) weight ratio of combustible to air. There are certain advantages in the use of each of these units; for example, let us determine T.C.C. in units of (2) and (3) and compare:

$$\begin{aligned} \text{T.C.C.} &= \frac{[n(12.01 - 2.016) + 2.016] 1000 \text{ mg.}}{\left(\frac{1}{0.2093}\right)\left(\frac{3n+1}{2}\right) 22.41 \text{ l}} \quad (7) \\ &= \left(87.33 - \frac{49.67}{3n+1}\right) \frac{\text{mg.}}{\text{l}} \end{aligned}$$

$$\begin{aligned} \text{T.C.C. (F/A)} &= \frac{n(12.01 + 2.016) + 2.016}{\left(\frac{1}{0.2093}\right)\left(\frac{3n+1}{2}\right) 28.97} \quad (8) \\ &= 0.06756 - \frac{0.03843}{3n+1} \\ &= 0.0007736 \left[87.33 - \frac{49.67}{3n+1}\right] \end{aligned}$$

* In this report, air is taken to be composed of 20.93 percent oxygen, 78.08 percent nitrogen, 0.05 percent carbon dioxide, 0.0094 percent argon and the remainder of traces of a number of other elements. This composition gives the air an average molecular weight of 28.97.

Contrails

Therefore, for the paraffin hydrocarbons we have,

$$\begin{aligned} \text{T.C.C. (F/A)} &= 0.0007736 \text{ T.C.C. } \left(\frac{\text{mg.}}{\text{l}}\right) & (9) \\ &= 0.0007736 \frac{\text{T.C.C. } \%}{100\% - \text{T.C.C. } \%} \times \frac{(14.026n+2.016)}{28.97} \% \end{aligned}$$

One further point to note here is the ratio of combustible to oxygen atoms for a stoichiometric mixture as well as for limit mixtures. From the general equation for the paraffin hydrocarbons we have:

$$\text{T.C.C.} = \frac{\text{No. of combustible atoms}}{\text{No. of oxygen atoms}} = \frac{n+2n+2}{3n+1} = 1 + \frac{1}{3n+1} \quad (10)$$

For many combustibles the lower limit is approximately $1/2$ T.C.C. and the upper limit 3 T.C.C., which gives:

$$L \doteq 0.5 \left(1 + \frac{1}{3n+1}\right) \quad (11)$$

and

$$U \doteq 3 \left(1 + \frac{1}{3n+1}\right) \quad (12)$$

Although only approximate, these figures are accurate enough to be used in setting up an apparatus for determining limits of flammability (Appendix IV).

2.12 Mists and Sprays

2.12.1 A considerable amount of work has been done on the technical problems associated with combustible mists and sprays; (see bibliography); however, very few investigators have concerned themselves with the fundamental problems involved in the burning of sprays and mists.

2.12.2 The problem can be divided into four parts: (1) formation of combustible liquid droplet, (2) transfer of heat to these droplets, (3) mass transfer and mixing of vapor and air, (4) ignition of the resulting vapor-air mixture. Only (1) and (2) are characteristic of mists and sprays alone. Just as for gases, the ignition source may play a very important role in (3) as well as in (4).

2.12.3 Formation of mists ordinarily involves vapor condensation. Formation of a combustible liquid spray in air involves the shearing action between a liquid in motion with respect to the surrounding air, that is, the liquid can be projected into air; air can be blown over a stationary column or sheet of liquid; the liquid and air can be projected into each other.

Contrails

2.12.4 Measurement of the particle size is a fundamental problem in the study of particles in a fluid. This is certainly true when considering combustible mists and sprays. However, before undertaking an actual measurement, one must decide what type of size measurement is most significant for the particular application involved. If the volume of the particle is of prime importance, this should be taken into consideration in the size measurement; likewise for the surface area, cross-sectional area, etc. For example, in the case of N spherical particles, one possibility would be:

$$r_{ave} = \frac{x \sqrt{\sum_{n=1}^N r_n^x}}{N} \quad (13)$$

or perhaps the effective radius would be more representative of a ratio such as the total volume to the total surface area so that, in general,

$$r_{ave} = K \frac{\sqrt[w]{\sum_{n=1}^N r_n^x}}{\sqrt[z]{\sum_{n=1}^N r_n^y}} \quad (14)$$

where $\frac{x}{w} - \frac{y}{z} = 1$. When studying the flammability characteristics of mists and sprays, the surface area is very important, accordingly equation (13) with $x = 2$ is of considerable importance.

2.12.5 As usual, the problem of sampling must be considered very carefully. All impinger-type collection apparatus suffer on two counts in the case of liquid droplet sampling. First, the collection efficiency of any impinger is a function of droplet size and velocity, and second the droplet size is a complex function of time and depends on a number of variables such as initial droplet size, temperature and pressure. This indicates that an optical or electrical apparatus which does not disturb the individual droplets appreciably would be preferable for measuring droplet sizes to the conventional coated slide and microscope arrangement.

EXPERIMENTAL RESULTS

3.1 The results obtained from 19 February 1950 to 19 February 1952 are summarized in this section under the headings: Limits of flammability; spark ignition energy measurements; ignition temperatures; and sprays and mists. The apparatus used for these investigations are described in the Appendix.

3.2 Limits of Flammability

3.2.1 CONCENTRATION LIMITS OF FLAMMABILITY (constant temperature): Aviation gasoline grades 100/130 and 115/145 and aviation jet fuel grade JP-3 have a high enough vapor pressure at 78°F. to make saturated vapor-air mixtures of these combustibles nonflammable because they contain an excess of combustible vapor. However, the flammable areas of unsaturated vapor-air mixtures of each of the above combustibles have been determined at 78°F. (Figures 8, 9 and 10). The F-1 limit-of-flammability apparatus was used for these investigations (Figure 24, Appendix I).

3.2.2 The limit-of-flammability curves in Figures 8a, 9a, and 10a are self-explanatory; the solid lines represent the limits of flammability for atmospheric and reduced pressures of the vapors from a fresh sample of the fuel tested. Consistent results were obtained provided less than 20 percent of the fresh liquid sample was used. This means that the percentages of heavy vapors in the vapor-air mixtures tested were small. However as the exact composition of the vapor-air mixtures tested is unknown, an average molecular weight was obtained for the gasoline samples from their distillation curves (Figures 1a, 1b), assuming them to be composed of straight chain paraffin hydrocarbons. This gave an average molecular weight of approximately 100, corresponding to that of heptane. The average molecular weight of aviation jet fuel grade JP-3 by the above method was 128; however because of the wide boiling range of this fuel (Figure 1d), this average molecular weight was not used to obtain the F/A values in Figure 10b. Instead, the average molecular weight used was the same as for gasolines, the boiling range for the first 20% of distillate for JP-3 fuel being almost the same as the boiling range for the gasolines (Figure 1). The F/A values used to plot Figures 8b, 9b, and 10b were calculated from equation (9), assuming an average molecular weight of 100 in each case. Since only the first 20% of the fresh liquid sample that distilled over into the explosion chamber was used in each case, an average weight of 100 is probably high, suggesting that the F/A values in Figures 8b, 9b and 10b also are high. It is interesting to compare these derived data with the experimental data obtained with the F-11 apparatus (Table 2) at 300°F. and one atmosphere pressure (Table 1). The data check as well as can be expected considering that the assumed molecular weight used in obtaining the derived data was probably high, and also that the data correspond to two different temperatures. However, Figures 8a, 9a and 10a, which represent the actual experimental data, should be used where possible in preference to Figures 8b, 9b and 10b plotted from the derived data.

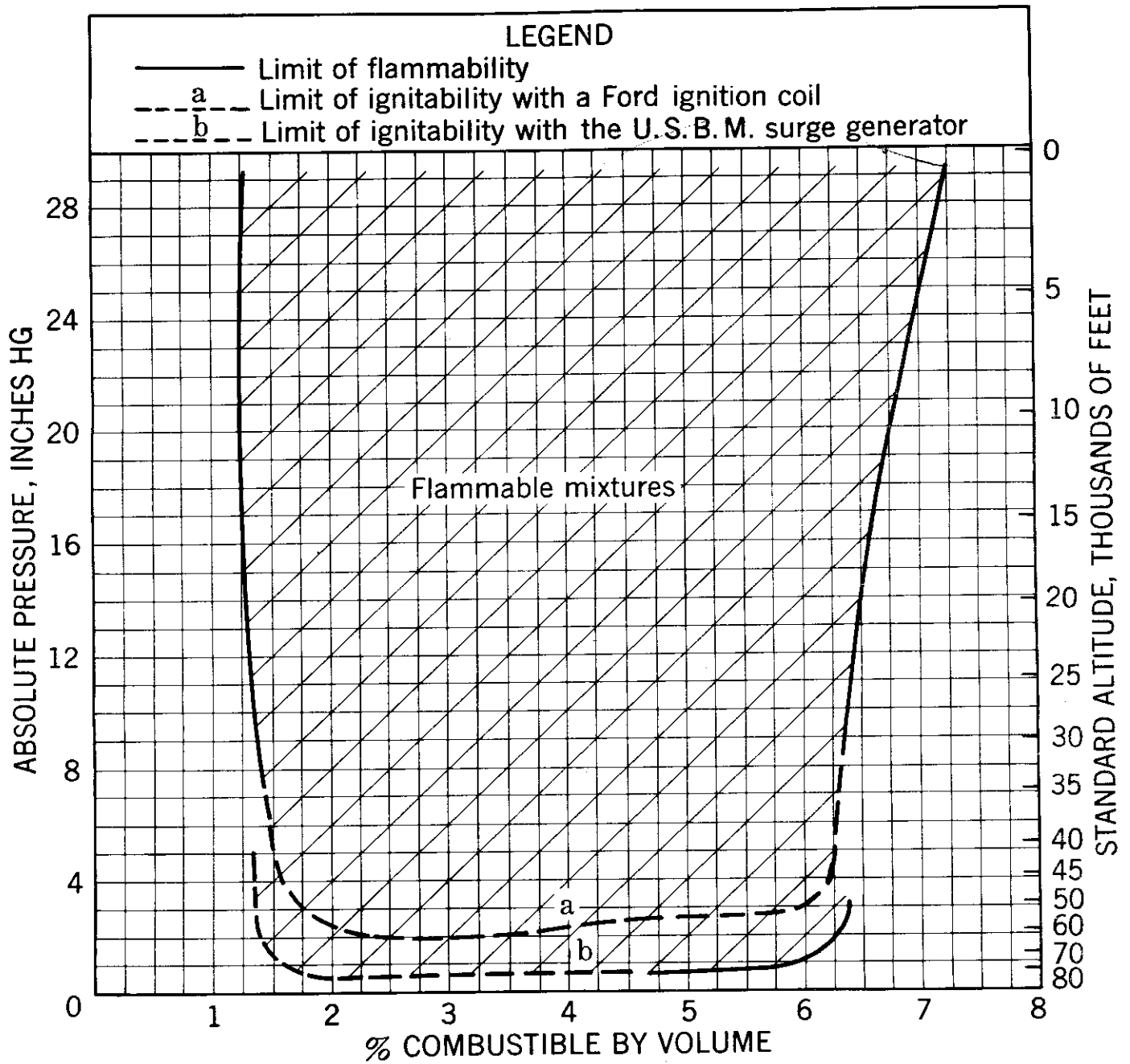

Figure 8a. - Concentration limits of flammability for aviation gasoline grade 100/130 vapor-air mixtures at $78 \pm 1^\circ \text{F}$.

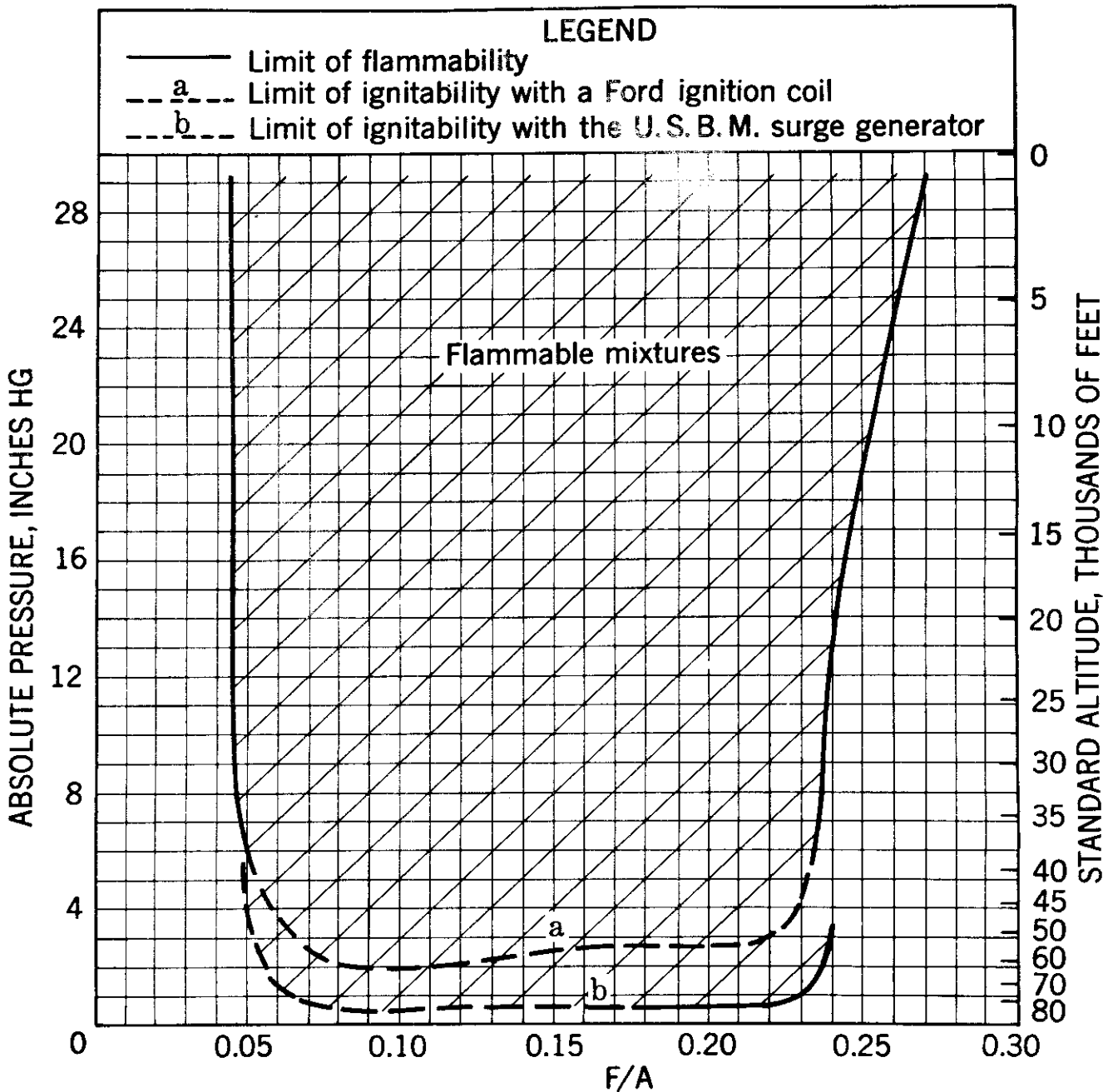

Figure 8b. - Concentration limits of flammability for aviation gasoline grade 100/130 vapor-air mixtures at $78 \pm 1^\circ \text{F}$. (curve obtained from figure 8a taking average molecular weight of this fuel to be 100).

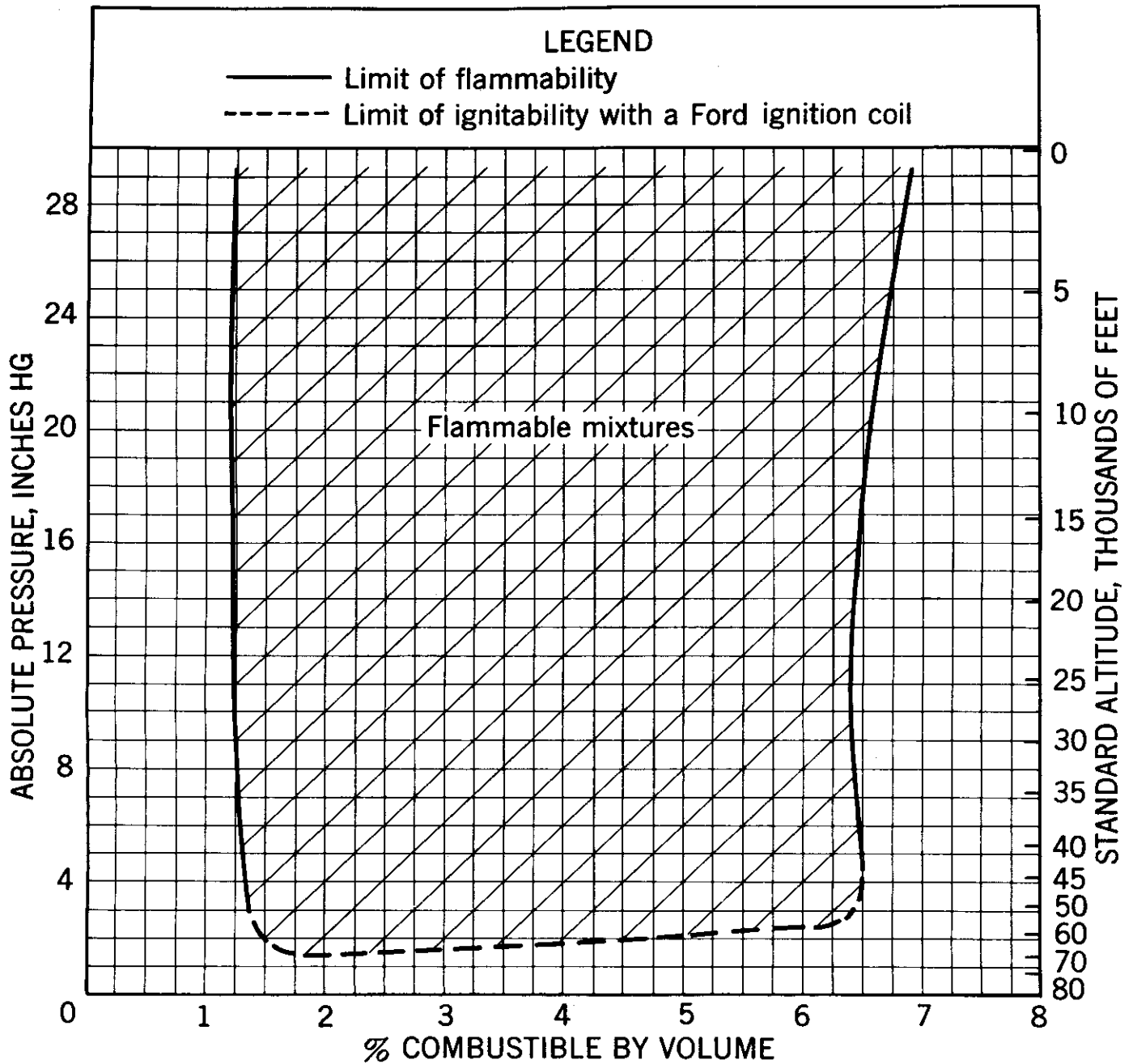

Figure 9a. - Concentration limits of flammability for aviation gasoline grade 115/145 vapor-air mixtures at 78 ± 2° F.

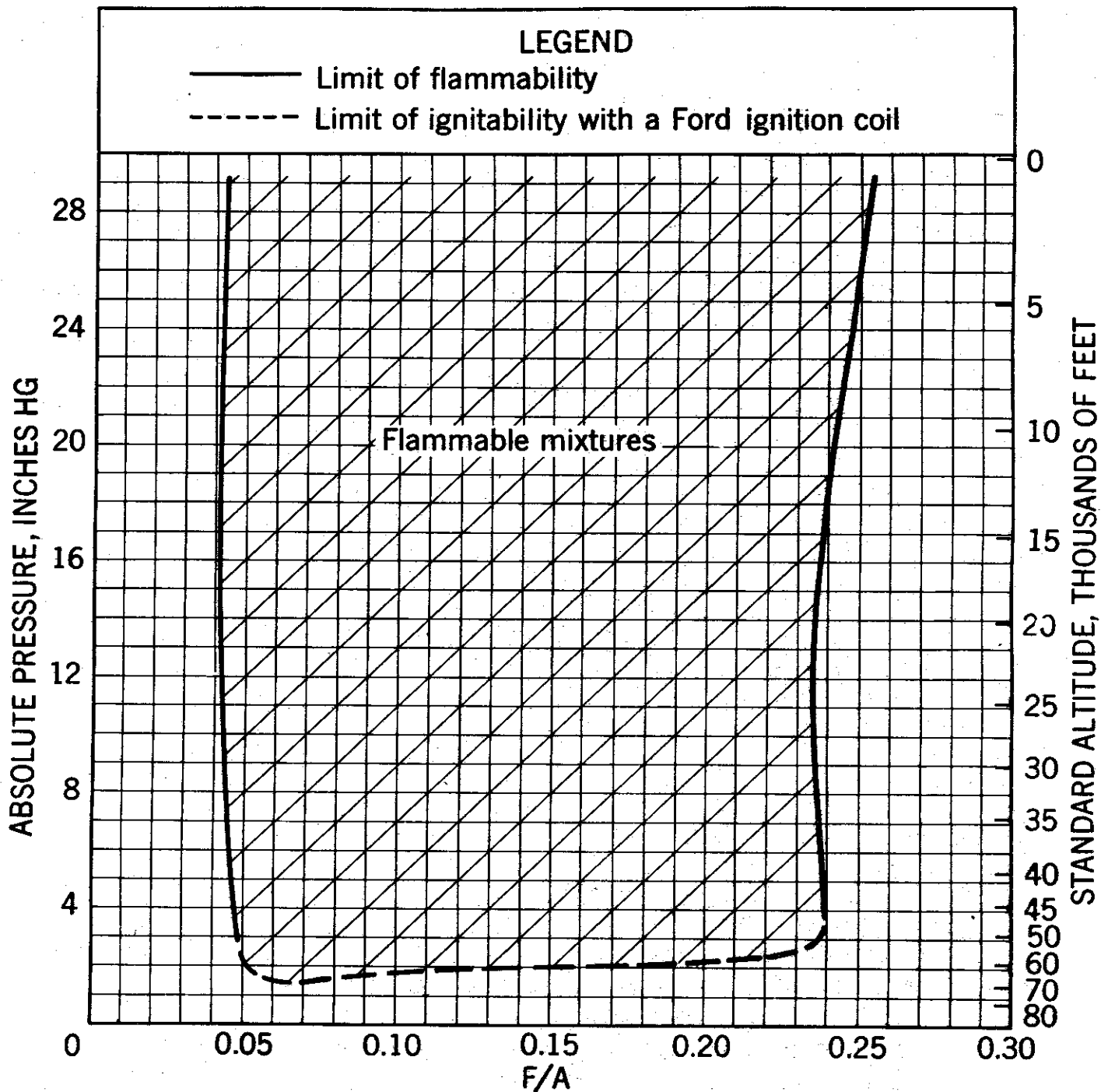

Figure 9b. - Concentration limits of flammability for aviation gasoline grade 115/145 vapor-air mixtures at 78 ± 2°F. (curve obtained from figure 9a taking average molecular weight of this fuel to be 100).

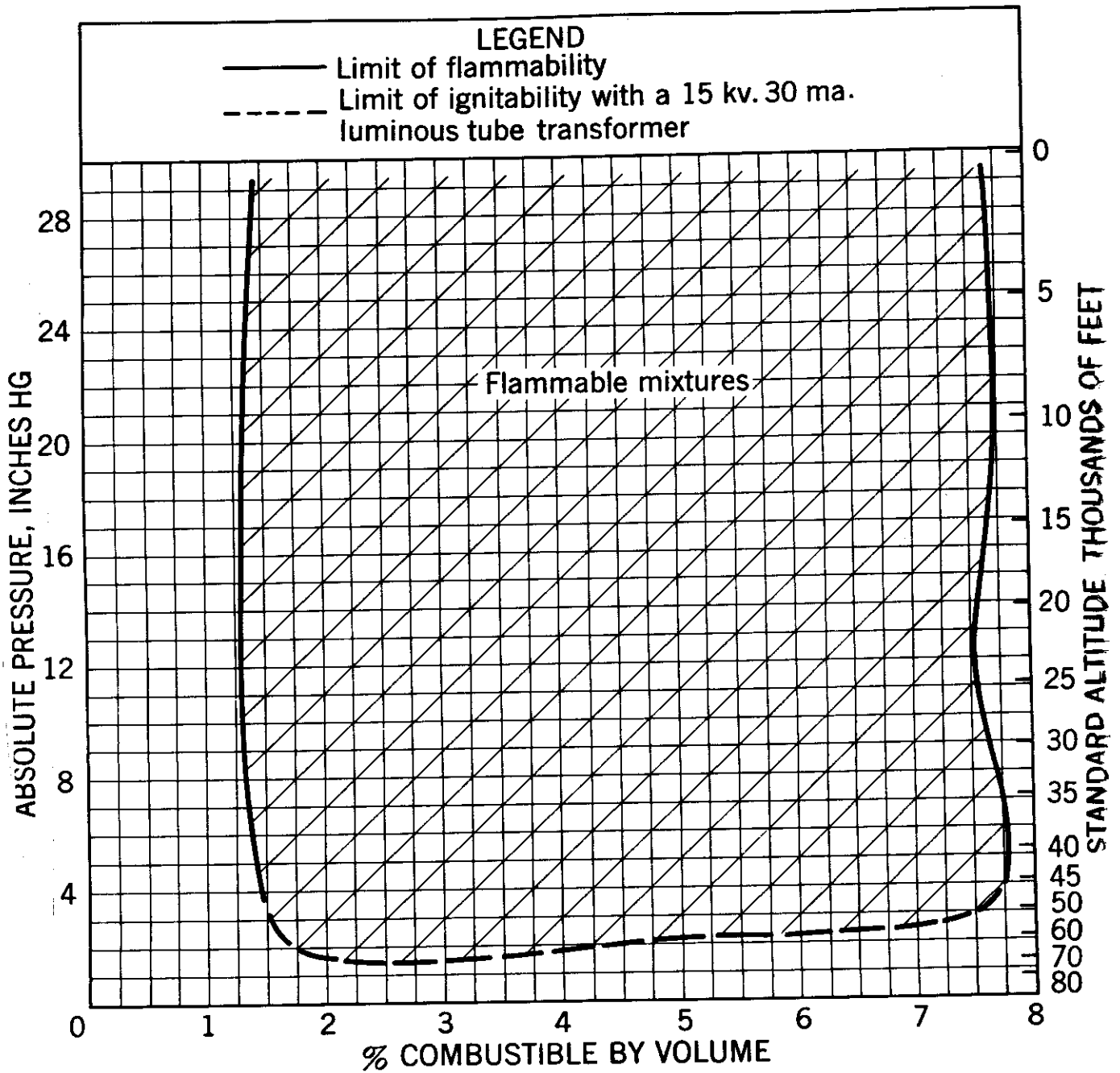

Figure 10a. - Concentration limits of flammability-jet fuel grade JP-3 vapor-air mixtures at $79 \pm 2^\circ\text{F}$.

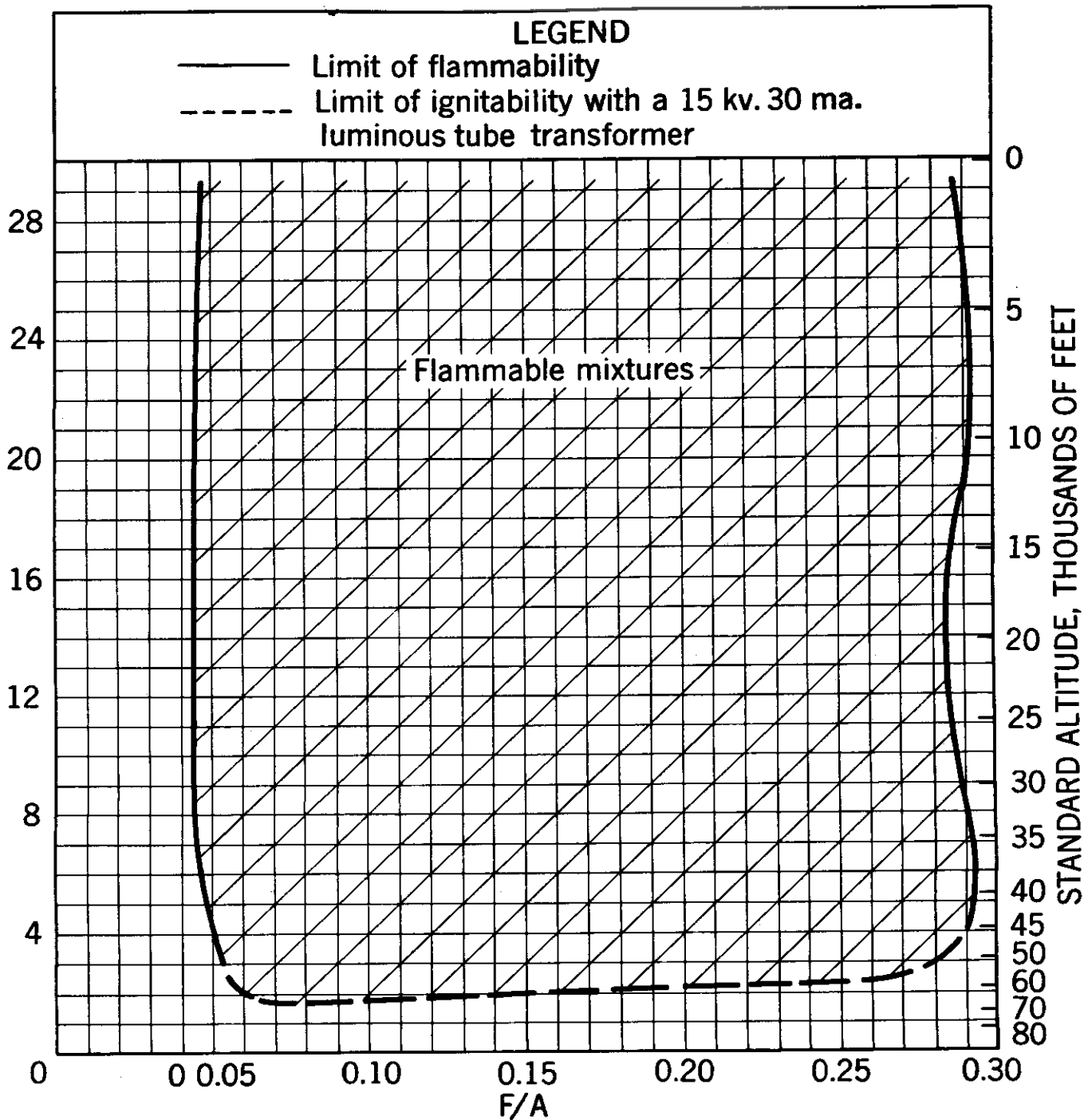

Figure 10b. - Concentration limits of flammability for aviation jet fuel grade JP-3 vapor-air mixtures at $79 \pm 2^\circ\text{F}$. (curve obtained from figure 10a taking average molecular weight of this fuel to be 100).

Contrails

Table 1.--Comparison of limit of flammability data obtained with two sets of apparatus at atmospheric pressure.

Combustible	F-1 Apparatus (78°F.) (Derived data)		F-11 Apparatus (300°F.) (Experimental F/A data)	
	Lower F/A	Upper F/A	Lower F/A	Upper F/A
Aviation gasoline grade 100/130	0.043	0.271	0.041	0.27
Aviation gasoline grade 115/145	.043	.255	.037	.26
Aviation jet fuel grade JP-3	.047	.287	.037	.30

3.2.3 One further point to bear in mind in conjunction with Figures 8, 9 and 10 is that these figures are for data obtained at 77° - 81°F., and should be used only for these temperatures. A limited number of tests were performed on aviation gasoline grade 100/130 vapor-air mixtures at 0°F. to obtain graphs at 0°F. similar to those in Figures 8, 9 and 10. However, the data obtained to date indicate that with fuel container and test chamber both at 0°F. the limits of flammability correspond to values obtained for varying butane, pentane, and hexane mixtures. The smaller the fraction of fuel mixture vaporized into the test apparatus from the fuel container, the higher are the lower and upper limits of flammability. The results obtained to date are so erratic at this low temperature that no flammability curves are available. The past history of the sample tested also plays a very important part in the actual limit-of-flammability values obtained at low temperatures. Accordingly, in order to obtain useful limit-of-flammability data for vapor-air mixtures that are not saturated with the combustible vapors at low temperatures, an initial series of tests should be conducted on butane-pentane-hexane control mixtures at low temperatures. If, as appears to be the case at present, the controlling hydrocarbons in the determination of the limits of flammability at temperatures below 0°F. are the most volatile ones present in the mixture under the conditions of temperature and pressure at which the test is conducted, then to improve a fuel mixture from the standpoint of safety at low temperatures and pressures, the volatile components should be removed. This means, of course, that as soon as a certain amount of butane, for instance, is exhausted from the mixture, then the pentane and hexane become the controlling hydrocarbons. Once a few control mixtures are investigated thoroughly, the problem of the flammability of complex hydrocarbon mixtures at low temperatures can be resolved more readily.

3.2.4 CONCENTRATION LIMITS OF FLAMMABILITY (constant pressure): The concentration limits of flammability were determined for aviation gasoline grades 100/130 and 115/145, and for aviation jet fuel grades JP-1 and JP-3 at 300°F. with the F-11 apparatus (Appendix V). This apparatus is designed to determine the limits of flammability of a combustible as a function of temperature at atmospheric pressure. The data obtained for the four combustibles mentioned are summarized in Table 2. The lower limit data in this

table may be compared with the data in Figure 7b, and with the calculated data obtained in paragraph 3.2.2 (Table 1). The lower limits of aviation gasoline grade 115/145 and of aviation jet fuel grades JP-1 and JP-3 are in good agreement with the curves of Figure 7b. The lower limit of aviation gasoline grade 100/130 is rather high, however it corresponds rather closely to lower limit data for aromatic hydrocarbons (Ref. 39). As before, comparison with pure combustibles is rather difficult in the absence of more precise information on the composition of the vapors given off.

Table 2.--The limits of flammability in air of four aircraft fuels at 300°F. and one atmosphere pressure.

Combustible	Limits of flammability			
	Lower*		Upper*	
	mg./l	F/A	mg./l	F/A
Aviation gasoline grade 100/130	53	0.041	348	0.27
Aviation gasoline grade 115/145	48	.037	337	.26
Aviation jet fuel grade JP-1	48	.037	405	.31
Aviation jet fuel grade JP-3	48	.037	387	.30

* The density of the air used for these data is that for conditions of S.T.P. (0°C. and 760 mm. Hg). The fuel density is that corresponding to 78°F.

3.2.5 EQUILIBRIUM CONCENTRATION LIMITS OF FLAMMABILITY (saturated combustible vapor-air mixtures): The equilibrium concentration limits of flammability have been determined for aviation gasoline grade 100/130 and 115/145 and for aviation jet fuel grades JP-1 and JP-3. These limits are defined in paragraph 2.6. The data obtained during the current investigation are included in Figures 11 to 14 with the equilibrium liquid-vapor-air temperature plotted as abscissa against the absolute pressure as ordinate. Since each of the above combustibles is a mixture of a large number of hydrocarbons, the flammable area obtained in each case depends on the history of the sample tested. This is illustrated in Figures 13 and 14 by drawing a flammable area for the vapors given off by a fresh sample and again for the vapors given by a sample from which a certain percentage of the liquid has evaporated. These data should simulate the extreme conditions which can exist in the "air" space above the fuel in a fuel tank. When the tank is first filled, this "air" space becomes saturated with a number of the volatile constituents present in the fuel. On an actual flight, the tank "breathes" expelling more and more of the highly volatile constituents as the altitude increases. When the altitude decreases, some more of the liquid fuel vaporizes into the vapor-air space existing in the tank. The composition of the vapor above the fuel at any instant thus depends on the past history of the fuel as well as on the temperature and pressure. For this reason, when determining the flammability characteristics of a fuel mixture, it is important to know not only what percentage of the fuel

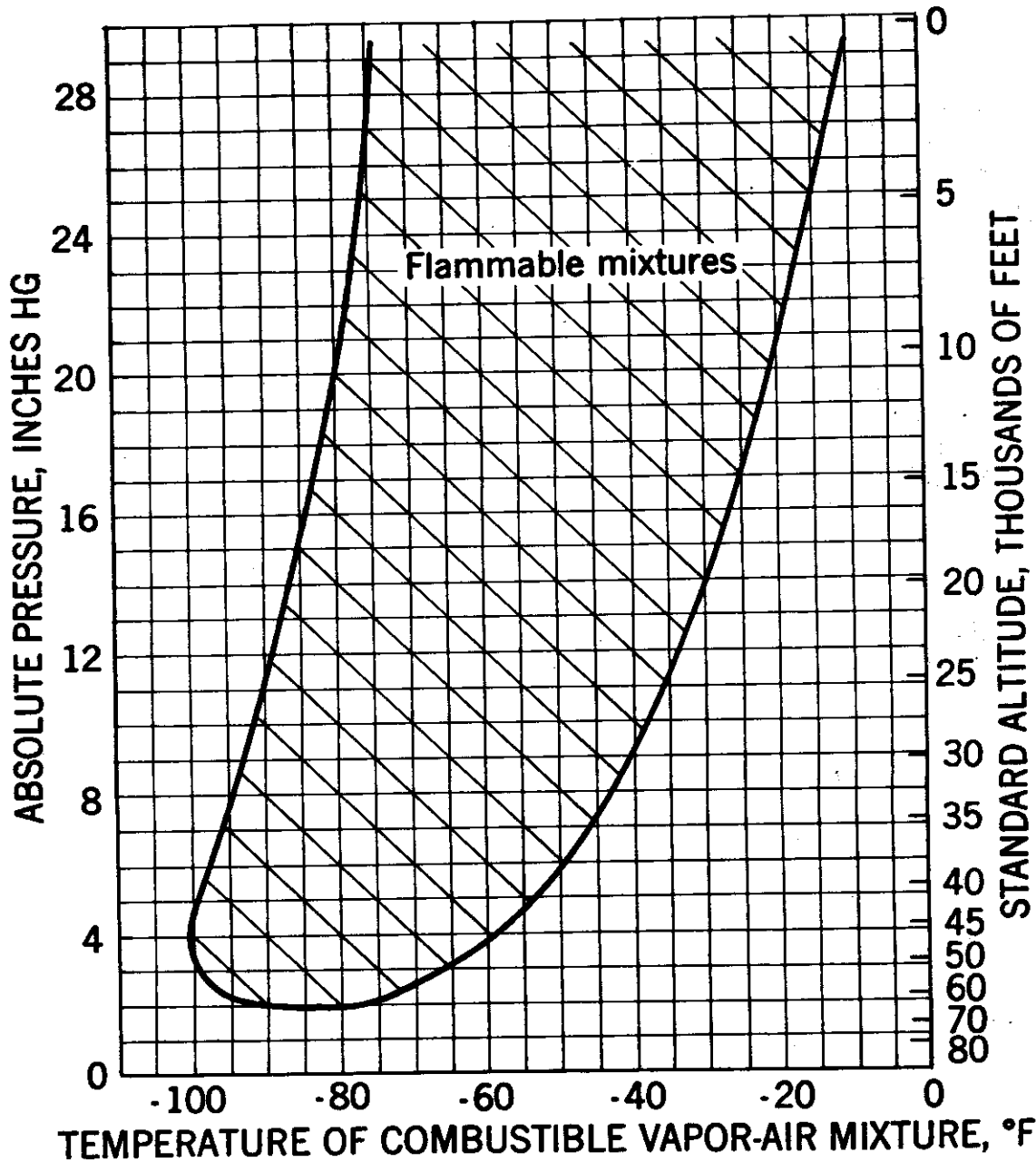

Figure 11 - Equilibrium concentration limits of flammability of the 0 to 5% fraction of aviation gasoline grade 100/130 vapor-air mixtures over the temperature range -100 to 0° F. (the 0 to 5% fraction of this fuel was distilled under the temperature and pressure conditions of each test).

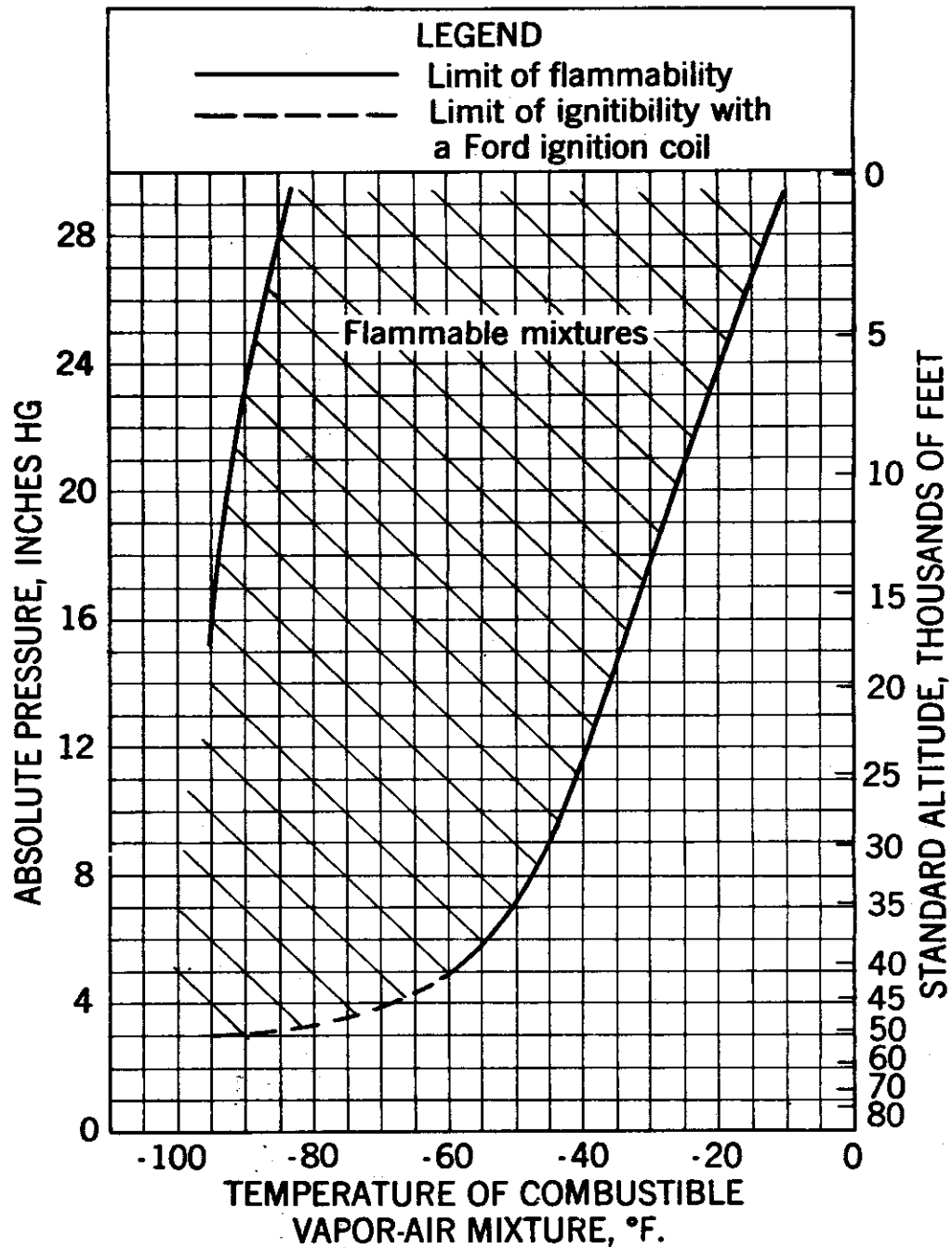

Figure 12 - Equilibrium concentration limits of flammability of the 0 to 10% fraction of aviation gasoline grade 115/145 vapor-air mixtures over the temperature range -100 to 0° F. (the 0 to 10% fraction of this fuel was distilled under the temperature and pressure conditions of each test)

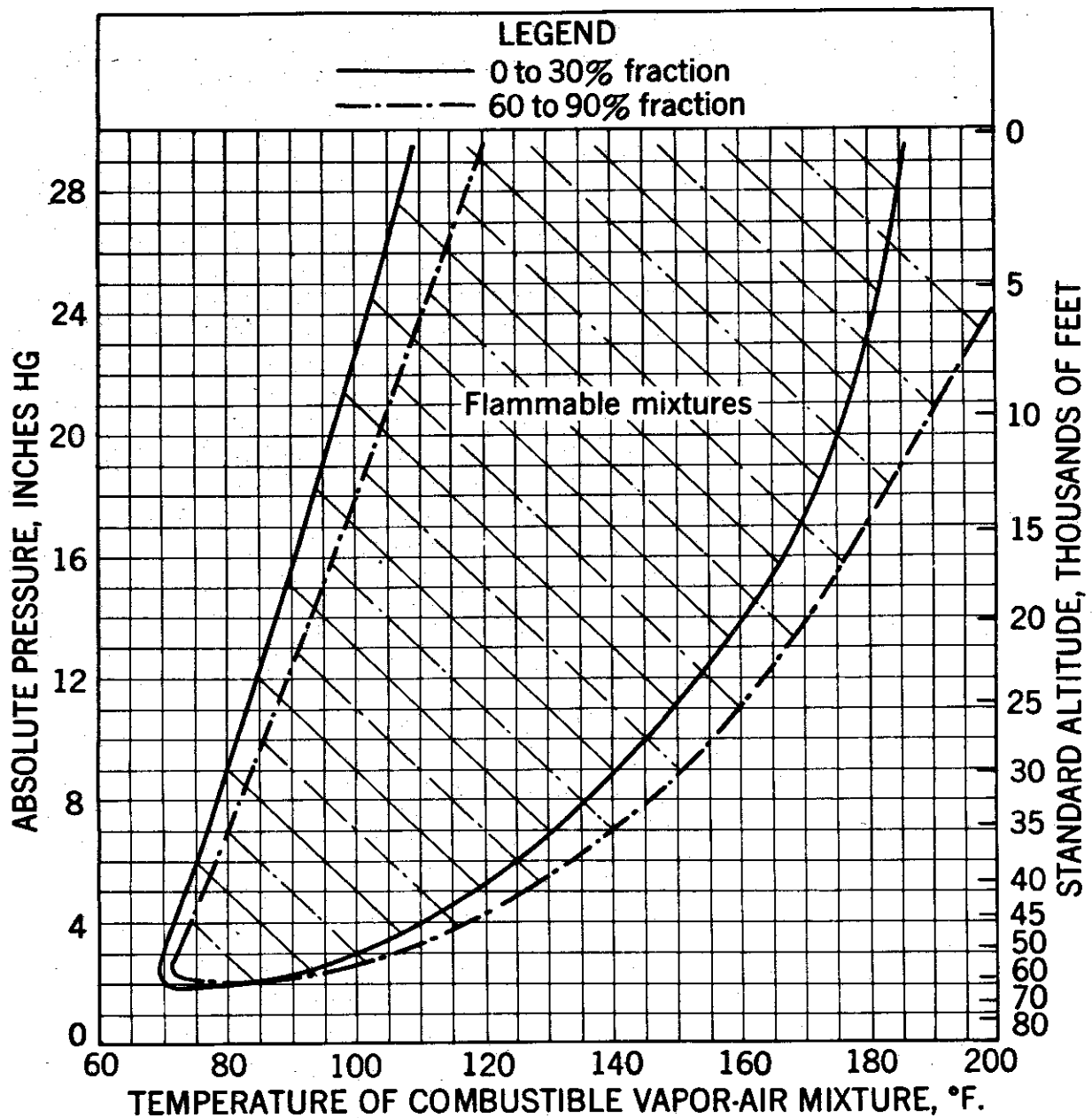

Figure 13 - Equilibrium concentration limits of flammability of the 0 to 30% and 60 to 90% fractions of aviation jet fuel grade JP-1 vapor-air mixtures over the temperature range 60 to 200° F. (the 0 to 30 and 60 to 90% fractions of this fuel were distilled under the temperature and pressure conditions of each test).

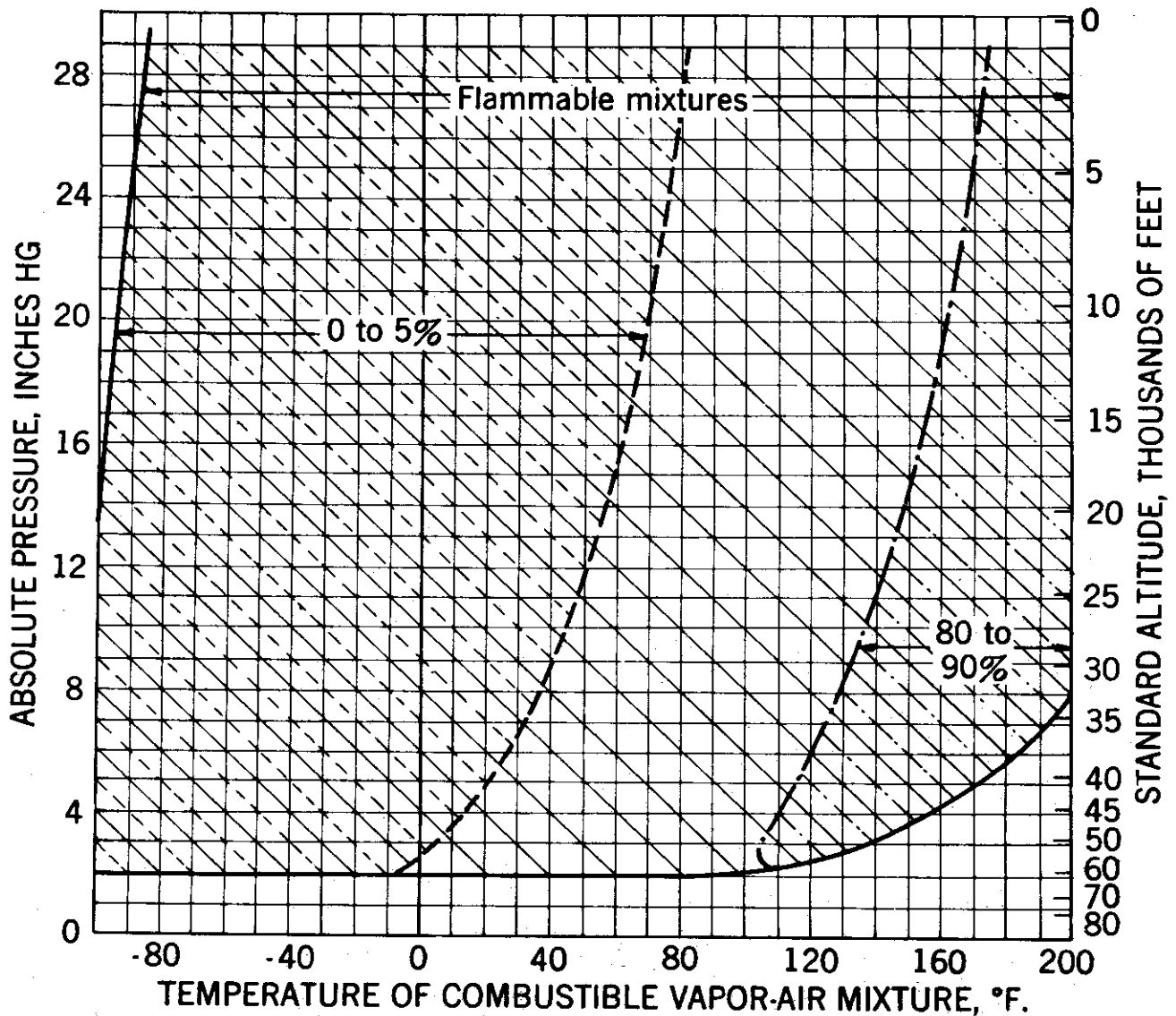

Figure 14 - Equilibrium concentration limits of flammability of the 0 to 5% and 80 to 90% fractions of aviation jet fuel grade JP-3 vapor-air mixtures over the temperature range -100 to +200° F. (the 0 to 5% and 80 to 90% fractions of this fuel were distilled under the temperature and pressure conditions of each test).

vaporizes into the test chamber but also the percentage of the original fuel which vaporized prior to initiating the flammability tests. For example, in Figure 14 the flammable area between -100° and 80°F . was obtained by using the aviation jet fuel grade JP-3 vapors obtained by vaporizing into the explosion chamber from 0 to 5% of a fresh sample at a temperature slightly above the explosion chamber temperature. The area between 100° and 200°F . was obtained by using the JP-3 vapors obtained by vaporizing into the explosion chamber the 80 to 90% portion of the original sample placed in the saturator.

3.2.6 Figures 11-14 can be redrawn to give F/A as the abscissa with the aid of the fuel vapor-pressure data obtained from Figure 2. However, the Reid vapor pressure data of Figure 2 apparently are not completely accurate, the F/A values obtained being inconsistent with all the other data reported here. Accordingly, these F/A plots have not been made. It should be noted that Figures 11-14 are traces of the equilibrium limit curves (the curves formed by the intersection of the flammable equilibrium concentration surface with the lower and upper concentration limit of flammability surfaces) on the temperature-pressure plane of Figure 6, whereas the proposed plots would be traces of the equilibrium limits curves on the concentration-pressure plane. Furthermore, these proposed plots differ from Figures 8-10 in that these latter figures represent flammable areas at constant temperature so that curves on the concentration-pressure plane would of course yield the identical shape of flammable area as the original; this is not true in the case of the proposed plots.

3.3 Spark Ignition Energy Measurements.

3.3.1 Successful ignition of a flammable mixture by any ignition source depends on the effective energy delivered to the system formed by the gaseous mixture and its surroundings. Whether or not a flammable mixture ignites depends on the useful energy from the ignition source delivered to the flammable mixture being investigated, and also on the temporal manner in which this energy is delivered to the mixture. In the course of experiments performed to date, various ignition sources have been used (Appendix X). However, energy and power measurements were made on only one source, the USBM surge generator, whose general efficiency as an ignition source at low pressures is superior to that of any other ignition source used to date. In accordance with phases 1 and 2 of the program outlined for this project (paragraph 1.2.2), the limits of ignitibility of aviation gasoline grade 100/130 vapor-air mixtures are being investigated at low pressures using the USBM surge generator as the ignition source. In accordance with the experimental criterion to be used in determining the limits of flammability of a combustible-air mixture at a specified temperature and pressure (cf. paragraph 2.4.4), most experiments conducted at room temperature and low pressures yield limits of ignitibility which have been represented by broken lines in Figures 8-10; this is not the case at reduced temperatures (Figures 11-14). Apparently at low temperatures the low pressure limit of

Contrails

flammability rises enough to permit determination of the low pressure limit with several types of ignition source. As aircraft fuels are not ordinarily used at low pressures and elevated temperatures, the problem of ignition may not be too difficult from a practical point of view. However, the data obtained to date indicate that ignition at low pressures is achieved more readily with larger spark gaps than those used at atmospheric pressure.

3.3.2 To date, the lowest pressure at which an aviation gasoline grade 100/130 vapor-air mixture has ignited and propagated flame is 0.63-inch Hg absolute at 78°F. This pressure corresponds to a standard altitude (but not to the corresponding temperature) of 86,000 feet. However, for stoichiometric mixtures, this was not a limit of flammability so that apparently once the limit of flammability is obtained this altitude will be raised.

3.3.3 Typical current and voltage oscillograms of the energy surge delivered to the spark gap in the explosion chamber are shown in Figure 15 and interpreted in Figure 16. Figures 16a and 16b are traces of the oscillograms given in Figures 15a and 15b. Figure 16c is a point by point multiplication of Figures 16a and 16b and represents the instantaneous power delivered to the spark gap as a function of time; the area under the curve in Figure 16c represents the energy delivered to the spark gap. The surge data obtained to date are plotted in Figures 17-19.

3.3.4 Figure 17 is a plot of the limits of ignitibility of aviation gasoline grade 115/145 vapor-air mixtures at low temperatures and pressures for three ignition sources superimposed on the equilibrium concentration limit of flammability curves for the 0 to 10% fraction of this fuel (Figure 12). A 0.25-inch spark gap was used in all cases. Curve (a) gives the limits of ignitibility for a Ford ignition coil curve (b) for a 120-millijoule, 550-microsecond spark from the USBM surge generator, and curve (c) for an 85-millijoule, 275-microsecond spark from the same USBM surge generator (Appendix X). This last spark appears to be the most efficient of those tested for low temperatures. The problem of spark efficiency is being investigated further with aviation gasoline grade 100/130 vapor-air mixtures (Figures 18 and 19).

3.3.5 Figure 18 is divided into three parts, each containing a family of curves for a stated aviation gasoline grade 100/130 vapor-air mixture. Each curve in the three families is a plot of the minimum ignition pressure (minimum pressure at which propagation of flame occurs throughout the mixture investigated) as a function of ignition spark duration. Two electrodes configurations were used for these curves. The first configuration (A) consisted of two 5/16-inch stainless steel rods mounted 1.75 inches apart in a glass base plate. From the ends of these rods #20 gage platinum electrodes were mounted to give a 0.25-inch spark gap. The second configuration (B) consisted of two kovar-glass bushings mounted 1.75 inches apart in a steel base plate. The platinum electrodes were mounted as above.

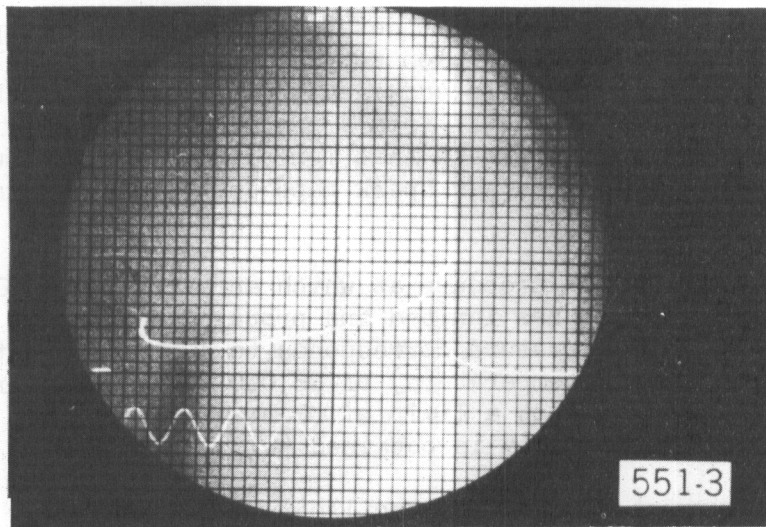

a

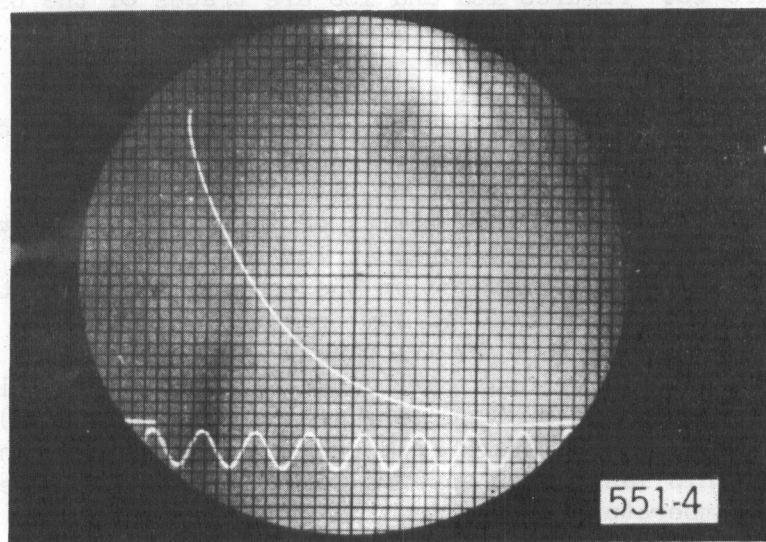

b

Figure 15. - Oscillograms of the (a) voltage across and (b) current through a spark discharge gap in an aviation gasoline grade 115/145 vapor-air mixture at -73° F. and 27 inches Hg absolute. (See figure 16 for the analysis of these oscillograms).

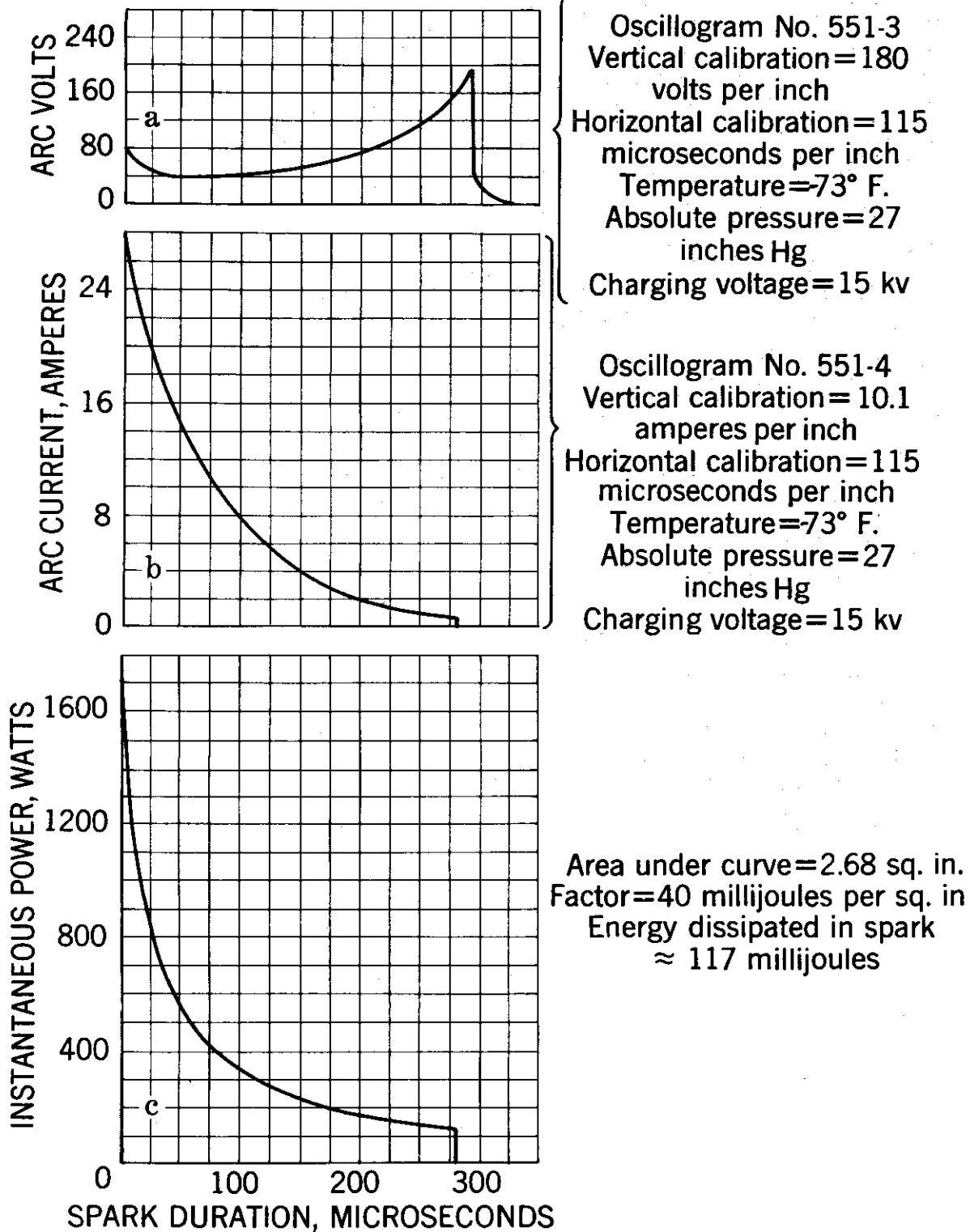

Figure 16. - Analysis of oscillograms 551-3 and 551-4 given in figures 15a and 15b.

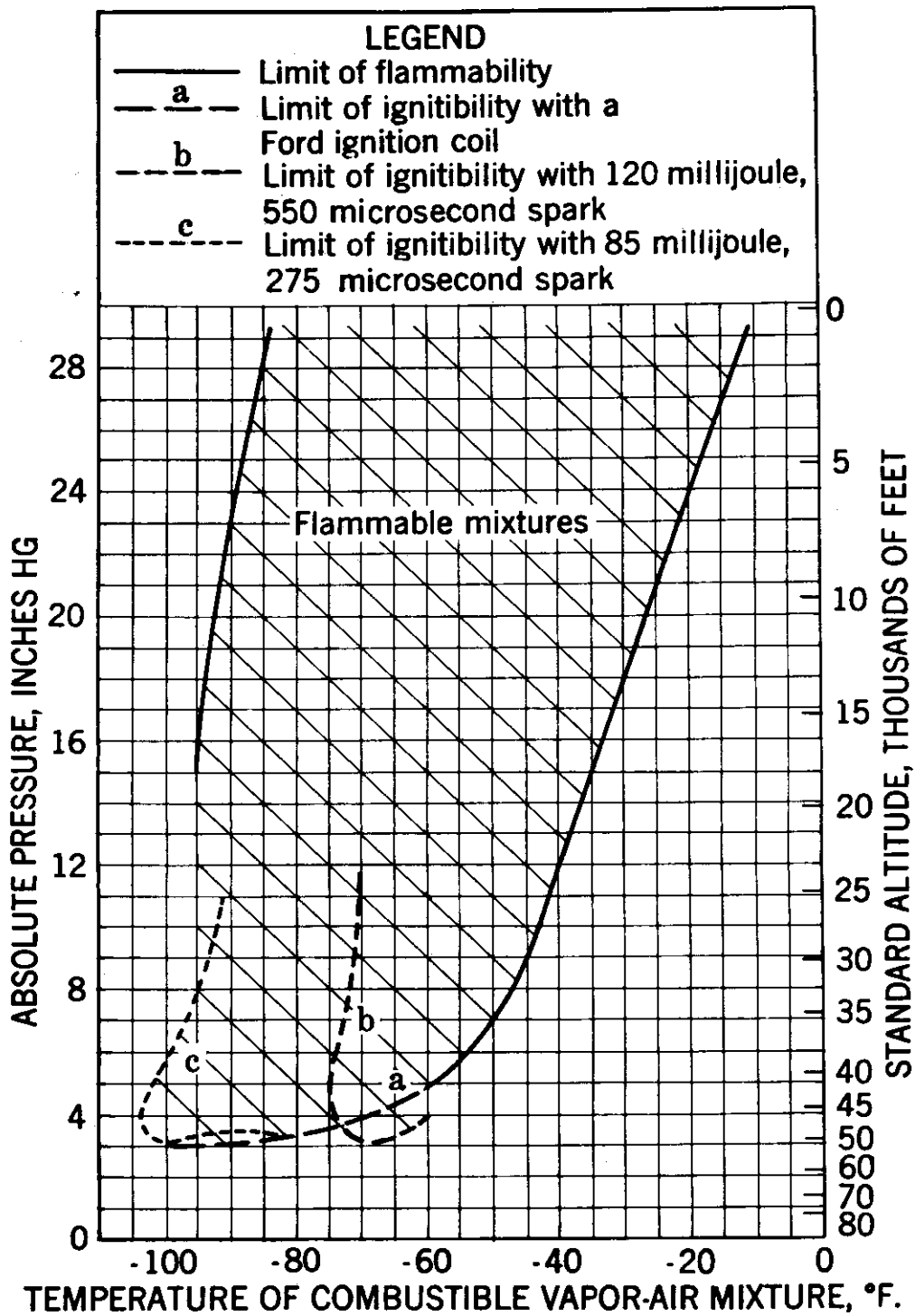

Figure 17. - Limits of ignitibility of aviation gasoline grade 115/145 vapor-air mixtures at low temperatures and pressures for three ignition sources superimposed on the equilibrium concentration limit of flammability curves for the 0 to 10% fraction of the fuel.

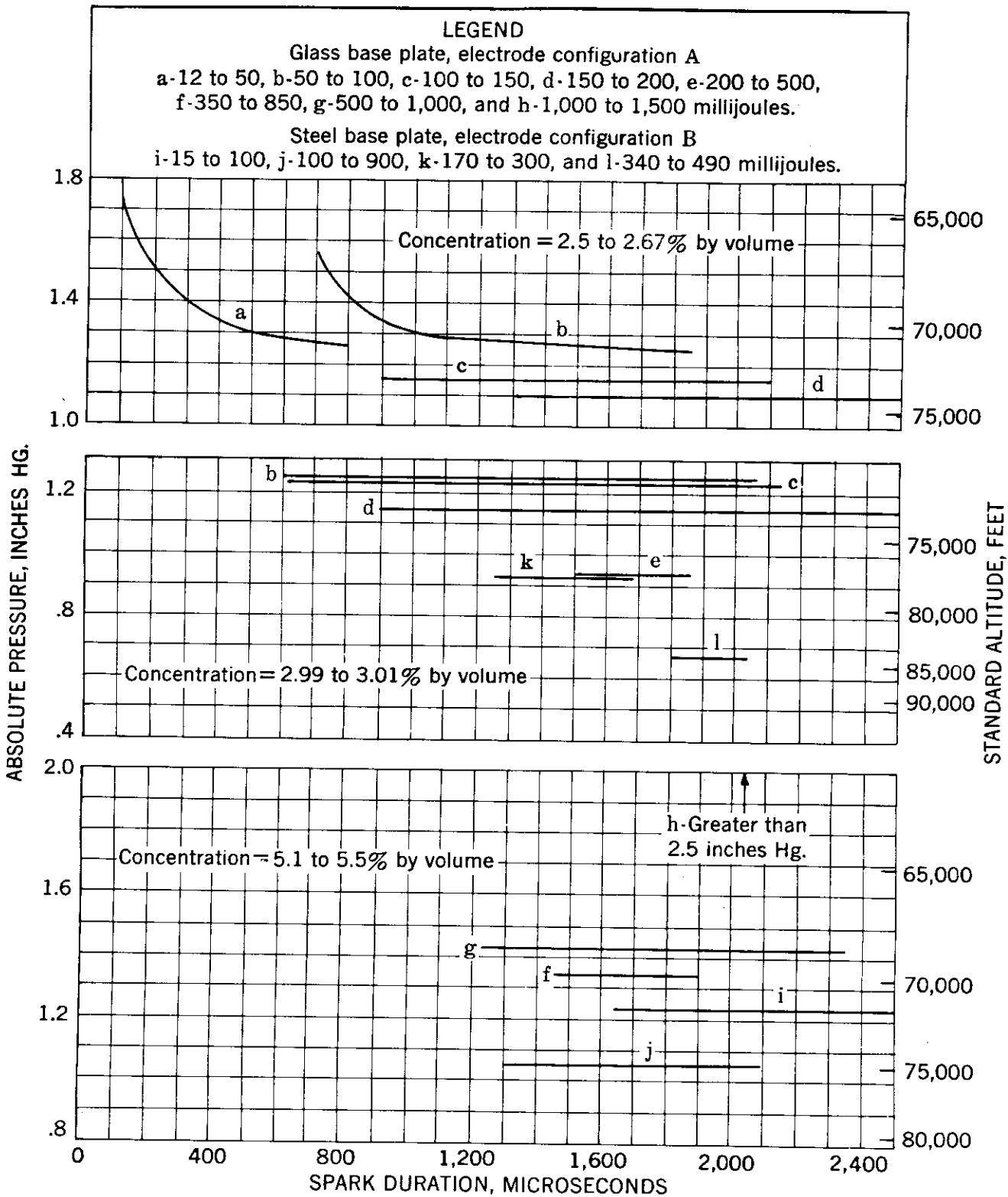

Figure 18.—Low pressure ignitability curves (minimum pressure at which ignition occurs plotted as a function of spark energy and time duration) for the concentrations of aviation gasoline grade 100/130 vapor in air noted on each set of graphs.

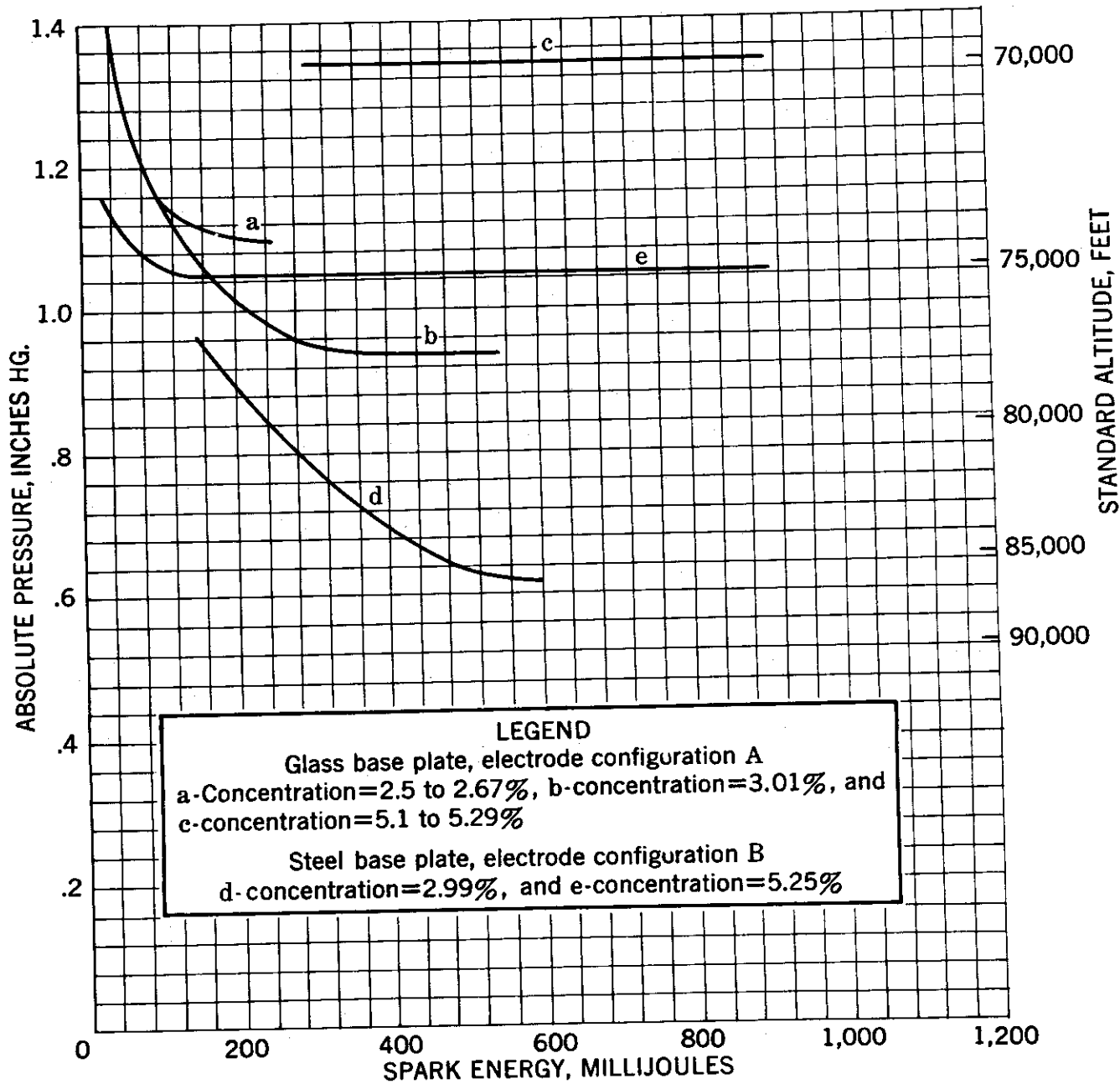

Figure 19.—Low pressure ignitability curves (minimum pressure at which ignition occurs, plotted as a function of spark energy) for different concentrations of aviation gasoline grade 100/130 vapor-air mixtures and for two electrode configurations. Duration of sparks is between 500 and 2500 microseconds.

3.3.6 Figure 19 gives five low pressure ignitibility curves for three concentration ranges and the two electrode configurations (A) and (B) described above. The data used for these curves were obtained for a spark duration between 500 and 2400 microseconds making the minimum ignition pressures independent of spark duration (cf. Figure 18). The optimum spark ignition energy depends on the electrode configuration as well as on the concentration of the combustible vapor-air mixture tested; in addition probably the best electrode configuration is a function of the temperature and pressure. However, a few preliminary conclusions can be drawn from Figures 18 and 19; namely, the optimum ignition energy for pressures below 2 inches Hg absolute is approximately 500 millijoules or greater. Also, this energy should be delivered in approximately 500 microseconds. (This applies to a 1/4-inch gap.)

3.4 Ignition Temperatures

3.4.1 The minimum spontaneous ignition temperatures obtained for the five USAF combustibles investigated are listed in Table 3. Data have been obtained at one atmosphere and 1/2 atmosphere pressure for the combustibles in contact with a pyrex surface, and at one atmosphere pressure with the combustibles in contact with aluminum and magnesium surfaces (Table 3). An important point to note in connection with Table 3 is that when in contact with a magnesium surface (FS-1, Spec. QQ-M-44), no ignition occurs for aviation gasoline grade 100/130 up to 918°F. or for aviation gasoline grade 115/145 up to 959°F. It is possible that these fuels may ignite above these temperatures, however tests were not continued to higher temperatures for fear of exceeding the spontaneous ignition temperature of the magnesium.

Table 3.—Minimum spontaneous ignition temperatures(°F.) in air.

Combustible	At 1 atmosphere			At 1/2 atmosphere
	in Pyrex	in Al*	in Mg**	in Pyrex
aviation gasoline grade 100/130	824	824	918	1027
aviation gasoline grade 115/145	880	842	959	1063
aviation jet fuel grade JP-1	442	442	468	864
aviation jet fuel grade JP-3	460	486	484	840
Aviation hydraulic fluid AN-O-366	437	424	448	838

* Aluminum 528-1/2 hard, Spec. QQ-A-318

** Magnesium FS-1, Spec. QQ-M-44

Contrails

3.4.2 The spontaneous ignition temperature for a combustible in contact with a specified surface at a specified pressure may be plotted as ordinate against the time lag before ignition as abscissa, for various concentrations of combustible in air. When the combustible is injected into the test flask as a liquid, the range of concentrations in the heated test flask is wide. In this case, plots may be made for various quantities of injected combustible. Typical plots are given in Figures 20a, 20b, and 20c for aviation jet fuel grades JP-1 and JP-3, and for aircraft hydraulic fluid AN-O-366, respectively, in contact with a magnesium surface at one atmosphere pressure. Similar plots are not available for aviation gasoline grades 100/130 and 115/145 as no explosions were obtained with these fuels in contact with a magnesium surface, as mentioned above (see also Table 3).

3.5 Mists and Sprays

3.5.1 Data obtained to date on sprays and mists indicate that the limits of flammability determined for vapors may be used also in the case of sprays and mists. However, flame propagation appears possible only if the combustible liquid droplets are vaporized and the vapors mixed with suitable amounts of air in the presence of an ignition source. Thus we are confronted with a problem of heat and mass transfer.

3.5.2 Because of the ease of formation of mists, the early experiments on this project were performed with aviation jet fuel grade JP-1 mists in air. These mists were formed by vaporizing the fuel into an evacuated cylinder and suddenly admitting cold air into the vapor-filled cylinder; this produced a fairly uniform mist. The average droplet size in the mist varied depending on the temperature of the vapor and the air and also on the time elapsed between mist formation and droplet-size determination. In the tests with aviation jet fuel grade JP-1, the average droplet diameter immediately after formation of the mist was 10 microns with the mist at approximately 32°F. Tested under these conditions, the concentration limits of flammability were 55 and 300 mg. fuel per liter of air (S.T.P.), respectively, for the lower and upper limits of flammability. This corresponds to F/A values of 0.043 and 0.23 (compare the lower limit vapor-air data in Figure 7).

3.5.3 Two procedures have been used in the study of sprays; one uses a Bosch injector, the other a two-fluid nozzle. The apparatus are described in Appendix IX.

3.5.4 The horizontal plane of the region of ignitibility of spray formed with a Bosch injector using weak sparks produced by a luminous tube transformer are given in Figure 21. In these tests, 0.15 gram of JP-1 fuel was injected into relatively quiet air at an injection pressure of 3500 psig. The outermost envelope in Figure 21 gives the ignitable region using 18-gage tungsten wire, or 1/8-inch brass welding rod, electrodes, if the electrical power supplied to the luminous tube transformer exceeds 78 watts. However, with lower power input, ignition was attained along this outer curve in 4 to 10% of the trials, whereas ignition was attained along the innermost

Contrails

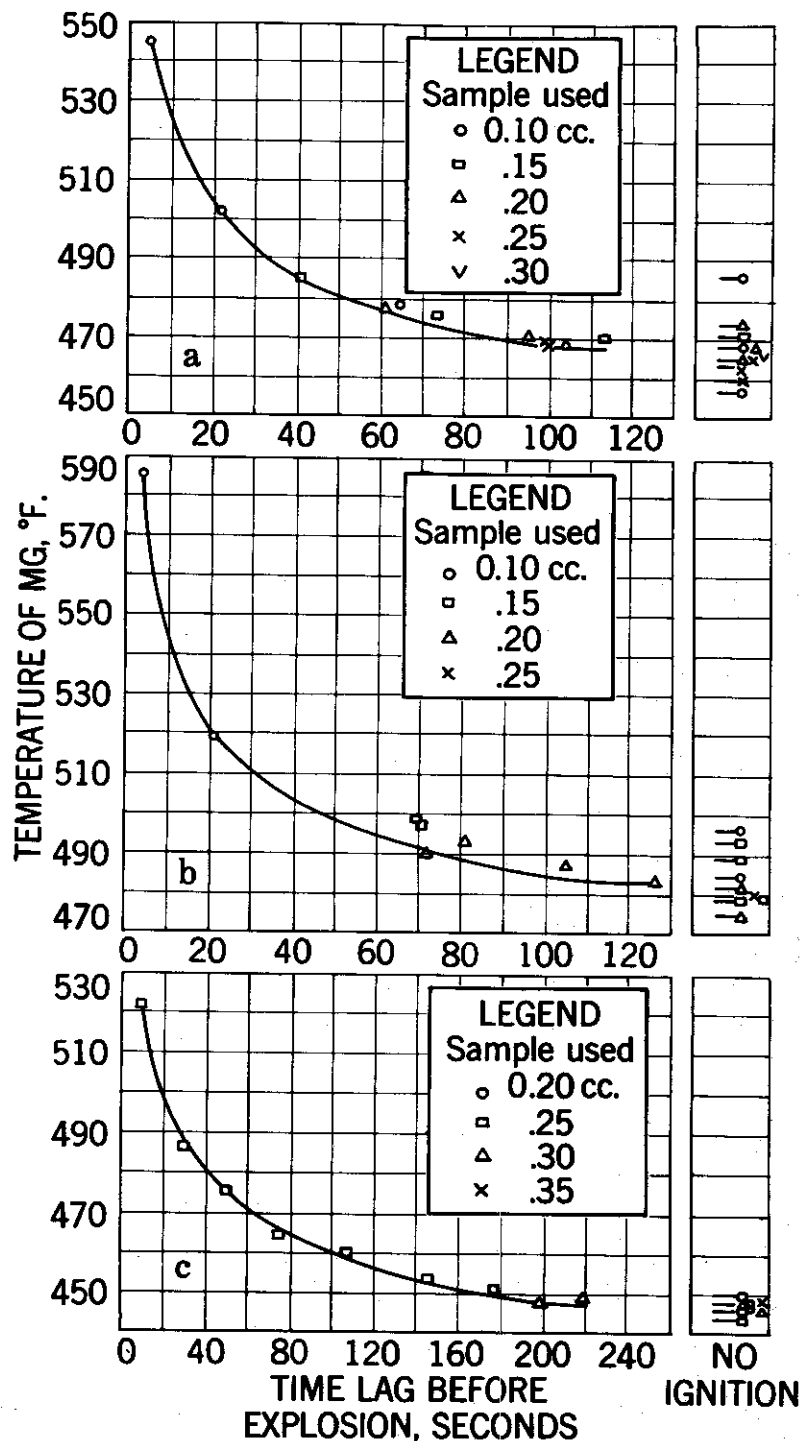

Figure 20. - Variations in spontaneous ignition temperatures with time lag before explosion and quantity of combustible for, (a) aviation jet fuel grade JP-1, (b) aviation jet fuel grade JP-3 and, (c) aircraft hydraulic fluid AN-O-366 in contact with magnesium (FS-1, spec. QQ-M, 44) in air at atmospheric pressure.

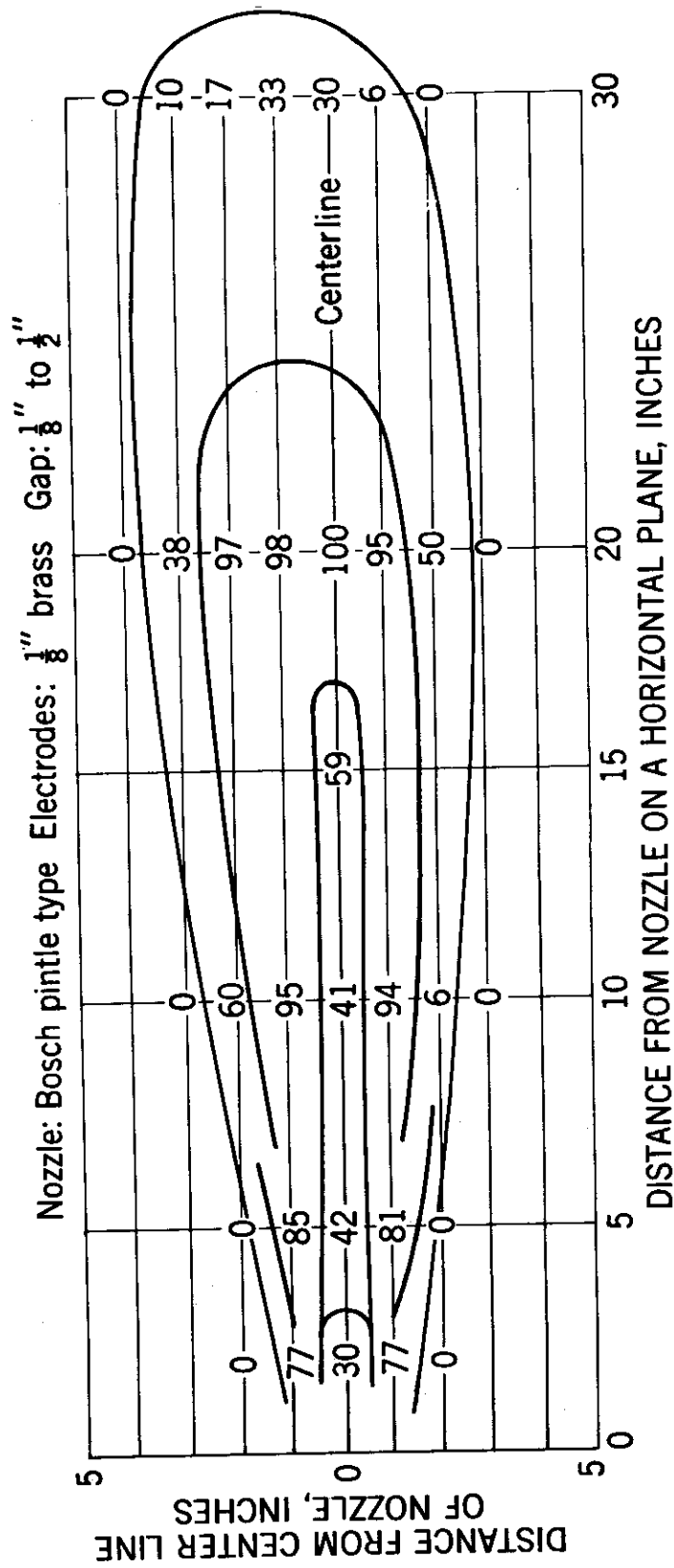

Figure 21. - Lines of equiprobability for aviation jet fuel grade JP-1 spray in air using powerful spark ignition source (30-50 watts.)

Contrails

envelope in 30 to 42 percent of the trials, etc. The equi-ignition probability curves (Figure 21) represent average curves obtained for three spark gaps measuring 1/8, 1/4 and 1/2-inch, respectively, the corresponding primary powers being 30, 40 and 50 watts. These power inputs correspond to voltages that barely sustain an arc for the three gaps considered. When the electrodes were not permitted to cool between tests, ignition of the spray was more frequent than indicated by the envelopes in Figure 21; this was more noticeable for the tungsten than for the brass electrodes.

3.5.5 The two-fluid nozzle spray apparatus is described in Appendix IX. The only quantitative limit-of-flammability data obtained with this apparatus to date consists of a lower limit of flammability fuel-air ratio for aviation jet fuel grade JP-1 of 0.0394. This value checks rather well with the data obtained for vapor-air mixtures (Figure 7). It was obtained by considering the air-velocity data for the 60° funnel (Figure 22), as well as the air and jet fuel-feed rate to the two-fluid nozzle.

3.5.6 The air-velocity data in Figure 22 indicate that in general there is so much turbulence and entrained air involved in this type of air-velocity measurement that the problem of determining average fuel-air ratios is complicated considerably by any surface close to the exit hole of a nozzle. Accordingly, current work is performed by spraying into the atmosphere with no restricting surfaces near the nozzle.

3.5.7 The spray produced by the two-fluid nozzle consisted of a rather heterogeneous mixture of various droplet diameters. Figure 23 shows a typical set of photomicrographs of the impressions made on a carbon coated microscope slide by aviation jet fuel grade JP-1 spray formed with a two-fluid nozzle. The droplet size variation is very marked here. Surface averaged droplet diameters varied from 44 microns, 2.6 inches from the nozzle, to 8 microns, 16 inches from the nozzle.

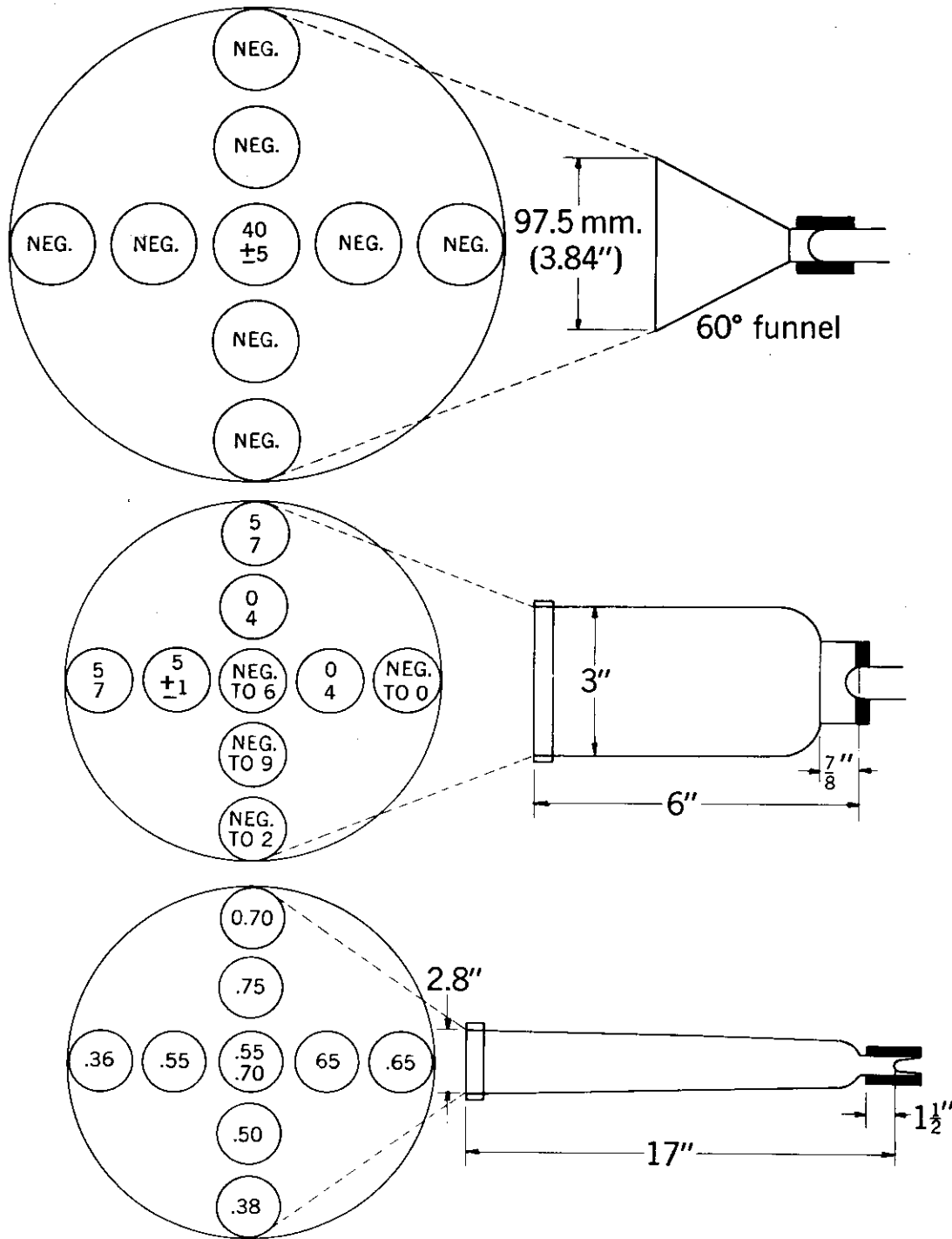
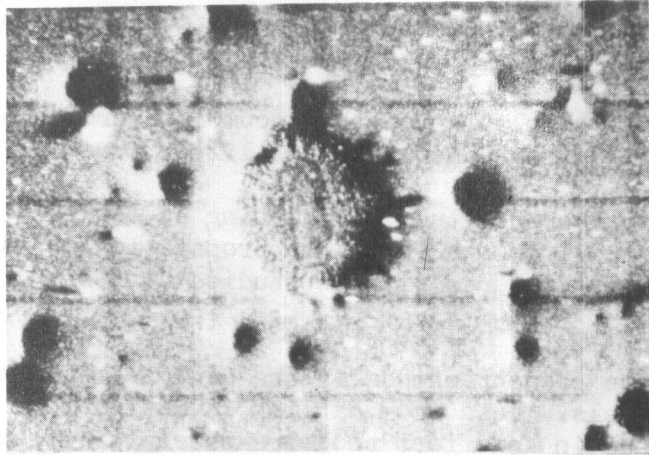
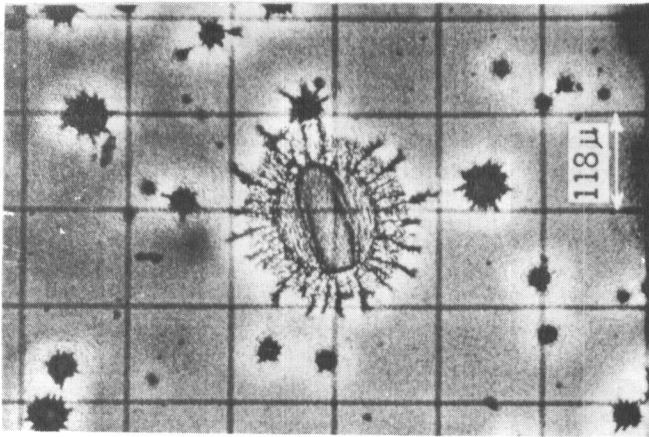

Figure 22. - Total air velocities due to the primary air from a two fluid nozzle plus the entrained secondary air for three exit chambers attached to the nozzle, (large circles represent chamber outlets, numbers in small circles are velocities in hundreds of feet per minute).



Oblique illumination



Transmitted light

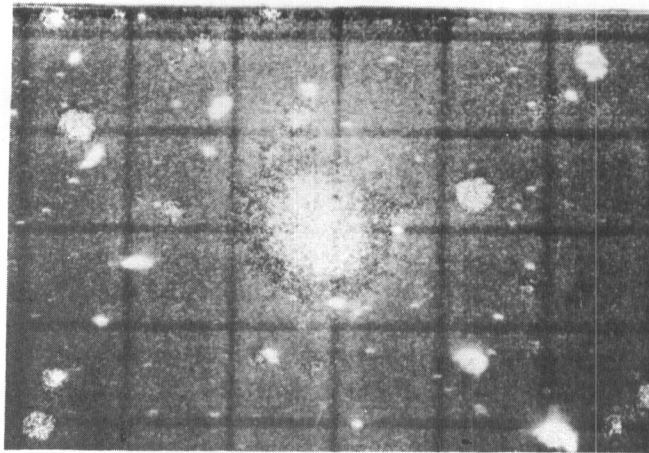

Vertical illumination

Figure 23. - Photomicrographs of impressions made on a carbon coated microscope slide by aviation jet fuel grade JP-1 spray formed with a two fluid nozzle.

SECTION IV

PROPOSED FUTURE INVESTIGATIONS

- 4.1 Future investigations of the flammability characteristics of aircraft fuels should include at least four items.
- 4.2 The first item is the completion of the incomplete projects enumerated under phases 1 and 2, paragraphs 1.2.2 and 1.2.3.
- 4.3 The second item involves the study of inerting at low pressures. For example, minimum oxygen requirements for flame propagation of various aircraft fuel-air-inerting gas mixtures will be studied at low and atmospheric pressures.
- 4.4 The third item on the present agenda is the study of the flammability characteristics of new fuels. Data from earlier investigations should be applied to new fuel blends in an effort to decrease explosion hazards in the proposed use of these fuels.
- 4.5 The fourth item may best be stated as follows: To investigate the flammability characteristics of various pure hydrocarbons found in typical hydrocarbon blends and apply the resulting data to the study of the flammability characteristics of control blends which initially may consist of two or three component mixtures of accurately known composition. These investigations would be especially important at low temperatures and pressures as mentioned in paragraph 3.2.3.

CONCLUSIONS

5.1 The compositions of aviation gasoline grades 100/130 and 115/145 and of aviation jet fuel grade JP-3 are such as to permit flame propagation in vapor-air mixtures of the fuels over extremely wide temperature and pressure ranges. Propagation of flame is possible at temperatures well below those encountered in the earth's atmosphere and for pressures corresponding to altitudes greater than those normally attained by present day aircraft. Flame propagates through saturated vapor-air mixtures of the above fuels at temperatures below -100°F . and 2 inches Hg absolute pressure (62,000 feet). As the temperature rises, flame propagates through unsaturated vapor-air mixtures of the above fuels at still lower pressures. For example, at 78°F . flame propagates through a 2.99% aviation gasoline grade 100/130 vapor-air mixtures at an absolute pressure of 0.63-inch Hg (86,000 feet).

5.2 Flame could not propagate in aviation jet fuel grade JP-1 vapor-air mixtures existing below 68°F . and 1.9 inches Hg (63,000 feet). The reason for this is that the fuel contains no highly volatile components so that the total vapor pressure of all the components is too low at temperatures below 68°F . to form an explosive mixture. Therefore, this fuel presents a much smaller explosion hazard from the standpoint of the vapor that exists at temperatures normally encountered in handling and storage than do the three fuels discussed above.

5.3 An electric spark delivered over a relatively long period appears to be more effective as an ignition source than one delivered in a series of short bursts, as in the case of a Ford ignition coil or a luminous tube transformer. The surge generator built to achieve ignition at low pressures is the most efficient ignition source used to date; other sources tested include, besides the surge generator, luminous tube transformers and Ford coils, capacitor discharges, heated wires, fused wires, and guncotton, and are listed in the order of their effectiveness for the ignition of combustible vapor-air mixtures at low pressures.

5.4 Of the combustibles investigated, the one most easily ignited spontaneously at elevated temperatures and one atmosphere pressure was aircraft hydraulic fluid AN-O-366, with aviation jet fuel grades JP-1 and JP-3 following very closely in the order given. Aviation gasoline grades 100/130 and 115/145 ignited spontaneously at much higher temperatures, listed in order of ease of ignition. The above statements hold whether the combustibles are in contact with a pyrex, aluminum or magnesium surface, except that in the case of the magnesium surface the gasolines did not ignite even when the temperature was elevated to approximately the ignition temperature of the magnesium itself. The ease of ignition of the above

Contrails

combustibles at one-half atmosphere pressure in contact with a pyrex surface in air was in the order, aviation hydraulic fluid AN-O-366, aviation jet fuel grades JP-3 and JP-1, and aviation gasoline grades 100/130 and 115/145. The corresponding minimum ignition temperatures at one-half atmosphere were higher in all cases than those at one atmosphere pressures.

5.5 Only a few of the problems associated with the ignition of mists and sprays have been investigated thus far. The concentration limits of flammability for very fine droplets appear to be approximately the same as those found for vapor-air mixtures under the same conditions of temperature and pressure. This indicates burning of vapor-air mixtures surrounding individual droplets so that the successful burning of an aggregate of combustible liquid droplets suspended in air presupposes vaporization of all or a portion of each droplet, followed by mixing of the vapor with the amount of air required to produce a flammable mixture. For this reason, the problems of heat transfer to liquid droplets and mixing of vapor and air by a flame should be investigated. It is known that large amounts of power must be dissipated by the ignition source to achieve ignition of a spray, but energy requirements of spray ignition have not been investigated.

Contrails

BIBLIOGRAPHY

1. Burgoyne, J. H., and Richardson, J. F. The Inflammability of Oil Mists. Fuel, 28, No. 1, pp. 1-5, January 1949.
2. Castleman, R. A. The Mechanism of the Atomization of Liquids. N.B.S. Jour. Res., 6, p. 369, 1931.
3. Coward, H. F. and Jones, G. W. Limits of Flammability of Gases and Vapors. Bureau of Mines Bulletin 503 (Rev. of Bull. 279), 1952.
4. De Juhasz, K. J., Zahn, O. F., Jr., and Schweitzer, P. H. On the Formation and Dispersion of Oil Sprays. Bulletin 46, Penna. State Engr. Exp. Station, 31, No. 29, 5 July 1937.
5. Dispersions in Gases. 17th Annual Chem. Engr. Symposium. Reprints from Ind. Eng. Chem., June 1951, and Anal. Chem., June 1951.
6. Godsave, G. A. E. Combustion of Droplets in a Fuel Spray. Nature, 164, 22 October 1949.
7. Guest, P. G., Sikora, V. W., and Lewis, B. Static Electricity in Hospital Operating Suites: Direct and Related Hazards and Pertinent Remedies. Bureau of Mines Rept. of Investigations 4833, January 1952.
8. Jones, G. W. Inflammability of Mixed Gases. Bureau of Mines Tech. Paper 450, 38 pp., 1929.
9. Jones, G. W. and Spolan, I. Inflammability of Gasoline Vapor-Air Mixtures at Low Pressures. Bureau of Mines Rept. of Investigations 3966, 1946.
10. Kuehn. Atomization of Liquid Fuels, Parts I and II. Translated at NACA, Tech. Memos. 329 and 330, 1925.
11. Lane, W. R. A Microburette for Producing Small Liquid Drops of Known Size. Jour. of Sci. Instr. 24, pp. 98-101, 1947.
12. Lee, D. W. and Spencer, R. C. Photomicrographic Studies of Fuel Sprays. NACA Report No. 454.
13. Levvy, G. A. The Delivery of Small Drops of Liquid. Jour. Sci. Instr., 24, pp. 274-5, 1947.
14. Lewis, H. C., et al. Atomization of Liquids in High Velocity Gas Streams. Ind. Eng. Chem., 40, 67, 1948.
15. Lewis, B. and von Elbe, G. Combustion, Flames and Explosions of Gases. Academic Press, Inc., New York, 1951.

Contrails

16. Lloyd, P. The Fuel Problem in Gas Turbines. Inst. Mech. Engrs. Proc., 159, pp. 220-229, 1948.
17. MacLennan, A. M. A Study of Kerosene Mist Explosions. Royal Aircraft Est., Rept. No. Chem. 448, September 1949, Discreet.
18. May, K. R. An Improved Spinning Top Homogeneous Spray Apparatus. Jour. App. Phys., 20, No. 10, p. 932, October 1949.
19. Mellan, I. Industrial Solvents (Second Ed.), p. 61, Reinhold Publishing Corp., New York, 1950.
20. Merrington and Richardson. The Breakup of Liquid Jets. Proc. Phys. Soc., A59, 1947.
21. Perry, J. H. Chemical Engineers Handbook (Third Ed.) McGraw-Hill Book Co., New York, 1950.
22. Roof, J. G. A Temperature Control System. Electronics, p. 166, October 1943.
23. Ruedy, R. Absorption of Light and Heat Radiation by Small Spherical Particles. Canadian Jour. of Res., 19, Sec. A, pp. 117-125, No. 10, October 1941.
24. Rupe, J. H. A Technique for the Investigation of Spray Characteristics of Constant Flow Nozzles. The Third Symposium on Combustion, Flame and Explosion Phenomena, The Williams & Wilkins Co., Baltimore, Md., 1949.
25. Rupe, J. H. Critical Impact Velocities of Water Droplets as a Problem in Injector Spray Sampling. Progress Report No. 4-80, JPL Cal. Tech., September 1950.
26. Schweitzer, P. H. Penetration of Oil Sprays. Bull. No. 46, Penn State Engr. Expt. Station, 31, No. 29, 5 July 1937.
27. Scott, G. S., Jones, G. W., and Scott, F. E. Determination of Ignition Temperatures of Combustible Liquids and Gases. Modification of the Drop Method Apparatus. Anal. Chem., 2, March 1948, pp. 238-241.
28. Sinclair, Davis. Light Scattering by Spherical Particles. J.O.S.A., 37, No. 6, p. 457, June 1947.
29. St. Clair, H. W., Spendlove, M. J. and Potter, E. V. Flocculation of Aerosols by Intense High Frequency Sound. U. S. Bureau of Mines Rept. of Investigations 4218, March 1948.
30. Stoker, R. L. A Method of Determining the Size of Droplets Dispersed in a Gas. Jour. App. Phys., 17, No. 4, pp. 243-245, April 1946.

Contrails

31. Stull, D. R. Application of Platinum Resistance Thermometry to Some Industrial Physicochemical Problems. Ind. Eng. Chem., pp. 234-242, 15 April 1946.
32. Stull, D. R. Vapor Pressure of Pure Substances, Organic Compounds. Ind. Eng. Chem., 39, p. 526, April 1947.
33. Sullivan, M. J., Wolfe, J. K. and Zisman, W. T. Flammability of the Higher Boiling Liquids and Their Mists. Ind. Eng. Chem., 39, No. 12, p. 1607, December 1947.
34. Swett, C. C., Jr. Spark Ignition of Flowing Gases, I -- Energies to Ignite Propane-Air Mixtures in Pressure Range of 2 to 4 inches Mercury Absolute. NACA RM E9E17, 1949.
35. Swett, C. C., Jr. Spark Ignition of Flowing Gases, II -- Effect of Electrode Parameters on Energy Required to Ignite a Propane-Air Mixture. NACA RM E 51J12.
36. Taylor, L. T. The Inflammability Characteristics of Liquid Fuels. AFTR No. 5895, July 1949.
37. United States Government Printing Office, A. E. C. Handbook on Aerosols, Washington, D. C., 1950.
38. Zabetakis, M. G., Scott, G. S., and Jones, G. W. Limits of Flammability of the Paraffin Hydrocarbons in Air. Ind. Eng. Chem., 43, No. 9, pp. 2120-24, September 1951.
39. Zabetakis, M. G., Scott, G. S., and Jones, G. W. The Flammability Characteristics of the C_nH_{2n-6} Aromatic Series. U. S. Bureau of Mines Rept. of Investigations 4824, October 1951.

APPENDIX I

The F-1 Concentration Limits-of-Flammability Apparatus

Essentially the F-1 apparatus (Figure 24) is a partial pressure limit-of-flammability apparatus (Ref. 9). The combustible to be studied is placed in a 20 ml. glass container p attached to the apparatus at the lower branch of a T-bore stopcock o by a very short section of neoprene rubber tubing. To study mixtures of a combustible and an inert, the inert material container may be attached to the apparatus at the T-bore stopcock o'. The neck of the glass container p butts against the stem of the T-bore stopcock. To prevent leaks, a hydrocarbon-insoluble grease is used on the stopcock and a mercury seal q' is placed around the glass container and the neoprene rubber connection. At the beginning of a run, stopcocks o and o' are connected between q and a; plate b and mercury seal c are put in place; mixer e is filled with mercury to outlet valve h by raising the leveling bulb g; the screw clamp on f is closed and the explosion chamber is evacuated as completely as possible so as to bring the manometer reading to within 0.1 mm. Hg of the barometer reading. The air above the sample in p is removed through o, q, r and s. The sample is introduced slowly into a by opening stopcock o until the manometer reading has decreased x mm. Stopcock o is then closed between p and a, and opened between q and a to allow air to enter a until the mercury column in k falls to zero. The combustible and air in explosion chamber a are mixed thoroughly by opening the pinch clamp on f and raising and lowering leveling bulb g at least 50 times. This gives a uniform combustible vapor-air mixture in which the percentage of combustible vapor by volume is taken to be:

$$\% \text{ combustible} = \frac{x}{P_B} \quad (15)$$

where x = partial pressure of combustible vapor, P_B = barometric pressure.

If limits of flammability are to be determined below atmospheric pressure, combustible vapor-air mixture is removed through g, o and o' until manometer k indicates the desired pressure. The mercury seal c is then removed, the room is darkened and a spark is passed between electrodes y. Visual observation is sufficient to determine whether or not the mixture in the tube is explosive. This process is repeated until the limiting mixtures have been found for a series of pressures at constant temperature.

APPENDIX II

The I-8 Ignition Temperature Apparatus

The I-8 Ignition Temperature apparatus (Figure 25) (Ref. 39) is a modification of that developed by Scott, Jones and Scott (Ref. 27). The essential unit of the apparatus is a standard Hoskins Type FD-104 electric crucible furnace. This furnace consists of a heater f wound on an alundum cylinder p, whose inner diameter and height are 5 inches respectively. The top of the furnace is a transite ring h and the bottom is a transite disk q, both fastened to a metal cylinder v. The insulation consists of sections r, r, and s. As the operating temperatures at the top and bottom of the crucible well are below the temperature at the mid-section, a neck and base heater were added to the furnace. The torroidal neck heater e is wound on a transite ring k, using 50 feet of No. 26 B&S gage nichrome wire. A transite ring n keeps the 200-cc. erlenmeyer test flask a in place and supports the ceramic insulators m. The temperatures at the neck, mid-section, and base are measured by means of thermocouples b, c, and d, respectively. These temperatures are recorded on 3 channels of a 12-channel electronic temperature recorder. The temperature variation between any two thermocouples is easily kept at less than $1/2^{\circ}\text{C}$. over the entire working range of the apparatus (the working range is limited by the softening point of the pyrex test flask). The temperatures of the three heaters are varied by means of three autotransformers connected to the heaters by terminals t, t, u, u.

Operations with this apparatus may be divided into three steps: temperature control, injection of sample, and observation. The first step involves adjustment of the three autotransformers to bring the temperatures at the top, center and bottom of the test flask* to within $1/2^{\circ}\text{C}$. of the desired test temperature. A measured amount of the sample is injected into the test flask with a 1-cc. hypodermic syringe calibrated in units of 0.01 cc. The inside of the test flask is then observed by means of a mirror placed at the appropriate angle above the flask. An electric timer is switched on at the instant the sample is injected into the test flask and stopped at the first appearance of flame in the flask. It is often necessary to darken the room in order to see the flames which are rather light blue in color. If no flame appears within about 5 minutes, the volume of sample tested is considered nonflammable at the temperature of the test flask. The test is then repeated at a higher temperature and/or for a different concentration of combustible.

When the I-8 apparatus is used for low pressures it is housed in a low-pressure steel chamber. This chamber is equipped with an outlet port attached to a vacuum pump, a manometer, electrical connectors, a water-cooled coil, a liquid injector and an observation window. The procedure followed is the same as for atmospheric pressure.

* Three test flasks were used for the investigations reported here; a 200 cc. erlenmeyer pyrex flask, a 500 cc. cylindrical aluminum (52S-1/2 hard Spec. QQ-A-318) flask and a 500 cc. cylindrical magnesium (FS-1 Spec. QQ-M-44) flask. The cylindrical flasks were 4 inches high and 3 inches in diameter.

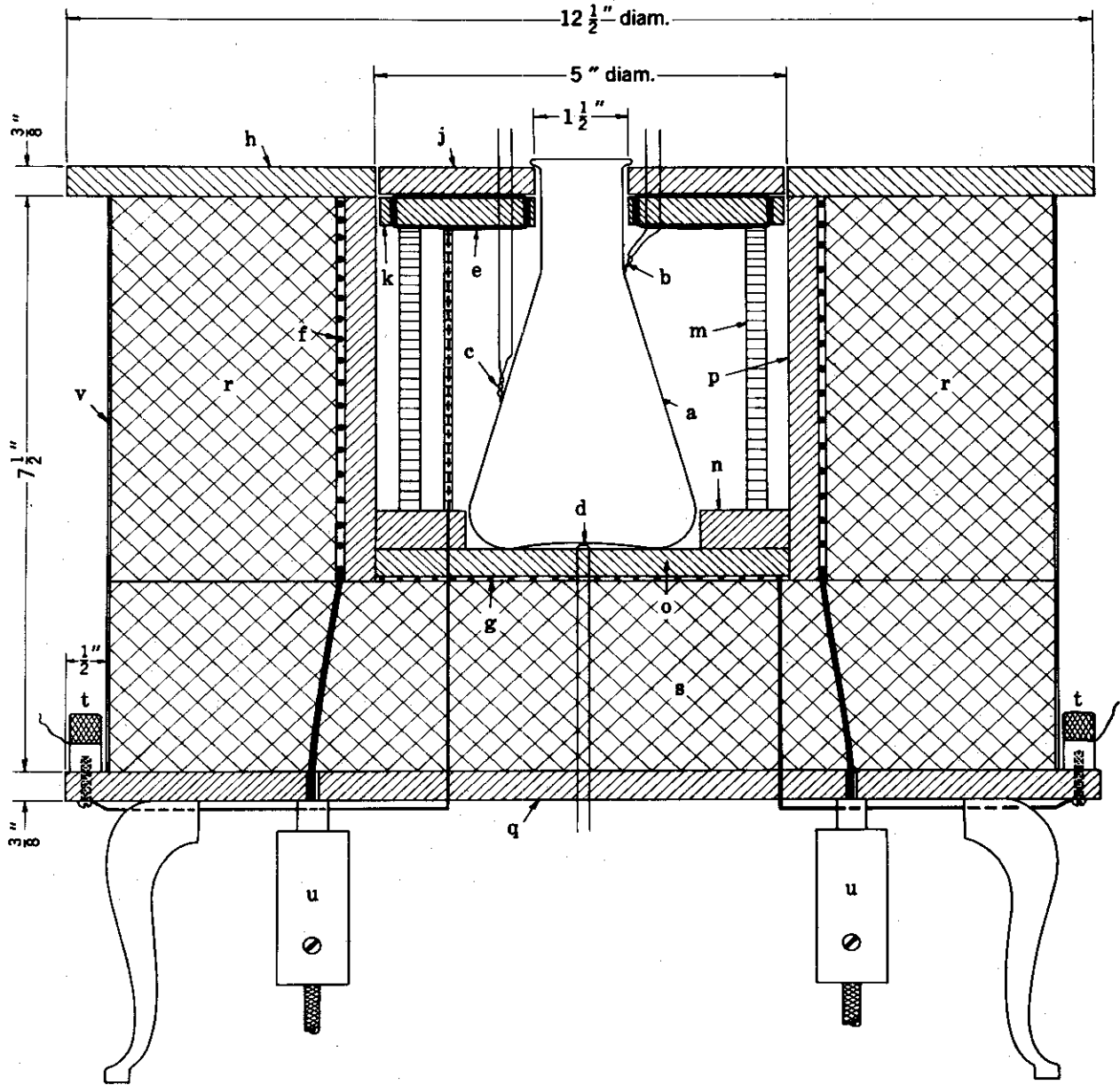

Figure 25. - Detailed drawing of the I-8 ignition temperature apparatus.

The F-9 Temperature Limits of Flammability Apparatus

This apparatus is used to determine the temperature limits of flammability for saturated combustible vapor-air mixtures at atmospheric and reduced pressures. Since the vapor pressure of a combustible depends on the temperature, the quantity of vapor in a saturated vapor-air mixture above the combustible may be varied by varying the temperature of the combustible. If, in addition, the absolute pressure of the vapor-air mixture can be varied while the temperature is kept constant, the concentration of fuel vapor in the vapor-air mixture above the combustible may be varied. In this way, flammability tests can be conducted on saturated fuel vapor-air mixtures at various concentrations, thus making it possible to determine the limiting mixtures that lie between the explosive and nonexplosive regions. Since this is a vapor-pressure apparatus, very accurate temperature control is required. An accurate control of the absolute pressure in the explosion chamber is necessary to define the limit mixture accurately.

The schematic diagram of this apparatus is given in Figure 26. A general view of the F-9 explosion chamber installed in an oven is given in Figure 27. The electronic temperature controller appears in Figure 32 with the F-11 apparatus. Accordingly, this controller will be discussed in connection with the F-11 apparatus in Appendix V.

Approximately 20 cc. of the sample is injected into the system at c (Figure 26). The oven temperature is adjusted to the desired value and kept constant during a series of tests. The absolute pressure in the explosion chamber is varied from test to test by means of pressure adjustment valve E. The vacuum pump is started and valves B and E are adjusted for the desired rate of air flow through the saturator and the desired pressure in the explosion chamber. The rate of air flow through the saturator is kept low so that the vapor-air mixture in the explosion chamber is almost quiescent. The bulk of the vapor-air mixture moves upward in the explosion chamber at less than one foot per minute. A low air-flow rate also helps maintain a uniform temperature as the saturator does not cool noticeably due to vaporization of the sample.

Air enters the system at A, is dried and metered and passed into the preheater tube (5 mm. O.D. pyrex glass tubing, 125 cm. long). A sintered glass well is attached to the end of the preheater. The air passes through this well into the sample in the saturator. The saturator is half full of 3 mm. perforated glass beads that are covered by the combustible liquid sample. The explosion chamber is flushed thoroughly several times with vapor-air mixture. The rubber hose segments between points B and C, and points D and E are pinched off and the vacuum pump is stopped. If the pressure changes slightly during this last step, it is readjusted to the desired value. The room is then darkened and a spark discharge passed through the vapor-air mixture about three inches from the bottom of the explosion chamber. If a flame propagates at least thirty inches (approximately $\frac{2}{3}$ the length of the explosion chamber), the mixture is considered flammable. Flame propagation along $\frac{2}{3}$ of the length of the tube is chosen as the governing criterion because the top portion of the explosion chamber passes through the oven and exhausts into the air or into a low-pressure system which is at room temperature and not at the temperature of the oven.

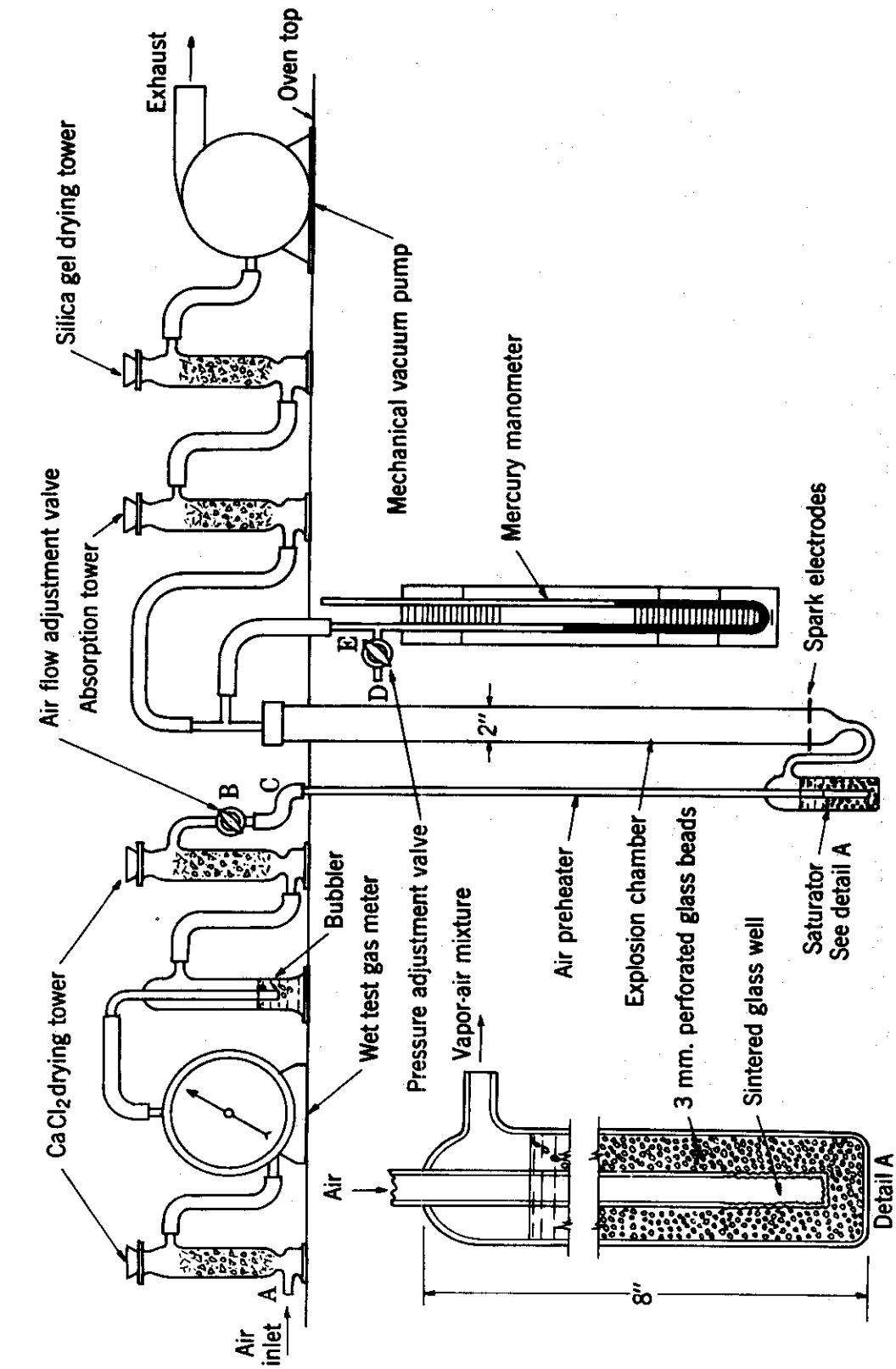

Figure 26. - Schematic diagram of the F-9 elevated temperature equilibrium concentration limit of flammability apparatus.

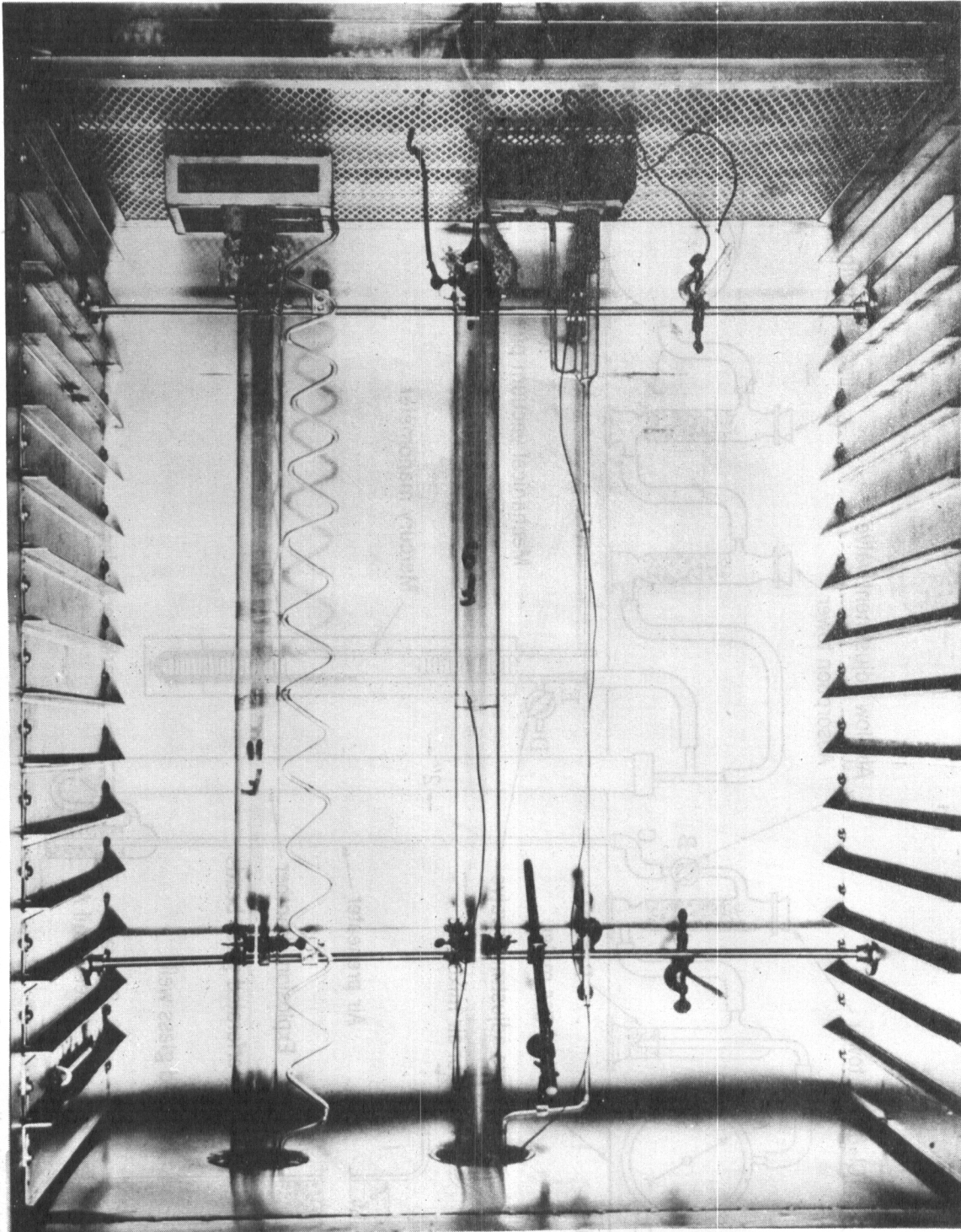

Figure 27. Close up view of the F-9 and F-11 explosion chambers installed in the oven.

APPENDIX IV

The F-10 Temperature Limits of Flammability Apparatus

The F-10 apparatus is similar to the F-9 apparatus described in Appendix III. The F-10 explosion chamber is two inches in diameter by 18 inches in length and is housed in a cold chamber (Figures 28, 29 and 30).

In making a test with this apparatus, dry ice is first placed in the sub-zero cabinet j (Figure 28) and the thermoregulator set for the desired test temperature. When the desired steady-state temperature is reached in the sub-zero cabinet, dry ice is placed in the Dewar cup surrounding water trap g, which follows drying towers e and f, and a cooling mixture in the cup surrounding saturator h. The compressor a is started and the initial pressure head adjusted by means of c. The flow rate is set by the needle valve preceding saturator h. Dried air almost saturated with combustible vapor at a temperature slightly higher than the explosion chamber i, temperature is passed through the explosion chamber, as in the case of the F-9 apparatus (Appendix III). The air is metered by wet-test gas meter m after all the vapor has been removed by liquid trap l. Flask o and bubbler n are used when the vapor-air mixture is passed through the apparatus without being metered. The vapor-air mixture in the explosion chamber is tested as in the case of the F-9 apparatus, except that here the entire explosion chamber is at the same reduced temperature and the criterion for flammability of a mixture is flame propagation the entire length of the explosion chamber. The auxiliary apparatus k, p, g, r, s, t, and u are used for partial pressure determinations.

APPENDIX V

The F-11 Concentration Limit-of-Flammability Apparatus

The F-11 apparatus (Figure 31) is a flow-type elevated-temperature constant-pressure concentration limit-of-flammability apparatus (Refs. 38 and 39). It consists of the following parts (Figures 27, 32, 33 and 34):

1. Constant-temperature bath
 - a. Oven and heaters
 - b. Temperature recorder
 - c. Temperature controller
2. Explosion Chamber
3. Vaporizer and Mixer

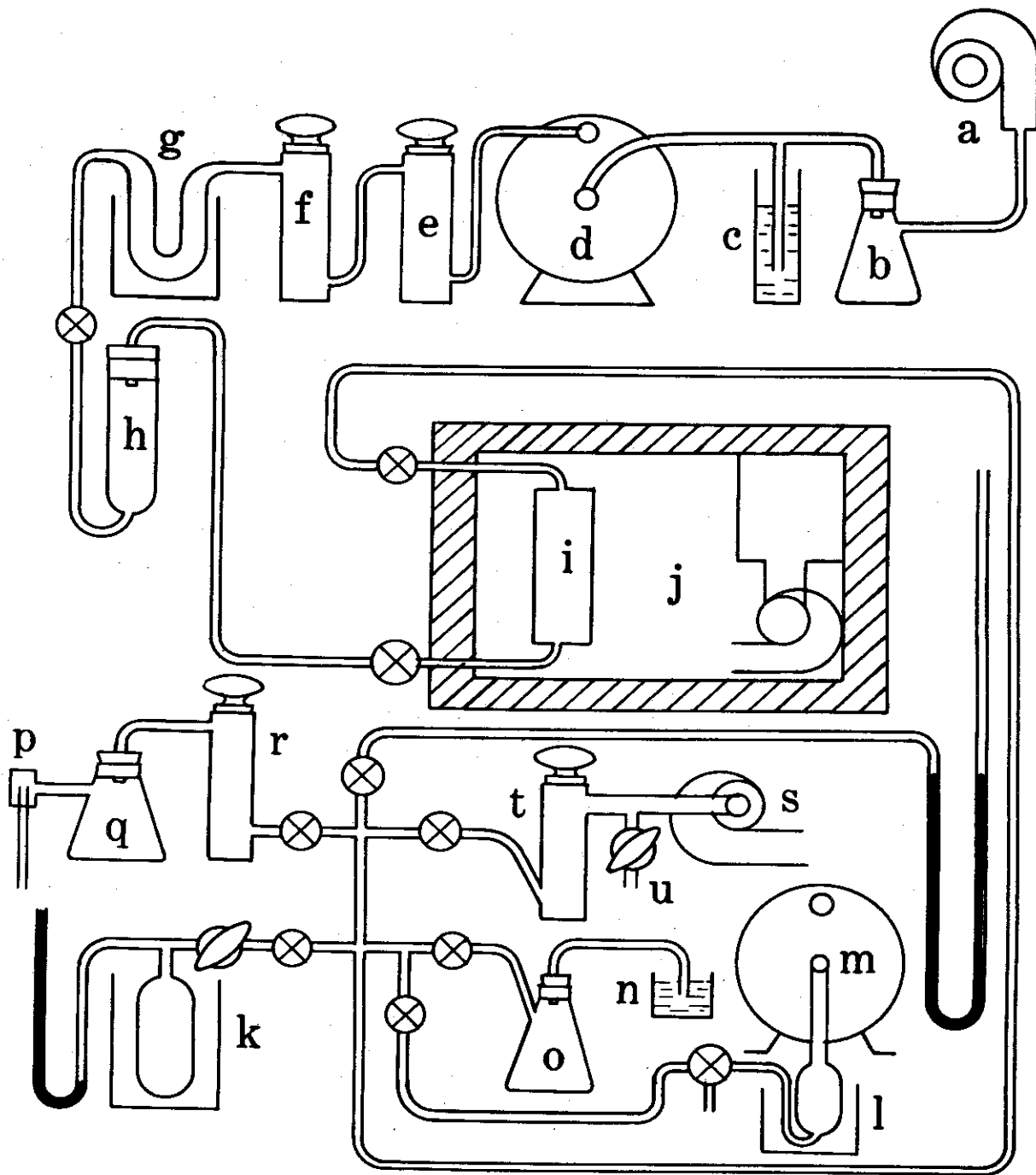

Figure 28. - Schematic diagram of the F-10 limit of flammability apparatus.

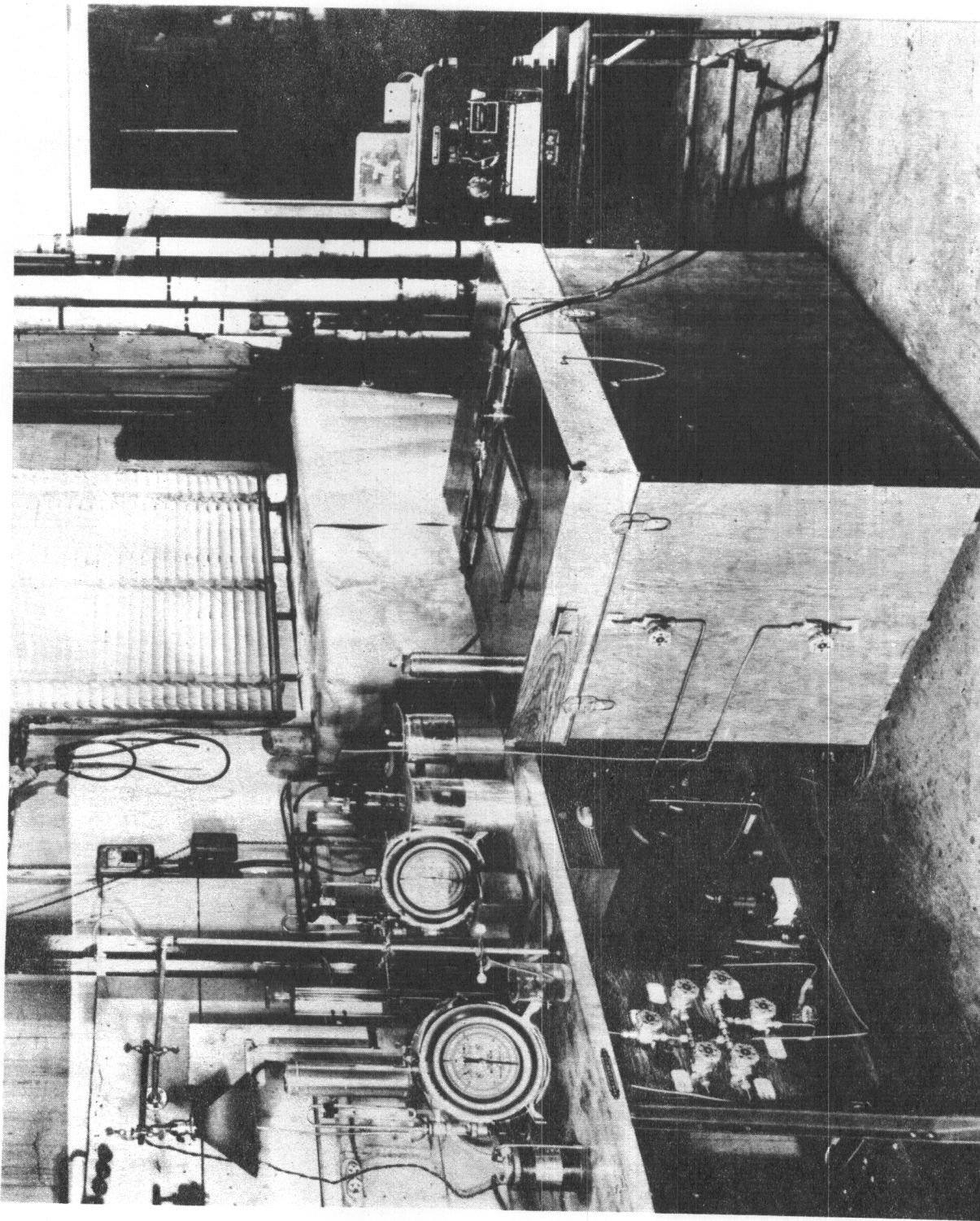

Figure 29. General view of the F-10 limit of flammability apparatus.

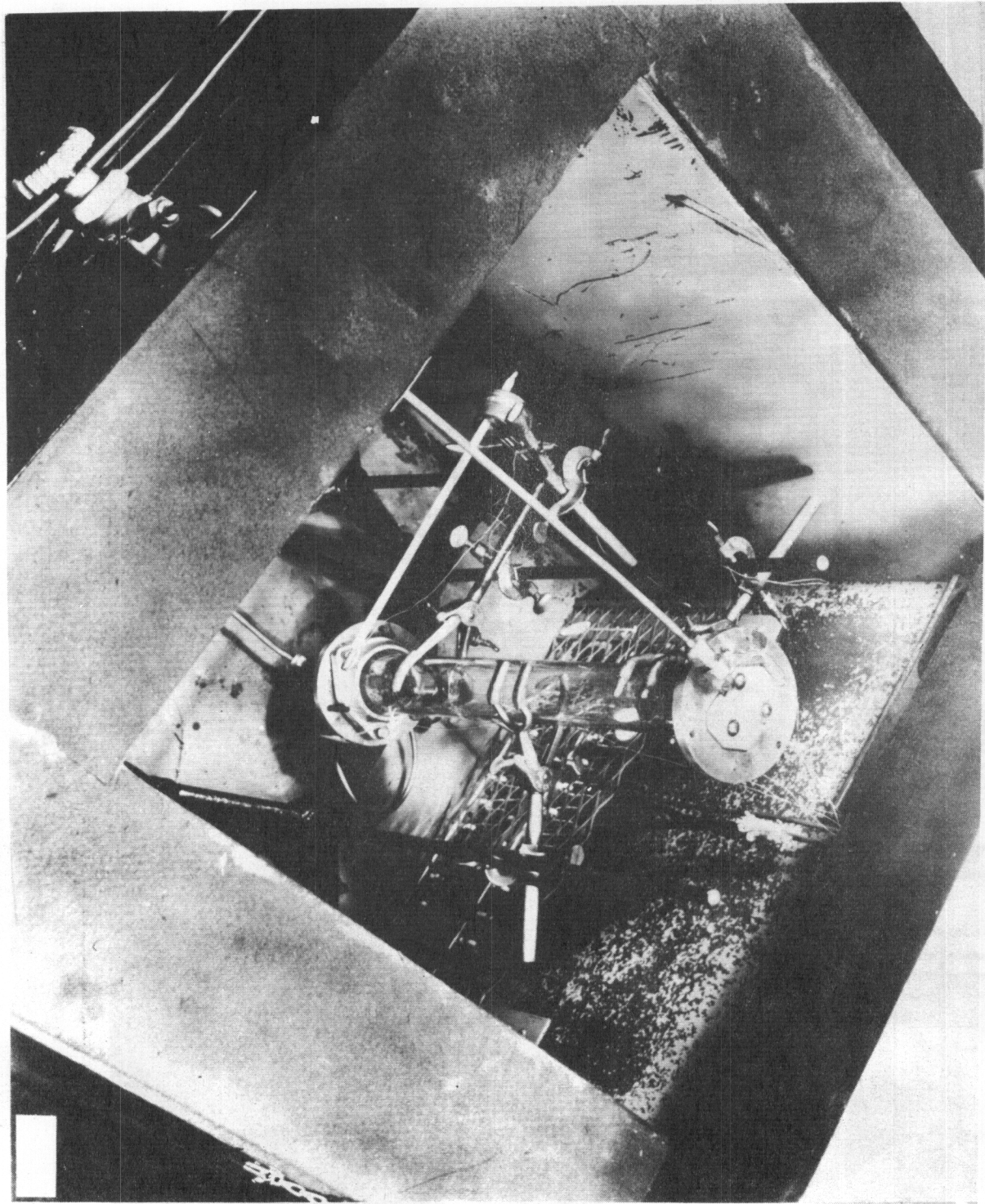

Figure 30. Close up view of the F-10 explosion chamber installed in the CO₂ cold chamber.

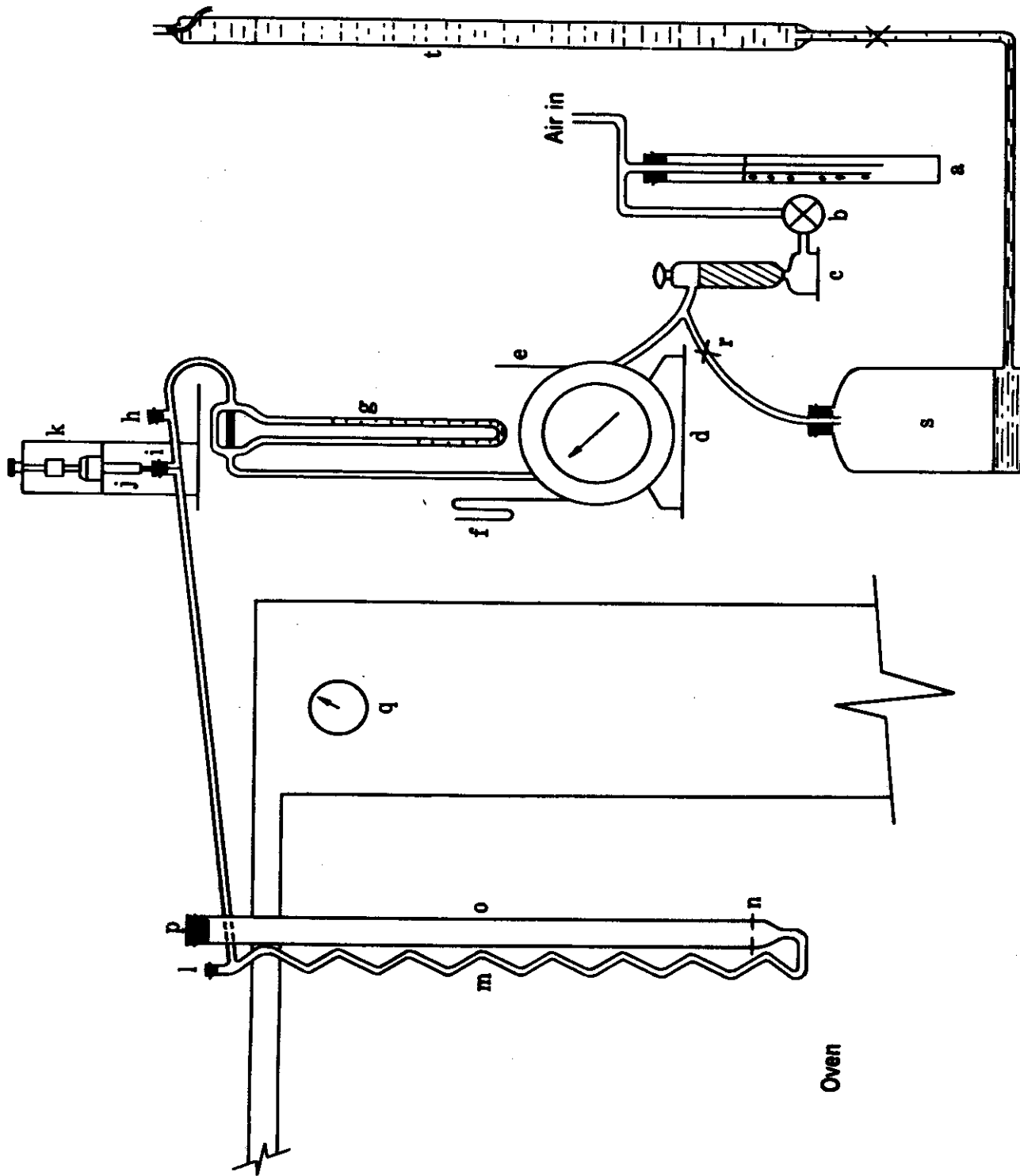

Figure 31. - Schematic diagram of the F-11 limit of flammability apparatus.

Figure 31 - Schematic diagram of the F-11 limit of flammability apparatus.

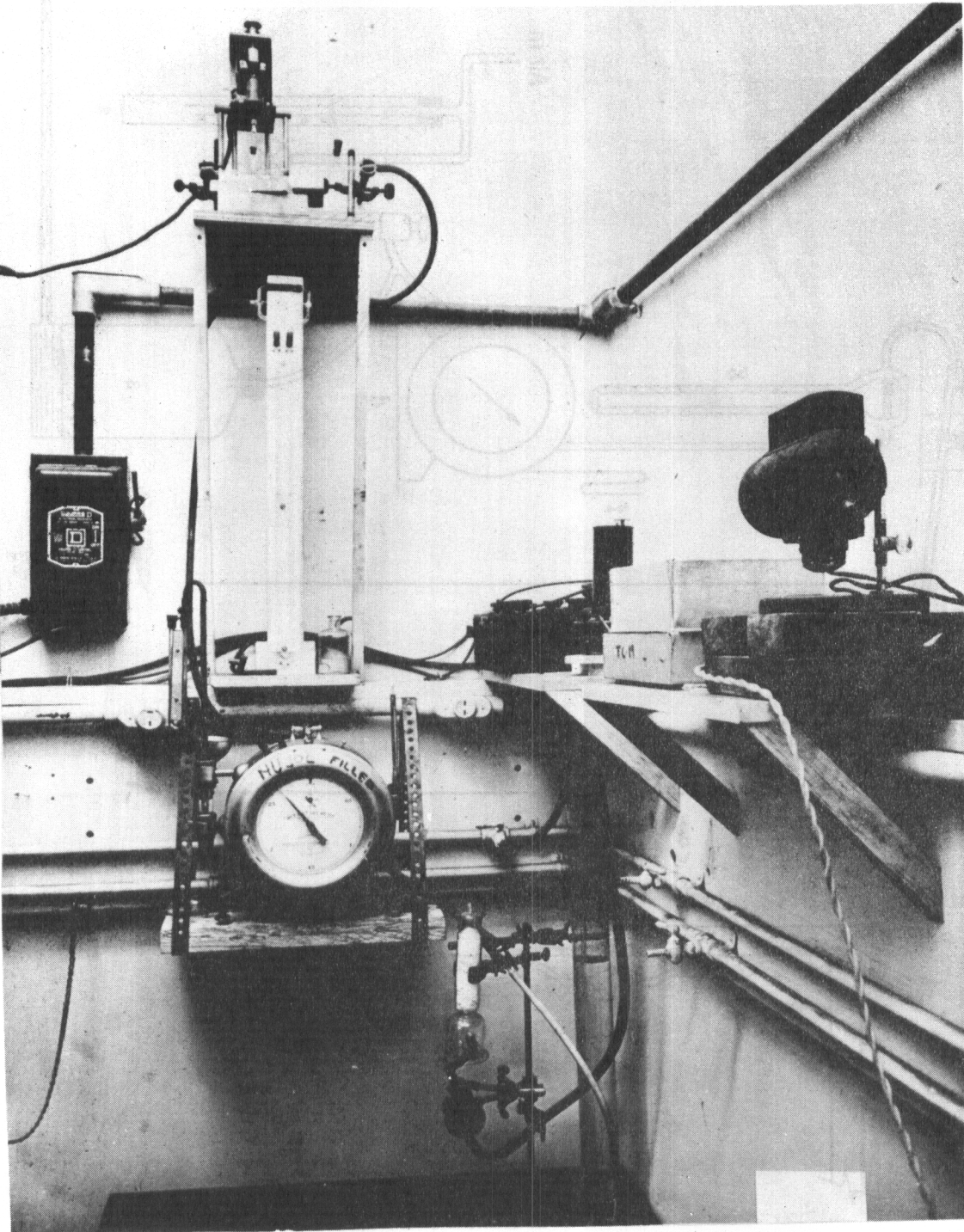

Figure 32. General view of the liquid feed device, air feed assembly, and photoelectric temperature controller (TC-19) used with the F-11 limit of flammability apparatus.

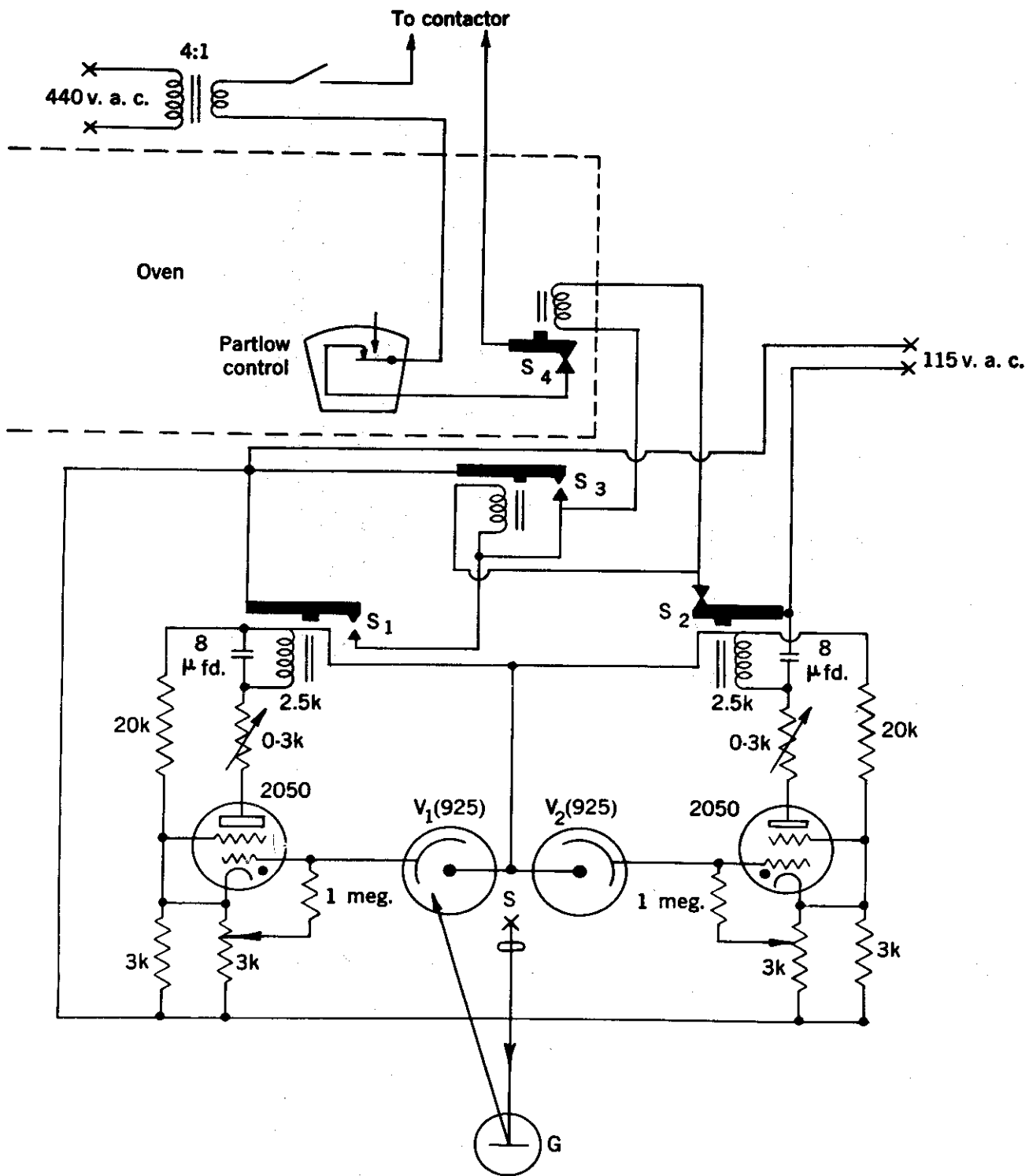

Figure 33. - Schematic diagram of the TC-19 photoelectric temperature controller used with the F-9 and F-11 limit of flammability apparatus.

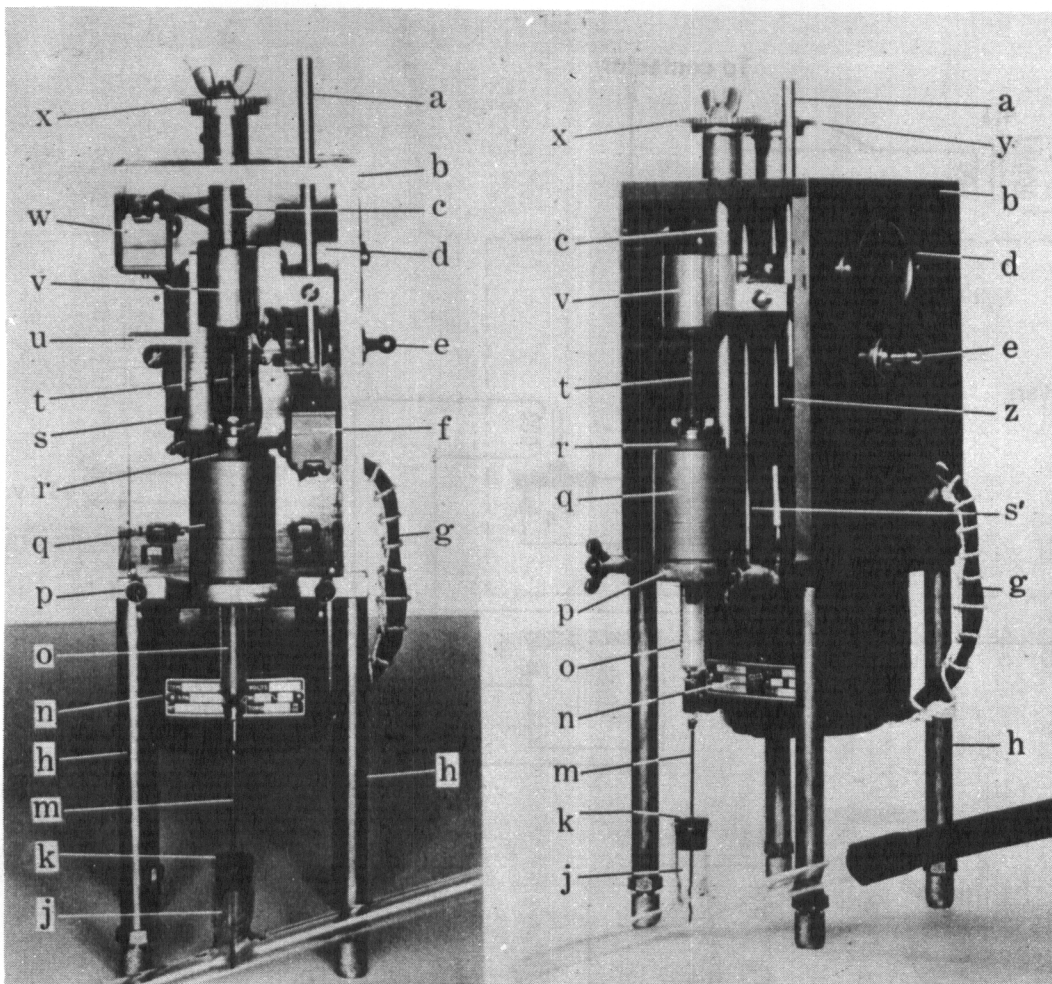

Figure 34a. - An improved model of of the liquid feed service used with the F-11 limit of flammability apparatus.

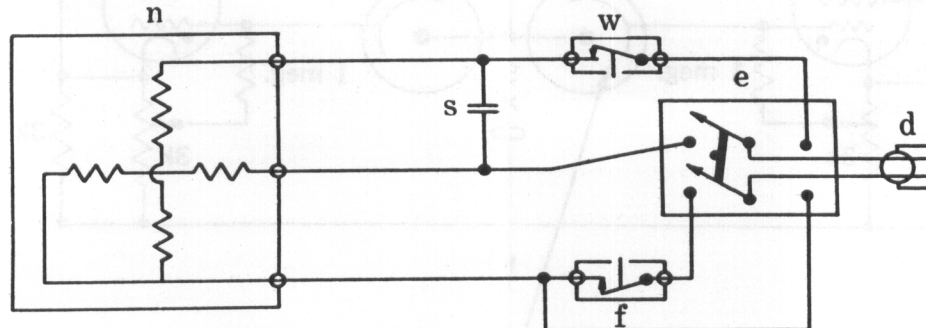

Figure 34b. - Schematic diagram of the electrical portion of the liquid feed device (improved model).

Contrails

4. Liquid-feed Device

- a. Drive unit
- b. Hypodermic syringe and needle
- c. Adapters

5. Air-feed Assembly

- a. Constant pressure device
- b. Wet-test gas meter and calibrator
- c. Flowmeter

6. Ignition source

- a. Electrodes
- b. Voltage source

1. Constant-temperature bath. An air bath is used to keep the explosion chamber and the vaporizer at a constant temperature. The air-bath housing consists of a large two-door commercial oven (working chamber dimensions, 37 x 25 x 50 inches). The oven is equipped with a 12-kw. low-gradient heater. A 3-phase motor (440 volt, 3/4 hp.) rotates a directly connected centrifugal fan which is statically and dynamically balanced. This fan circulates the air over the heater and through the oven chamber. The oven temperature is controlled by a mercury expansion off-on thermostat, which keeps the oven temperature within 5°F. of the desired temperature, from 100° to 500°F. Temperatures near the bottom, center, and top of the oven are recorded on three channels of a 12-channel electronic temperature recorder; three No. 20 B&S gage iron-constantin thermocouples are mounted directly on the explosion chamber.

Additional temperature control is provided by nine 1000-watt strip heaters installed in the recirculating duct of the oven; the temperature of these heaters is controlled by two variable autotransformers. The main (12 kw.) heater generally is not used for temperatures below 200°F.

A photoelectric temperature control (TC-19) is used to maintain the oven temperature constant to within $\pm 1/4^\circ\text{F}$. of any temperature from 100° to 500°F. This temperature control (Figure 33) is a modification of the one used by Roof (Ref. 22). The sensing element consists of a No. 36 B&S gage platinum wire wound into a 1-mm. helix, on a mica support (Ref. 31) placed near the top of the 12-kw. heater. Accordingly, the temperature controlled is that near the upper end of one side of the 12-kw. heater. However, as the recorded temperature is the oven temperature, by reading the record periodically, the control can be adjusted to give very satisfactory results even before a dynamic temperature equilibrium has been attained.

The platinum sensing element makes up one leg of a commercial wheatstone bridge. When the bridge is unbalanced by a change in the temperature of the platinum wire, current flows through an I&N galvanometer G (Figure 33)

Contrails

whose sensitivity is 0.045μ a per mm. This current rotates the galvanometer mirror so as to reflect the light from source S to photoelectric cell V_1 or V_2 , depending upon whether the temperature of the platinum sensing element is greater or less than the desired temperature. If the oven is too hot, S_1 closes; this closes S_3 , which in turn opens S_4 and S_5 , thus breaking the flow of current to the 12-kw. heater. If the oven is not hot enough, the reverse sequence of relay operations occurs, initiated by the opening of S_2 . S_4 , which is normally closed, makes it possible to use the apparatus at room temperature, or at elevated temperature if necessary, even though TC-19 (the photoelectric temperature controller) is inoperative. When TC-19 is in use, the Partlow mercury-expansion control is set at a temperature 3°F . above the desired oven temperature to provide a safety switch. Thus, if TC-19 becomes inoperative during a heating cycle, the temperature rises until the micro-switch in the Partlow control shuts off the 12-kw. heater.

In using TC-19, the oven is first brought to the desired temperature with the Partlow control. Then TC-19 is turned on and the wheatstone bridge is adjusted to give a null indication on the galvanometer at the desired temperature. The temperature record is examined periodically and the wheatstone bridge adjusted if necessary.

2. Explosion chamber. The explosion chamber is a cylindrical pyrex-glass tube with an inner diameter of approximately 50 mm. and a length of 4 feet. The combustible gas-air mixture enters the cylinder through an opening at the base. It moves up the cylinder at a rate of 3 to 15 inches per minute, depending on the rate of delivery of combustible and air to the system.

3. Vaporizer and mixer. The vaporizer and mixer consist of a continuous 8-mm. pyrex tube approximately 12 feet long. They are designed to insure thorough mixing of the combustible liquid with the air delivered to the vaporizer (Figures 27 and 32).

4. Liquid-feed device. The liquid-feed device (Figure 34*) consists of a drive unit housed in a brass body b, a hypodermic syringe o with a 4-inch No. 19 needle m, which is inserted in the vaporizer j, through a rubber stopper k, and a set of adapters r and q. The drive unit is made up of a 1-RPM fractional horsepower motor with built-in gear reducer n, 3 sets of interchangeable gears x and y, a machined feed screw 1/2-inch in diameter with 20 threads per inch c, and a driving head v, which moves the plunger t of the hypodermic syringe o. This driving head is kept from rotating by a guide rod s. Standard 1-cc., 2-cc., 5-cc., and 10-cc. hypodermic syringes are used. The syringes are mounted in brass adapters q, which in turn are mounted on the base p of the liquid-feed device. The same adapter is used for the 1-cc. and 5-cc. syringes so that a fiber sleeve r is inserted into q when the 1-cc. syringe is used. The length of the adapters can be adjusted so as to place the hypodermic syringe and needle in the proper vertical position. Once the proper position is found the adapter is locked by means of a fiber set screw. A limited amount of vertical positioning can be obtained also with height-adjustment screws on the four legs h of the liquid-feed

* The apparatus shown in Figure 34 is an improved version of the one used for the tests described in this report.

device; these are equipped with locking nuts, which keep them in place when the proper syringe position has been found. In practice it is much easier to make all height adjustments with the brass adapters than with the height-adjustment screws on the legs.

The vertical speed of the driving head depends primarily on the gears mounted on the drive shaft z and on the feed screw c. The distance between the centers of the drive shaft and the feed screw is constant (32 mm.). Therefore, assuming that the same size teeth are used on the gears, the only criterion for the choice of gears is that the sum of the teeth on each set of two gears be a constant. The available gear sets have a total of 120 teeth. Since the shaft speed of the motor is 1 rpm and the machined feed screw has 20 threads per inch, the rate of delivery of liquid by the liquid-feed device can be calculated for any particular hypodermic syringe and gear combination; gears with 40, 45, 60, 75, and 80 teeth are available.

The electrical portion of the liquid-feed device (Figures 34a and 34b) consists of a 115-volt AC receptacle shell d, a reversing switch e, a lower-limit microswitch f, actuated by an adjustable rod a, a cable g, a phase-splitting condenser S, and an upper-limit microswitch w, actuated by the upper-limit bar u.

5. Air-feed assembly. The air-feed assembly consists of a constant-pressure device, a wet-test gas meter with its calibrator, and a flowmeter.

The main element of the constant pressure device consists of a bubbler a placed just before a high resistance consisting of a CaCl_2 drying tower, the wet-test gas meter, and the orifice of the flowmeter.

The wet-test gas meter is a nujol-filled, 3 liter per revolution, wet-test gas meter. The meter calibrator is made from a glass tube similar to the one used for the explosion chamber. The flowmeter is essentially a water-filled manometer calibrated to give approximate rates of air flow (Figure 32).

6. Ignition source. The ignition source is composed of a pair of No. 20 B&S gage platinum-wire electrodes placed 3 inches from the base of the explosion chamber and spaced approximately 1/4-inch apart. The voltage source is a 15-kv., 30 ma. neon sign transformer. The primary of this transformer is connected to an autotransformer.

In determining the concentration limits of flammability of a combustible in the F-11 apparatus, one must first calculate the amount of combustible theoretically needed for complete combustion (T.C.C.). This has been done for the paraffin hydrocarbon series in paragraph 2.11.2. A rough rule that may be used in setting up the F-11 apparatus for many hydrocarbons is that the approximate values of the lower and upper limits of flammability are $0.5 \times \text{T.C.C.}$ and $3 \times \text{T.C.C.}$, respectively. Once these values and the specific gravity of the hydrocarbon are known, the proper hypodermic syringe, liquid-feed device gears, and flowmeter setting are chosen; one determination requires approximately 30 minutes.

Contrails

The first experimental step is the adjustment of the Nujol level in the wet test gas meter d, (Figure 31) until the calibration of this meter is accurate to within $\pm 0.35\%$.

The temperature of the explosion chamber o, is adjusted to within $1/4^\circ\text{F}$. of the desired value.

The air flow into the explosion chamber is adjusted to the desired rate (4 to 20 liters of air per hour). This is slow enough to permit the testing of the combustible-air mixture without fear of turbulence due to the air flow.

The proper gears are put in place on the liquid feed assembly k (this is determined by the choice of combustible and hypodermic syringe j).

The hypodermic syringe j is filled to a predetermined level (a fiber block is locked in place on the stem of the hypodermic syringe) and weighed on an analytical balance. The syringe is then mounted in an adapter which, in turn, is mounted in the liquid feed assembly. The stem of the syringe is locked in place on the driving mechanism of the liquid feed device, and the fiber block is removed. Liquid is fed into the air stream at point i (points h and l are used when more than one liquid is to be fed into the air stream) of the vaporizer m.

The motor of the liquid feed device k, and the electric timer q, are started (both are connected to the same electric on-off switch), and the wet-test gas meter reading is recorded.

After enough vapor-air mixture has passed through the explosion chamber to flush it completely six times, the perforated cover p is removed from the explosion chamber and a spark is passed through the vapor-air mixture. The results are observed visually. If only a flame cap is produced by the spark, then the mixture is considered nonflammable. If a flame travels uniformly at least two-thirds or more of the length of the explosion chamber without having a broken flame front, then the mixture is considered flammable. In general, a flame that travels two-thirds the length of the explosion chamber with a uniform flame front will travel the entire length of the explosion chamber. Flames which travel up the explosion chamber with a broken flame front seldom travel over two thirds the length of the tube; when they do, however, the test is repeated with the energy of the spark source decreased so that it does not create a turbulent mixture in the tube. If the flame still appears erratic, the concentration of the vapor-air mixture is changed slightly and the test again repeated so that the flame either does or does not travel at least two thirds the length of the explosion chamber.

The timer and the liquid-feed assembly are turned off, and the wet-test gas meter reading is recorded.

The pressure and temperature of the air in the wet-test gas meter are recorded.

Contrails

The hypodermic syringe and fiber block are again weighed on an analytical balance.

The composition of the vapor-air mixture tested is calculated as follows:

Percent combustible by volume in air (this is taken to mean the percent combustible by volume in the combustible-air mixture under conditions of normal temperature and pressure) at normal temperature and pressure (NTP) =

$$\frac{\left(\frac{\Delta w}{M} V\right) 100\%}{\frac{\Delta w}{M} V + \frac{\Delta v P' T}{P T'}} = \left(\frac{v_1}{v_1 + v_a}\right) 100\%$$

Δw = weight of sample fed into system in the time interval

$$t_{\text{final}} - t_{\text{initial}} = t_f - t_i$$

v_1 = volume of liquid vapor (NTP) corresponding to Δw
 Δv = volume of air at temperature T' fed into system in the time interval $t_f - t_i$

v_a = volume of air (NTP) corresponding to Δv

V = 22.4 liters

T = 273°K.

T' = temperature of air passing through the wet-test gas meter

P = 760 mm. of mercury

In general, a series of four to eight tests is required to determine the lower or upper limit of flammability of a combustible in air at any particular temperature and pressure. These limits are then plotted as abscissa against the temperature as ordinate.

The limits of flammability having been determined as the percentage by volume of combustible in air at NTP, they also may be expressed in terms of milligrams of combustible per liter of air (reduced to NTP), as follows:

$$L \left[\frac{\text{mg.}}{\text{liter(air)}} \right] = \frac{L(\% \text{ by vol. in air}) M}{\sqrt{100 - L(\% \text{ by vol. in air})} V}$$

V = 22.4 liters; M = molecular weight of the combustible.

The fuel-air ratio, F/A , at the limits of flammability may be determined from the limits expressed in terms of mg./liter as follows:

$$F/A = L \frac{\text{mg.}}{\text{l}} \times \frac{22.4 \text{ l}}{28.97 \times 10^3 \text{ mg.}} = 0.0007736 L \left(\frac{\text{mg.}}{\text{l}} \right)$$

where L must be expressed in mg./liter.

Contrails

If L is expressed on a percentage basis, then

$$F/A = \frac{L(\%)}{100 = L(\%)} \times \frac{M}{28.97}$$

Or, using the original weight data we can write:

$$L = \frac{\Delta w P T'}{\Delta v P' T} \frac{\text{mg.}}{1}$$

$$\text{and } F/A = 0.0007736 \frac{\Delta w P T'}{\Delta v P' T}$$

The accuracy of this experiment may be determined by considering each of the above factors as follows:

Loss of sample due to evaporation around the plunger of the hypodermic syringe and the point of connection of the needle to the syringe.

Handling losses during weighing. These include, in addition to evaporation, loss of sample from the end of the 4-inch No. 19 hypodermic needle.

It is important that the combustible sample be fed into the vaporizer m, at a uniform rate, and that vaporization of the sample from the vaporizer into the air stream should not only be constant but should occur at a rate equal to the delivery rate of the sample into the vaporizer. The constant rate of delivery of the sample to the vaporizer may be affected by several factors:

Change in the density of the sample during an experiment. (An air conditioning system is used to maintain the room temperature to within less than 2°F. of the desired temperature.)

Changes in the speed of the driving motor in the liquid-feed device k.

Variation in pitch of the driving screw in the liquid-feed device.

Large changes in the barometric pressure during an experiment.

Δv . This factor is obtained by means of a wet-test gas meter, which is calibrated against a secondary standard; therefore, the accuracy of Δv depends entirely on the accuracy of calibration of the wet-test gas meter.

To ensure a homogeneous gas mixture, the rate of delivery of air to the vaporizer also is important. This rate of delivery is maintained fairly uniform by means of a constant flow device, a flowmeter, and a valve (Figures 31 and 32).

P' and T' . The accuracy of the first term depends on the barometer that is used and on the manometer f that is attached to the wet-test gas meter d . The accuracy of the second term depends on the thermometer e used in the wet-test gas meter.

Laboratory variations in P' and T' produce only negligible deviations in the limits of flammability.

The variations in $\Delta w / \Delta t$ and $\Delta v / \Delta t$ are by far the most critical. The variations of $\Delta w / \Delta t$ depends, among other things, on the boiling point and surface tension of the combustible used and on the size of the hypodermic syringe. The losses of several combustibles were determined by performing all the steps enumerated in the above procedure without turning on the motor of the liquid-feed device. Losses of 2 to 5 mg. of sample were found in some cases, representing a loss of 0.5 to 1% of the sample. As the error in the wet-test gas meter reading may be of the same order, the experiments generally are accurate to within $\pm 2\%$, due to variations in the air and liquid supply. The over-all accuracy of the experiment should be within $\pm 3\%$, allowing for temperature and pressure variations.

APPENDIX VI

The F-12 Limit-of-Flammability Apparatus

The F-12 is basically the same as the F-1 apparatus (Appendix I). It differs from the F-1 apparatus in that its explosion chamber is housed in a 30 cubic foot cold chamber similar to the 8 cubic foot chamber used in conjunction with the F-10 apparatus (Appendix IV), and it uses a two-stage automatic mixer similar to the one used with the F-24 apparatus (Appendix VIII). The 30 cubic foot cold chamber used with this apparatus has a working chamber height of 5 feet. The data obtained with this apparatus is similar to the data obtained with the F-1 apparatus except that it is obtained at low temperatures.

APPENDIX VII

The F-21 Temperature Limit-of-Flammability Apparatus

The F-21 apparatus is similar to the F-9 apparatus described in Appendix III except that its explosion chamber has an inside diameter of 4 inches. It is housed in the same oven as the F-9 apparatus and uses the same type of saturator.

APPENDIX VIII

The F-24 Concentration Limit-of-Flammability Apparatus

The F-24 is basically similar to the F-1 apparatus (Appendix I). It differs from the F-1 apparatus in several details (Figures 35 and 36). First of all, the mixture to be tested is mixed in a 20-liter gas bottle j (Figure 35) so that several low pressure tests may be made on one mixture in the 4-inch diameter explosion chamber a. Secondly, the mixing device is automatic consisting of mercury pumps g' and f' which are operated by raising and lowering mercury bottles g and f. Bottles g and f are raised and lowered by cross arm e which is coupled to a drive mechanism by means of a solid steel link. The drive mechanism consists of an electric drive motor, a gear reducer and an offset drive shaft (Figure 36). The remainder of the apparatus is similar to the F-1 apparatus as may be seen by comparing Figures 35 and 24.

APPENDIX IX

Spray and Mist Apparatus

Three types of apparatus have been used for these investigations. The first type (for mists) consists of an apparatus similar to the F-9 (Appendix III). The combustible to be misted is vaporized into the evacuated explosion chamber which is kept at a low temperature. Air at a low temperature is then mixed with the vapor, thus forming the desired mist. The mist temperature can be controlled by varying the vapor and the air temperatures.

The second apparatus (F-26 spray apparatus, Figures 37 and 38) is a continuous flow setup which uses a two-fluid nozzle to generate the sprays to be tested. The schematic diagram (Figure 37) of this apparatus lists all the components used in making spray ignition tests. It consists basically of 5 components: a source of supply of air, a source of supply of fuel, a two-fluid nozzle, a test chamber and an ignition source. Rotameters are used to measure the flow rates of the air and fuel fed to the two-fluid nozzle which produces the spray. The spray is forced into the test chamber where it is tested by passing a number of sparks through it at various points in the test chamber. An electronic photo timer, an autotransformer (variac), a luminous tube transformer and a set of spark electrodes make up the ignition system used with this apparatus. Auxiliary apparatus used in conjunction with the F-26 apparatus include droplet size measurement apparatus such as collectors, microscopes and photoelectric microphotometer.

The third apparatus (F-27 spray apparatus, Figure 39) is a solid injection type consisting of a hand pump and nozzle to produce the spray, and a high voltage spark apparatus to test the ignitibility of the spray. The hand pump is an American Bosch nozzle test stand (APFH 1B-100B-S51), the nozzle holder an ARB35 Bosch holder, and the nozzle an ADN852 Bosch nozzle, set to open at a pressure of 3500 pounds per square inch.

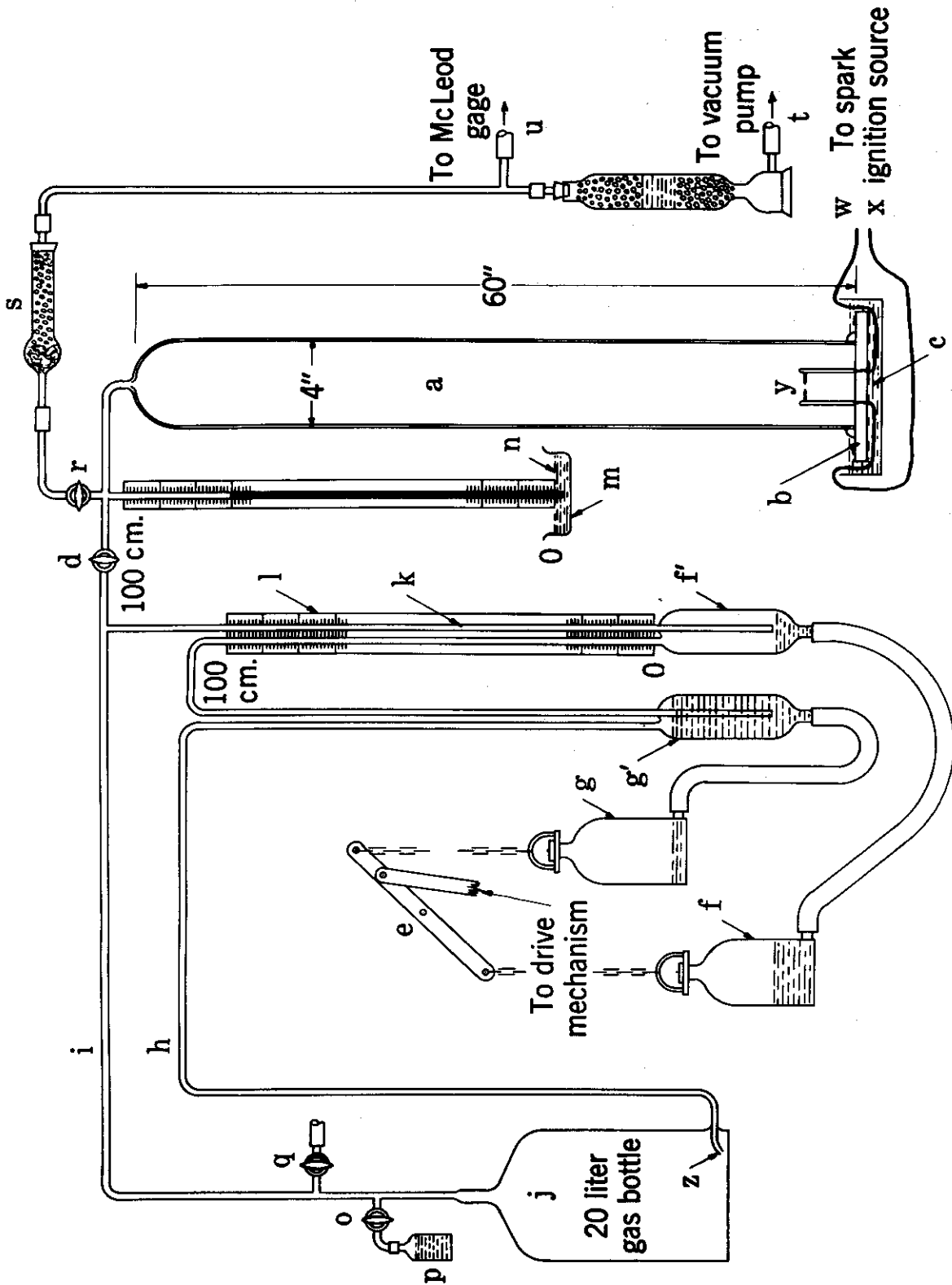

Figure 35. - Schematic diagram of the F-24 limit of flammability apparatus.

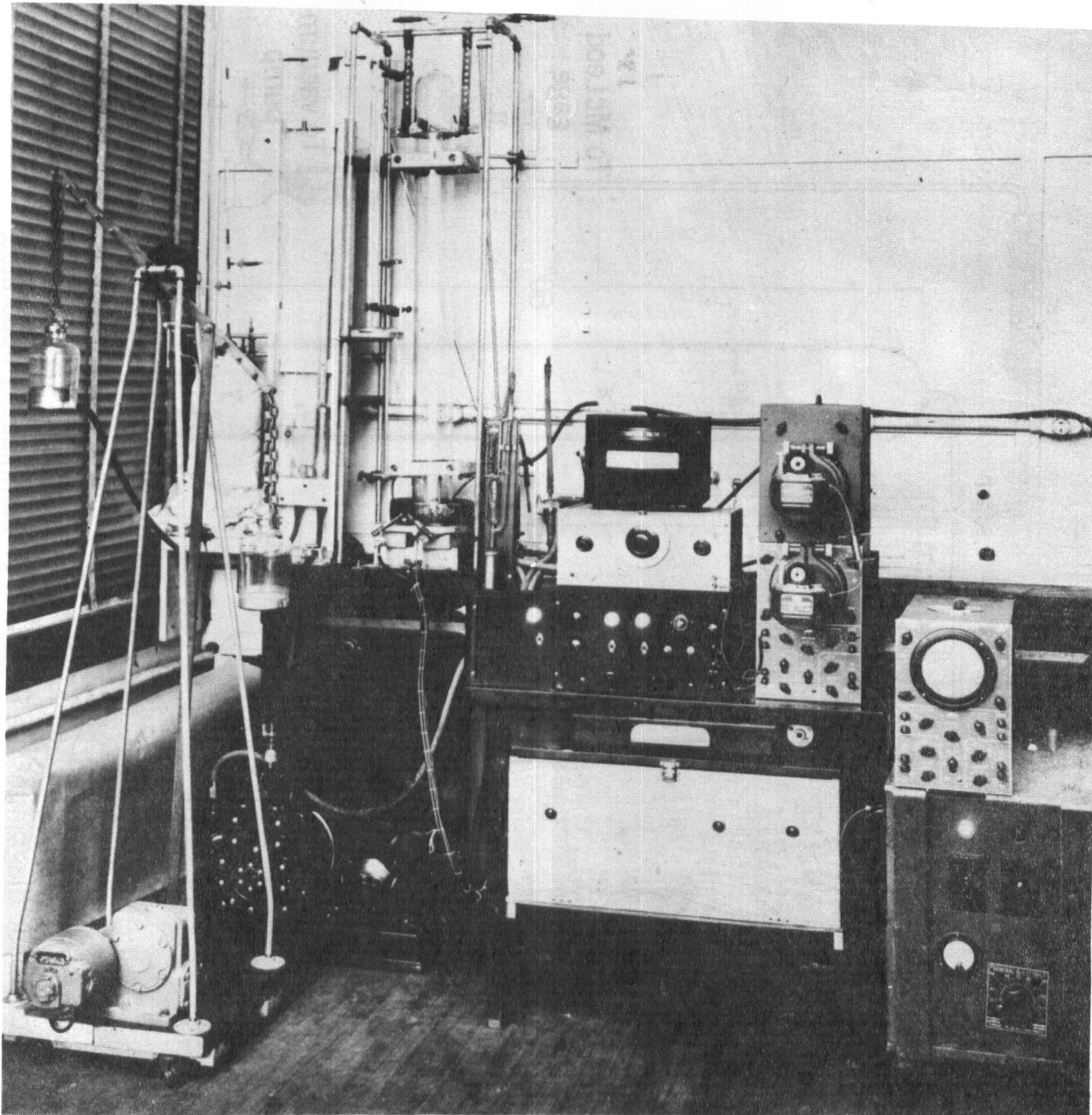

Figure 36. General view of the F-24 limit of flammability apparatus with the surge generator and its associated measurement apparatus in place for an actual test.

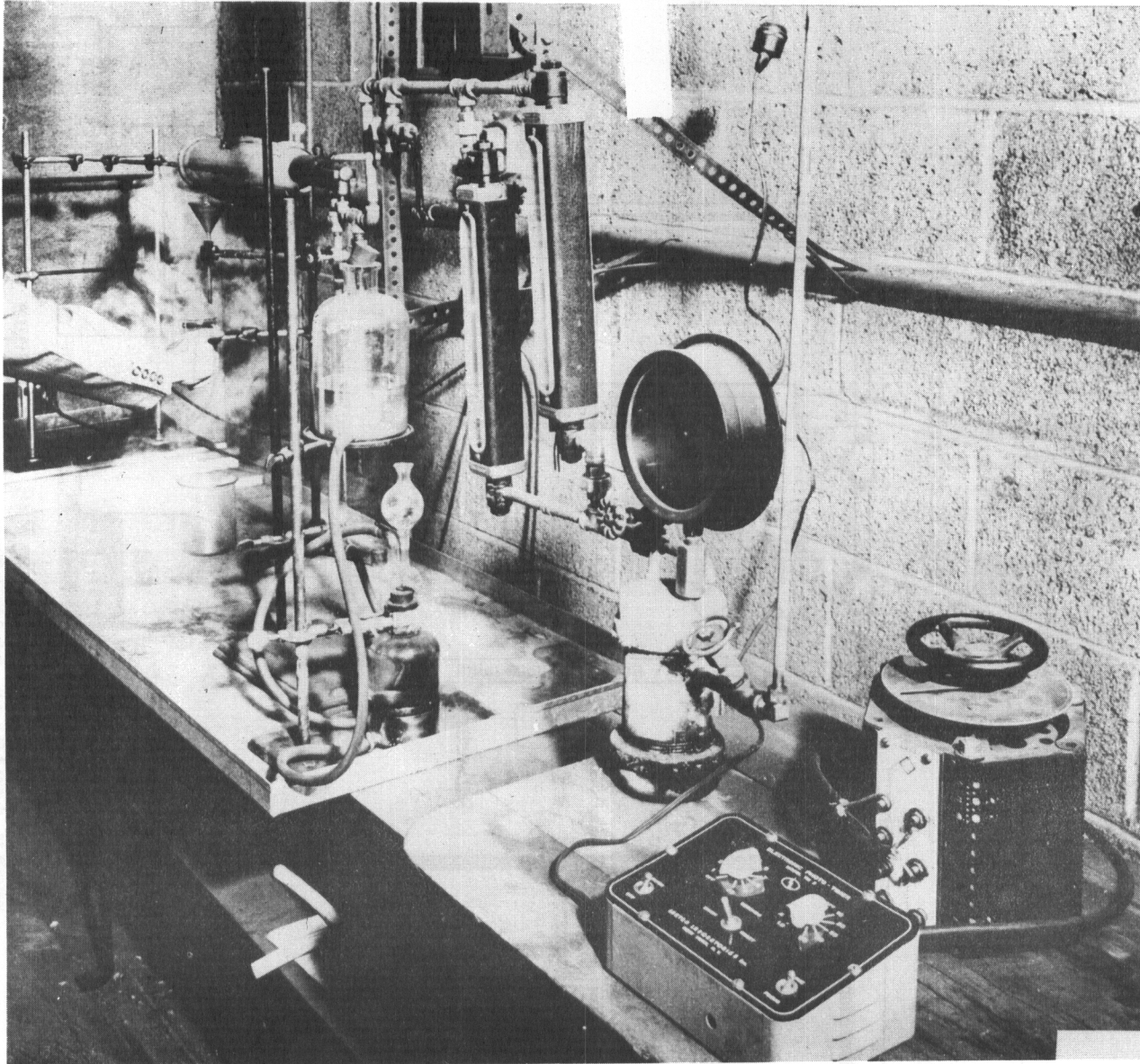

Figure 38. The F-26 continuous flow type spray ignition apparatus.

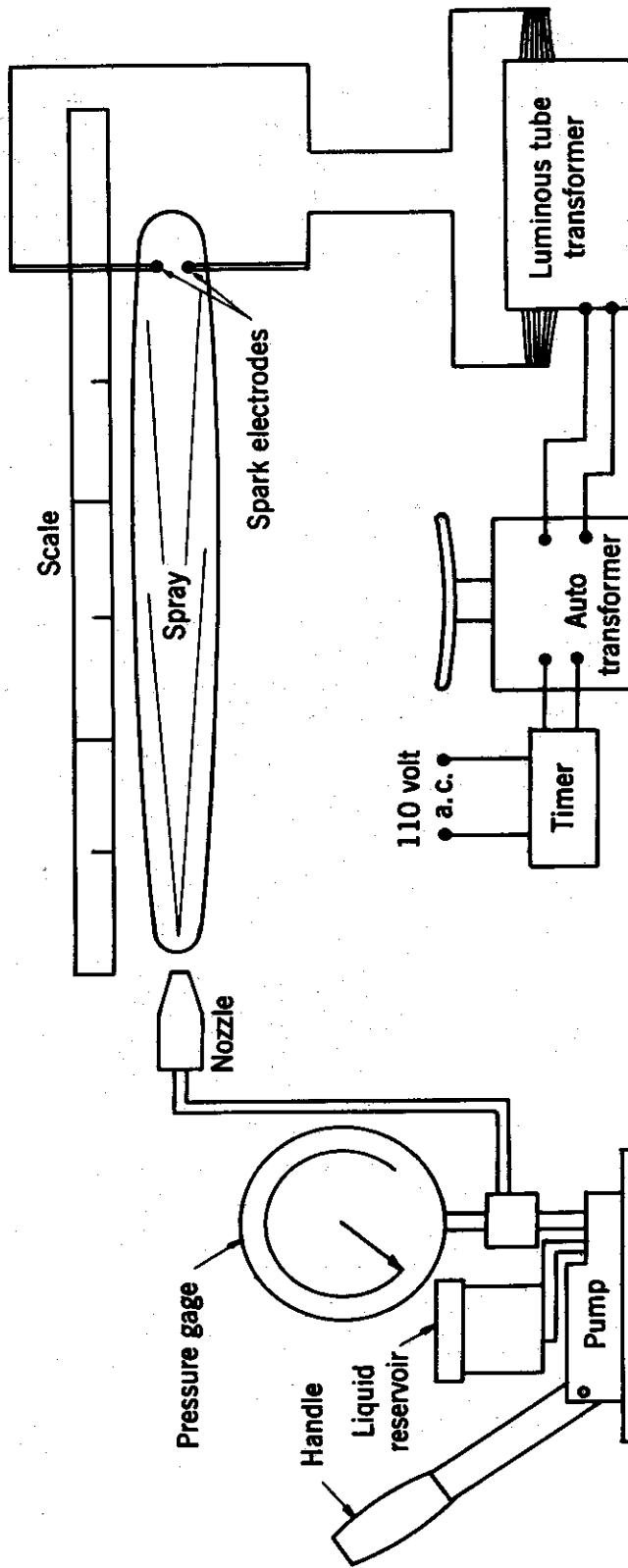

Figure 39.—Block diagram of the F-27 solid injection type spray ignition apparatus.

The ignition apparatus consists of an electronic timer, an autotransformer, a 15 kv., 30 ma. luminous tube transformer and a set of spark electrodes. The secondary terminals of the luminous tube transformer are connected directly to the spark electrodes which are made of either 1/8-inch brass welding rod or of 18-gage tungsten wire. The procedure involves first the initiation of a spark between the electrodes and second the production of a single burst of spray in a fixed direction. This procedure is repeated for a number of spark electrode positions and spark power outputs in order to determine the regions of ignitibility of the spray.

APPENDIX X

Ignition Sources

A number of ignition sources were employed during this investigation. These sources included Ford spark ignition coils, heated wires, guncotton, sparks produced by discharging a condenser, luminous tube transformers, and a surge generator which proved to be the most efficient. However, for altitudes to approximately 65,000 feet, a 15 kv., 30 ma. luminous tube transformer is quite efficient. A 15 kv., 60 ma. luminous tube transformer works nicely to approximately 70,000 feet. A surge generator has been used for ignition at altitudes in excess of 80,000 feet.

The surge generator used at the U. S. Bureau of Mines consists of 6 basic components (Figure 40).

1. Power supply
2. Surge generator
3. Delay network
4. Surge clipper
5. Voltage and current measurement circuits
6. Associated power supplies and calibrating circuits

1. Power supply: The power supply (Figure 41) is a conventional supply built to charge the surge generator capacitors to any potential up to 20,000 volts in approximately 3 seconds. The output voltage is adjustable over the entire range 0 to 20,000 volts by means of a variable autotransformer placed on the primary side of the high voltage transformer. The charging voltage is measured with an electrostatic voltmeter and kept constant during a series of tests in order to make it more nearly possible to obtain sparks from the surge generator of constant energy content. The initial surge of charging current is limited by a suitable high voltage charging resistor.

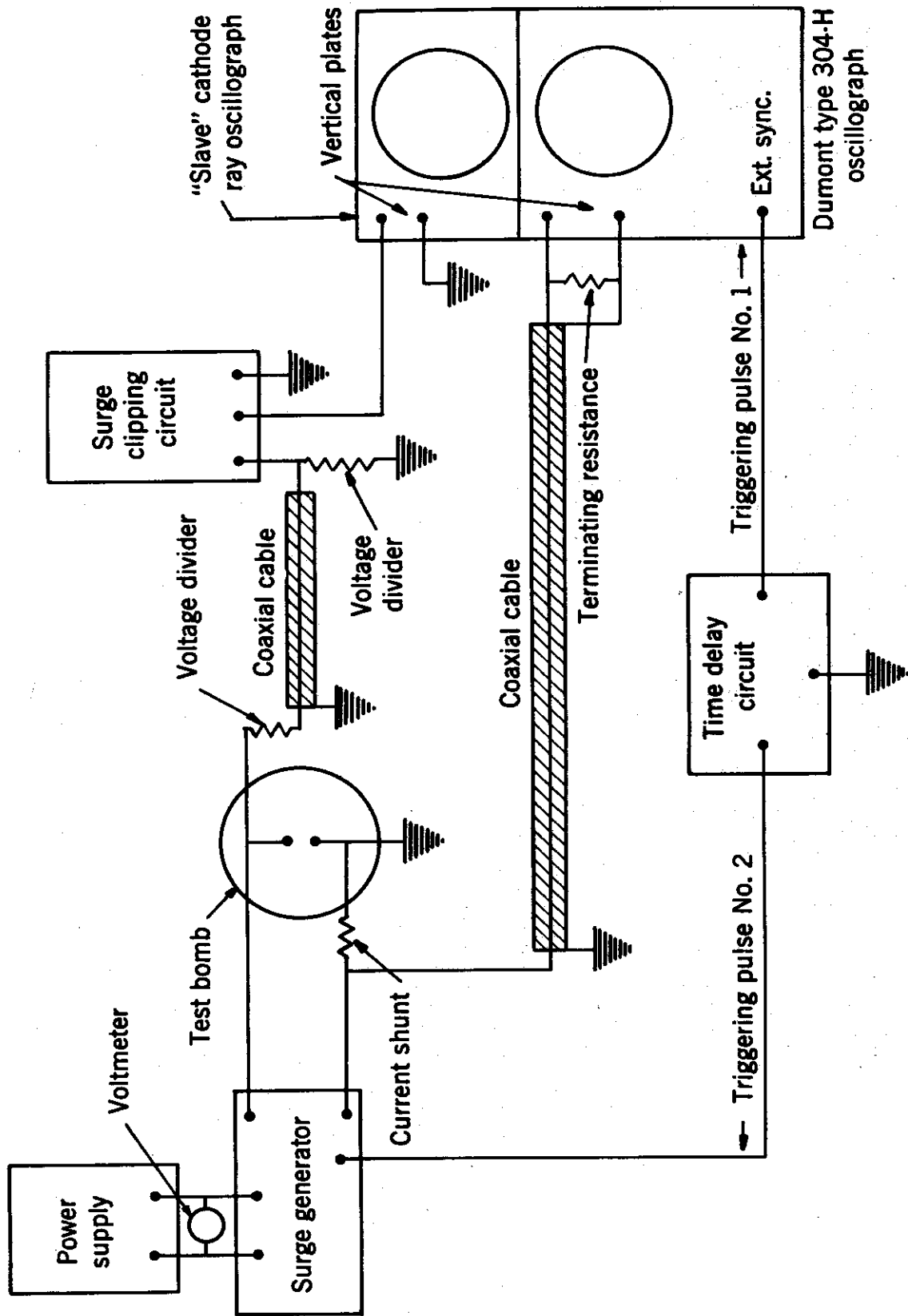

Figure 40.—Block diagram of the U. S. Bureau of Mines surge generator and spark ignition energy measurement apparatus.

Contrails

2. Surge generator: The surge generator (Figure 41) is composed primarily of a capacitor, series inductance and resistance, and shunt resistance. The values of these circuit elements are so chosen as to deliver a spark of the proper energy content, duration, and wave shape that is desired for a given application. An over-damped, or non-oscillatory wave is generally used. The capacitor (or capacitors) is charged to a steady voltage by the power supply and then discharged by means of a small triggering pulse applied to the triggering gap. The surge voltage appears across the shunt resistance (which is also the voltage divider) and the spark gap (in the explosion chamber) which then sparks over. The capacitor is the energy storage element, but over 99% of its energy is dissipated in the resistors. A good grade of oil-filled mica capacitor is used which is capable of withstanding 20,000 volts and having low internal resistance and inductance. A series inductance is used to reduce the initial rate of rise of voltage across the gap and also the rate of rise of discharge current through the gap. These features help to insure more consistent sparking of the gap and more reliable voltage measurements by the non-inductive resistors, which might give erroneous results with a steep-front wave. The series resistance (part of which is the current shunt) is adjustable so as to vary the maximum surge current and duration of the spark. This resistance may be varied along with the capacitor in various ways to change spark energy and duration more or less independently. All the resistances used are of the wire-wound, non-inductive type.

3. Delay circuit: In order to be able to display on the oscilloscope screens the traces of spark voltage and current, it is necessary to delay in some way the signal representing these values by the time required to initiate the sweep pulse and permit an inch or so of travel on the linear part of the sweep. This is accomplished by means of a time delay circuit (Figure 42), which produces two pulses with an adjustable time interval between them. The first pulse, a low voltage one, triggers the sweep when the "delay trip" button is depressed, and the second pulse, a high voltage one, triggers the surge generator and the test gap breaks down almost instantaneously. The triggering gap of the surge generator is "sensitized" by means of radioactive material to make it operate consistently.

4. Surge clipping circuit: The voltage required to spark-over the bomb gap and to deliver the required current may be 100 to 200 times the minimum arc voltage existing across the gap after breakdown. It is desirable to obtain on the screen of the cathode ray tube a reasonable deflection representing this arc voltage, which is of the order of 50 volts. At the same time, the tube must be protected against the pre-breakdown voltage, which may be several times the voltage rating of the deflecting plates, which is 1000 volts in the case of the 5CP11-A tube in the Dumont 304-H oscilloscope. This protection is accomplished by means of the clipping circuit (Figure 43). The clipping tube is a diode biased so as to clip off all of that portion of the voltage wave above 1000 volts, but to leave undisturbed that portion which is less than 1000 volts, which is a range sufficient enough to record all oscillograms encountered thus far. The cathode-ray tube is so designed that voltages may be applied up to six times that represented by the on-screen trace, without distorting the on-screen deflection.

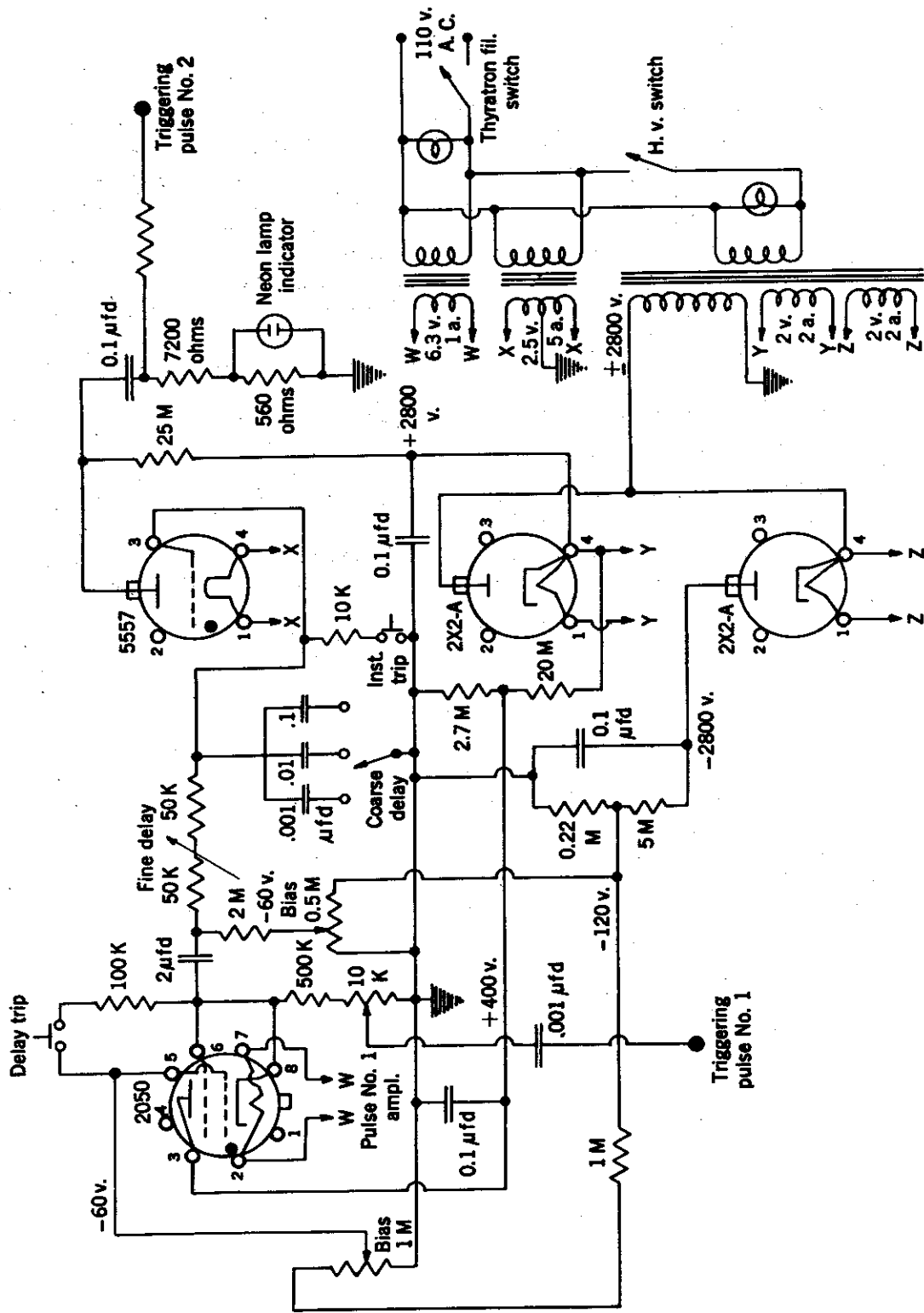

Figure 42.—Circuit diagram of the dual-pulse time delay network for synchronizing the surge generator and the oscillograph sweeps.

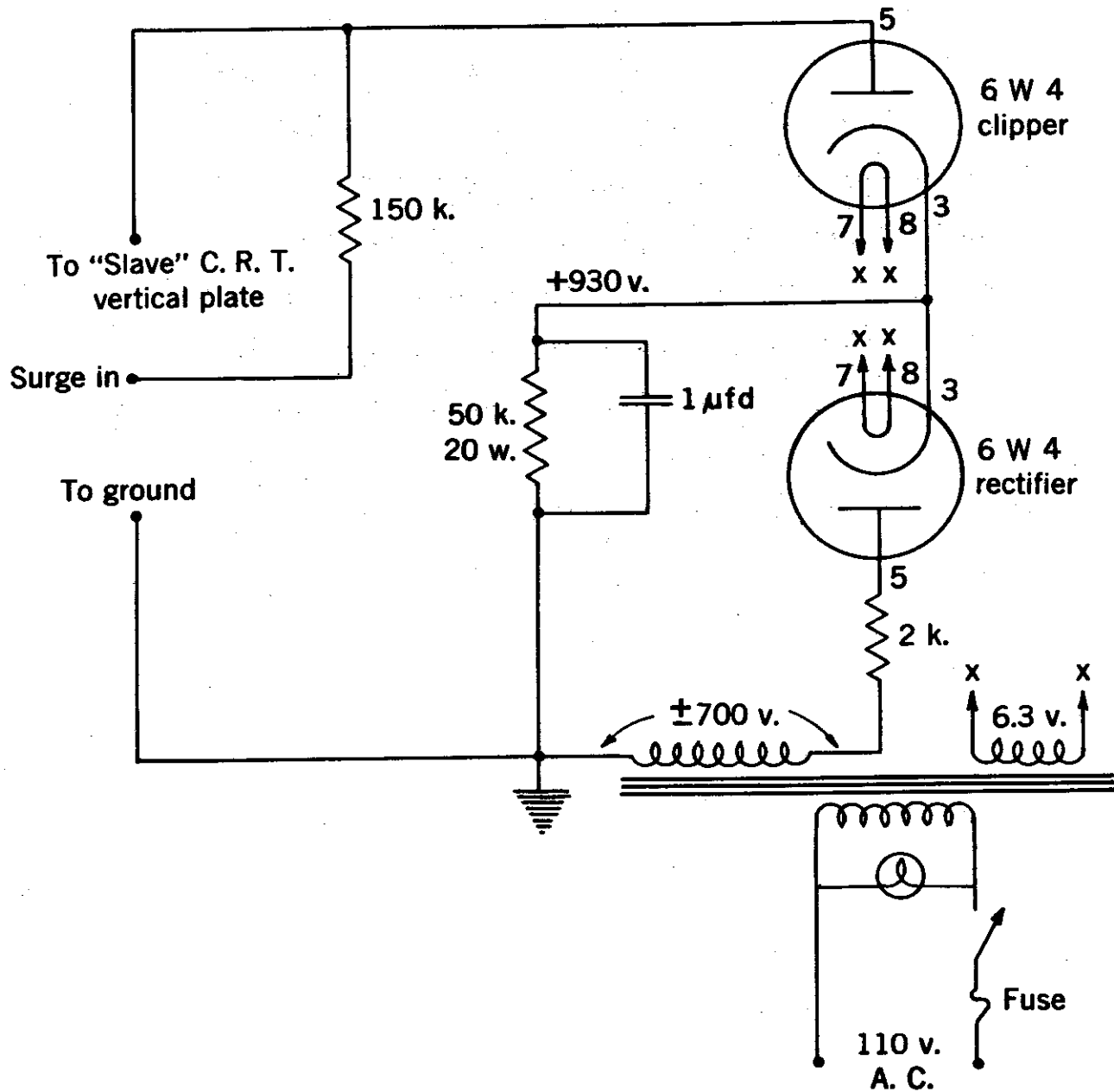

Figure 43.—Circuit diagram of the surge clipper.

5. Voltage and current measurement circuits: The surge voltage across the test gap was measured with a voltage divider composed of non-inductive resistors totaling about 8000 ohms; this value was chosen so as to be substantially larger than any series resistance which might be placed in the surge generator. This divider was divided into two parts, one being at the gap end of the coaxial cable and the other part being at the oscillograph end. The oscillograph plates were connected across this second section so that the oscillograph observed about half the voltage appearing at the test gap. With the transients observed to date it has not been necessary to terminate the voltage cable with its characteristic impedance, thereby making it possible to couple directly to the plates of the oscillograph without the use of amplifiers.

The current through the test gap is likewise measured with a suitable non-inductive resistor and the signal transmitted to the oscillograph through a coaxial cable. This cable was terminated by its characteristic impedance of 75 ohms.

The non-inductive resistors used were of the power wire-wound type, having zero voltage and temperature coefficients of resistance under the experimental conditions. Both manufacturer's specifications and a check with a radio-frequency bridge confirmed the excellent frequency response of these resistors, the impedance being equal to the D.C. resistance up to one megacycle, with less than one percent deviation. One megacycle is somewhat higher than the highest harmonic which might be derived from analysis of the impulses reported here, so these resistors are considered satisfactory for the measurements undertaken in conjunction with the ignition energy work described in Section 3.3.

The basic oscillograph used to record the oscillograms reported here was a Dumont 304-H. An auxiliary, or "slave" oscillograph (Figure 44), was built having a common sweep signal with the 304-H, or "master" unit. This made it possible to record simultaneously oscillograms of voltage and current as a function of time. Two Dumont Type 296 cameras were used to record the oscillograms, all on 35 mm. Super XX film. It is considered that more accurate and more easily interpreted results can be obtained by plotting current and voltage against time separately than by plotting current against voltage. The "slave" unit has independent position, focus, and intensity controls. As mentioned previously, the signals were coupled directly to the vertical deflection plates, so there is no problem with gain and response of the vertical amplifier.

Frequently, during a series of tests, it is necessary to calibrate the X-axis, or time base, of the oscillograms. For this calibration a sine wave is double exposed on the oscillograms by means of an accurate signal generator connected through the vertical amplifier. The calibration, conveniently expressed in microseconds per inch, changes very little during the course of a day for a given setting of sweep and horizontal gain controls.

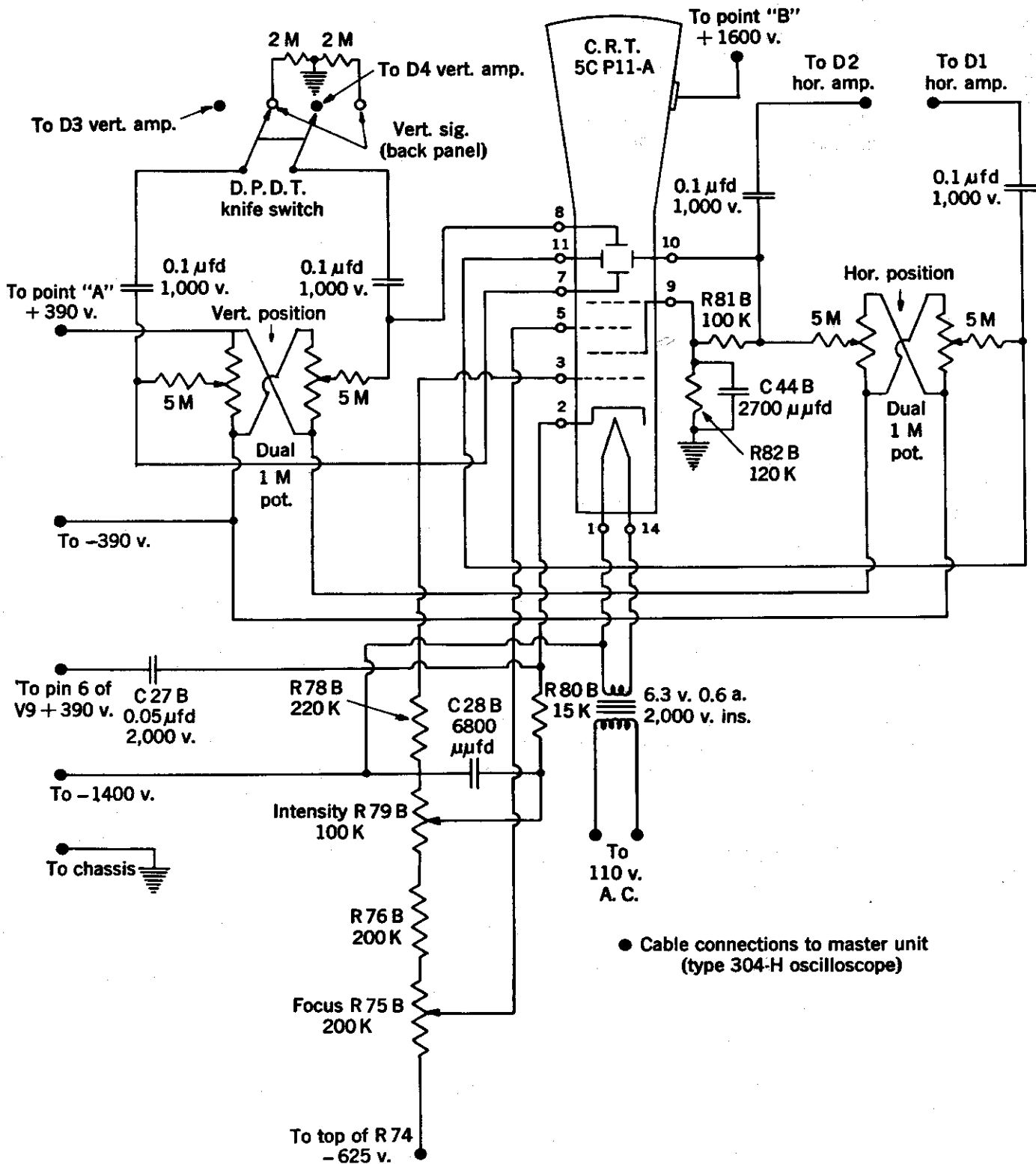

Figure 44.—Circuit diagram of the "Slave" cathode-ray oscilloscope to operate with Dumont type 304-H oscilloscope.

Contrails

Calibration of the Y-axis is accomplished by taking a series of oscillograms of 60-cycle voltages applied directly to the vertical plates, and measured with an accurate 60-cycle voltmeter. This calibration can be made to about $\pm 1\%$ and does not change over a long period of time. A.C. must be used instead of D.C. because of the capacitor coupling that is necessary in the oscillograph circuits to block the D.C. positioning voltages. The background illumination on the screen can be adjusted so that the ruled grid can be superimposed on the oscillograms for purposes of measurement.

7. Voltage and current surges: A typical voltage and current surge produced by a simplified surge generator is given in Figure 45. The surge parameters used for the actual and theoretical waves are given in the insert.

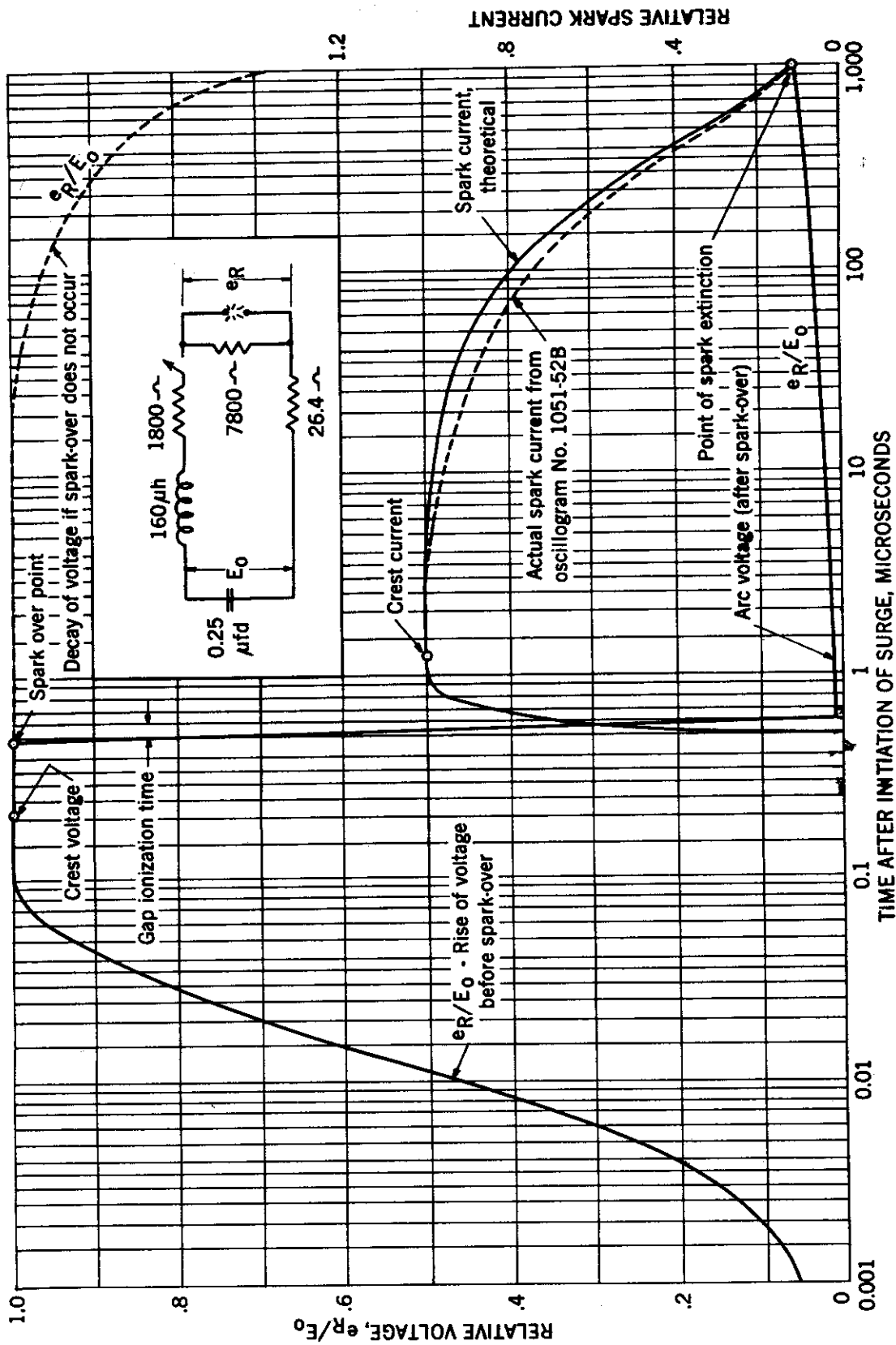

Figure 45.—Typical surge waves of voltage and current generated by the U. S. Bureau of Mines surge generator (cf. insert).

Contrails

INDEX

	Page
Apparatus	
F-1, concentration limit of flammability - - - - -	52
F-9, temperature limits of flammability - - - - -	56
F-10, temperature limits of flammability - - - - -	59
F-11, concentration limits of flammability - - - - -	59
F-12, limit of flammability - - - - -	73
F-21, temperature limit of flammability - - - - -	73
F-24, concentration limit of flammability - - - - -	74
F-26, spray apparatus - - - - -	74
F-27, spray apparatus - - - - -	74
I-8, ignition temperature - - - - -	54
Ignition sources - - - - -	80
Aviation gasoline, grade 100/130	
ASTM distillation curve - - - - -	2
in air, concentration limits of flammability at 0°F., discussion - - - - -	26
in air, concentration limits of flammability at 78°F. - - - -	20, 21
in air, equilibrium concentration limits of flammability - -	28
in air, limits of flammability, table - - - - -	26, 27
in air, low pressure ignitibility curves - - - - -	37, 38
in air, minimum SIT, table - - - - -	39
Reid vapor pressure curve - - - - -	3
Aviation gasoline, grade 115/145	
ASTM distillation curve - - - - -	2
in air, concentration limits of flammability at 78°F. - - - -	22, 23
in air, equilibrium concentration limits of flammability - -	29
in air, limits of flammability, table - - - - -	26, 27
in air, limits of ignitibility - - - - -	36
in air, minimum SIT, table - - - - -	39
Reid vapor pressure curve - - - - -	3
Aviation hydraulic fluid AN-O-366	
in air, minimum SIT, table - - - - -	39
in air, variation in SIT with time lag - - - - -	41
Aviation jet fuel, grade JP-1	
ASTM distillation curve - - - - -	2
in air, droplet sizes - - - - -	43
in air, equilibrium concentration limits of flammability - -	30
in air, formation of mists - - - - -	40
in air, formation of sprays - - - - -	40
in air, limits of flammability, table - - - - -	27
in air, lines of equilibrium ignition probability for sprays in a horizontal plane - - - - -	45
in air, minimum SIT, table - - - - -	39
in air, variation in SIT with time lag - - - - -	41
Reid, vapor-pressure curve - - - - -	3

INDEX

	Page
Aviation jet fuel, grade JP-3	
ASTM distillation curve	2
in air, concentration limits of flammability at 79°F.	24, 25
in air, equilibrium concentration limits of flammability	31
in air, limits of flammability, table	26, 27
in air, minimum SIT, table	39
in air, variation in SIT with time lag	41
Reid vapor-pressure curve	3
Bibliography	49
Burning process associated with combustibile droplets	11
Butane in air, ignitibility curve	8
Conclusions	47
n-decane in air, lower limit of flammability	15
Energy measurements, spark ignition	32
Explosive limits, definition	6
Flammability characteristics of combustibile gases and vapors,	
definition	11
Flammable gaseous mixtures, combustion of	14
Flammable volume, general form	13
Flash point	9, 10
Fuels	1
Future investigations	46
Gaseous mixture, definition	
flammable	5
nonflammable	5
n-heptane in air, lower limit of flammability	15
n-hexane in air, lower limit of flammability	15
Ignition temperatures	39
Le Chatelier's law	12
Limit mixture, definition	5
Limit of flammability, concentration, definition	6
Limits of flammability, effect of temperature and pressure on	6
Limits of flammability, experimental criterion for the	
determination of	6
Limits of flammability, experimental results	19
Limits of flammability, general form of constant pressure	
curves	9
Limits of flammability in air, approximate values of	17
Limit of flammability, low pressure, definition	11

Contrails

INDEX

	Page
Limit of flammability, lower, definition - - - - -	6
Limits of flammability, temperature or equilibrium concentration, definition - - - - -	7
Limits of flammability, temperature, general form of saturated vapor-air curves - - - - -	10
Limit of flammability, upper, definition - - - - -	6
Limit of ignitibility, definition - - - - -	7
Liquid mixtures - - - - -	12
Mists - - - - -	17, 40
n-nonane in air, lower limit of flammability - - - - -	15
iso-octane in air, lower limit of flammability - - - - -	15
n-octane in air, lower limit of flammability - - - - -	15
oscillograms, voltage and current, analysis - - - - -	35
oscillograms, voltage across and current through a spark discharge gap - - - - -	34
Phase 1 - - - - -	1
Phase 2 - - - - -	1
Program - - - - -	1
Pure liquids - - - - -	11
Purpose - - - - -	1
Raoult's law - - - - -	12
Size measurement, heterogeneous mixture of sizes - - - - -	18
Size measurement, sampling methods - - - - -	18
Spontaneous ignition temperature, definition - - - - -	11
Spontaneous ignition temperature, minimum, definition - - - - -	11
Sprays - - - - -	17, 40
photomicrographs - - - - -	45
Stoichiometric mixtures - - - - -	14
Time lag before ignition, definition - - - - -	11
T.C.C., definition - - - - -	16
T.C.C. for paraffin hydrocarbons in air, expresses as a fuel-air weight ratio - - - - -	16
T.C.C. for paraffin hydrocarbons in air, expressed as a ratio of combustible to oxygen atoms - - - - -	17
T.C.C. for paraffin hydrocarbons in air, expressed in mg. combustible per liter of air - - - - -	17
T.C.C. for paraffin hydrocarbons in air, expressed in percent by volume - - - - -	16
Two-fluid nozzle, air velocities - - - - -	45
sprays produced by - - - - -	43, 45

INITIAL DISTRIBUTION LIST

1. Wright Air Development Center (5 copies)
 - a. Materials Laboratory, Research Division (WCRTR)
 - b. Armament Laboratory, Weapons Components Division (WCEG)
 - c. Power Plant Laboratory, Aeronautics Division (WCNEF)
 - d. Power Plant Laboratory, Aeronautics Division (WCNEG)
 - e. Power Plant Laboratory, Aeronautics Division (WCNEI)
2. National Advisory Committee for Aeronautics
3. Bureau of Aeronautics, United States Navy
4. Ballistic Research Laboratory, Aberdeen Proving Ground, Maryland