

FULLY-STRESSED DESIGN OF AIRFRAME REDUNDANT STRUCTURES

W. Dwyer*, J. Rosenbaum**, M. Shulman*, and H. Pardo*

Grumman Aircraft Engineering Corporation

This paper presents a description of two automated, fully stressed design procedures for airframe redundant structures, together with wing box beam examples. One of the methods is a variation of the other; both are based upon the displacement method and are essentially digital computer adaptations of a traditional optimization technique. By the simpler, "average stress" method, one analyzes a structure which has been idealized as a system of discrete elements, and then resizes the members of the structure based upon the average stresses occurring in each member, together with some failure criteria. It has been found in applying this method to wings, that the final structure resulting from many iterations sometimes exhibits discontinuities in material distribution that are sufficiently severe to be unacceptable to stress analysts for use in design. This effect is evident in the accompanying examples. Even in such cases, however, useful results for rough work such as in preliminary design may nevertheless be obtained by cutting off the iteration procedure after approximately three cycles. The alternative approach is based upon "nodal stresses" in the manner of the force method, rather than average element stresses, and converges to reasonably smooth material distributions. It has the disadvantage, however, of requiring additional programming for its implementation, and consequently thus far has been applied only to wing type structures. Both procedures have been in use recently at Grumman on various preliminary designs.

* Structural Methods Engineer, Structural Mechanics Section

** Staff Assistant to Manager of Structural Sciences

SECTION I
DISCUSSION

BACKGROUND

The goal of the structural designer has always been an airframe structure which meets all operational requirements, and at the same time is of minimum weight. The process involved in achieving this goal is an iterative one, in which applied loads are first determined for the critical conditions - maneuver, gust, landing, etc. - and the structure is then sized for strength, based upon these loads. With this "first cut" at a structure in hand, one can estimate flexibilities, and introduce their effects into revised load calculations. Perhaps even more important, in some cases at least, flutter calculations are now possible as well. The results of these investigations will almost certainly require a modification of the original structure, and thus an iterative procedure is involved.

One of the key steps in this procedure is the optimization of the major structural components for strength, based upon the loads calculated during a given cycle. This can be done in a traditional way, leading to what is generally known as a "fully stressed" design. By this we mean an idealized structure for which the stresses in all the elements are at prescribed maximum limits under at least one loading condition, or are at minimum areas, gages, etc., as dictated by various other practical considerations. Engineers have long believed that such a structure will very likely also be of minimum weight.

It is acknowledged that a fully stressed design may not always be the lightest possible structure satisfying these strength and minimum gage constraints (Reference 1). Much work is currently being done in this area using true optimization procedures, i.e., those which focus directly upon the weight of the structure, and attempt to minimize it, subject to the aforementioned constraints. Currently, the more promising approaches for doing this include the penalty function and the gradient search techniques (References 2 to 4). To date, however, those fully stressed designs which have been shown to be non-optimum have fallen into a very restricted class, and even for this group they have been fairly close to optimum. In view of the much greater computer time required for the penalty function and the gradient search techniques, the fully stressed design approach is considered to be an acceptable practical compromise for the present.

In the case where a wing or empennage proves to be critical for flutter, rather than strength, the fully stressed design approach, of course, is not directly applicable. Under these conditions one must fall back upon traditional cut and try techniques, which may consist of judiciously increasing certain of the minimum skin gages permitted in a fully stressed design, and going through the entire analysis cycle to determine the effect upon the flutter speed. There has been at least one pioneering attempt at introducing true optimization techniques into the problem of designing airframe structures that are critical for flutter (Reference 5), but to date, it must be considered beyond the state of the art from an engineering point of view.

THE AVERAGE STRESS METHOD

Up to the present, most of the work reported in the literature on structural optimization has been focused primarily upon truss type structures, rather than the stressed skin ones which are of primary concern in aerospace applications. This would seem to be a logical progression; aerospace structures have additional complicating features that are not present in trusses.

The conventional way to apply the direct stiffness method to wing and fuselage type structures is to idealize them of uniform stress triangles, connected only at their vertices. Other structural elements may be present as well, such as bars and beams.

The most obvious way to attempt to fully stress such structures is to apply to them, with a minimum of change, the methods previously developed for trusses. Thus, one would calculate the principal stresses for each triangle independently, or perhaps the corresponding effective stress, and then resize each triangle based upon this average stress state, together with some failure criteria. Other kinds of elements would be handled similarly. The resized structure would then be reanalyzed. The analysis and redesign procedure would be automatically repeated until the process converged to a design in which every element is either stressed to its maximum for the given failure criteria under at least one load condition, or is at some prescribed minimum size.

Unfortunately, independently of any optimization that may be attempted, a basic feature of the stress distributions that frequently result for such idealized structures is large and erratic discontinuity between stresses in adjacent triangles. Other kinds of members, if present, further complicate the picture. In essence, this means then that one has differently stressed members in parallel between the same nodes. This is in marked contrast to the situation for trusses, where one has single members only between adjacent nodes.

The result of this complication is disastrous when one attempts to optimize an aerospace structure in the manner indicated. Inevitably, the higher stressed members pick up additional load, i.e., become heavier, while the adjacent lower stressed ones in parallel are driven to their minimum sizes. The resulting discontinuities in skin gages, etc., are completely unrealistic, and the whole analysis is discredited in the eyes of the structures engineer.

Turner and his associates (References 6) have pointed out that one can eliminate a large part of the discontinuities in stress between adjacent triangles by combining the triangles in groups of four to form quadrilaterals. Average stresses are then calculated for each quadrilateral, which is henceforth considered to be a new, uniform thickness, structural element. In the case of rectangles, the average stresses calculated are identical to those obtained from a consideration of the node forces at the center of the rectangle. For non-rectangular combinations, this is no longer exactly so, but the average values are still a good indication of the average stress state within the element. Grumman has made extensive use of this element in applying the direct stiffness method to aircraft stress analysis.

When optimization of a wing structure is attempted using quadrilaterals rather than triangles, the results are somewhat more gratifying. It is true that, basically, one still has elements in parallel between the same nodes, but because the stresses vary much more smoothly, it takes more iterative cycles to develop severe discontinuities in material distribution. Fortunately, it has been observed that, using the fully stressed design procedure, the structural weight usually converges very rapidly to a nearly constant value. Thus, for certain practical purposes, such as in preliminary design, it has been found that two or three cycles of this form of the fully stressed design procedure give results that can be quite useful. There may be a number of elements present in the structure at this stage with sizeable negative margins, however.

THE NODAL STRESS METHOD

For wing final detail stress analysis purposes, as contrasted with optimization, structures engineers at Grumman (and presumably elsewhere as well) are not satisfied with using average stresses occurring somewhere in the interior of either triangular or quadrilateral structural elements. Instead, one must be concerned with maximum wing cover stresses as they exist at the intersections of spars and ribs, and at other discontinuities. For this purpose, one prefers analysis results in the form of the older force method idealization, i.e., bars with axial load varying along the length, and shear panels subjected to shear flows only.

In order to satisfy this need, current practice at Grumman is to analyze a wing by the stiffness method, using quadrilaterals wherever possible, and then to manipulate the resulting nodal forces into force method form, i.e., bar end loads and panel shear flows. These, in turn, are converted into stresses at the node points in the manner traditionally used for the force method.

Thus when the cover panels are rectangular, or nearly so, the direct stresses at the nodes are obtained by dividing the bar end loads by the appropriate cross-sectional areas. The shear stresses are the panel shear flows divided by the panel thicknesses. Handled in this way, the direct stresses at a spar-rib intersection are now continuous, while the shear flows vary in a finite manner as required by equilibrium of the bars.

When the spars and ribs are decidedly non-orthogonal, the situation is more complex, but the same basic trend toward continuity of stresses is still present.

Turner, et al (Reference 6) have described a slightly different procedure for determining stresses at the node point. It also is based upon use of the nodal forces, but treats shears from the spar and rib webs as concentrated forces rather than as shear flows. Thus discontinuities still exist in the direct stresses at the nodes. These are eliminated by averaging.

The question naturally arises, why not base the optimization procedure upon the previously described nodal stresses, rather than upon average values calculated for individual elements, considered independently of one another? Would this not tend to reduce the tendency to unrealistic discontinuities in material distributions? The essential details of how such a procedure might be applied are given next.

We assume that the wing to be optimized can be idealized primarily of quadrilateral membrane elements of the type described previously. Spar and rib caps are minimal, and their cross sectional areas are to be held effectively constant. However, see Appendix III for the case where a significant portion of the spanwise loading is carried in the spar caps and/or in other spanwise stiffening material.

After a displacement type redundant analysis of the idealized structure is carried out, corner forces from adjacent panels (and end loads from bars, if present) are transformed into force method form, that is, bar end loads and panel shear flows. This transformation is described briefly in Appendix I.

Using these loads, P/A type stresses are calculated in the bars at every node. Also, corresponding to each end of each of the bars, a single equivalent skin gage is calculated. For example, in a spar immediately outboard of a given node, this thickness is based upon appropriate contributions from the skins on both sides of the given spar. A corresponding equivalent skin gage is obtained in the spar direction immediately inboard of the node, and similar equivalent skin gages are obtained in the rib direction immediately forward of, and immediately aft of, the given node. Stress resultants may now be calculated; they are products of the P/A type stresses and the corresponding equivalent skin gages.

If the spars and ribs are approximately orthogonal, these stress resultants, plus the shear flows in the individual panels, are sufficient to determine a revised skin gage at each corner of every panel. Of course a suitable design criterion is needed, as well. On the other hand, if the sweep effects are substantial, an orthogonal set of stress resultants along the normal to the spar direction must first be obtained, in the manner of Appendix II. In either event, the resulting corner thicknesses are averaged for each panel, and the average thicknesses are used thereafter in the next displacement analysis cycle.

It can be seen from the preceding that the average stress and the nodal stress methods differ only in the manner in which the results of the displacement analysis are used to calculate local stresses, and from them, revised skin gages for the next round of analysis. However, this is apparently a significant difference. As was mentioned before, the average stress method recognizes the existence, in the displacement method idealization, of members in parallel between adjacent nodes. Because of the essentially discontinuous nature of the finite element approach, these members in parallel can operate at different stress levels. The optimization procedure, if carried out for a sufficient number of cycles, will tend to increase the thickness of the higher stressed member of such a pair, and drive the adjacent lower stressed one toward its minimum gage. The nodal stress method, on the other hand, tends to better equalize the stresses in members in parallel for the purpose of calculating new thicknesses, and thereby minimizes this difficulty.

SECTION II
SIMPLIFIED EXAMPLE STRUCTURE

The first structure chosen for comparing the predictions of the two methods is illustrated in the accompanying sketches, Figures 1 and 2. As can be seen, it is a simplified three spar, five bay, swept box beam, subjected to the three load conditions shown. For simplicity, no cap strip material is provided. In an actual structure with appreciable beam caps and/or stiffeners, this material can be handled as described in Appendix C.

In order to isolate the essential differences between the two methods, the failure criteria employed has been artificially simplified over what would actually be needed in practice. Thus, we do not distinguish between tensile and compressive loading, and failure is assumed to take place when the Henky-Von Mises effective stress σ_e reaches 60,000 psi, where

$$\overline{\sigma_e} = (\sigma_x^2 - \sigma_x \sigma_y + \sigma_y^2 + 3\tau_{xy}^2)^{\frac{1}{2}}$$

For each of the two fully stressed designs, the skin thicknesses were initially set at a uniform 0.16 in. Twenty redesign cycles were run in each case. The resulting cover gages are plotted on the accompanying graphs, Figure 3.

An examination of the curves reveals that the nodal stress results appear to have converged completely after about ten cycles, whereas the average stress values are still changing slightly after twenty. Also, the nodal stress thicknesses after twenty cycles appear to be considerably more smoothly distributed and acceptable for design than those based upon average stresses. This latter conclusion is reinforced by the cross-plotted results of Figure 4. Notice, however, that the thicknesses at the end of these cycles are fairly close to one another for the two methods. Thus for certain purposes, such as in rough preliminary design work, the three cycle, average stress results might be quite useful.

The weights of the two structures change very little after the initial resizing, as indicated in the following table.

	Nodal Stress	Average Stress
Start	179.5 lb.	179.5 lb.
1 cycle	119.9	118.9
3 cycles	119.5	118.5
20 cycles	119.2	119

However, the margins of safety are surprisingly different from zero during the early iterations. This can be seen from the curves of Figure 3 and the fact that, as a guide at least, the margin for a given panel after the n^{th} iteration is related to the panel thicknesses t_n and t_{n+1} by the expression:

$$M. S. = \frac{t_n - t_{n+1}}{t_n}$$

Thus, large positive slopes are indicative of large negative margins.

SECTION III

EA-6B WING

The Grumman EA-6B is a new, four-place electronic countermeasure version of the two-place A-6A Intruder, the latter being a United States Navy carrier based attack aircraft which has seen extensive action in Vietnam. The timing of the design of the EA-6B wing was such that it was carried out simultaneously with the development of the previously discussed fully stressed design programs; hence, these programs were used only in an exploratory manner on this project. The results obtained are nevertheless of some interest and will be presented in this section.

The overall wing planform geometry is shown in Figure 5. As can be seen, the main structural box beam is of two-spar construction, inboard of the "turning rib", and multi-spar construction outboard of this point. The wing has a fold joint at approximately mid span. The covers are machined from aluminum alloy plate material, and have three different types of stiffening between spars, depending upon the distance from the airplane symmetry plane. The wing cross section is unsymmetrical, with the lower cover less cambered than the upper.

The idealized plan form geometry is shown in Figure 6. The spar and rib webs, which are not shown, are quadrilaterals which can take shear only. In the fully stressed design analyses that have been run, no bars simulating cap strips or stiffeners are employed. Instead, all of the bending material in the covers is concentrated in isotropic membrane elements. The fold joint region is an exception. It is rather complex, and no attempt is made to optimize it

by means of the computer program. In this area, bars as well as triangles and quadrilaterals are used, and their areas and thicknesses are held fixed, in order to maintain the desired distribution of flexibilities between the various hinges.

In Figure 6, the idealized structure outboard of the fold joint shows an extended leading edge which does not appear in Figure 5. The latter represents the wing as it is currently being built. The extended leading edge has been included in the analysis in order to evaluate a proposed change.

There are 17 design conditions considered in the runs, of which only three affect any appreciable portion of the structure. These are all symmetrical flight conditions: (I) positive **high angle of attack**, (XI) positive low angle of attack with wing tip speed brakes extended, and (XII) positive low angle of attack with low drag.

Once again, in order to isolate the differences between the two methods most effectively, the Henky-Von Mises yield criterion has been used for both the upper and lower covers, with an allowable value of 66,000 psi. The vertical shear panels in the spar and rib webs are sized according to their average shear stresses and are held to 39,000 psi. In all cases, the minimum gage is set at 0.065 in.

The two types of programs, average stress and nodal stress, have been run for 14 cycles, with all gages set initially at one inch. The results for the first and the fourteenth redesigns are shown inboard of the fold rib in Figure 7. A study of the numbers presented there indicates that the initially resized gages are very similar except at the leading edge, where the minimum gage requirement makes the nodal stress results considerably higher, because in this case it is applied at each corner separately. These gages then increase or decrease reasonably smoothly to the final values.

It can be seen that the final values obtained by the two methods are not strikingly different, in contrast to the case of the simplified example structure. Results are also shown plotted in Figure 8 for a fairly typical cross section, that immediately outboard of the turning rib. By both methods the load intensity obviously builds up in the reentrant corner region, as expected. The nodal stress results appear to be smoother than the average stress ones, especially in the upper cover.

The wing weights by the two methods are within 1% of each other at the initial resizing, and come even closer together for subsequent iterations. In both cases the weights reduce by less than 2% from the first to the fourteenth cycle.

SECTION IV

CONCLUDING COMMENTS

In addition to the two examples discussed herein, Grumman has applied the average stress method to a number of other airframe structures. In some cases the material distributions appeared reasonable; in others they were very erratic, and in fact led to the development of the nodal stress method. Practice at Grumman henceforth will undoubtedly be to use the nodal stress method wherever the structural idealization permits it.

In addition to the Henky-Von Mises and the maximum shear criteria which were employed in the examples given, the programs provide for reduced tensile allowables, which can be made applicable for those design conditions for which fatigue is important. The programs also provide for compressive allowables which vary with compressive and shear load intensity, and thus, where applicable, one can use an optimum design curve such as provided in Reference 7.

Finally, one might recall that in some cases, truly optimized airframe structures are identical with the fully stressed design results. In such cases at least, if one uses an average stress approach, these theoretically correct methods should be expected to give material distributions that are sometimes quite erratic and unsuited for use in design.

ACKNOWLEDGMENT

The work reported in this paper is part of a continuing effort in structural optimization sponsored by the Grumman Aircraft Engineering Corporation Advanced Development Program. The authors gratefully acknowledged the guidance given them by W. Lansing, Chief of Structural Mechanics (who originally suggested the nodal stress approach), and the advice and assistance of E. Ranalli, W. R. Jensen, A. Davidson and P. Mulieri in accomplishing portions of the work.

SECTION V

REFERENCES

1. Razani, R., "The Behavior of the Fully-Stressed Design of Structures and its Relationship to Minimum-Weight Design," AIAA Journal Vol. 3, No. 12, December 1965, pp. 2262-2268.
2. Fiacco, A. V. and McCormack, G. P., "Computational Algorithm for the Sequential Unconstrained Minimization Technique for Nonlinear Programming," Management Science Vol. 10, No. 4, January 1964, pp. 601-617.
3. Schmit, L. A. and Fox, R. L., "An Integrated Approach to Structural Synthesis and Analysis," AIAA Journal Vol. 3, No. 6, June 1965, pp. 1104-1112.
4. Gellatly, R. A. and Gallagher, R. H., "A Procedure for Automated Minimum Weight Structural Design, Part 1 Theoretical Basis," Aeronautical Quarterly Vol. XVII, August 1966, pp. 216-230.
5. Turner, M. J., "Optimization of Structures to Satisfy Flutter Requirements," 25th Meeting of the Structures and Materials Panel of AGARD, 25-29 September 1967.
6. Turner, M. J., Martin, H. C., Weikel, P. C., "Development and Application of the Stiffness Method," Matrix Methods of Structural Analysis Edited by F. de Veubeke, Pergamon Press, 1964.
7. Catchpole, E. J., "The Optimum Design of Compression Surfaces Having Unflanged Integral Stiffeners," Journal of the Royal Aeronautical Society, November 1954, pp. 765-768.
8. Johnson, J. R., Melosh, R. J., and Luik, R. "Optimum Structural Design", 25th Meeting of the Structures and Materials Panel of AGARD, 25-29 September 1967.

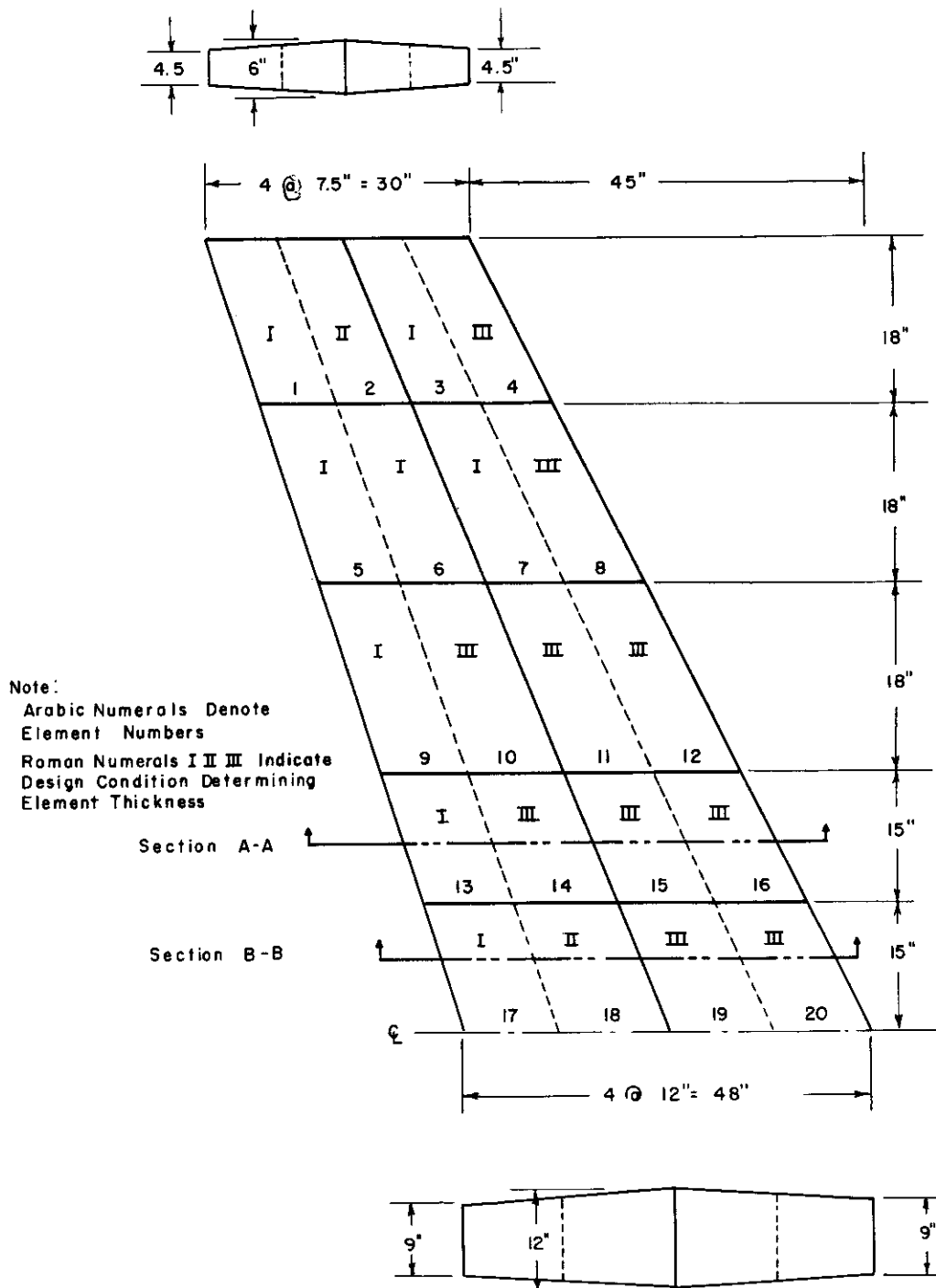
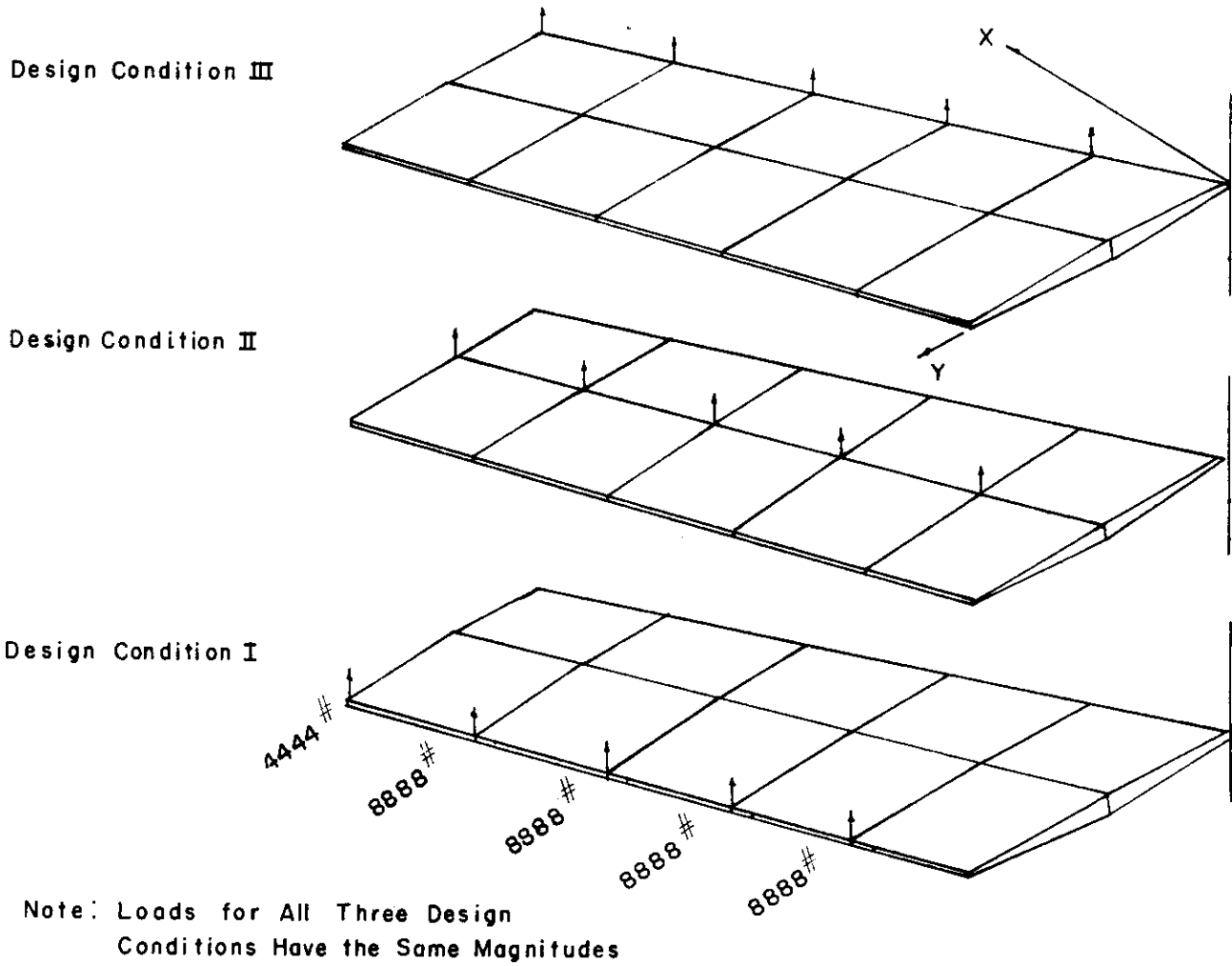

Figure 1. Example Structure Geometry



Note: Loads for All Three Design Conditions Have the Same Magnitudes

Figure 2. Example Structure Applied Loads

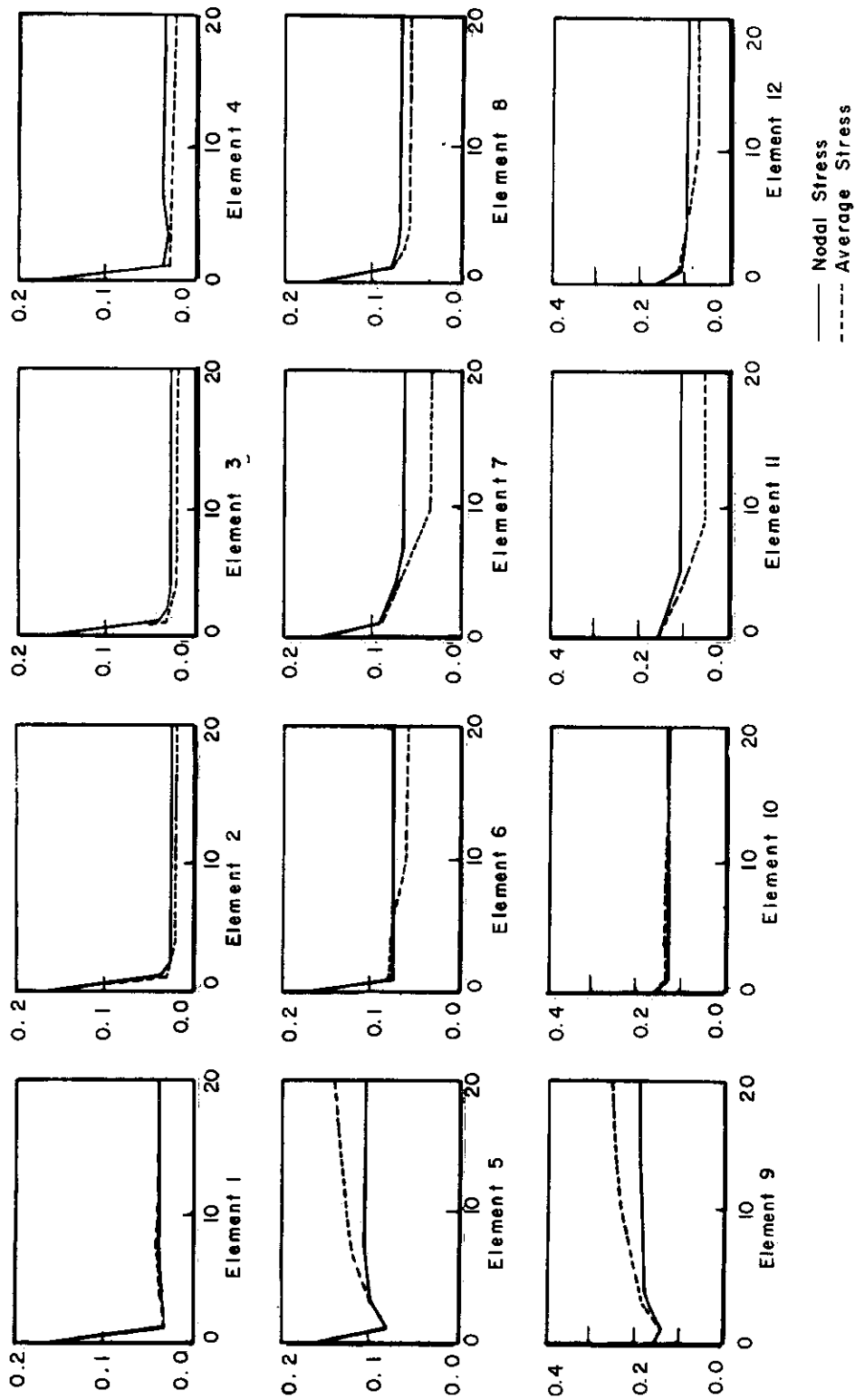

Figure 3. Element Thickness (Inches) as a Function of the Number of Cycles.

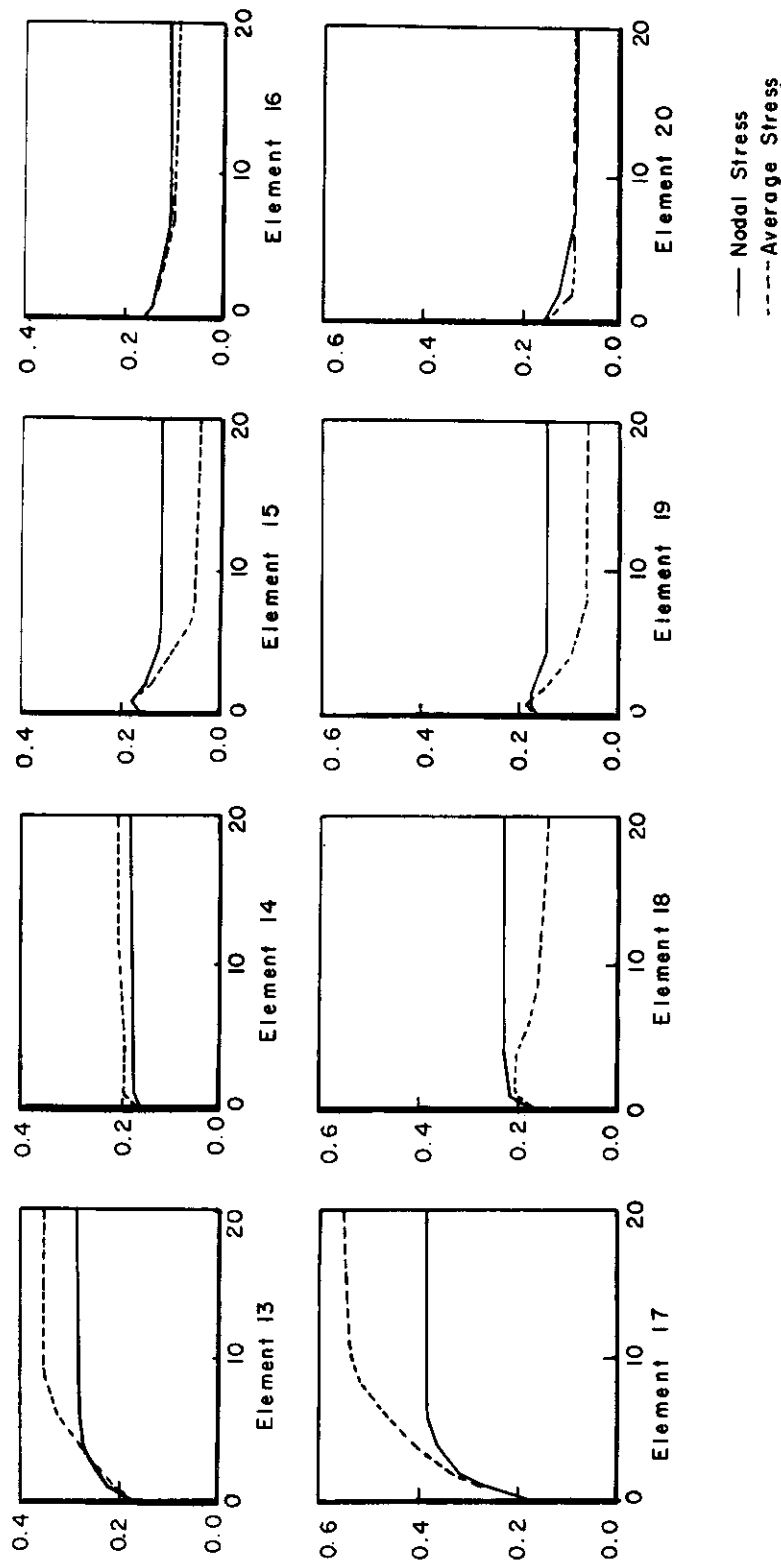

Figure 3 (contd.) Element Thickness (Inches) as a Function of the Number of Cycles

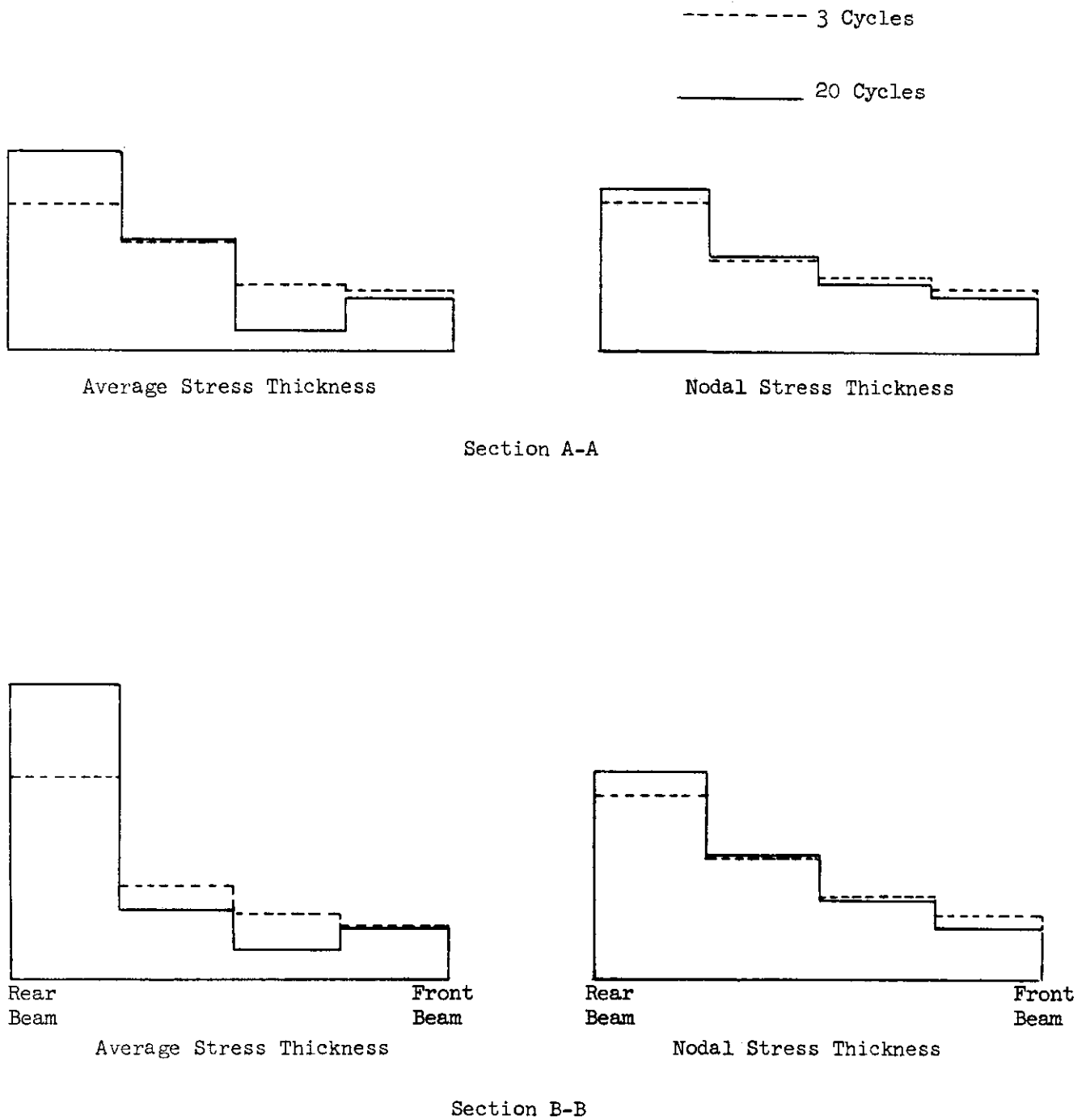

Figure 4. Selected Chordwise Cover Thicknesses Predicted by the Average Stress and Nodal Stress Methods

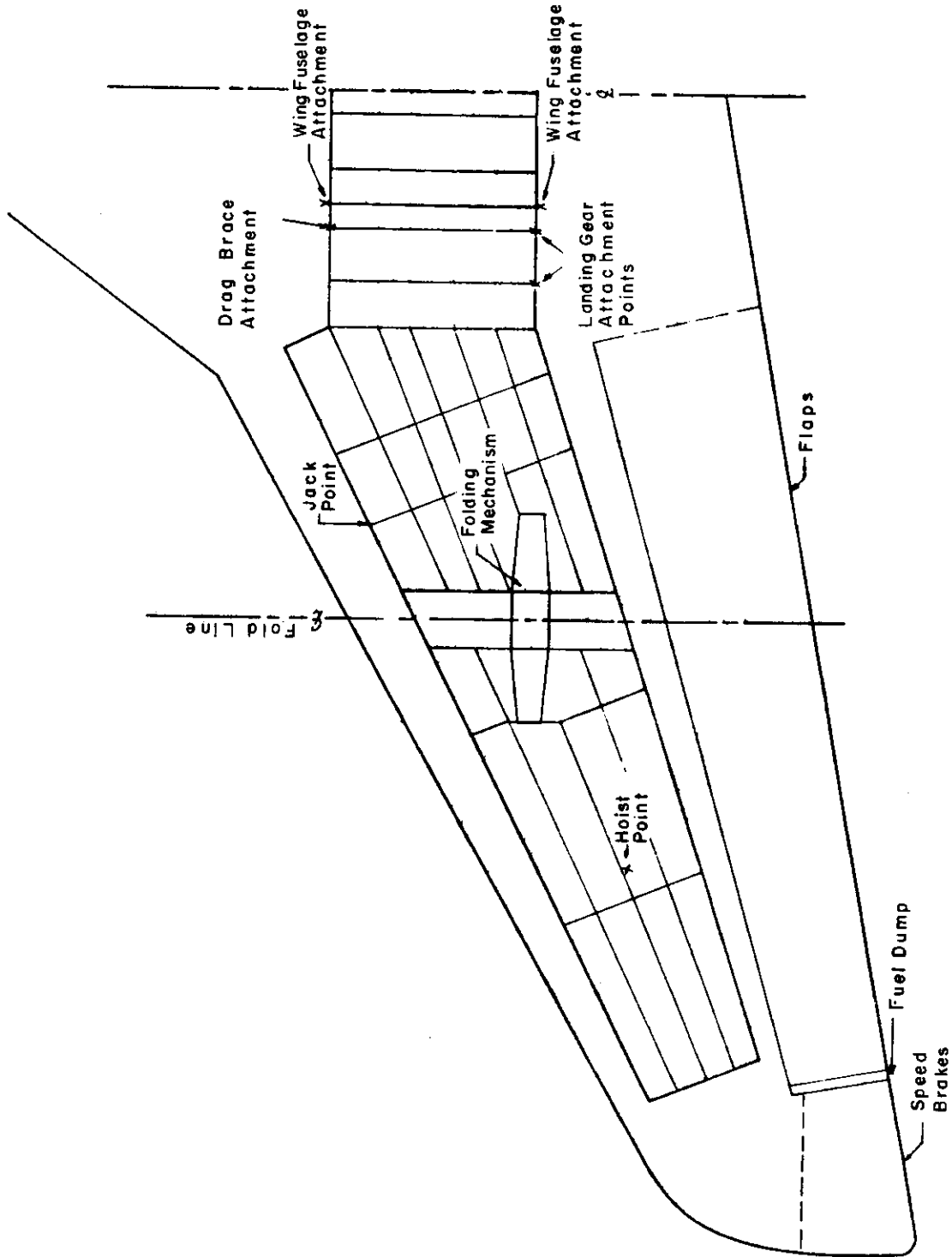

Figure 5. EA-6B Wing Geometry Showing Main Structural Box Beam and General Lay-Out

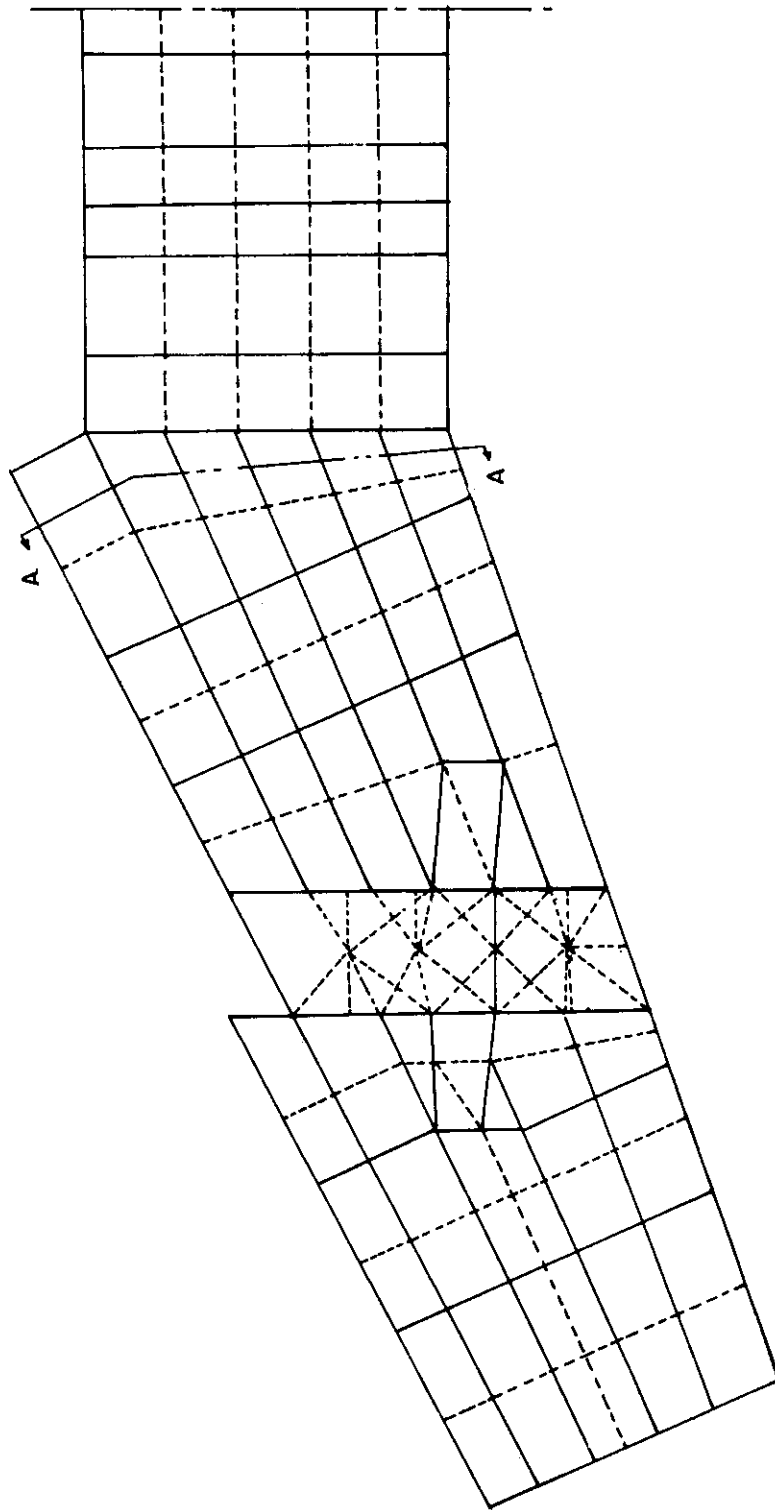

Figure 6. EA-6B Wing Idealization

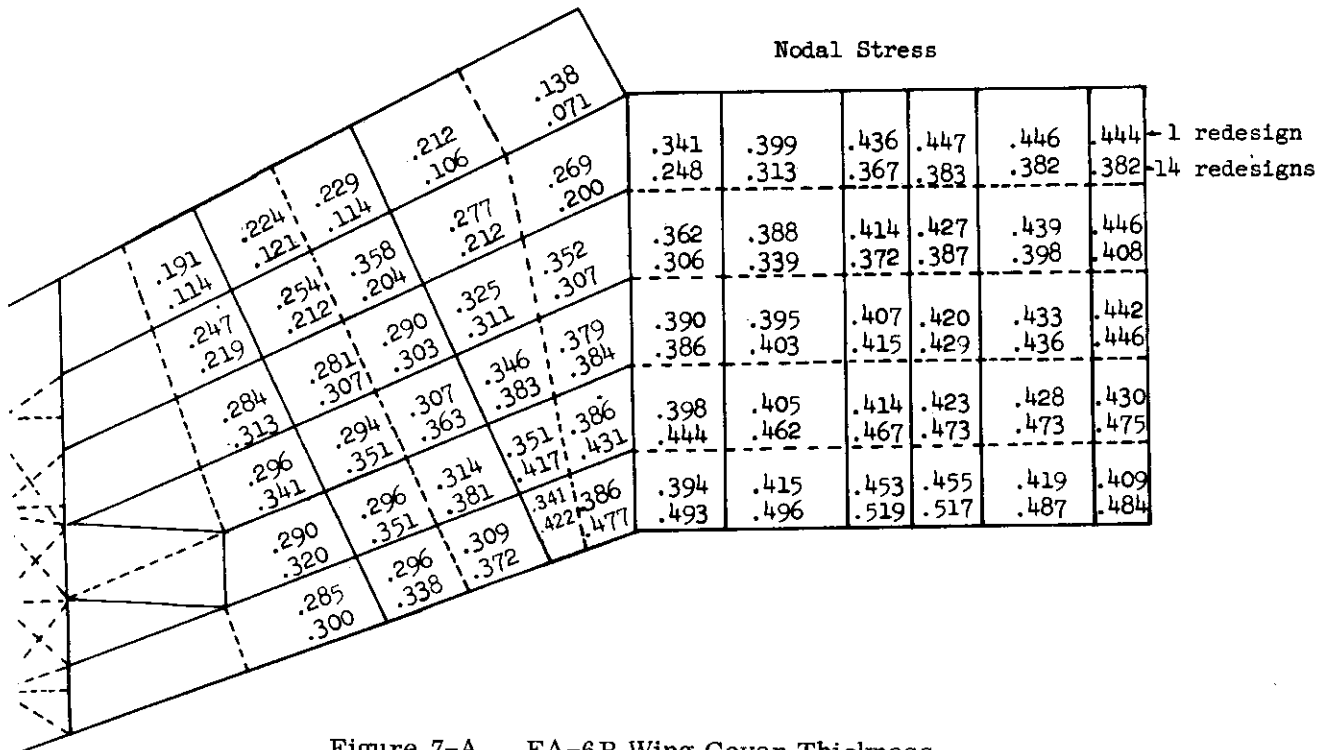
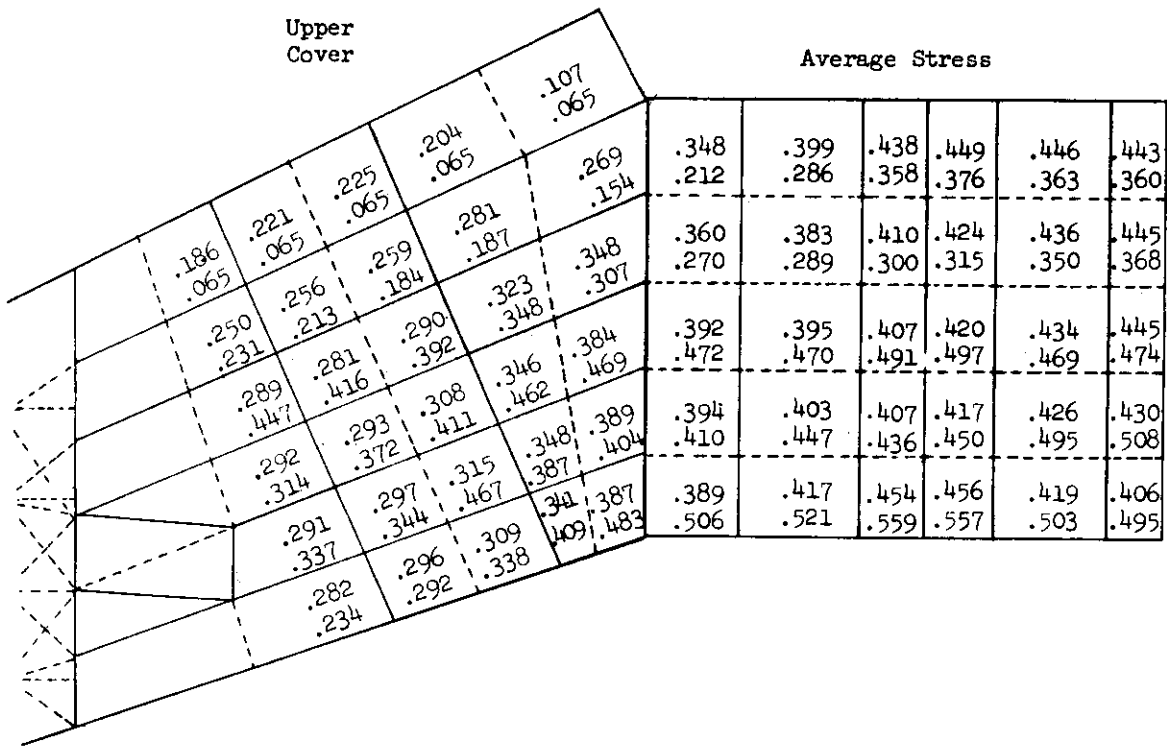

Figure 7-A. EA-6B Wing Cover Thickness

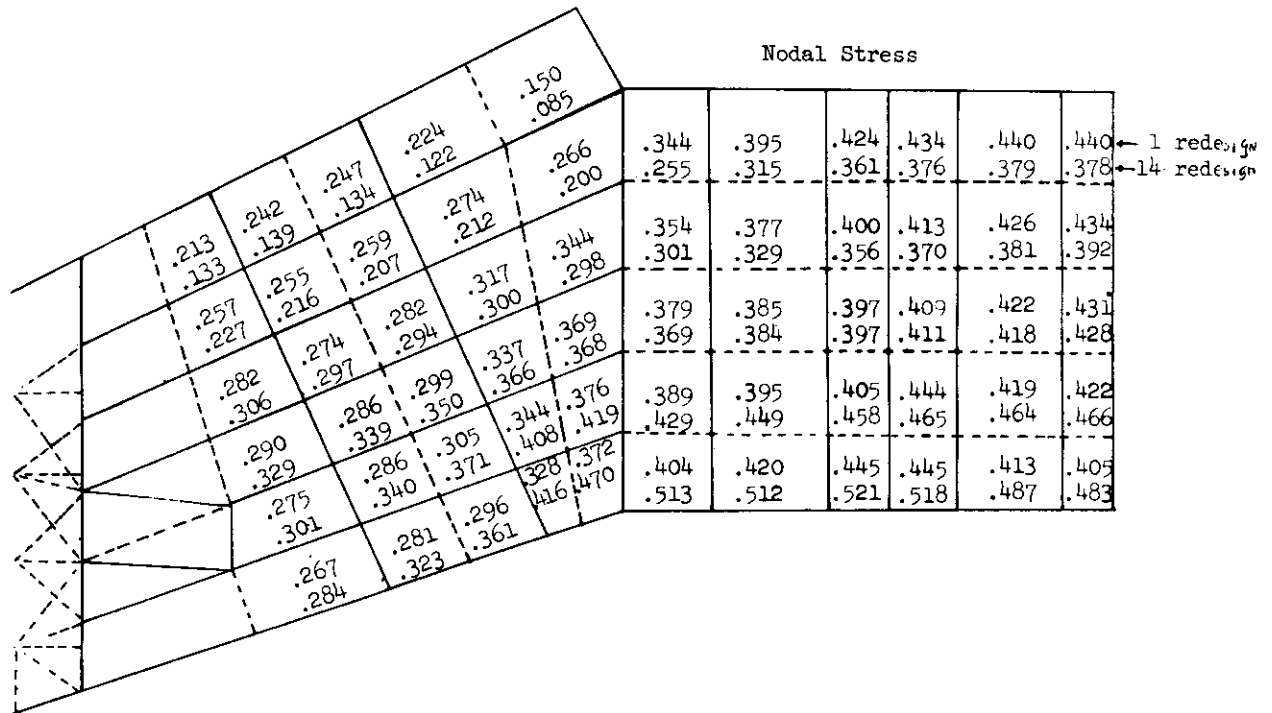
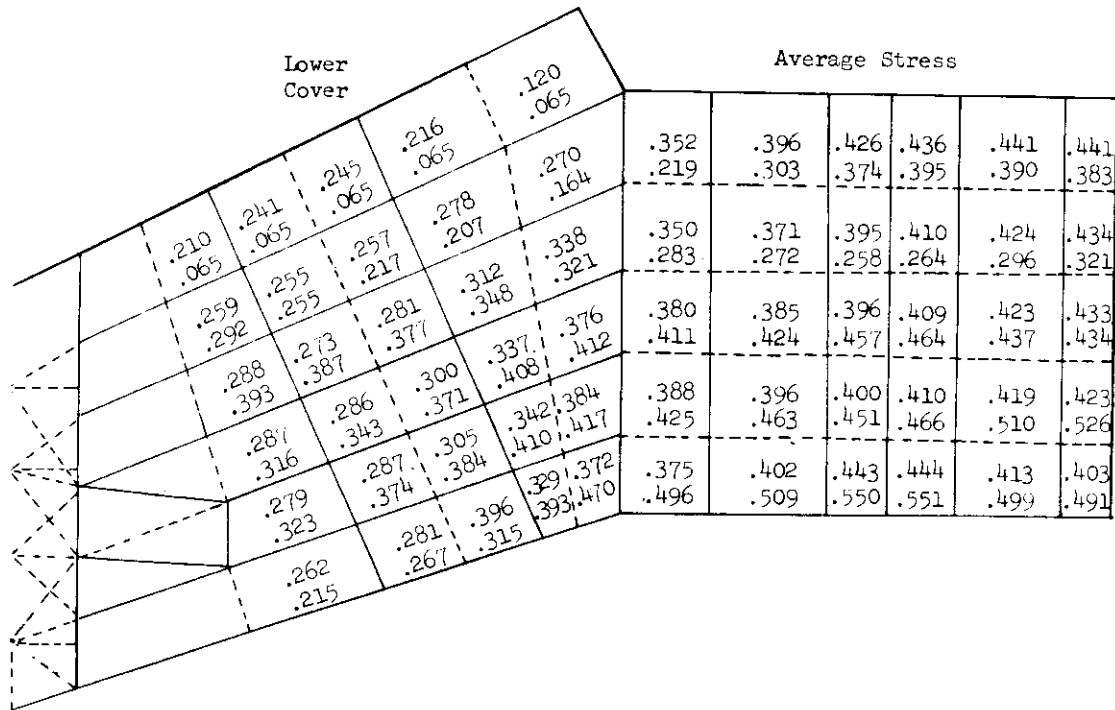
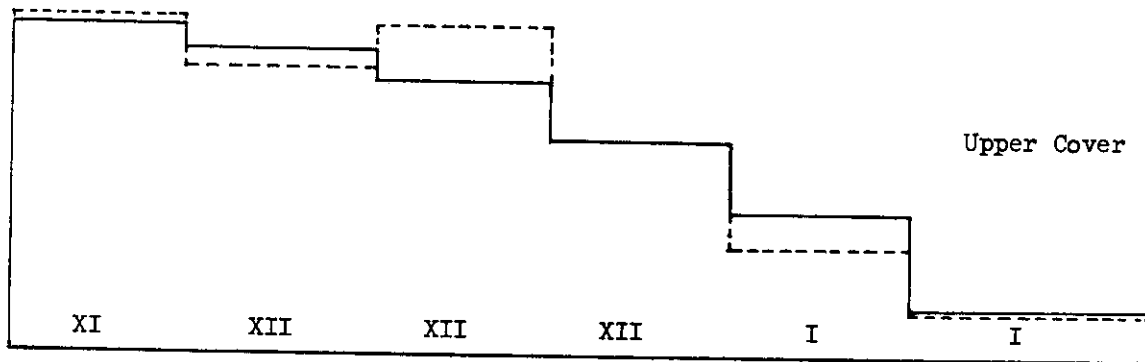
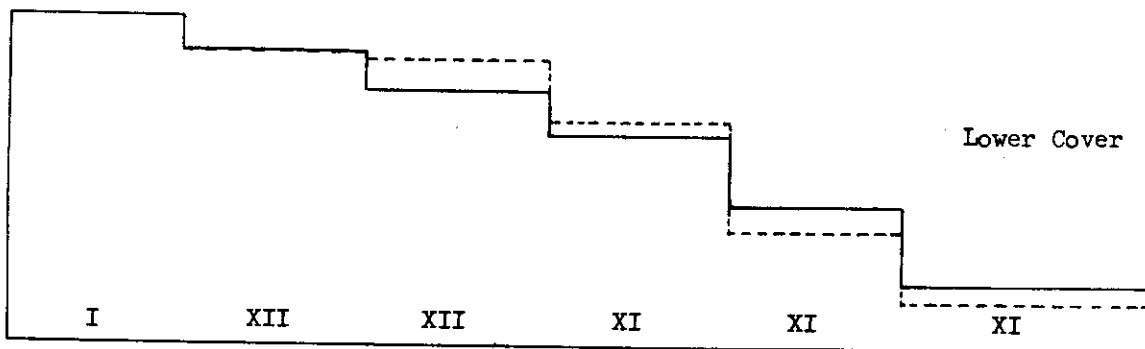

Figure 7-B. EA-6B Wing Cover Thicknesses



Roman numerals indicate load conditions, see page 14

----- Average Stress
—— Nodal Stress



Rear Beam

Front Beam

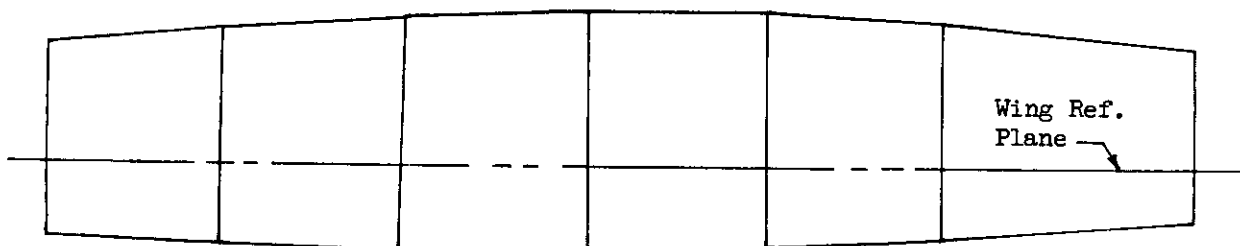

Figure 8. EA-6B Wing Box and Cover Thicknesses at Section A-A

APPENDIX I

CONVERSION OF DISPLACEMENT ANALYSIS RESULTS
INTO FORCE METHOD FORM

For the purpose of a displacement method redundant analysis, many airframe structures can be idealized as consisting primarily of quadrilateral membrane elements and bars. A portion of a wing structure treated in this way is displayed in Figure 9. As shown there, the quadrilaterals are loaded by corner forces acting along the edges, while the bars are loaded axially.

The equivalent force method idealization for the same structure is shown in Figure 10. There, all of the direct load is carried by bars located along the intersections of the panels, while the panels themselves are loaded only by edge shears.

The transformation from displacement method member loads to force method member loads is very simple. For example, in Figure A-1, the four forces at node one, acting along the line between nodes one and two, are added together to form the bar end load q_s which is shown in Figure 10. Similarly, the shear flow q_{ss} of Figure A-2 is obtained from the two corner forces acting in the same direction on the corresponding panel of Figure 9. One simply takes their difference and divides by the length of the side.

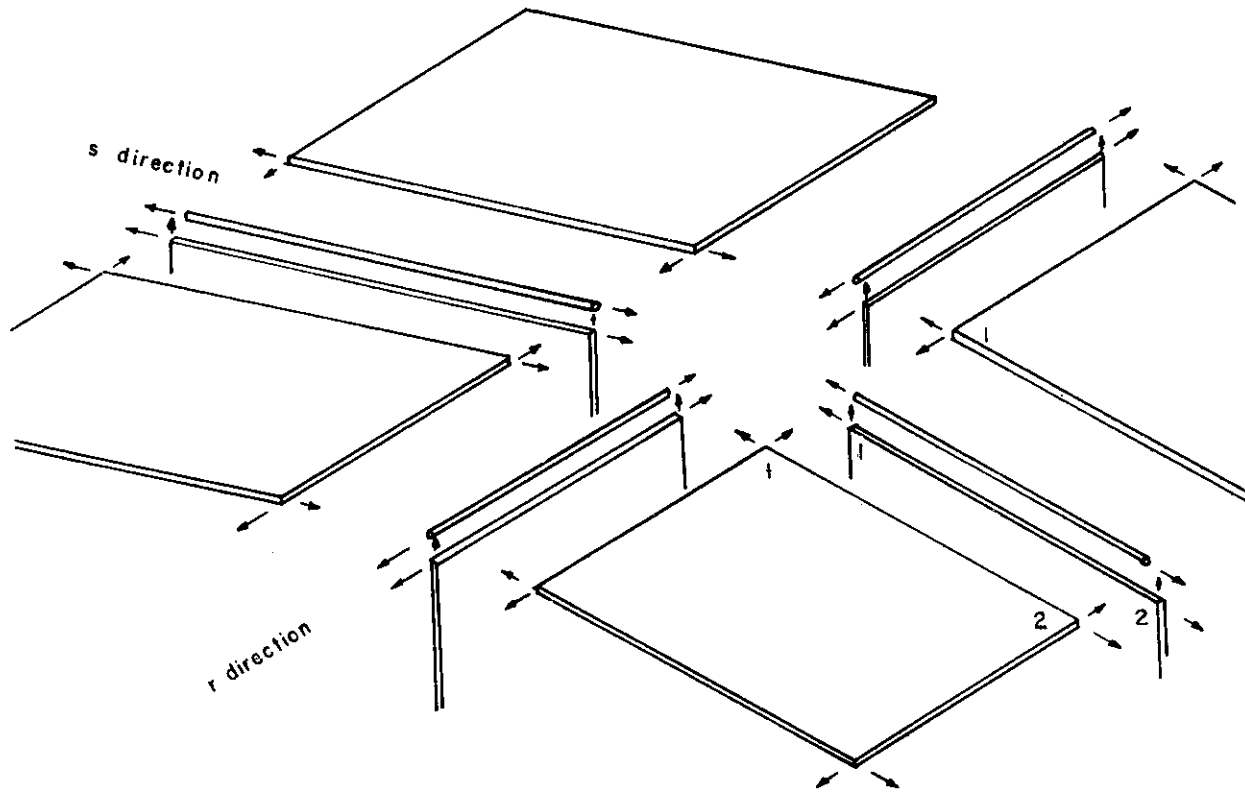

Figure 9. Standard Displacement Method Idealization

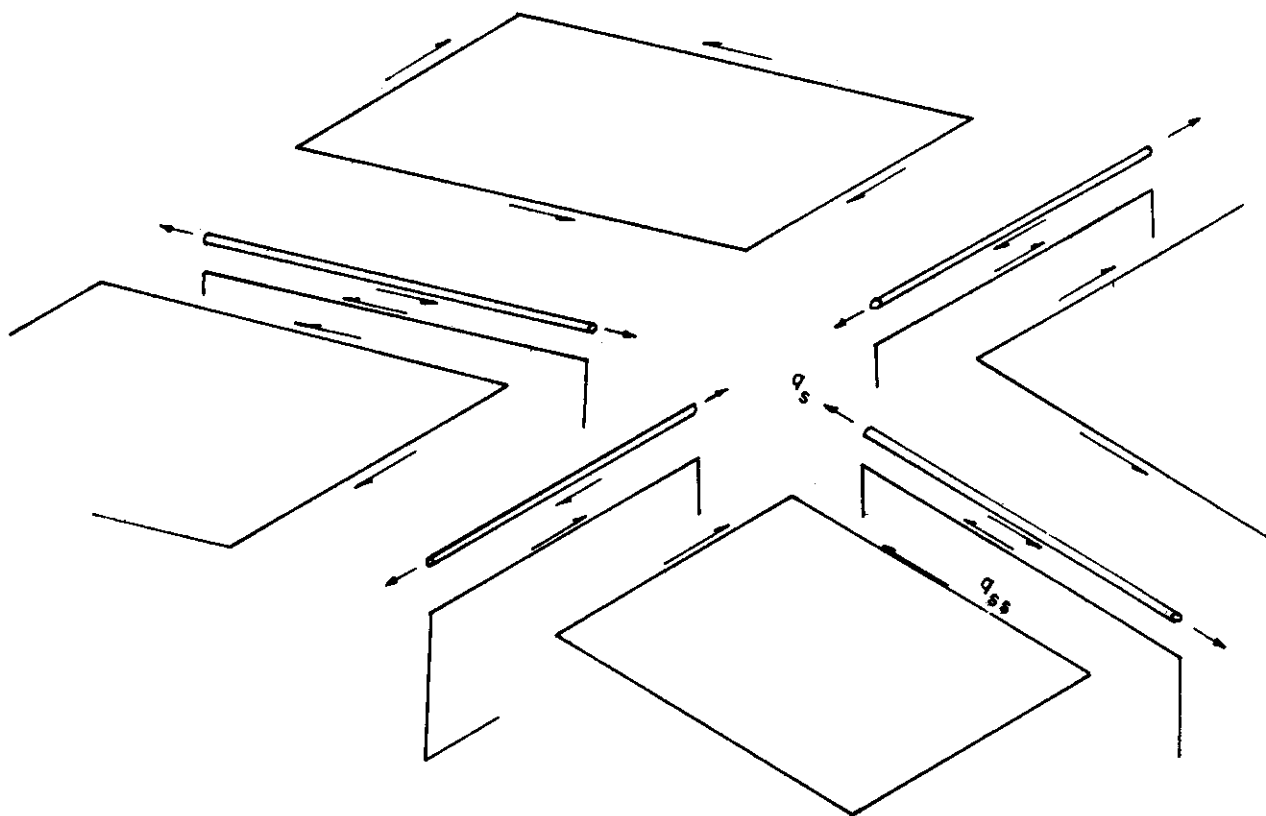
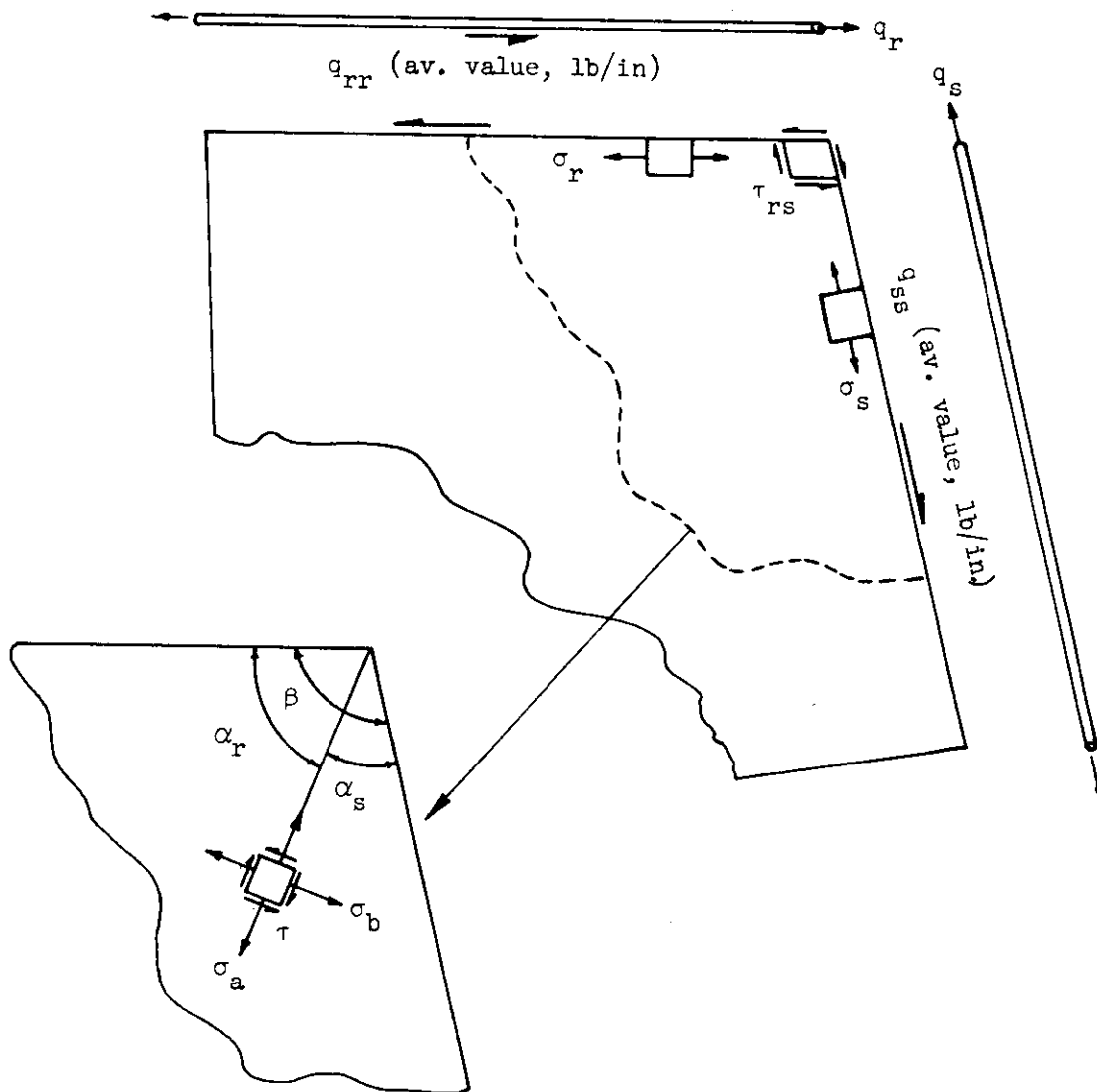

Figure 10. Alternate Force Method of Presenting Results of Displacement Method Analysis, Obtained by Transforming Nodal Forces Into Bar End Loads and Panel Shear Flows.

APPENDIX II
CONVERSION OF FORCE METHOD SWEEP WING
MEMBER LOADS INTO STRESSES



By the force method, the stresses in a wing cover adjacent to a spar and rib intersection are approximated by superposition of the three stress fields σ_r , σ_s and τ_{rs} . The orientations of these stresses for an irregular swept panel are shown in the accompanying sketch. Their magnitudes at a corner are assumed to be related to the corresponding member loads by the following:

$$\begin{aligned} \sigma_r &= q_r / A_r \\ \sigma_s &= q_s / A_s \\ \tau_{rs} &= q_{rr} / t \text{ or } q_{ss} / t, \text{ whichever is larger.} \end{aligned} \tag{1}$$

A_s is the equivalent spar area measured normal to the spar axis, and includes appropriate contributions from the adjacent skins as well as the actual cap strip and stiffener material. A_r is the analogous equivalent rib area, while "t" is the skin gage.

The stresses resulting from the superposition of σ_r , σ_s and τ_{rs} can be obtained by equilibrium calculations and are:

$$\begin{aligned}\sigma_a &= \sigma_s \cos^2 \alpha_s + \sigma_r \cos^2 \alpha_r - 2\tau_{rs} \frac{\cos \alpha_r \cos \alpha_s}{\sin \beta} \\ \tau &= \sigma_s \sin \alpha_s \cos \alpha_s - \sigma_r \sin \alpha_r \cos \alpha_r + \tau_{rs} \frac{\sin (\alpha_r - \alpha_s)}{\sin \beta}\end{aligned}\tag{2}$$

σ_b can be obtained from the formula for σ_a by increasing α_s and decreasing α_r by 90 degrees.

It can be seen from these expressions that if a panel is essentially rectangular, the stresses along and normal to the spar are given directly by Equation 1.

APPENDIX III

TREATMENT OF SPAR CAP AND STIFFENER MATERIAL

In optimizing a practical wing structure, one would like to be able to treat spar cap and stiffener material as bars which are fully stressed independently of the cover material. This proves to be difficult, because the idealized bars are then acting in parallel with the covers, and the same basic problem that was discussed for the average stress method occurs here also. In brief, the bars either take a disproportionately large or small share of the load, depending upon whether they or the adjacent covers happen to be initially acting at the higher stress.

In reality, away from concentrated loads in a thick skinned wing, the spar caps may well serve only one purpose -- to transfer shear from the spar webs to the covers. In this event, one would wish to hold the cap area at some minimum value consistent with this requirement. Integral stiffeners, on the other hand, are usually optimum when their areas are a fixed ratio of the skin cross-sectional area. Catchpole (Reference 7), for example, gives this ratio as 1.46 to one in the case of compression panels with uniformly spaced integral stiffeners of rectangular cross section.

One method for handling this situation is to fix the spar areas at their desired values. As for the stiffeners, the neatest way to handle them would be to use orthotropic plate elements. Thus, one would select a set of characteristics representing the shear and transverse extensional behavior of the base skin, and longitudinal extensional behavior representing base skin plus a fixed percentage of stiffener material. In effect one would then be "smearing" out the stiffener material into an orthotropic plate.

A less elegant way to achieve the same objective would be to make several homogeneous plate, fully stressed design runs in succession. The first run could be made without any bar material; accordingly, the covers would be sized to carry all of the spanwise bending load. The idealized structure covers would, however, be too stiff in shear and in transverse load carrying capacity.

One could now, by hand, subtract out of the plate material the fraction deemed to be optimum for stiffening. This could be entered as fixed bar areas, as discussed previously.

The fully stressed design procedure is now carried out again. If the ratio of cover skin area to lumped stiffener area remains sufficiently close to optimum, the work is done. Otherwise, a correction to the bar areas and another fully stressed design run may be necessary.

Contrails