

TERNARY PHASE EQUILIBRIA IN TRANSITION METAL-  
BORON-CARBON-SILICON SYSTEMS

Part IV. Thermochemical Calculations

Volume III. Computational Approach to the  
Calculation of Ternary Phase  
Diagrams

Y. A. Chang

~~This document is subject to special export controls and each transmittal to foreign governments or foreign nationals may be made only with prior approval of Metals and Ceramics Division, Air Force Materials Laboratory, Wright-Patterson Air Force Base, Ohio~~

*This document has been approved  
for public release and sale;  
its distribution is unlimited  
U.S. Air Systems Command  
Letter dated Aug 22, 1968  
Capt. Marchenko  
U 831117*

# *Contrails*

# *Contracts*

## NOTICES

When Government drawings, specifications, or other data are used for any purpose other than in connection with a definitely related Government procurement operation, the United States Government thereby incurs no responsibility nor any obligation whatsoever; and the fact that the Government may have formulated, furnished, or in any way supplied the said drawings, specifications, or other data, is not to be regarded by implication or otherwise as in any manner licensing the holder or any other person or corporation, or conveying any rights or permission to manufacture, use or sell any patented invention that may in any way be related thereto.

Copies of this report should not be returned to the Research and Technology Division unless return is required by security considerations, contractual obligations, or notice on a specific document.

# *Contrails*

## FOREWORD

The research described in this report was carried out at the Materials Research Laboratory, Aerojet-General Corporation, Sacramento, California, under USAF Contract No. AF 33(615)-1249. The contract was initiated under Project No. 7350, Task No. 753001, and was administered under the direction of the Air Force Materials Laboratory, Research and Technology Division, with Captain R. A. Peterson and Lt. P.J. Marchiando acting as Project Engineers, and Dr. E. Rudy, Aerojet-General Corporation, as Principal Investigator. Professor Dr. Hans Nowotny, University of Vienna, served as consultant to the program.

The project, which includes the experimental and theoretical investigation of related binary and ternary systems in the system classes  $Me_1-Me_2-C$ ,  $Me-B-C$ ,  $Me_1-Me_2-B$ ,  $Me-Si-B$ , and  $Me-Si-C$ , was initiated on 1 January 1964. The work on related binary systems  $Me-C$  and  $Me-B$  was initiated November 1964 as a subtask to the investigation of the ternaries.

The author wishes to thank Dr. E. Rudy for his interest, advice and encouragement during the course of this work. He also wishes to thank J. Hwang for aspects of the mathematical analysis of the problem. The computer programs were prepared by Ray Marler, Len Nole, Jerry Howard, and Bill Reuss of the Computing Science Division.

The manuscript of this report was released by the author February 1966 for publication as an RTD Technical Report.

Other reports issued under USAF-Contract AF 33(615)-1249 have included:

### Part I. Related Binaries

Volume I.	Mo-C System
Volume II.	Ti-C and Zr-C Systems
Volume III.	Systems Mo-B and W-B
Volume IV.	Hf-C System
Volume V.	Ta-C System. Partial Investigations in the Systems V-C and Nb-C
Volume VI.	W-C System. Supplemental Information on the Mo-C System
Volume VII.	Ti-B System
Volume VIII.	Zr-B System
Volume IX.	Hf-B System
Volume X.	V-B, Nb-B, and Ta-B Systems

### Part II. Ternary Systems

Volume I.	Ta-Hf-C System
Volume II.	Ti-Ta-C System
Volume III.	Zr-Ta-C System

## FOREWORD (Cont'd)

- Volume IV. Ti-Zr-C, Ti-Hf-C, and Zr-Hf-C Systems
- Volume V. Ti-Hf-B System
- Volume VI. Zr-Hf-B System
- Volume VII. Ti-Si-C, Nb-Si-C and W-Si-C Systems
- Volume VIII. Ta-W-C System
- Volume IX. Zr-W-B System, Pseudobinary System TaB<sub>2</sub>-HfB<sub>2</sub>
- Volume X. Zr-Si-C, Hf-Si-C, Zr-Si-B, and Hf-Si-B Systems
- Volume XI. Hf-Mo-B and Hf-W-B Systems

### Part III. Special Experimental Techniques

- Volume I. High Temperature Differential Thermal Analysis

### Part IV. Thermochemical Calculations

- Volume I. Thermodynamic Properties of Group IV, V, and VI Transition Metal Carbides
- Volume II. Thermodynamic Interpretation of Ternary Phase Diagrams.

This technical report has been reviewed and is approved.

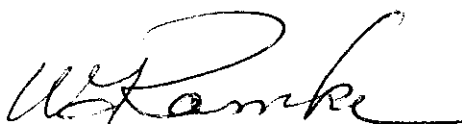

W.G. RAMKE  
Chief, Ceramics and Graphite Branch  
Metals and Ceramics Division  
Air Force Materials Laboratory

## ABSTRACT

The general conditional equations which govern the phase equilibria in three-component systems are presented. Using the general conditional equations, a general method has been developed to precalculate the phase equilibria in three-component systems from first principle using computer technique. The method developed has been applied to several model examples and the system Ta-Hf-C. The phase equilibria in three-component systems calculated using the simplified method as originally developed by Rudy, agree well with those calculated by the present method. The only difference is in the homogeneous range with respect to the interstitial component of solid solutions which exhibit large variation with metal exchange. This is to be expected in view of the assumptions made in the simplified method.

In connection with the phase diagram calculation and other problems of the present Air Force contract, several computer programs have been developed which are included in the appendix of this report.

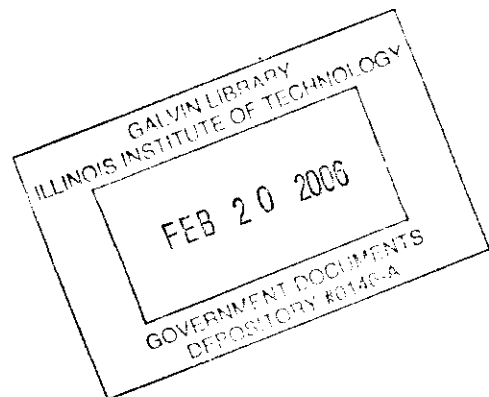

# *Contrails*



TABLE OF CONTENTS

	PAGE
I. INTRODUCTION AND SUMMARY . . . . .	1
A. Introduction . . . . .	1
B. Summary . . . . .	1
II. THERMODYNAMIC DESCRIPTION OF PHASE EQUILIBRIA IN THREE-COMPONENT SYSTEMS. . . . .	2
A. Two-Phase Equilibria in Three-Component Systems . . . . .	2
B. Three-Phase Equilibria in Three-Component Systems. . . . .	15
III. APPLICATION OF THE METHOD DEVELOPED TO THE SYSTEM Ta-Hf-C . . . . .	26
IV. DISCUSSION. . . . .	38
References. . . . .	39
Appendix I Computer Programs for Ternary Phase Diagram Calculations . . . . .	40
Appendix II Computer Program for Calculating the Excess Free Energies of the $Me_2C$ Phases in Terms of $2 + w$ gram- atom of Alloy. . . . .	59
Appendix III Computer Program for Evaluating the High-Temperature Thermodynamic Properties. . . . .	63
Appendix IV Computer Program for Calculating the Free Energies of the Monocarbide Phases Using the Wagner-Schottky Vacancy Model. . . . .	66

## LIST OF ILLUSTRATIONS

FIGURE		PAGE
1	Two-Phase Equilibria in a Ternary System	3
2	Schematic Representation of the Three Independent Variables $x'$ , $y'$ , and $x''$ for Two-Phase Equilibria in A Ternary System when $x'' > x$ .	6
3	Schematic Representation of the Three Independent Variables $x'$ , $y'$ , and $x''$ for Two Phase Equilibria in a Ternary System when $x'' < x$ .	7
4	Gibbs Free Energies of the Two Intermediate Phases $AC_v$ and $AC_w$ in the Binary A-C	9
5	Gibbs Free Energies of the Two Intermediate Phases $BC_v$ and $BC_w$ in the Binary B-C	10
6	Phase Equilibria Between Phases $\beta$ and $\gamma$ and $\gamma$ and C in the System A-B-C at 2000°K Calculated Using the General Method	12
7	Phase Equilibria Between Phases $\beta$ and $\gamma$ and $\gamma$ and C in the System A-B-C at 2000°K Calculated Using the Simplified Method	13
8	Concentration-Free-Energy-Gradient Curves for Solutions (A, B), (A, B) $C_v$ and (A, B) $C_w$ at 2000°K	14
9	Phase Equilibria Between $\beta$ and $\delta$ and $\delta$ and C in the System A-B-C at 2000°K Calculated Using the Simplified Method.	15
10	Phase Equilibria Between $\beta$ and $\delta$ and $\delta$ and C in the System A-B-C at 2000°K Calculated Using the General Method.	16
11	Three-Phase Equilibrium in a Ternary System	17
12	Phase Equilibria Calculated Using the Simplified Method in the System A-B-C at 1250°K when the Two Binary Phases $AC_w$ and $BC_w$ are Unstable	20
13	Phase Equilibria Calculated Using the General Method in the System A-B-C at 1250°K when the Two Intermediate Phases $AC_w$ and $BC_w$ are Unstable	21
14	The Concentration-Free-Energy-Gradient Curves for the Solution (A, B) and (A, B) $C_v$ at 1250°K	22

## LIST OF ILLUSTRATIONS (Cont'd)

FIGURE		PAGE
15	A Typical Ternary Phase Diagram with a Three-Phase Field Resulting from the Absence of a Corresponding Intermediate Phase in the Binary A-C	23
16	Phase Equilibria Calculated Using the General Method in the System A-B-C at 2000°K when all the Three Phases $AC_w$ , $BC_v$ and $BC_w$ are stable in the binaries.	23
17	Phase Equilibria Calculated Using the Simplified Method in the System A-B-C at 2000°K when the Three Phases $AC_w$ , $BC_v$ and $BC_w$ are Stable in the Binaries.	24
18	Integral Gibbs Free Energy of Decomposition of (A, B) $C_{.235}$ to (A, B) $C_{.961}$ and (A, B)	25
19	Calculated Phase Equilibria in the System Ta-Hf-C Using the General Method at 2273°K	32
20	Calculated Phase Equilibria in the System Ta-Hf-C Using the General Method at 1773°K.	33
21	Calculated Phase Equilibria in the System Ta-Hf-C Using the Simplified Method at 2273°K	34
22	Calculated Phase Equilibria in the System Ta-Hf-C Using the Simplified Method at 1773°K	35
23	Concentration-Free-Energy-Gradient Curves for the Metal, Subcarbide and Monocarbide Solid Solutions	36
24	Integral Free Energy of Decomposition of the Subcarbide Phase into the Metal and Monocarbide Phase at 2273°K	37

# *Contrails*

## I. INTRODUCTION AND SUMMARY

### A. INTRODUCTION

Apart from theoretical interest, the capability of predicting phase equilibria in three-component systems from binary data is of practical significance since the cost of experimentally investigating phase equilibria in ternary systems is rather high. For the transition metal<sub>1</sub>, metal<sub>2</sub>, carbon ternary systems (i.e. the interstitial type of solid solutions), a method has been developed by Rudy<sup>(1)</sup> to predict the phase equilibria in ternary systems assuming that the intermediate phases in the metal<sub>1</sub>-carbon and metal<sub>2</sub>-carbon binaries are either of line-compounds or that both phases are of equal dependence of the free energy on the concentration coordinate of the interstitial component. In cases, where the homogeneous ranges of the solid solutions with respect to the interstitial component changes drastically with metal exchange, the simplified method does not predict, as to be expected from the assumptions made, the exact phase boundaries. The purpose of the present work is to develop a general method using computer technique to predict the phase equilibria in three-component systems with no assumptions made as in the simplified method. This general method will predict not only the phase equilibria but also the correct homogeneous ranges of the single phases.

### B. SUMMARY

The conditional equations which govern the phase equilibria in three-component systems are presented. Using the conditional equations, a method has been developed using computer technique to precalculate the phase equilibria in three-component systems from first principle. The method developed has been applied to model examples and the system Ta-Hf-C. The phase equilibria in three-component systems calculated using the simplified method originally developed by Rudy, agree rather well with those calculated by the present method. The only difference is in the homogeneous ranges of solid solutions which exhibit large variation with metal exchange. This is to be expected in view of the assumptions made in the simplified method.

Several computer programs for the phase equilibrium calculations as well as for other problems of the present Air Force contract have been developed. The fortran statements of all the computer programs are included in the appendix at the end of the report.

## II. THERMODYNAMIC DESCRIPTION OF PHASE EQUILIBRIA IN THREE COMPONENT SYSTEMS

According to the phase rule, at constant pressure the maximum number of coexisting phases in a one-component system is two, two-component system three, and three-component system, four. In addition, if one fixes temperature, the maximum number of coexisting phases in a ternary system reduces to three. Consequently, an isothermal section of a ternary phase diagram is built up of one-phase, two-phase, and three-phase equilibria. On the one hand, concentrations of the coexisting phases in a two-phase field determine the phase boundaries of single-phase fields. On the other hand, the boundaries of a three-phase equilibrium are the limiting tie-lines of the three adjacent two-phase equilibria. We shall now discuss first the thermodynamics of two-phase equilibria.

### A. TWO-PHASE EQUILIBRIA IN THREE-COMPONENT SYSTEM

The Gibbs free energy of formation of a two-phase alloy,  $A_x B_y C_z$  as shown in Figure 1 is a linear combination of the Gibbs free energies of formation of the two coexisting phases  $A_{x'} B_{y'} C_{z'}$  and  $A_{x''} B_{y''} C_{z''}$ . Expressing in mathematical terms, we have

$$\Delta G = \nu_1 \Delta G_1 + \nu_2 \Delta G_2 \quad (1)$$

where  $\Delta G$ ,  $\Delta G_1$ , and  $\Delta G_2$  are the Gibbs free energies of formation of the two-phase alloy and of the two co-existing single phases; and  $\nu_1$  and  $\nu_2$  are the relative amounts of the two co-existing single phases. If we take one gramatom of alloy as our basis, we have the following three boundary conditions:

# Contrails

$$v_1 + v_2 = 1 \quad (2)$$

$$x' + y' + z' = 1 \quad (3)$$

$$x'' + y'' + z'' = 1 \quad (4)$$

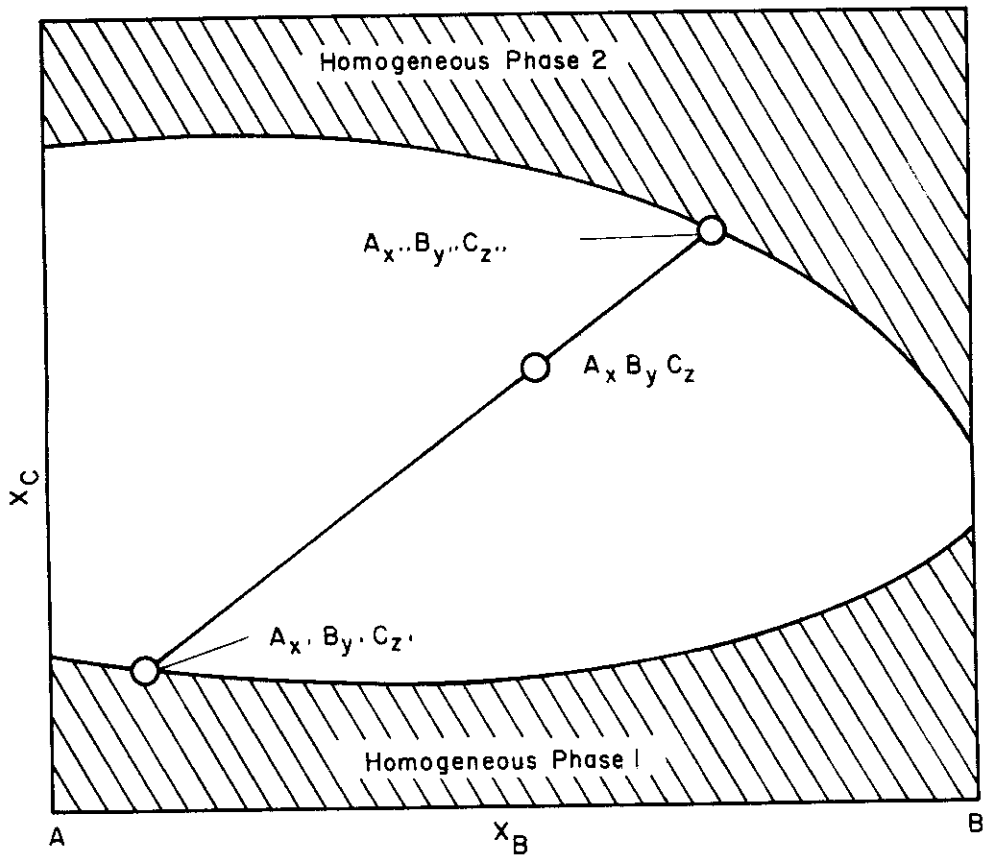

Figure 1. Two-Phase Equilibria in a Ternary System.

Two additional boundary conditions can be obtained resulting from the conservation of masses:

$$v_1 x' + v_2 x'' = x \quad (5)$$

$$v_1 y' + v_2 y'' = y \quad (6)$$

# Contrails

Given  $\Delta G_1$  and  $\Delta G_2$  as a function of composition at constant P and T and a set of x, y, z values, we would like to calculate the values of  $x'$ ,  $y'$ ,  $z'$  and  $x''$ ,  $y''$ , and  $z''$ . Since there are eight unknowns:  $v_1, v_2, x', y', z', x'', y'',$  and  $z''$  and five equations (2 to 6), we have only three independent variables. We can choose any three variables as we wish. In the present case, we shall choose  $x', y'$ , and  $x''$ , as our ultimate variables. By elimination of the various variables in equations (2) through (6), we obtain the following expressions for  $v_1, v_2, z', y''$  and  $z''$  in terms of  $x', y'$  and  $x''$ :

$$v_1 = \frac{x - x''}{x' - x''} \quad (7)$$

$$v_2 = \frac{x - x'}{x'' - x'} \quad (8)$$

$$z' = 1 - x' - y' \quad (3a)$$

$$y'' = \frac{x' - x''}{x' - x} y + \frac{x - x''}{x - x'} y' \quad (9)$$

and

$$z'' = 1 - x'' - y'' \quad (4a)$$

In order to solve for  $x', y'$  and  $x''$ , we need three additional equations which must be derived from the condition that at equilibrium  $\Delta G$  according to equation (1) is a minimum. We can minimize  $\Delta G$ , with the five constraints expressed by equations (2) through (6), after the method of Lagrange as was originally done by Rudy<sup>(1)</sup>. We obtain,

$$\Delta G_1 - a_1 \quad -a_4 x' \quad -a_5 y' = 0 \quad (10)$$

$$\Delta G_2 - a_1 \quad -a_4 x'' \quad -a_5 y'' = 0 \quad (11)$$

$$v_1 \frac{\partial \Delta G_1}{\partial x'} - a_2 \quad -a_4 v_1 = 0 \quad (12)$$

$$v_1 \frac{\partial \Delta G_1}{\partial y'} - a_2 \quad -a_5 v_1 = 0 \quad (13)$$



# Contrails

$$v_1 \frac{\partial \Delta G_1}{\partial z'} - a_2 = 0 \quad (14)$$

$$v_2 \frac{\partial \Delta G_2}{\partial x''} - a_3 - a_4 v_2 = 0 \quad (15)$$

$$v_2 \frac{\partial \Delta G_2}{\partial y''} - a_3 - a_5 v_2 = 0 \quad (16)$$

$$v_2 \frac{\partial \Delta G_2}{\partial z''} - a_3 = 0 \quad (17)$$

From equations (12), (13), (15), and (16); (12), (14), (15), and (17); and (12), (14), (15), and (17), we obtain the following additional equations:

$$\left[ \frac{\partial \Delta G_1}{\partial x'} - \frac{\partial \Delta G_1}{\partial y'} \right]_{T,p} = \left[ \frac{\partial \Delta G_2}{\partial x''} - \frac{\partial \Delta G_2}{\partial y''} \right]_{T,p} \quad (18)$$

$$\left[ \frac{\partial \Delta G_1}{\partial z'} - \frac{\partial \Delta G_1}{\partial x'} \right]_{T,p} = \left[ \frac{\partial \Delta G_2}{\partial z''} - \frac{\partial \Delta G_2}{\partial x''} \right]_{T,p} \quad (19)$$

and

$$\Delta G_1 - \Delta G_2 = (x' - x'') \left[ \frac{\partial \Delta G_1}{\partial x'} - \frac{\partial \Delta G_1}{\partial z'} \right]_{T,p} + (y' - y'') \left[ \frac{\partial \Delta G_1}{\partial y'} - \frac{\partial \Delta G_1}{\partial z'} \right]_{T,p} \quad (20)$$

From equations (18), (19), and (20), we can in principle solve for  $x''$ ,  $x'$ , and  $y'$ . However, since the equations for  $\Delta G_1$  and  $\Delta G_2$  are non-linear with respect to the three independent variables  $x''$ ,  $x'$ , and  $y'$ , the solving of the three simultaneous equations is not very simple. Instead, it is more convenient to numerically find the minimum value of  $\Delta G$  according to equation (1) by varying the values of  $x''$ ,  $x'$ , and  $y'$  from 0.0 to 1.0. We can take any small incremental value as we wish. In general, for phase diagram calculations, we have found a value of 0.01 is sufficient.

Since  $x' + y' \leq 1$ , we need only to consider the values of  $x'$ ,  $y'$ , and  $x''$  in the prism as shown in Figure 2 for the computation of  $\Delta G$ . Moreover

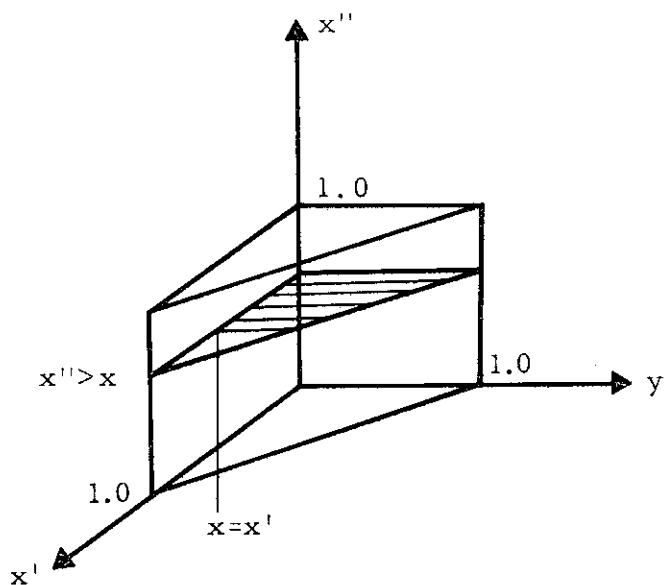

Figure 2. Schematic Representation of the Three Independent Variables  $x'$ ,  $y'$  and  $x''$  for Two-Phase Equilibria in a Ternary System when  $x'' > x$ .

the values of  $x$  always lie between those of  $x'$  and  $x''$ . For each value of  $x''$  greater than  $x$ , we compute  $\Delta G$  for all values of  $x'$  smaller than  $x$ , i.e. the shaded trapezoidal region (in Figure 2) and for each value of  $x'$  smaller than  $x$ , we do the similar computations for all values of  $x'$  greater than  $x$ , i.e. the shaded trapezoidal region in Figure 3.

Since  $v_1, v_2$  and  $y''$  are all positive, rearranging equation (6), we have

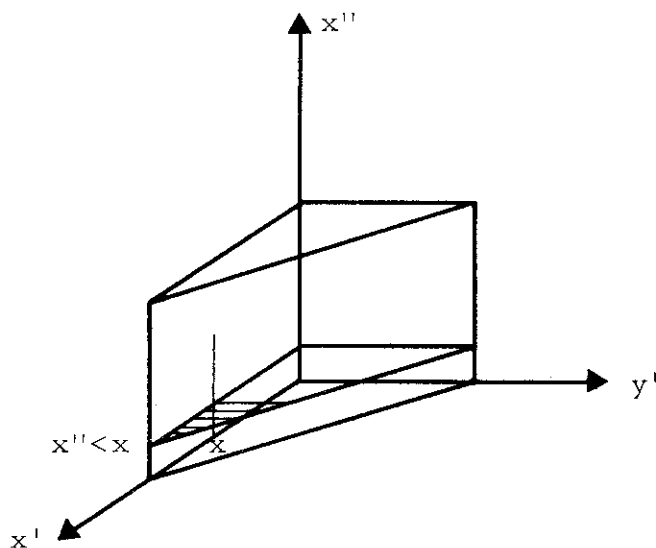

Figure 3. Schematic Representation of the Three Independent Variables  $x'$ ,  $y'$ , and  $x''$  for Two-Phase Equilibria in a Ternary System when  $x'' < x$

$$y' = \frac{y}{v_1} - \frac{v_2}{v_1} y'' \leq \frac{y}{v_1} = \frac{x' - x''}{x - x''} y \quad (21)$$

Equation (21) gives an upper limit of  $y'$ .

The number of computations for searching the minimum of  $\Delta G$  according to equation (1) can be further reduced when we use the additional information provided by the binary phase boundaries.

Before proceeding further, we must have some mathematical expressions for  $\Delta G_1$  and  $\Delta G_2$ . As shown previously,<sup>(2,3)</sup> the free energy of a

single phase of the interstitial type of solid solutions such as the ternary carbides may be adequately represented by the following expression,

$$\Delta G_1 \text{ (in cal/gatom alloy)} = x' \Delta G_{AC_u} + y' \Delta G_{BC_u} + \frac{x'y'\epsilon'}{(1-z')} + RT \left[ x' \ln \frac{x'}{1-z'} + y' \ln \frac{y'}{1-z'} \right] \quad (22)$$

where  $x'$ ,  $y'$  and  $z'$  are atom fractions of A, B, and C in phase 1,  $\epsilon'$  is the interaction parameter for the solid solution  $(A,B)C_u$ , R is the universal gas constant, T is the absolute temperature, and  $\Delta G_{AC_u}$  and  $\Delta G_{BC_u}$  are the Gibbs free energies of formation of the two respective binary phases in cal/gatom A or B. We have a similar expression for  $\Delta G_2$  which is a function of  $x''$ ,  $y''$  and  $z''$ .

Often we have the cases where the solubility of the third component, let's say C, in the solution  $(A,B)C_u$  is so small that for practical purposes, we can take u as zero. For such cases,  $z' = 0$ , we reduce the three independent variables  $x'$ ,  $y'$  and  $x''$  to only  $x'$  and  $x''$ . Therefore, the search for a minimum for  $\Delta G$  according to equation (1) reduces from a three-dimensional to a two-dimensional problem.

### Model Example 1:

Let us now take a hypothetical case where A and B form a series of continuous solid solutions at high temperature; A and C and B and C form two intermediate phases  $AC_v$ ,  $AC_w$  and  $BC_v$ ,  $BC_w$ , respectively as shown in Figures 4 and 5. Moreover, the solubility of C in the solid solution (A,B) is assumed to be small; and  $(A,B)C_v$  and  $(A,B)C_w$  form two series of continuous solid solutions. The homogeneous range with respect to component C is narrow in the solid solution  $(A,B)C_w$  solid solution. We would like now to compare the tie-line distributions in the two-phase regions  $(A,B)-(A,B)C_v$  and  $(A,B)-(A,B)C_w$  calculated at 2000°K using the method described here with those calculated by the simplified method<sup>(1)</sup>.

The Gibbs free energies of the four binary intermediate phases:  $AC_v$ ,  $BC_v$ ,  $AC_w$ , and  $BC_w$  may be represented by the following equations (see Figures 4 and 5).

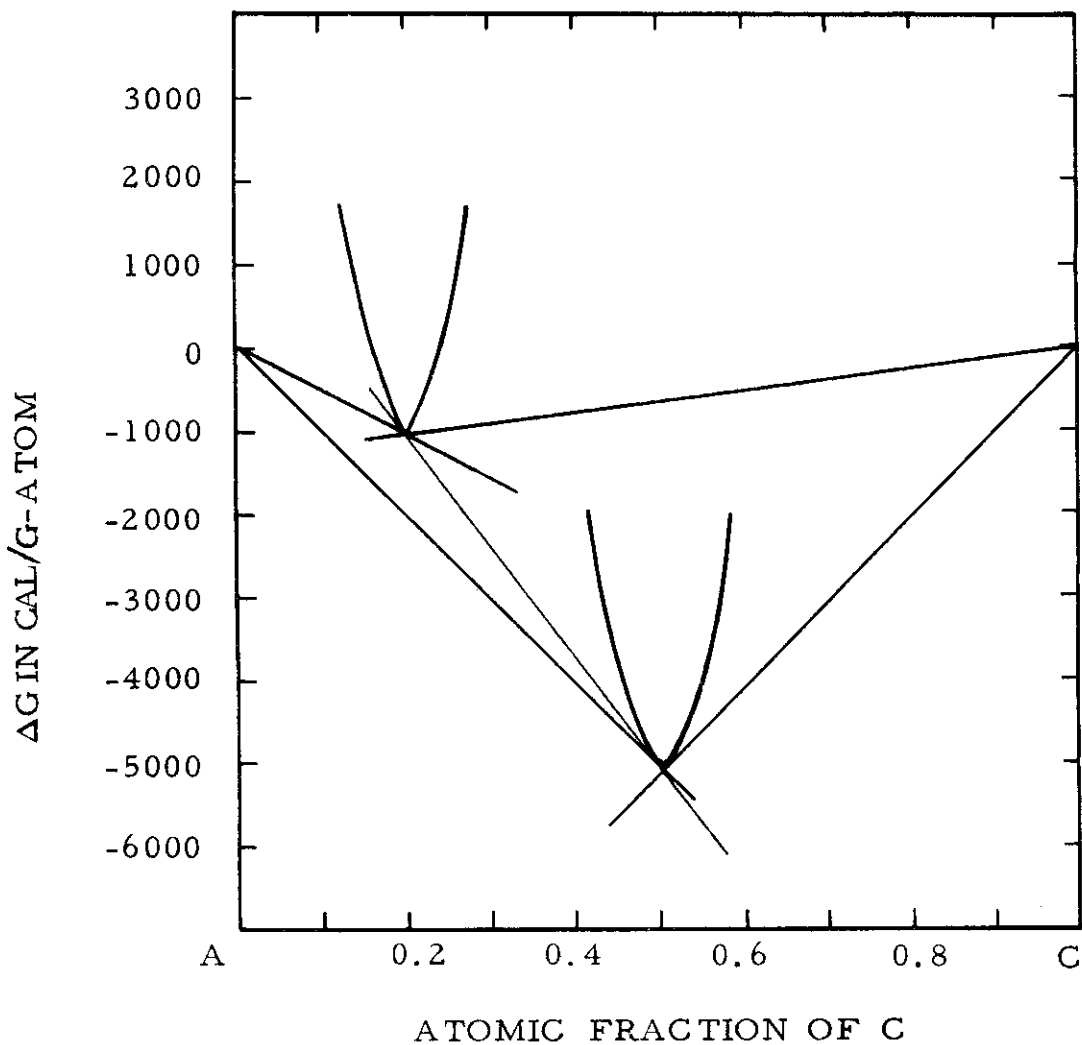

Figure 4. Gibbs Free Energies of the Two Intermediate Phases  $AC_v$  and  $AC_w$  in the binary A-C.

$$\Delta G_{AC_v} = \frac{1}{1-z} \{23,000 - 240,000z + 600,000z^2\} \quad (23)$$

$$\Delta G_{BC_v} = \frac{1}{1-z} \{35,710 - 418,882z + 1,102,162z^2\} \quad (24)$$

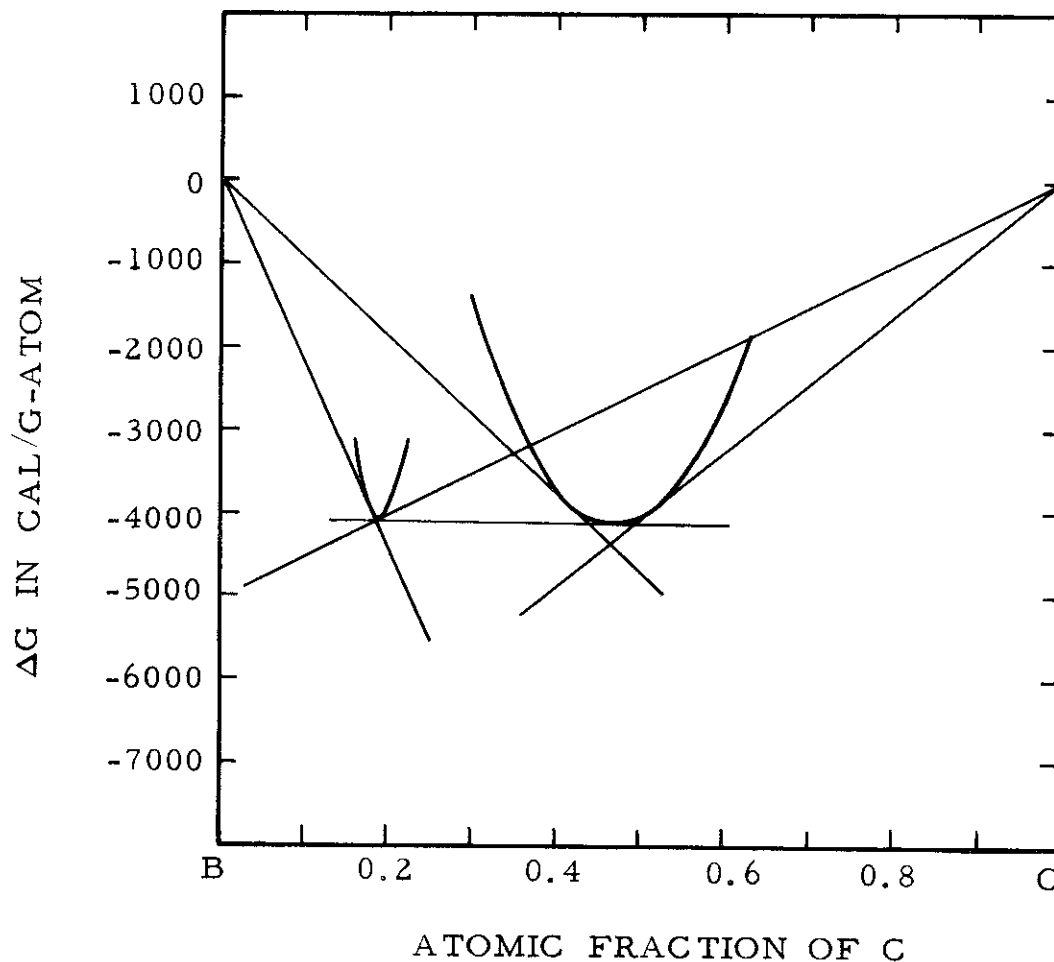

Figure 5. Gibbs Free Energies of the Two Intermediate Phases  $BC_v$  and  $BC_w$  in the Binary A-C.

$$\Delta G_{AC_w} = \frac{1}{1-z} \{121,065 - 504,220 z + 504,220 z^2\} \quad (25)$$

$$\Delta G_{BC_w} = \frac{1}{1-z} \{15,335 - 83,555 z + 89,780 z^2\} \quad (26)$$

The Gibbs free energies of the ternary solutions  $(A,B)C_v$  and  $(A,B)C_w$  may take the same form as equation (22). The interaction parameters for the three solid solutions are taken to be,

# Contrails

$$\epsilon_{A,B} = 5970$$

$$\epsilon_{(A,B)C_v} = 3980$$

$$\epsilon_{(A,B)C_w} = 3980$$

We shall first consider the two-phase equilibria between the solid solutions (A,B) and (A,B) $C_v$ . Since we assume that the intermediate phases  $AC_w$  and  $BC_w$  are not stable in the binary systems, the phase  $AC_v$  then becomes stable. Accordingly, we have

$$\Delta G_1 = 5970 x^1 y^1 + RT (x^1 \ln x^1 + y^1 \ln y^1) \quad (27)$$

$$\begin{aligned} \Delta G_2 = & x'' \Delta G_{AC_v} + y'' \Delta G_{BC_v} + \frac{3980 x'' y''}{1 - z''} + \\ & + RT \left[ x'' \ln \frac{x''}{1 - z''} + y'' \ln \frac{y''}{1 - z''} \right] \quad (28) \end{aligned}$$

One can see from Figures 6 and 7 that the tie-line distribution between the solid solutions (A,B) and (A,B) $C_v$  calculated using the method described here agrees well with that calculated using the simplified method. This is to be expected since the range of homogeneity with respect to component C in (A,B) $C_v$  is relatively narrow. The simplified method for calculating the two-phase equilibria in ternary systems has been discussed extensively by Rudy<sup>(1)</sup>. It suffices to say that the compositions of the two co-existing phases are where the concentration free energy gradients are the same, i.e.

$$\frac{d\Delta G_1}{dx^1} = \frac{d\Delta G_2}{dx''} \quad (29)$$

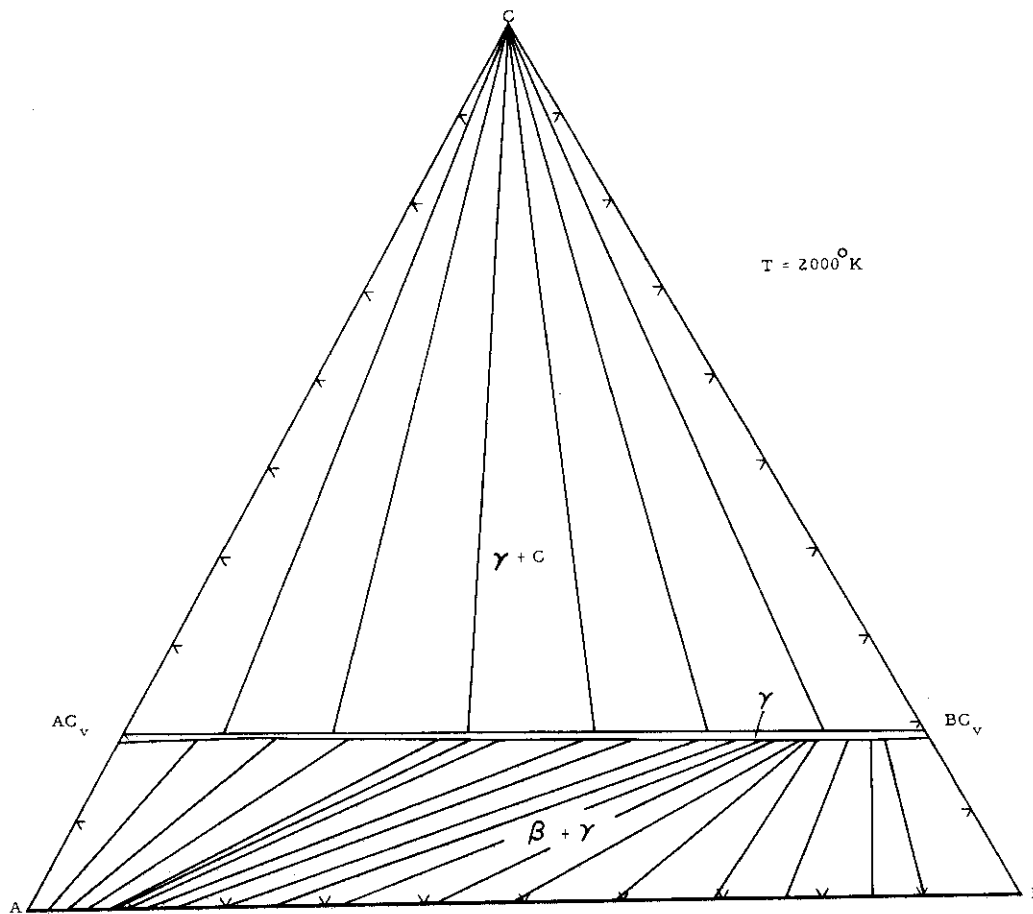

Figure 6. Phase Equilibria Between Phases  $\beta$  and  $\gamma$  and  $\gamma$  and C in the System A-B-C at 2000°K Calculated Using the General Method.

The concentration free energy gradient curves for the solid solutions (A,B), (A,B) $C_v$  and (A,B) $C_w$  are shown in Figure 8.

Next, we consider the two-phase equilibria between the solid solutions (A,B) and (A,B) $C_w$ . In this case, we assume that the phases  $AC_v$  and  $BC_v$  do not appear in the two respective binaries. Since the homogeneous range for the phase  $BC_w$  is relatively large and the free energies of  $AC_w$  phase increase rapidly at concentrations of C-component higher and lower



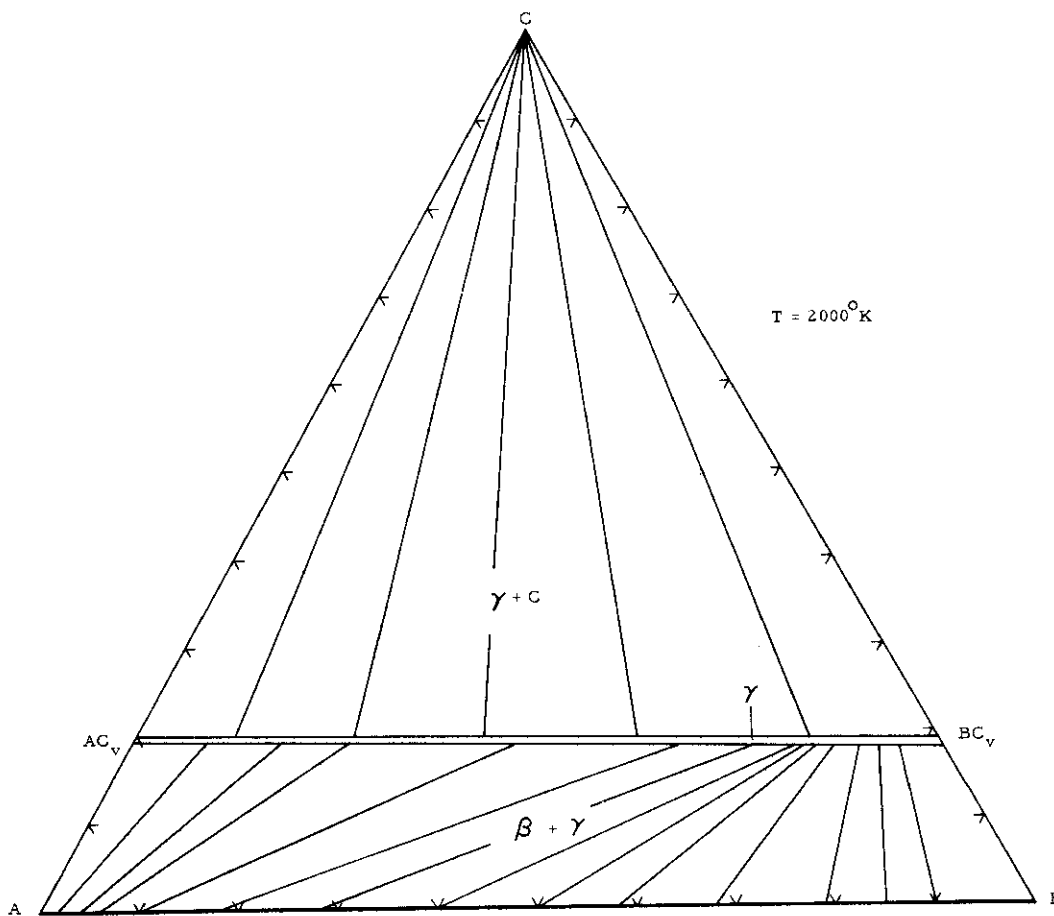

Figure 7. Phase Equilibria Between Phases  $\beta$  and  $\gamma$  and  $\gamma$  and C in the System A-B-C at 2000°K Calculated Using the Simplified Method.

0.5, the tie-line distribution calculated (Figure 9) used this simplified method does not agree well with that calculated (Figure 10) using the general method described here again as expected. Moreover, the A-B-rich phase boundary of the solid solution  $(A,B)C_w$  calculated using the method described in this paper shows a curvature as expected while that calculated using the simplified method does not.

It should be pointed out here since the solubilities of A and B in C are assumed to be negligible, the tie lines in the two-phase regions  $(A,B)C_v$  and C and  $(A,B)C_w$  and C (Figures 6, 7, 9, and 10) were not calculated and must be pointed toward the pure component.

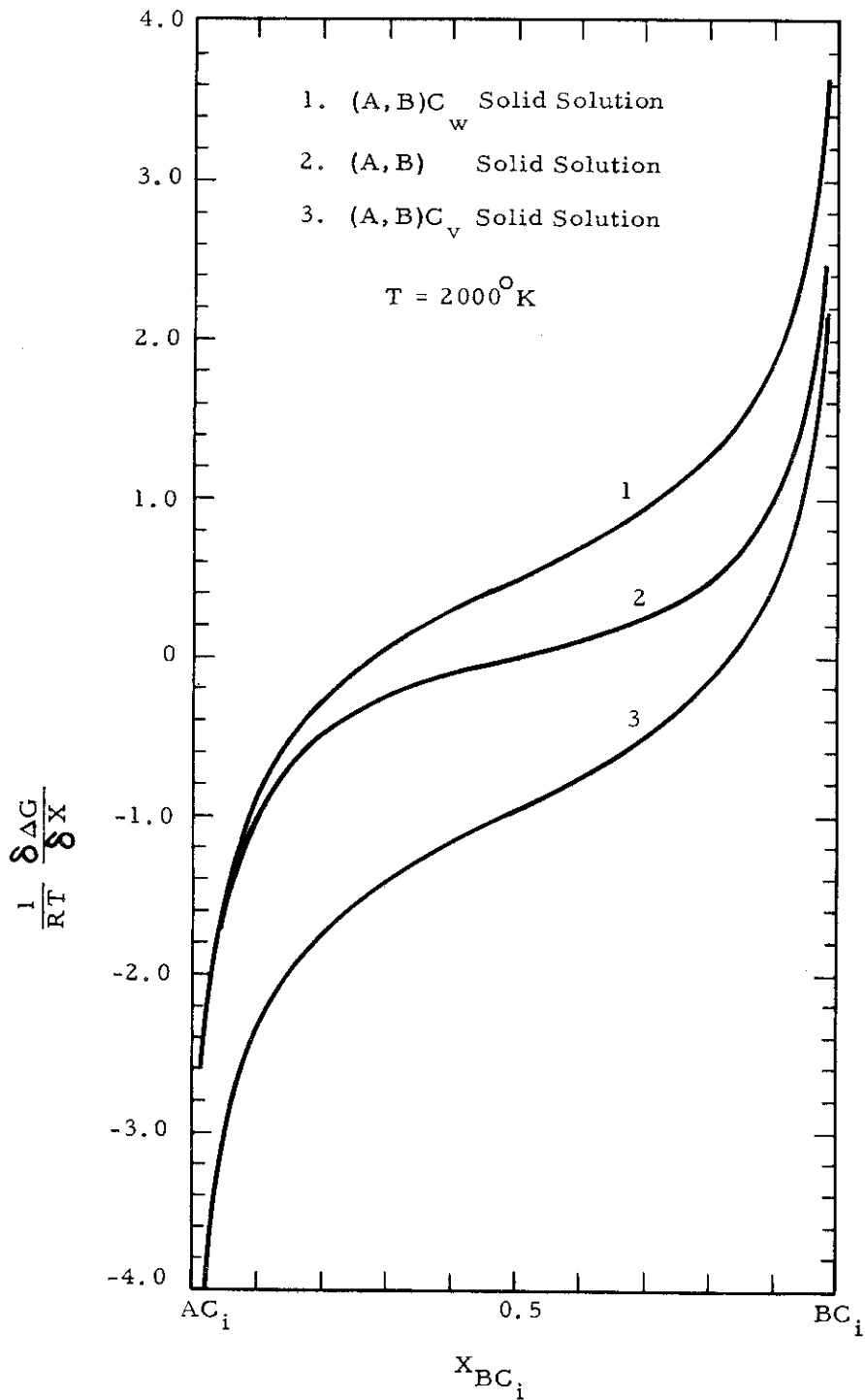

Figure 8. Concentration Free Energy Gradient Curves for Solutions (A,B), (A,B)C<sub>v</sub> and (A,B)C<sub>w</sub> at 2000°K.

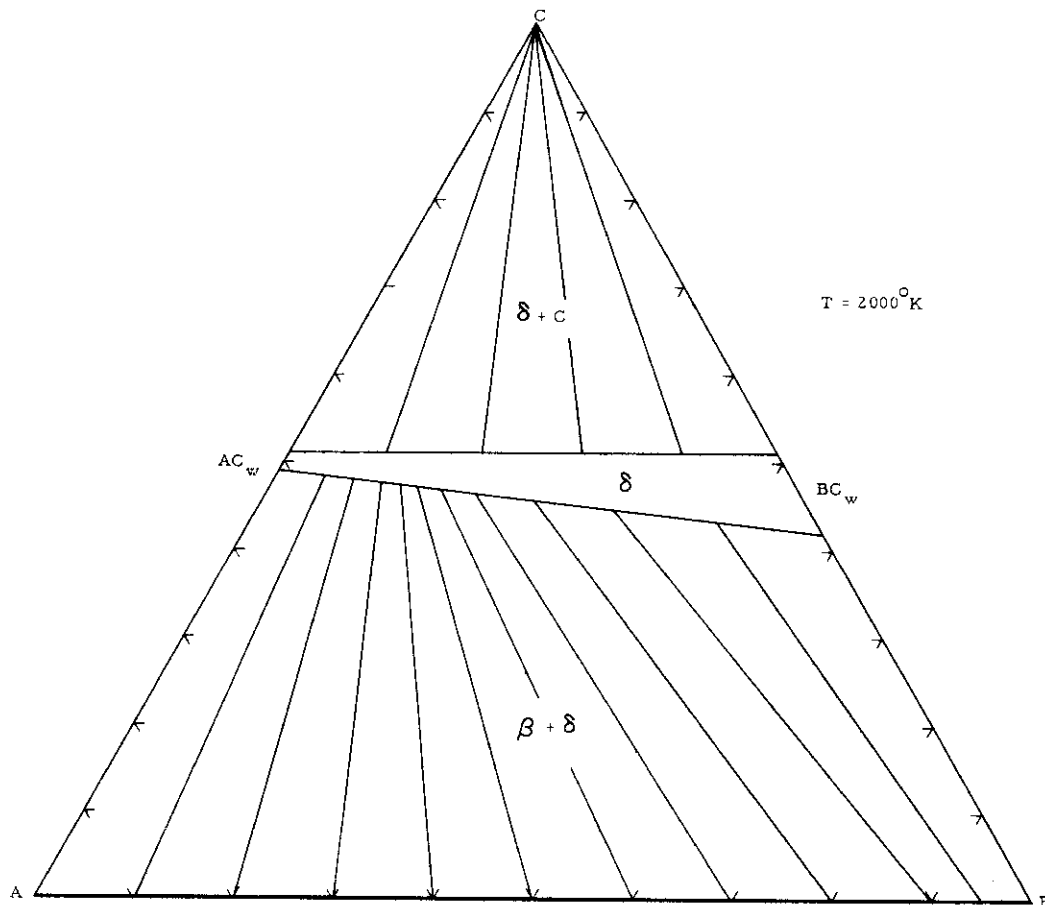

Figure 9. Phase Equilibria Between  $\beta$  and  $\delta$  and  $\delta$  and C in the System A-B-C at 2000°K Calculated Using the Simplified Method.

B. THREE-PHASE EQUILIBRIA IN THREE-COMPONENT SYSTEM

In a similar manner as for the two-phase equilibria, the Gibbs free energy of a three-phase alloy  $A_x B_y C_z$  as shown in Figure 11 is a linear combination of the Gibbs free energies of formation of the three co-existing phases  $A_{x'} B_{y'} C_{z'}$ ,  $A_{x''} B_{y''} C_{z''}$  and  $A_{x'''} B_{y'''} C_{z'''}$ :

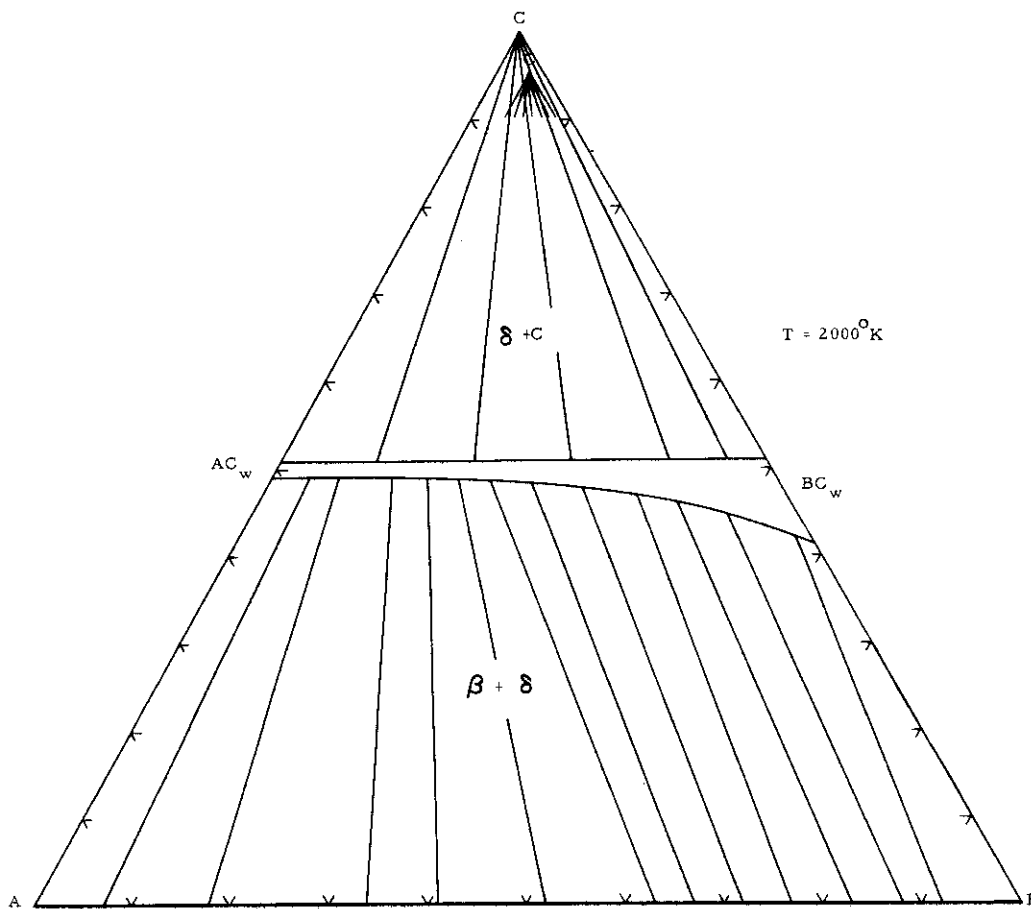

Figure 10. Phase Equilibria Between  $\beta$  and  $\delta$  and  $\delta$  and C in the System A-B-C at 2000°K Calculated Using the General Method.

$$\Delta G = \nu_1 \Delta G_1 + \nu_2 \Delta G_2 + \nu_3 \Delta G_3 \quad (30)$$

with the following constraints:

$$\nu_1 + \nu_2 + \nu_3 = 1 \quad (31)$$

$$x^i + y^i + z^i = 1 \quad (32)$$

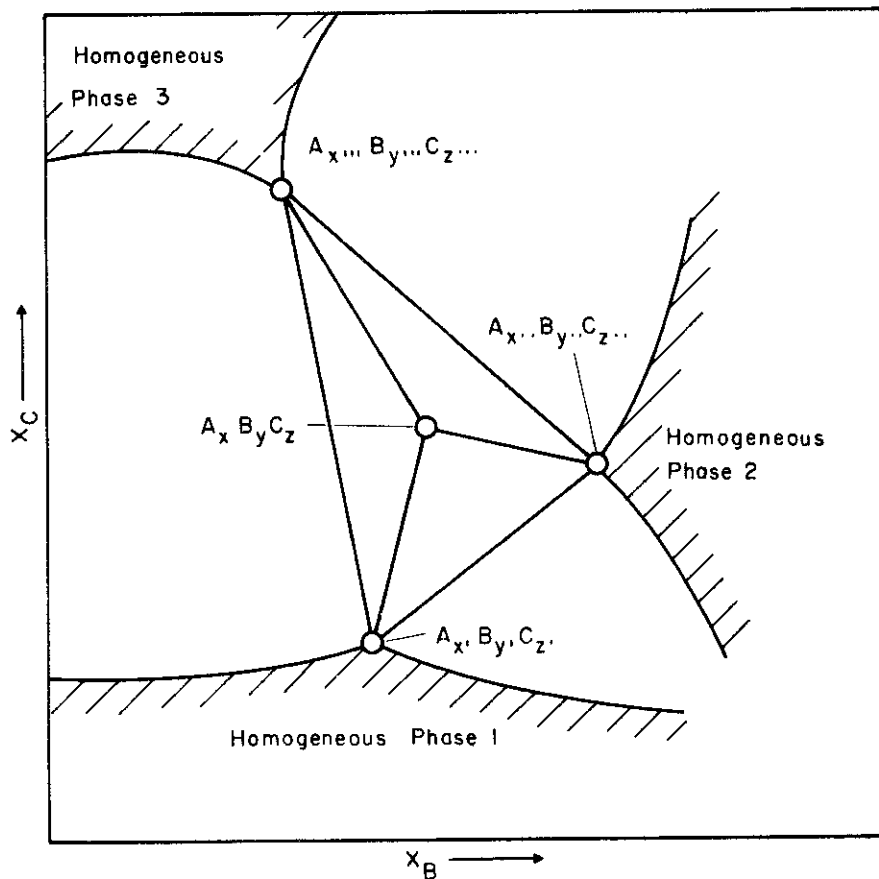

Figure 11. Three-Phase Equilibrium in a Ternary System

$$x'' + y'' + z'' = 1 \quad (33)$$

$$x''' + y''' + z''' = 1 \quad (34)$$

$$v_1 x' + v_2 x'' + v_3 x''' = x \quad (35)$$

$$v_1 y' + v_2 y'' + v_3 y''' = y \quad (36)$$

We have twelve unknowns and six equations (31 through 36). Therefore, we have six independent variables. It is no longer practical for us to use the similar method as for the two-phase equilibria to find the combination of the compositions of the three co-existing phases where  $\Delta G$  according to equation (30) is a minimum.

# Contrails

Fortunately, we can reduce the six independent variables to two by taking advantage of the fact that the boundaries of a three-phase equilibrium are nothing but the limiting tie-lines of the three adjacent two-phase equilibria. We shall first discuss the method of seeking the compositions  $(x''', y''', z''')$  of the third co-existing phase when the compositions  $(x', y', z')$  and  $(x'', y'', z'')$  of the other two co-existing phases are known. We will then discuss how to find the compositions  $x', y', z'$  and  $x'', y'', z''$ . Under such conditions, instead of having the six constraints as expressed by equations (31) through (36), we have only four boundary conditions: Equations (31), (34), (35), and (36) with six unknowns, i.e.  $\nu_1, \nu_2, \nu_3, x''', y'''$  and  $z'''$ . Therefore, we have ultimately two independent variables. We can choose any two variables as we wish, but from a practical point of view, it is convenient to choose the two variables  $z'''$  and  $y'''$ . Expressing  $\nu_1, \nu_2, \nu_3$  and  $x'''$  in terms of  $y'''$  and  $z'''$ ; we have

$$\nu_1 = \frac{(y' - y)(z''' - z) - (z'' - z)(y''' - y)}{D} \quad (37)$$

$$\nu_2 = \frac{(y - y')(z''' - z') - (z - z')(y''' - y')}{D} \quad (38)$$

$$\nu_3 = 1 - \nu_1 - \nu_2 \quad (31a)$$

$$x''' = 1 - y''' - z''' \quad (34a)$$

where

$$D = (y'' - y')(z''' - z') - (z' - z')(y''' - y') \quad (39)$$

To find the values of  $y'''$  and  $z'''$  we again have to use the condition that at equilibrium  $\Delta G$  according to equation (30) is a minimum. The method for seeking the values of  $y'''$  and  $z'''$  where  $\Delta G$  is a minimum is similar to the method used for solving the two-phase equilibria discussed earlier.

For the three-phase equilibria resulting from a miscibility gap in one of the solid solutions, the compositions of the miscibility gap of this solid solution are well-defined. In this case, we can solve for the composition of third co-existing phase using the method described here.

## Model Example 2:

We shall use the same data as in Model Example 1 to illustrate the application of the method described here. When the temperature is lower from 2000°K to 1250°K, a miscibility gap results from the solid solution (A,B). The compositions of the miscibility gap at 1250°K are  $x' = 0.83$ ,  $y' = 0.17$  and  $x'' = 0.17$  and  $y'' = 0.83$ . Again, as shown in Figures 12 and 13, the phase equilibria calculated using the simplified method agree well with those calculated using the general method with the exception that homogeneous range of the solid solution (A,B) $C_v$  with respect to component C is narrower. The free energy-concentration-gradient curves used to determine the phase equilibria at 1250°K as shown in Figure 12, are displaced in Figure 14.

Referring to Figure 15, the method for seeking the composition of the three co-existing phases  $\beta$ - $\gamma$ - $\delta$  will be discussed using the following conditions:

$$\begin{array}{lll}
 \text{at } x_1, y_1, z_1: & \Delta G (2\phi \text{ between } \beta-\delta) & < \Delta G(2\phi \text{ between } \beta-\gamma) \\
 & & < \Delta G(3\phi \text{ between } \beta-\gamma-\delta) \\
 \\
 \text{at } x_2, y_2, z_2: & \Delta G (3\phi \text{ between } \beta-\delta-\gamma) & < \Delta G(2\phi \text{ between } \beta-\delta) \\
 & & < \Delta G(2\phi \text{ between } \beta-\gamma) \\
 \\
 \text{at } x_3, y_3, z_3 & \Delta G (2\phi \text{ between } \beta-\gamma) & < \Delta G(2\phi \text{ between } \beta-\delta) \\
 & & < \Delta G(3\phi \text{ between } \beta-\gamma-\delta)
 \end{array}$$

In reality, we don't have any idea about the compositions of the three co-existing phases except we know there is a three-phase equilibrium  $\beta$ - $\gamma$ - $\delta$  since the corresponding phase in the A-C binary is not stable. Thus, we can start, let's say, with a composition  $x_1, y_1, z_1$  and ask ourselves what possible three-phase field it is in. We know one of the phase boundaries of this three-phase equilibrium  $\beta$ - $\gamma$ - $\delta$  is the tie-line between  $\beta$ - $\delta$  and furthermore, this tie-line must lie at the left of the composition  $x_1, y_1, z_1$ . Thus, we can start with various compositions at the left of the composition  $x_1, y_1, z_1$  and first find the corresponding compositions of the two co-existing phases  $\beta$  and  $\delta$ . Knowing the various values of  $x', y', z'$  ( $\beta$ -phase) and  $x'', y'', z''$  ( $\delta$ -phase), one can calculate the corresponding values of  $x''', y''', z'''$  ( $\gamma$ -phase) and the corresponding values of  $\Delta G (3\phi \text{ between } \beta-\delta-\gamma)$ . One then compares the lowest value among all the  $\Delta G$  values calculated with those of  $\Delta G (2\phi \text{ between } \beta-\delta)$  and  $\Delta G(2\phi \text{ between } \beta-\gamma)$

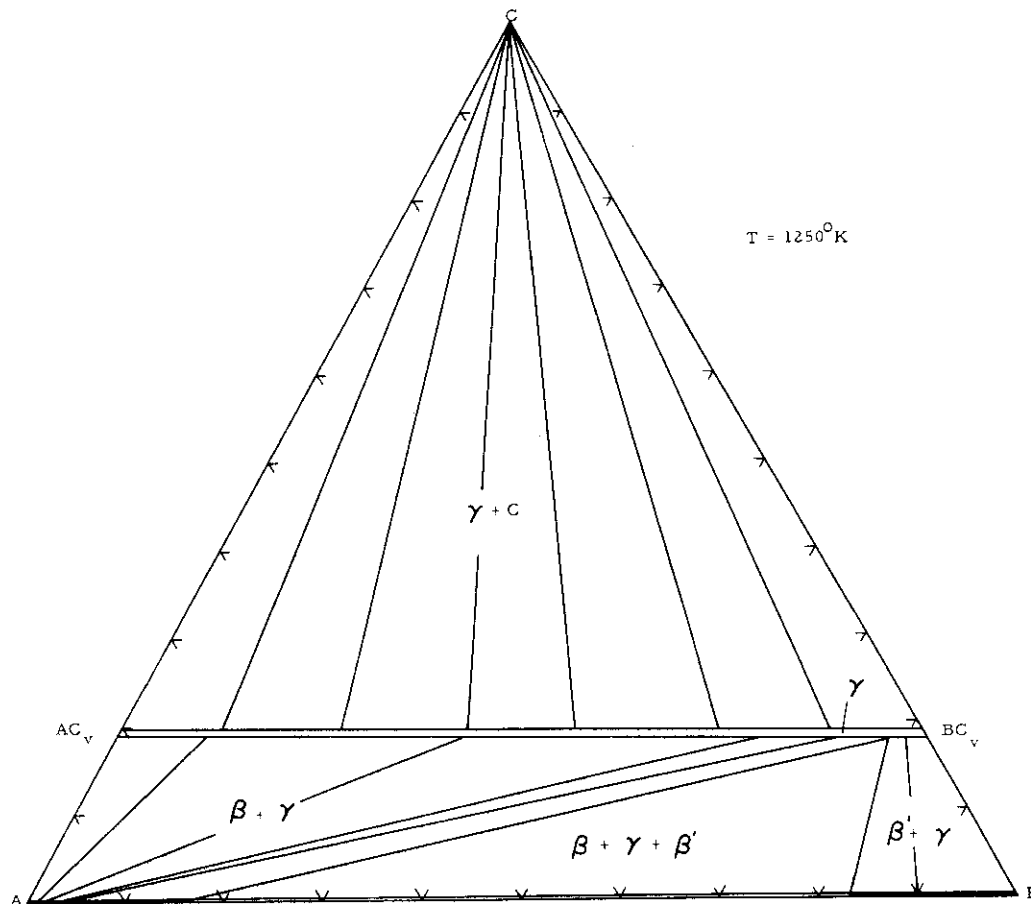

Figure 12. The Phase Equilibria Calculated Using the Simplified Method in the System A-B-C at 1251°K When the Two Binary Phases  $AC_w$  and  $BC_w$  are Unstable.

using the method described earlier. The stable equilibrium is defined by the lowest value of the Gibbs free energy. If  $\Delta G$  ( $2\phi$  between  $\beta-\delta$ ) is the lowest, the three-phase equilibrium must lie at the right of the chosen values of  $x_1, y_1, z_1$ . If on the other hand, the value of  $\Delta G$  ( $2\phi$  between  $\beta-\gamma$ ) is the lowest, then the three-phase equilibrium must lie to the left of the chosen values of  $x_1, y_1, z_1$ . If the value of  $\Delta G$  ( $3\phi$  between  $\beta-\gamma-\delta$ ) is the lowest, then we have found the three-phase equilibrium. A simple and rapid iteration process can be prepared to solve the compositions of the three co-existing phases.



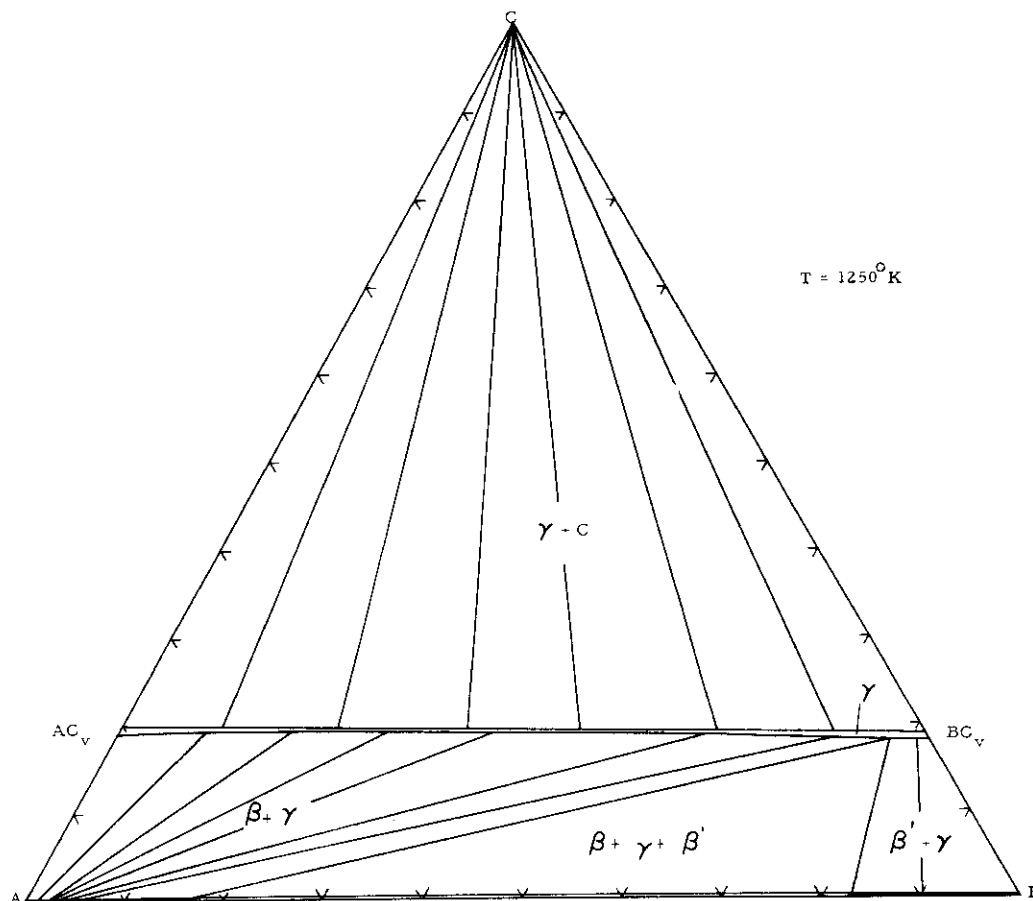

Figure 13. The Phase Equilibria Calculated Using the General Method in the System A-B-C at 1250°K When the Two Intermediate Phases  $AC_w$  and  $BC_w$  are Unstable.

Model Example 3:

Using the same data as in Model Example 1 and assuming all the three phase  $BC_v$ ,  $AC_w$  and  $BC_w$  appear in the corresponding two binaries A-C and B-C, we shall use the method described here to find the three-phase field  $\beta-\gamma-\delta$  and the tie-lines in the three two-phase fields:  $\beta-\delta$ ,  $\beta-\gamma$  and  $\gamma-\delta$ . The phase diagrams calculated at 2000°K using the general method as shown in Figure 16 agrees well with that calculated using the simplified method (Figure 17). The obvious difference between the two calculated

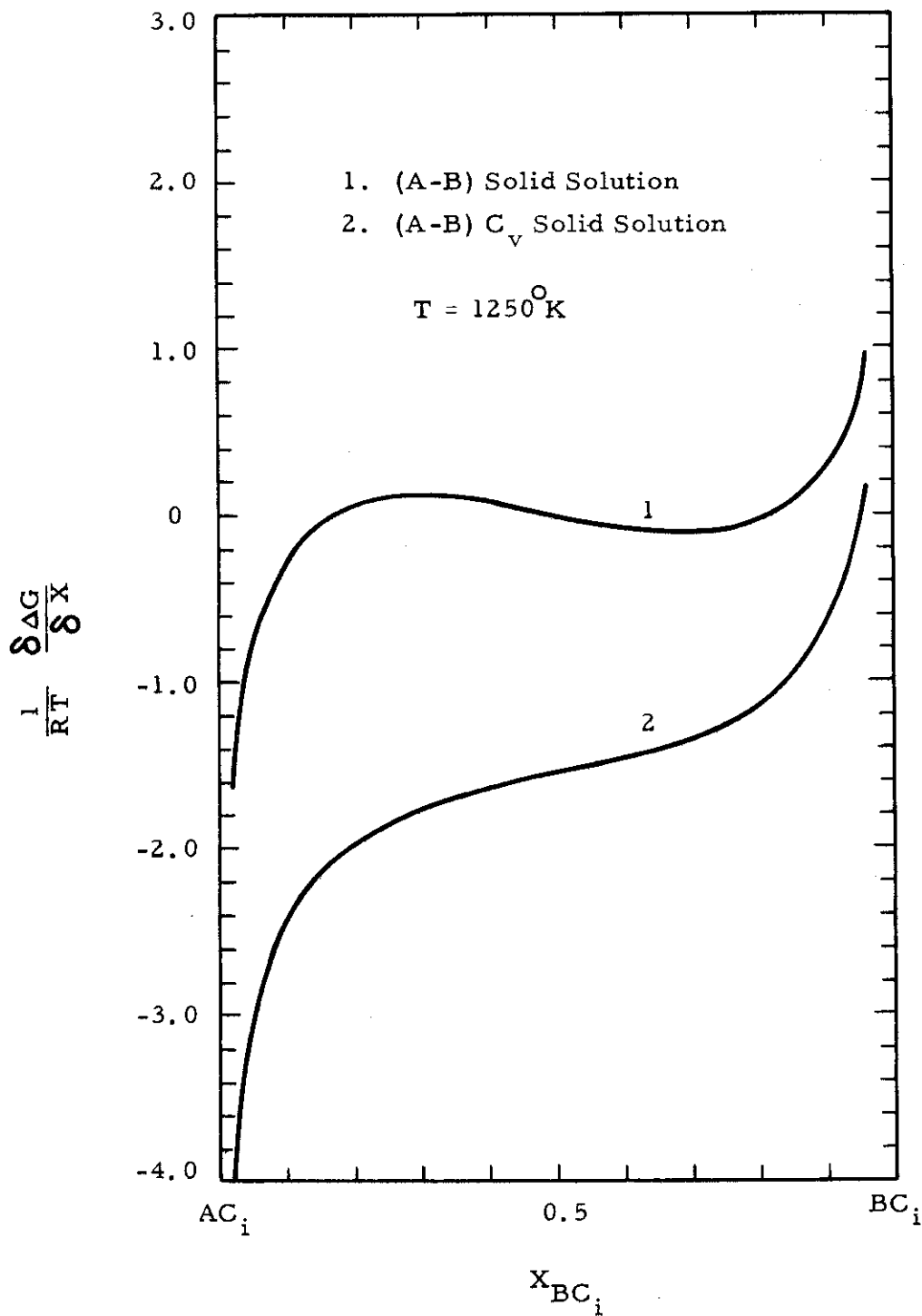

Figure 14. The Concentration-Free-Energy-Gradient Curves for Solutions (A,B) and (A,B)C<sub>v</sub> at 1250°K.

# Contrails

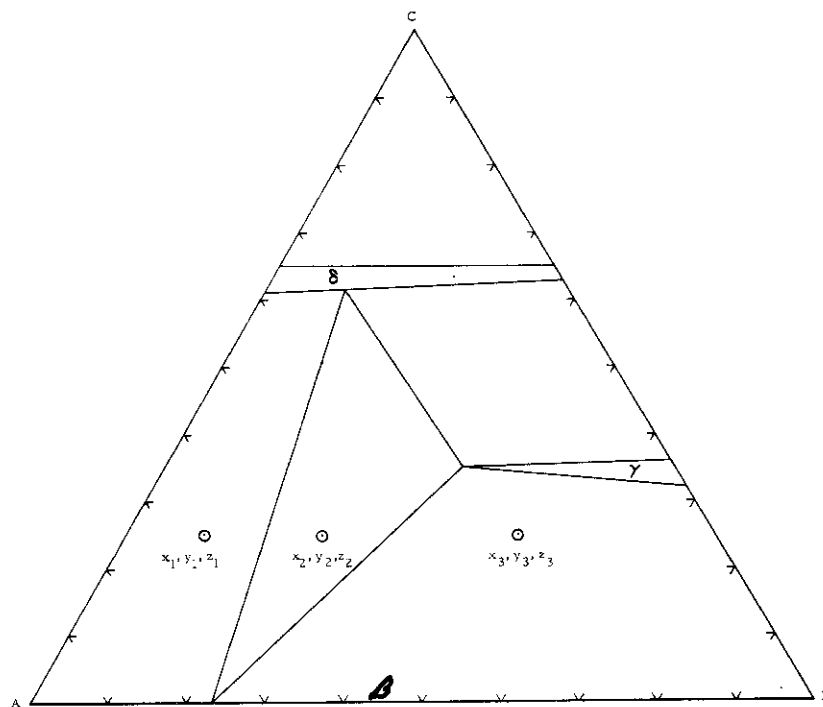

Figure 15. A Typical Ternary Phase Diagram with a Three-Phase Field Resulting from the Absence of a Corresponding Intermediate Phase in the Binary A-C.

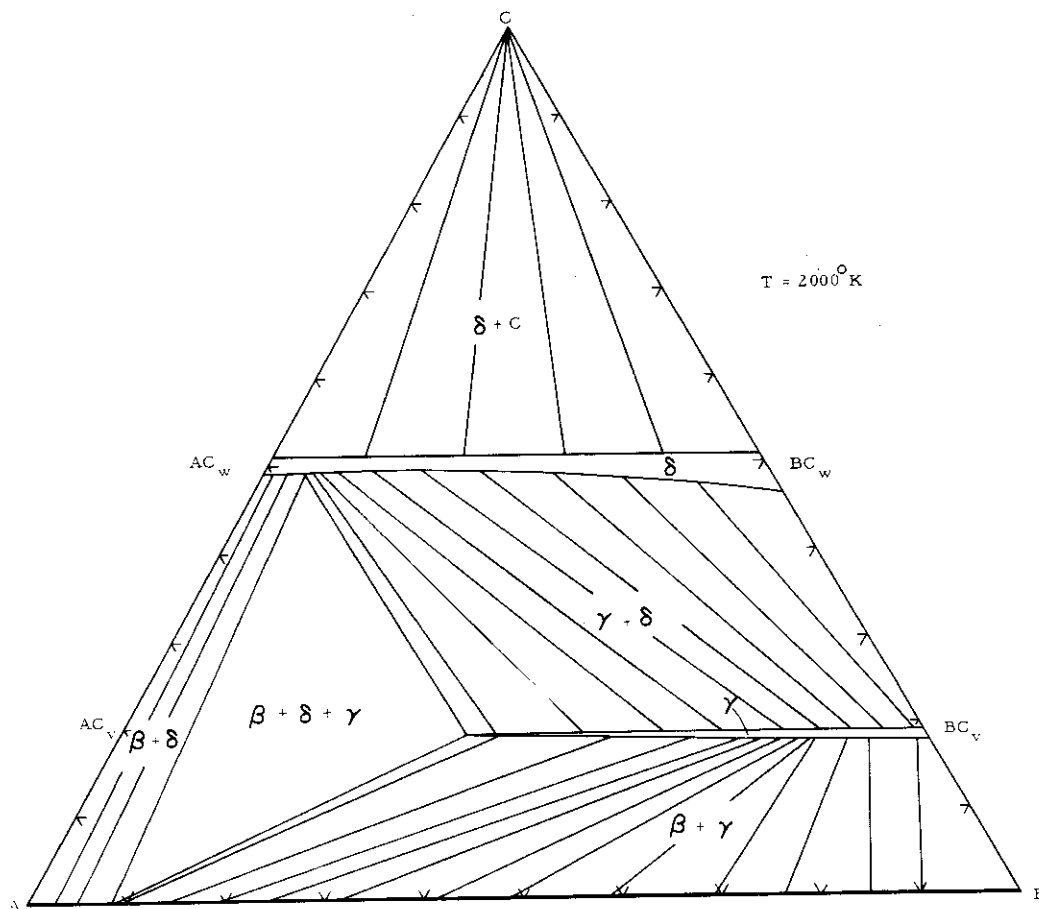

Figure 16. Phase Equilibria Calculated Using the General Method in the System A-B-C at 2000°C when the three Phases  $AC_w$ ,  $BC_v$  and  $BC_w$  are Stable in the Binaries

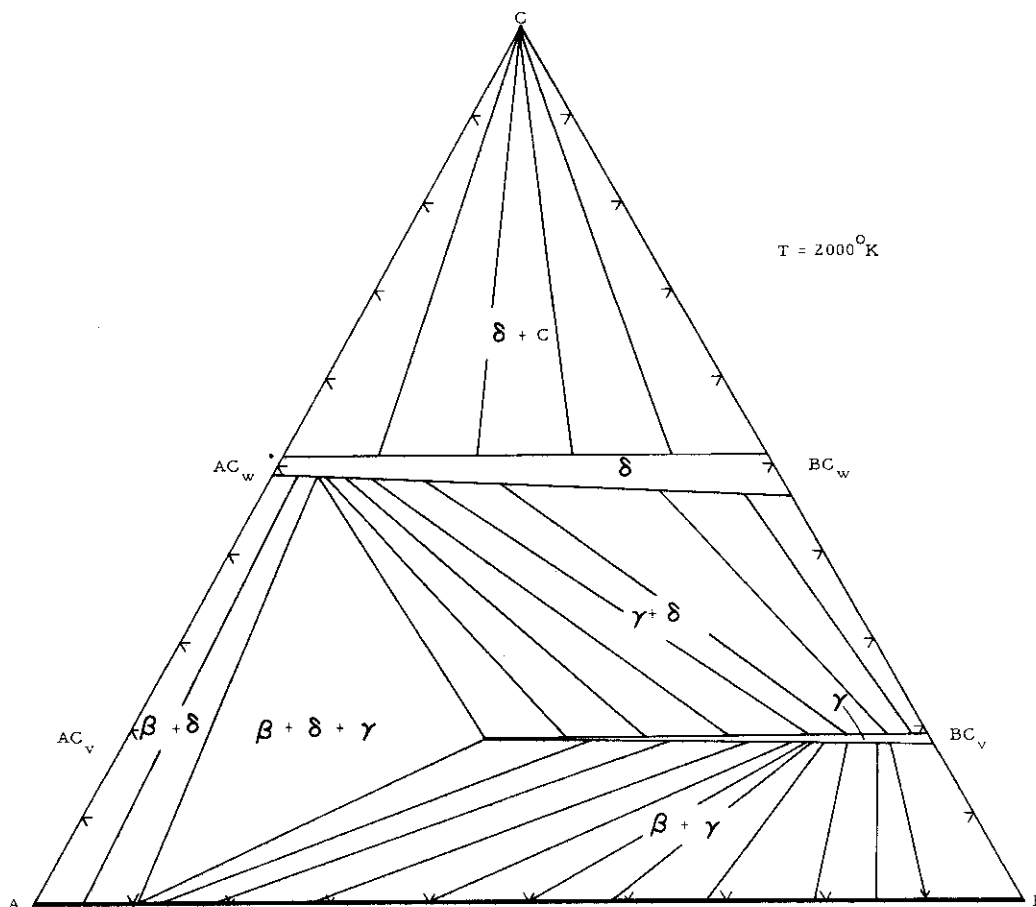

Figure 17. Phase Equilibria Calculated Using the Simplified Method in the System A-B-C at 2000°K When the Three Phases  $AC_w$ ,  $BC_v$  and  $BC_w$  are Stable in the Binaries.

phase diagrams is the (A-B) rich homogeneous range of the solid solution (A-B) $C_w$  with respect to C-component. The homogeneous range calculated using the general method shows the curvature while that calculated using the simplified method does not.

Although the technique of fixing the compositions of the co-existing phases for a three-phase equilibrium using the simplified method has been discussed extensively previously, it is worthwhile to point out that in addition to the condition at equilibrium, the free-energy-concentration gradients, i.e.

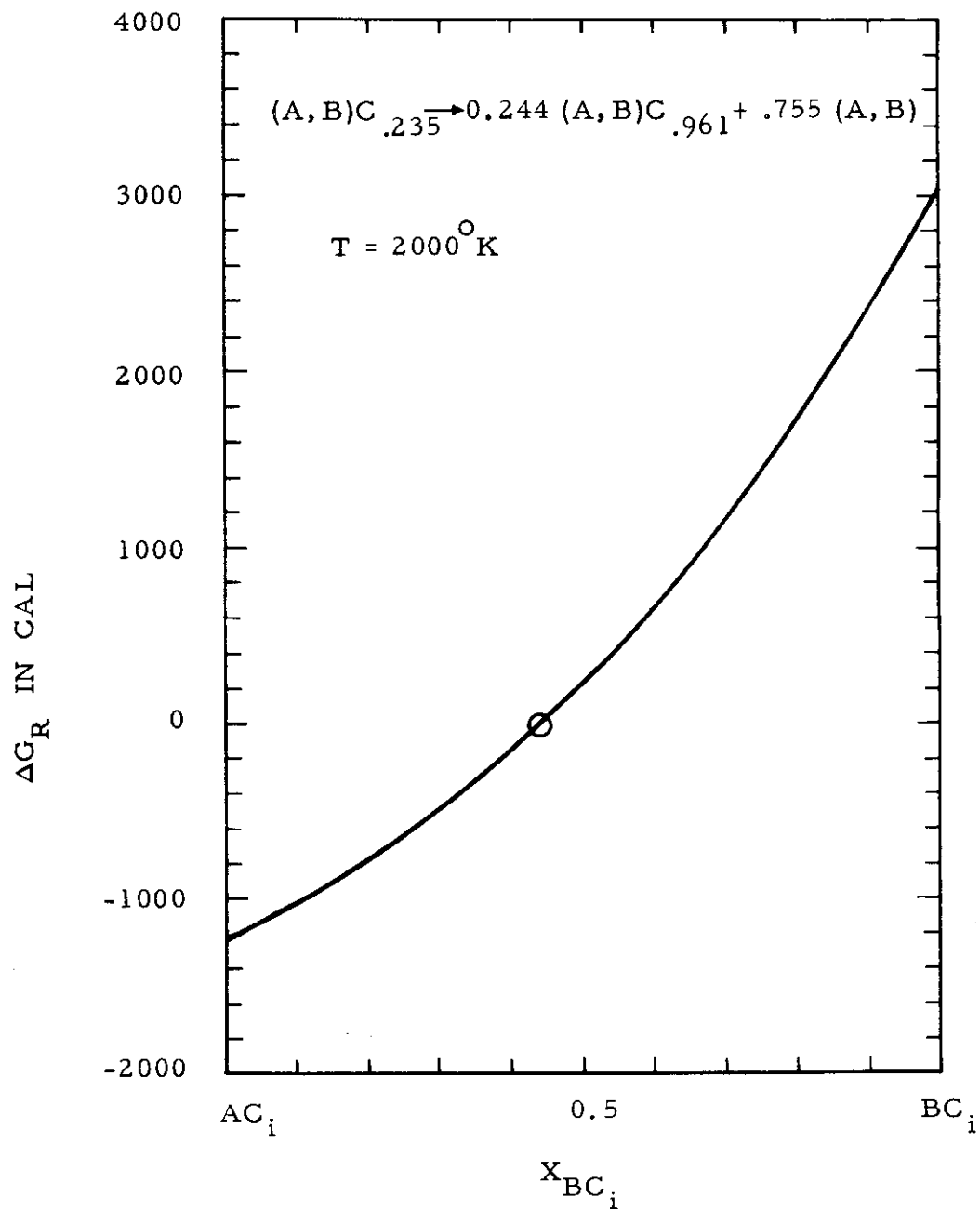
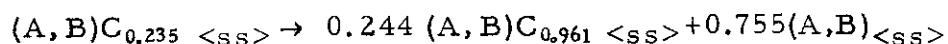

Figure 18. Integral Gibbs Free Energies of Decomposition of  $(A, B)C_{.235}$  to  $(A, B)C_{.961}$  and  $(A, B)$ .

$$\frac{\partial \Delta G_{(A,B)C_i}}{\partial x_{BC_i}}$$

must all be necessarily equal, we need the additional stability condition in order to fix the compositions of the three phases. Expressing in thermodynamic terms, the stability condition simply says that at equilibrium the integral Gibbs free energy of decomposing an alloy  $(A,B)C_v$  into two other alloys  $(A,B)C_u$  and  $(A,B)C_w$  must be zero. For the model example described here, the total Gibbs free energy of decomposition of the alloy  $(A,B)C_{0.235}$  to the alloys  $(A,B)C_{0.961}$  and  $(A,B)$  according to the following reaction is shown in Figure 18.



### III. APPLICATION OF THE METHOD DEVELOPED TO THE SYSTEM

#### Ta-Hf-C

As already discussed earlier, in order to precalculate the phase equilibria in a ternary system, it is necessary to know the free energies of the binary phases as a function of composition and the solution behaviors of the ternary phases. In the binary system Hf-C, one intermediate phase, hafnium monocarbide HfC (B1-type), forms with a wide range of homogeneity<sup>(4)</sup>. The  $\alpha$ -Hf terminal phase is stabilized by the addition of carbon atoms to higher temperatures. However, since little is known about the free energy of this phase as a function of composition, we shall at the present ignore the stabilization of the  $\alpha$ -phase to high temperatures and assume that metal and carbon components at the metal-rich boundaries of the monocarbide phase are in equilibrium with those in the  $\beta$ -Hf terminal phase at high temperatures.

In addition to the monocarbide phase (B1-type), a second intermediate phase,  $Ta_2C$  forms in the system tantalum-carbon. Tantalum subcarbide,  $Ta_2C$ , is polymorphic. The low-temperature form,  $\alpha$ - $Ta_2C$ , has a hexagonal close-packed arrangement of the metal atoms. The distribution of the carbon atoms among the interstitial sites is not known but undoubtedly dependent on temperature.

The high-temperature form  $\beta$ -Ta<sub>2</sub>C, probably has the same arrangement of metal atoms<sup>(5)</sup> but differs in the degree of disorder in the carbon sublattice from the  $\alpha$ -modification. Again, for the lack of pertinent thermodynamic data with respect to the two modifications of Ta<sub>2</sub>C, we shall assume  $\alpha$ -Ta<sub>2</sub>C and  $\beta$ -Ta<sub>2</sub>C to be of one phase for the calculation at the present.

The Gibbs free energies of the monocarbide and subcarbide phases will be represented by a sum of two contributions: the thermal and the configurational contributions to the total free energies of these phases, i. e.

$$\Delta G = \Delta G^{\text{th}} + \Delta G^{\text{conf}} \quad (39)$$

Since the free energies of formation<sup>(6)</sup> for both of the two monocarbide phases at the stoichiometric composition have been determined, we shall represent the free energies of formation due to thermal vibration for compositions less than  $x_C = 0.5$  by,

$$\Delta G^{\text{th}} (\text{B1 phase}) = 2(1-z) \Delta G_f + (1-2z)(a + bz + Cz^2) \quad (40)$$

where  $\Delta G_f$  is the Gibbs free energy of formation of the stoichiometric monocarbide phase in cal/gatom alloy,  $z$  is the atom fraction of the carbon component, and  $a$ ,  $b$  and  $c$  are parameters needed to be determined. When  $b$  and  $c$  are set equal to zero, we have the Wagner-Schottky<sup>(6, 7, 8, 9)</sup> vacancy model with 'a' being the Gibbs free energy of forming a carbon vacancy on the carbon sublattice. For the free energy contribution due to configurational mixing of carbon atoms among the various lattice sites, we assume ideal entropy of mixing which is reasonable at high temperatures. Accordingly, we have

$$\Delta G^{\text{conf}} = RT \left[ z \ln \frac{z}{1-2z} + (1-z) \ln \frac{1-2z}{1-z} \right] \quad (41)$$

For the subcarbide phase, the thermal contribution to the total free energy will be represented by a 3rd degree polynominal, i. e.

$$\Delta G^{\text{th}} = a' + b'z + c'z^2 + d'z^3 \quad (40b)$$

For the configurational free energy, we shall use the model developed by Rudy<sup>(10)</sup>. In this model, one assumes that the two interstitial sites occupied by the carbon atoms are energetically different by an amount of  $\Delta E$ . Expressing in terms of two gram atoms of metal ( $\text{Me}_2\text{C}_w$ ), the configurational free energy as derived earlier<sup>(10)</sup> is

$$\Delta G_{\text{Me}_2\text{C}_w}^{\text{conf}} = z_B \Delta E + \left[ z_A \ln z_A + (1-z_A) \ln (1-z_A) + z_B \ln z_B + (1-z_B) \ln (1-z_B) \right] RT \quad (42)$$

where  $\Delta E$  is the energy difference between the two interstitial sites in the cal/2-gram atom metal,  $z_A$  is the mole fraction of carbon atoms on the A-sites,  $(1-z_A)$  is the mole fraction of vacant A-sites,  $z_B$  is the mole fraction of the carbon atoms on the energetically unfavorable B-sites and  $(1-z_B)$  is the mole fraction of the vacant B-sites. It is understood that

$$z_A + z_B = w \quad (43)$$

However, since it is more convenient to discuss the free energies of solid solutions in terms of one gram atom alloy, we shall divide equation (42) by  $(2+w)$  and change the variable from  $w$  to  $z$  (the atom fraction of carbon atoms in the solution). Accordingly, we have

$$\Delta G_{\text{Me}_{1-z}\text{C}_z}^{\text{conf.}} = \frac{1-z}{2} \left[ z_B \Delta E + \left[ z_A \ln z_A + (1-z_A) \ln (1-z_A) + z_B \ln z_B + (1-z_B) \ln (1-z_B) \right] RT \right] \quad (44)$$

Using the well-known thermodynamic relationships relating the partial molar and integral quantities, we have,



# Contrails

$$\begin{aligned} \Delta \bar{G}_{Me}^{conf} &= \Delta G - z \frac{d\Delta G}{dz} \\ &= \frac{z_B \Delta E}{2} + \frac{RT}{2} \left[ z_A \ln z_A + (1-z_A) \ln (1-z_A) + \right. \\ &\quad \left. + z_B \ln z_B + (1-z_B) \ln (1-z_B) \right] \\ &\quad - \frac{z}{1-z} \left[ \Delta E s + RT r \ln \frac{z_A}{1-z_A} + RT s \ln \frac{z_B}{1-z_B} \right] \\ \Delta \bar{G}_C^{conf} &= \Delta G + (1-z) \frac{d\Delta G}{dz} \end{aligned} \quad (45)$$

$$= \Delta E s + r RT \ln \frac{z_A}{1-z_A} + s RT \ln \frac{z_B}{1-z_B} \quad (46)$$

where

$$r = \frac{(1-z_A)^2 (1+u)^2}{(1-z_A)^2 (1+u)^2 + e^{-\Delta E/RT}} \quad (47)$$

$$s = \frac{(1-z_B)^2 (1+v)^2}{(1-z_A)^2 (1+u)^2 + e^{-\Delta E/RT}} \quad (48)$$

$$u = \frac{z_A}{1-z_A} e^{-\frac{\Delta E}{RT}} \quad (49)$$

$$v = \frac{z_B}{1-z_B} e^{\frac{\Delta E}{RT}} \quad (50)$$

$$z_B = \frac{- \left[ \frac{1-3z}{1-z} + e^{-\frac{\Delta E}{RT}} \frac{(1+z)}{(1-z)} \right] + \left[ \left( \frac{1-3z}{1-z} + e^{-\frac{\Delta E}{RT}} \frac{1+z}{1-z} \right)^2 + \left( \frac{8z}{1-z} \right) e^{-\frac{\Delta E}{RT}} \left( 1 - e^{-\frac{\Delta E}{RT}} \right) \right]^{1/2}}{2 (1 - e^{-\Delta E/RT})} \quad (51)$$

$$z_A = \frac{2z}{1-z} - z_B \quad (52)$$

If we set  $\Delta E = 0$ ,  $z_A = z_B$  since there is no difference between the carbon atoms on the A-sites and B-sites. From equation (52) one obtains,

$$z_A = z_B = \frac{z}{1-z} \quad (53)$$

Substituting for  $z_A$  and  $z_B$  according to equation (53), equation (44) reduced to equation (41).

Before we can proceed any further, we must know the values of  $a, b, c$ , (equation 40a) and of  $a', b', c'$  (equation 40b) for the monocarbide and subcarbide phases in addition to the values of  $\Delta E$  for the two subcarbide phases. These parameters were determined by using the following conditions.

- a. Values of  $\Delta G_f$  for TaC and HfC are those selected by Chang<sup>(6)</sup>.
- b. The free energy decomposition of TaC<sub>0.5</sub> to 0.633 TaC<sub>0.79</sub> + 0.367 Ta is taken to be 2300 cal at 2273°K<sup>(6)</sup>.
- c. The free energy difference between HfC<sub>0.5</sub> and TaC<sub>0.5</sub> is taken to be 2250 cal at 2273°K<sup>(6)</sup>.
- d. The phase boundaries of the subcarbide and monocarbide phases are those determined by Rudy<sup>(4)</sup> and Rudy and Harmon<sup>(5)</sup>.
- e. The partial molar quantities in the two-phase regions: metal-subcarbide, subcarbide-monocarbide and monocarbide-graphite must be all the same.

With these five conditions, we have obtained the following results for our computation:

## HfC-phase (B1-type)

$$\begin{aligned} 2\Delta G_{f,0.5} &= -52,350 + 2.08 T & 298.15^\circ\text{-}2073^\circ\text{K} \\ &= -55,630 + 3.66 T & 2073^\circ\text{-}2491^\circ\text{K} \end{aligned}$$

$$a = 250,154; \quad b = -968,150; \quad c = 1,113,170$$

## Hf<sub>2</sub>C-phase

$$a' = 72,445; \quad b' = -466,000; \quad c' = 650,000; \quad d' = 0; \quad \Delta E = 0$$

## TaC-phase (B1-type)

$$\Delta G_{f,0.5} = -35,335 - 1.7949 \log T + 6.4757 T$$

$$a = 363,950; \quad b = 1,527,083; \quad c = 1,770,833$$

## Ta<sub>2</sub>C-phase

$$a' = 129,848; \quad b' = 1,336,117; \quad c' = -4,726,667; \quad d' = 5,373,333$$

$$\Delta E = 4000 \text{ cal.}$$

The phase equilibria in the system Ta-Hf-C at 2273°K and 1273°K are calculated and presented in Figures 19 and 20. The phase diagrams calculated using the simplified method are shown in Figures 21 and 22 for comparison. As might be expected, the marked difference between the calculated phase diagrams by the two different methods is the homogeneous range of the monocarbide phase. The concentration-free-energy-gradient curves for the metal, subcarbide and monocarbide phases as well as the integral free energy of decomposition of the subcarbide phase into the metal and monocarbide phases at 2273°K used to establish the phase equilibria are presented in Figures 23 and 24. Similar curves used to determine the phase equilibria at 1773°K are not included in this report.

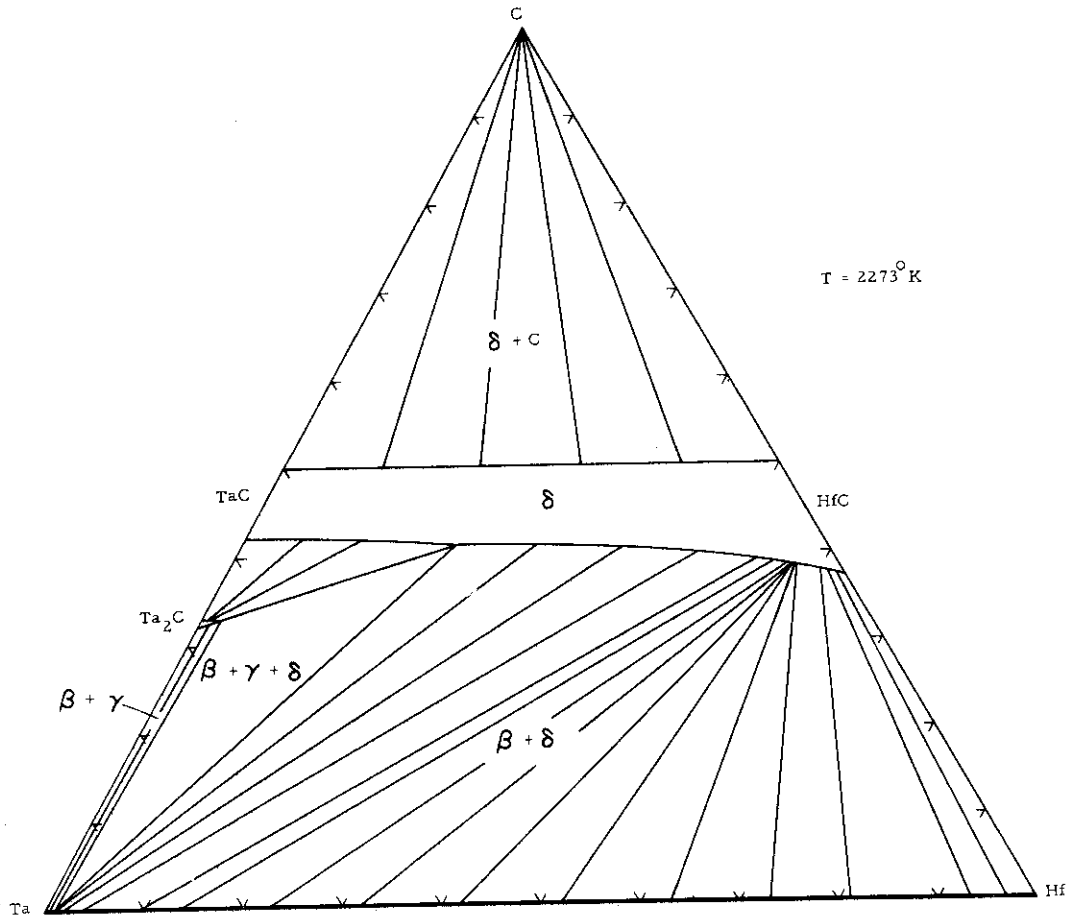

Figure 19. Calculated Phase Equilibria in the System Ta-Hf-C Using the General Method at 2273°K.

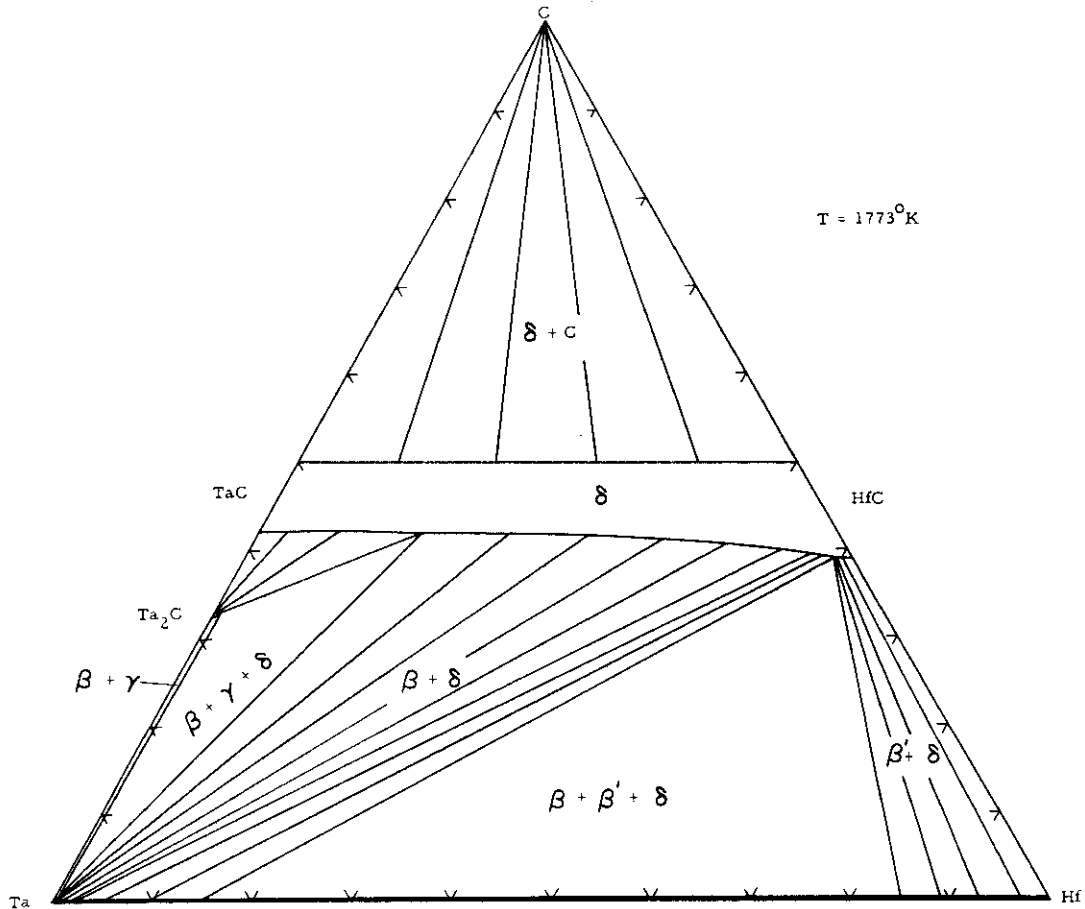

Figure 20. Calculated Phase Equilibria in the System Ta-Hf-C Using the General Method at 1773°K.

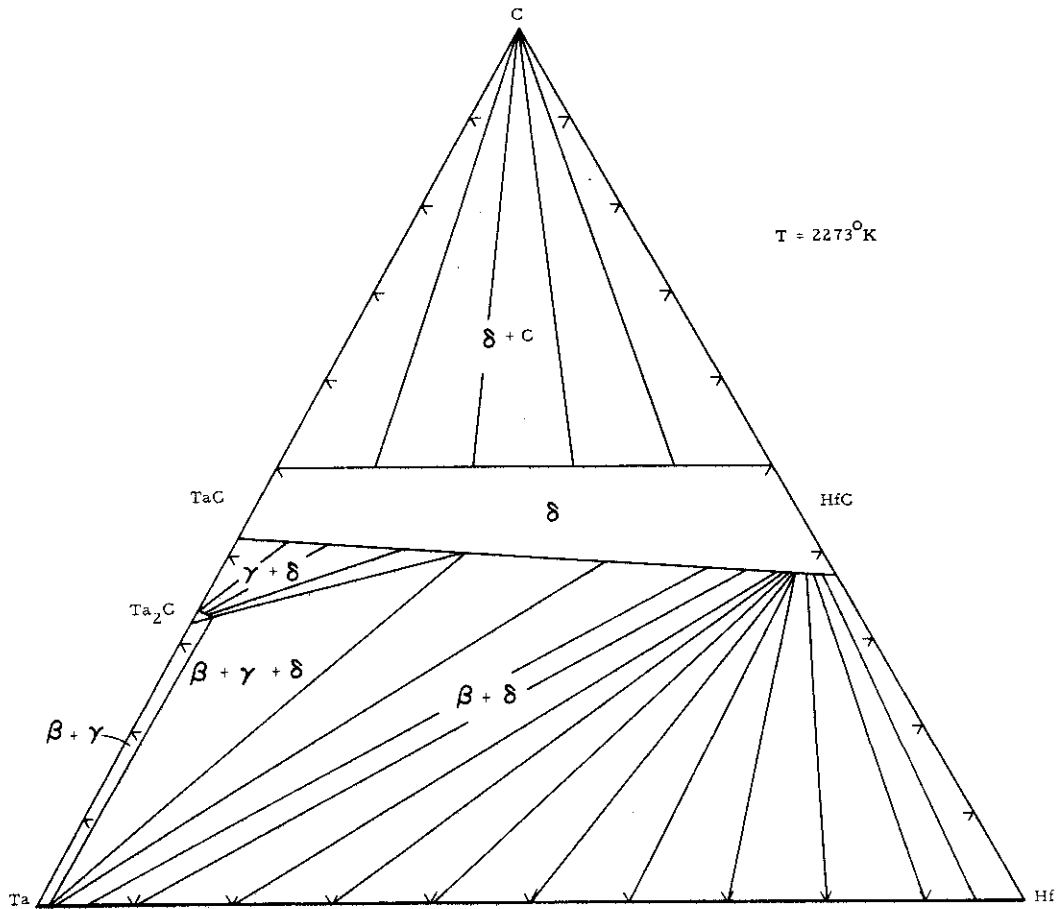

Figure 21. Calculated Phase Equilibria in the System Ta-Hf-C Using the Simplified Method at 2273°K.

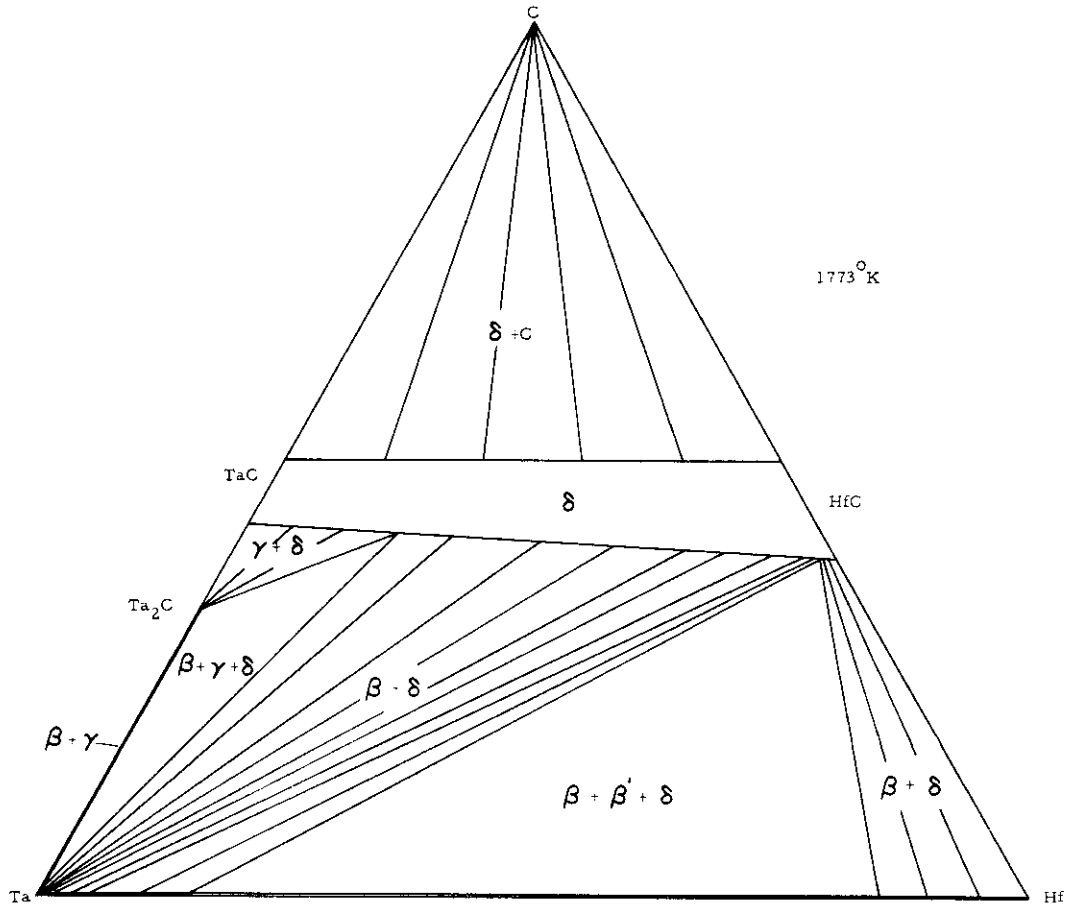

Figure 22. Calculated Phase Equilibria in the System Ta-Hf-C Using the Simplified Method at 1773°K.

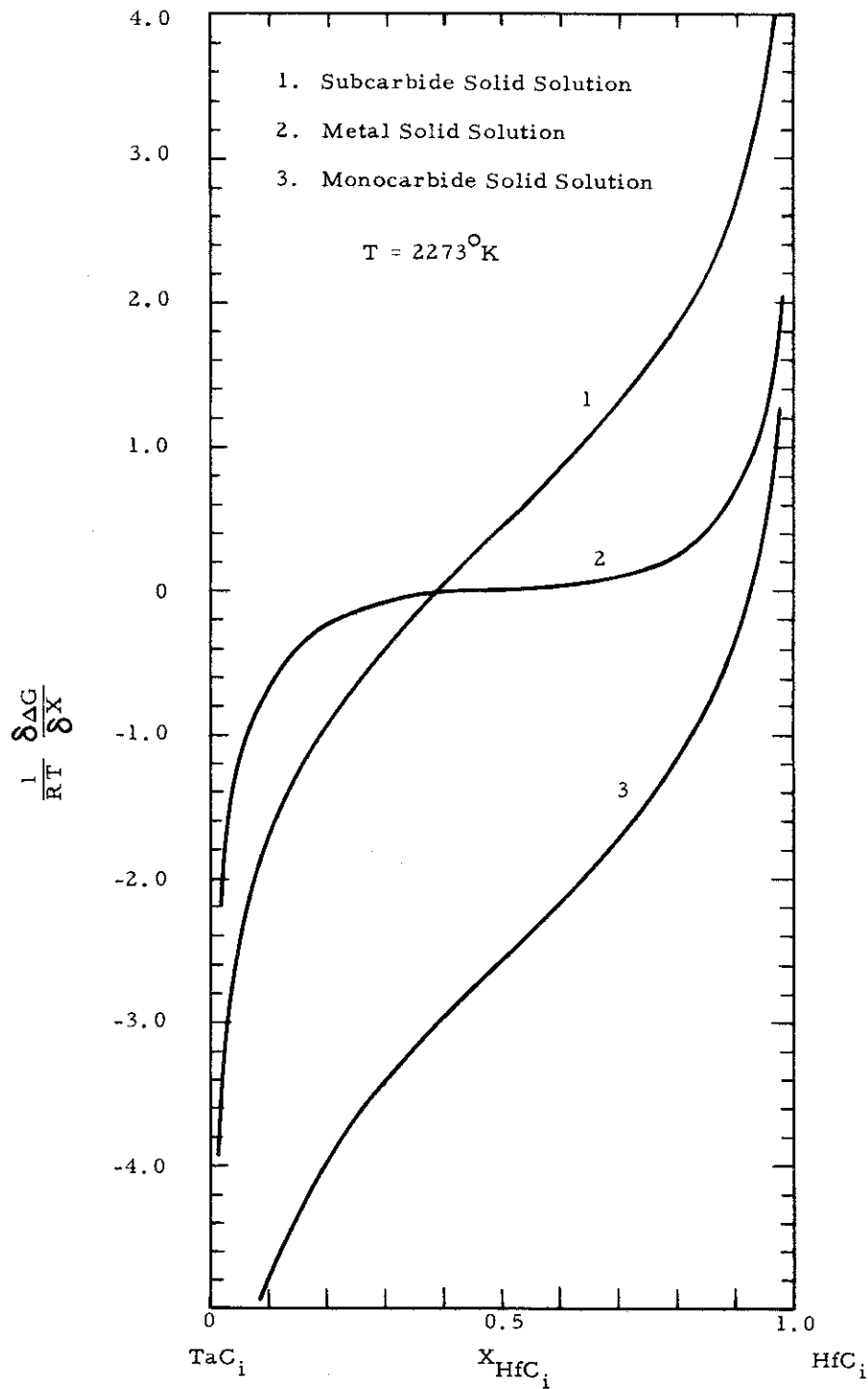

Figure 23. Concentration Free-Energy-Gradient Curves for the Metal, Subcarbide and Monocarbide Solid Solutions.



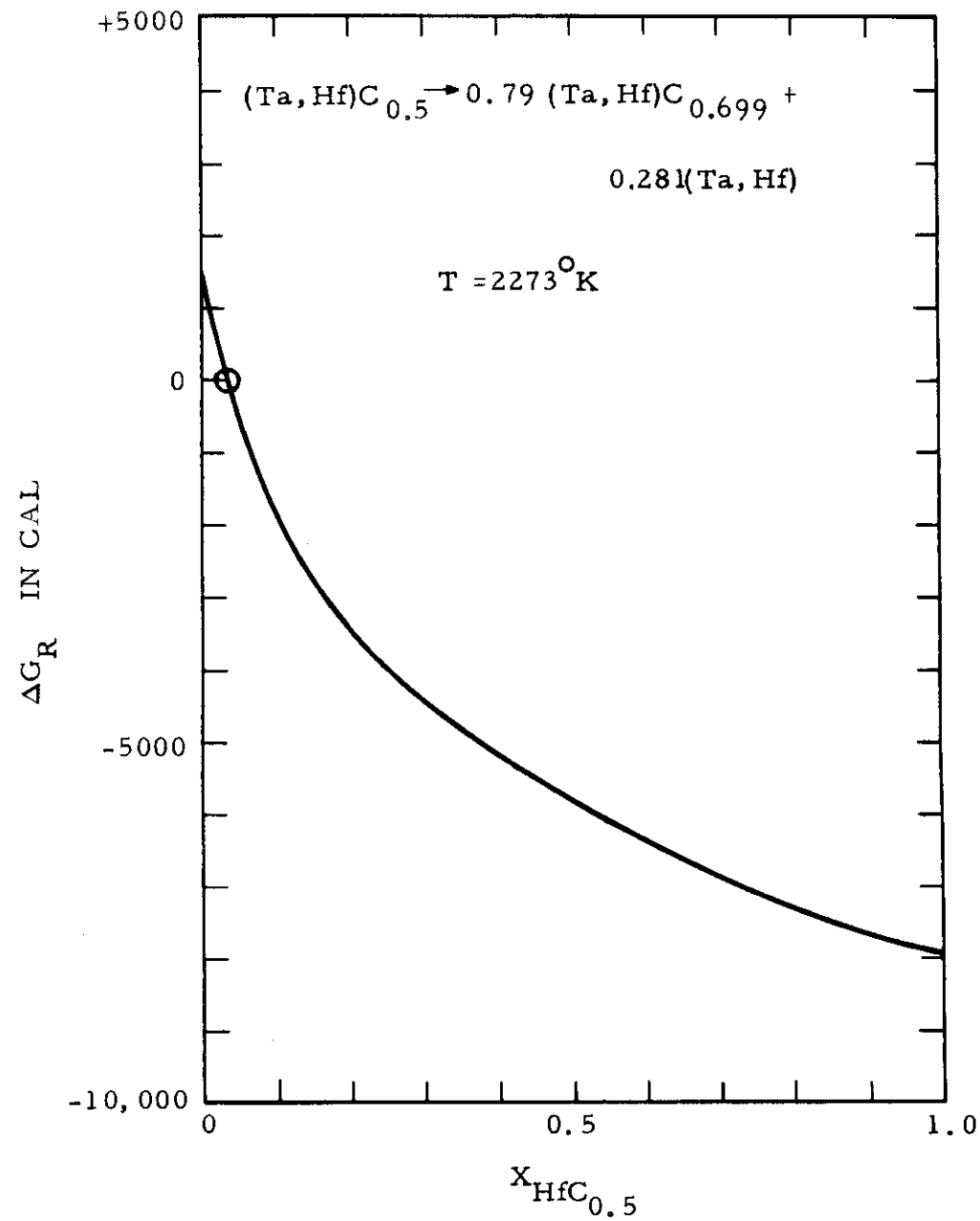

Figure 24. Integral Free Energy of Decomposition of the Subcarbide Phase into the Metal and Monocarbide Phases at 2273°K.

IV. DISCUSSION

The method described in this report has demonstrated that the phase equilibria in three-component systems can be adequately predicted from binary data based on the first principle provided that the Gibbs free energies of formation of all the binary phases are accurately known as a function of composition and temperature. Moreover, one must also know the solution behaviors of the ternary alloys. It has been demonstrated previously<sup>(2, 3)</sup>, that for the interstitial type of solid solution such as the transition metal carbides, the regular solution theory with proper values of the interaction parameters, is adequate in most cases.

The general method also demonstrates that the simplified method originally developed by Rudy for predicting phase equilibria in three-component systems is sufficiently accurate. In cases where the homogeneous ranges of the ternary solid solutions with respect to the interstitial component such as carbon are small, the simplified method would predict the identical results as the general method. Only, when the homogeneous ranges of a ternary solid solution with respect to the interstitial element change drastically with the metal exchange, will there be a difference between the phase diagrams calculated using the two different methods. In practice, the phase equilibria in a ternary system predicted by the simplified method are sufficiently accurate in most cases.

## REFERENCES

1. E. Rudy: Z. Metallk. 54 ,112 (1963).
2. E. Rudy: Z. Metallk. 54 213 (1963).
3. E. Rudy and Y.A. Chang: Plansee Proceedings 1964, p786, Metallk Plansee, AG., Reutte, Tirol (1965).
4. E. Rudy: Hf-C Phase Diagram, AFML-TR-65-2, Part I, Vol. IV. (1965)
5. E. Rudy and D.P. Harmon: Ta-C Phase Diagram, AFML-TR-65-2, Part I, Vol. V (1965).
6. Y.A. Chang: AFML-TR-65-2, Part IV, Vol. I (1965).
7. C. Wagner: Thermodynamics of Alloys, Addison-Wesley, Reeding, Mass. (1952).
8. C. Wagner and W. Schottky: Z. Physik. Chem. 11 1963 (1931).
9. L. Kaufman and A. Sarney: Compounds of Interest in Nuclear Reactor Technology, American Institute of Mining, Metallurgical and Petroleum Engineers, Inc., 267 (1964).
10. E. Rudy, St. Windisch, and Y.A. Chang: AFML-TR-65-2, Part I, Vol. I (1965).

APPENDIX I

COMPUTER PROGRAMS FOR TERNARY PHASE  
DIAGRAM CALCULATIONS (Ray Marler)

# Contrails

```
$IBFTC K-1      FULIST
  DIMENSION X(50),Y(50),A3(3),A4(3),TITLE(13)
  NAMelist/INPUT/NOXYS,IPRINT,CASE,DUMP,XLIM,R,T,EPSP,EPSP,A3,A4,
  1X,Y,K1,K2
  NAMelist/DTADMP/LINE,K,J,XP,YP,XPP,YPP,ZPP,DG,DG3,DG4,GNU1,GNU2,
  1FXP,FYP,DG1,C1,C2,FC1,FC2,DG2
1 FORMAT(1H139X53H A E R O J E T - G E N E R A L   C O R P O R A T I
10 N/1H039X53H C O M P U T I N G   S C I E N C E S   D I V I S I O N
2/1H050X31H S A C R A M E N T O   P L A N T//1H057X17H P R O G R A M
3   K/1H027X77H T W O - P H A S E   E Q U I L I B R I U M   I N   T E
4   R N A R Y   S Y S T E M/16H0 C U S T O M E R 97X19H P R O G R A M M
5   E R/12H O Y . A . C H A N G 109X11H R . H . M A R L E R // )
  READ(5,17)TITLE
2 READ (5,INPUT)
  WRITE(6,1)
  WRITE(6,18)TITLE
  WRITE(6,INPUT )
  LIM = XLIM + .005
  NDUMP1= DUMP
  NDUMP2 = INT(DUMP*XLIM+.005) - NDUMP1*LIM
  RT = R*T
  WRITE(6,1)
  WRITE(6,18)TITLE
  DO 14 I = 1, NOXYS
  WRITE(6,16)X(I),Y(I)
  PASS = 1.
  L = 1
  LINE = 1
  LIMX = XLIM * X(I) + .005
  BLIMX = LIMX
  JMAX = LIM - LIMX
  DO 12 K = K1,K2
  CAY = K
  XPP = CAY/XLIM
  DO 12 J = 1, JMAX
  XJ = J
  XP = (BLIMX + XJ)/XLIM
  ZPP = (XP - XPP)*(1.-X(I)-Y(I))/(XP - X(I))
  IF(ZPP.GE.1..OR.ZPP.LE.0..OR.XP.EQ.XPP.OR.XP.EQ.X(I))GO TO 12
  DG3 = ((A3(3)*ZPP+A3(2))*ZPP+A3(1))/(1.-ZPP)
  DG4 = ((A4(3)*ZPP+A4(2))*ZPP+A4(1))/(1.-ZPP)
  GNU1 = (X(I)-XPP)/(XP-XPP)
  GNU2 = (XP-X(I))/(XP-XPP)
  IF(GNU1.LT.0..OR.GNU1.GT.1..OR.GNU2.LT.0..OR.GNU2.GT.1.)GO TO 12
  YP = 1.-XP
  YPP = 1. -XPP - ZPP
  CALL XLNX(XP,FXP,$12)
  CALL XLNX(YP,FYP,$12)
  DG1 = (FXP+FYP)*RT+XP*YP*EPSP
  C1 = XPP/(1.-ZPP)
  C2 = YPP/(1.-ZPP)
  CALL XLNX(C1,FC1,$12)
  CALL XLNX(C2,FC2,$12)
  DG2=((FC1+FC2)*RT+C1*C2*EPSP+C1*DG3+C2*DG4)*(1.-ZPP)
  DG =GNU1*DG1+GNU2*DG2
  IF(DG.GE.0.)GO TO 12
  IF(PASS.NE.1.)GO TO 5
  PASS = 0.
  GO TO 6
```

# Contrails

```
5 IF (DG - DGOLD)6,8,8
6 DGOLD = DG
  XPS = XP
  YPS = YP
  XPPS= XPP
  YPPS= YPP
  ZPPS= ZPP
  LSAVE = LINE
8 IF(NDUMP1.NE.K.OR.NDUMP2.NE.J)GO TO 9
  WRITE (6,DTADMP)
  GO TO 11
9 IF(IPRINT.EQ.0)WRITE(6,10)LINE,XP,YP,XPP,YPP,ZPP,DG
10 FORMAT(1H 15X14,6E16.8)
11 LINE = LINE + 1
12 CONTINUE
  WRITE(6,10)LSAVE,XPS,YPS,XPPS,YPPS,ZPPS,DGOLD
14 CONTINUE
  CASE = CASE - 1.
  IF(CASE.GT.0.)GO TO 2
15 STOP
16 FORMAT(1H019X 4HX = E15.8,10X,4HY = E15.8/1H 15X4HLINE7X2HX14X
  12HYP13X3HXPP13X3HYPP13X3HZPP12X5HDEL G)
17 FORMAT(13A6)
18 FORMAT(1H027X13A6)
  END
```

# Contrails

```
$IBFTC K-1-A FULIST
  DIMENSION X(50),Y(50),TITLE(13),VA(5),VB(5),RA(5),RB(5)
  NAMELIST/INPUT/NOXYS,IPRINT,CASE,DUMP,XLIM,R,T,EPSP,EPSP,VA,VB,
  1 X,Y,K1,K2,D3,D4,RA,RB,DEACV,DEBCV,DGACU,DGBCU
  NAMELIST/DTADMP/K,J,XP,YP,XPP,YPP,ZPP,DG,DGACV,DGBCV,GNU1,GNU2,
  1FXP,FYP,DG1,C1,C2,FC1,FC2,DG2
  1 FORMAT(1H139X53H A E R O J E T - G E N E R A L C O R P O R A T I
  10 N/1H039X53H C O M P U T I N G S C I E N C E S D I V I S I O N
  2/1H050X31H S A C R A M E N T O P L A N T//1H057X17H P R O G R A M
  3 K/1H027X77H T W O - P H A S E E Q U I L I B R I U M I N T E
  4 R N A R Y S Y S T E M/16H0C U S T O M E R 97X19H P R O G R A M M
  5 E R/12H0Y. A. CHANG109X11HR.H. MARLER//)
  READ(5,17)TITLE
  2 READ (5,INPUT)
  WRITE(6,1)
  WRITE(6,18)TITLE
  WRITE(6,INPUT )
  LIM = XLIM + .005
  NDUMP1= DUMP
  NDUMP2 = INT(DUMP*XLIM+.005) - NDUMP1*LIM
  FLAG = NDUMP1
  RT = R*T
  WRITE(6,1)
  WRITE(6,18)TITLE
  DO 14 I = 1, NOXYS
  WRITE(6,16)X(I),Y(I)
  PASS = 1.
  LIMX = XLIM * X(I) + .005
  BLIMX = LIMX
  JMAX = LIM - LIMX
  DO 12 K = K1,K2
  CAY = K
  XPP = CAY/XLIM
  DO 12 J = 1, JMAX
  XJ = J
  XP = (BLIMX + XJ)/XLIM
  IF(XP.EQ.XPP.OR.XP.EQ.X(I))GO TO 12
  ZPP = (XP - XPP)*(1.-X(I)-Y(I))/(XP - X(I))
  IF(ZPP.EQ..5)ZPP = .499
  IF(ZPP.GT.D4.OR.ZPP.LT.D3)GO TO 12
  CALL DLGC(DGACV,R,T,ZPP,VA,RA,DEACV,FLAG,$12)
  CALL DLGC(DGBCV,R,T,ZPP,VB,RB,DEBCV,FLAG,$12)
  GNU1 = (X(I)-XPP)/(XP-XPP)
  GNU2 = (XP-X(I))/(XP-XPP)
  IF(GNU1.LT.0..OR.GNU1.GT.1..OR.GNU2.LT.0..OR.GNU2.GT.1.)GO TO 12
  YP = 1.-XP
  YPP = 1. -XPP - ZPP
  CALL XLNX(XP,FXP,$12)
  CALL XLNX(YP,FYP,$12)
  DG1 = (FXP+FYP)*RT+XP*YP*EPSP+DGACU*XP+DGBCU*YP
  C1 = XPP/(1.-ZPP)
  C2 = YPP/(1.-ZPP)
  CALL XLNX(C1,FC1,$12)
  CALL XLNX(C2,FC2,$12)
  DG2=((FC1+FC2)*RT + C1*C2*EPSP + C2*DGBCV + C1*DGACV)*(1.-ZPP)
  DG =GNU1*DG1+GNU2*DG2
  IF(DG.GE.0.)GO TO 12
  IF(PASS.NE.1.)GO TO 5
  PASS = 0.
```

# Contrails

```
GO TO 6
5 IF (DG - DGOLD)6,8,8
6 DGOLD = DG
  XPS = XP
  YPS = YP
  XPPS= XPP
  YPPS= YPP
  ZPPS= ZPP
8 IF(NDUMP1.NE.K.OR.NDUMP2.NE.J)GO TO 9
  WRITE (6,DTADMP)
  FLAG = 0
  GO TO 12
9 IF(IPRINT.EQ.0)WRITE(6,10)      XP,YP,XPP,YPP,ZPP,DG
10 FORMAT(1H 19X5F16.8,F16.4)
12 CONTINUE
  WRITE(6,10)      XPS,YPS,XPPS,YPPS,ZPPS,DGOLD
14 CONTINUE
  CASE = CASE - 1.
  IF(CASE.GT.0.)GO TO 2
15 STOP
16 FORMAT(1H023X4HX = F10.8,5X,4HY = F10.8/1H 26X2HXP14X
  12HYP13X3HXPP13X3HYPP13X3HZPP12X5HDEL G)
17 FORMAT(13A6)
18 FORMAT(1H027X13A6)
END
```



# Contrails

```
$IBFTC K-2      FULIST
  DIMENSION X(50),Y(50),Z(50),TITLE(13),CDG3(3),CDG4(3),CDG5(3),
  1CDG6(3)
  NAMELIST/INPUT/          A,B,C,D,R,T,DELTA,EPSP,EPSP,CDG3,CDG4,
  1CDG5,CDG6,X,Y,Z
1  FORMAT(1H139X53HA E R O J E T - G E N E R A L   C O R P O R A T I
10 N/1H039X53HC O M P U T I N G   S C I E N C E S   D I V I S I O N
2/1H050X31HS A C R A M E N T O   P L A N T//1H057X17HP R O G R A M
3  K/1H019X93HG E N E R A L   T W O - P H A S E   E Q U I L I B R I
4 U M   I N   T E R N A R Y   S Y S T E M/16H0C U S T O M E R 97X
519HP R O G R A M M E R/12HOY. A. CHANG109X11HR.H. MARLER//)
  READ(5,3)TITLE,ID
3  FORMAT(13A6,I2)
2  READ (5,INPUT)
  WRITE (6,1)
  WRITE(6,4)TITLE,ID
4  FORMAT(1H026X13A6,25XI2)
  WRITE (6,INPUT)
  WRITE(6,1)
  WRITE(6,16)TITLE
16 FORMAT(1H026X13A6// 7X1HX12X1HY12X1HZ11X2HXP11X2HYP11X2HZP11X3HXPP
111X3HYPP11X3HZPP 9X7HDELTA G/)
  RT = R*T
  DO 14 I = 1,50
  IF(X(I).EQ.0..AND.Y(I).EQ.0..AND.Z(I).EQ.0.)GO TO 15
  IPASS = 1
17 IF(A.EQ.X(I))A = X(I)+DELTA/10.
  XPP = A
5  IF(XPP - X(I)) 6,13,7
6  XP = X(I) + DELTA
  XPMAX = 1.
  GO TO 8
7  XP = 0.
  XPMAX = X(I)
8  ZP = C
12 YP = 1.-XP-ZP
  IF(XP.EQ.XPP)GO TO 11
  GNU1 =(X(I)-XPP)/(XP-XPP)
  IF(GNU1.GE.1..OR.GNU1.LT.0.)GO TO 11
  GNU2 = 1.-GNU1
  YPP =(Y(I)-GNU1*YP)/GNU2
  ZPP =1.-XPP-YPP
  IF(ZPP.GE.1..OR.ZPP.LT.0.)GO TO 11
  CALL CUBIC(CDG3,ZPP,DG3,$11)
  CALL CUBIC(CDG4,ZPP,DG4,$11)
  U1 = XPP/(1.-ZPP)
  U2 = YPP/(1.-ZPP)
  CALL XLNX(U1,FU1,$11)
  CALL XLNX(U2,FU2,$11)
  DG2=((FU1+FU2)*RT+U1*U2*EPSP +U2*DG4 + U1*DG3)*(1.-ZPP)
  CALL CUBIC(CDG5,ZP,DG5,$11)
  CALL CUBIC(CDG6,ZP,DG6,$11)
  U1= XP/(1.-ZP)
  U2= YP/(1.-ZP)
  CALL XLNX(U1,FU1,$11)
  CALL XLNX(U2,FU2,$11)
  DG1=((FU1+FU2)*RT + U1*U2*EPSP +U2*DG6 + U1*DG5)*(1.-ZP)
  DG = GNU1*DG1 + GNU2 * DG2
  IF(IPASS.EQ.0)GO TO 19
```

# Contrails

```
IPASS = 0
DGS = DG
19 IF(DG.GE.DGS)GO TO 9
DGS = DG
XPS = XP
YPS = YP
XPPS =XPP
YPPS=YPP
ZPS = ZP
ZPPS= ZPP
9 IF(ID.NE.0)WRITE(6,10)X(I),Y(I),Z(I),XP,YP,ZP,XPP,YPP,ZPP,DG
10 FORMAT(1H 9F13.8,F13.4)
11 ZP = ZP + DELTA
IF(ZP.LE.D)GO TO 12
XP = XP + DELTA
IF(XP.LT.XPMAX)GO TO 8
13 XPP = XPP + DELTA
IF(XPP.LE.B)GO TO 5
WRITE(6,10)X(I),Y(I),Z(I),XPS,YPS,ZPS,XPPS,YPPS,ZPPS,DGS
14 CONTINUE
15 GO TO 2
END
```

# Contrails

```
$IBFTC K-2-A FULIST
  DIMENSION X(50),Y(50),Z(50),TITLE(13),VACV(5),VBCV(5),VACU(5),
  1 VBCU(5),RACV(5),RACU(5),RBCV(5),RBCU(5)
  NAMELIST/INPUT/ A,B,C,D,E,F,R,T,DELTA,EPSP,EPSP,DEACV,DEBCV,
  1DEACU,DEBCU,VACV,VBCV,VACU,VBCU,RACV,RBCV,RACU,RBCU,X,Y,Z
  1 FORMAT(1H139X53H A E R O J E T - G E N E R A L C O R P O R A T I
  10 N/1H039X53H C O M P U T I N G S C I E N C E S D I V I S I O N
  2/1H050X31H S A C R A M E N T O P L A N T//1H057X17H P R O G R A M
  3 K/1H019X93H G E N E R A L T W O - P H A S E E Q U I L I B R I
  4 U M I N T E R N A R Y S Y S T E M/16H0C U S T O M E R 97X
  519H P R O G R A M M E R/12H0Y. A. CHANG109X11HR.H. MARLER//)
  READ(5,3)TITLE,ID
  3 FORMAT(13A6,I2)
  2 READ (5,INPUT)
  WRITE (6,1)
  WRITE(6,4)TITLE,ID
  4 FORMAT(1H026X13A6,25X12)
  WRITE (6,INPUT)
  WRITE(6,1)
  WRITE(6,16)TITLE
  16 FORMAT(1H026X13A6// 7X1HX12X1HY12X1HZ11X2HXP11X2HYP11X2HZP11X3HXPP
  111X3HYPP11X3HZPP 9X7HDELTA G/)
  FLAG =ID/10
  RT = R*T
  DO 14 I = 1,50
  IF(X(I).EQ.0..AND.Y(I).EQ.0..AND.Z(I).EQ.0.)GO TO 15
  IPASS = 1
  XPP = A
  DO 17 IXPP=1,1000
  IF(XPP-X(I))6,13,7
  6 XP = X(I) + DELTA
  XPMAX = F
  GO TO 8
  7 XP = E
  XPMAX = X(I)
  8 DO 18 IXP=1,1000
  ZP=C
  DO 22 IZP=1,1000
  YP=1.-XP-ZP
  IF(XP.EQ.XPP)GO TO 11
  GNU1 =(X(I)-XPP)/(XP-XPP)
  IF(GNU1.GE.1..OR.GNU1.LT.0.)GO TO 11
  GNU2 = 1.-GNU1
  YPP =(Y(I)-GNU1*YP)/GNU2
  ZPP =1.-XPP-YP
  IF(ZPP.GE.1..OR.ZPP.LT.0.)GO TO 11
  CALL DLGC(DGACV,R,T,ZPP,VACV,RACV,DEACV,FLAG,$11)
  CALL DLGC(DGBCV,R,T,ZPP,VACV,RBCV,DEBCV,FLAG,$11)
  U1 = XPP/(1.-ZPP)
  U2 = YPP/(1.-ZPP)
  CALL XLNX(U1,FU1,$11)
  CALL XLNX(U2,FU2,$11)
  DG2=((FU1+FU2)*RT+U1*U2*EPSP+U2*DGBCV+U1*DGACV)*(1.-ZPP)
  CALL DLGC(DGACU,R,T,ZP,VACU,RACU,DEACU,FLAG,$11)
  CALL DLGC(DGBCU,R,T,ZP,VBCU,RBCU,DEBCU,FLAG,$11)
  U1= XP/(1.-ZP)
  U2= YP/(1.-ZP)
  CALL XLNX(U1,FU1,$11)
  CALL XLNX(U2,FU2,$11)
```

# Contrails

```
DG1 = ((FU1+FU2)*RT+U1*U2*EPSP+U2*DGBCU+U1*DGACU)*(1.-ZP)
DG = GNU1*DG1 + GNU2 * DG2
IF(IPASS.EQ.0)GO TO 19
IPASS = 0
DGS = DG
19 IF(DG.GE.DGS)GO TO 9
DGS = DG
XPS = XP
YPS = YP
XPPS =XPP
YPPS=YPP
ZPS = ZP
ZPPS= ZPP
9 IF(ID.NE.0)WRITE(6,10)X(I),Y(I),Z(I),XP,YP,ZP,XPP,YPP,ZPP,DG
10 FORMAT(1H 9F13.8,F13.4)
11 ZP = ZP + DELTA
IF(ZP.GT.D)GO TO 12
22 CONTINUE
WRITE(6,23)
23 FORMAT( 25H0THE ZP LOOP WAS EXCEEDED)
GO TO 5
12 XP =XP+DELTA
IF(XP.GE.XPMAX)GO TO 13
18 CONTINUE
WRITE(6,20)
20 FORMAT(25H0THE XP LOOP WAS EXCEEDED)
GO TO 5
13 XPP = XPP + DELTA
IF(XPP.GT.B)GO TO 5
17 CONTINUE
WRITE(6,21)
21 FORMAT(26H0THE XPP LOOP WAS EXCEEDED)
5 WRITE(6,10)X(I),Y(I),Z(I),XPS,YPS,ZPS,XPPS,YPPS,ZPPS,DGS
14 CONTINUE
15 GO TO 2
END
```

# Contrails

```
$IBFTC K-3      FULIST
  DIMENSION TITLE(13)
  COMMON      CDGACV(3),CDGBCV(3),CDGACW(3),CDGBCW(3)
  NAMELIST/INPUT/B1,B2,DELTA,X,Y,Z,XP,YP,ZP,XPP,YPP,ZPP,R,T,M,
  1CDGACV,CDGBCV,CDGACW,CDGBCW,EPSP,EPSP,EPSP
1 FORMAT(1H139X53H A E R O J E T - G E N E R A L   C O R P O R A T I
10 N/1H039X53H C O M P U T I N G   S C I E N C E S   D I V I S I O N
2/1H050X31H S A C R A M E N T O   P L A N T//1H057X17H P R O G R A M
3   K/1H019X93H G E N E R A L   T W O - P H A S E   E Q U I L I B R I
4 U M   I N   T E R N A R Y   S Y S T E M/16H0C U S T O M E R 97X
519H P R O G R A M M E R/12H0Y. A. CHANG109X11HR.H. MARLER//)
  READ(5,3)TITLE,ID
3 FORMAT(13A6,I2)
2 READ (5,INPUT)
  WRITE (6,1)
  WRITE(6,4)TITLE,ID
4 FORMAT(1H026X13A6,25XI2)
  WRITE (6,INPUT)
  WRITE(6,1)
  WRITE(6,5)TITLE
  RT=R*T
  CALL DGACVS(DGACV,ZPP,$11)
  CALL DGBCVS(DGBCV,ZPP,$11)
  U1=XP/(1.-ZP)
  U2=YP/(1.-ZP)
  CALL XLNX(U1,FU1,$11)
  CALL XLNX(U2,FU2,$11)
  DG1 = (FU1+FU2)*RT + EPSP*U1*U2
  U1=XPP/(1.-ZPP)
  U2=YPP/(1.-ZPP)
  CALL XLNX(U1,FU1,$11)
  CALL XLNX(U2,FU2,$11)
  DG2 = ((FU1+FU2)*RT + EPSP*U1*U2 + DGBCV*U2 + DGACV*U1)*(1.-ZPP)
13 IPASS=1
  DYP = YP-Y
  DYPP=YPP-Y
  DZP = ZP-Z
  DZPP=ZPP-Z
  AREA2 =DYPP*DZP - DYP*DZPP
  ZPPP= B1
7 YPPP=0.
  YPPPMX=1.-ZPPP
  DZPPP=ZPPP-Z
8 DYPPP=YPPP-Y
  AREA1 =DYP*DZPPP-DYPPP*DZP
  AREA3 =DYPPP*DZPP - DYPP*DZPPP
  IF(.NOT.(AREA1.LT.0..AND.AREA2.LT.0..AND.AREA3.LT.0..OR.AREA1.GT.
10..AND.AREA2.GT.0..AND.AREA3.GT.0.))GO TO 11
  XPPP=1.-YPPP-ZPPP
  CALL DGACWS(DGACW,ZPPP,$11)
  CALL DGBCWS(DGBCW,ZPPP,$11)
  U1=XPPP/(1.-ZPPP)
  U2=YPPP/(1.-ZPPP)
  CALL XLNX(U1,FU1,$11)
  CALL XLNX(U2,FU2,$11)
  DG3 = ((FU1+FU2)*RT+EPSP*U1*U2 + DGBCW*U2 + DGACW*U1)*(1.-ZPPP)
  D = (YPP - YP)*(ZPPP- ZP) - (ZPP - ZP) * (YPPP- YP)
  IF(D.EQ.0.)GO TO 11
  GNU1 = ((YPP-Y)*(ZPPP-Z) - (ZPP-Z)*(YPPP-Y))/D
```

# Contrails

```
IF(GNU1.LE.0..OR.GNU1.GT.1.)GO TO 11
GNU2 = ((Y-YP)*(ZPPP-ZP) - (Z-ZP)*(YPPP-YP))/D
IF(GNU2.LE.0..OR.GNU2.GT.1.)GO TO 11
GNU3 = 1.-GNU1-GNU2
DG = GNU1* DG1 + GNU2 *DG2 + GNU3*DG3
IF(IPASS.EQ.0)GO TO 9
IPASS = 0
DGS = DG
9 IF(DG.GE.DGS)GO TO 10
DGS = DG
XPPPS = XPPP
YPPPS = YPPP
ZPPPS = ZPPP
10 IF(ID.NE.0)WRITE(6,14)X,Y,Z,XP,YP,ZP,XPP,YPP,ZPP,XPPP,YPPP,ZPPP,DG
11 YPPP = YPPP + DELTA
IF(YPPP.LE.YPPPMX)GO TO 8
ZPPP = ZPPP + DELTA
IF(ZPPP.LE.B2) GO TO 7
WRITE(6,14)X,Y,Z,XP ,YP ,ZP ,XPP ,YPP ,ZPP ,
1XPPPS,YPPPS,ZPPPS,DGS
M = M -1
IF(M.LT.0)GO TO 2
IF(DGS.GE.0.)GO TO 12
B1 =AMAX1(B1,DGS-DELTA)
B2 =AMIN1(B2,DGS+DELTA)
12 DELTA = DELTA/10.
GO TO 13
14 FORMAT(1H 12F10.7,F10.3)
5 FORMAT(1H026X
1 13A6//130H X Y Z XP Y
1P ZP XPP YPP ZPP XPPP YPPP
2 ZPPP DELTA G/)
END
```

# Contrails

```
$IBFTC K-3-A FULIST
DIMENSION TITLE(13),RACV(5),RBCV(5),RACW(5),RBCW(5),VACV(5),
1 VBCV(5),VACW(5),VBCW(5)
NAMelist/INPUT/B1,B2,DELTA,X,Y,Z,XP,YP,ZP,XPP,YPP,ZPP,R,T,M,EPSP,
1 EPSPP,EPSPPP,DEACV,DEBCV,DEACW,DEBCW,VACV,VBCV,VACW,VBCW,
2 RACV,RBCV,RACW,RBCW,DGACU,DGRCU
1 FORMAT(1H139X53H A E R O J E T - G E N E R A L C O R P O R A T I
10 N/1H039X53H C O M P U T I N G S C I E N C E S D I V I S I O N
2/1H050X31H S A C R A M E N T O P L A N T//1H057X17H P R O G R A M
3 K/1H019X93H G E N E R A L T W O - P H A S E E Q U I L I B R I
4 U M I N T E R N A R Y S Y S T E M/16H0C U S T O M E R 97X
519H P R O G R A M M E R/12HOY. A. CHANG109X11HR.H. MARLER//)
READ(5,3)TITLE,ID
3 FORMAT(13A6,I2)
2 READ (5,INPUT)
WRITE (6,1)
WRITE(6,4)TITLE,ID
4 FORMAT(1H026X13A6,25XI2)
WRITE (6,INPUT)
WRITE(6,1)
WRITE(6,5)TITLE
FLAG = ID/10
RT=R*T
CALL DLGC(DGACV,R,T,ZPP,VACV,RACV,DEACV,FLAG,$11)
CALL DLGC(DGBCV,R,T,ZPP,VBCV,RBCV,DEACV,FLAG,$11)
U1=XP/(1.-ZP)
U2=YP/(1.-ZP)
CALL XLNX(U1,FU1,$11)
CALL XLNX(U2,FU2,$11)
DG1 = (FU1+FU2)*RT + EPSP*U1*U2+DGACU*XP+DGBCU*YP
U1=XPP/(1.-ZPP)
U2=YPP/(1.-ZPP)
CALL XLNX(U1,FU1,$11)
CALL XLNX(U2,FU2,$11)
DG2 = ((FU1+FU2)*RT + EPSP*U1*U2 + DGBCV*U2 + DGACV*U1)*(1.-ZPP)
13 IPASS=1
DYP = YP-Y
DYPP=YPP-Y
DZP = ZP-Z
DZPP=ZPP-Z
AREA2 =DYPP*DZP - DYP*DZPP
ZPPP= P1
7 YPPP = 0.
YPPPMX=1.-ZPPP
DZPPP=ZPPP-Z
8 DYPPP=YPPP-Y
AREA1 =DYP*DZPPP-DYPPP*DZP
AREA3 =DYPPP*DZPP - DYP*DZPPP
IF(.NOT.(AREA1.LT.0..AND.AREA2.LT.0..AND.AREA3.LT.0..OR.AREA1.GT.
10..AND.AREA2.GT.0..AND.AREA3.GT.0.))GO TO 11
XPPP=1.-YPPP-ZPPP
CALL DLGC(DGACW,R,T,ZPPP,VACW,RACW,DEACW,FLAG,$11)
CALL DLGC(DGBCW,R,T,ZPPP,VBCW,RBCW,DEBCW,FLAG,$11)
U1=XPPP/(1.-ZPPP)
U2=YPPP/(1.-ZPPP)
CALL XLNX(U1,FU1,$11)
CALL XLNX(U2,FU2,$11)
DG3 = ((FU1+FU2)*RT+EPSP*U1*U2 + DGBCW*U2 + DGACW*U1)*(1.-ZPPP)
D = (YPP - YP)*(ZPPP - ZP) - (ZPP - ZP) * (YPPP - YP)
```

# Contrails

```
IF(D.EQ.0.)GO TO 11
GNU1 = ((YPP-Y)*(ZPPP-Z) - (ZPP-Z)*(YPPP-Y))/D
IF(GNU1.LE.0..OR.GNU1.GT.1.)GO TO 11
GNU2 = ((Y-YP)*(ZPPP-ZP) - (Z-ZP)*(YPPP-YP))/D
IF(GNU2.LE.0..OR.GNU2.GT.1.)GO TO 11
GNU3 = 1.-GNU1-GNU2
DG = GNU1* DG1 + GNU2 *DG2 + GNU3*DG3
IF(IPASS.EQ.0)GO TO 9
IPASS = 0
DGS = DG
9 IF(DG.GT.DGS)GO TO 10
DGS = DG
XPPPS = XPPP
YPPPS = YPPP
ZPPPS = ZPPP
10 IF(ID.NE.0)WRITE(6,14)X,Y,Z,XP,YP,ZP,XPP,YPP,ZPP,XPPP,YPPP,ZPPP,DG
11 YPPP = YPPP + DELTA
IF(YPPP.LE.YPPPMX)GO TO 8
ZPPP = ZPPP + DELTA
IF(ZPPP.LE.B2) GO TO 7
WRITE(6,14)X,Y,Z,XP ,YP ,ZP ,XPP ,YPP ,ZPP ,
1XPPPS,YPPPS,ZPPPS,DGS
M = M -1
IF(M.LT.0)GO TO 2
IF(DGS.GE.0.)GO TO 12
B1 =AMAX1(B1,DGS-DELTA)
B2 =AMIN1(B2,DGS+DELTA)
12 DELTA = DELTA/10.
GO TO 13
14 FORMAT(1H 12F10.7,F10.3)
5 FORMAT(1H026X
1 13A6//130H X Y Z XP YPP ZPP XPPP YPPP Y
1P ZP XPP YPP ZPP XPPP YPPP
2 ZPPP DELTA G/)
END
```



# Contrails

```
$IBLDR XLNXF                                12/17/65      XLNX0000
$TEXT XLNXF                                12/17/65      XLNX0001
*N ((X$7V*7(*7-5 00 80 9 9                94 8 93 77 7749G405 Z4 8 93 'G '5 'XLNX0002
*N9(( '*XV*7(*7-5 5 ' 74+03' W=          ' 7 9 5 Z  *)P0 ' )4'G47'4'04'74'XLNX0003
*N8V*' *7V*X(*7-74 04'74774 ' '5         7 'G 074074'74'449' ' ' 7' ' ' 7447' 'XLNX0004
*59(2'*/ ' '5 ' '                          XLNX0005
$CDICT XLNXF                                12/17/65      XLNX0006
*/ (( 0' 1'*)P 0      0 9*)P  '*)P-6 P*)- XLNX0007
$DKEND XLNXF                                12/17/65      XLNX0008
$IBFTC CUBICF NOLIST
SUBROUTINE CUBIC(COEF,X,Y,*)
DIMENSION COEF(3)
IF(X.EQ.1.)RETURN 1
Y = ((X*COEF(3)+COEF(2))*X+COEF(1))/(1.-X)
RETURN
END
```

# Contrails

```
$IBFTC DGACVF FULIST
  SUBROUTINE DGACVS(DGACV,ZPP ,*)
  COMMON   CDGACV(3),CDGBCV(3),CDGACW(3),CDGBCW(3)
  CALL CUBIC(CDGACV,ZPP,DGACV,$10)
  RETURN
10 RETURN 1
  END

$IBFTC DGBCVF FULIST
  SUBROUTINE DGBCVS(DGBCV,ZPP ,*)
  COMMON   CDGACV(3),CDGBCV(3),CDGACW(3),CDGBCW(3)
  CALL CUBIC(CDGBCV,ZPP,DGBCV,$10)
  RETURN
10 RETURN 1
  END

$IBFTC DGACWF FULIST
  SUBROUTINE DGACWS(DGACW,ZPPP,*)
  COMMON   CDGACV(3),CDGBCV(3),CDGACW(3),CDGBCW(3)
  CALL CUBIC(CDGACW,ZPPP,DGACW,$10)
  RETURN
10 RETURN 1
  END

$IBFTC DGBCWF FULIST
  SUBROUTINE DGBCWS(DGBCW,ZPPP,*)
  COMMON   CDGACV(3),CDGBCV(3),CDGACW(3),CDGBCW(3)
  CALL CUBIC(CDGBCW,ZPPP,DGBCW,$10)
  RETURN
10 RETURN 1
  END
```

# Contrails

```
$IBFTC DELGC FULIST
SUBROUTINE DLGC (DGC,R,T,ARG,V,ARE,DELE,FLAG,*)
DIMENSION V(5),ARE(5)
GC = ARE(5)*T + ARE(4)
DGFC = (ALOG10(T)*ARE(2)+ARE(3))*T + ARE(1)
CALL DGXS(ARG,DELE,R,T,DELGXS,FLAG,$2)
DGC=(((ARG*V(5)+V(4))*ARG+V(3))*ARG+V(2))*ARG+V(1)+(1.-2.*ARG)*
1GC+(1.-ARG)*DGFC+DELGXS)/(1.-ARG)
IF(FLAG.GT.0.)WRITE(6,1)GC,DGFC,DGC
1 FORMAT( 6H GC = E15.8,5X 7HDGFC = E15.8,5X6HDGC = E15.8)
RETURN
2 RETURN1
END

$IBFTC DLGXS FULIST
SUBROUTINE DGXS(X,DELE,R,T,DELGXS,FLAG,*)
RT=R*T
IF(DELE)10,5,1
1 W=DELE/RT
EXPW = EXP(W)
EXPNW =1./EXPW
CALL XSUBAB(X,EXPNW,XA,XB,FLAG,$10)
CALL PRELIM(XA,XB,EXPNW,EXPW,SMALLR,S,FLAG)
CALL DELGCX(DELE,RT,XA,XB,SMALLR,S,DLGCXS,FLAG)
CALL DELGMX(X,XA,XB,RT,DELE,DLGCXS,DGMEXS,FLAG)
CONJXA=1.-XA
CONJXB=1.-XB
CALL XLNX(XA,FXA,$10)
CALL XLNX(CONJXA,FCNJXA,$10)
CALL XLNX(XB,FXB,$10)
CALL XLNX(CONJXB,FCNJXB,$10)
DELGXS=((FXA+FXB+FCNJXA+FCNJXB)*RT +XB*DELE)*(1.-X)/2.
GO TO 9
5 CONJX=1.-X
CALL XLNX (X,FX,$10)
CALL XLNX (CONJX,FCONJX,$10)
UX=1.-2.*X
CALL XLNX(UX,FUX,$10)
DELGXS =(FUX-FCONJX+ FX)*RT
9 IF(FLAG.GT.0.)WRITE(6,11)DELGXS
RETURN
10 RETURN 1
11 FORMAT(10H DELGXS = E15.8)
END
```

# Contrails

```
SEXECUTE      IBJOB
$IBJOB A48052  MAP
$IBFTC TAB    FULIST
  DIMENSION DELTAE(10), TEE(10)
  1 READ(5,100) IDE, IT, (DELTAE(I), I=1, IDE), (TEE(I), I=1, IT), XF, XL, DX, R,
  1 FLAG
  WRITE(6,500) (DELTAE(I), I=1, IDE), (TEE(I), I=1, IT), XF, XL, DX, R, FLAG
  DO 50 I=1, IT
  T=TEE(I)
  RT=T*R
  DO 49 J=1, IDE
  DELE=DELTAE(J)
  WRITE (6,200) T, DELE
  W=DELE/RT
  EXPW = EXP(W)
  EXPNW = EXP(-W)
  X=XF
  IF(FLAG.GT.0.) WRITE(6,300) RT, W, EXPW, EXPNW, X
10 CALL XSUBAB(X, EXPNW, XA, XB, FLAG, $11)
  CALL PRELIM(XA, XB, EXPNW, EXPW, SMALLR, S, FLAG)
  CALL DELGCX(DELE, RT, XA, XB, SMALLR, S, DLGCXS, FLAG)
  CALL DELGMX(X, XA, XB, RT, DELE, DLGCXS, DGMEXS, FLAG)
  DELGXS = ((XA*ALOG(XA) + XB*ALOG(XB) + (1.-XA)*ALOG(1.-XA) + (1.-XB)*ALOG(
  11.-XB)) * RT + XB*DELE) * (1.-X) / 2.
  WRITE(6,400) X, DLGCXS, DGMEXS, DELGXS
  IF(FLAG.EQ.1.) FLAG=0.
11 X=X+DX
  IF(X.LE.XL) GO TO 10
49 CONTINUE
50 CONTINUE
100 FORMAT(2I2/(5E13.7 ))
200 FORMAT(1H139X4HT = E15.8, 10X10HDELTA E = E15.8/1H038X1HX14X12HDELT
  1A G C XS 7X13HDELTA G ME XS 9X10HDELTA G XS/)
300 FORMAT(1H026X5E16.8)
400 FORMAT(27X4E20.8)
500 FORMAT(1H1/(26X5E16.8 ))
  GO TO 1
  END
```

# Contrails

```
$IBFTC XSBAB FULIST
SUBROUTINE XSUBAB(X,EXPNW,XA,XB,FLAG,*)
  ASTAR=1.-EXPNW
  CONJX=1.-X
  BSTAR=((1.+X)*EXPNW-3.*X+1.)/CONJX
  CSTAR=-2.*X/CONJX*EXPNW
  XB1=-BSTAR/2./ASTAR
  XB2=SQRT(BSTAR*BSTAR-4.*ASTAR*CSTAR)/2./ASTAR
  XB=XB1+XB2
  IF((XB.GT.0.).AND.(XB.LT.1.))GO TO 10
  XB=XB1-XB2
  IF((XB.GT.0.).AND.(XB.LT.1.))GO TO 10
  WRITE (6,100)XB,ASTAR,BSTAR,CSTAR
100 FORMAT(6H0XB = E15.8,38H , IS NOT IN THE RANGE (0 LT XB LT 1)./
  1 9H0ASTAR = E15.8,10X 8HBSTAR = E15.8,10X8HCSTAR = E15.8/
  216H0GO TO NEXT CASE)
  9 RETURN 1
  10 XA=2./CONJX*X-XB
  IF((XA.GT.0.).AND.(XA.LT.1.))GO TO 12
  WRITE (6,200)XA,ASTAR,BSTAR,XB
200 FORMAT(6H0XA = E15.8,38H , IS NOT IN THE RANGE (0 LT XA LT 1)./
  1 9H0ASTAR = E15.8,10X 8HBSTAR = E15.8,10X 8HCSTAR = E15.8,10X
  25HXB = E15.8/16H0GO TO NEXT CASE)
  GO TO 9
  12 IF(FLAG.LE.0.)GO TO 14
  WRITE (6,300)XA,XB,ASTAR,BSTAR,CSTAR
300 FORMAT( 21H0D U M P X S U B A B/6H0XA = E15.8,5X5HXB = E15.8,5X
  18HASTAR = E15.8,5X8HBSTAR = E15.8,5X,8HCSTAR = E15.8/)
  14 RETURN
  END
$IBFTC PRLIM FULIST
SUBROUTINE PRELIM( XA,XB,EXPNW,EXPW,SMALLR,S,FLAG)
  CONJXA=1.-XA
  CONJXB=1.-XB
  U=XA/CONJXA*EXPNW
  V=XB/CONJXB*EXPW
  RNUM=((1.+U)*CONJXA)**2
  SMALLR=RNUM/(RNUM+EXPNW)
  SNUM=((1.+V)*CONJXB)**2
  S=SNUM/(SNUM+EXPW)
  IF(FLAG.LE.0.)GO TO 1
  WRITE (6,100)U,V,RNUM,SMALLR,SNUM,S
100 FORMAT(21H0D U M P P R E L I M/5H0U = E15.7,5H V = E15.7,8H RNUM
  1= E15.7, 9HSMALLR = E15.7,8H SNUM = E15.7,5H S = E15.7/)
  1 RETURN
  END
```

A  
B  
C  
D  
  
G  
H  
I  
J  
K  
L  
M  
N  
O  
P  
Q  
R  
  
T  
U  
A  
B  
C  
D  
E  
F  
G  
H  
I  
A  
B  
C  
D  
E  
F  
G  
H  
I  
J  
K  
L  
M  
N  
O  
P

# Contrails

```
$IBFTC DGCXS  FULIST
SUBROUTINE DELGCX (DELE,RT,XA,XB,SMALLR,S,DLGCXS,FLAG)
DLGCXS=(ALOG(XA/(1.-XA))*SMALLR + ALOG(XB/(1.-XB))*S)*RT + S*DELE
IF(FLAG.GT.0.)WRITE(6,100)DLGCXS
RETURN
100 FORMAT(21HOD U M P D L G C X S/13H0 DEL GCXS = E15.7/)
END

$IBFTC DGMX  FULIST
SUBROUTINE DELGMX (X,XA,XB,RT,DELE,DLGCXS,DGMEXS,FLAG)
CONJXA=1.-XA
CONJXB=1.-XB
ZAMX=ALOG(CONJXA)*CONJXA + ALOG(XA)*XA
ZBMX=ALOG(CONJXB)*CONJXB + ALOG(XB)*XB
DGMEXS=((ZAMX+ZBMX)*RT+XB*DELE)/2.-X/(1.-X)*DLGCXS
IF(FLAG.GT.0.)WRITE (6,100)ZAMX,ZBMX,DGMEXS
RETURN
100 FORMAT(21HOD U M P D E L G M X/8H0ZAMX = E15.7,10X7HZBMX = E15.7,
110X9HDGMEXS = E15.7/)
END

$IBFTC DGMS  FULIST
SUBROUTINE DGMES(X,RT,ALPHA,GME,DGMESG,GC,DELGF,FLAG)
IF(X-.5)10,20,30
10 DGMESG =ALOG((1.-2.*X)/(1.-X))*RT + 2.*DELGF + GC
GO TO 40
20 DGMESG = ALOG((1.-2.*ALPHA)/ALPHA)*RT - GME
GO TO 40
30 DGMESG = ALOG((1.-X)/(2.*X-1.))*RT - GME
40 IF(FLAG.GT.0.)WRITE(6,100) DGMESG
100 FORMAT(19HOD U M P D G M E S/10H0DGMESG = E15.8/)
RETURN
END

$IBFTC DGCS  FULIST
SUBROUTINE DGCSIG(X,GC,GME,ALPHA,DELGF,RT,DLGCSG,FLAG)
IF(X-.5)10,20,30
10 DLGCSG = ALOG(X/(1.-2.*X))*RT -GC
GO TO 40
20 DLGCSG = ALOG((1.-2.*ALPHA)/ALPHA)*RT-GC
GO TO 40
30 DLGCSG = ALOG((2.*X-1.)/X)*RT + 2.*DELGF + GME
40 IF(FLAG.GT.0.)WRITE(6,100)DLGCSG
100 FORMAT(21HOD U M P D G C S I G/10H0DLGCSG = E15.7/)
RETURN
END
```

A  
B  
C  
D  
E  
F  
G  
A  
B  
C  
D  
E  
F  
G  
H  
I  
J  
K  
L  
A  
B  
C  
D  
E  
F  
G  
H  
I  
J  
K  
L  
A  
B  
C  
D  
E  
F  
G  
H  
I  
J  
K  
L

APPENDIX II.

Computer program for calculating the excess free energies of the  $Me_2C$  phases in terms of  $2 + w$  gramatom of alloy. For theoretical background of this problem, refer to AFML-TR-65-2, Part I, Volume I (1965).....(Bill Reuss).

# Contrails

```
$EXECUTE      IBJOB
$IBJOB 42051  MAP
$IBFTC 42051  FULIST,DECK,REF
```

```
C PROGRAM C (42051) ME2CY PHASE CALCULATION - EXCESS QUANTITIES
  DIMENSION Y(2500), XCA(2500), XCB(2500), ZA(2500), ZB(2500),
  1 Z(2500), HXS(2500), GXS(2500)

  10 READ (5,20) MODEL, YMIN, YMAX, DY, WMIN, WMAX, DW
  20 FORMAT (I1,8X,6E10.0)
  WRITE (6,30) MODEL,YMIN,YMAX,DY,WMIN,WMAX,DW
  30 FORMAT(1H1//////////61X,9HPROGRAM C//62X,7H(42051)///44X,
  1 44HME2CY PHASE CALCULATIONS - EXCESS QUANTITIES///62X,6HMODEL ,
  2 I1///3X,6HYMIN = F11.5 ,4X, 6HYMAX = F11.5 ,4X, 6H DY = F11.5,
  3 4X, 6HWMIN = F11.5,4X, 6HWMAX = F11.5 ,4X, 6H DW = F11.5 )

  W = WMIN

  35 LINCT = 50
  37 DO 39 I=1,2500
    Y(I) = 0.
    XCA(I) = 0.
    XCB(I) = 0.
    ZA(I) = 0.
    ZB(I) = 0.
    Z(I) = 0.
    HXS(I) = 0.
  39 GXS(I) = 0.

  40 I = 1
    Y(1) = YMIN
    EMW = 1./ EXP(W)

  50 GO TO (100,200),MODEL

  100 AA = 2.* (1.-EMW)
    AAAA = 2. * AA
  105 B = 1. - Y(I) + EMW*(1.+Y(I))
    C = Y(I) * EMW
    QUAD = B**2 + AAAA*C
    IF (QUAD) 107,110,110
  107 ZA(I) = 1.
    ZP(I) = QUAD
    GO TO 280

  110 QUAD = SQRT(QUAD)
    XCB(I) = (-B+QUAD)/AA
    IF (XCB(I)-1.)120,130,130
  120 IF (XCB(I))130,130,160
  130 ZB(I) = XCB(I)
    XCB(I) = (-B-QUAD)/AA
    IF (XCB(I)) 150,155,140
  140 IF (XCB(I)-1.)160,150,150
  150 Z(I) = XCP(I)
    XCP(I) = 0.
  155 ZA(I) = 3.
    GO TO 280

  160 XCA (I) = Y(I) - XCB(I)
    ZA(I) = XCA(I)* ALOG(XCA(I)) + (1.-XCA(I))*ALOG(1.-XCA(I))
```



# Contrails

```
ZB(I)= XCB(I)*ALOG(XCB(I)) + (1.-XCB(I))* ALOG(1.-XCB(I))
HXS(I) = XCB(I) * W
GO TO 270

200 CON = -2. +4.* EMW
205 YEMW = Y(I) * EMW
A = CON + Y(I) - YEMW
B = 2. - YEMW
QUAD = B**2 + 4.*A*Y(I)
IF (QUAD) 107,210,210

210 QUAD = SQRT(QUAD)
AA = 2.*A
XCA(I) = (-B + QUAD)/AA
IF (XCA(I)-1.)220,230,230
220 IF (XCA(I)) 230,230,260
230 ZP(I) = XCA(I)
XCA(I) = (-B-QUAD)/AA
IF (XCA(I)) 250,255,240
240 IF (XCA(I) - 1.) 260,250,250
250 Z(I) = XCA(I)
255 ZA(I) = 2.
GO TO 280

260 XCA1 = 1. + XCA(I)
XCB(I) = Y(I)/2.*XCA1/XCA(I) - 1.
TO1PX = 2./XCA1
TXO1PX = TO1PX * XCA(I)
ZA(I)= TO1PX * ( XCA(I)*ALOG(XCA(I))+(1.-XCA(I))* ALOG(1.-XCA(I)))
ZB(I)=TXO1PX * ( XCB(I)*ALOG(XCB(I))+(1.-XCB(I))* ALOG(1.-XCB(I)))
HXS(I) = TXO1PX * XCB(I) * W

270 Z(I) = ZA(I) + ZP(I)
GXS(I) = HXS(I) + Z(I)
IF (I - 2499)280, 300 ,300

280 Y(I+1) = Y(I) + DY
IF (Y(I+1) - YMAX) 290,290,298
290 I = I+1
GO TO (105,205),MODEL

298 Y(I+1) = 0.
300 DO 380 J = 1,I
303 IF (LINCT - 42) 305,350,350
350 LINCT = 0
WRITE (6,360)MODEL ,W
360 FORMAT (1H1,61X, 9HPROGRAM C //62X, 7H(42051) ///44X,44HME2CY PHAS
1E CALCULATIONS - EXCESS QUANTITIES/// 62X , 6HMODEL ,I1///
2 57X, 3HW = E15.8 ///)
305 IF (XCB(J)) 330,310,330
310 IF (ZA(J)- 1.) 320,315,320
315 WRITE (6,316) Y(J) ,ZB(J)
316 FORMAT(F11.4,21X,31HNegative VALUE UNDER RADICAL = E16.8,6X ,
1 15HIMAGINARY ROOTS )
GO TO 375
320 IF (ZA(J)-3.) 325,327,325
327 WRITE (6,328) Y(J) , ZB(J)
328 FORMAT( F11.4,13X, 11HXCB ROOTS ( ,E16.8 , 3H , ,E16.8 , 40H ) A
1RE NOT IN THE RANGE BETWEEN 0 AND 1 )
```

# Contrails

```
GO TO 375
325 IF (ZA(J) - 2.) 330,323,330
323 WRITE (6,324) Y(J) , ZB(J) , Z(J)
324 FORMAT (F11.4,13X, 11HXCA ROOTS ( ,E16.8 , 3H , ,E16.8 , 40H ) A
1RE NOT IN THE RANGE BETWEEN 0 AND 1 )
GO TO 375
330 CALL INT4D (Y,HXS,Y(J) ,TRP, DHXS )
CALL INT4D(Y,Z ,Y(J),TRP,DZ)
CALL INT4D(Y,GXS,Y(J),TRP,DGXS)
370 WRITE (6,371) Y(J) ,XCA(J) , XCB(J) ,ZA(J),ZB(J),Z(J) ,HXS(J),
1 GXS(J), DHXS , DZ , DGXS
371 FORMAT (1X,4HY = E15.8,8H XCA = E15.8,8H XCB = E15.8,7H ZA =
1 E15.8,7H ZB = E15.8,6H Z = E15.8/5X,6HHXS = E15.8,8H GXS =
2 E15.8,12H DHXS/DY = E15.8,10H DZ/DY = E15.8,12H DGXS/DY =
3 E15.8)
375 LINCT = LINCT + 2
380 CONTINUE
```

```
W = W+DW
IF (W-WMAX) 35,35,10
```

END

```
$ENTRY          42051
$DATA
1          .96          1.04          .02          .68315768 .70315768 .01
2          .96          1.04          .02          .68315768 .70315768 .01
2          .05          1.95          .05          .5          9.          .5
1          .05          1.95          .05          .5          9.          .5
```

APPENDIX III.

Computer program for evaluating the high-temperature thermodynamic properties. For theoretical background, refer to AFML-TR-65-2, Part IV, Volume I (1965)..... (Len Nole).

# Contrails

```
$IBJOB          GO,MAP
$IBFTC 8064     LIST,REF,DECK
C   EVALUATION OF HIGH TEMPERATURE THERMODYNAMIC PROPERTIES
C   VIA NUMERICAL INTEGRATION
      DIMENSION DATA(500),HEAD(12),TABLT(100),KDIS(20),TABLY(100),
1     TABT(1),TABY(1)
      EQUIVALENCE (TABT,DATA(1)),(TABY,DATA(201)),(SST,DATA(401))

C
C
1 DO 2 I =1,500
2 DATA(I)= 0.
  CALL SLITE(0)
  CALL ASI38 (DATA,HEAD,NE)
  IF (NE - 2)6,3,4
3 STOP
4 WRITE (6,5)
5 FORMAT (27H (((I N P U T   E R R O R))))
  GO TO 1
6 N = DATA(402),
  DO 10 I =1,200
  IF (TABT(I))4,7,10
7 IF (TABT(I+1))4,11,10
10 CONTINUE
11 NOFT = I-1
  WRITE (6,12) HEAD
12 FORMAT (1H1,42X,27HAEROJET GENERAL CORPORATION/ 36X,41HLIQUID ROCK
1ET PLANT,SACRAMENTO CALIFORNIA / 31X,55HEVALUATION OF HIGH TEMPERA
2TURE THERMODYNAMIC PROPERTIES/11H DEPT. 4600,80X,8HJOB-8064/32X,
312A6)
  WRITE (6,13) SST, N, (TABT(I),TABY(I),TABT(I+50),TABY(I+50),
1TABT(I+100),TABY(I+100),TABT(I+150),TABY(I+150), I = 1,50)
13 FORMAT (//,50X,20H I N P U T   D A T A   //7X,3HSST,3X,7HSUB INT/,
1F10.2,8X,I2,//,23X,2HT ,8X,2HY ,10X,10H      T(50),10H      Y(50),10
2X,10H      T(100),10H      Y(100),10X,10H      T(150),10H      Y(150),//,
3(15X,F10.2,F10.3,10X,F10.2,F10.3,10X,F10.2,F10.3,10X,F10.2,F10.3))
  WRITE (6,130)
130 FORMAT (1H1,48X,21H O U T P U T   D A T A   //,10H T DEG K ,5X,
15H Y ,5X,5H CP ,4X,6HHT-HST,4X,6HST-SST,5X,5HFOGFE,5X,10H INTER
2VALS)
  KDIS(1)= 1
  I = 2
  K = 2
  TINTP = 0.
  TABLT(1) = TABT(1)
  TABLY(1) = TABY(1)
  J = 2
14 TABLT(I) = TABT(J)
  TABLY(I) = TABY(J)
  IF (TABT(J+1))20,16,20
16 IF (TABT(J+2))4,22,160
160 J = J+2
  I = I+1
  KDIS(K) = J
  K = K + 1
  TABLT(I) = TABT(J)
  TABLY(I) = TABY(J)
20 I = I + 1
  J=J+4
  GO TO 14
```

# Contrails

```
22 KDIS(K) = NOFT
   K = 0
   LMN = 1
24 K = K+1
   NML = KDIS(K)
   LN = KDIS(K+1)
   IF (LMN -1)231,231,25
231 DELHT = 0.
   DELST = 0.
   CP = TABLY(1)
   FOGFE = DATA(401)
   GO TO 27
25 LMN = LMN+1
   DELHT = TABLY(LMN)*(TABLT(LMN) - 298.15)
   CALL INT4D (TABT(NML),TABY(NML),TABLT(LMN),YO,DY)
   CP = DY*(TABLT(LMN) - 298.15) + TABLY(LMN)
   TEMP = TABLY(LMN)*(1. - 298.15/TABLT(LMN))
   CALL SLITET(1,KL)
   IF (KL-1)26,26,251
251 CALL INTGR (TABLT(LMN-1),TABLT(LMN),TX,N)
   CALL INT4 (TABT(NML),TABY(NML),TX,YOFT)
   GOFTX = YOFT * (TX - 298.15)/TX/TX
   CALL INTGS (GOFTX,TINT,.00001,M)
   TINT = TINT + TINTP
   TINTP = TINT
26 DELST = TEMP + TINT
   FOGFE = -DELHT/TABLT(LMN)+ DELST + SST
27 WRITE (6,30) TABLT(LMN), TABLY(LMN), CP, DELHT, DELST, FOGFE, M
30 FORMAT      (F10.2,F10.3,4F10.2,12X,I3)
31 IF (TABLT(LMN))4,1,32
32 IF (TABLT(LMN) - TABT(LN))25,34,34
34 IF (TABT(LN) - TABT(NOFT))35,1,1
35 CALL SLITE(1)
   GO TO 24
   END
$ENTRY      8064
$DATA
```

APPENDIX IV.

Computer program for calculating the free energies of the monocarbide phases using the Wagner-Schottky vacancy model. For theoretical background, refer to AFML-TR-65-2, Part IV, Volume I (1965).....(Jerry Howard)

# Contrails

```
$EXECUTE      IBJOB  
$IBJOB 8072   MAP  
$IRFTC 8072   LIST,DECK
```

C

C MONOCARBIDES BY USING THE VACANCY MODEL.

C8072- PROGRAM H. THERMODYNAMIC CALCULATIONS FOR GROUP IV METAL

```
DIMENSION DATA(200),HEAD(12),TEMP1(20),GAO(20),GBO(20),  
1 ALGPAO(20),ALGPBO(20),GA(20),GB(20),RTLN(20),  
2 ALFA(20),TDGF(20)  
DIMENSION A(20),B(20),BET(20),GAM(20)  
EQUIVALENCE (DATA(1),TA),(DATA(2),TAB),(DATA(3),TBL),(DATA(4),  
1 BETA),(DATA(5),GAMMA),(DATA(6),BETAP),(DATA(7),GAMMAP),  
2 (DATA(8),BETAPP),(DATA(9),GAMMPP),(DATA(11  
3 ),XMIN),(DATA(12),XMAX),(DATA(13),DELX),  
4 (DATA(15),TEMP1),(DATA(55),GAO),  
5 (DATA(75),GBO),(DATA(95),ALGPAO),(DATA(115),ALGPBO),  
6 (DATA(155),T1CONT),(DATA(35),AA),(DATA(36),BB),(DATA(37)  
7 ,AAP),(DATA(38),BBP),(DATA(39),AAPP),(DATA(40),BBPP)
```

C

```
1 CALL AS138(DATA,HEAD,NE)  
WRITE(6,88)  
88 FORMAT(1H1)  
GO TO (5,4,2),NE  
2 WRITE(6,3)  
3 FORMAT(20X,24H I N P U T   E R R O R   )  
GO TO 1  
4 CALL EXIT  
5 PT5=.005  
ALN2=.69315  
R=1.98726  
I=1  
ICNT1=T1CONT+ .01
```

C

```
6 T = TEMP1(I)  
IF(T.LT.TAB) GO TO 7  
IF(T.LT.TBL) GO TO 8  
BET(I)=BETAPP  
GAM(I)=GAMMPP  
A(I) = AAP  
B(I) = BBP  
GO TO 9  
7 BET(I)=BETA  
GAM(I)=GAMMA  
A(I) = AA  
B(I) = BB  
GO TO 9
```

# Contrails

```
8 BET(I)=BETAP
  GAM(I)=GAMMAP
  A(I) = AAP
  B(I) = BBP
9 RT=R*T
  TDGF(I)=BET(I)+GAM(I)*T
  GB(I)=A(I)+B(I)*T
  RTLN(I)=-GB(I)-RT*ALN2
  ALFA(I)=.5*EXP(-GB(I)/RT)
  GA(I)=-RTLN(I)-RT*ALN2-TDGF(I)
C
  I=I+1
  IF(I.LE.ICNT1) GO TO 6
C
20 J=1
C
21 T=TEMP1(J)
  CGA = GA(J)
  CGB = GB(J)
  CRLNA = RTLN(J)
  CALF = ALFA(J)
  RT = R*T
  WRITE(6,22) HEAD
22 FORMAT(1H1,42X,27HAEROJET GENERAL CORPORATION/36X,41HLIQUID ROCKET
  1 PLANT,SACRAMENTO CALIFORNIA//38X,12A6//19H I N P U T D A T A//)
  WRITE(6,100) BET(J),GAM(J), A(J), B(J)
100 FORMAT(9X,16HLINEAR EQUATIONS/12X,18H2 DELTA GF A = ,E12.5,
  16H, B = ,E12.5/12X,18HGB+ A = ,E12.5,6H, B = ,E12.5)
  WRITE(6,101)GAO(J),GBO(J),ALGPAO(J),ALGPBO(J)
101 FORMAT(9X,6HGAO = ,F7.0,8H, GBO = ,F7.0,12H, LOG PAO = ,F7.3,
  112H, LOG PBO = ,F7.3)
28 WRITE(6,29) T
29 FORMAT(9X,15HTEMPERATURE IS ,F6.1,15H DEGREES KELVIN,/)
  WRITE(6,102) CGA,CGB,CRLNA,CALF
102- FORMAT(21H O U T P U T D A T A//9X,5HGA+= ,E12.5,6H,GB+= ,E12.5,
  113H,RT LN ALFA= ,E12.5,7H,ALFA= ,E12.5//8X,1HX,11X,4HDGAB,10X,
  24HDGGB,11X,2HDG,12X,3HGAB,11X,3HGGB,12X,1HG,10X,6HLOG PA,8X,
  36HLOG PB)
  C1=4.576*T
  C2=C1*ALGPAO(J)
  C3=C1*ALGPBO(J)
  X=XMIN
C
30 ARG = ABS(X/.5-1.0)
  IF(ARG.LE.1.E-4) GO TO 32
  IF(X.LT.0.5) GO TO 34
```



# Contrails

```
IF(X.GT.0.5) GO TO 35
32 X = .500
   DGA = -CGA-RT*ALN2-CRLNA
   DGB = -CGB+CGA+DGA
   GO TO 36
34 DGA = TDGF(J)+CGB+RT*ALOG((1.-2.*X)/(1.-X))
   DGB = -CGB+RT*ALOG(X/(1.-2.*X))
   GO TO 36
35 DGA = -CGA+RT*ALOG((1.-X)/(2.*X-1.))
   DGB = TDGF(J)+CGA+RT*ALOG((2.*X-1.)/X)
36 VR1 = 1. -X
   DG=VR1*DGA+DGB*X
   GAB=DGA+GAO(J)
   GBB=DGB+GBO(J)
   G=VR1*GAB+X*GBB
   ALGPA=(DGA+C2)/C1
   ALGPB=(DGB+C3)/C1
   WRITE(6,33) X,DGA,DGB,DG,GAB,GBB,G,ALGPA,ALGPB
33 FORMAT(9(2X,E12.5))
   X=X+DELX
   IF(X.LE.XMAX) GO TO 30
   J=J+1
   IF(J.LE.ICNT1) GO TO 21
   GO TO 1
END
```

# *Contrails*

DOCUMENT CONTROL DATA - R&D		
(Security classification of title, body of abstract and indexing annotation must be entered when the overall report is classified)		
1. ORIGINATING ACTIVITY (Corporate author)  Aerojet-General Corporation Materials Research Laboratory Sacramento, California	2a. REPORT SECURITY CLASSIFICATION <p style="text-align: center; font-size: large;">Unclassified</p> 2b. GROUP <p style="text-align: center; font-size: large;">N.A.</p>	
3. REPORT TITLE  Ternary Phase Equilibria in Transition Metal-Boron-Carbon-Silicon Systems Part IV. Thermochemical Calculations, Volume III. Computational Approach to to the Calculation of Ternary Phase Diagrams		
4. DESCRIPTIVE NOTES (Type of report and inclusive dates)		
5. AUTHOR(S) (Last name, first name, initial)  Chang, Y. A.		
6. REPORT DATE  February 1966	7a. TOTAL NO. OF PAGES  69	7b. NO. OF REFS  10
8a. CONTRACT OR GRANT NO. AF 33(615)-1249  b. PROJECT NO. 7350  c. Task No. 735001  d.	9a. ORIGINATOR'S REPORT NUMBER(S)  AFML-TR-65-2 Part IV, Volume III  9b. OTHER REPORT NO(S) (Any other numbers that may be assigned this report)  N.A.	
10. AVAILABILITY/LIMITATION NOTICES <del>This document is subject to special export controls, and each transmittal to                      for eign governments for foreign nationals may be made only with prior approval of                      Metals &amp; Ceramics Div., AF Materials Laboratory, Wright-Patterson AFB, Ohio.</del>		
11. SUPPLEMENTARY NOTES	12. SPONSORING MILITARY ACTIVITY  AFML (MAMC) Wright-Patterson AFB, Ohio	
13. ABSTRACT  <p>The general conditional equations which govern the phase equilibria in three-component systems are presented. Using the general conditional equations, a general method has been developed to precalculate the phase equilibria in three-component systems from first principle using computer technique. The method developed has been applied to several model examples and the system Ta-Hf-C. The phase equilibria in three-component systems calculated using the simplified method as originally developed by Rudy, agree well with those calculated by the present method. The only difference is in the homogeneous range with respect to the interstitial component of solid solutions which exhibit large variation with metal exchange. This is to be expected in view of the assumptions made in the simplified method.</p> <p>In connection with the phase diagram calculation and other problems of the present Air Force contract, several computer programs have been developed which are included in the appendix of this report.</p> <p style="font-style: italic; font-size: large;">This document has been approved for public release and sale; its distribution is unlimited. USAF Systems Command</p>		

**Unclassified**  
Security Classification

14.	KEY WORDS	LINK A		LINK B		LINK C	
		ROLE	WT	ROLE	WT	ROLE	WT
	<p>Thermodynamics Ternary Phase Diagram</p>						

**INSTRUCTIONS**

**1. ORIGINATING ACTIVITY:** Enter the name and address of the contractor, subcontractor, grantee, Department of Defense activity or other organization (*corporate author*) issuing the report.

**2a. REPORT SECURITY CLASSIFICATION:** Enter the overall security classification of the report. Indicate whether "Restricted Data" is included. Marking is to be in accordance with appropriate security regulations.

**2b. GROUP:** Automatic downgrading is specified in DoD Directive 5200.10 and Armed Forces Industrial Manual. Enter the group number. Also, when applicable, show that optional markings have been used for Group 3 and Group 4 as authorized.

**3. REPORT TITLE:** Enter the complete report title in all capital letters. Titles in all cases should be unclassified. If a meaningful title cannot be selected without classification, show title classification in all capitals in parenthesis immediately following the title.

**4. DESCRIPTIVE NOTES:** If appropriate, enter the type of report, e.g., interim, progress, summary, annual, or final. Give the inclusive dates when a specific reporting period is covered.

**5. AUTHOR(S):** Enter the name(s) of author(s) as shown on or in the report. Enter last name, first name, middle initial. If military, show rank and branch of service. The name of the principal author is an absolute minimum requirement.

**6. REPORT DATE:** Enter the date of the report as day, month, year; or month, year. If more than one date appears on the report, use date of publication.

**7a. TOTAL NUMBER OF PAGES:** The total page count should follow normal pagination procedures, i.e., enter the number of pages containing information.

**7b. NUMBER OF REFERENCES:** Enter the total number of references cited in the report.

**8a. CONTRACT OR GRANT NUMBER:** If appropriate, enter the applicable number of the contract or grant under which the report was written.

**8b, 8c, & 8d. PROJECT NUMBER:** Enter the appropriate military department identification, such as project number, subproject number, system numbers, task number, etc.

**9a. ORIGINATOR'S REPORT NUMBER(S):** Enter the official report number by which the document will be identified and controlled by the originating activity. This number must be unique to this report.

**9b. OTHER REPORT NUMBER(S):** If the report has been assigned any other report numbers (*either by the originator or by the sponsor*), also enter this number(s).

**10. AVAILABILITY/LIMITATION NOTICES:** Enter any limitations on further dissemination of the report, other than those

imposed by security classification, using standard statements such as:

- (1) "Qualified requesters may obtain copies of this report from DDC."
- (2) "Foreign announcement and dissemination of this report by DDC is not authorized."
- (3) "U. S. Government agencies may obtain copies of this report directly from DDC. Other qualified DDC users shall request through \_\_\_\_\_."
- (4) "U. S. military agencies may obtain copies of this report directly from DDC. Other qualified users shall request through \_\_\_\_\_."
- (5) "All distribution of this report is controlled. Qualified DDC users shall request through \_\_\_\_\_."

If the report has been furnished to the Office of Technical Services, Department of Commerce, for sale to the public, indicate this fact and enter the price, if known.

**11. SUPPLEMENTARY NOTES:** Use for additional explanatory notes.

**12. SPONSORING MILITARY ACTIVITY:** Enter the name of the departmental project office or laboratory sponsoring (*paying for*) the research and development. Include address.

**13. ABSTRACT:** Enter an abstract giving a brief and factual summary of the document indicative of the report, even though it may also appear elsewhere in the body of the technical report. If additional space is required, a continuation sheet shall be attached.

It is highly desirable that the abstract of classified reports be unclassified. Each paragraph of the abstract shall end with an indication of the military security classification of the information in the paragraph, represented as (TS), (S), (C), or (U).

There is no limitation on the length of the abstract. However, the suggested length is from 150 to 225 words.

**14. KEY WORDS:** Key words are technically meaningful terms or short phrases that characterize a report and may be used as index entries for cataloging the report. Key words must be selected so that no security classification is required. Identifiers, such as equipment model designation, trade name, military project code name, geographic location, may be used as key words but will be followed by an indication of technical context. The assignment of links, rules, and weights is optional.

**Unclassified**

Security Classification