

AFFDL-TR-73-159 VOLUME I

**THE MARK IV SUPERSONIC-HYPERSONIC
ARBITRARY-BODY PROGRAM
VOLUME I – USER'S MANUAL**

*ARVEL E. GENTRY
DOUGLAS N. SMYTH
WAYNE R. OLIVER*

DOUGLAS AIRCRAFT COMPANY
McDONNELL DOUGLAS CORPORATION

Approved for public release; distribution unlimited.

FOREWORD

This report describes a computer program developed at the Douglas Aircraft Division of the McDonnell Douglas Corporation, Long Beach, California. The development of the Douglas Arbitrary-Body Aerodynamic Computer Program was started in 1964 and greatly expanded in subsequent years under sponsorship of the Douglas Independent Research and Development Program (IRAD). From August 1966 to May 1967 the program development was continued under Air Force Contract No. F3361567-C-1008. The product of this work was the Mark II version of the program as released for use by government agencies in May 1967. Between 1967 and 1968 further Douglas IRAD work and another Air Force Contract (F33615-67-C1602) produced the Mark III Hypersonic Arbitrary-Body Program. The latest version of the program as presented in this report is identified as the Mark IV Supersonic-Hypersonic Arbitrary-Body Computer Program and was prepared in the period of 1972-73 under Air Force Contract F33615-72-C-1675. This contract was administered by the Air Force Flight Dynamics Laboratory, Flight Mechanics Division, High Speed Aero Performance Branch. The Air Force Project Engineers for this study were Verle V. Bland Jr., and Captain Hugh Wilbanks, AFFDL/FXG.

At the Douglas Aircraft Company, this work was conducted under the direction of Mr. Arvel E. Gentry as Principal Investigator. A number of major parts of the new program were prepared by Mr. Douglas N. Smyth. Mr. Wayne R. Oliver's work in applying the various versions of this program to practical design problems contributed both in program design and in program validation. A number of other people contributed to the various phases of this work for which the authors are grateful.

This report was submitted by the authors in November 1973.

This technical report has been reviewed and is approved.



PHILIP P. ANTONATOS
Chief, Flight Mechanics Division
Air Force Flight Dynamics Laboratory

ABSTRACT

This report describes a digital computer program system that is capable of calculating the supersonic and hypersonic aerodynamic characteristics of complex arbitrary three-dimensional shapes. This program is identified as the Mark IV Supersonic-Hypersonic Arbitrary-Body Computer Program. This program is a complete reorganization and expansion of the old Mark III Hypersonic Arbitrary-Body Program. The Mark IV program has a number of new capabilities that extend its applicability down into the supersonic speed range.

The outstanding features of this program are its flexibility in covering a very wide variety of problems and the multitude of program options available. The program is a combination of techniques and capabilities necessary in performing a complete aerodynamic analysis of supersonic and hypersonic shapes. These include: vehicle geometry preparation; computer graphics to check out the geometry; analysis techniques for defining vehicle component flow field effects; surface streamline computations; the shielding of one part of a vehicle by another; calculation of surface pressures using a great variety of pressure calculation methods including embedded flow field effects; and computation of skin friction forces and wall temperature.

Although the program primarily uses local-slope pressure calculation methods that are most accurate at hypersonic speeds, its capabilities have been extended down into the supersonic speed range by the use of embedded flow field concepts. This permits the first order effects of component interference to be accounted for.

The program is written in FORTRAN for use on CDC or IBM type computers.

The program is documented in three volumes. Volume I is primarily a User's Manual, Volume II gives the Program Formulation, and Volume III contains the Program Listings.

FEB 15 2006

Contrails

Contracts

CONTENTS

	Page
SECTION I INTRODUCTION	1
SECTION II PROGRAM FRAMEWORK.	3
SECTION III INPUT DATA INSTRUCTIONS.	9
INPUT TO MAIN EXECUTIVE ROUTINE	11
Executive Flag Card.	11
System Control Card.	11
GEOMETRY DATA PREPARATION	12
Geometry Nomenclature.	12
Geometry Data Preparation Methods.	14
Input to Geometry Executive Control and	
Quadrilateral Calculation Routine	15
Geometry Control Card.	15
Panel Identification Card.	18
Scale Factor Card.	21
Input to the Element Reading Routine.	22
Element Control Card	22
Element Data Input Cards	27
Elliptical-Cross-Section Data	29
Ellipse Generation Control Card.	29
Cross-Section Data Cards	30
Parametric-Cubic Input Data	33
Parametric Cubic Title Card.	34
Parametric Cubic Boundary Data	36
Aircraft Geometry Option.	38
Aircraft Geometry Identification and	
Control.	43
Control Flag Card.	44
Wing Area Card	45
Wings.	46
Wing Percent-Chord Location Cards	49
Airfoil Leading Edge Coordinate Cards	49
Wing Camber Line Cards.	49
Wing Airfoil Ordinate Cards	50
Fuselage	51
Fuselage X-Station Cards.	53
Fuselage Camber Cards	53
Fuselage Cross-Section Area Cards	53
Fuselage Y-Ordinate Cards	54
Fuselage Z-Ordinate Cards	54
Pods or Nacelles	55
Pod Origin Card	57
Pod X-Station Cards	57
Pod Radii Cards	58
Fins	59
Fin Leading Edge Coordinate Card.	60
Fin Percent-Chord Location Card	60
Fin Airfoil Ordinate Card	60

Contrails

	Page
Canards or Horizontal Tails	61
Canard Leading Edge Coordinate Card	62
Canard Percent-Chord Location Card	62
Canard Upper Ordinate Card	62
Canard Lower Ordinate Card	62
General Airfoil Surfaces	64
General Airfoil Control Flag Card	66
Airfoil Percent-Chord Location Cards	67
Airfoil Orientation Cards	67
Airfoil Camber Distribution Cards	67
Airfoil Thickness Distribution Cards	67
AERODYNAMIC PROGRAM INPUT DATA	69
Input to Aero Executive Routine	69
Aero System Title Card	69
Aero Flag Card	69
Flight Condition Card	70
Reference Dimension Card	70
α - β Cards	71
Flow Field Program Input Data	72
Flow Field Data	75
Master Directory Title Card	75
Master Directory Data Set Card	75
α - β Set Directory Table Card	76
Region Directory Table Card	76
Hand-Load Flow Field Option	78
Hand-Load Data Type Flag Card	78
Flow Field Data Load of Uniform Flow Field	78
Non-Uniform Flow Field Data Control and Plane Orientation Card	78
Sub-Region Control Card	79
Flow Field Coordinate Card	80
Flow Field Data Card	80
Simple Flow Field Option	81
Simple Flow Field Data Source Card	81
Simple Flow Field Data Card	81
Shock-Expansion Flow Field Option	82
Shock Expansion Flow Field Control Card	85
Cutting Plane Control Card	86
Cutting Plane Origin and Orientation Card	87
Meridian Planes Input Position Card	87
Parallel Planes PHI Card	87
Parallel Planes Input Position Cards	88
Surface Data Transfer Option	89
Flow Field Control and Plane Orientation Card	89
Hand Loaded Surface Property Data Cards	90
Surface Data Coordinate Card	90
Surface Data Property Card	90
Surface Data Panel Selection Card	91

Contents

	Page
Surface Streamline Option.	92
Surface Property Access Flag Card	94
Normalization Data Cards.	96
Streamline Identification and Title Card.	96
Streamline Data Cards	97
Shielding Program Input Data.	99
Shielding Title Control Card	99
Shielding Panel Control Card	100
Pressure Calculation Program Input Data	101
Title Card and Basic Flags	101
Component Organization Card.	101
Pressure Method Cards.	103
Interference Method Cards.	108
Interference Method Control Card.	108
Uniform Flow Field Card	110
Input Pressure Option.	111
Surface Property Access Flag Card	111
Normalization Data Cards.	113
Viscous Program Option.	114
Skin Friction Basic Flag and Title Card.	114
Geometry Data Source Card.	114
Skin Friction Method Cards	114
Integral Method Boundary Layer Input Data.	116
Streamline Data Source Card	116
Integral Skin Friction Method Control Data.	117
Integral Method Flag Card	119
Streamline Selection Card	121
Viscous Force Cards	122
Surface Property Access Flag Card.	122
Normalization Data Cards	124
Mark III Skin Friction Element Data Cards.	125
Special Routines Option Input Data.	130
Special Option Selection Card.	130
Summation Routine Option.	131
Summation Control Card	131
AUXILIARY PROGRAMS	133
Auxiliary Programs Control Card	133
General Cutting Plane Option	134
Input to General Cutting Plane Option	137
Configuration Description Card	137
Component Control Card	137
Cutting Plane Origin and Orientation Card	137
Meridian Planes Input Position Card.	138
Parallel Planes PHI Card	138
Parallel Planes Input Position Cards	138
Panel Identification and Control Card.	138
Output Data Control Card	138

Contrails

	Page
SECTION IV OUTPUT DATA.	140
GEOMETRY OUTPUT DATA.	141
FLOW FIELD SECOND ORDER SHOCK EXPANSION OUTPUT DATA.	142
SHOCK EXPANSION CUTTING PLANE OUTPUT DATA	144
SURFACE DATA TRANSFER OPTION OUTPUT DATA.	145
FLOW FIELD DATA READ OUTPUT DATA.	146
SHIELDING PROGRAM OUTPUT DATA	148
AERODYNAMIC FORCE COEFFICIENT OUTPUT DATA	149
DETAILED FORCE CHARACTERISTICS OF EACH ELEMENT.	150
MARK III SKIN FRICTION OUTPUT DATA.	152
MARK III SKIN FRICTION METHOD TEMPERATURE ITERATION OUTPUT.	154
INTEGRAL BOUNDARY LAYER PROGRAM OUTPUT DATA	156
FORCE SUMMATION OUTPUT DATA	162
STREAMLINE OPTION OUTPUT DATA	163
APPENDIX A INVISCID PRESSURE CALCULATION METHODS.	164
COMPARISON OF METHODS	164
DISCUSSION OF PRESSURE METHODS.	182
Modified Newtonian	182
Modified Newtonian + Prandtl-Meyer	185
Tangent Wedge (Oblique Shock).	185
Tangent Wedge Empirical.	186
Tangent Cone	186
Van Dyke Unified Method.	187
Modified Dahlem-Buck Method.	187
Shock Expansion Method (Strip Theory).	187
Free Molecular Flow.	195
Delta Wing Empirical	196
APPENDIX B GEOMETRY DATA CHECKOUT	197
APPENDIX C SAMPLE PROBLEMS.	212
REFERENCES.	257

Contrails

SECTION I

INTRODUCTION

The program described in this manual is identified as the Mark IV Mod 0 Version of the Supersonic-Hypersonic Arbitrary-Body Aerodynamic Computer Program. This computer program consists of several major program components controlled by an executive main program. The program components are designed to provide the user with a complete geometric description of a vehicle shape in a form useful to the computer, computer graphics to check out the geometry data, analysis techniques for defining vehicle component flow field effects, surface streamline computations, the shielding of one part of a vehicle by another, calculation of surface pressures using a great variety of pressure calculation methods including embedded flow field effects, and computation of skin friction forces and wall temperature using both an elemental simple method (old Mark III) and an integral analysis along calculated streamlines. Together, these components provide the necessary capabilities for performing all of the tasks required in the preliminary-design aerodynamic analysis of hypersonic shapes. With the use of embedded flow concepts the programs capabilities are also extended down into the supersonic speed region where component interference effects become important.

This computer program is written in FORTRAN for use on CDC computers. A small conversion routine is also furnished that will automatically convert the program for use on the IBM series of computers. On the CDC computers the program will operate in less than 120K octal words of storage. On the IBM machines (IBM 370/165) the program requires approximately 200K bytes of storage.

The Mark IV program will eventually completely replace the old Mark III Hypersonic Arbitrary-Body Program distributed in April 1968 (Reference 1). However, the present Mod 0 version of the new Mark IV program does not as yet have all of the capabilities of the old Mark III program. Those capabilities missing from the Mark IV program include the computer graphics routines, stability derivatives, and control surface deflection. All of these capabilities will be added to the program in the near future.

This program places at the disposal of the user a collection of different aerodynamic analysis tools that he can use in attacking his particular problem. Therefore, the accuracy of the results achieved depends to a certain extent upon the user's knowledge of high speed aerodynamics and on how he decides to apply the program to his problem. The documentation reports for this program are designed to tell the user what the program has in it and how it can be used. No attempt is made to tell the user what methods or options he should use in attacking a given problem. For example, it is up to the user to decide if he should use the tangent cone pressure method on the bottom side of a delta wing instead of the tangent wedge method. The program will not make the selection for him.

Contrails

All of this means that the user should have a more fundamental understanding of the theoretical methods used than is the case with most other computer programs. Before using any option the user should review the applicable material in the Program Formulation report, Volume II, to be sure that the option selected will give the best answer for the particular problem. A shotgun approach of just trying all of the pressure methods and selecting the ones that give the best correlation with total force coefficient test data should be avoided. The user should instead be more concerned with the prediction and correlation of detailed pressures on the various vehicle components. If the pressure methods are selected on this basis and the resulting total force coefficients are still not too good, then the user should search for other reasons for the differences (i.e., the failure to account for some interference effect, the inadequacy of methods available, etc.).

SECTION II

PROGRAM FRAMEWORK

The new Mark IV program has a completely different program framework from that used on the old Mark III program. In the new program the various functional jobs are separated in completely independent parts of the program. While some separation was used in the old Mark III program, the functional jobs of geometry, pressure and viscous calculations of the program were all together in one major grouping of routines. In the new Mark IV program the geometry generation and storage routines are a completely separate part of the program. The aerodynamic part of the program has six major and completely separate components - Flow Field, Shielding, Inviscid Pressures, Streamline Analysis, Viscous Methods, and Special Routines.

The basic framework of the Mark IV program is shown in Figure 1. The geometry data for the Mark IV program is the same as for the Mark III program, so the old graphics programs generated for the Mark III program can still be used to check out the data. A new aircraft geometry option has been added to the geometry program.

It is important that the user understand the basic function of each of the major program components and the way in which data are saved for use in the different components. The loading of the basic geometry data is the most time consuming part of the input data preparation. All geometry input, generation, and storage is accomplished in the Geometry Option part of the program. Subroutine GEOM is the executive controller of this option. This is normally the first option called in the analysis of a new vehicle. The GEOM subroutine converts the input geometry data into quadrilateral elements and stores them along with the original input surface element corner point coordinates on unit 4 using mass storage (direct access) techniques. The organization of the data on unit 4 is described in Volume II.

All other parts of the program make use of the geometry data stored on unit 4. The vehicle is normally divided into a number of panels with each panel composed of a number of surface elements. Each panel is identified by a storage sequence number. The manner in which these panels are to be grouped together is determined in other parts of the program by direct reference to these panel sequence numbers. This adds considerable flexibility in the use of geometry data for many purposes. Some users may wish to modify their old graphics picture drawing programs to make use of this new data storage scheme.

The AERO part of the program contains six major program components; Flow Field Analysis, Shielding, Inviscid Pressures, Streamlines, Viscous Methods, and Special Routines. The Flow Field Analysis Option provides a number of features that are used in accounting for flow field interference between the various vehicle components. These flow field data may be either uniform (not a function of the space coordinates) or non-uniform. The non-uniform data are stored as a function of some combination of the space coordinates (X,Y,Z, angular orientation, radius).

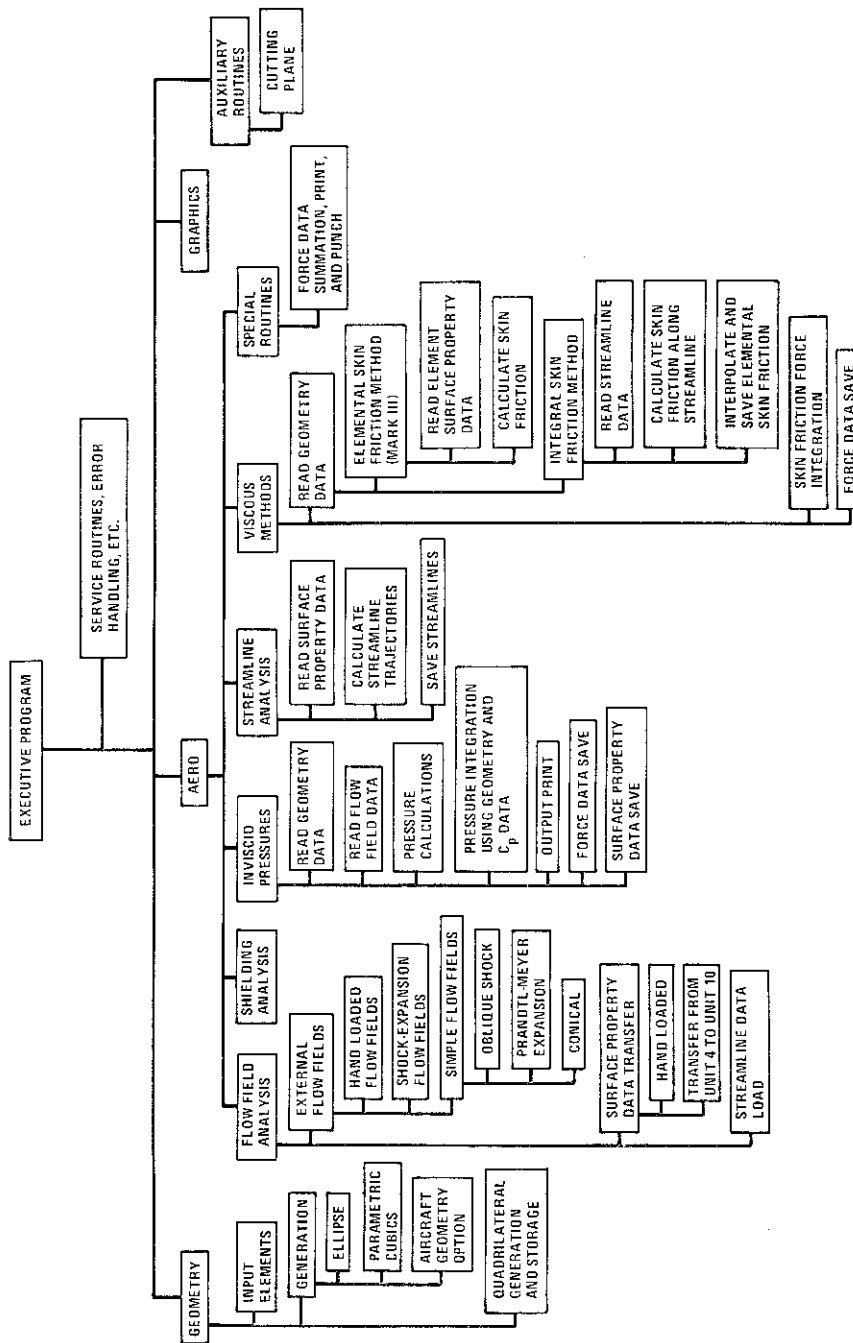

Figure 1. Functional Organization of Mark IV Program.

Contrails

When these data are required within the other parts of the program the necessary interpolations are accomplished to provide the local flow field data precisely at the point required. All of the interpolations are accomplished using a spline surface fit technique. All of the flow field data are stored on unit 10 using mass storage techniques. The format of the stored data is described in Figure 16 and in Volume II. Flow field data must be generated in the FLOW option and stored on unit 10 before interference calculations can be attempted in the Inviscid Pressure part of the program.

The flow field data to be stored on unit 10 may be either input directly using the Hand Input Option, or they may be generated by the Flow Field Generation options provided. The shock-expansion option provided for this purpose requires the use of geometry data previously stored on unit 4. This geometry may be actual parts of the vehicle or it may be special geometry input only for the purpose of generating the flow field data. Further input data are used to specify the orientation and position of the cutting planes used in the shock-expansion calculations. These cutting planes are then passed through the specified geometry panel combination to define surface lines along which the shock-expansion calculations are performed. The shock-expansion calculations produce local surface properties, properties along the shock, and when required the properties within this bounded flow field. These properties in terms of the local Mach number, the direction cosine components of the local surface velocity vector, the ratio of local pressure to freestream pressure (P/P_∞), and temperature ratio (T/T_∞), are then stored on the flow field storage unit 10. The flow field data are stored under a set of region pointer numbers. These region sequence numbers are then used by the Inviscid Pressure part of the program to retrieve the desired flow field data for use in the interference calculations. The present version of the program does not include interference effects in the viscous computations except as they might come through from the use of local property data that included interference effects.

For some types of hypersonic force calculations it is necessary to know what parts of the vehicle are shielded from the freestream flow by other vehicle components. To do this, it is first necessary to make an element-by-element check for possible shielding situations. This is accomplished in the Shielding Option. Before using this option the user should first obtain pictures of the vehicle geometry at the desired angle of attack and yaw angle. These pictures will indicate what vehicle panel sequence numbers will possibly be shielded, and what panels will be doing the shielding. These shielded and shielding panel sequence numbers are input to the Shielding Option to minimize the number of element searches necessary. Otherwise, it would be necessary to have the shielding routine search every single element for possible shielding by every other element.

When an element is completely shielded by another element a new element identical to the shielded element is created, but it is given a negative element area. If only a portion of an element is shielded then one or

Contrails

more negative area elements will be created to represent the shielded portion. The number of new elements created will depend upon the orientation of the two elements as viewed from the freestream direction. The negative area elements are stored sequentially on unit 3. These data are used within the Inviscid Pressure part of the program in the standard manner. All of the vehicle elements including these additional negative area elements are analyzed and their force contributions calculated. The negative area elements are thus able to cancel out the force contribution of the vehicle elements or portion of elements that are shielded from the freestream flow. Obviously, if shielding is to be accounted for in the pressure calculations, then the Shielding option must be used before the Inviscid Pressure option is entered.

The Inviscid Pressure part of the program contains all the facilities necessary to calculate the pressures and resultant forces on each quadrilateral element. These forces are summed to determine the total force coefficients for the vehicle. The geometry data used by the inviscid pressure calculations are obtained from unit 4 where they must have been stored by the Geometry Option. The geometry panels are grouped into several vehicle components for the purposes of the pressure calculations at the direction of the user. The components are formed merely by specifying the panel sequence numbers to be grouped together to form a component. Each part of the vehicle that requires a different set of pressure calculation methods must be grouped into a separate vehicle component. If interference calculations are to be made, then the flow field region numbers to be considered for each component must also be specified. The flow field data must have been previously stored on unit 10 before the inviscid pressure calculations are attempted.

Under the control of an input flag, the local flow properties on the surface may also be stored back on to unit 4 along with the geometry data for use in streamline calculations or in the Viscous Option. The total force coefficients for each vehicle component are stored on unit 9 using mass storage techniques. No component summation is performed in the Inviscid Option. Instead, this is accomplished in the Special Routines portion of the AERO program by the SUM routine. This option may also be used to punch out the final coefficients for use in off-line plotters.

The surface Streamline Option may be used to generate streamlines along which subsequent viscous computations will be made. This option makes use of surface velocity vector data previously calculated and stored on the flow field unit by the Surface Data Transfer Option of the Flow Field routines. The Surface Data Transfer Option, in turn, obtained its information from the data saved on unit 4 during the inviscid pressure calculations.

The Viscous Option of the program contains the skin friction methods used in the old Mark III program plus a new Integral Skin Friction program that may be used where more detailed skin friction data are desired. The Integral Skin Friction Option calculates viscous properties along the

Contrails

streamlines determined in the Streamline Option and stores the results on the Surface Data Storage Unit 10 right along with the streamline surface data. These data are then fit with the surface spline techniques and the skin friction coefficient determined by interpolation for each surface geometry element. By using this method the skin friction distribution over the complete surface of a vehicle component may be calculated using the same geometry data set as was used for the inviscid pressure calculations (and using the Inviscid Option calculated local properties). In most applications, however, it will be best to make use of some combination of both the old Mark III Skin Friction option and the new Integral Method in the analysis of a typical vehicle. The Mark III Skin Friction option should be used when possible because of the shorter computing times and its usually sufficient accuracy. The Integral Method should be used only in situations where more detailed skin friction information is needed over the complete surface of a given component.

The Force Data Summation Option under the Special Routines section of the AERO program may be used to selectively sum, print, and punch data that has been previously stored on the Force Data Save unit 9 by the the Inviscid and Viscous routines. The results of these summations may also be stored back on the Force Data Save unit. This is the only option provided in the program for adding together the force contributions of different vehicle components. This capability is no longer provided in the inviscid portion of the program as it was in the old Mark III version. Later versions of the program will include derivative and trim options in this portion of the system.

The present version of the program does not contain any graphics capability. To check out geometry data, the user must make use of graphis capability developed and used on the Mark III program. A future addition to the Mark IV program will include a new graphics package that will include perspective picture drawing options, and the ability to draw pictures of surface velocity vectors, surface streamlines, and flow field shock systems. All of these data are already stored on Geometry Data Storage Unit 4 and on the Flow Field Data Storage Unit 10.

The Auxiliary Routines section of the present program contains the General Cutting Plane Option. This option has the capability to determine the section shape of any arbitrary body in any desired plane. This option is useful in a number of geometry related problems. For example, it can be used to help define the wing-body juncture in the detailed geometry preparation stage.

The Mark IV program is controlled by the Executive Program. The input to the Executive routine provides a series of input selection options that direct the program to the Geometry, Aero, Graphics, or Auxiliary major components of the program. When it is necessary each of these components, in turn, uses a small executive routine to further control the selection of sub-options. This method of selecting which parts of

Contrails

the program are to be used in solving a particular problem is one distinguishing difference between the Mark IV and Mark III programs. A multitude of internal flags and switches provided the selection capability in the Mark III program. If the user uses only the capabilities in the new program that were available in the Mark III program, he will find that the Mark IV program is much easier to learn to use. However, the new options that are provided to give flow field interference effects, streamlines, shielding, etc., add to the complexity of the program operation.

SECTION III

INPUT DATA INSTRUCTIONS

This computer program system uses a free-form approach to the preparation of the input data. That is, the order of the input cards depends upon the requirements of the problem being solved. This is true of both the system control data and the input data to each of the major program components. For this reason, few standard data load sheets are provided. In most cases the user will find that a simple 80-column load sheet can be used. This means that the cards can be written on the load sheet in the order in which they will be read into the program. This will save the card shuffling that was necessary when using the input sheets in the Mark III program. In the Mark IV program all of the input data is read right at the beginning of the job and printed out on the output unit. In this way the user always has a record of the input data along with the output results of the program.

This program is entitled the "Supersonic-Hypersonic Arbitrary-Body Program." This title brings with it certain inherent problems. If we are going to permit a completely arbitrary shape, we will have to use a large amount of data in describing it for the computer - we must be willing to pay something for the freedom of arbitrariness. Also, since no single pressure-calculation method will give good answers for all possible vehicle shapes under all flight conditions, we must have available a large number of force-calculation methods and know how and when to use them. The flow field computation capabilities permit the first order investigation of flow field interference effects between vehicle components. Here again, the user must have a good idea of what types of flow fields to expect over the surface of the shape before he can adequately prepare the flow field generation input data. Don't expect the program to do as good a job as a complete three-dimensional method of characteristics would be able to do. Also, at the low supersonic Mach numbers and on simple shapes, don't expect the program to give as accurate answers as might be obtained in an influence coefficient lifting surface program where all interference effects are accounted for.

The basic approach in the design of this computer program system has been an attempt to minimize the difficulties caused by these two problem areas. The program has been designed so that simple problems are very easy to set up and run. However, the program is written with a great deal of flexibility, enough to handle almost all situations that may arise. With the more complex problems, the input also becomes more complicated. The user should study the different sample problems provided in this manual before he tries to approach his own problem.

The user of this program is cautioned to follow closely the instructions given in this manual. He should not rely on his experience with the old Mark III program or with preliminary versions of the Mark IV program as most of the input data formats have changed. At times the user may find it helpful to study the code listings provided in Volume II to more clearly understand the input data requirements. However, as with any

Contrails

similar set of documents, no written manuals are a substitute for a complete understanding of the problem to be solved, a methodical approach to the preparation and checking of the input data, and a careful analysis of the output data. Also, the accuracy of this program in any given application depends upon the wisdom of the engineer in selecting the proper flow field and force-calculation methods.

A brief summary of the input data requirements for the Mark IV Program is given below. This is followed by a more detailed card-by-card description of all of the input items.

The Mark IV Program requires an Executive Flag Card and a System Control Card. These cards are followed by the sets of data cards for each program option to be executed. The sets of data furnished must be in the same order as the options are specified on the System Control Card.

In the detailed card-by-card descriptions given on the following pages some of the cards may have an assigned card TYPE number which must be punched in card columns 71-72. In the old Mark III program every card required a TYPE number. However, in most cases the Mark IV program does not have these numbers assigned.

The general scheme used in describing the input data is shown below.

<u>Column Code</u>	<u>Routine Format</u>	<u>Explanation</u>
--------------------	---------------------------	--------------------

The meaning of each of these columns is as follows:

- Column - Indicates the position on the card for each data field.
- Code - Gives the FORTRAN name used in the read statement by the program.
- Routine - Indicates the subroutine where the data is read.
- Format - Indicates the FORTRAN format of the data read statement. The parameter I4 would indicate that the parameter is an integer, right justified in a field that is 4 columns wide. The parameter F10.0 would indicate a fixed point number punched with a decimal point and sign, and placed anywhere in the card columns indicated.
- Explanation - The description of the input data parameters, flags, etc.

Contrails

INPUT TO MAIN EXECUTIVE ROUTINE

Only two input cards are required for the Executive Program.

Executive Flag Card (2I1) *Right hand justified*

This card must be the first card in the data deck.

Column Code	Routine Format	Explanation
1 IEROR	Main II	Automatic ABEND dump flag. Used in IBM version of the program only. = 0 Any IHC type of error will cause an automatic OC4 type of System ABEND. This is useful in tracking down both program and input errors. = 1 Automatic ABEND capability is not turned on.
2 INMONT	Main II	Input monitor control flag. This flag causes all of the input data to be copied from the input unit (5) to Unit 1. As this is being done all the input cards (except for the Executive Flag Card) are written out on the output unit (6). = 0 The monitor routine is called as is described above. = 1 The monitor routine is not called and the input data is not printed on unit 6 or transferred to unit 1.

System Control Card (20I1,39X,A4)

1 IPG(1)	Main 20I1	System options in the order that they are to be executed.										
2 IPG(2)												
3 IPG(3) etc.		<table><thead><tr><th>IPG</th><th>Option</th></tr></thead><tbody><tr><td>= 1</td><td>Call GEOM.</td></tr><tr><td>= 2</td><td>Call AERO.</td></tr><tr><td>= 3</td><td>Call GRAPH.</td></tr><tr><td>= 4</td><td>Call AUXILI.</td></tr></tbody></table>	IPG	Option	= 1	Call GEOM.	= 2	Call AERO.	= 3	Call GRAPH.	= 4	Call AUXILI.
IPG	Option											
= 1	Call GEOM.											
= 2	Call AERO.											
= 3	Call GRAPH.											
= 4	Call AUXILI.											
20 IPG(20)												
60-63 CASE	Main A4	Case identification.										

Contrails

GEOMETRY DATA PREPARATION

GEOMETRY NOMENCLATURE

Before proceeding with the detailed descriptions of the geometry input data several (and often confused) geometry terms should be defined. Users of the Mark III program should take note of these since some changes and additions have been made in these definitions for the Mark IV program.

Surface Element:	This, the smallest geometry unit, consists of four related points on the surface of the vehicle and the area enclosed by lines connecting successive points. All geometry data must eventually be made available to the program in surface-element form.
Plane Quadrilateral Element:	Each surface element is converted by the program into a plane quadrilateral element. The plane quadrilateral element is the basic geometric unit used in the force calculations. This unit, in effect, is the integration step size and is fixed once the surface element representation of the shape is established.
Cross-Section Cut:	A cross-section cut is that view obtained by cutting the vehicle in the longitudinal plane (Z, Y plane), at a constant X-station.
Vehicle Section:	A vehicle section consists of an aggregation of surface elements that have similar size and proportions. On the Type 3 element data cards a Section starts when a point with STATUS = 2 is found. A Section ends when the next STATUS = 2 (or 3) is found.
Vehicle Panel:	This is a newly defined parameter. It is used to indicate a part of the vehicle that is made up of several Sections. On the Type 3 element data cards a Panel is ended when a STATUS = 3 is found.
Vehicle Component:	A Component is defined as a major part of the vehicle that is to be analyzed by the program as a unit (i.e., a wing, tail, etc.). A Component is usually made up of several Panels.

These various definitions are illustrated in the table and Figure 2.

Contrails

Basic Quantity	Combine	To Form	Examples
Points	→	Elements	
Elements	→	Sections	Inboard Section A, Flap Section B, outboard Section C.
Sections	→	Panels	Sections A,B,C form upper wing panel.
Panels	→	Components	Upper and lower panels form wing Component.
Components	→	Vehicle	Wing, fuselage, tail, etc. components form the complete vehicle.

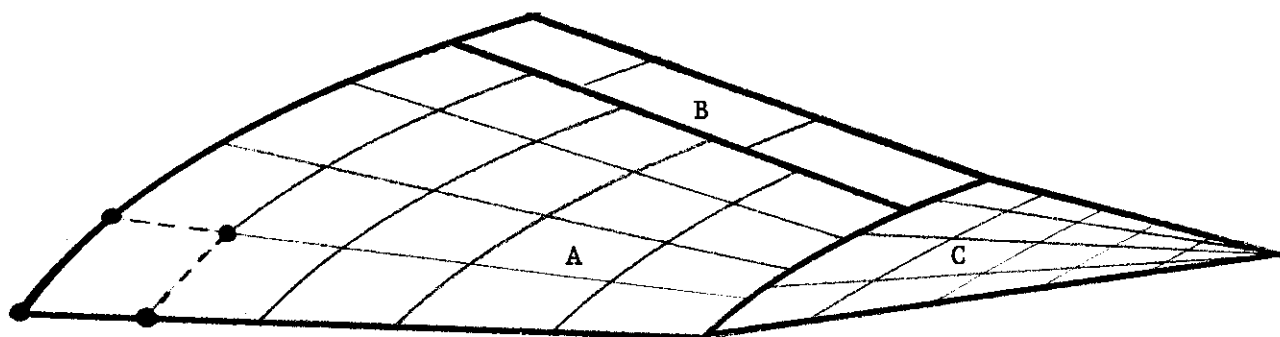

Figure 2. Geometry Definitions Diagram.

In this new program the geometry data are stored on the Quadrilateral Element Storage unit 4 by PANELS. That is, each PANEL is identified by a sequence number. In the AERO part of the program these PANELS may be grouped together to form vehicle COMPONENTS for the aerodynamic analysis. The PANELS are assigned consecutive sequence numbers (ISTAT3) by the GEOMETRY routine as they are stored on the Quadrilateral Storage unit 4. The user must keep track of the panel sequence numbers for each panel (each STATUS = 3) stored on Unit 4. These panel sequence numbers are required as input to the other parts of the program to retrieve the proper geometry data for the flow field, inviscid pressure, and skin friction calculations.

GEOMETRY DATA PREPARATION METHODS

Several options are available for describing the geometric shape of a vehicle or component for use in this program. These methods are selected at the discretion of the user. A given vehicle may be defined by a combination of the methods. These methods permit the user to describe a completely arbitrary shape, or to synthesize a vehicle from simple component parts, depending upon the requirements of the problem. The general techniques used in achieving this are outlined below.

In the Mark IV Program, the geometry data are input using one of the following methods:

1. Surface-element method (distributed elements). This method uses a large number of surface coordinate points that are related to groups of 4 to form a surface element. The program then converts the area defined by each set of 4 points into a plane quadrilateral element. All types of input geometry data eventually end up in this form before actual force computations are made.
2. Elliptical-cross-section data. In this method input data consist of the necessary radii, circle or ellipse center, and the sector of the circle or ellipse to be used. The program then converts these data into exactly the same surface-element form as described in the above paragraph. These data created by the program are in the correct format for conversion to plane quadrilaterals for subsequent calculations. The element geometry data generated in this method are stored on the geometry data storage tape (Tape 8).
3. Mathematical surface fit (Parametric Cubics). The surface input data for this method consist of coordinates of points along the four boundaries of a patch. The coefficients for a mathematical surface fit equation are then calculated to provide a description of the interior surface of the patch. This surface is then converted to exactly the same form as in Method 1 by a systematic variation of the two parametric parameters. Again, as in Method 2 above, the resulting element data are saved on the geometry storage tape for subsequent conversion to plane quadrilaterals.
4. Aircraft Geometry Generation Program. This program is designed to simplify the loading of aircraft types of configurations (i.e., wings, tails, nacelles, etc.).

The selection of the method to be used in describing a shape depends upon the detailed requirements of the problem and the vehicle shape. For completely arbitrary shapes either the surface element or the parametric cubic method would be used. For simple shapes, such as a vehicle nose, leading edge, or circular or elliptical cross section, the elliptical-surface generation method (method 2) would be used. For a vehicle synthesized from a number of simple components the geometry data can be generated by a separate program.

Note: The total number of elements that can be analyzed by the program at one time depends upon whether or not surface property data are to be saved and upon the number of α - β combinations. See the discussion on Data Storage Techniques for Unit 4 in Volume III.

Contrails

Geometry data required by the program may actually serve two different purposes.

1. Vehicle geometry data over which actual pressures will be calculated.
2. Special geometric surfaces to be used for other purposes such as to calculate flow fields, simplified skin friction, etc.

The Geometry Option will normally be the first option called (unless geometry data has been previously assembled and stored in quadrilateral form in the computer on a previous run).

The GEOM Program has two basic tasks: It provides for the input or generation of geometry data in ELEMENT form (TYPE3 cards), and for the conversion of these data to QUADRILATERAL form (surface area, outward normals, centroids, etc.). The ELEMENT cards when generated are usually stored on Unit IOUT (=8 for most cases). The QUADRILATERAL data are stored on Unit 4 using Mass Storage techniques for the CDC version and Direct Access for the IBM version.

A simplified flow chart of how the geometry data are read in and used is presented in Figure 3.

Input to Geometry Executive Control and Quadrilateral Calculation Routine

Geometry Control Card (112,5I1,1I2,15A4)

This is the first card for the GEOM option.

Column Code	Routine Format	Explanation
1-2 IOUT	GEOM I2	Output storage unit for Type 3 element data cards when they are generated by one of the geometry generation routines or loaded by the Element Load routine. Usually input = 8, but it may also be convenient to use it = 1 (or = 5 if INMONT = 1 on the Executive Flag Card). If quadrilaterals are not to be calculated IOUT may be input = 7 to obtain a punched deck of the Type 3 element cards.
3 IREW	GEOM I1	Rewind flag for unit IOUT. = 0 Rewind unit IOUT before storing any Type 3 cards on it. = 1 Do not rewind unit IOUT.
4 PRINTS	GEOM I1	Print flag for detailed quadrilateral characteristics. = 0 Do not print. = 1 Print.

Contrails

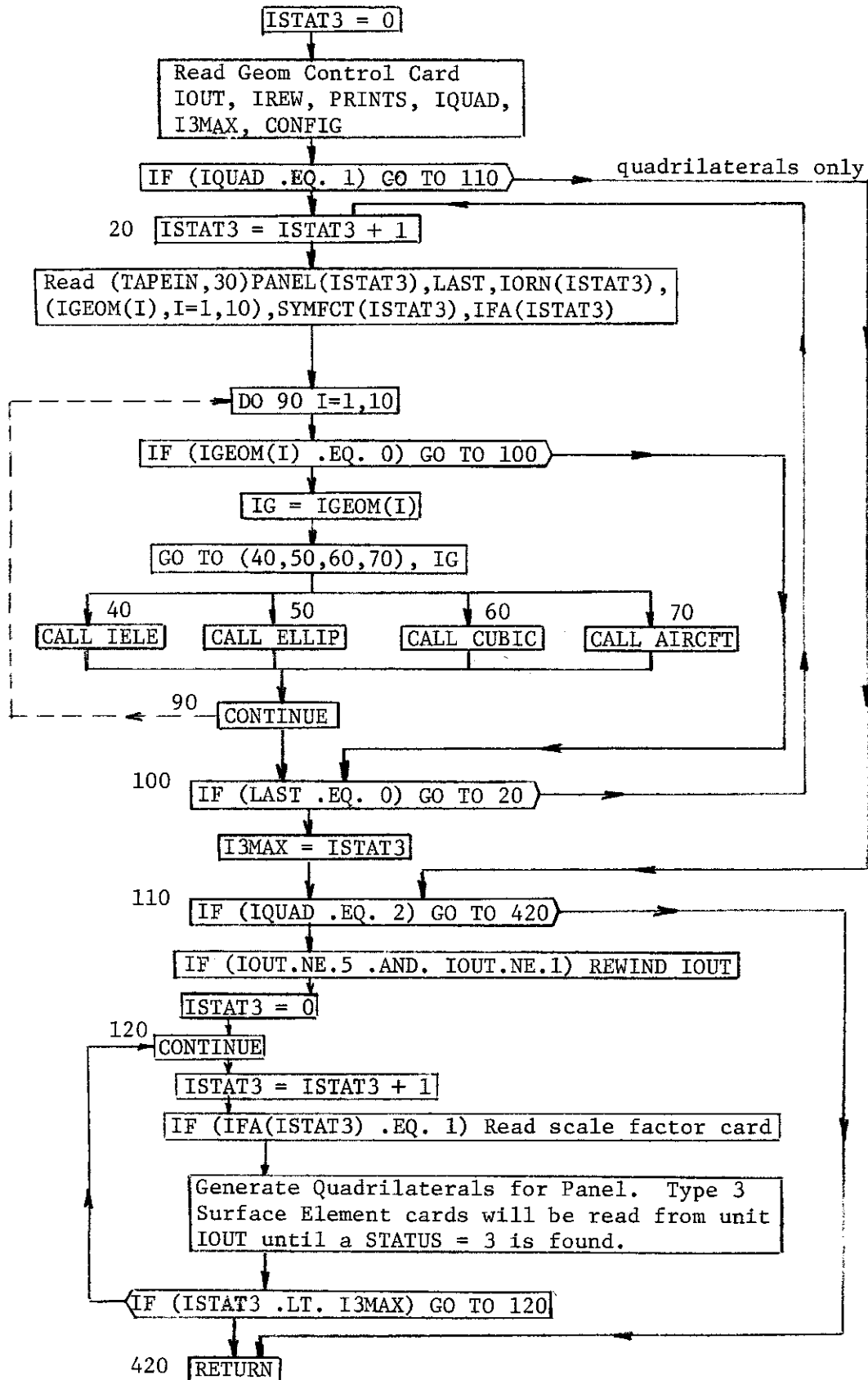

Figure 3. Geometry Input and Usage Flow Chart.

Contrails

Geometry Control Card (continued)

<u>Column Code</u>	<u>Routine Format</u>	<u>Explanation</u>
5	IQUAD	GEOM I1
		Quadrilateral Calculation Flag. = 0 Program will expect to use the geometry generation or storage routines to put elements on to unit IOUT. A Panel Identification card will be next in the deck. = 1 Program will by-pass the element generation and storage options. A Panel Identification Card will not be read. Program will read Type 3 geometry cards from unit IOUT and convert them to quadrilaterals. = 2 Same as = 0 above except that the program will not calculate the quadrilaterals. A Return from the GEOM routine will be called after the geometry generation or storage on unit IOUT is completed.
6	I3MAX	GEOM I1
		Number of Status 3's in the element unit IOUT. Used in determining when the end of the quadrilateral computations is reached (used only when IQUAD = 1). When IQUAD \neq 1 I3MAX is determined by the program.
7	NEW	GEOM I1
		New data set flag. = 0 This is a new data set unit for geometry data. Set up all flags and pointers. = 1 This is not a new data set. Use old flags and pointers to store additional panels.
8-9	NPMAX	GEOM I2
		Maximum number of panels to be provided for on the new geometry data unit. Used only when NEW = 0. If input as = 0 then the program will set NPMAX = 50.
10-69	CONFIG	GEOM 15A4
		Configuration identification to be written on the first record of the geometry storage unit (4).

Contrails

Panel Identification Card

(A4,2I1,10I1,2I1,4I2)

This card is required if IQUAD \neq 1. This card is used to control the flow to the various geometry generation routines. One of these cards is required before each entry into the geometry generation DO loop. The geometry generation DO loop is terminated by the LAST parameter on this card. Each Panel Identification Card can cause the geometry generation routines to be entered up to 10 times. The number of times that the geometry generation routines are to be entered is controlled by the IGEOM(I) parameter. When IGEOM(I) = 0 the DO loop is stopped. If IGEOM(I) = 0 the DO loop will not even be started but the Panel Identification Cards will be read in until LAST = 1.

Column Code	Routine Format	Explanation
1-4 PANEL(I)	GEOM A4	Panel number or code identification. This identification will be stored on the quadrilateral data storage unit 4.
5 LAST	GEOM I1	Last Panel flag. = 0 This is not the last Panel Identification Card. = 1 This is the last Panel Identification Card.
6 IORN(I)	GEOM I1	Geometry orientation flag (same is in the Mark III program). = 0 Normal mode using cross-sections. = 1 Geometry data input in streamwise strips. = 2 Geometry data input in streamwise strips but for each streamwise strip of elements the first coordinate point in the right-hand strip of points is not used in the formation of the leading edge element but is ignored by the program. This is illustrated in the diagrams below for the lower wing of a vehicle. The streamwise direction is indicated by the arrow.

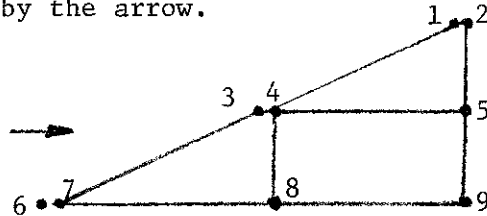

In the diagrams above the numbers indicate the order of the input points. Note that points 1 and 2 are duplicate points (same values for X, Y, and Z). The first element is formed by points 1-2-4-5 and point 3 is ignored. In a similar manner, an element is formed by points 3-4-7-8 and point 6 is not used.

Contrails

Panel Identification Card (continued)

<u>Column Code</u>	<u>Routine Format</u>	<u>Explanation</u>
		Symmetry flag (continued) Note: Although it is possible to use different Symmetry flags for different components of a vehicle, the safe thing to do is to input or generate the geometry using the same Symmetry flag for all parts of a vehicle. This is particularly important if pictures are to be drawn with a computer graphics picture drawing program.
18 IFA(I)	GEOM I1	Scale factor flag. This flag permits the alteration of geometry data either by a shift of the reference coordinate system or by a multiplying factor. = 0 Use input geometry coordinates (no scale factors will be used). The Scale Factor Card will not be input. = 1 Use scale factors to scale and shift the geometry data in the basic coordinate system. Scale factors and coordinate increments are applied as the geometry data are being converted into quadrilateral data. The original element data on Unit IOU are not altered. i.e. $X_{\text{new}} = X_{\text{input}} \cdot (\text{XSC}) + \text{DELX}$ etc. for Y and Z Note: The Scale Factor Card is input after all of the Panel Identification Cards and geometry generation cards (for IELE, ELLIP, CUBIC, AIRCFT) are input, and are the last cards read before the quadrilaterals are calculated.
19-20 NADJ1	GEOM I2	The number of some other panel that is adjacent to side number 1 of this panel. The side numbering convention is the same as was used to identify the sides of a single element.
21-22 NADJ2	GEOM I2	The number of some other panel that is adjacent to side number 2 of this panel.
23-24 NADJ3	GEOM I2	The number of some other panel that is adjacent to side number 3 of this panel.
25-26 NADJ4	GEOM I2	The number of some other panel that is adjacent to side number 4 of this panel.

Contrails

Scale Factor Card (6F10.0)

This card is input only if IFA = 1. One Scale Factor Card is required for each Panel Identification Card that has IFA = 1. All of the required Scale Factor Cards are grouped together and input behind all of the geometry input or generation cards on each entry into the Geometry option. The Scale Factor Cards are read in one at a time as they are required (as specified by the IFA parameters on each Panel Identification Card). This read occurs in the cycle of the quadrilateral calculations and the scale factors are applied to the input geometry data as they are being converted into quadrilaterals. The original element data (Type 3 cards) stored on unit 8 is not affected by these scale factors as the scale factors are only used as the quadrilaterals are being generated. See Figure 3.

<u>Column Code</u>	<u>Routine Format</u>	<u>Explanation</u>
1-10 XSC	GEOM F10.0	X Scale Factor to be multiplied times X_{input} .
11-20 YSC	GEOM F10.0	Y Scale Factor to be multiplied times Y_{input} .
21-30 ZSC	GEOM F10.0	Z Scale Factor to be multiplied times Z_{input} .
31-40 DELX	GEOM F10.0	ΔX Scale - Increment to be added to X.
41-50 DELY	GEOM F10.0	ΔY Scale - Increment to be added to Y.
51-60 DELZ	GEOM F10.0	ΔZ Scale - Increment to be added to Z.

Contrails

INPUT TO THE ELEMENT READING ROUTINE (IELE)

This geometry option is used to transfer element data cards (Type 3 cards) from the input unit (usually 5 or the input monitor storage unit 1) to the geometry element data storage unit (8).

Element Control Card (2I2,2I1)

<u>Column Code</u>	<u>Routine Format</u>	<u>Explanation</u>
1-2 I3MAX	IELE I2	The number of STATUS 3's that will be read before the IELE routine will stop and return to the main geometry program.
3-4 IN	IELE I2	Input unit for the Type 3 cards. If input = 0 the program will set IN equal to TAPEIN as defined in the main executive program (= 1 or = 5).
5 IREW	IELE I1	Rewind flag for unit IN. The rewind control statement in IELE before the geometry read starts is as follows. IF (IN.NE.5 .AND. IREW.EQ.1) REWIND IN. = 0 Do not rewind unit IN. = 1 If IN \neq 5 rewind IN.
6 I3	IELE I1	Status 3 control flag. = 0 As the element cards are copied over to unit IOUT all of the STATUS 3's will be removed except the last one. = 1 All of the STATUS 3's will be removed as the cards are copied to unit IOUT.

Element data cards (Type 3 cards) are input following the above Element Control Card.

The important result of this general approach to the geometry problem is that the force-calculation part of the program is not affected by the method used to input the geometric shape. The form of the geometry data can be varied to meet the situation.

The coordinate system used for all the geometry data is shown in the figure below. For symmetrical vehicles it is standard practice to input the left side of the vehicle only.

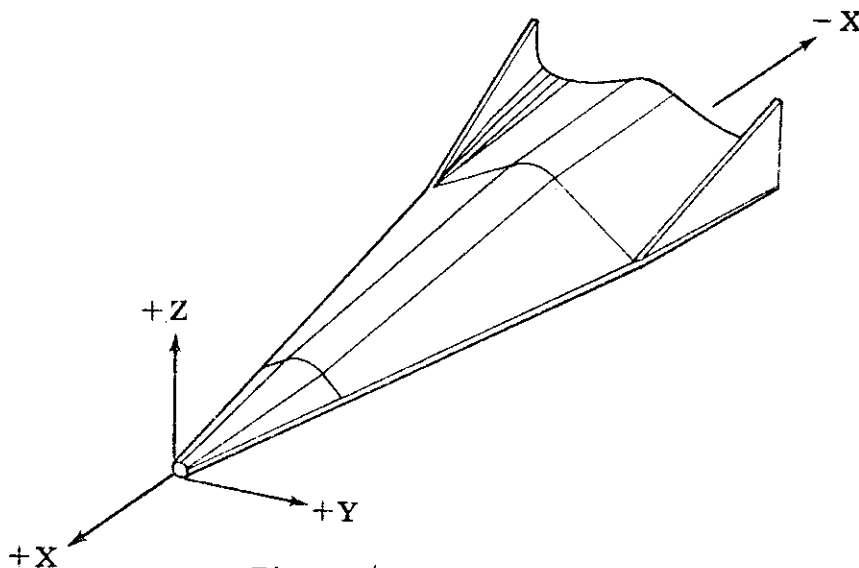

Figure 4. Input Geometry Coordinate System.

Since all of the geometry options finally produce geometry data in surface-element form, it is important that the methods and nomenclature used with this method be clearly understood. It is, therefore, recommended that the input instructions for the surface-element method be studied before an attempt is made to use either the ellipse or the parametric cubic options.

Under certain circumstances, the input geometry data must be input in a prescribed manner. This occurs when using the shock-expansion pressure-calculation method. A discussion of these problems is presented on pages 191 and 195.

Surface-Element Input Data (Distributed-Element Method)

The geometric input data in this method include the coordinates of a large number of points on the vehicle surface. The input data are organized in a manner that permits the description of a vehicle on a component-buildup basis. This gives increased flexibility in shape description and makes it possible

Contrails

to use different force-calculation methods for different components. Because of possible changes in the surface contours of a component, it may also be necessary to divide the component into several sections. Each section of a vehicle component is further divided into a number of small units called elements, each defined by four points in space. In practice, the surface coordinates are usually recorded from cross section drawings of the vehicle in such a way that each point need be read only once (even though it may be a member of as many as four adjacent elements). Each point is defined by its three coordinates and a STATUS flag that indicates whether it is the first point of a new section, a continuation of a column of points, the beginning of a new column, or the last point of the vehicle. The program uses the STATUS flags to determine how the input points are to be related to form elements, and how the elements are combined to form a section.

The first question that the user asks when starting to load the element geometry is, "In what order do I enter the surface points?" The basic rules to be followed are given below. These will be followed by a discussion of a visual technique that many users will find helpful in determining the proper loading order.

For the purpose of organizing the input data for computation, each point is assigned a pair of integers, m and n . These integers are not actually input to the program (they are calculated internally) but their use in the following discussion will provide a better understanding of the input-data organization. For each point, n identifies the "column" of points to which it belongs, and m identifies its position in the "column", i.e., the "row". The first point of a "column" always has $m = 1$. To ensure that the program will compute outward normal vectors, the following condition for the order of input points must be satisfied. If an observer is located in the flow and is oriented so that locally he sees points on the surface with m values increasing upward, he must also see n values increasing toward the right. Strict adherence to this simple rule will always lead to a correct set of input geometry data. Examples of correct and incorrect input are shown in the sketches below. In these pictures the flow field lies above the paper, and the interior of the body lies below the paper. The arrows indicate the order of reading the points.

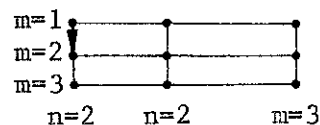
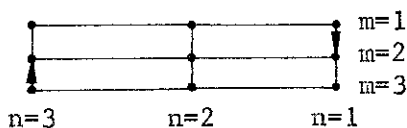
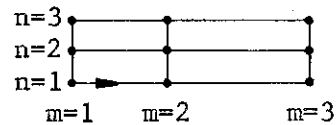
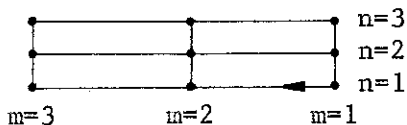
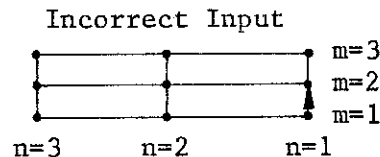
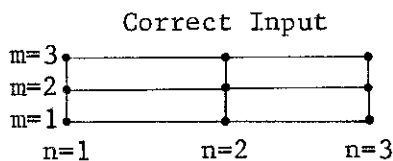

Contrails

Associated with each input point is an input quantity called its status. The first point of each new section has Status = 2. Except for the first n-line of a section, the first point of each n-line has Status 1. The last point of the component of the vehicle has Status 3. All other points have Status = 0, i.e., they may be left blank on the input sheet. The program will not exit properly from the surface-data subprogram and into the force-calculation phase until it reads a Status = 3.

The simple visual technique described below is helpful in determining the proper order of the input points.

1. First, assume that you are holding in your hand a small model of the vehicle shape. Many program users find it helpful to construct a small paper model to help in visualizing the geometry loading procedure. On this model we will draw lines to represent the elements to be loaded for a given vehicle section. This process is illustrated in the photographs in Figure 5.
2. Next, decide which strips of elements are to constitute "columns" and which "rows". In most problems one of two procedures is selected - either a "column" of elements starts at the bottom of the shape and continues around to the top, roughly following vehicle cross-section lines, or a "column" is oriented so that it starts at the front part of the vehicle and runs aft toward the rear.
3. Hold the model out in front of you and rotate it until the columns are vertical with the first row of elements at the bottom. This procedure should be used regardless of what part of the vehicle is being loaded - the body, fin, inside of fin, etc. Always orientate the model so that you are looking at the section to be loaded (from the outside, looking at the surface) with the columns running vertical and the rows running horizontal.
4. Now that you have the section being loaded oriented in front of you, with the columns vertical, apply the following cardinal geometry rule:

If a column of data points are loaded from the bottom to the top, then the next column of points (starting with a Status = 1) must be to the right.

All of the geometric input data for this geometry option are input on Type 3 Element Data cards. Each card contains the X, Y, Z coordinates and Status flag for two points on the body surface. Every card in the element-geometry deck must contain two surface points except the last card, which may have only the first-surface-point coordinates and status filled in. If a particular line of vehicle points is odd in number then it is usually advisable to repeat the last point (a dummy point) so that the last card will have two sets of point data. This permits the shifting of vehicle sections of the deck without disrupting other sections.

Contrails

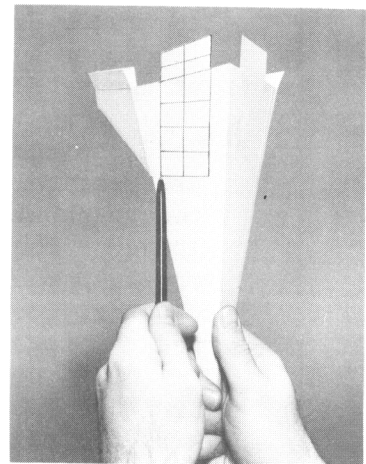
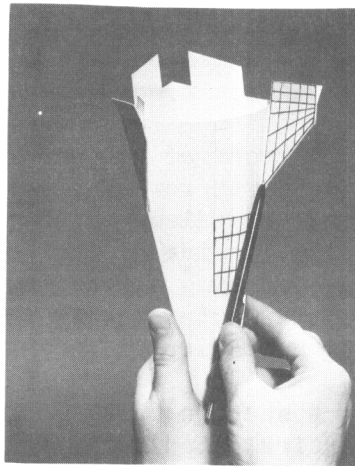
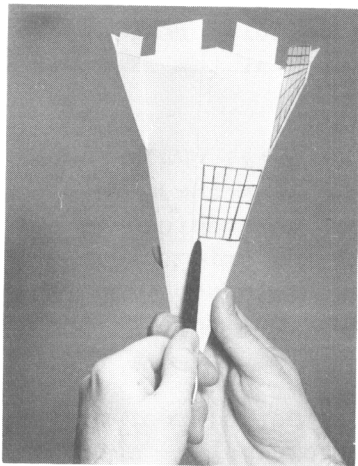
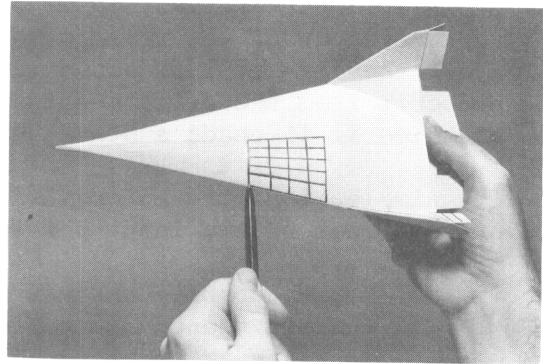
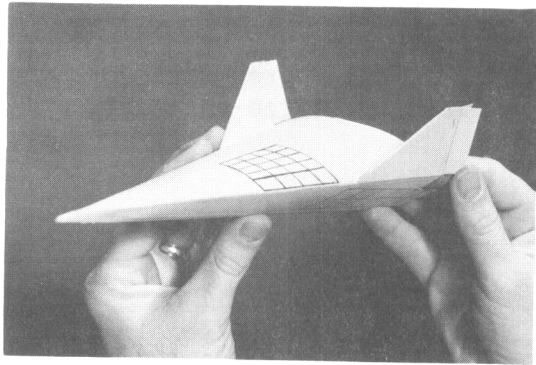

Figure 5. Use of Small Paper Model in Visualizing Geometry Loading Procedure. (In each example the pen is pointing at the first point to be loaded and in the direction of the first column of input points.)

Contrails

ELEMENT DATA INPUT CARDS (3F10.0,I1,3F10.0,I1,2X,I2,1A4,I2,4X,I4)

The detailed description of the input data for the surface-element method is presented below.

<u>Column Code</u>	<u>Routine Format</u>	<u>Explanation</u>
1-10 X	IELE F10.0	X-coordinate of surface point (the value of X is written anywhere in this space with a decimal point and sign; usually input only if it is negative).
11-20 Y	IELE F10.0	Y-coordinate of surface point.
21-30 Z	IELE F10.0	Z-coordinate of surface point.
31 STAT	IELE I1	Status flag for the above set of coordinates (= 2, 1, 0, or 3).
32-41 XX	IELE F10.0	X-coordinate of surface point.
42-51 YY	IELE F10.0	Y-coordinate of surface point.
52-61 ZZ	IELE F10.0	Z-coordinate of surface point.
62 STATT	IELE I1	Status flag for the above set of coordinates (= 2, 1, 0, or 3).
65-66 CASE	IELE I2	Case number (right-justified integer).
67-70 SECT	IELE 1A4	Numbers or letters to identify the vehicle section. These must be legal machine characters.
71-72 TYPE	IELE I2	Card type number =03.
77-80 SEQ	IELE I4	Card sequence number. This number is used to identify each card of a particular section and to aid in keeping the cards in order (right-justified integer).

A data load sheet for the above data is shown on the next page.

Contrails

ELLIPTICAL-CROSS-SECTION DATA

This geometry option provides the capability of generating geometric data for vehicle components having whole or partial circular or elliptical cross sections with a minimum amount of input information required. This option is usually used to generate hemispherical noses and wing and tail leading edges.

The data generated by this option is saved on the geometry storage tape (Tape 8) in normal surface-element input data form. In this manner it is possible to describe a vehicle with a combination of both hand-input data (in surface-element or parametric-cubic input form) and analytically derived circular or elliptical cross-section data.

The input data for this geometry option is described below. Input sheet 5 is used for these data. The input procedure is to define the basic properties of a circular or elliptical cross section (a cut in the Z-Y plane with X being a constant for the cross section). Each cross section where a set of element data is desired must be input in this manner. The first cross section must be toward the front of the vehicle, and each succeeding section must be toward the rear.

Ellipse Generation Control Card (12A4,11X,2I1,3XI2,1A4,I2)

Column Code	Routine Format	Explanation
1-48 TITLE	ELLIP 12A4	Vehicle section or component title. Any acceptable machine characters.
60 DISCON	ELLIP 11	Angular-data option flag. This flag controls the angular division of the cross section and the dummy points generated to give complete card output for the geometry storage tape. See sketch below.

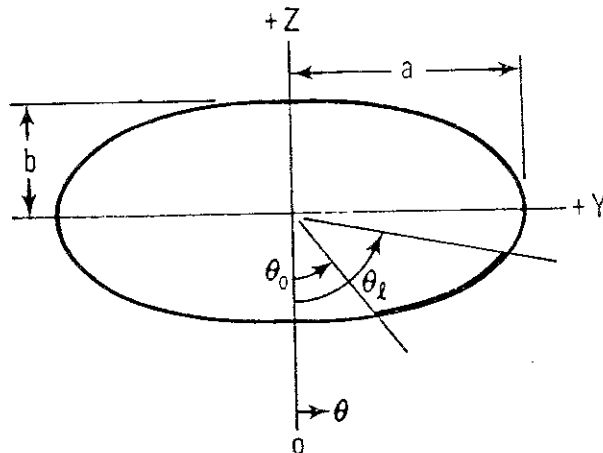

Contrails

Ellipse Generation Control Card (continued)

Column Code	Routine Format	Explanation
60 DISCON (continued)	ELLIP	The angular-data options are given below. = 1 All initial angles, θ_0 , and all final angles, θ_ℓ , are the same for each cross section for this section of the vehicle. = 2 All θ_ℓ in the vehicle section are the same but the θ_0 varies. = 3 All θ_0 in the vehicle section are the same but the θ_ℓ varies.
61 IPRINT	ELLIP I1	Print flag. This flag controls the printing of the element data generated in this option. This data printout will contain the exact information written on the geometry storage tape. = 0 Do not print data. = 1 Print.
65-66 CASE	ELLIP I2	Case number. A right-justified integer used to identify the vehicle data.
67-70 SECT	ELLIP IA4	Section identification. A number or letter used to identify this section or component of the vehicle. Any acceptable machine characters.
71-72 TYPE	ELLIP I2	Card Type number =04 (integer).
<u>Cross-Section Data Cards</u>		(F10.0,2F6.0,I3,2F10.0,2F7.0,I1,10X I2)
One card for each cross-section cut desired.		
1-10 X	ELLIP F10.0	X-station (usually negative if the vehicle nose is at the coordinate system origin).
11-16 THETO	ELLIP F6.0	Initial angle, θ_0 , Degrees.
17-22 THETL	F6.0	Final angle, θ_ℓ , Degrees.
23-25 NN	ELLIP I3	Number of divisions of cross section desired. This number controls the number and spacing of the elements generated between θ_0 and θ_ℓ . Right-justified integer.
26-35 A	ELLIP F10.0	Ellipse radius along the Y - axis, a.
36-45 B	F10.0	Ellipse radius along the Z - axis, b.
46-52 DELZ	F7.0	Offset of center of ellipse in the Z-direction, ΔZ .

Contrails

Cross-Section Data Cards (continued)

Column Code	Routine Format	Explanation
53-59 DELY	ELLIP F7.0	Offset of center of ellipse in the Y -direction. ΔY .

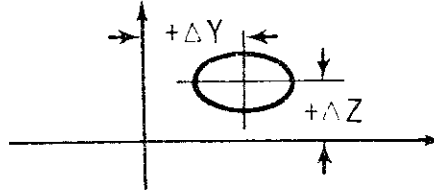

60	LAST	<p>Last Flag. This flag controls the Status flag (STAT) of the last element point generated and the position of the geometry data storage tape (Tape 8) after the element data has been written on it.</p> <ul style="list-style-type: none"> = 0 This is not the last cross section; set STAT = 0 and read in new cross-section card. = 1 Not active. Do not use. = 2 This is the last cross section for this vehicle section or component. Set the status flag STAT = 0, and read in a new ellipse data title card. = 3 Not active. Do not use. = 4 This is the last cross section; no more sections are given, set last STAT = 3, write end of file on geometry tape.
65-66	CASE	ELLIP I2 Case number (right-justified integer).
67-70	SECT	ELLIP 1A4 Numbers or letters to identify the vehicle panel. These must be legal machine characters.
71-72	ITYPE	ELLIP I2 Card type number = 05 (integer).
77-80		Card sequence number. Not read by program.

A data load sheet for the above data is shown on the next page.

PARAMETRIC-CUBIC INPUT DATA

The geometry-input option is provided as an alternate input method in the description of arbitrary shapes. In this respect, it serves the same purpose as the surface-element input method.

In the surface-element input method a vehicle section is described by a large number of surface points organized in an element fashion. In the Parametric Cubic method only points along the boundaries of a patch are input to the program and the distributed surface points (surface elements) required for the subsequent quadrilateral calculations are determined by the program.

The basic features of this method are that (1) fewer input points are required to describe a shape, (2) the input of this data is a little more complicated, and (3) the generated element size is controlled by two input parameters and may be changed to meet the requirements of the problem.

The input data for this option uses input data sheet 5. The input data consist of points along the four boundaries of a patch. The program calculates the coefficients for a mathematical surface-fit equation to provide a description of the interior surface of the patch. This surface is then converted into exactly the same form as the normal surface-element input data for further calculations. The element data generated is saved on the geometry storage tape (Tape 8) for use in other phases of the program.

Figure 6 illustrates how a section is described by this method.

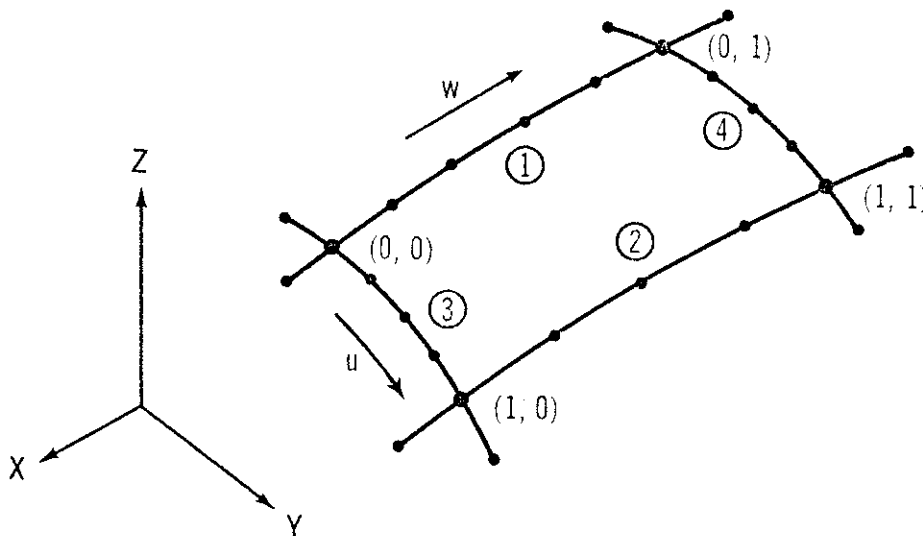

Figure 6. Parametric Cubic Patch Input.

Each of the four boundaries is identified in Figure 6 by a number inside a circle. The input data for each of these boundaries must be input in the order indicated by these numbers, i.e., boundaries 1, 2, 3, and 4. The order of the input points on a boundary and the order of the boundaries is important. The approach to ensure a correct input of the data is similar to that used for the quadrilateral-element input data. First, the user

Contrails

should imagine that he is holding a small model of the vehicle in hand. The vehicle is divided into a number of sections or patches. Figure 6 represents one such patch. The objective here is to describe how the data for one patch is loaded into the program.

The user orientates the model of the vehicle so that the number 1 boundary is to the left and the number 2 boundary to the right. Coordinates of points along the number 1 boundary are loaded first. The order of these points (from the user's view of the model) is from the bottom to the top of the patch. Note that a point must be included outside the patch at either end of the boundary to give proper slopes at the corner points. The next input points are for boundary number 2 and again from bottom to top. Boundary number 3 is loaded from left to right as is boundary number 4. A different number of points may be used to describe each boundary up to a maximum of 20 for each one.

Each of the input points has a status flag associated with it similar to that used in the surface-element input method. The first point (the bottom point outside the patch on boundary number 1) has a status of 2. The first point on each of the other boundaries has a status of 1. All the other points have a status of 0 except the last point (the point on the right side outside the patch on boundary 4) which has a status of 3.

The input sheet contains two points per card. Every card must contain two points except the last which may have one point (loaded on the left side of the card).

The detailed input information required for this geometry-method option is presented below.

Parametric Cubic Title Card (12A4,1X,I3,1X,I3,3X,3I1,2XI2,1A4,I2)

This card contains patch control data and divisions to be used in converting the patch to element data. See sheet 5.

<u>Column Code</u>	<u>Routine Format</u>	<u>Explanation</u>
1-48 TITLE	CUBIC 12A4	Section or patch title. Any acceptable machine characters.
50-52 NOU	CUBIC I3	Number of division of the parametric variable u. This controls the number of elements in the element mesh in the u-direction (right-justified integer).
54-56 NOW	CUBIC I3	Number of divisions of the parametric variable w. This controls the number of elements in the element mesh in the w-direction (right-justified integer). If this number is an even number then the program will change it to the next higher odd number so that there will always be an odd number of elements in a column. This will give an even number of points in a column to fill out both the left and right sides of the element data card.

Contrails

Parametric Cubic Title Card (Continued)

Column Code	Routine Format	Explanation
60 LAST	CUBIC I1	<p>Last Flag. This flag controls the Status flag (STAT) of the last element point generated and the position of the geometry data storage tape (Tape 8) after all data has been written on it.</p> <p>= 1 Not active. Do not use.</p> <p>= 2 This is not the last patch. Set the last-point status flag STAT = 0, and read in a new set of patch data (including a new title card).</p> <p>= 3 Not active. Do not use.</p> <p>= 4 This is the last patch. Set the last-point status to STAT = 3, write an end of file on unit IOUT.</p>
61 ISOVR	CUBIC I1	<p>First-point status override flag.</p> <p>= 0 The status flag for the first coordinate point of the patch will be = 2 (normal mode).</p> <p>= 1 The status flag for the first coordinate point of the patch will be set = 1. This will permit "joining together" several parametric cubic patches to form a single section of surface-element data.</p>
62 IPRINT	CUBIC I1	<p>Print flag. This flag controls the printing of the element data generated in this option. This data printout will contain the exact information written on the geometry storage tape (in BCD card image form).</p> <p>= 0 Do not print data.</p> <p>= 1 Print.</p>
65-66 CASE	CUBIC I2	Case number (right-justified integer).
67-70 SECT	CUBIC 1A4	Numbers or letters to identify the vehicle panel.
71-72 ITYPE	CUBIC I2	Card type number = 06.

Contrails

Parametric Cubic Boundary Data (3F10.4,I1,3F10.4,I1,8X,I2)

This card contains the coordinates of the boundary curves for a parametric cubic patch. See sheet 5.

<u>Column Code</u>	<u>Routine Format</u>	<u>Explanation</u>
1-10 X	CUBIC F10.4	X-coordinate of boundary curve point.
11-20 Y	CUBIC F10.4	Y-coordinate of boundary curve point.
21-30 Z	CUBIC F10.4	Z-coordinate of boundary curve point.
31 STAT	CUBIC I1	Status flag for the above set of coordinates (= 2, 1, 0, or 3). This flag controls the reading in of the boundary curve data and is not the same as the STATUS flag that will be generated and written on the geometry storage tape along with the generated surface element data.
32-41 XX	CUBIC F10.4	X-coordinate of boundary curve point.
42-51 YY	CUBIC F10.4	Y-coordinate of boundary curve point.
52-61 ZZ	CUBIC F10.4	Z-coordinate of boundary curve point.
62 STATT	I1	Status flag for the above set of coordinates (= 2, 1, 0, or 3). This flag controls the reading in of the boundary curve data and is not the same as the STATUS flag that will be generated and written on the geometry storage tape along with the generated surface element data.
65-66 CASE		Case number. Not read by program.
67-70 SECT		Numbers or letters to identify the vehicle panel. Not read by program.
71-72 ITYPE	CUBIC I2	Card type number = 07.
77-80 SEQ		Card sequence number. Not read by program.

A data load sheet for the above data is shown on the next page.

AIRCRAFT GEOMETRY OPTION

The Aircraft Geometry Option has the capability of generating element data for six classes of aircraft surfaces. These are identified as follows.

1. Wings

Airfoil ordinates are input at percent-chord locations along with the X, Y, Z coordinates of each airfoil leading edge. Wing camber data and chord lengths are also input.

2. Fuselage

A fuselage may be defined in segments and may be circular or arbitrary in cross section. If the fuselage is circular it may be input by a cross-sectional area distribution. If the fuselage is arbitrary it may be input as X-Y-Z cross-sectional coordinate data. Up to four fuselage segments may be specified on each entry into the Aircraft Geometry Option.

3. Pods or Nacelles

The X-Y-Z coordinates of the pod origin are input along with a pod radii distribution. Up to nine pods may be specified on each entry to the Aircraft Geometry Option.

4. Fins

The X-Y-Z coordinates of the lower and upper airfoil leading edge of vertical fins are input along with airfoil ordinates at up to ten percent-chord locations. The chord lengths are also input. As many as six fins may be used on each entry to the Aircraft Geometry Option. Only symmetrical airfoils are generated.

5. Canards or Horizontal Tails

The X-Y-Z coordinates of the inboard and outboard airfoil leading edge are input along with the airfoil ordinates and chord lengths. Up to two canards may be input on each entry to the Aircraft Geometry Option. Unsymmetrical airfoils are permitted.

6. General Airfoil Surface

The orientation of each airfoil is specified by X-Y-Z coordinates of the leading and trailing edges and a rotation angle. The airfoil ordinates and camber data are also input. This permits the description of wing or tail type of surfaces where the airfoils are not orientated in a fixed streamwise plane.

Contrails

The first five classes of surfaces indicated above are the same as those available in the NASA Wave Drag program. The sixth surface is a new feature provided within the Arbitrary-Body Program that allows the geometric description of a surface composed of airfoil sections that may be arbitrarily orientated in space. This removes some of the restrictions imposed within the wing, fin, and canard options used in the NASA Wave Drag program. Also, additional parameters may be specified on the pod input data to allow arbitrary orientation of the pods or nacelles.

Various combinations of the above shapes may be used in describing most aircraft configurations. However, in some situations a part of a vehicle may not be accurately described by one of the above components. In this case, the particular part of the vehicle may be input or generated using the completely arbitrary shape capabilities in the other parts of the program (i.e., input elements, parametric cubic patches, etc.). For other problems it may be easiest to generate the vehicle using the Aircraft Geometry Option and then alter those cards that need changes by hand in order to give an accurate representation of the shape. This may be necessary to accurately describe such regions as wing roots, fillets, etc.

Note that in the description of each of the surfaces above certain restrictions exist as to the maximum number of fuselage segments, pods, fins, etc., that may be generated on a single entry into the Aircraft Geometry Option. It should be noted, however, that all such limitations may be overcome by entering the Aircraft Geometry Option as many times as may be required.

The output data for the Aircraft Geometry Option consist of element data cards with two coordinate points and accompanying Status flags recorded on each card (Type 3 Arbitrary-Body Program cards). These cards are written on the Geometry Storage Unit (Unit 8) for use by the rest of the Arbitrary-Body program. The card decks generated in this manner may be used directly as input data for subsequent runs on the Hypersonic Arbitrary-Body Program, or as input to the Douglas Arbitrary-Body Supersonic Wave Drag Program and the Douglas Potential Flow Program (the Neumann Program). These same element cards may be used to generate pictures using on-line interactive graphics programs, and in programs that use large electro-mechanical drafting devices such as the Orthomat and Gerber Plotters.

Some users may make use of the Aircraft Geometry Option and the Arbitrary-Body Program picture drawing capabilities as a tool in validating geometry data for the NASA Wave Drag Program (the Harris Program). For such applications, however, care should be taken to verify that the input data for the users' version of the NASA program is the same as required by the Aircraft Geometry Option of the Hypersonic Arbitrary-Body Program. Note that the sixth surface type provided in the Aircraft Geometry Option (arbitrary-airfoil orientation) is not available for use on the NASA Wave Drag Program. Since all programs tend to change with time it may be necessary for the user to make modifications to the Aircraft Geometry Option to maintain consistency in input data with the NASA Wave Drag Program.

Users of the Aircraft Geometry Option should exercise care in selecting input parameters to assure that the resulting surface element data will meet the needs of their problem. This rather obvious statement is necessary because of the multifunction uses that this option serves.

Contrails

The various methods within the Aircraft Geometry Program are selected by input flags on a control card. The various parameters, tables, etc., for each aircraft component are given on a separate set of cards for each type of surface. The order and identification of each of the input cards is given in the list below. Each card, if it is to be used, must be in the order indicated.

<u>Card or Card Set Number</u>	<u>Card Identification</u>
1	Title and Identification Card
2	Control Flag Card
3	Wing Area Card (if required)
4	Wing Percent-Chord Location Card(s)
5	Airfoil Leading Edge Coordinate Card(s)
6	Wing Camber Line Card(s) (for each airfoil, if required)
7	Wing Airfoil Ordinate Card(s) (for each airfoil)
8	Fuselage X-Station Card(s) (for first segment)
9	Fuselage Camber Card(s) (if required)
10	Fuselage Cross-Section Area Card(s) (if required)
11	Fuselage Y-Ordinates (for arbitrary shape) (if required)
12	Fuselage Z-Ordinates (for arbitrary shape) (if required)
13	Repeat 11 and 12 for all cross sections of segment.
14	Repeat 8 through 13 for all fuselage segments.
15	Pod Origin Card
16	Pod X-Station Card(s)
17	Pod Radii Card(s)
18	Repeat 15 through 17 for all pods.
19	Fin Leading Edge Coordinate Card
20	Fin Percent-Chord Location Card
21	Fin Airfoil Ordinate Card
22	Repeat 19 through 21 for all fins.

Contrails

<u>Card or Card Set Number</u>	<u>Card Identification</u>
23	Canard Leading Edge Coordinate Card
24	Canard Percent-Chord Location Card
25	Canard Upper Ordinate Card
26	Canard Lower Ordinate Card (if required)
27	Repeat 23 through 26 for all canards
28	General Airfoil Surface Control Flag Card
29	Airfoil Percent-Chord Location Card(s)
30	Airfoil Orientation Card(s)
31	Airfoil Camber Line Card(s)
32	Airfoil Ordinate-Thickness Card(s)
33	Repeat 28 through 32 for multiple airfoil surfaces as required.
34	Repeat 1 through 33 for multiple configurations as required.
35	Type 99 card (Normal Return to Executive Program).

The detailed descriptions given on the following pages include all input cards and parameters. Where it might be useful the mnemonics used in the program are also given. On some of the cards identification information is punched in card columns 73-80. Although this information is not used by the program its use may help to eliminate errors in card order. The card field to be used for input numbers is indicated for each card. All integers should be punched in the right most column of the field. Real numbers may be punched anywhere in the field specified. Except for the integers on the Control Flag Card, all other input is in the form of real numbers with the decimal point and sign punched on the card (i.e., -59.56).

The type 99 card contains a 99 in card columns 71 and 72. The remainder of the card has the same format as the Title and Identification Card (card 1), however these remaining fields are usually left blank.

A chart showing the data flow logic for the Aircraft Geometry Option is presented in Figure 7.

Contrails

AIRCRAFT GEOMETRY IDENTIFICATION AND CONTROL

<u>Column Code</u>	<u>Routine Format</u>	<u>Explanation</u>
<u>Title and Identification Card</u> (9A3,8A4,I1,2X,I1, 2X,A3,2X ,A2,2A4) <i>(X I 2,4 X)</i>		
1-59 CARD	AIRCFT 9A3, 8A4	The title that is to appear at the top of the output pages. Any acceptable machine characters.
60 ISTAT3	AIRCFT I1	Flag to control the generation of a dummy element with a very small surface area in order to introduce a Status = 3 at the appropriate in a geometry deck. = 0 Dummy element will be included at the very end of the Type 3 cards produced in the Aircraft Geometry Option. This means that the last Type 3 card will have a Status 3 flag. = 1 No dummy Status 3 element will be generated. The last data point in the Aircraft Geometry cards produced will have a Status = 0.
63 IHARIS	AIRCFT I1	NASA-Harris Input Coordinate Flag. = 0 Arbitrary-Body Program coordinates will be used. The usual practice is to have the nose of the vehicle at the origin of the coordinate system with the tail having a negative X-station. = 1 The NASA Harris coordinate system will be used. The vehicle nose is at the origin and all the X-coordinates are positive for the input data on the Aircraft Geometry Data cards. The program will change them to negative values before the final Type 3 cards are written on the storage unit to be consistent with the Arbitrary-Body system.
65-66 66-68 CASE	AIRCFT A3I2	Case number to be printed at the top of data output pages and in card columns 66-68 ⁶⁵⁻⁶⁶ on the Type 3 cards produced by the Aircraft Geometry Option.
71-72 TYPE	AIRCFT A2	Case termination flag. If input = 99 the Aircraft Geometry Option will stop with this card and return to the Geometry routine. If left blank the program will continue reading in Aircraft Geometry data cards.

Contrails

Control Flag Card (7I3,I1,I2,16I3,8X)

Column Code	Routine Format	Explanation
1-3 J0	AIRCFT I3	Wing area flag. = 0 Wing area card is not included. = 1 Wing area card is to be read.
4-6 J1	AIRCFT I3	Wing data and camber flag. = 0 No wing data are used. = 1 Cambered wing data are to be read. = -1 Uncambered wing data are to be read.
7-9 J2	AIRCFT I3	Fuselage control flag. = 0 No fuselage data are used. = 1 Data for arbitrarily shaped fuselage will be read. = -1 Data for circular fuselage will be read.
10-12 J3	AIRCFT I3	Pod control flag. = 0 No pod data are used. = 1 Pod data are to be read.
13-15 J4	AIRCFT I3	Fin control flag. = 0 No fin data are used. = 1 Fin data are to be read.
16-18 J5	AIRCFT I3	Canard control flag. = 0 No canard data are used. = 1 Canard data are to be read.
19-21 J6	AIRCFT I3	Fuselage camber and symmetry flag. = 0 Fuselage camber data will be read. = 1 Configuration is symmetrical with respect to the X-Y plane (uncambered circular fuselage is used). = -1 Fuselage is uncambered. = 2 Uncambered, arbitrary fuselage.
22 J7	AIRCFT I1	General airfoil surface flag. = 0 No airfoil data are used. = 1 General airfoil surface control card to be read.
23-24 NWAFF	AIRCFT I2	Number of airfoils used to describe the wing = 2 to 20.
25-27 NWAFFOR	AIRCFT I3	Number of percent-chord points used to define each wing airfoil section. = 3 to 30.
28-30 NFUS	AIRCFT I3	The number of fuselage segments to be read. = 1 to 4.
31-33 NRADX(1)	AIRCFT I3	Number of Y-Z coordinate points used to describe each cross section for the first fuselage segment. This parameter is used for both arbitrary and circular fuselage segments. = 3 to 30.

Contrails

IDENTIFICATION AND CONTROL (continued)

Control Flag Card (continued)

<u>Column Code</u>	<u>Routine Format</u>	<u>Explanation</u>
34-36 NFORX(1)	AIRCFT I3	Number of X cross sections to be used for each fuselage segment. = 2 to 30.
37-39 NRADX(2)	AIRCFT I3	Same as Field 31-33 for second fuselage segment.
40-42 NFORX(2)	AIRCFT I3	Same as Field 34-36 for second fuselage segment.
43-45 NRADX(3)	AIRCFT I3	Same as Field 31-33 for third fuselage segment.
46-48 NFORX(3)	AIRCFT I3	Same as Field 34-36 for third fuselage segment.
49-51 NRADX(4)	AIRCFT I3	Same as Field 31-33 for fourth fuselage segment.
52-54 NFORX(4)	AIRCFT I3	Same as Field 34-36 for fourth fuselage segment.
55-57 NP	AIRCFT I3	Number of pods to be input (up to 9).
58-60 NPODOR	AIRCFT I3	Number of stations to be used in the pod radii distribution input. This is the same for all pods. = 2 to 30.
61-63 NF	AIRCFT I3	Number of vertical fins to be input (up to 6).
64-66 NFINOR	AIRCFT I3	Number of ordinates used to define each fin airfoil. This is the same for all fins. = 3 to 10.
67-69 NCAN	AIRCFT I3	Number of canards or horizontal tails to be input (up to 2).
70-72 NCANOR	AIRCFT I3	Number of ordinates used to define the airfoils. This is the same for all canards. = 3 to 10 Airfoil is symmetrical, upper ordinates only will be read. = -3 to -10 Airfoil is unsymmetrical, lower ordinates will be read right after the upper values are read in.

Wing Area Card

(F7.2)

1-7 REFA

AIRCFT
F7.2

This card is required if JO = 1 on the Control Flag Card. This parameter is not used by the program but may be present in some decks set up for the NASA Wave Drag Program. If JO = 0 on the Control Flag Card then the Wing Area Card is not included in the deck.

Contrails

WINGS

The input information required by the Aircraft Geometry Option to define a wing with streamwise airfoils is as follows:

1. Number of airfoils.
2. Number of airfoil percent-chord points used to define the airfoils.
3. A table of percent-chord locations that are to be used for the airfoil thickness and camber distributions.
4. The X-Y-Z coordinates of the leading edge of each airfoil.
5. The chord length of each airfoil.
6. The airfoil ordinate data in percent of chord length at each percent-chord position for each airfoil.
7. A flag to indicate when camber data are to be read in or set equal to zero.
8. Camber values of the mean camber line (ΔZ) at each percent-chord location for each airfoil.

The input information required to describe a wing is illustrated in Figure 8.

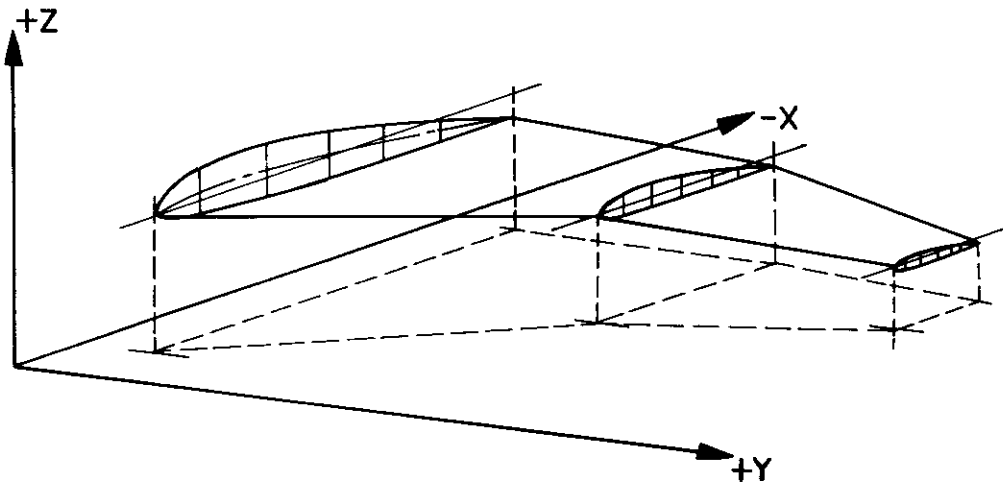

Figure 8. Wing with Streamwise Airfoils.

Contrails

Note that each airfoil lies in an X-Z plane at a fixed spanwise station, Y. This will pose problems in some applications at the wing-fuselage juncture, particularly for area-ruled fuselages.

The Z-coordinates of each surface point are calculated from the following relationship.

$$Z = Z_0 + DZ * C * WAFORD(I,J) + TZORD(I,J).$$

where

Z = final Z-coordinate of a point on the airfoil.

DZ = upper surface - lower surface factor.
= +1.0 for upper surface.
= -1.0 for lower surface.

C = chord length/100.0

WAFORD = upper airfoil thickness in percent of chord length
subscript I = the airfoil number (=1 for the inboard airfoil)
subscript J = the number of chordwise location.

TZORD = camber, ΔZ .

Z₀ = Z-coordinate of the airfoil leading edge point.

The order of the generated X-Y-Z surface points is shown in Figure 9a for the upper surface of the wing. The wing lower surface is shown in Figure 9b.

In the wing shown in Figure 9 there were seven percent-chord locations from the leading edge to the trailing edge. Since each element data card generated (Type 3 card) contains two data points, three and one-half cards will be required for the root upper surface. Rather than beginning the next wing chord on the last half of the third card, this field is filled by a dummy point (point 8) which is a repeat of the trailing edge point (point 7). This dummy point is furnished automatically by the program when it is required and permits each airfoil to be started on a new card. This facilitates the manual manipulation of resulting data decks to meet various needs.

The wing lower surface is considered as a new vehicle section. To obtain the correct "outward" side of the surface the generation of points starts at the tip rather than the root as was done for the upper surface. Dummy trailing edge points are generated just as was done for the upper surface. In the example shown, point 1 will have a Status flag of 2, points 9 and 17 will have Status = 1, and all the rest will have Status = 0.

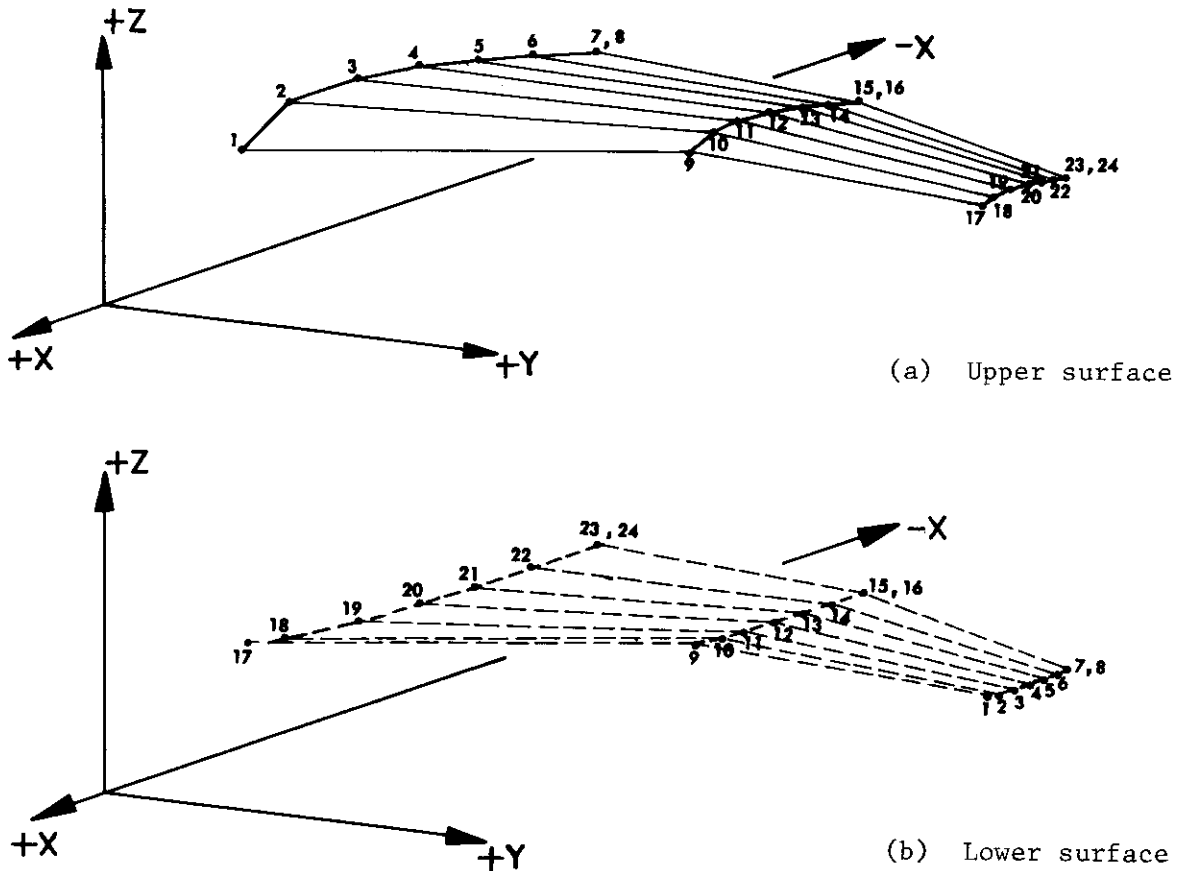

Figure 9. Points and Elements Generated for Wing Surface.

Note that a surface point is calculated at each input percent-chord location for each airfoil. The number of percent-chord locations and the number of airfoils will determine the number of surface points generated and the number of resulting surface elements. In the example shown in Figure 9 a total of 28 elements were generated (including 4 that result from the dummy trailing edge points).

Contrails

WING DATA CARDS

Wing Percent-Chord Location Card(s) (10F7.0,10X)

<u>Column Code</u>	<u>Routine</u>	<u>Explanation</u>
	<u>Format</u>	
1-7 XAF(1)	AIRCFT	Table of percent-chord locations that are to be used for the airfoil thickness and camber coordinates. Use as many cards as required with 10 numbers on each card. Use as many fields and cards as is specified by NWAFOR (Field 25-27) on the Control Flag Card.
8-14 XAF(2)	10F7.0	
15-21 XAF(3)		
22-28 XAF(4)		
29-35 XAF(5)		
36-42 XAF(6)		
43-49 XAF(7)		
etc. etc.		

Airfoil Leading Edge Coordinate Cards (4F7.0,52X)

1-7 WAFORG(I,1)	AIRCFT	X-coordinate of the airfoil leading edge.
8-14 WAFORG(I,2)	4F7.0	Y-coordinate of the airfoil leading edge.
15-21 WAFORG(I,3)		Z-coordinate of the airfoil leading edge.
22-28 WAFORG(I,4)		The airfoil streamwise chord length.
73-80		May be punched WAFORG _i , where i denotes the airfoil number.

Note: Repeat this card for all airfoils, starting with the inboard airfoil and working to the outboard tip airfoil. The number of these cards is given by the parameter NWAFF (Field 23-24) on the Control Flag Card and must not be greater than 20.

Wing Camber Line Cards (10F7.0,10X)

Not required if J1 = -1 on the Control Flag Card.

1-7 TZORD(J,1)	AIRCFT	Camber values of the mean camber line (ΔZ) at each percent-chord location for each airfoil. Use as many cards as required with 10 numbers on each card. Each airfoil must have as many numbers as was specified by the parameter NWAFOR in field 25-27 on the Control Flag Card. There will be as many sets of these cards as was indicated by the parameter NWAFF in field 23-24 on the Control Flag Card. The first number for each airfoil should start on a new card. The identification TZORD _j may be punched in card columns 73-80, where j denotes the airfoil number.
8-14 TZORD(J,2)	10F7.0	
15-21 TZORD(J,3)		
22-28 TZORD(J,4)		
29-35 TZORD(J,5)		
36-42 TZORD(J,6)		
43-49 TZORD(J,7)		
50-56 TZORD(J,8)		
57-63 TZORD(J,9)		
64-70 TZORD(J,10)		
1-7 TZORD(J,11)		
etc. etc.		

Contrails

WING DATA CARDS (continued)

Wing Airfoil Ordinate Cards (10F7.0,10X)

<u>Column Code</u>	<u>Routine Format</u>	<u>Explanation</u>
1-7 WAFORD(J,1)	AIRCFT	Wing airfoil thickness ordinates as a percent of chord length at each percent-chord ordinate position for each airfoil. Use as many cards as required with 10 numbers on each card. Each airfoil must have as many numbers as was specified by the parameter NWAFOR in field 25-27 on the Control Flag Card. There will be as many sets of these cards as was indicated by the parameter NWAF in field 23-24 of the Control Flag Card. The first number for each airfoil should start on a new card. The identification WAFORDj may be punched in card columns 73-80, where j denotes the airfoil number.
8-14 WAFORD(J,2)	10F7.0	
15-21 WAFORD(J,3)		
22-28 WAFORD(J,4)		
29-35 WAFORD(J,5)		
36-42 WAFORD(J,6)		
43-49 WAFORD(J,7)		
50-56 WAFORD(J,8)		
57-63 WAFORD(J,9)		
64-70 WAFORD(J,10)		
1-7 WAFORD(J,11)		
etc. etc.		

FUSELAGE

The input information required by the Aircraft Geometry Option to define a fuselage is as follows:

1. Fuselage shape flags (circular, arbitrary, cambered).
2. Number of fuselage segments (1 to 4).
3. Number of Y-Z coordinate points used to describe an X-cross section for each fuselage segment (3 to 30).
4. Number of X cross sections to be used for each fuselage segment (2 to 30).
5. A table of X-values of the fuselage cross sections for each fuselage segment.
6. Tables of Y-Z values to describe each cross section for arbitrary shaped fuselage.
7. Fuselage centerline camber distribution.
8. Cross-sectional area distribution of the fuselage if it is circular.

From the above input items we see that the fuselage may be circular or arbitrary in cross section, may have camber, and may be made up of as many as four segments. However, a single fuselage cannot be made up to a combination of circular and arbitrary cross sections. (This comment only applied for a single pass into the Aircraft Geometry Option. Multiple entries into the Aircraft Geometry Option from the Hypersonic Arbitrary-Body executive main program permits an unlimited combination of program capabilities.)

The order of the generated fuselage coordinate points is from the bottom around to the top. The first point for each fuselage segment has a Status flag of 2, each new cross section starts with a Status of 1, and all the other points have Status = 0. If the last point for a cross-section fills only the left half of the Type 3 element data card, a dummy point is generated to fill the right field of the card. Figure 10 shows the order of the generated surface points for an arbitrarily shaped fuselage. Only two fuselage segments are shown.

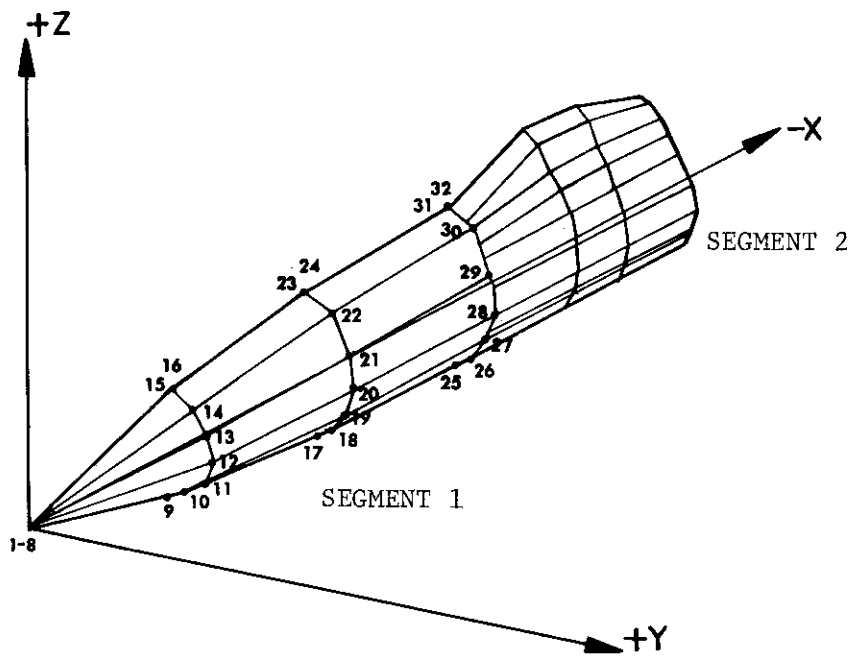

Figure 10. Fuselage Geometry Generation

FUSELAGE DATA CARDS

Fuselage X-Station Card(s) (10F7.0,10X)

Column Code	Routine Format	Explanation
1-7 XFUS(I,1)	AIRCFT	Table of X-station values to be used for first fuselage segment. Use as many cards as required with 10 numbers on each card. The number of cross sections used must be the same as indicated by the parameter NFORX on the Control Flag Card. The X-stations must be in an order proceeding from the front of the vehicle to the rear.
8-14 XFUS(I,2)	10F7.0	
15-21 XFUS(I,3)		
22-28 XFUS(I,4)		
29-35 XFUS(I,5)		
36-42 XFUS(I,6)		
43-49 XFUS(I,7)		
50-56 XFUS(I,8)		
57-63 XFUS(I,9)		
64-70 XFUS(I,10)		
1-7 XFUS(I,11)		
etc. etc.		

Fuselage Chamber Card(s) (10F7.0,10X)

Required only if J6 = 0 on the Control Flag Card

1-7 ZFUS(I,1)	AIRCFT	Fuselage camber distribution for first fuselage segment. Use as many cards as required with 10 numbers on each card. The number of camber points used must be the same as indicated by the parameter NFORX on the Control Flag Card. For an arbitrarily shaped fuselage this parameter will not actually be used in generating the surface coordinate points. However, if the parameter J6 = 0 on the Control Flag Card, then the appropriate number of fuselage camber cards must be present in the deck (all the values may be = 0.0). The identification ZFUSj may be punched in card columns 73-80, where j denotes the number of the last fuselage station given on that card.
8-14 ZFUS(I,2)	10F7.0	
15-21 ZFUS(I,3)		
22-28 ZFUS(I,4)		
29-35 ZFUS(I,5)		
36-42 ZFUS(I,6)		
43-49 ZFUS(I,7)		
50-56 ZFUS(I,8)		
57-63 ZFUS(I,9)		
64-70 ZFUS(I,10)		
1-7 ZFUS(I,11)		
etc. etc.		

Fuselage Cross-Section Area Card(s) (10F7.0,10X)

Not required if the fuselage is arbitrary in shape (if J2 = 1)

1-7 FUSARD(I,1)	AIRCFT	A table of fuselage cross-sectional area distribution at each station for the first fuselage segment. Use as many cards as required with 10 numbers on each card. The number of points used must be as indicated by the parameter NFORX on the Control Flag Card. The identification FUSARDj may be punched in card columns 73-80, where j denotes the station number.
8-14 FUSARD(I,2)	10F7.0	
15-21 FUSARD(I,3)		
22-28 FUSARD(I,4)		
29-35 FUSARD(I,5)		
etc. etc.		

Contrails

FUSELAGE DATA CARDS (continued)

Fuselage Y-Ordinate Card(s) (10F7.0,10X)

Used for arbitrarily shaped fuselage only. Do not use these cards unless J2 = 1 on the Control Flag Card.

Column Code	Routine Format	Explanation
1-7 YFUSY(I,J,1)	AIRCFT	Y-ordinates for one fuselage cross section, starting at the bottom and going around to the top of the section. Use as many cards as required with 10 numbers on each card. The parameter NRADX on the Control Flag Card specifies the number of Y-ordinates required for each cross section. Each set of Y-ordinate cards are followed immediately by a Z-ordinate set of cards for that same cross section. The number of ordinates may range from 3 to 30.
8-14 YFUSY(I,J,2)	10F7.0	
15-21 YFUSY(I,J,3)		
22-28 YFUSY(I,J,4)		
29-35 YFUSY(I,J,5)		
36-42 YFUSY(I,J,6)		
43-49 YFUSY(I,J,7)		
etc. etc.		

Fuselage Z-Ordinate Card(s) (10F7.0,10X)

Used for arbitrarily shaped fuselage only. Do not use these cards unless J2 = 1 on the Control Flag Card.

1-7 ZFUSZ(I,J,1)	AIRCFT	Z-ordinates for one fuselage cross section, starting at the bottom and going around to the top of the section. These Z-ordinates correspond to the Y-ordinates input on the Y-ordinate card described above. Use as many cards as required with 10 numbers on each card. The parameter NRADX on the Control Flag Card specifies the number of Z-ordinates required for each cross section. Each set of Z-ordinate cards must be right behind the corresponding set of Y-ordinate cards.
8-14 ZFUSZ(I,J,2)	10F7.0	
15-21 ZFUSZ(I,J,3)		
22-28 ZFUSZ(I,J,4)		
29-35 ZFUSZ(I,J,5)		
36-42 ZFUSZ(I,J,6)		
43-49 ZFUSZ(I,J,7)		
50-56 ZFUSZ(I,J,8)		
57-63 ZFUSZ(I,j)		
etc. etc.		

Note: Paired sets of Y-ordinate and Z-ordinate cards are repeated for each fuselage cross section until all cross sections for a single fuselage segment are read in. The number of paired sets is given by the parameter NFORX input on the Control Flag Card.

The order of cards for the second fuselage segment is the same as prepared for the first segment. This includes fuselage station, camber, cross-section area, and Y-Z ordinates for each fuselage segment.

PODS OR NACELLES

A pod or nacelle is a body of revolution with its axis arbitrarily located with reference to the vehicle axis system. This increased capability has been added without effecting the NASA Wave Drag Program input format (the NASA program is limited to having the pod axis parallel to the vehicle X-axis). The pod is defined with respect to its own coordinate system ($X'-Y'-Z'$), the orientation of which is considered to have been achieved through a yaw-pitch sequence of rotations. The parameters used in defining the pod and the formation of surface elements are illustrated in Figure 11.

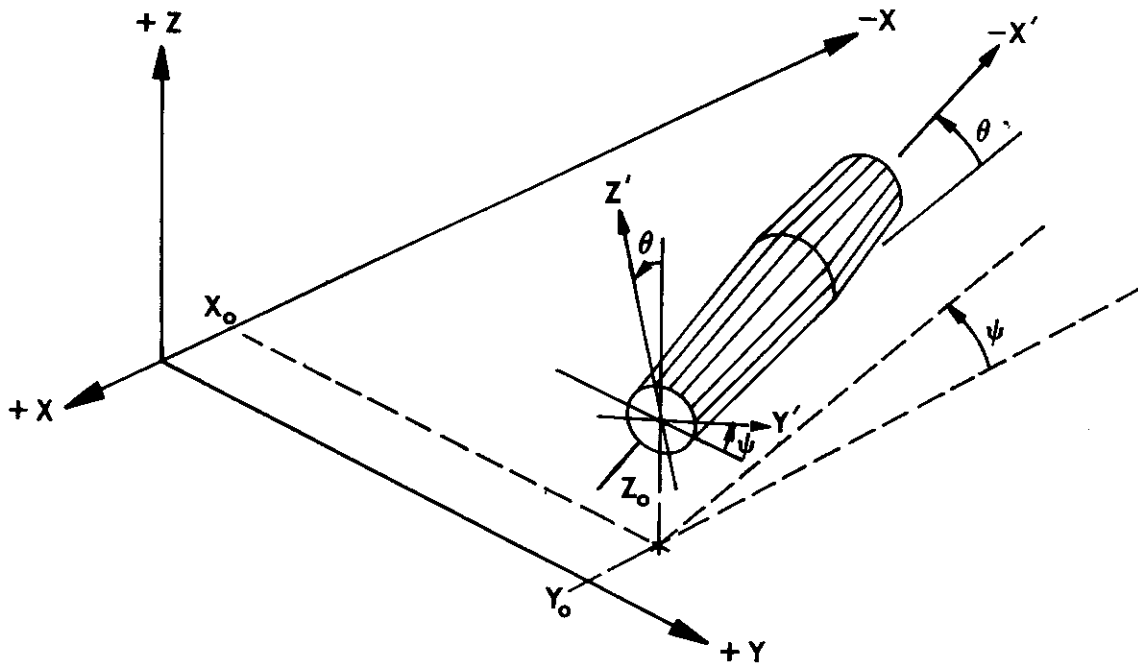

Figure 11. Pod or Nacelle Geometry.

The input information required to define a pod or nacelle is as follows:

1. Number of pods (up to 9).
2. Number of stations to be used in the pod radii distribution input (2 to 30). This is the same for all pods.
3. The X-Y-Z coordinates of the origin and end of each pod in the vehicle coordinate system.
4. A table of X-ordinates (relative to pod origin) for the pod radii distribution.
5. Pod radii distribution for each pod.

Contrails

The order of the generated surface points is from the bottom around to the top. The first point of each pod has a Status of 2, each new station starts with a Status of 1, and all other points have Status = 0. If the last point for a station fills only the left half of the Type 3 Element Data Card, a dummy point is generated to fill the right half of the card. When the pod axis lies in the X-Z origin plane, only half the pod is generated ($-90^\circ \leq \omega \leq +90^\circ$). Otherwise elements for the complete pod are determined.

In addition to specifying the axis orientation, the number of elements in 180° may also be specified. If this expanded capability is not used and the input fields are left blank, the program assumes the pod axis is parallel to the vehicle axis, and elements are generated every 15° in ω .

Contrails

POD AND NACELLE DATA CARDS

Pod Origin Card (3F7.0,3X,I1,3X,3F7.0,6X,I1,5X,I2)

<u>Column Code</u>	<u>Routine Format</u>	<u>Explanation</u>
1-7	PODORG(I,1) F7.0	X-coordinate of the origin of the first pod with respect to the vehicle coordinate system origin.
8-14	PODORG(I,2) F7.0	Y-coordinate of the origin of the first pod with respect to the vehicle coordinate system origin.
15-21	PODORG(I,3) F7.0	Z-coordinate of the origin of the first pod with respect to the vehicle coordinate system origin.
25	IOR I1	Arbitrary orientation flag. If this value does not equal 1, fields 29-49 are ignored and the pod axis is assumed parallel to the vehicle X-axis.
29-35	PODORG(I,4) F7.0	X-coordinate of the end point of the first pod with respect to the vehicle coordinate system.
36-42	PODORG(I,5) F7.0	Y-coordinate of the end point of the first pod with respect to the vehicle coordinate system.
43-49	PODORG(I,6) F7.0	Z-coordinate of the end point of the first pod with respect to the vehicle coordinate system.
56	IEL I1	Element number flag. If this value does not equal 1, field 62-63 is ignored and 12 elements are assumed in 180°.
62-63	NEL I2	Number of elements in 180° (≤ 36).
73-80		The card identification, PODORGi may be punched in these columns where i denotes the pod number.

Pod X-Station Card(s) (10F7.0,10X)

1-7	XPOD(I,1)	AIRCFT	Table of X-ordinates (relative to pod origin) to be used for the pod radii distribution. Use as many cards as required with 10 numbers on each card. The number of cross sections used must be the same as indicated by the parameter NPODOR given in field 58-60 on the Control Flag Card. The first X-ordinate must be zero, and the last X-ordinate is the length of the pod. The identification XPODi may be punched in card columns 73-80, where i denotes the pod number.
8-14	XPOD(I,2)	10F7.0	
15-21	XPOD(I,3)		
22-28	XPOD(I,4)		
29-35	XPOD(I,5)		
36-42	XPOD(I,6)		
43-49	XPOD(I,7)		
50-56	XPOD(I,8)		
57-63	XPOD(I,9)		
64-70	XPOD(I,10)		
1-7	XPOD(I,11)		
etc.	etc.		

Contrails

POD AND NACELLE DATA CARDS (continued)

Pod Radii Card(s) (10F7.0,10X)

<u>Column Code</u>	<u>Routine Format</u>	<u>Explanation</u>
1-7 PODR(I,1)	AIRCFT	A table of pod radii distribution at each X-station for the first pod. Use as many cards as required with 10 numbers on each card. The number of points used must be the same as indicated by the parameter NPODOR given in field 58-60 on the Control Flag Card. The identification PODR _i may be punched in card columns 73-80, where <i>i</i> denotes the pod number.
8-14 PODR(I,2)	10F7.0	
15-21 PODR(I,3)		
22-28 PODR(I,4)		
29-35 PODR(I,5)		
36-42 PODR(I,6)		
43-49 PODR(I,7)		
etc. etc.		

Note: A new set of all three pod input card sets is required for each pod (a maximum of 9 are provided for). Note that every pod uses the same value for the parameter NPODOR. If the Y-ordinate of the pod origin is 0.0 then only half of the symmetrical centerline pod is generated. If the Y-ordinate is not equal to 0.0 then the entire pod will be generated.

FINS

Fins are defined by upper and lower uncambered airfoils. Each airfoil lies in an X-Y plane at a fixed vertical distance, Z. This restriction may pose problems in some applications at the fin fuselage juncture. The leading edge of each airfoil is located relative to the coordinate system origin by input X-Y-Z displacements. For fins located on the plane of symmetry only half of the surface is generated. If the fin is located off the plane of symmetry both sides will be generated. The generation of surface points and elements follows the same general procedure as outlined previously for the wing.

The input information required to define a fin is as follows:

1. Number of vertical fins (up to 6).
2. Number of ordinates used to define each fin airfoil section (3 to 10).
3. The X-Y-Z coordinates of the fin lower and upper leading edges.
4. Chord lengths for the lower and upper airfoils.
5. A table of percent-chord locations that are used to define airfoils.
6. A table of airfoil ordinates as a percent of the chord length.

The input and formation of fin surface elements are illustrated in Figure 12.

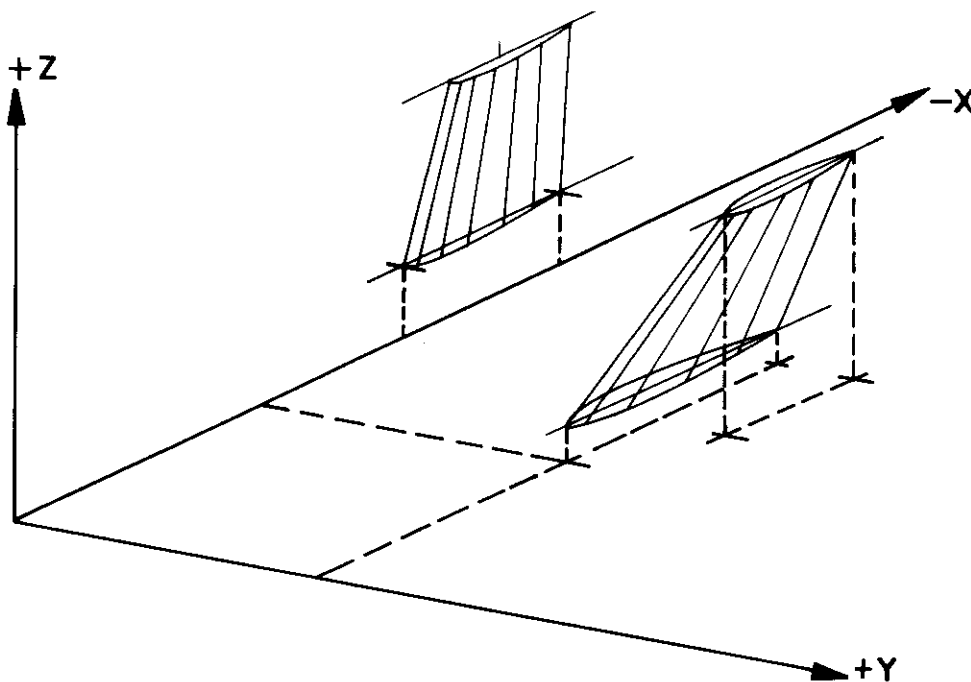

Figure 12. Fin Geometry Generation.

Controls

FIN DATA CARDS

Fin Leading Edge Coordinate Card (8F7.0,24X)

<u>Column Code</u>	<u>Routine Format</u>	<u>Explanation</u>
1-7 FINORG(N,1,1)	AIRCFT	X-coordinate of root airfoil leading edge.
8-14 FINORG(N,1,2)	8F7.0	Y-coordinate of root airfoil leading edge.
15-21 FINORG(N,1,3)		Z-coordinate of root airfoil leading edge.
22-28 FINORG(N,1,4)		Chord length of root airfoil.
29-35 FINORG(N,2,1)		X-coordinate of tip airfoil leading edge.
36-42 FINORG(N,2,2)		Y-coordinate of tip airfoil leading edge.
43-49 FINORG(N,2,3)		Z-coordinate of tip airfoil leading edge.
50-56 FINORG(N,2,4)		Chord length of tip airfoil.
73-80		The card identification FINORGn, where n denotes the fin number.

Fin Percent-Chord Location Card (10F7.0,10X)

1-7 XFIN(N,1)	AIRCFT	Table of percent-chord locations that are to be used for the airfoil thickness ordinates. Only one card is used and may contain up to 10 numbers. The number of percent-chord locations used must be the same as indicated by the parameter NFINOR in field 64-66 on the Control Flag Card. The card identification XFINn may be punched in card columns 73-80, where n denotes the fin number.
8-14 XFIN(N,2)	10F7.0	
15-21 XFIN(N,3)		
22-28 XFIN(N,4)		
29-35 XFIN(N,5)		
36-42 XFIN(N,6)		
43-49 XFIN(N,7)		
50-56 XFIN(N,8)		
57-63 XFIN(N,9)		
64-70 XFIN(N,10)		

Fin Airfoil Ordinate Card (10F7.0,10X)

1-7 FINORD(N,1)	AIRCFT	Table of fin airfoil thickness ordinates as a percent of chord length at each percent-chord ordinate position for the fin. Only one card is used and may contain up to 10 numbers. The number of percent-chord locations used must be the same as indicated by the parameter NFINOR in field 64-66 on the Control Flag Card. The card identification FINORDn may be punched in card columns 73-80, where n denotes the fin number.
8-14 FINORD(N,2)	10F7.0	
15-21 FINORD(N,3)		
22-28 FINORD(N,4)		
29-35 FINORD(N,5)		
36-42 FINORD(N,6)		
43-49 FINORD(N,7)		
50-56 FINORD(N,8)		
57-63 FINORD(N,9)		
64-70 FINORD(N,10)		

Note: A new set of all three fin input cards is required for each fin (a maximum of 6 are provided for). Note that every fin uses the same value for the parameter NFINOR. If the Y-ordinates of the fin leading edge are input as 0.0 only half of the symmetrical centerline fin is generated. If the Y-ordinates of the leading edge are not equal to 0.0 then the entire fin will be generated.

CANARDS OR HORIZONTAL TAILS

Canards or horizontal tails are defined in a manner similar to that used for fins using an inboard airfoil and an outboard airfoil. Each airfoil lies in an X-Z plane at a fixed Y distance. The airfoils may be symmetrical or unsymmetrical. Both the top and bottom of the surface will be generated using the same procedures as outlined for the wing.

The input information required to define a canard or horizontal tail is as follows:

1. Number of canards (up to 2).
2. Number of ordinates used to define the canard airfoils (3 to 10).
3. The X-Y-Z coordinates of the inboard and outboard airfoil leading edges.
4. Chord lengths of the inboard and outboard airfoils.
5. A table of percent-chord locations that are to be used to define the airfoils.
6. A table of airfoil upper surface ordinates as a percent of chord length. If the airfoil is not symmetrical another table contains the lower surface ordinates.

The generation of canard and horizontal tail surfaces is illustrated in Figure 13.

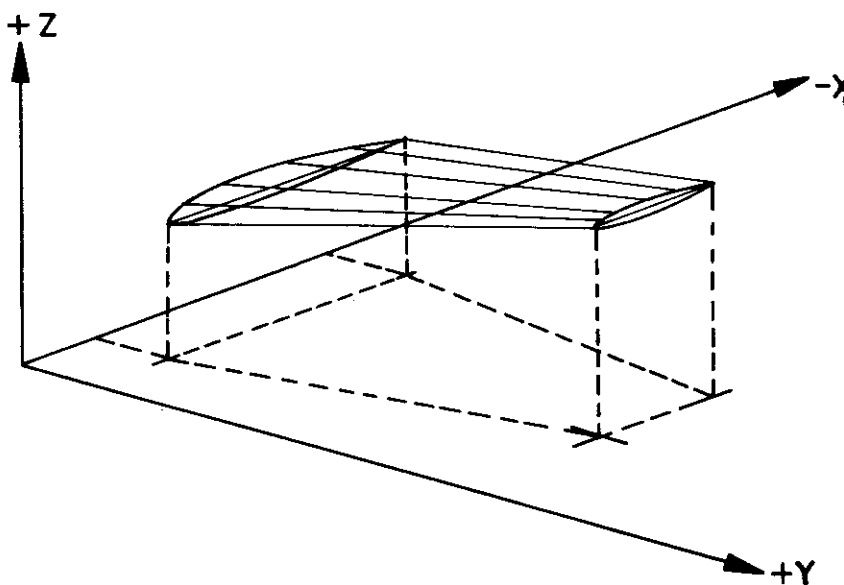

Figure 13. Generation of Canard and Horizontal Tail Geometry

Contrails

CANARD DATA CARDS

Canard Leading Edge Coordinate Card (8F7.0,24X)

<u>Column Code</u>	<u>Routine Format</u>	<u>Explanation</u>
1-7 CANORG(N,1,1)	AIRCFT	X-coordinate of inboard airfoil leading edge.
8-14 CANORG(N,1,2)	8F7.0	Y-coordinate of inboard airfoil leading edge.
15-21 CANORG(N,1,3)		Z-coordinate of inboard airfoil leading edge.
22-28 CANORG(N,1,4)		Chord length of the inboard airfoil.
29-35 CANORG(N,2,1)		X-coordinate of outboard airfoil leading edge.
36-42 CANORG(N,2,2)		Y-coordinate of outboard airfoil leading edge.
43-49 CANORG(N,2,3)		Z-coordinate of outboard airfoil leading edge.
50-56 CANORG(N,2,4)		Chord length of the outboard airfoil.
73-80		The card identification CANORGn may be punched in card columns 73-80, where n denotes the fin number.

Canard Percent-Chord Location Card (10F7.0,10X)

1-7 XCAN(N,1)	AIRCFT	Table of percent-chord locations that are to be used for the airfoil thickness ordinates. Only one card is used and may contain up to 10 numbers. The number of percent-chord locations used must be the same as indicated by the parameter NCANOR in field 70-72 on the Control Flag Card. The card identification XCANn may be punched in card columns 73-80, where n denotes the canard number.
8-14 XCAN(N,2)	10F7.0	
15-21 XCAN(N,3)		
22-28 XCAN(N,4)		
29-35 XCAN(N,5)		
36-42 XCAN(N,6)		
43-49 XCAN(N,7)		
50-56 XCAN(N,8)		
57-63 XCAN(N,9)		
64-70 XCAN(N,10)		

Canard Upper Ordinate Card (10F7.0,10X)

Also used for lower surface if canard is symmetrical.

1-7 CANORD(N,1)	AIRCFT	Table of canard airfoil thickness ordinates as a percent of chord length at each percent-chord ordinate position. Only one card is used and may contain up to 10 numbers. The number of percent-chord locations used must be the same as indicated by the parameter NCANOR in field 70-72 on the Control Flag Card. If the parameter NCANOR is positive (+) these airfoil ordinates will be used for both the top and bottom of the canard. The card identification CANORDn may be punched in card columns 73-80, where n denotes the canard number.
8-14 CANORD(N,2)	10F7.0)	
15-21 CANORD(N,3)		
22-28 CANORD(N,4)		
29-35 CANORD(N,5)		
36-42 CANORD(N,6)		
43-49 CANORD(N,7)		
50-56 CANORD(N,8)		
57-63 CANORD(N,9)		
64-70 CANORD(N,10)		

If the canard airfoil is not symmetrical the bottom airfoil thickness ordinates are input of the following card.

CANARD DATA CARDS (continued)

Canard Lower Ordinate Card (10F7.0,10X)

This card is only used if the airfoil is not symmetrical (NCANOR = -)

<u>Column Code</u>	<u>Routine Format</u>	<u>Explanation</u>
1-7 CANOR1(N,1)	AIRCFT	Table of canard airfoil thickness ordinates for the lower surface as a percent of chord length at each percent-chord ordinate position. Only one card is used and may contain up to 10 numbers. The number of percent-chord locations used must be the same as indicated by the parameter NCANOR in field 70-72 on the Control Flag Card. The parameter NCANOR must be negative. Both the upper and lower thickness ordinates are input as positive percent-of-chord values. The card identification CANOR1n may be punched in card columns 73-80, where n denotes the canard number.
8-14 CANOR1(N,2)	10F7.0	
15-21 CANOR1(N,3)		
22-28 CANOR1(N,4)		
29-35 CANOR1(N,5)		
36-42 CANOR1(N,6)		
43-49 CANOR1(N,7)		
50-56 CANOR1(N,8)		
57-63 CANOR1(N,9)		
64-70 CANOR1(N,10)		

Note: A new set of all canard cards is required for each canard (a maximum of 2 canards are provided for). Note that every canard uses the same value for the parameter NCANOR.

GENERAL AIRFOIL SURFACES

This geometry surface type may be used to generate surfaces that are defined by airfoil sections having arbitrary orientations in space. The airfoils are not confined to fixed planes as was the case for the wings, fins and canards previously described. This more general approach permits the use of non-streamwise airfoil sections and is useful in describing intersecting components such as the wing and tail fuselage junctures. Input cards for this surface type cannot be used as input to the NASA Wave Drag Program.

The general airfoil surface is defined by connecting two or more airfoil sections with straight lines. The orientation of each airfoil is given by coordinates of the leading and trailing edges and an airfoil rotation angle. The techniques used in defining these airfoils and in performing the necessary transformation to obtain the required Z-Y-Z coordinates in the vehicle coordinate system are discussed below.

Each airfoil section is defined relative to a coordinate system fixed within the airfoil. The airfoil thickness displacements may be measured either from the mean-camber line along a line perpendicular to the airfoil axis or on a line that is normal to the mean camber line. This latter method is used in some of the early NASA airfoil documents. All airfoil section parameters are expressed as a percent of the airfoil chord. The parameters used in defining an airfoil are illustrated in Figure 14. In this illustration the airfoil lies in the η - ξ plane.

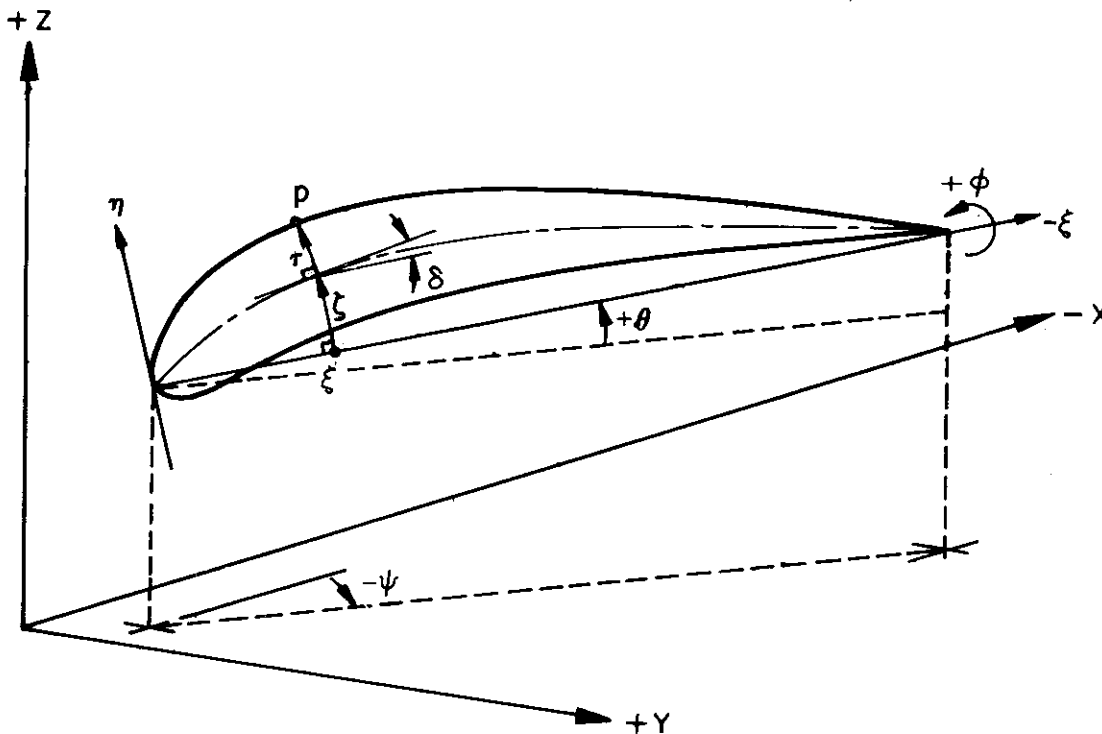

Figure 14. General Airfoil Coordinate System.

Contrails

The input information required by the Aircraft Geometry Option to define a general airfoil surface is as follows:

1. Number of airfoils.
2. Number of airfoil percent-chord points used to define the airfoils.
3. Flags to control the thickness distribution type, generation of tip and root closure elements, and repetitive use of mean camber line and thickness distributions.
4. A table of percent chord locations that are to be used for the airfoil thickness and camber distributions.
5. The X-Y-Z coordinates of the leading and trailing edge of each airfoil section.
6. The roll angle ϕ of each airfoil section.
7. The mean camber line ordinates in percent-chord at each percent chord location for each airfoil.
8. Thickness distribution in percent chord at each percent-chord position for each airfoil.

The roll angle ϕ is input explicitly and together with ψ and θ are positive in the right-handed sense of the reference system.

Zero values for the rotation angles indicate the airfoil is orientated parallel to the X-Z plane. Zero yaw and pitch angles and a +90 degree roll angle gives an airfoil in the X-Y plane (such as a vertical tail root airfoil).

This surface type differs from those previously described in that repetitive use may be made of the arbitrary airfoil option on a single pass into the Aircraft Geometry Option. This stacking option allows wings, fins, etc. to be generated on a single pass into the Aircraft Geometry Option. A control flag also permits repetitive use of airfoil data for subsequent airfoils to save input time when all the surface airfoils are identical. Tip and root closure elements may also be generated to give a completely enclosed surface.

The arrangement of the generated X-Y-Z surface points and elements is similar to the procedure outlined for the wing surface with the exception of elements that may be generated to close the tip and root sections.

Contrails

GENERAL AIRFOIL DATA CARDS

General Airfoil Control Flag Card (22X,I3, 2(3X,I2), 7(4X,I1),2X,A4,4X)

<u>Column Code</u>	<u>Routine Format</u>	<u>Explanation</u>
1-22		Surface Description statement. Any acceptable machine characters. Not used by the program.
23-25 ISURF	AIRCFT I3	Control surface deflection flag (= 0).
29-30 NAF	AIRCFT I2	Number of airfoils used to describe the surface. = 2 to 20.
34-35 NAFORD	AIRCFT I2	Number of percent-chord points used to define each airfoil section. = 3 to 30.
40 NCAM	AIRCFT I1	Flag for mean camber line distribution. = 0 No camber data will be input. = 1 Camber data will be input.
45 NACA	AIRCFT I1	Airfoil thickness type flag. = 0 Thickness will be calculated normal to the chord line. = 1 Thickness will be calculated normal to the mean camber line. = 2 Same as = 0, but camber input as ΔZ .
50 IT1P	AIRCFT I1	Flag for closure surface at the tip. = 0 Do not generate tip closure surface. = 1 Tip closure surface will be generated.
55 IROOT	AIRCFT I1	Flag for closure surface at the root. = 0 Do not generate root closure surface. = 1 Root closure surface will be generated.
60 ISLMC	AIRCFT I1	Flag for similar camber line distribution. = 0 Each airfoil camber line will be input. = 1 Camber line distribution will be the same for all airfoils and need be input only for the first.
65 ISIMT	AIRCFT I1	Flag for similar thickness distribution. = 0 Each airfoil thickness distribution will be input. = 1 Thickness distribution will be the same for all airfoils and need be input only for the first.
70 MORE	AIRCFT I1	Flag to indicate stacking of general airfoil surfaces. = 0 This is the last surface. = 1 Another surface follows and a complete set of arbitrary airfoil input cards is expected immediately following this set.
73-76 SURFID	AIRCFT A4	Surface identification to be punched in fields 73-76 of the output element data Type 3 cards. Any acceptable machine characters.

Contrails

GENERAL AIRFOIL DATA CARDS (continued)

Airfoil Percent-Chord Location Card(s) (10F7.0,10X)

<u>Column Code</u>	<u>Routine Format</u>	<u>Explanation</u>
1-7 XOC(1)	AIRCFT	Table of percent-chord locations that are to be used for the airfoil thickness and camber distributions. Each card may contain up to 10 fields, if more are required continue with additional cards of the same format. Use as many fields as is specified by NAFORD (field 34-35) on the General Airfoil Control Flag Card. Maximum number of fields is 30 (3 cards).
8-14 XOC(2)	10F7.0	
15-21 XOC(3)		
22-28 XOC(4)		
29-35 XOC(5)		
36-42 XOC(6)		
43-49 XOC(7)		
50-56 XOC(8)		
57-63 XOC(9)		
64-70 XOC(10)		
1-7 XOC(11)		Fields 73-80 of each card may be used for identification.
etc. etc.		

Airfoil Orientation Cards (10F7.0,10X)

1-7 AFORG(I,1)	AIRCFT	X-coordinate of the airfoil leading edge.
8-14 AFORG(I,2)	10F7.0	Y-coordinate of the airfoil leading edge.
15-21 AFORG(I,3)		Z-coordinate of the airfoil leading edge.
22-28 AFORG(I,4)		X-coordinate of the airfoil trailing edge.
29-35 AFORG(I,5)		Y-coordinate of the airfoil trailing edge.
36-42 AFORG(I,6)		Z-coordinate of the airfoil trailing edge.
43-49 AFORG(I,7)		Airfoil roll angle ϕ in degrees.
73-80		May be used for identification.

Note: Repeat this card for all airfoils, starting with the inboard root airfoil and working to the outboard tip airfoil. The number of these cards is given by the value of NAF (field 29-30) of the General Airfoil Control Flag Card and must not be greater than 20.

Airfoil Camber Distribution Cards (10F7.0,10X)

Required only if NCAM = 1 on the General Airfoil Control Flag Card. If NACA = 2, use wing camber cards (see p. 49)

1-7 AFCAM(I,1)	AIRCFT	Mean camber line distribution, in percent-chord, at each percent-chord location XOC. Use as many cards as required with 10 numbers on each card. Each airfoil must have as many numbers as was specified by the parameter NAFORD (field 34-35) on the General Airfoil Control Flag Card (30 maximum). There will be as many sets of cards as given by the parameter NAF (field 29-30) on the General Airfoil Control Flag Card. The first value for each airfoil should start on a new card. If parameter ISIMC = 1 (field 60 of General Airfoil Control Flag Card), only one set of cards is required. Fields 73-80 may be used for identification.
8-14 AFCAM(I,2)	10F7.0	
15-21 AFCAM(I,3)		
22-28 AFCAM(I,4)		
29-35 AFCAM(I,5)		
36-42 AFCAM(I,6)		
43-49 AFCAM(I,7)		
50-56 AFCAM(I,8)		
57-63 AFCAM(I,9)		
64-70 AFCAM(I,10)		
1-7 AFCAM(I,11)		
etc. etc.		

Contrails

GENERAL AIRFOIL DATA CARDS (continued)

Airfoil Thickness Distribution Cards (10F7.0,10X)

<u>Column Code</u>	<u>Routine Format</u>	<u>Explanation</u>
1-7 AFORD(I,1)	AIRCFT	Airfoil thickness coordinates, in percent-chord, at each percent-chord location XOC. Use as many cards as required with 10 numbers on each card. Each airfoil must have as many numbers as was specified by the parameter NAFORD (field 34-35) on the General Airfoil Control Flag Card (30 maximum). There will be as many sets of cards as given by the parameter NAF (field 29-30) on the General Airfoil Control Flag Card. The first value for each airfoil should start on a new card. If parameter ISIMT = 1 (field 65 of General Airfoil Control Flag Card), only one set of cards is required. Fields 73-80 may be used for identification.
8-14 AFORD(I,2)	10F7.0	
15-21 AFORD(I,3)		
22-28 AFORD(I,4)		
29-35 AFORD(I,5)		
36-42 AFORD(I,6)		
43-49 AFORD(I,7)		
50-56 AFORD(I,8)		
57-63 AFORD(I,9)		
64-70 AFORD(I,10)		
1-7 AFORD(I,11)		Note: Data are input as 1/2 of total thickness values (i.e., if $t/c_{total} = 0.04$, then input AFORD = $t/c = 2.0\%$).
etc. etc.		

AERODYNAMIC PROGRAM INPUT DATA

The Aerodynamic portion of the program contains six major components.

1. Flow Field Analysis
2. Shielding Analysis
3. Inviscid Pressures
4. Viscous Methods
5. Special Routines
6. Streamlines

Access to these major options is obtained by use of the Aero option on the System Control Card input to the Main Executive Routine. All six of the above major options are controlled by an executive routine called AERO.

The input data to the AERO executive routine includes a set of flags (IPG) to determine the sequence of calls to the above six options. Up to 20 calls may be made to the various options on a single entry into the AERO executive routine. After the last non-zero option is executed the program will return to the Main Executive program. The basic flight conditions, vehicle reference dimensions, and the angle of attack and yaw angle cards are input to the AERO executive routine and apply for all of the AERO options called by the IPG commands.

Input to Aero Executive Routine

Aero System Title Card (15A4)

<u>Column Code</u>	<u>Routine Format</u>	<u>Explanation</u>
1-60 TITLE	AERO 15A4	Title to be printed at the top of each page of the output.

Aero Flag Card (20I1)

1	IPG(1)	AERO I1	Aerodynamic sub-options to be used in the order in which they will be solved. Maximum of 20.
2	IPG(2)		= 1 Flow Field Analysis.
3	IPG(3)		= 2 Shielding Analysis.
etc.	etc.		= 3 Inviscid Pressures.
20	IPG(20)		= 4 Viscous Forces.
26,27	NTAPE	I2	= 5 Special Routines
28	IREP	I1	= 6 Streamlines

IREP .NE. 0 SKIP TAKE 4

Contrails

Flight Condition Card (4F10.0,I1,I2)

<u>Column Code</u>	<u>Routine Format</u>	<u>Explanation</u>
1-10 MACH	AERO F10.0	Free-stream Mach number
11-20 ALT	AERO F10.0	Flight altitude (feet). If input as less than -1000 (e.g., -2000.0) free-stream pressure is input in place of PSTAG (cc 21-30) and free-stream temperature is input in place of TSTAG (cc 31-40).
21-30 PSTAG	AERO F10.0	Wind-tunnel stagnation pressure (atmospheres). = 0.0 If the U.S. 1962 Standard Atmospheric properties are to be used at the input altitude. ≠ 0.0 Input altitude will be ignored and the input stagnation pressure and temperature will be used to calculate tunnel free-stream properties (using isentropic ideal-gas relationships).
31-40 TSTAG	AERO F10.0	Wind-tunnel stagnation temperature, °F. This number will be used with the above pressure to calculate the tunnel free-stream properties.
41 IGAS	AERO I1	Gas selection flag. = 0 Air properties will be used. = 1 Helium properties will be used.
42-43 NAB	AERO I2	Number of α - β cards to be read. A maximum of 20 cards are permitted.

Reference Dimension Card (6F10.0)

1-10 SREF	AERO F10.0	Reference area for the force coefficients (wing area). Must be in units consistent with input scaled geometry data.
11-20 MAC	AERO F10.0	Reference length to be used in pitching moment calculations.
21-30 SPAN	AERO F10.0	Reference length to be used in rolling-and yawing-moment calculations.
31-40 XCG	AERO F10.0	Longitudinal position of center of gravity for moment calculations. Note that XCG will frequently be input as a negative number since the negative X-axis is usually taken as directed from the nose to the tail.
41-50 YCG	AERO F10.0	Lateral position of the center of gravity. Usually = 0.0.
51-60 ZCG	AERO F10.0	Vertical position of the center of gravity.

Contrails

α - β Cards (7F10.0)

The number of these cards to be input is controlled by the parameter NAB. The complete set of α - β cards is assumed to be used by all the AERO options (Flow Field, Inviscid Pressures, Viscous, and Special) unless the various options specify otherwise.

<u>Column Code</u>	<u>Routine Format</u>	<u>Explanation</u>
1-10 ALPHA(I)	AERO F10.0	Vehicle angle of attack (α), deg.
11-20 BETA(I)	AERO F10.0	Vehicle sideslip angle (β). Positive with the wind striking the right side of the vehicle, deg.
21-30 ROL(I)	AERO F10.0	Vehicle roll angle, deg. Positive with right wing down.
31-40 CDELTA(I)	AERO F10.0	Control surface deflection angle. (Not operational in Mark IV Mod 0 version)
41-50 QI(I)	AERO F10.0	Vehicle pitch rate, radians/sec.
51-60 RI(I)	AERO F10.0	Vehicle yaw rate, radians/sec.
61-70 PI(I)	AERO F10.0	Vehicle roll rate, radians/sec.

Note: The above parameters are stored in data arrays. A maximum of 20 conditions are permitted.

FLOW FIELD PROGRAM INPUT DATA

The Flow Field Program is reached by way of sub-option calls from the Aero Executive routine. The Flow Field Program is used to load or generate local flow fields for use in the pressure calculations of the Inviscid Force option. The Flow Field Program stores local flow field data on the Flow-Field Data Storage unit using mass storage (direct access) techniques. The unit contains several directory tables to provide the necessary pointers to each level of the data. These include a Master Directory, an α - β directory table for each data set (Mach number) that provides the pointers to each α - β set, a region directory table for each α - β that points to the flow field table, and a flow field data table that points to each type of flow field data (i.e., flow field, streamlines, etc.). It is very important to be thoroughly familiar with the way that these tables are generated and used. Subroutine FLOW should be studied to obtain this knowledge. The general manner in which the flow field information is generated and stored is summarized by the diagram in Figure 15. The organization of the Flow Field Data Directories and Tables is shown in the diagram of Figure 16. The detailed card input requirements for each of the options are then presented on the following pages.

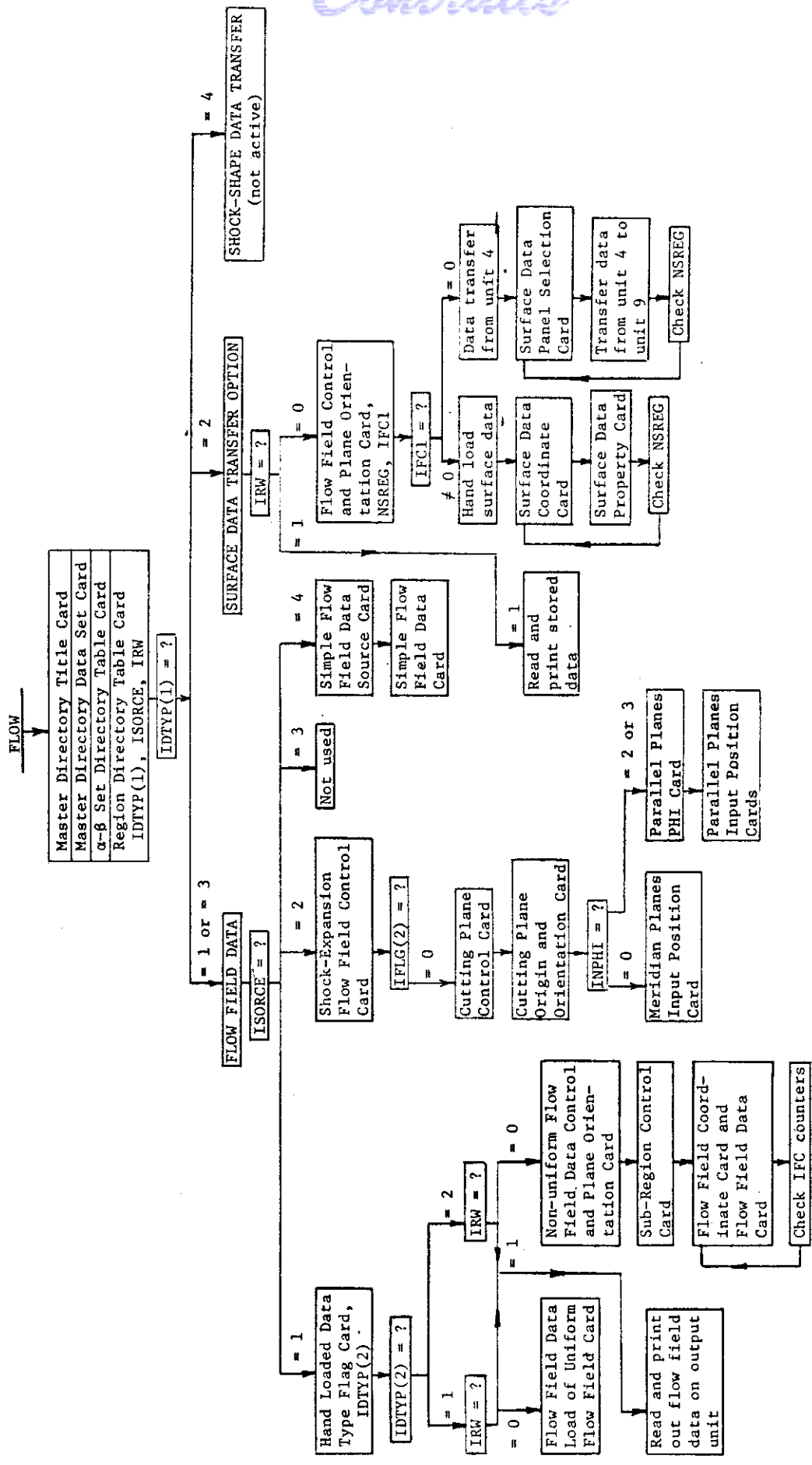

Figure 15. Input Data Logic for Flow Field Option.

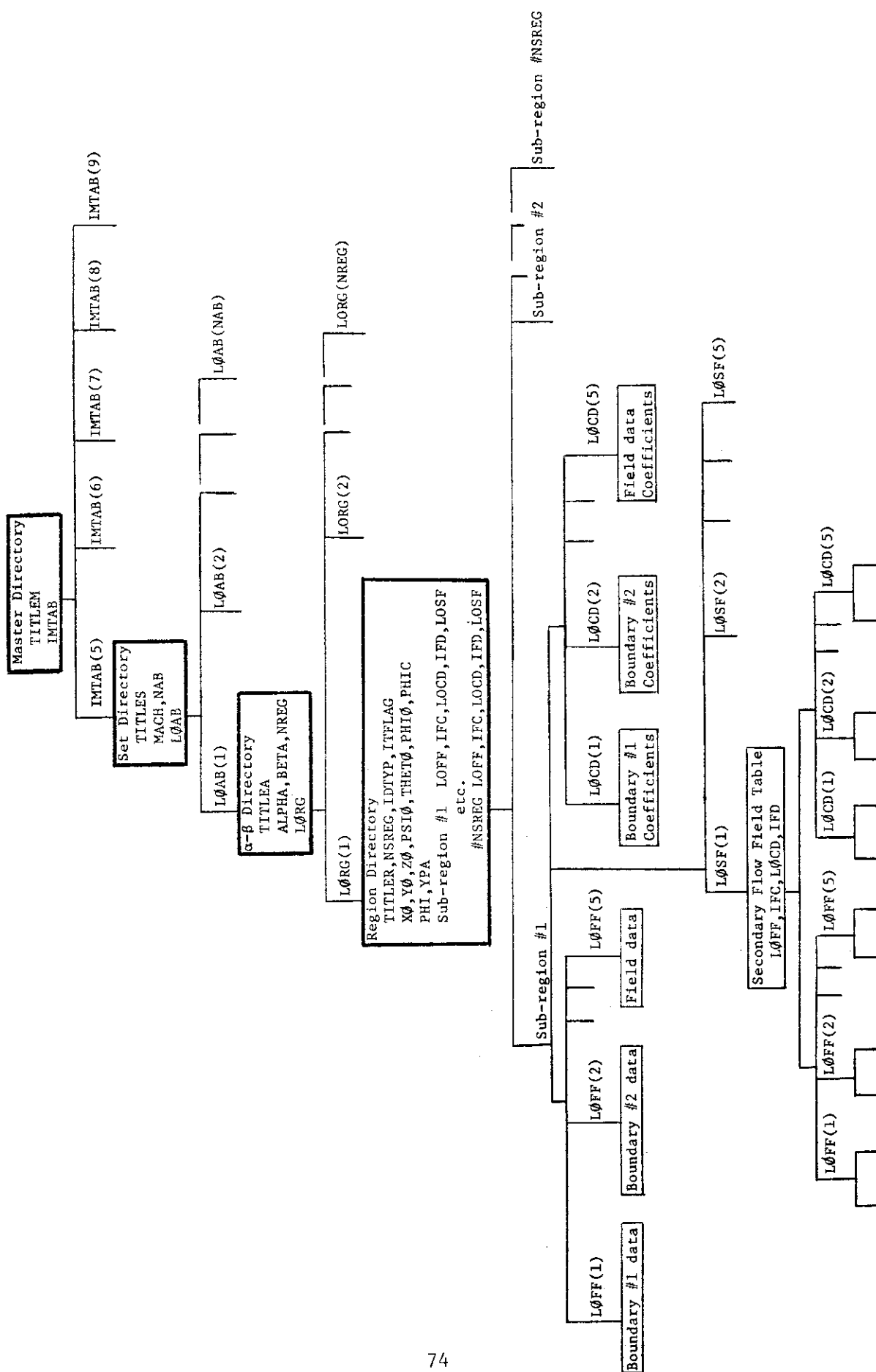

Figure 16. Flow Field Data Storage Format.

FLOW FIELD DATA

The input cards described below control the generation and use of the Flow field storage unit directories and tables and the pointers that they contain. In general, options are provided for either reading data already stored on the unit and printing them on the output unit for inspection, or the actual loading or generation of the flow field data. The cards described below are concerned with the generation and use of the directory tables. Subsequent input card descriptions will give the input requirements for each of the methods actually used in loading or generating the flow field data itself using the directory tables that have been prepared.

Master Directory Title Card (1I1,19X,10A4)

<u>Column</u>	<u>Code</u>	<u>Routine</u>	<u>Explanation</u>
		<u>Format</u>	
1	MFLAG	FLOW I1	Master directory status flag. = 0 Set up complete new master directory table. = 1 Directory table already exists, so just use old pointers.
21-60	TITLEM	FLOW 10A4	Master directory title. This title is only used when MFLAG = 0.

Master Directory Data Set Card (2I1, 1X, I1, F6.0, 10X, 10A4)

This card is used to establish the different sets of data (i.e., different Mach numbers).

1	LASTS	FLOW I1	Last set flag. = 0 This is not the last set of data. = 1 This is the last set of data.
2	NEWS	FLOW I1	New Set Directory flag. = 0 Set up a new Set Directory table. = 1 The desired Set Directory already exists so just read the pointers to get to the desired set. = 2 A new Set Directory will be added and the Master Directory pointer updated.
4	NSET	FLOW I1	Data set number. Maximum of 5 permitted. (must be = 1 if NEWS = 0)
5-10	MACH	FLOW F6.0	Mach number. This does not have to be the same as was input to AERO.
21-60	TITLES	FLOW 10A4	Set directory title. This title is used only when NEWS = 0.

Contrails

Region Directory Table Card (continued)

<u>Column Code</u>	<u>Routine Format</u>	<u>Explanation</u>
3-4 IREG	FLOW I2	Flow region number.
5 IDTYP(1)	FLOW I1	Data type flag. = 1 Flow Field data will be read, loaded, or generated. = 2 Surface property data will be read or loaded. = 3 Streamline data will be read or hand loaded. = 4 Shock shape data will be read or hand loaded. (not active)
6 ISORCE	FLOW I1	Flow Field data source flag. Used only if IDTYP(1) = 1. = 1 Data are to be input using the hand loaded flow field option, or will be read and printed out from an already existing data set for examination. = 2 Data will be generated using the Shock-Expansion option. = 3 Not used at present time. Reserved for use in downstream flow field generation. = 4 Data will be generated using one of the Simple Flow Field routines.
7 IRW	FLOW I1	Data read or write flag. = 0 Data will be input or generated by one of the sub-options and the flow field data saved on the storage unit (10). = 1 Data will be read from the flow field data save unit (10) and written out on the output file.
21-60 TITLER	FLOW 10A4	Title for the region directory table. This title is only used when NEWR = 0.

Note: The type of cards expected next is determined by the IDTYP(1)
and ISORCE parameters.

Contrails

Hand-Load Flow Field Option

This option is provided as a means of inputting flow-field data directly on to the flow-field data storage unit (unit 10). This option is reached when IDTYP(1) = 1 and ISORCE = 1, or when IDTYP(1) = 3 on the Region Directory Table Card.

Hand-Load Data Type Flag Card (I1)

Column	Data	Routine Format	Explanation
1	IDTYP(2)	FFINPT I1	Data type flag. = 1 Uniform flow field data are to be input (IRW=0) or read (IRW=1). = 2 Non-uniform flow field data are to be input (IRW=0) or read (IRW=1).

Flow Field Data Load of Uniform Flow Field (6F10.0)

This card is input only if IDTYP(2) = 1, and IRW = 0.

1-10	DINF(1)	FFINPT F10.0	M_{local}
11-20	DINF(2)	FFINPT F10.0	X direction cosine component of local velocity vector.
21-30	DINF(3)	FFINPT F10.0	Y direction cosine component of local velocity vector.
31-40	DINF(4)	FFINPT F10.0	Z direction cosine component of local velocity vector.
41-50	DINF(5)	FFINPT F10.0	P/P_{∞} local.
51-60	DINF(6)	FFINPT F10.0	T/T_{∞} local.

Non-Uniform Flow Field Data Control and Plane Orientation Card (I1,4X,I1,4X,6F10.0)

This card is input if IDTYP(2) = 2, and IRW = 0

1	NSREG	FFINPT I1	Number of sub-regions (assumed at least 1).
6	ITFLAG	FFINPT I1	Data normalization flag. = 0 Data = fn (A,R) = 1 Data = fn (X,Y) = 2 Data = fn (X,Z)
11-20	X \emptyset	FFINPT F10.0	X \emptyset (see Shock-Expansion Flow Field option, page 82)
21-30	Y \emptyset	FFINPT F10.0	Y \emptyset
31-40	Z \emptyset	FFINPT F10.0	Z \emptyset

Contrails

Non-Uniform Flow Field Data Control and Plane Orientation Card (continued)

Column Code	Routine Format	Explanation
41-50 PSI \emptyset	FFINPT F10.0	PSI \emptyset
51-60 THET \emptyset	FFINPT F10.0	THET \emptyset
61-70 PHI \emptyset	FFINPT F10.0	PHI \emptyset

Sub-Region Control Card (11I2)

This card is input only if IDTYP(1) = 2, and IRW = 0.

1-2	IFC(1)	FFINPT I2	Number of points input on first boundary. IFC(1) \leq 50.
3-4	IFC(2)	FFINPT I2	Number of points on the second boundary. IFC(2) \leq 50.
5-6	IFC(3)	FFINPUT I2	Number of points on the third boundary. (not active at present time)
7-8	IFC(4)	FFINPT I2	Number of points on the fourth boundary. (not active at present time)
9-10	IFC(5)	FFINPT I2	Number of remaining internal flow field points.

Note that $(IFC_1 + IFC_2 + IFC_3 + IFC_4 + IFC_5) \leq 100$

11-12	IFD(1)	FFINPT I2	Not used at present time.
13-14	IFD(2)	FFINPT I2	Not used at present time.
15-16	IFD(3)	FFINPT I2	Not used at present time.
17-18	IFD(4)	FFINPT I2	Not used at present time.
19-20	IFD(5)	FFINPT I2	Not used at present time.
21-22	ISECF	FFINPT I2	Secondary flow flag. = 0 No secondary flow is present. = 1 Yes, secondary flow will be input.

Note that the above card is followed immediately by the flow field data cards.

Contrails

Flow Field Coordinate and Flow Field Data Cards

All of the actual flow-field data (both boundary data and flow field values) are loaded in the same format. The number of data points in each set is given by the parameters IFC(1), IFC(2), and IFC(5). In the present program IFC(3) and IFC(4) are not active. Each data point consists of one Flow Field Coordinate Card and one Flow Data Card. Each pair of cards is repeated until the required number of data points has been read in as required by the IFC counters. Used if IDTYP(2) = 2.

<u>Flow Field Coordinate Card</u>		(6F10.0)
<u>Column Code</u>	<u>Routine Format</u>	<u>Explanation</u>
1-10 DATA(1)	FFINPT F10.0	X-coordinate of flow field data point.
11-20 DATA(2)	FFINPT F10.0	Y-coordinate of flow field data point.
21-30 DATA(3)	FFINPT F10.0	Z-coordinate of flow field data point.
31-40 DATA(4)	FFINPT F10.0	A, axial distance of flow field data point.
41-50 DATA(5)	FFINPT F10.0	R, radial distance of flow field data point.
51-60 DATA(6)	FFINPT F10.0	PHI, orientation angle of flow field data point, in degrees.

Flow Field Data Card (6F10.0)

1-10 DATA(7)	FFINPT F10.0	M_{local} .
11-20 DATA(8)	FFINPT F10.0	X direction cosine component of local velocity vector.
21-30 DATA(9)	FFINPT F10.0	Y direction cosine component of local velocity vector.
31-40 DATA(10)	FFINPT F10.0	Z direction cosine component of local velocity vector.
41-50 DATA(11)	FFINPT F10.0	P/P_{∞} local.
51-60 DATA(12)	FFINPT F10.0	T/T_{∞} local.

Note: The Sub-Region Control Card and the required number of pairs of Flow Field Coordinate and Data cards are repeated until the ISECF parameter on the Sub-Region Control Card is set to 0. If NSREG is greater than 1, then this entire set of cards is repeated again. This process is repeated until the number of sets is equal to NSREG.

Simple Flow Field Option

This option is provided as a means of generating uniform flow field data using the compression, Prandtl-Meyer expansion, cone, and Newtonian Prandtl-Meyer routines provided in the program. The basic input requirements include the freestream Mach number, the direction cosine components of the flow field, and the flow turning angle. The program then uses one of the above routines to calculate the local Mach number, P/P_∞ , and T/T_∞ values. These data are then stored on the flow field storage unit in the same format as would be used if they had been input using the Hand Loaded Flow Field option. Each entry to the Simple Flow Field Option generates one flow field Region. The cards below are input only if IDTYP(1) = 1, and ISORCE = 4 on the Region Directory Title Card.

Simple Flow Field Data Source Card (11)

Column Code	Routine Format	Explanation
1 ISORCE	FFSPEC 11	Simple flow field selection flag. = 1 Wedge compression. = 2 Prandtl-Meyer expansion from freestream Mach number. = 3 Cone surface flow field. = 4 Newtonian Prandtl-Meyer flow field.

Simple Flow Field Data Card (6F10.0)

1-10 DINF(1)	FFSPEC F10.0	Freestream Mach number
11-20 DINF(2)	FFSPEC F10.0	X direction cosine component of local velocity vector.
21-30 DINF(3)	FFSPEC F10.0	Y direction cosine component of local velocity vector.
31-40 DINF(4)	FFSPEC F10.0	Z direction cosine component of local velocity vector.
41-50 DINF(5)	FFSPEC F10.0	Flow generating turning angle from freestream direction required to give desired local flow field conditions.
51-60 DINF(6)	FFSPEC F10.0	Field angle parameter (not used at present time).

Contrails

An initial value of the meridian angle ϕ_0 may also be input. This is simply a convenience as the shock-expansion calculations are made with reference to the most windward plane. All cutting planes will be perpendicular to the YP, ZP plane (P simply denotes prime). Parallel cutting planes will be parallel to the XP-axis and meridian planes will contain the XP-axis.

Meridian Cutting Planes. Meridian planes are specified by a rotation, ϕ , about the XP axis, $\phi = 0$ being the negative ZP-plane. Meridian planes may be specified individually (ϕ input in ascending order) or selected as equally spaced. In the latter case,

$$\phi(I) = \phi_0 + (I-1) * \Delta\phi \quad ; \quad I = 1, \text{NPL}$$

where NPL is the number of cutting planes and

$$\Delta\phi = 360 / \text{NPL}$$

Meridian planes are "one-sided" in that intersections with the surface are found only at ϕ and not at $\phi + 180^\circ$.

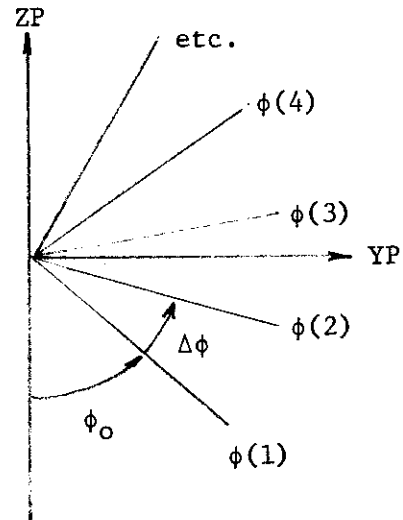

Some care must be taken in defining the cutting plane axis in relation to the surface geometry. Consider the example shown below of a cambered or inclined fuselage.

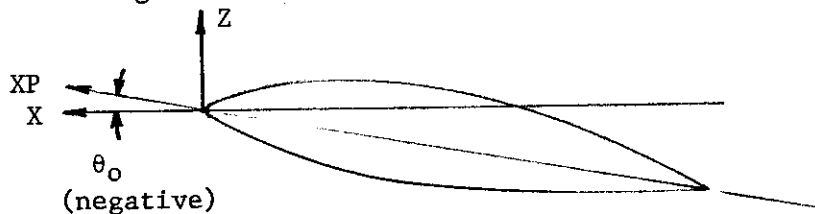

If the axis for the meridian planes is specified coincident with the X-axis ($\psi_0 = 0$, $\theta_0 = 0$), meaningless results will be obtained for the flow lines aft of the location at which the body is below the X-axis. Correct orientation of the XP-axis in this case would be at a negative θ_0 , passing through the nose and the trailing edge points.

Contours

In general, the meridian axis should everywhere be interior to the surface in question. While radial symmetry between ϕ and $\phi+180^\circ$ planes is not conserved, the angular relationship between successive segments of the flow line is maintained, which is the important quantity in the shock-expansion method.

Parallel Cutting Planes. Parallel cutting planes are inclined to the ZP-axis at a constant angle ϕ_c , and may also be input individually or selected as equally spaced. The positions (XN,YN,ZN) of the parallel planes are input in reference coordinates (X,Y,Z) and are automatically transformed to the cutting plane coordinates (XP,YP,ZP). If equal spacing is selected, the two end points are input and the planes are located at

$$YPA(I) = YPA(1) + (I-1) * \Delta YPA ; I = 1, NPL$$

where

$$\Delta YPA = \{YPA(NPL) - YPA(1)\} / (NPL-1)$$

The notation YPA refers to the YP position of the YP-axis.

Parallel cutting planes are "two-sided" in that intersections with the surface are found at both ϕ_c and $\phi_c + 180^\circ$. Wing-like components should, therefore, be defined in separate groups of upper surface panels and lower surface panels.

Flow Line Shapes and Data Ordering. The flow lines are defined by the intersections of the cutting planes with the surface geometry. Before the shock-expansion calculations can proceed, the intersections are arranged in ascending order of the axial coordinate A, defined positive in the flow direction (i.e., $A = -XP$), and duplicate points are eliminated.

Two input parameters, X1 and X2, are provided as a means to limit the extent of the flow field to be saved on unit 10. This may be useful, for example, in considering a local region of a flow line which could only be obtained from a geometry panel input over a larger extent. More importantly, it is necessary to avoid multiple points on the cutting plane axis. That is, to eliminate the nose point and trailing edge point of pointed bodies (e.g., the previous sketch of an inclined body). Each meridian flow line would contain these points and since they are on the XP-axis it is impossible to establish the ϕ coordinate. This is of no consequence to the actual shock-expansion calculations (as in fact they are included) but is important if the flow field data are saved for subsequent streamline or force calculations.

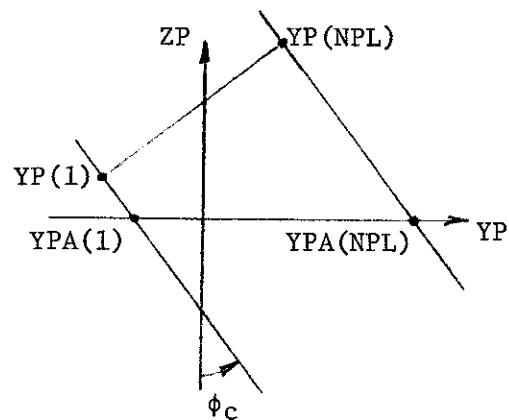
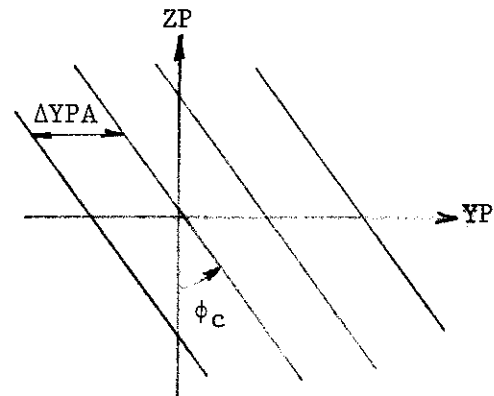

Contrails

Symmetry Considerations. Most configurations are loaded with Y-symmetry (geometry input flag SYMFCT = 0) and only one side is actually loaded. In addition, many runs are made with zero yaw (Beta = 0) and calculations need only be made on the input half of the configuration (total forces are obtained by simply doubling). Because of the frequency of this type of calculation, it is considered a normal run and the input parameter ISYM = 0 on the Cutting Plane Control Card. If on the other hand, a symmetric configuration is run in a yawed flow, ISYM = 1 will automatically reflect the geometry. The ISYM flag has no effect on a non-symmetric configuration (SYMFCT = 1, both sides input).

Shock Expansion Flow Field Control Card (5I1,5X,2F10.0)

Column Code	Routine Format	Explanation
1 IFLG(1)	FFBODY I1	Body slope flag. = 0 Use linear slope calculation. = 1 Use circular-arc calculation (routine CADA).
2 IFLG(2)	FFBODY I1	Surface data flag. = 0 A new surface line will be generated using routine MERID. = 1 Previous surface data will be used. All other shock-expansion cards are not input.
3 IFLG(3)	FFBODY I1	Solution type flag. = 0 First order shock-expansion method will be used with tangent-wedge or Prandtl-Meyer starting conditions. = 1 Second order shock-expansion method with cone flow starting solutions from A.R.C. report C.P. No. 792. = 2 Second order shock-expansion method with Jones' cone flow starting solutions. Best method for lee side flow. = 3 First order shock-expansion method with cone flow starting solutions from A.R.C. report C.P. No. 792. = 4 First order shock-expansion method with Jones' cone flow starting solutions.
4 IFLG(4)	FFBODY I1	Shock calculation flag. = 0 No shock. = 1 Shock calculation using shock-expansion. = 2 Shock calculation using empirical formulas (not active at present time).

Contrails

Shock Expansion Flow Field Control Card (continued)

Column Code	Routine Format	Explanation
5 IFLG(5)	FFBODY I1	Detail print flag. = 0 Do not print detailed data. = 1 Print detailed shock-expansion results.
11-20 X1	FFBODY F10.0	Desired forward X-limit of the flow field data.
21-30 X2	FFBODY F10.0	Desired aft X-limit of the flow field data.

Cutting Plane Control Card (10I2,I2,2I1)

This card is input only if IFLG(2) = 0.

1-2 IPANL(1)	MERID	Panel number to be used by cutting plane routine to establish surface paths for the shock-expansion calculations. A total of 10 panels may be used for one flow field calculation.
3-4 IPANL(2)	10I2	
5-6 IPANL(3)		
7-8 IPANL(4)		
9-10 IPANL(5)		
11-12 IPANL(6)		
13-14 IPANL(7)		
15-16 IPANL(8)		
17-18 IPANL(9)		
19-20 IPANL(10)		
21-22 NPL	MERID I1	Number of cutting planes to be used (≤ 36).
23 INPHI	MERID I1	Cutting plane type flag. = 0 Meridian cuts, equally spaced. = 1 Meridian cuts, position input. = 2 Parallel cuts, equally spaced. = 3 Parallel cuts, position input.
24 ISYM	MERID I1	Beta-symmetry flag. This flag is applicable only when panel geometry is symmetrical (SYMFCT = 0). = 0 Yaw angle, Beta = 0.0. = 1 Yaw angle, Beta \neq 0.0.

Contrails

Cutting Plane Origin and Orientation Card (6F10.0)

Input only if IFLG(2) = 0.

Column Code		Routine Format	Explanation
1-10	XP \emptyset	MERID F10.0	X \emptyset (scaled coordinates)
11-20	YP \emptyset	MERID F10.0	Y \emptyset
21-30	ZP \emptyset	MERID F10.0	Z \emptyset
31-40	PSI \emptyset	MERID F10.0	PSI \emptyset , ψ_0 , degrees
41-50	THET \emptyset	MERID F10.0	THET \emptyset , θ_0 , degrees
51-60	PHI \emptyset	MERID F10.0	PHI \emptyset , ϕ_0 , degrees

Meridian Planes Input Position Card (6F10.0)

Input only if IFLG(2) = 0.

This card is input only if INPHI = 1. Input 6 points per card.
The number of points is equal to NPL.

1-10	PHI(1)	MERID 6F10.0	Meridian angles in degrees. Must be in ascending order.
11-20	PHI(2)		
21-30	PHI(3)		
31-40	PHI(4)		
41-50	PHI(5)		
51-60	PHI(6)		

Use more cards until PHI(NPL) is reached.

Parallel Planes PHI Card (1F10.0)

This card is input only if INPHI = 2 or 3, and IFLG(2) = 0.

1-10	PHICD	MERID F10.0	Plane angle in degrees. (= 0.0 for parallel streamwise cuts on a wing).
------	-------	----------------	--

Contrails

Parallel Planes Input Position Cards (3F10.0)

These cards are input only if IFLG(2) = 0 and INPHI = 2 or 3. If INPHI = 2 then two of these cards will be read. If INPHI = 3 then the number of these cards must be equal to the parameter NPL input on the Cutting Plane Control Card.

<u>Column Code</u>	<u>Routine Format</u>	<u>Explanation</u>
1-10 XN	MERID	The coordinates in the reference coordinate system (body coordinates) through which the cutting plane will pass.
11-20 YN	3F10.0	
21-30 ZN		

Surface Data Transfer Option

This option is used to transfer surface data (that has been generated and stored on unit 4 by FORCE) to the flow field unit 10. This puts the data on unit 10 in the proper format ready for use in streamline calculations. This option may also be used to hand load surface data on to unit 10. The Surface Data Transfer Option is exercised only if IDTYP(1) = 2 on the Region Directory Table Card. If IRW = 1 then this option may be used to read and print out surface data previously stored on unit 10.

Flow Field Control and Plane Orientation Card (I1,I4,I1,4X,6F10.0)

This card is input only if IDTYP(1) = 2 and IRW = 0.

<u>Column Code</u>	<u>Routine Format</u>	<u>Explanation</u>
1 NSREG	FFSURF I1	Total number of sub-regions to be loaded from unit 4 to unit 10 or hand loaded (assumed at least = 1).
2-5 IFCL	FFSURF I4	Number of data points to be read. If input = 0 then the data will be read from unit 4 and loaded on to unit 10. If input \neq 0 then this number of data points (=IFCL) will be read from the input unit (hand loading of surface data).
6 ITFLAG	FFSURF I1	(not used at present time)
11-20 DAT(1)	FFSURF F10.0	X \emptyset (see Shock Expansion Flow Field option, page 82)
21-30 DAT(2)	FFSURF F10.0	Y \emptyset
31-40 DAT(3)	FFSURF F10.0	Z \emptyset
41-50 DAT(4)	FFSURF F10.0	PSI \emptyset
51-60 DAT(5)	FFSURF F10.0	THET \emptyset
61-70 DAT(6)	FFSURF F10.0	PHI \emptyset

Contrails

Hand Loaded Surface Property Data Cards

These cards are used to hand load surface property data directly on the flow field unit 10. These cards are input only if IFCL \neq 0. The general format of the cards is the same as is used for loading Flow Field Data (Flow Field Coordinate and Data Cards). Two cards are required for each data point. The first card contains the X,Y,Z coordinates and the second card has the surface velocity vector data. Each pair of cards is repeated until the required number of data points has been read in as required by the IFCL counter.

Surface Data Coordinate Card (6F10.0)

<u>Column Code</u>	<u>Routine Format</u>	<u>Explanation</u>
1-10 DATA(1)	FFSURF F10.0	X-coordinate of the surface data point.
11-20 DATA(2)	FFSURF F10.0	Y-coordinate of the surface data point.
21-30 DATA(3)	FFSURF F10.0	Z-coordinate of the surface data point.
31-40 DATA(4)	FFSURF F10.0	(not used)
41-50 DATA(5)	FFSURF F10.0	(not used)
51-60 DATA(6)	FFSURF F10.0	(not used)

Surface Data Property Card (6F10.0)

1-10 DATA(7)	FFSURF F10.0	Surface Mach number.
11-20 DATA(8)	FFSURF F10.0	X-direction cosine component of the surface velocity vector.
21-30 DATA(9)	FFSURF F10.0	Y-direction cosine component of the surface velocity vector.
31-40 DATA(10)	FFSURF F10.0	Z-direction cosine component of the surface velocity vector.
41-50 DATA(11)	FFSURF F10.0	P/P_∞ at the surface point.
51-60 DATA(12)	FFSURF F10.0	T/T_∞ at the surface point.

If this option is used, then the number of sets of these data furnished after the "Flow Field Control and Orientation Card" must be = NSREG.

Surface Data Panel Selection Card (10I2)

This card is used when surface data are to be transferred from unit 4 to unit 10 by the FFSURF routine. This card is input if IFCL = 0 on the Flow Field Control and Plane Orientation Card. The parameters input on the Surface Data Panel Selection Card identify the geometry panel numbers on unit 4 (that also have had surface data stored by the FORCE routine) that are to be grouped together to form the surface data region. In subsequent streamline calculations each surface sub-region set of data are fit at one time with the surface spline routine for interpolation purposes. It is therefore important that the geometry panels grouped together form a regular surface (one that does not have rapid local changes in character that might fool the surface spline routine and give bad interpolation values).

<u>Column Code</u>	<u>Routine Format</u>	<u>Explanation</u>
1-2 IPANL(1)	FFSURF I2	Panel number of geometry data on unit 4 (including surface velocity vector data) to be grouped to form a sub-region on the flow field storage unit 10. A total of 10 panels may be used for one sub-region.
3-4 IPANL(2)	FFSURF I2	
5-6 IPANL(3)	FFSURF I2	
7-8 IPANL(4)	FFSURF I2	
9-10 IPANL(5)	FFSURF I2	
11-12 IPANL(6)	FFSURF I2	
13-14 IPANL(7)	FFSURF I2	
15-16 IPANL(8)	FFSURF I2	
17-18 IPANL(9)	FFSURF I2	
19-20 IPANL(10)	FFSURF I2	

If this option is used, then the number of these cards is equal to NSREG.

Surface Streamline Option

The Surface Streamline Program is reached by way of sub-option calls from the Aero Executive routine. This option may be used to calculate streamlines on the vehicle surface for subsequent use in viscous computations. The streamline program makes use of surface velocity vector data that has been previously stored on the Flow Field Data Unit 10. It is, therefore, necessary that the proper options be called and executed to prepare these data before the Streamline Option is called. It is also necessary that the Streamline Option be called and executed before a Viscous Option requiring streamline data is called.

For streamline calculations to be performed it is first necessary to generate surface velocity vector data over the vehicle component being studied. One way to accomplish this is to have the velocity vector data calculated within the Inviscid Pressure Option of AERO. The Surface Data Transfer Option of the Flow Field part of the program may then be used to transfer these data from unit 4 to the proper format required on unit 10. The sequence of options required to use this approach is as follows:

1. Geometry data are generated or stored on unit 4 by the Geometry Option.
2. The Inviscid Pressure Option of AERO is then used to calculate the surface velocity vector distribution over each vehicle panel (using Newtonian theory for the velocity vector and whatever impact and shadow pressure methods desired to obtain the local Mach number, pressure, and temperature). These data are saved back on unit 4 right along with the original geometry data.
3. The Surface Data Transfer Option of the Flow Field section of the program is then used to transfer the local surface data on to the regular Flow Field Data Storage unit 10 in a format consistent with all of the other flow field data (and, therefore, suitable for use by the surface spline interpolation routines).
4. The Surface Streamline Option is then called to perform the actual streamline computations.

It is also possible to obtain the local surface property data for the streamline calculations in another manner. Or, to be more precise, it is possible to use general flow field data to obtain the local surface property information required by the streamline calculations. These general flow field data may have either been hand loaded into the program, or they may have been generated by one of the flow field calculations (i.e., the shock-expansion option). Of course, when general flow field data are used only the Boundary #1 data (surface data) are actually used in the streamline calculations, and the flow field data away from the vehicle surface are ignored. We should also keep in mind that the general flow field data may be subdivided into subregions and secondary flows because of the presence of shocks, etc.. The capabilities are, therefore, provided to use subregions collectively or selectively in the streamline calculations. A secondary flow number

Contrails

may also be input and the streamlines will only be calculated within this region. At the present time, it is not possible to have the streamline computations continue downstream through a secondary flow after they have been started within the primary flow of a subregion. The streamline computations, however, may be initiated within a secondary flow region.

It is also possible to completely hand load surface property data using the capabilities within the Flow Field Option, and to then make use of these data within the Surface Streamline Option.

The general procedure involved in generating streamlines by using the features of the Flow Field Program options to prepare the local surface property data is as follows:

1. Geometry data are generated or stored on unit 4 by the Geometry Option.
2. The Flow Field Analysis Option of AERO is used to either hand load or generate flow field data which is stored on unit 10.
3. The Streamline Option of AERO is then used to calculate the selected streamlines using only the Boundary #1 data (surface data) that has been stored on unit 10. The user must identify the subregion or secondary flow region to be used in the streamline calculations.

The end result in the use of the Streamline Option is the computation of a streamline trajectory over the vehicle surface. The data generated includes the X-Y-Z coordinates of the streamline, and the interpolated local property data (Mach number, pressure ratio, and temperature ratio). When requested by the use of an input flag these streamline data are stored back on unit 10 for subsequent use in the viscous calculations. Each separate streamline is stored under a different subregion number on the Flow Field Data Storage unit 10. The user must therefore keep track of the storage order of the streamlines so that he can retrieve the desired lines when he is over in the viscous option.

Contrails

Surface Property Access Flag Card (I1,3I2,3I1,10I2,I1)

Column Code	Routine Format	Explanation
1	LASTR STREAM I1	Last flow region flag. = 0 This is not the last streamline set of data. After all the streamline data cards are read and streamlines calculated, routine STREAM will expect to read another Surface Property Access Flag Card. = 1 This is the last streamline set of data. A return to the AERO routine will be made after all the streamlines are calculated.
2-3	NDSET STREAM I2	Data set number where surface data properties will be found on unit 10.
4-5	IABSET STREAM I2	α - β set number where surface data properties will be found on unit 10.
6-7	IR STREAM I2	Flow region number where surface data properties will be found on unit 10.
8	INORM STREAM I1	Normalization flag for surface property spline interpolation. The surface property data are stored at varying X,Y,Z locations. However, it is usually best to convert the X-Y-Z coordinates to some combination of other coordinates for the spline interpolation (axial distance, A; radial distance, R; radial angle, ϕ). For example, on a body of revolution A and ϕ would be best. For a wing, X and Y. For a vertical tail, X-Z. The available flags are: = 0 $\phi = \text{fn}(A,R)$ = 1 $Z = \text{fn}(X,Y)$ (i.e., wings) = 2 $Y = \text{fn}(X,Z)$ (i.e., vertical tails) = 3 $X = \text{fn}(Y,Z)$ = 4 $R = \text{fn}(A,\phi)$ (i.e., body of revolution)
9	ISURF STREAM I1	Surface boundary normalization flag. This flag determines how the normalization data input on the next card will be used by the program in the normalization for the spline interpolation and for establishing the boundary limits for the interpolation.

Contrails

Surface Property Access Flag Card (continued)

Column Code	Routine	Format	Explanation
9	ISURF	STREAM I1	<p>= 0 The input values for XB(1),YB(1),ZB(1) and XB(2),YB(2),ZB(2) will be used to establish the normalization limits for the first variable (i.e., if INORM = 4, they will determine the limits of the axial distance, A). The input values for XB(3),YB(3),ZB(3) and XB(4),YB(4),ZB(4) will be used to establish the normalization limits for the second variable (i.e., if INORM = 4, they will determine the limits of the angular coordinate, ϕ).</p> <p>= 1 The surface is assumed to be of a wing or tail type and the XB,YB,ZB normalization limits input on the next cards will be used to establish a chordwise-spanwise normalization. The point XB(1),YB(1),ZB(1) is the leading edge point of the root chord, and the point XB(2),YB(2),ZB(2) is the trailing edge at the root. The point XB(3),YB(3),ZB(3) is the tip leading edge, and XB(4),YB(4),ZB(4) is the tip trailing edge.</p>
10	IPF	STREAM I1	<p>Primary flow flag.</p> <p>= 0 Streamlines will be calculated using flow data on unit 10 as stored by the Surface Data Transfer Option, or the primary flow of the data stored by the Flow Field Analysis Option.</p> <p>= 1 Streamlines will be calculated using flow data on unit 10 as stored by the Flow Field Analysis Option for the secondary flow number input as ISF(1) below.</p>
11-12	ISR(1)	STREAM	<p>Subregion flow number where surface data properties will be found on unit 10.</p> <p>If ISR(1) = 0, all subregions associated with flow region IR (CC 6-7) will be used.</p>
13-14	.	10I2	
15-16	.		
17-18	.		
19-20	.		
21-22	.		
23-24	.		
25-26	.		
27-28	.		
29-30	ISR(10)		
31	ISF(1)	STREAM I1	<p>Secondary flow number where surface data will be found on unit 10. Used only if IPF = 1 (CC 10). Only ISF(1) is active for streamline calculations.</p>

Contrails

Normalization Data Cards (3F10.0)

Four cards are required that contain the coordinates for the data normalization limit process in the spline interpolation. The meaning of the four points is determined by the parameter ISURF on the preceding card.

<u>Column Code</u>	<u>Routine</u>	<u>Explanation</u>
	<u>Format</u>	
1-10 XB(i)	STREAM F10.0	XB coordinate.
11-20 YB(i)	STREAM F10.0	YB coordinate.
21-30 ZB(i)	STREAM F10.0	ZB coordinate.
	i = 1 to 4	

Streamline Identification And Title Card (2I2,16X,10A4)

1-2 IRSAVE	STREAM I2	Streamline save flap. = 0 do not save. ≠ 0 Flow region number where streamline data will be saved on unit 10. The streamline data will be saved under the same NDSET and IABSET numbers as were used for the surface property data. Normally, IRSAVE should not be the same as IR.
3-4 NSTR	STREAM I2	Number of streamlines to be calculated. This number of streamline data cards must be present right after the normalization Data Cards. (This number of streamline space will be reserved on the storage unit even though all of them may not be saved.
21-60 TITLER	STREAM 10A4	Title for the streamline flow region number IRSAVE.

Note: Each calculated streamline that is to be saved will be placed in a different sub-region under the flow region IRSAVE.

Contrails

Streamline Data Cards (2I2,3I1,I2,14,7X,4F10.0)

One Streamline Data card is required for each streamline to be calculated. The number of streamlines and Streamline Data Cards to be input is determined by the parameter NSTR on the Region Identification and Normalization Flag Card.

Column Code	Routine Format	Explanation
1-2	I PRINT	STREAM I2 Streamline print flag. = 0 Do not print out streamline data. = 1 Print streamline data for every DELTAS point. = 2 Print streamline data for every second DELTAS point. = 3 Print streamline data for every third DELTAS point. etc.
3-4	I SAVE	STREAM I2 Streamline save flag. = 0 Do not save streamline data on the flow field unit 10. = 1 Save every streamline DELTAS data point on unit 10 under region IRSAVE. = 2 Save every second streamline DELTAS data point on unit 10. = 3 Save every third streamline DELTAS data point on unit 10. etc.
5	I START	STREAM I1 Streamline starting condition flag. = 0 Start streamline calculations at the centroid of the given element number on the specified panel number. = 1 Start the streamline calculations at the given X,Y,Z location. = 2 Continue from a previously calculated streamline. (not active at present time)
6	I STAG	STREAM I1 Stagnation point calculation flag. = 0 Start streamline at given point. Do not calculate stagnation point. = 1 Calculate stagnation point and start streamline calculations from that point. (not active at present time)

Contrails

Streamline Data Cards (continued)

<u>Column Code</u>	<u>Routine</u>	<u>Explanation</u>
	<u>Format</u>	
7 ISMODE	STREAM I1	Streamline mode calculation flag. = 0 To calculate streamline integrate in the transformed plane with two variables and interpolate for the third surface variable to keep the streamline on the surface. = 1 To calculate streamline integrate using all three coordinates (X,Y,Z integration). The streamline may leave the surface.
8-9 IPANL	STREAM I1	Panel number on unit 4 for the start of the streamline. Used if ISTART = 0.
10-13 L	STREAM I4	Element number in panel IPANL for the start of the streamline. Used if ISTART = 0.
21-30 DELTAS	STREAM F10.0	Streamline integration distance step interval for the Runge-Kutta integration process. (may be negative to integrate forward)
31-40 XSI	STREAM F10.0	X-coordinate of the streamline starting point. Used if ISTART = 1.
41-50 YSI	STREAM F10.0	Y-coordinate of the streamline starting point. Used if ISTART = 1.
51-60 ZSI	STREAM F10.0	Z-coordinate of the streamline starting point. Used if ISTART = 1.

SHIELDING PROGRAM INPUT DATA

The Shielding Program may be used to account for the situation where one part of a vehicle shape is shielded from the freestream flow by another part of the vehicle. The geometry data for use by the Shielding program must be stored and available on the Quadrilateral Element Storage unit (4). The Geometry Options must be used to accomplish this.

Before the Shielding Program is used on a given vehicle the user should have the Picture Drawing Program generate pictures at each of the α - β conditions to be analyzed for shielding. This will provide the user with the information as to what part of the vehicle is being shielded by what other parts. From these pictures the user should make a list of numbers of each Panel of the vehicle that will experience some shielding. For each shielded Panel a list should also be made of what other vehicle Panels cause the shielding. These lists of numbers will be input on the shielding input data cards to reduce the amount of time that will be required to perform the shielding searches.

The Shielding Program will perform it's shielding search and will generate and store a special set of quadrilateral elements. These special quadrilateral elements will have negative surface areas and taken all together will represent those parts of the vehicle that are shielded by some other upstream part. The negative area shielded elements are stored on Unit 3. One set of negative area elements will be stored for each α - β specified on the input the AERO executive routine. When the FORCE program calculates the pressures on the vehicle it will proceed in a normal manner until all of the normal vehicle elements are accounted for. It will then turn to the negative area shielded elements and calculate the pressures also in a perfectly usual manner, except that the element areas used will be negative. In this manner the shielded parts of the vehicle will be effectively removed from the analysis and will have no contributions to the final vehicle forces.

Shielding Title Control Card

(I2,I1,I2,15A4)

<u>Column Code</u>	<u>Routine Format</u>	<u>Explanation</u>
1-2 NPANL	SHIELD I2	The total number of PANELS to be considered and analyzed for shielding.
3 IPRINT	SHIELD I1	Print flag. = 0 Do not print negative area shielded elements. = 1 Print characteristics of the negative area quadrilateral elements.
4-5 INAB	SHIELD I2	Angle of attack analysis control flag. (not used in present program)
6-65 TITLE	SHIELD 15A4	Title for print out on shielding print pages.

Contrails

Shielding Panel Control Card (I2,20I2)

The number of these cards to be read must be = NPANL as specified on the Shielding Title Control Card.

<u>Column Code</u>	<u>Routine Format</u>	<u>Explanation</u>
1-2 IPAN	SHIELD I2	The sequence number of the Panel to be considered for shielding.
3-4 ISHE(1)	SHIELD	The sequence number of the Panel that is to be considered as a possible shielding panel. Up to a total of 20 such Panel numbers may be specified on each of these Shielding Panel Control Cards.
5-6 ISHE(2)	20I2	
7-8 ISHE(3)		
etc.		

PRESSURE CALCULATION PROGRAM INPUT DATA

The Pressure Calculation Program is reached by way of sub-option calls from the Aero Executive routine. The sequence of calls to the FORCE routine and the saving and summation of force data is accomplished in routine PRES. The geometry data for use by the PRES and FORCE routines must be stored and available on the Quadrilateral Element Storage unit (4). The Geometry Options must be used to accomplish this storage. An input to routine PRES specifies how the vehicle Panels are to be grouped to form vehicle Components for the force analysis. These selections are made by using the Panel sequence numbers assigned by the Geometry program (the Panels are numbered in the order in which they are placed on the Quadrilateral Element Storage unit (4)).

Title Card and Basic Flags (I2,I1,3X,15A4)

<u>Column Code</u>		<u>Routine Format</u>	<u>Explanation</u>
1-2	NCOMP	PRES I2	Total number of vehicle Components to be analyzed. Each Component may consist of one or more vehicle Panels. The grouping of Panels to form Components is controlled by the Component Organization Card below. (20 maximum)
3	IFSAVE	PRES I1	Force data save flag. = 0 Set up a new Unit 9 Force Data save file. Save component force data. = 1 Save force data. Use existing Unit 9 Force Data file and just add a new set to it. = 2 Do not save force data.
7-66	TITLE	PRES 15A4	Title to be printed out at the top of the force data output.

Component Organization Card (10I2,3I1)

1-2	IPANL(1)	PRES 10I2	The identification numbers for all of the Panels on the Quadrilateral Element Storage unit (4) that are to be grouped together to form this vehicle Component. Up to a maximum of 10 Panels may be grouped together to form a Component. All the elements in a given Component will be analyzed using the same pressure calculation method.
3-4	IPANL(2)		
5-6	IPANL(3)		
etc.			
19-20	IPANL(10)		

Note: The number of sets of Component Organization, Pressure Method Cards, and Interference Method Cards must be = NCOMP.

Contrails

Component Organization Card (continued)

<u>Column Code</u>	<u>Routine Format</u>	<u>Explanation</u>
21	IPM	PRES I1
		Pressure Method card flag. = 0 Pressure Method cards will be read for each α - β . = 1 Read only one Pressure Method card and assume that it will apply for all the α - β 's for this component. = 2 Use the same pressure method data set as was used for the previous vehicle Component. No Pressure Method cards will be input.
22	INT	PRES I1
		Interference method card flag. = 0 No interference cards will be read. Interference effects will not be accounted for in the force calculations. = 1 Interference method cards will be read for each α - β for this component. = 2 Read only one interference method card and assume that it will apply for all the α - β 's for this component. = 3 Use the same interference method data set as was used for the previous vehicle Component. No interference method cards will be input.
23	ISHEF	PRES I1
		Shielding elements flag. = 0 Shielding elements have not been generated for this component and shielding effects will therefore not be accounted for. = 1 Shielding elements have been generated and are stored on unit 3. Shielding effects should be accounted for on this vehicle Component.

Contrails

Pressure Method Cards (2I2, 3I1, 3X, 6F10.0)

The Pressure Method Cards are used to specify what pressure calculation methods are to be used for each vehicle Component. The necessary constants for each pressure method are also input on these cards. The number of Pressure Method Cards to be input is controlled by the parameter IPM on the Component Organization Card. If IPM = 0 then the number of Pressure Method Cards must be equal to the parameter NAB as input on the Flight Condition Card to the AERO executive routine.

The general format for the Pressure Method Cards is given below.

<u>Column Code</u>	<u>Routine Format</u>	<u>Explanation</u>
1-2 IMPACT	PRES I2	Impact force-calculation method flag. The following methods are available for calculation of pressures on surface elements in impact flow (right-justified integer). = 1 Modified Newtonian (K is input in CC 11-20). = 2 Modified Newtonian + Prandtl-Meyer (CC 31-40 must contain the proper value for η_c). = 3 Tangent-wedge (using oblique-shock). = 4 Tangent-wedge empirical. = 5 Tangent-cone. = 6 Inclined-cone method. See discussion in Volume II. = 7 Van Dyke Unified Method (small disturbance theory). = 8 Blunt-body skin-friction shear-force contributions to the aero forces. The deck set-up is just like a regular pressure calculation run. The aero forces obtained must be added to the forces calculated using one of the other force calculation methods (usually modified Newtonian). = 9 Shock-expansion Method using strip theory. The parameter IORN on the Panel Identification Card in the Geometry Option identifies which edge of the panel is the leading edge. IORN may be = 0 or 1 only.

Contrails

Pressure Method Cards (continued)

Column Code	Routine Format	Explanation
1-2	IMPACT (continued)	<p>=10 Free-molecular flow. Input f_n in CC 11-20, f_t in CC 41-50, and T_B/T_∞ in CC 31-40. See Volume II free-molecular discussion.</p> <p>=11 Input constant pressure coefficient (use CC 11-20 for the pressure coefficient). A constant pressure coefficient will be applied over all elements.</p> <p>=12 Hankey flat-surface empirical.</p> <p>=13 Delta-wing empirical.</p> <p>=14 Dahlem-Buck empirical.</p> <p>=15 Blast-wave pressure increments. For axisymmetric flow input 0.0 in CC 11-20. For planar flow input 1.0 in CC 11-20. An input number is also required in CC 31-40 (see discussion for PDATA(3)). The parameter X_0 for the blast wave calculations must be input in CC 41-50.</p>
3-4	ISHAD PRES I2	<p>Shadow force-calculation method flag. The following methods are available for calculation of pressures on surface elements in shadow flow (right-justified integer).</p> <p>= 1 Newtonian (i.e., $C_p = 0.0$).</p> <p>= 2 Modified Newtonian + Prandtl-Meyer (CC 31-40 must contain the proper value for η_c).</p> <p>= 3 Prandtl-Meyer expansion from free-stream.</p> <p>= 4 Inclined cone method. See discussion in Volume II.</p> <p>= 5 Van Dyke Unified Method (small disturbance).</p> <p>= 6 High Mach number base pressure ($C_p = -1/M^2$).</p> <p>= 7 Shock-expansion (strip theory). See IMPACT = 9 discussion.</p> <p>= 8 Input pressure coefficient (use CC 11-20 for the input pressure coefficient).</p> <p>= 9 Free-molecular flow. See IMPACT = 10 for other input requirements.</p>

Pressure Method Cards (continued)

Column Code	Routine Format	Explanation
5	IPRINT PRES 11	<p>Print flag. This flag controls the printing of the detailed force characteristics of each vehicle element.</p> <p>= 0 Do not print detailed element force data.</p> <p>= 1 Print detailed force contributions for each element (a large amount of output will be produced and machine time will increase).</p> <p>= 2 Print detailed local property calculation and iteration results.</p>
6	IPIN PRES 11	<p>Non-uniform input C_p table flag.</p> <p>= 0 Input C_p table will not be used</p> <p>= 1 Input C_p table will be used. Input Pressure Option Cards will be input. IMPACT and ISHAD parameters will be ignored. This option may be used to input wind tunnel pressure data in order to obtain resultant vehicle forces.</p> <p>= 2 The non-uniform C_p table that has been previously generated by the Second-Order Shock-Expansion method (of the Flow Field Option) will be used over the surface of the vehicle component. IMPACT and ISHAD parameters will be ignored. Input Pressure Option Cards will be expected. This is the way provided in the program in which the Second-Order Shock-Expansion method can be used as a pressure calculation method.</p>
7	ISAVE PRES 11	<p>Save surface property data flag.</p> <p>= 0 Do not save the surface property data (local surface Mach number, P/P_∞, T/T_∞, etc.).</p> <p>= 1 Save surface property data on unit 4. <u>This option must be used to store data that is required by the skin friction options.</u> These data may also be used in the Surface Data Transfer Option and later in the Streamline Option.</p>

Contrails

Pressure Method Cards (continued)

Column Code	Routine Format	Explanation
11-20 PDATA(1)	PRES F10.0	<p>Pressure method input parameters. The input parameter in this field will vary depending upon the pressure method option selected.</p> <p>For IMPACT = 1, 2, or 3 input the modified Newtonian correction factor, K (CPSTAG).</p> <p>For IMPACT = 10 input the free-molecular flow parameter, f_n.</p> <p>For IMPACT = 11 input a constant pressure coefficient, C_p.</p> <p>For IMPACT = 15 input 0.0 for axisymmetric flow or 1.0 for plan flow.</p>
21-30 PDATA(2)	PRES F10.0	<p>QQINF. Dynamic pressure (q) at the surface divided by the freestream q.</p> $C_{p\infty} = C_p (q/q_\infty)$ <p><u>Must be input as 1.0 if no change from free-stream is to be made.</u> This parameter is useful in removing the effect of a vehicle component or in changing the local q for a whole component because of a constant q/q∞ effect of an interference component.</p>
31-40 PDATA(3)	PRES F10.0	<p>This field is used for several different input parameters depending upon the values of the impact and shadow pressure calculation method flags.</p> <p>= Prandtl-Meyer expansion correction factor η_c (ETAC) in the following equation.</p> $C_p = \frac{P\eta_c - P_\infty}{q_\infty}$ <p>This is used when IMPACT = 2 or ISHAD = 2 but is usually input as 1.0.</p> <p>= Input pressure coefficient in shadow regions when ISHAD = 8.</p> <p>= T_B/T_∞ for IMPACT = 10. T_B/T_∞ is the ratio of body temperature to freestream temp.</p> <p>= For IMPACT = 15 (blast wave) and axisymmetric flow input $\sqrt{C_D} \cdot D$ (square root of drag coefficient times the sphere diameter). For plane flow input $C_D^{2/3} d^{2/3}$ (where C_D is the drag coefficient of a cylinder and d is the cylinder diameter).</p>

Pressure Method Cards

(continued)

Column Code	Routine Format	Explanation
41-50 PDATA(4)	PRES F10.0	<p>ENPM. Surface slope modification factor. If input as $\neq 0.0$ the surface slope (θ, angle between outward surface normal and velocity vector) will be divided by this number. The impact angle (δ) is calculated as follows:</p> $\delta = \pi/2 - \theta_{\text{input}}/\text{ENPM}$ <p>If ENPM is input as -0.0 or 1.0 then the body slope is not changed.</p> <p>This location has an alternate use when IMPACT is input as $= 10$.</p> <p>$= f_t$ (tangential momentum accomodation coefficient, -0.0 for Newtonian flow and 1.0 for completely diffuse reflection).</p>
51-60 PDATA(5)	PRES F10.0	<p>IMPACI. Impact method for Shock-expansion calculations. This flag controls the method to be used in the calculation of the pressure and local properties on the first element of each streamwise strip for subsequent shock-expansion calculations. The available methods are listed below. This field is used only when IMPACT = 9.</p> <p>$= 3.0$ Tangent-wedge (oblique shock).</p> <p>$= 5.0$ Tangent-cone.</p> <p>$= 13.0$ Delta-wing empirical.</p>
61-70 PDATA(6)	PRES F10.0	<p>ISHADI. Shadow method for Shock-Expansion calculations. This flag controls the method to be used in the calculation of the pressure and local properties on the first element of each streamwise strip for subsequent shock-expansion calculations (if the first element is in a shadow region). This field is used only when ISHAD = 7. The only acceptable method at the present time is</p> <p>$= 3.0$ Prandtl-Meyer expansion from freestream.</p>

Interference Method Cards

The Interference Method Cards are used to specify the type of interference computations that are to be used for each vehicle component. The number of Interference Method Cards to be input is controlled by the parameter INT on the Component Organization Card. If INT = 0 then no Interference Method Cards are input. If INT = 1 then the number of Interference Method Cards must be equal to the parameter NAB as input on the Flight Condition Card to the AERO executive routine. See the description of the INT parameter for further information.

The Interference Method Cards actually serve two purposes. If the flow field to be used in the interference calculations by the FORCE routine is uniform (not a function of X,Y,Z) then the flow field data may be input directly on the Interference Method Cards. If the flow field is not uniform then the flow field data must be obtained directly from the flow field data storage unit (10). The data may be placed on the storage unit either by the use of the Flow Field Data Hand-Load option, or they may be generated by one of the flow field generation routines. The Interference Method Cards are used to specify and control the source of the interference flow field data to be used by the FORCE program.

Interference Method Control Card (10I1,12I2)

Column Code	Routine Format	Explanation
1	INF(J,1) (J is the α - β counter)	PRES I1 Interference data source flag. = 0 The flow field is uniform and the flow field data will be input on this card as the DINF(J,I) array. = 1 The flow field is uniform but the flow field data will be obtained off of the flow field data storage unit (10). No interpolation is required. = 2 The flow field data is non-uniform and they must be obtained from the flow field data storage unit. The data will be interpolated to find the local flow field for each of the element centroids.
2	INF(J,2)	PRES I1 Flow field data set number (NSET) on the flow field data storage unit to be used for this vehicle component.
3	INF(J,3)	PRES I1 Alpha-Beta set number of the flow data set (IABSET) to be used for interference.
4	INF(J,4)	PRES I1 Not used at present time.
5	INF(J,5)	PRES I1 Not used at present time.

Contrails

Interference Method Control Card (continued)

<u>Column</u>	<u>Code</u>	<u>Routine Format</u>	<u>Explanation</u>
6	INF(J,6)	PRES I1	Not used at present time.
7	INF(J,7)	PRES I1	Not used at present time.
8	INF(J,8)	PRES I1	Not used at present time.
9	INF(J,9)	PRES I1	Not used at present time.
10	INF(J,10)	PRES I1	Not used at present time.

Up to 4 different flow region sets of data may be specified for possible use with a given vehicle component. Each region set of data may contain flow field data at one or more meridian cuts (identified by a sub-region number). The data for each sub-region may also have secondary flow regions. The pointer information for retrieving the proper flow field data is supplied in the following card columns.

11-12	INF(J,11)	PRES I2	First flow field region number.
13-14	INF(J,12)	PRES I2	Sub-Region number.
15-16	INF(J,13)	PRES I2	Secondary flow number.
17-18	INF(J,14)	PRES I2	Second flow field region number.
19-20	INF(J,15)	PRES I2	Sub-Region number.
21-22	INF(J,16)	PRES I2	Secondary flow number.
23-24	INF(J,17)	PRES I2	Third flow field region number.
25-26	INF(J,18)	PRES I2	Sub-Region number.
27-28	INF(J,19)	PRES I2	Secondary flow number.
29-30	INF(J,20)	PRES I2	Fourth flow field region number.
31-32	INF(J,21)	PRES I2	Sub-Region number.
33-34	INF(J,22)	PRES I2	Secondary flow number.

Contrails

Uniform Flow Field Card (6F10.0)

This card must be input if $INF(J,1) = 0$.

<u>Column Code</u>	<u>Routine Format</u>	<u>Explanation</u>
1-10 DINF(J,1)	PRES F10.0	M_{local}
11-20 DINF(J,2)	PRES F10.0	X direction cosine component of local velocity vector.
21-30 DINF(J,3)	PRES F10.0	Y direction cosine component of local velocity vector.
31-40 DINF(J,4)	PRES F10.0	Z direction cosine component of local velocity vector.
41-50 DINF(J,5)	PRES F10.0	P/P_{∞}
51-60 DINF(J,6)	PRES F10.0	T/T_{∞}

Note: The subscript J in the above parameters is the angle of attack counter.

Input Pressure Option

The Input Pressure Option Cards are used when the vehicle component forces are to be calculated using pressure data previously stored on the flow field data unit 10. This option may be used in several ways. For example, the forces on a particular component may be calculated using experimental results which have been previously stored on unit 10 by use of the Flow Field Data Hand-Load Option. More directly, forces may be determined using the data generated by the Shock-Expansion Flow Field Option and stored on unit 10.

In either case, pressure data is available at a limited number of discrete locations on the component. The forces are calculated by summing the contributions of all the elements that make up the component. The function of the Input Pressure Option is to obtain the value of pressure at the centroid of each element. This is accomplished by interpolation using the Surface Spline method and, as in the other applications of this method, proper normalization of the coordinates is required to obtain meaningful results. The use of the Input Pressure Option is controlled by the parameter IPIN on the Pressure Method Cards. If IPIN = 0, no Input Pressure Cards are read: If IPIN = 1 or IPIN = 2, then a set of Input Pressure Option Cards will be required. Since the parameter IPIN is used for each α - β , a set of Input Pressure cards will be needed for each α - β for which IPIN is on (=1 or =2).

A set of Input Pressure Option Cards consists of five cards; a Surface Property Access Flag Card and four Normalization Data Cards. The format of these cards is very similar to those used for the Surface Streamline Option.

Surface Property Access Flag Card (I1,3I2,3I1,10I2,5I1)

Column Code	Routine Format	Explanation
1	LASTR CPINPT I1	(Not active)
2-3	NDSET CPINPT I2	Data set number where surface data properties will be found on unit 10.
4-5	IABSET CPINPT I2	α - β set number where surface data properties will be found on unit 10.
6-7	IR CPINPT I2	Flow region number where surface data properties will be found on unit 10.
8	INORM CPINPT I1	Normalization flag for surface property spline interpolation. The surface property data are stored at varying X,Y,Z locations. However, it is usually best to convert the X-Y-Z coordinates to some combination of other coordinates for the spline interpolation (axial distance, A; radial distance, R; radial angle, ϕ).

Contrails

Surface Property Access Flag Card (continued)

Column Code	Routine Format	Explanation
		For example, on a body of revolution A and ϕ would be best. For a wing X and Y. For a vertical tail, X-Z. The available flags are: = 0 $\phi = \text{fn}(A,R)$ = 1 $Z = \text{fn}(X,Y)$ (i.e., wings) = 2 $Y = \text{fn}(X,Z)$ (i.e., vertical tails) = 3 $X = \text{fn}(Y,Z)$ = 4 $R = \text{fn}(A,\phi)$ (i.e., body of revolution)
9	ISURF CPINTP I1	Surface boundary normalization flag. This flag determines how the normalization data input on the next card will be used by the program in the normalization for the spline interpolation and for establishing the boundary limits for the interpolation. = 0 The input values for XB(1),YB(1),ZB(1) and XB(2),YB(2),ZB(2) will be used to establish the normalization limits for the first variable (i.e., if INORM = 4, they will determine the limits of the axial distance, A). The input values for XB(3),YB(3),ZB(3) and XB(4),YB(4),ZB(4) will be used to establish the normalization limits for the second variable (i.e., if INORM = 4, they will determine the limits of the angular coordinate, ϕ). = 1 The surface is assumed to be of a wing or tail type and the XB,YB,ZB normalization limits input on the next cards will be used to establish a chordwise-spanwise normalization. The point XB(1),YB(1),ZB(1) is the leading edge point of the root chord, and the point XB(2),YB(2),ZB(2) is the trailing edge at the root. The point XB(3),YB(3),ZB(3) is the tip leading edge, and XB(4),YB(4),ZB(4) is the tip trailing edge.
10	IPF CPINPT I1	Primary flow flag. Not used in present program. IPF is set = 1 by the program.

Surface Property Access Flag Card (continued)

Column Code	Routine Format	Explanation
11-12	ISR(1)	Subregion flow number where surface data properties will be found on unit 10. If ISR(1) = 0, all subregions associated with flow region IR (CC 6-7) will be used.
13-14	.	
15-16	.	
17-18	.	
19-20	.	
21-22	.	
23-24	.	
25-26	.	
27-28	.	
29-30	ISR(10)	
31	ISF(1) CPINPT 5I1	Secondary flow number where surface data will be found on unit 10.
32	ISF(2)	The secondary flow numbers must be input to be considered and if indicated, will be used with both IPF = 0 and IPF = 1.
33	ISF(3)	
34	ISF(4)	
35	ISF(5)	

Normalization Data Cards (3F10.0)

Four cards are required that contain the coordinates for the data normalization limit process in the spline interpolation. The meaning of the four points is determined by the parameter ISURF on the preceeding card.

1-10	XB(i)	CPINPT F10.0	XB coordinate
11-20	YB(i)	CPINPT F10.0	YB coordinate
21-30	ZB(i)	CPINPT F10.0	ZB coordinate

i = 1 to 4

Contrails

VISCOUS PROGRAM OPTION

The Viscous Program Option is reached by way of sub-option calls from the AERO executive routine. Routine VISCUS is the control routine for the viscous calculations and is similar to the PRES routine used in the Inviscid Option of the program. The Viscous Option makes use of surface property data (local pressure, temperature, and Mach number) that has been previously calculated by the Inviscid FORCE routine for the geometry being studied.

Skin Friction Basic Flag and Title Card (I2,I1,3X,15A4)

<u>Column Code</u>	<u>Routine</u>	<u>Format</u>	<u>Explanation</u>
1-2 NCOMP	VISCUS	I2	Total number of vehicle Components to be analyzed. Each Component may consist of one or more vehicle Panels. The grouping of Panels to form Components is controlled by the Geometry Data Source Card.
3 IFSAVE	VISCUS	I1	Force data save flag. = 0 Set up a new force data save file (unit 9). Save skin friction force data for future summation. = 1 Save skin friction force data for future summation on unit 9. Use old unit 9 file and just add the new force data on to the file. = 2 Do not place the force data on the force data file unit.
7-66 TITLE	VISCUS	15A4	Title to be printed out on the skin friction output pages.

Geometry Data Source Card (10I2,²⁰3I1,¹I3) (7)

1-2 IPANL(1) etc.	VISCUS	10I2	The identification numbers for all of the Panels on the Quadrilateral Element Storage unit (4) that are to be grouped together to form this vehicle Component.
39-40 IPANL(10)			
41 ISK	VISCUS	I1	Skin Friction Method Card flag. = 0 Skin Friction Method cards will be read for each α - β . = 1 Read only one Skin Friction Method Card and assume that it will apply for all of the α - β 's for this component. = 2 Use the same Skin Friction Method data set as was used for the previous vehicle component (no Skin Friction Method Cards will be read).

Contrails

Geometry Data Source Card (continued)

<u>Column Code</u>	<u>Routine Format</u>	<u>Explanation</u>
42-44 NS	VISCUS I3	Number of skin friction elements to be analyzed. This number must be equal to the number of elements on the Quadrilateral Element save unit 4 for this vehicle component and must not be greater than 100. The number of Skin Friction Element Data Cards must be = NS. This input is used for the Mark III skin friction option only.

Skin Friction Method Cards (3I1)

These cards control the method to be used in calculating the skin friction coefficients used in the skin friction computations. The number of these cards is controlled by the ISK flag on the Component Organization Card.

<u>Column Code</u>	<u>Routine Format</u>	<u>Explanation</u>
1 ISFMTH	VISCUS I1	Skin friction method flag. = 0 Use Integral Method Boundary Layer Program. The wall temperature, if it is not input, will be calculated by the old Mark III skin friction methods. Cards for the Integral Method will be expected next. The old Mark III Skin Friction Element Data Cards will not be input. = 1 Calculate skin friction coefficients using the old Mark III program methods. Mark III Skin Friction Element Data Cards will be expected next.
2 IPRINT	VISCUS I1	Print flag when old Mark III skin friction has been used (ISFMTH = 1). = 0 Do not print. = 1 Print detailed skin friction computation intermediate results.
3 ISAVE	VISCUS I1	Skin friction coefficient data save flag. = 0 Do not save. = 1 Write skin friction coefficient and wall temperature results on each element back out on to unit 4 along with the previously saved surface data. This option only used if ISFMTH = 0.

INTEGRAL METHOD BOUNDARY LAYER INPUT DATA

The Integral Method Boundary Layer Program is reached when the Skin Friction Method Card has the parameter ISFMTH = 0. The Integral Method Boundary Layer Program requires that surface streamline data as previously calculated by the Streamline Option of AERO be available. The Integral Method Program calculates skin friction along these streamlines and stores the results on the Surface Data Storage Unit 10 right with the streamline surface data. These data are then fit with the surface spline techniques and the skin friction coefficient determined by interpolation for each surface geometry element for all the panels specified by the IPANL parameters. By using this method the skin friction distribution over the complete surface of a vehicle may be calculated (skin friction calculated over the same geometry data set as was used for the inviscid pressure calculations). In most applications, however, it will be best to make use of some combination of both the old Mark III Skin Friction option and the new Integral Method in the analysis of a typical vehicle. The Mark III Skin Friction option should be used when possible because of the shorter computing times. The Integral Method should be used only in situations where more detailed skin friction information is needed over the complete surface of a given component.

Streamline Data Source Card (I1,3I2)

<u>Column Code</u>	<u>Routine</u>	<u>Explanation</u>
	<u>Format</u>	
1	LASTR	INTEG
		I1
		Last flow region flag.
		= 0 This is not the last Streamline Data Source Card. After all the skin friction data are calculated for this set of cards another Streamline Data Source Card will read in.
		= 1 This is the last Streamline Data Source Card. After all the skin friction data are calculated for this set of cards, the program will return to the VISCUS routine.
2-3	NDSET	INTEG
		I2
		Data set number where streamline data will be found on unit 10.
4-5	IABSET	INTEG
		I2
		α - β set number where streamline data will be found on unit 10.
6-7	IR	INTEG
		I2
		Flow region number where streamline data will be found on unit 10.

Contrails

Integral Skin Friction Method Control Card (3I1,7X,3F10.0)

This card always follows the Streamline Data Source Card.

<u>Column Code</u>	<u>Routine Format</u>	<u>Explanation</u>
1	ISFM	INTEG I1
		Skin friction coefficient calculation method flag. = 0 Use the Integral Boundary Layer method for calculating the skin friction coefficient along the streamline. An Integral Method Flag Card will follow this card. = 1 Do not use the Integral Method for the skin friction calculations. Instead use the skin friction coefficients as calculated by subroutine TEMP. This is the same routine that is used to calculate the wall temperature for the old Mark III Skin Friction option (and as also used to get wall temperature for the Integral Boundary Layer method). This will give basically the same skin friction results as for the old Mark III option, but the viscous-inviscid interaction effect that is calculated in the Mark III option will not be accounted for. Calculations will be made for each point along the streamline. The Integral Method Flag Card will <u>not</u> be used and will not be input.
2	IWT	INTEG I1
		Wall temperature method flag. This flag controls the selection of the method to be used in calculating the wall temperature in routine TEMP. This flag is used for both ISFM = 0 and = 1. When ISFM = 1 it also controls the skin friction coefficient calculation procedure selection. In the discussions below the methods to be used for laminar and turbulent flow are separated by a slash (i.e., Laminar/Turbulent). = 0 Use Reference Temperature/Spalding-Chi methods to calculate temperature. = 1 Use Adiabatic wall temperature and Reference Temperature/Spalding-Chi methods. = 2 Use input wall temperature and Reference Temperature/Spalding-Chi methods. Wall temperature is input in CC 11-20 and CC 21-30.

Contrails

Integral Skin Friction Method Control Card (continued)

<u>Column Code</u>	<u>Routine Format</u>	<u>Explanation</u>
2	IWT (continued)	<ul style="list-style-type: none">= 3 Use Reference Enthalpy/Spalding-Chi (with enthalpy ratios) methods.= 4 Use adiabatic wall temperature and Reference Enthalpy/Spalding-Chi (with enthalpy ratios) methods.= 5 Use input wall temperature and Reference Enthalpy/Spalding-Chi (with enthalpy ratios) methods. Wall temperature is input in CC 11-20 and CC 21-30.= 6 Use Reference Temperature/Reference Temperature methods.= 7 Use input wall temperature and Reference Temperature/Reference Temperature methods. Wall temperature is input in CC 11-20 and CC 21-30.= 8 Use Reference Enthalpy/Reference Enthalpy methods.= 9 Use input wall temperature and Reference Enthalpy/Reference Enthalpy methods. Wall temperature is input in CC 11-20 and CC 21-30.
3	IPRINT	INTEG I1
		Iteration and local skin friction print flag for use in routine TEMP. <ul style="list-style-type: none">= 0 Do not print.= 1 Print iteration results for wall temperature and the final local skin-friction data in routine TEMP.= 2 Print the final local skin-friction data in routine TEMP but do not print the iteration results. This is the recommended option for most applications where you want to see the skin friction results along a streamline.
11-20	SURFI6	INTEG F10.0
		Input wall temperature for laminar calculations, °R. This input is used when IWT = 2, 5, 7, or 9.
21-30	SURFI7	INTEG F10.0
		Input wall temperature for turbulent calculations, °R. This input is used when IWT = 2, 5, 7, or 9.

Contrails

Integral Skin Friction Method Control Card (continued)

<u>Column Code</u>	<u>Routine Format</u>	<u>Explanation</u>
31-40 RETRAN	INTEG F10.0	Transition Reynold's Number used in selecting which skin friction result is to be used for each point when ISFM = 1. Input Transition Reynold's Number divided by 10^6 .

Integral Method Flag Card (2I2,I1,I2,9I1,4X,5F10.0)

This card is only input when ISFM = 0.

1-2 NVP	INTEG I2	Number of points desired in the velocity profile at each station. (Usually input = 20).
3-4 NTURB	INTEG I2	Integer number of the streamline data point, if any, at which user wishes turbulent boundary layer to begin. If NTURB = 0, the program will calculate the position of transition to turbulent flow. NTURB may also be given any value from 1 to the maximum number of data points on the streamline. If NTURB = 1, initial values must be given for DTURB and TTURB. If NTURB > 1, initial values may or may not be given.
5 KPVM	INTEG I1	(not used in present program)
6-7 KSMTH	INTEG I2	Number of times distribution of surface velocity is to be smoothed prior to computation of surface gradients (= 0, 1, 2, 3, etc.). KSMTH = 3 is good for most applications.
8 KSPLN	INTEG I1	Integer indicating manner in which surface gradients are to be calculated. = 0 Weighted-difference technique. = 1 Spline curve-fit technique (use with care).
9 KLE	INTEG I1	Flag indicating type of initial condition existing at the first streamline point. = 0 Stagnation point or initial values given. = 1 Sharp leading edge.
10 KATCH	INTEG I1	Flag indicating whether laminar-boundary layer separation (if encountered) should reattach as a turbulent boundary layer. = 0 Separation and stop solution. = 1 Reattach.

Integral Method Flag Card (continued)

Column Code	Routine Format	Explanation
11 KPRE	INTEG I1	Preliminary calculation print flag. = 0 Output suppressed. = 1 Output printed.
12 KGRAD	INTEG I1	Surface gradients of velocity and Mach number print flag. = 0 Output suppressed. = 1 Output printed.
13 KSDE	INTEG I1	Flag for printing of solutions of laminar and turbulent differential equations. = 0 Output suppressed. = 1 Output printed.
14 KLAM	INTEG I1	Flag for printing of laminar calculations for location of instability and transition. = 0 Output suppressed. = 1 Output printed.
15 KMAIN	INTEG I1	Flag for printing of principal calculated boundary-layer parameters. = 0 Output suppressed. = 1 Output printed.
16 KPROF	INTEG I1	Flag for printing of velocity profiles. = 0 Output suppressed. = 1 Output printed.
21-30 CTHET	INTEG F10.0	Ratio of momentum thickness after reattachment to momentum thickness at laminar separation. This parameter is used when KATCH = 1.
31-40 DLAM	INTEG F10.0	Initial displacement thickness, if any, of laminar boundary layer at the first streamline point. DLAM may be zero or have some finite value (feet).
41-50 TLAM	INTEG F10.0	Initial momentum thickness, if any, of laminar boundary layer at the first streamline point. TLAM may be zero or have some finite value (feet).

Contrails

Integral Method Flag Card (continued)

<u>Column Code</u>	<u>Routine Format</u>	<u>Explanation</u>
51-60 DTURB	INTEG F10.0	Initial displacement thickness, if any, of turbulent boundary layer. DTURB may be given for the point designated by NTURB, or for the point at which transition is calculated by the program (feet).
61-70 TTURB	INTEG F10.0	Initial momentum thickness, if any, of the turbulent boundary layer (see DTURB). Feet.

Streamline Selection Card (10I2)

This card is used to select the streamline numbers (sub-region number) of the streamlines on the data save unit (10) for which skin friction values will be calculated. This card follows the Integral Method Flag Card if ISFM = 0, or the Integral Skin Friction Method Control Card if ISFM = 1.

1-2 ISTR(1)	INTEG 10I2	Sub-region number of the first streamline to be analyzed.
3-4 ISTR(2)		Sub-region number of the second streamline to be analyzed.
5-6 ISTR(3)		Third streamline.
7-8 ISTR(4)		Fourth streamline.
etc. etc.		etc.
10-20 ISTR(10)		

Note: If LASTR is = 0 then another Streamline Data Source Card will be expected after the above card. If LASTR = 1 then the program will return to VISCUS.

Viscous Force Cards

The Viscous Force Cards described on this and the next two pages are input only when the Integral Method Boundary Layer Program (ISFMTH = 0) has been used. The skin friction has been calculated along the required streamlines and has been stored on unit 10 before these cards are read in. It is now necessary to use the stored skin friction data along the streamlines to obtain values of the skin friction at the centroids of all the elements of the input panels that make up the component. This is accomplished by interpolation using the Surface Spline method, and as in the other applications of this method, proper normalization of the coordinates is required to obtain meaningful results.

The skin friction data is stored on unit 10 in the same format as flow field data. However, different definitions are applied to the terms primary and secondary flows. These are explained in the following paragraph.

Along a given streamline, four possible regimes exist: Laminar, Transitional, Turbulent, and Separated flows. The Laminar regime is stored as the first secondary flow, the transitional regime as the second secondary flow, the turbulent regime as the third secondary flow, and the separated regime as the fourth secondary flow. These definitions apply to the logical storage arrangement. The physical storage of the data is unchanged from the original streamline data used for the integral calculations. This data could be re-used (for example, different transition location) by accessing the primary flow.

A set of Viscous Force Cards consists of five cards: A Surface Property Access Flag Card and four Normalization Data Cards. The format of these cards is identical to the input pressure option cards. A set of these cards must be input for each α - β being run.

Surface Property Access Flag Card (I1,3I2,3I1,10I2,5I1)

Column Code		Routine Format	Explanation
1	LASTR	CFINPT I1	(Not active)
2-3	NDSET	CFINPT I2	Data set number where surface data properties will be found on unit 10.
4-5	IABSET	CFINPT I2	α - β set number where surface data properties will be found on unit 10.
6-7	IR	CFINPT I2	Flow region number where surface data properties will be found on unit 10.
8	INORM	CFINPT I1	Normalization flag for surface property spline interpolation. The surface property data are stored at varying X,Y,Z locations. However, it is usually best to convert the X-Y-Z coordinates to some combination of other coordinates for the spline interpolation (axial distance, A; radial distance, R; radial angle, ϕ).

Contrails

Surface Property Access Flag Card (continued)

Column Code	Routine Format	Explanation
		For example, on a body revolution A and ϕ would be best. For a wing X and Y. For a vertical tail, X-Z. The available flags are: = 0 $\phi = \text{fn}(A,R)$ = 1 $Z = \text{fn}(X,Y)$ (i.e., wings) = 2 $Y = \text{fn}(X,Z)$ (i.e., vertical tails) = 3 $X = \text{fn}(Y,Z)$ = 4 $R = \text{fn}(A,\phi)$ (i.e., body of revolution)
9	ISURF CFINTP I1	Surface boundary normalization flag. This flag determines how the normalization data input on the next card will be used by the program in the normalization for the spline interpolation and for establishing the boundary limits for the interpolation. = 0 The input values for XB(1),YB(1),ZB(1) and XB(2),YB(2),ZB(2) will be used to establish the normalization limits for the first variable (i.e., if INORM = 4, they will determine the limits of the axial distance, A). The input values for XB(3),YB(3),ZB(3) and XB(4),YB(4), ZB(4) will be used to establish the normalization limits for the second variable (i.e., if INORM = 4, they will determine the limits of the angular coordinate, ϕ). = 1 The surface is assumed to be of a wing or tail type and the XB,YB,ZB normalization limits input on the next cards will be used to establish a chordwise-spanwise normalization. The point XB(1),YB(1),ZB(1) is the leading edge point of the root chord, and the point XB(2),YB(2),ZB(2) is the trailing edge at the root. The point XB(3),YB(3),ZB(3) is the tip leading edge, and XB(4),YB(4), ZB(4) is the tip trailing edge.
10	IPF CFINPT I1	Primary flow flag. = 0 primary flow considered = 1 primary flow not considered.

Surface Property Access Flag Card (continued)

<u>Column Code</u>	<u>Routine</u>	<u>Format</u>	<u>Explanation</u>
11-12	ISR(1)	CFINPT	Subregion flow number where surface data properties will be found on unit 10. If ISR(1) = 0, all subregions associated with flow region IR (CC 6-7) will be used.
13-14	.	10I2	
15-16	.		
17-18	.		
19-20	.		
21-22	.		
23-24	.		
25-26	.		
27-28	.		
29-30	ISR(10)		
31	ISF(1)	CFINPT	Secondary flow number where streamline surface data will be found on unit 10. Normally, ISF(1) is input = 0 and the program then automatically sets up the ISF values as follows: ISF(1) = 1 for laminar region ISF(2) = 2 for transitional ISF(3) = 3 for turbulent ISF(4) = 4 for separated ISF(5) = 0
32	ISF(2)	5I1	
33	ISF(3)		
34	ISF(4)		
35	ISF(5)		

Normalization Data Cards (3F10.0)

Four cards are required that contain the coordinates for the data normalization limit process in the spline interpolation. The meaning of the four points is determined by the parameter ISURF on the preceding card.

1-10	XB(i)	CFINPT F10.0	XB coordinate
11-20	YB(i)	CFINPT F10.0	YB coordinate
21-30	ZB(i)	CFINPT F10.0	ZB coordinate

i = 1 to 4

Contrails

Mark III Skin Friction Element Data Cards (I2,8I1,2F9.0,3F6.0,2F6.0,F4.0,8X,I2)

One Skin Friction Element Data Card must be loaded for each element stored on the Quadrilateral Element Storage unit (4) for each vehicle Component. The format of these cards is exactly the same as the Type 11 cards used on the Mark III program (Mode 1 skin friction method). However, some of the parameters on the old Type 11 card are not actually used by this new version of the program.

Column Code	Routine Format	Explanation
1-2	IS(I,1) SKINFR I2	Skin friction element number.
3	IS(I,2) M3SF I1	Viscous-Inviscid interaction effect flag. = 0 Use tangent-wedge in interaction correction. = 1 Use tangent-cone in interaction correction
4	IS(I,3) SKINFR I1	Calculate induced pressures due to boundary layer displacement effects. Skin friction is not calculated. = 0 No = 1 Yes
5	IS(I,4) SKINFR I1	Skin-friction summation flag. = 0 Use turbulent skin friction data in calculating forces. (Note: The program will make a switch to laminar summation at very low Reynolds number, where turbulent results are not meaningful). = 1 Use laminar skin friction data in calculating forces.
6	IS(I,5) SKINFR I1	(Not used in this program)
7	IS(I,6) SKINFR I1	Wall-temperature and skin-friction method Flag. The program always calculates both laminar and turbulent skin-friction results. The result to be added to the pressure calculations is indicated by the flag in CC 5. In the discussions below the methods to be used for laminar and turbulent flow are separated by a slash (i.e., Laminar/Turbulent). (Integer) = 0 Calculate wall temperature and skin friction using Reference Temperature/Spalding-Chi methods.

Contrails

Mark III Skin Friction Element Data Cards (continued)

Column Code	Routine Format	Explanation
7	IS(I,6) (continued)	<ul style="list-style-type: none"> = 1 Use adiabatic wall temperature and Reference Temperature/Spalding-Chi methods. = 2 Use input wall temperature and Reference Temperature/Spalding-Chi methods. T_w input in CC 47-52 and 53-58. = 3 Calculate wall temperature and skin friction using Reference Enthalpy/Spalding-Chi (with enthalpy ratios) methods. = 4 Use adiabatic wall temperature and Reference Enthalpy/Spalding-Chi (with enthalpy ratios) methods. = 5 Use input wall temperature and Reference Enthalpy/Spalding-Chi (with enthalpy ratios) methods. T_w input in CC 47-52 and 53-58. = 6 Calculate wall temperature and skin friction using Reference Temperature/Reference Temperature methods. = 7 Use input wall temperature and Reference Temperature/Reference Temperature methods. T_w input in CC 47-52 and 53-58. = 8 Calculate wall temperature and skin friction using Reference Enthalpy/Reference Enthalpy methods. = 9 Use input wall temperature and Reference Enthalpy/Reference Enthalpy methods. T_w input in CC 47-52 and 53-58.
8	IS(I,7) SKINFR I1	<p>Flag to control printing of skin-friction data for each skin-friction surface element.</p> <ul style="list-style-type: none"> = 0 Do not print. = 1 Print skin-friction data. This is recommended option for most applications.
9	IS(I,8) SKINFR I1	<p>Print flag for flow characteristics before and after the shock or expansion.</p> <ul style="list-style-type: none"> = 0 Do not print. = 1 Print flow characteristics.

Mark III Skin Friction Element Data Cards (continued)

Column Code	Routine Format	Explanation
10	IS(I,9) SKINFR I1	Iteration and local skin friction print flag. = 0 Do not print. = 1 Print iteration results for wall temperature and the final local skin-friction data. = 2 Print the final local skin-friction data but not the iteration results. This is the recommended option for most applications.
11-19	SURF(I,1) SKINFR F9.0	Skin friction element surface wetted area in same units as S_{ref} . If input as 0.0 then the program will use the surface area as calculated from the input geometry unit for each element. The input wetted area must correspond to the input skin-friction geometry (i.e., if the Symmetry flag is 0, left side of the vehicle input, then the input wetted area should be only for the left side).

The four input quantities in CC 20 through 46 furnish to the program the planform shape of the skin-friction surface being analyzed ("Surface-of-Interest"), and the shape of the initial-surface (to account for the fact that the flow has traversed some other part of the shape before reaching the surface of interest). This information is not obtained from the input skin-friction geometry data input on the Type 3 cards. The input skin-friction geometry data are used only to establish the position and orientation of the centroid and the area of each skin-friction surface. The diagram below illustrates the input parameters required on the Skin Friction Element Data cards.

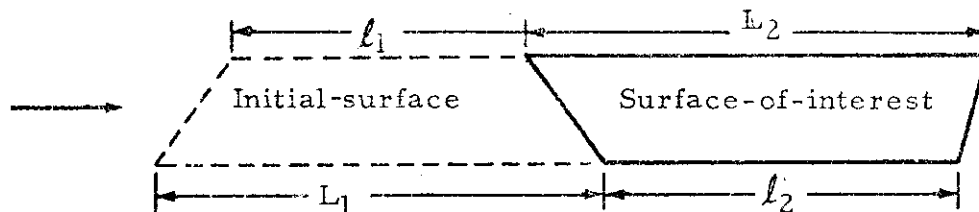

20-28	SURF(I,2)	SKINFR F9.0	The longest length of the surface-of-interest (L_2 in the diagram above). Feet.
29-34	SURF(I,3)	SKINFR F6.0	The longest length of the initial-surface (L_1 in the diagram above). Feet.

Contrails

Mark III Skin Friction Element Data Cards (continued)

Column Code	Routine Format	Explanation
35-40 SURF(I,4)	SKINFR F6.0	The taper ratio of the initial-surface (l_1/L_1). This taper ratio is defined as the ratio of the shortest chord length to the longest chord length. If both the initial-surface longest-length and the longest length of the surface-of-interest are on the same edge of the shape, then the taper ratio of the initial-surface is input as a positive number. If these lengths are on opposite sides of the shape such as in the diagram on the previous page then the initial surface taper ratio is input as a negative number. With these ground rules the absolute value of the taper ratio will never be greater than 1.0.
41-46 SURF(I,5)	SKINFR F6.0	The taper ratio of the surface-of-interest (l_2/L_2). This taper ratio is defined as the ratio of the shortest chord length. This taper ratio is always positive and never greater than 1.0.
47-52 SURF(I,6)	SKINFR F6.0	Input wall temperature for laminar calculations, °R. This input is used when CC 7 = 2, 5, 7, or 9.
53-58 SURF(I,7)	SKINFR F6.0	Input wall temperature for turbulent calculations, °R. This input is used when CC 7 = 2, 5, 7, or 9.
59-62 SURF(I,8)	SKINFR F4.0	(Not used in present program)
71-72 TYPE	SKINFR I2	Card Type number. Not used in present program.

A data load sheet for the Mark III Skin Friction Element Data Cards is given on the following page.

SPECIAL ROUTINES OPTION INPUT DATA

The Special Routines section of the program is reached by way of sub-option calls from the AERO Executive routine. The Special Routines routine currently has two options; the Summation routine, and the Derivative-Trim routine. The basic purpose of the Summation routine is to add together the aerodynamic force coefficients of the separate vehicle components as calculated in the Force and Skin Friction programs. The components to be added are selected by component number (sequence number in which they were placed on to the Force Data unit 9). This option may also be used to punch force data from the Force Data Save unit (9) and/or to print out the force data.

The Derivative-Trim routine is used to determine the aerodynamic coefficient derivatives and to prepare trimmed coefficient data. It uses data stored on the Force Data Save unit.

Special Option Selection Card (2011)

<u>Column Code</u>	<u>Routine Format</u>	<u>Explanation</u>
1	IPG(1) SPEC 2011	Special Routines sub-options to be used in the order given.
2	IPG(2)	= 1 Summation Program will be called.
3	IPG(3)	This program may be used to add, print and punch force data saved on the Force Data Save unit (9).
.	.	
.	.	= 2 Derivative-Trim option.
.	.	(not active in the current version)
	etc.	
20	IPG(20)	

Contrails

SUMMATION ROUTINE OPTION

This routine may be used to selectively sum, print, and punch data that has been stored on the Force Data Save unit (9) by the Force and Skin Friction routines. The results of the summations may also be stored on the Force Data Save unit. This is the only option provided in the program for adding together the force contributions of different vehicle components.

Summation Control Card (5I1,I4,20I2)

<u>Column Code</u>	<u>Routine Format</u>	<u>Explanation</u>
1	LAST	SUM I1
		Last control card flag. = 0 This is not the last control card. Another Control card will be expected next. = 1 This is the last control card. Return to the Aero routine after this card set of sum/print/punch instructions is completed.
2	ISUM	SUM I1
		Summation flag. = 0 Do not sum up component forces. = 1 Sum up all the vehicle components as specified by the ICOMP parameter.
3	ISAVE	SUM I1
		Data save flag. = 0 Save summation data on the Force Data Save unit (9). = 1 Do not save summation data.
4	IPRINT	SUM I1
		Print control flag. = 0 Print out summation data only. Component data will not be printed. = 1 Print component and summation data. Print component data even if summation was not performed.
5	IPUNCH	SUM I1
		Punch control flag. = 0 Do not punch any data. = 1 Punch summation data only. = 2 Punch both component and summation data. The data will be punched in the following order on a single card. ALPHA, C N, C A, C M, C Y, C LN, C LL, BETA, IRUN The card format is as follows: FORMAT (7F9.4,F7.2,1X,I4) One identification card is punched for each set.

Summation Control Card (continued)

<u>Column Code</u>	<u>Routine</u>	<u>Explanation</u>
	<u>Format</u>	
6-9 IRUN	SUM I4	Run number to be punched on the punched cards.
10-11 ICOMP(1)	SUM	Selected component sequence numbers to be summed, printed, and/or punched.
12-13 ICOMP(2)	20I2	These numbers must correspond to the order of the data placed on the Force Data Save unit (9) in the Force and Skin Friction routines. For example, if you wish to sum up components number 5, 7, and 11, then input ICOMP(1)=5, ICOMP(2)=7, and ICOMP(3)=11.
14-15 ICOMP(3)		
. .		
. .		
. .		
etc.		
48-49 ICOMP(20)		

If LAST = 0 then another Summation Control Card will be expected next.

If LAST = 1 then the return to AERO will be called next.

AUXILIARY PROGRAMS

This program option is reached by way of System Option calls from the Main Executive Routine System Control Card (IPG = 4). The Auxiliary Programs feature is provided as a means of attaching additional programs or features to the Mark IV program framework as might be required by the user. At the present time only the General Cutting Plane routine is provided as an option.

Auxiliary Programs Control Card (10I1)

<u>Column</u>	<u>Code</u>	<u>Routine Format</u>	<u>Explanation</u>
1	IAUX(1)	AUXILI I1	Auxiliary program options in the order that they are to be executed.
			<u>IAUX</u> <u>Option</u>
2	IAUX(2)	AUXILI I1	= 1 Not used. Available for user additions.
3	IAUX(3)	AUXILI I1	= 2 Not used.
.	.	.	= 3 Not used.
			= 4 General Cutting Plane Option
			etc.
10	IAUX(10)	AUXILI I1	

Contrails

GENERAL CUTTING PLANE OPTION

Introduction

The general cutting plane option has the capability to determine the section shape of an arbitrary body in any desired plane. That is, the intersection of an arbitrary body cut by a plane. The orientation of the cutting plane is general being specified by a point in space and three rotation angles. The cutting planes may be requested singly or in multiples and for convenience, the latter have been classified into two types: meridian and parallel cuts.

Meridian cuts all pass through the same point in space and are "one-sided" whereas the parallel cuts are "two-sided" and do not pass through the same point. The meaning of one-sided is that intersections are only found on one side of the YP-axis, and obviously two-sided refers to both sides of the YP-axis (see sketch below).

A vehicle configuration is made up of physical components such as the fuselage, wing, et., which are composed of geometry panels (status 3's). These panels in turn are made up of the quadrilateral elements. In using the general cutting plane the desired panels are selected by name (as many as 10 on a single pass). The intersections which form the section

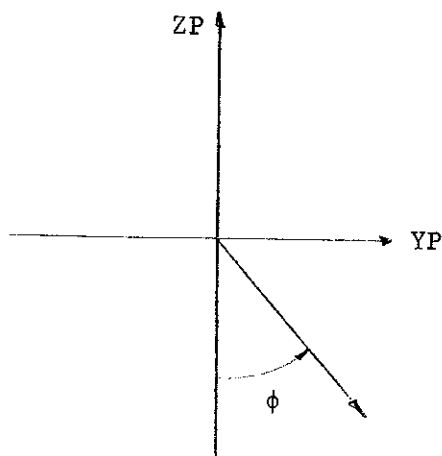

Meridian Cut, One-Sided

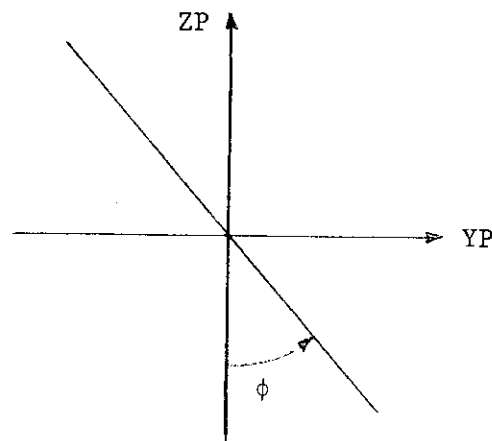

Parallel cut, Two-Sided

shape are collected for each cutting plane but randomly as they are calculated. Several options are available for ordering them:

1. By individual panel
2. By all panels as a group
3. By panels as sets

The ordering may be done with respect to each of the three body coordinates (X,Y,Z) and also with respect to the axial coordinate (A) of the cutting plane.

Cutting Plane Orientation

The orientation of a plane is completely described by its normal vector and a point in space lying in the plane. For convenience, the positive triple $(\bar{T}_1, \bar{T}_2, \bar{T}_3)$ is used to define the cutting plane, which initially is coincident with the $\bar{i}, \bar{j}, \bar{k}$ coordinate vectors, respectively, of the body system. \bar{T}_2 is the cutting plane normal vector and the coordinate origin is selected as the point lying in the plane.

The orientation of an arbitrary cutting is then specified by three rotations in a yaw-pitch-roll sequence $(\psi_0, \theta_0, \phi_0)$ and by a translation of the origin (x_0, y_0, z_0) . Angle ψ_0 is a rotation about \bar{T}_3 , angle θ_0 is a rotation about \bar{T}_2 , and angle ϕ_0 is a rotation about \bar{T}_1 . The Intersections are determined in the plane of \bar{T}_2, \bar{T}_3 in which the cutting plane is viewed as a line. All the elements are projected into this plane and the coordinated axis are labeled YP and ZP (\bar{T}_2 and \bar{T}_3 , respectively). Since the ϕ_0 rotation does not effect the viewing plane, it is accounted for as an offset or initial value.

Specification of Cutting Planes

Meridian planes are specified by a rotation ϕ_0 plane. Meridian planes may be specified individually (ϕ input in ascending order) or selected as equally spaced. In the latter case,

$$\phi(I) = \phi_0 + (I - 1) * \Delta\phi; \quad I = 1, NPL$$

where NPL is the number of planes and

$$\Delta\phi = \frac{360}{NPL}$$

Parallel cutting planes are inclined at a constant angle ϕ_c and also may be input individually or selected as equally spaced.

The positions of the parallel planes are input in body coordinates (X, Y, Z) and the points are automatically transformed to the viewing plane YP-axis. If equal spacing is selected, the two end points are input and the planes are located at

$$YPA(I) = YPA(1) + (I - 1) * \Delta YPA; \quad I = 1, NPL$$

where

$$\Delta YPA = [YPA(NPL) - YPA(1)] / (NPL - 1)$$

and NPL is the number of planes.

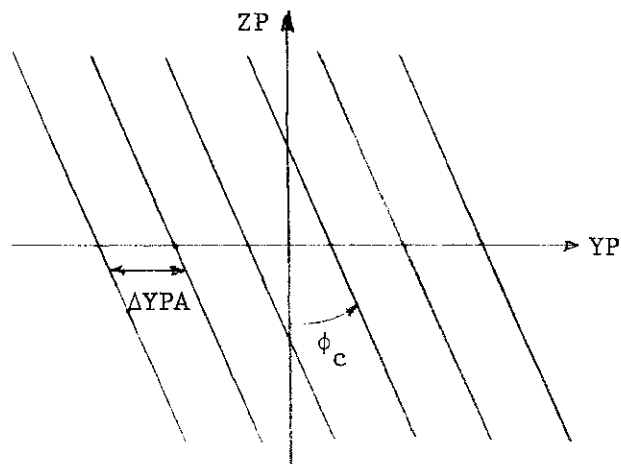
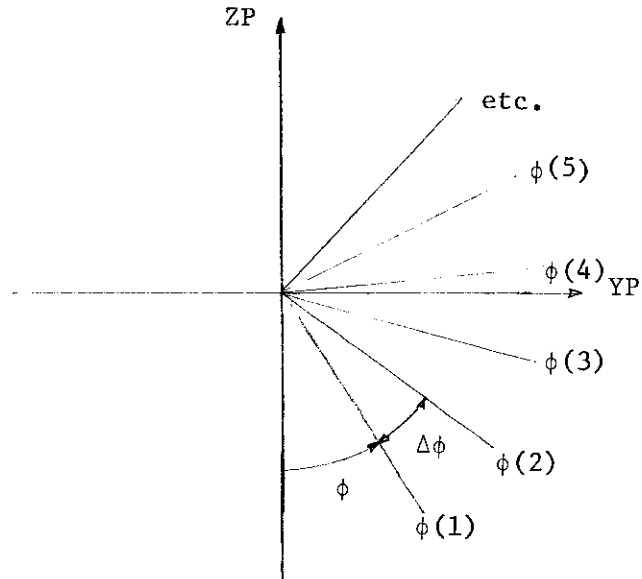

Section Shapes and Data Ordering

Each point of a section shape is identified by the name (ID) and element number (J) of the panel from which it was calculated. Five variables are given for each point: the three coordinates of the point in the body system (X, Y, Z), the axial coordinate (A) of the cutting plane, and the radial distance (R) normal from the axis to the point. The section data may be ordered (arranged numerically) with respect to four of these variables: X, Y, Z, and A. The numerical arrangement for X, A is in descending order and for Y, Z in ascending order, consistent with the arbitrary body coordinate convention.

The ordering may be done for each panel independently, for all panels taken together, and also by considering each panel as a set and ordering these sets. When ordering by sets coincident points between two sets are removed from the final distribution. Also, when ordering by sets, a base panel, to which the remaining panels are added, must be specified. Some care must be taken in the choice of variable to be used in ordering. For example, in cross section cuts the axial coordinate will be double valued and the ordered distribution would be meaningless. A better choice for this case would be the Z coordinate.

Symmetry Considerations

Most configurations are loaded with $\pm Y$ -symmetry (geometry input flag SYMFCT = 0 or 2) and this is automatically accounted for in the general cutting plane option. However, for many applications it is not necessary to include this feature and thus an override input flag has been provided to ignore symmetry.

INPUT TO GENERAL CUTTING PLANE OPTION

Configuration Description Card (15A4)

Column Code		Routine Format	Explanation
1-60	CTITLE	GENCUT 15A4	Configuration title

Component Control Card (A4,25XI1,4XI1,3XI2,4XI1,9XI1)

1-4	TITLE	GENCUT A4	Component identification
30	IORG	GENCUT I1	Origin card flag. = 0 Zero (0.0) will be assumed for all of origin variables. The Cutting Plane Origin and Orientation Card will not be input. = 1 The cutting Plane Origin and Orientation Card will be input.
35	INPHI	GENCUT I1	Cutting plane type flag. = 0 Meridian cuts will be equally spaced. = 1 Meridian cut positions will be input. = 2 Parallel equally spaced cuts will be generated by the program. Two Parallel Planes Input Position Cards will be input to give the position of the first and last cutting planes. = 3 Parallel cuts with arbitrary input spacing will be used. The number of cuts will be equal to NPL and the number of Parallel Planes Input Position Cards will also be equal to NPL.
39-40	NPL	GENCUT I2	Number of cutting planes (≤ 36).
45	ISYM	GENCUT I1	Symmetry override flag. = 0 Symmetry of the geometry data is ignored. = 1 Symmetry of geometry data is used.
55	IPRNT	GENCUT I1	Special print flag. = 0 Do not print detailed checkout data. = 1 Print detailed checkout data.

Cutting Plane Origin and Orientation Card This card read only if IORG= 1.
(6F10.0)

1-10	XPO	X_o	Definition of cutting planes origin and orientation (see discussion on page 135). If IORG = 0, zero (0.0) will be assumed for all of these variables.
11-20	YPO	Y_o	
21-30	ZPO	Z_o	
31-40	PSIO	ψ_o	
41-50	THEO	θ_o	
51-60	PHIO	ϕ_o	

Contrails

Meridian Planes Input Position Card (six values per card)

Column Code	Routine Format	Explanation
1-10	PHI(1) ϕ_1 GENCUT	Meridian angles in degrees (must be in ascending order).
11-20	PHI(2) ϕ_2 6F10.6	
etc.	PHI(NPL) ϕ_N	

Parallel Planes PHI Card This card read only if INPHI=2 or 3

Column Code	Routine Format	Explanation
1-10	PHICD ϕ_c GENCUT F10.6	Plane angle in degrees

Parallel Planes Input Position Cards These cards read only if INPHI=2 or 3

1-10	XN	GENCUT F10.0	If INPHI=2, two cards read
11-20	YN	GENCUT F10.0	If INPHI=3, NPL cards read
21-30	ZN	GENCUT F10.0	

Panel Identification and Control Card (A4,50XI1,5XI1)

1-4	IPANL	GENCUT I4	Panel number. Geometry data on unit 4 corresponding to this number is used.
	IPRINT	GENCUT I1	Special print flag (checkout only)
	LAST	GENCUT I1	= 0 another card of this type will be read = 1 this is last panel ID card

A maximum of 10 panel ID cards may be used.

Output Data Control Card (10I1,3XI2,5XA4,5XI1,24XI1)

1	IOR(1)	OUTD	Ordering flag for each panel individually = 0 no ordering ≠ 0 points will be ordered as per variable flag IOV	
2	IOR(2)	10I1		
3	IOR(3)			
4	IOR(4)			
.	.			
.	.			
10	IOR(10)			
14-15	IOG	OUTD I2		Group ordering flag < 0 all panels ordered as if random set = 0 no group ordering = 1 panels ordered by groups

Contrails

Output Data Control Card

(continued)

<u>Column Code</u>	<u>Routine</u>	<u>Format</u>	<u>Explanation</u>
21-24	COMPB	OUTD A4	Base panel of group (see discussion on page 136).
30	IOV	OUTD I1	Flag to signify variable to be ordered. = 0 axial coordinate (also default) = 1 X-coordinate = 2 Y-coordinate = 3 Z-coordinate
55	IPRINT	OUTD I1	Output print control flag. = 0 Do not print results. = 1 Print output data.

SECTION IV OUTPUT DATA

The amount of output data generated by this program is controlled by the various input print flags. The basic philosophy involved in the output-data printing is outlined below and followed by a more detailed description of the output from each part of the program.

The first data card input to the program contains a flag (INMONT) that causes all of the input data to be copied from the usual input unit (5) to a storage unit (1). As this is being done all of the input data cards (except for the very first card in the deck, the Executive Flag Card) are written out on the output unit (6). A column identification header is printed out at the top of each page as an aid in locating the card columns.

Parts of the program may prepare up to four basic types of output data.

1. Basic output data always required by the user.
2. Detailed results needed to better understand the results of the program (i.e., detailed pressure distributions). These are usually controlled by an input flag.
3. Intermediate results of program calculations, iterations, etc. These are always controlled by an input flag.
4. Checkout print data used only to track down program difficulties. These are usually controlled by internal flags set within the routine where the printout occurs.

The output volume from this program may be small or very large depending upon the needs of the user. The user will be aware of his output needs for a specific problem and should adjust his print line estimate on his job card accordingly in order to avoid having the job stopped because of exceeding an output limit.

GEOMETRY OUTPUT DATA

Subroutine GEOM is responsible for controlling the generation and storage of all the basic geometry data. The detailed characteristics of each quadrilateral element may be printed on command. This output is shown below.

SUPERSONIC/HYPERSONIC ARBITRARY-BODY PROGRAM, MARK IV MOD 0

CASE

PAGE 11

FORWARD TOP SECTION **PARAMETRIC CUBIC INPUT**

INPUT SURFACE ELEMENT DATA

N	M	X	Y	Z	X	Y	Z	X	Y	Z	NX	NY	NZ	XCENT	YCENT	ZCENT	AREA	DELTA V	VOLUME	L
1	5	-1.00000E+00	1.00000E+00	-1.00000E+00	-1.60000E+01	-1.60000E+01	-1.60000E+01	-1.60000E+01	-1.60000E+01	-1.60000E+01	.164777	-.38005E+00	-.38005E+00	-.38005E+00	-.38005E+00	-.38005E+00	9.93180E-01	1.62407E+00	5.76486E+00	10
		3.60000E-01	3.46000E-01	3.06800E+00	3.06800E+00	3.08000E+00	3.08000E+00	3.08000E+00	3.08000E+00	3.08000E+00	.966592	1.69174E+00	1.69174E+00	1.69174E+00	1.69174E+00	1.69174E+00	1.62407E+00	1.62407E+00	1.62407E+00	
		-3.50000E-02	3.20000E-02	-7.78000E-01	-7.78000E-01	-8.39000E-01	-8.39000E-01	-8.39000E-01	-8.39000E-01	-8.39000E-01	.196339	-3.98547E-01	-3.98547E-01	-3.98547E-01	-3.98547E-01	-3.98547E-01	5.76486E+00	5.76486E+00	5.76486E+00	

SECTION #67 TOTAL AREA OF INPUT ELEMENTS = 5.126 TOTAL NUMBER OF ELEMENTS = 10
TOTAL VOLUME OF INPUT ELEMENTS = 5.765

Explanation:

- N = Element column number.
- M = Element row number.
- X, Y, Z = Coordinates of input surface corner points (given clockwise around the element).
- NX, NY, NZ = Direction cosines of outward surface normal.
- X CENT = Centroid of quadrilateral.
- Y CENT
- Z CENT
- AREA = Quadrilateral surface area.
- DELTA V = Volume contribution of element when projected on to the X-Z plane (= NY*YCENT*AREA)
- VOLUME = Summation of element volume contributions.
- SECTION = Section identification read from Type 3 cards.
- L = Element number.

The geometry generation routines may also produce printed output if requested. This consists of images of the Type 3 cards being generated.

FLOW FIELD SECOND ORDER SHOCK EXPANSION OUTPUT DATA

The Second Order Shock Expansion output results are controlled by the print flag IFLG(5) on the Shock Expansion Flow Field Control Card.

SECOND-ORDER SHOCK-EXPANSION

M = 4,500000 ALFWD = 2,000000 PHIT = 90,000000 AMP = 4,497259 ALFP = ,000000

	X	Y	DELTA	S
	0,0000	0,0000	11,2991	0,0000
	,5714	,1142	11,2991	,5827
	,1,1429	,2283	11,2991	1,1654
	,1,143	,2287	11,2991	1,17476
	,100,0000	2,9280	,7,6907	97,6518
		2,5141	,8,2438	100,5388

STARTING FLOW M = 4,04022 THETA = 17,355 DPSK = ,38867

- M = Upstream Mach number.
- ALFWD = Angle of attack in the windward plane relative to local axis, degrees.
- PHIT = Meridian angle relative to windward plane, degrees.
- AMP = Mach number component in PHIT plane.
- ALFP = Angle of attack of AMP relative to local axis, degrees.
- X = Axial coordinate.
- Y = Height or radial coordinate.
- DELTA = Slope angle of surface element relative to local axis, degrees.
- S = Arc length along surface.
- STARTING FLOW - Downstream conditions on the first element
- M = Surface Mach number on first element.
- THETA = Shock angle generated by first element relative to local axis.
- DPSK = Relative pressure difference. Surface value minus downstream shock value divided by upstream value, on first element.

FLOW FIELD SECOND ORDER SHOCK EXPANSION OUTPUT DATA (continued)

INVISCID SOLUTION, SURFACE		M		CP	PB	ETA	ANGLE	CPLIM	PC
X	P/P(INF)	4.0402	.0932	2.32163	0.0000	25.6294	.0932	2.32163	
.2857	2.32163	4.0402	.0932	2.32163	.88180	25.6294	.0932	2.32163	
.8571	2.32163	4.0402	.0932	2.32163	.58654	25.2867	.0893	2.26583	
-1.4286	2.26015	4.0605	.0889	2.25821	.58654	25.2867	.0893	2.26583	
-2.0000	2.26267	4.0596	.0891	2.26159	.58654	25.2867	.0893	2.26583	
-2.5714	2.26407	4.0592	.0892	2.26347	.58654	25.2902	.0893	2.26583	
-4.2457	2.15856	4.0953	.0817	2.15109	1.42025	24.6650	.0822	2.16578	
-7.1429	2.04950	4.1348	.0740	2.04342	.84975	23.9818	.0748	2.06099	
-10.0000	1.91099	4.1777	.0667	1.9028	.63000	23.0000	.0670	1.96040	

- X = Axial coordinate.
 - P/P(INF) = Pressure ratio, value at surface divided by upstream value.
 - M = Mach number at surface.
 - CP = Surface pressure coefficient.
 - PB = Two-dimensional pressure ratio at corner.
 - ETA = Exponent η in second-order solution.
 - ANGLE = Mach angle relative to local axis.
 - CPLIM = Limiting value of pressure coefficient.
 - PC = Limiting value of pressure ratio.
- 1ST ORDER SHOCK EXPANSION - this print out appears during a second-order solution whenever the value of ETA is less than zero. No second-order correction is applied to the pressure and thus P/P(INF) = PB.

INVISCID SOLUTION, SHOCK WAVE 1		YS	P2/P1	M2	THETA
0.0000	0.0000	1.9330	3.9695	17.3554	
-.9566	.2990	1.9330	3.9695	17.3554	
-1.9132	.5979	1.9330	3.9695	17.1318	
-2.9137	.9063	1.8808	3.9925	17.1426	
-3.8805	1.2045	1.8833	3.9914	17.1487	
-4.8111	1.5111	1.8833	3.9914	17.1487	

- INVISCID SOLUTION, SHOCK WAVE n where n = 1 indicates primary or first shock
 = 2 indicates first secondary or embedded shock
- XS = Axial coordinate.
 - YS = Height or radial coordinate.
 - P2/P1 = Pressure ratio across shock.
 - M2 = Downstream Mach number at the shock.
 - THETA = Shock angle relative to local axis.

SHOCK EXPANSION CUTTING PLANE OUTPUT DATA

The Shock Expansion Flow Field option makes use of the cutting plane features of the program. The cutting plane output data is shown below.

CONFIGURATION NUMBER OF CUTS = 1 TOTAL POINTS = 40
 PHIO = 0.000000 PSID = 0.000000 THEU = 0.000000 X0 = 0.000000 Y0 = 0.000000 Z0 = 0.000000

PLANE NUMBER 1 PHI = 90.000000 YPA = 0.000000 NUMBER OF INTERSECTIONS = 40

POINTS ORDERED FOR A AS PER IJG = 1 AND IUR(I) = 0 0 0 0 0 0 0 0 0 0

ID	J	X	Y	Z	R	A
A	9	0.000000	0.000000	0.000000	0.000000	0.000000
A	9	7.571429	114173	7.000000	114173	7.571429
A	27	-1.142857	228346	-1.000000	228346	-1.142857
A	45	-1.714286	339708	-1.000000	339708	-1.714286
A	63	-2.285714	451060	-1.000000	451060	-2.285714

- = PSIO Cutting plane orientation angle, ψ_0 .
- = PHIO Cutting plane orientation angle, ϕ_0 .
- = THEU Cutting plane orientation angle, θ_0 .
- = XO Cutting plane origin, X_0 , coordinate.
- = YO Cutting plane origin, Y_0 , coordinate.
- = ZO Cutting plane origin, Z_0 , coordinate.
- = PHI Cutting plane meridian angle.
- = YPA Spacing of the cutting planes (see page 84).
- = IJG Group ordering flag (see General Cutting Plane Option).
- = IUR Ordering flag for each panel individually (see General Cutting Plane Option).
- = ID Panel number or code identification from the Panel Identification Card.
- = J Element number in the panel.
- = X X-coordinate of the point.
- = Y Y-coordinate of the point.
- = Z Z-coordinate of the point.
- = R Radial coordinate of the point.
- = A Axial coordinate of the point.

FLOW FIELD DATA READ OUTPUT DATA (continued)

MACH = Data set Mach number.
 NAB = The number of α - β set directories on the unit.
 LOAB = Pointer array to the start of each α - β set directory.
 ALPHA = Angle of attack of α - β set being read.
 BETA = Yaw angle of α - β set being read.
 LORG = Pointer array to the start of each Region Directory.
 IDTYP = Data type array (see Region Directory Table Card and Hand-Load Data Type Flag Card).
 X0,Y0,etc. = See Shock-Expansion Flow Field option, page 87).
 LOFF = Sub-region pointer array.
 IFC = Data point counter array for sub-region data.
 LOCD = Sub-region pointer array for surface spline coefficients.
 IFD = Data point counter for coefficient data.
 BOUNDARY n DATA = Flow field data array, DATA.
 DATA(1) = X-coordinate of data point.
 DATA(2) = Y-coordinate of data point.
 DATA(3) = Z-coordinate of data point.
 DATA(4) = Axial distance, A, of flow field data point.
 DATA(5) = Radial distance, R, of flow field data point.
 DATA(6) = Orientation angle, PHI, of flow field data point, radians.
 DATA(7) = Mach number at data point.
 DATA(8) = X-direction cosine component of local velocity vector.
 DATA(9) = Y-direction cosine component of local velocity vector.
 DATA(10) = Z-direction cosine component of local velocity vector.
 DATA(11) = P/P ∞ at flow field data point.
 DATA(12) = T/T ∞ at flow field data point.

Where n = 1 Surface data.
 = 2 Shock wave data.
 = 3 Upstream boundary (not active in present program).
 = 4 Downstream boundary (not active in present program).
 = 5 Field data.

SHIELDING PROGRAM OUTPUT DATA

The purpose of the Shielding program is to produce and store negative area elements that represent those portions of the shape that are shielded by some other part. The printing of these negative area elements is controlled by a print flag on the Shielding Title Control Card.

SUPERSONIC/HYPERSONIC ARBITRARY-BODY PROGRAM, MARK IV MOD 0

CASE

PAGE 31

SHIELDING TITLE CARD

****SHIELDING PROGRAM OUTPUT NEGATIVE AREA ELEMENTS
 PANEL# 8 SHIELDING PANELS# 1 2 3 4 5 10 -0 -0 -0 -0 -0 -0 -0 -0 -0 -0 -0
 ALPHA# 7.00 BETA# 0.00

ICT	IN	IM	NX	NY	NZ	XCENT	YCENT	ZCENT	AREA
1.0	1.0	1.0	.23267E+00	.86723E+00	.40019E+00	-.23870E+02	.15502E+00	.41936E+01	-.74430E-01
			-.23166E+02	-.23084E+02	-.24564E+02	-.24664E+02			
			.16600E+00	.14400E+00	.14400E+00	.16600E+00			
			.38000E+01	.38000E+01	.45825E+01	.45918E+01			
			.40000E+01	0.	0.				

- ICT = Negative area element number.
- IN = Column number of element being shielded.
- IM = Row number of element being shielded.
- NX,NY,NZ = Direction cosines of outward surface normal.
- XCENT = Centroid of quadrilateral (new negative element).
- YCENT
- ZCENT
- AREA = Negative element quadrilateral surface area.
- X1,X2,X3,X4 = Element corner points (clockwise around the element).
- Y1,Y2,Y3,Y4
- Z1,Z2,Z3,Z4

AERODYNAMIC FORCE COEFFICIENT OUTPUT DATA

Aerodynamic force coefficients may be printed in the Inviscid Pressure part of the program (PRES), in the Viscous routine (VISCUS), and by the Summation routine (SUM). The general format of the data is as follows.

SUPERSONIC/HYPERSONIC ARBITRARY-BODY PROGRAM MARK IV MOD 0

PAGE 55

CASE 1

COMPONENT NUMBER = 1

PANEL ID SFM

A CGK

MACH# 19.085 VEL# 20000.0 FT/SEC RE/FT = .31156E+05
 ALT = 20000.
 AIR

S REF = 152.00 SPAN = 8.30 MAC = 30.00
 X CG = -18.60 Y CG = 0.00 Z CG = 1.00

FORCE DATA

ALPHA	C D	C L	C A	C Y	C N
BETA	L/D	C M	C LL	C LN	
5.00	.00173	.00342	.00143	0.00000	.00355
0.00	1.97095	.00078	0.00000	0.00000	

- ALPHA = Angle of attack in degrees.
- BETA = Yaw angle in degrees (positive with the wind striking the right side of the vehicle).
- C D = C_D , drag coefficient.
- C L = C_L , lift coefficient.
- C A = C_A , axial force coefficient.
- C Y = C_Y , side force coefficient (positive when force is pushing on left side of vehicle toward the right).
- C N = C_N , normal force coefficient.
- L/D = lift-to-drag ratio.
- C M = C_m , pitching moment about center of gravity (based on length parameter, MAC).
- C LL = C_{ℓ} , rolling moment coefficient based on reference length, SPAN (positive when tending to cause a roll to the right).
- C LN = C_n , yawing moment coefficient based on reference length, SPAN (positive when tending to force the nose to the right)

DETAILED FORCE CHARACTERISTICS OF EACH ELEMENT

The output shown below is produced when the flag IPRINT on the Pressure Method Card is set = 1 or 2. This same output format is also used for the element force characteristics print out in the viscous program.

HYPERSONIC ARBITRARY-BODY PROGRAM, MARK IV A MOD C

CASE

PAGE 119

WING WITH EDDY FLOWFIELD INVISCID

AIR

ELEMENT DATA MACH= 4.500 ALT = 3.5 REF = 102.0 SPAN = 34.5 IMPACT = 15 IMPACT = 0
 XCG = 0.0 YCG = 0.0 ZCG = 0.0 MAC = 100.0 ISHAD = 5 ISHAD = 0
 ANGLE OF ATTACK = 2.00 YAW ANGLE = 0.0 K = 2.00000 ETAC = 1.0000 DELTA E = 0.0
 IDERIV = 0 Q = 0.0 R = 0.0 P = 0.0

L	DEL CA	DEL CY	DEL CN	DEL CLL	DEL CLM	DEL CLN	CP	AREA
	CA	CY	CN	CLL	CLM	CLN	DELTA	
	XCENT	YCENT	ZCENT					
1	0.16047E-04	0.0	-0.15987E-03	0.0	0.79547E-04	0.0	0.16665E-01	0.51083E 00
	0.16047E-04	0.0	-0.15987E-03	0.0	0.79547E-04	0.0	0.27582E 01	
	-0.49739E 02	0.50558E 01	0.16633E 00					
	LLCND= 1	1	1	1	1	1	1	1
	FLUM DATA SET = 1	ALPHA-DELTA SET = 2	DIANFL = 4.76558	-0.95875	0.07484	0.04288	0.90273	0.90480
			FLOW REGION = 1	SUB-REGION = 1	SECONDARY FLOW = 0			
2	0.79326E-05	0.0	0.0	0.0	0.45640E-04	0.0	0.12086E 00	0.4974E 00
	0.0	0.0	0.0	0.0	0.12319E-04	0.0	0.0	0.0

- L = Element number
- DEL CA = Axial force increment for element, ΔC_A .
- DEL CY = Side force increment for element, ΔC_Y .
- DEL CN = Normal force increment for element, ΔC_N .
- DEL CLL = Rolling moment increment for element, ΔC_{l_r} .
- DEL CLM = Pitching moment increment, ΔC_m .
- DEL CLN = Yawing moment increment, ΔC_n .
- CP = Pressure coefficient on the element (set = 0.0 for skin friction output format).
- AREA = Element surface area.
- CA = Summation of axial force increments.
- CY = Summation of side force increments.
- CN = Summation of normal force increments.
- CLL = Summation of rolling moment increments.

DETAILED FORCE CHARACTERISTICS OF EACH ELEMENT (continued)

- CLM = Summation of pitching moment increments.
- CLN = Summation of yawing moment increments.
- DELTA = Element impact angle, degrees.
- XCENT = X-coordinate of element centroid.
- YCENT = Y-coordinate of element centroid.
- ZCENT = Z-coordinate of element centroid.
- LCOND = Element condition flag array.
 - LCOND(1) = Element condition code.
 - = 0 freestream element.
 - = 1 complete element that will be corrected for flow field effects.
 - = 2 element that will not be analyzed because it crosses over a flow region boundary (not used in initial release of program).
 - = 3 part-element that is in a flow region that will be analyzed for interference (not used in initial release of program).
 - = 4 remaining half of the part-element (not used in initial release).
 - LCOND(2) = The element number of the element in the original geometry data set.
 - LCOND(3) = The flow field region number used for the interference calculations.
- CPI = Element pressure coefficient based on local conditions (before correction to freestream conditions).
- DINFL = Interference data array.
 - DINFL(1) = Local flow field Mach number (= local skin friction coefficient in skin friction print out).
 - DINFL(2) = X-component direction cosine of surface velocity vector.
 - DINFL(3) = Y-component direction cosine of surface velocity vector.
 - DINFL(4) = Z-component direction cosine of surface velocity vector.
 - DINFL(5) = Local flow field pressure ratio, P/P_{∞} .
 - DINFL(6) = Local flow field temperature ratio, T/T_{∞} .

MARK III SKIN FRICTION OUTPUT DATA

The basic data output by the Mark III skin friction option is as follows.

SKIN FRICTION DATA		METHOD		S WET		LENGTH		LENGTH		TAPER		ANGLE(1)		RE LOC		CHI BAR		V BAR	
SURF NO.	TYPE	CF	CF	SUM CA	SUM CN	SUM CA	SUM CN	TW	TW	TW/T	TW/T	TW/TR	TW/TR	RE*/FT	RE*/FT	CD	CD	CF/CFU	CF/CFU
LAM	CA	CF	CH											RE*/FT	C STAR	C	C	V STAR	V STAR
TURB	V	MACH	V SOUND	P-PSF	TEMP-R	RHU*10**4	VIS*10**7												
1	1		0	24.	16.0	0.0	0.0	0.0	0.0	-0.0	0.0	8.02	9.702E+05	8.074	.0222				
.00657	0.00000	0.00000	0.00000	0.00000	0.00000	1652.6	3.6161					.0577	3.980E+03	0.00000	1.2006				
.00415	0.00000	0.00000	0.00000	0.00000	0.00000	1742.5	3.8130					.0576	9.817E+04	0.00000	1.0000				
19.08450	2000.0	1047.97	.4134	456.99	.0052696	3.382652	3.116E+04					3.650E-01	6.735E-01	.0163					
LOCAL 11.19672	19746.8	1763.63	4.8240	1294.28	.0217132	7.0A0162	6.056E+04												

- SURF NO. = Skin-friction element number.
- TYPE = Viscous-inviscid interaction type flag. (=0 for tangent-wedge, = 1 tangent-cone).
- METHOD = Method flag (=0 skin friction is calculated, = 1 viscous induced pressures are calculated).
- S WET = Wetted area of skin-friction surface (note that areas input or calculated with values less than 1.0 will be printed as 0.).
- LENGTH = Longest length of the surface of interest
- LENGTH = Longest length of the initial surface.
- TAPER = Taper ratio of the initial-surface.
- ANGLE(1) = Flow turning angle.
- RE LOC = Local Reynolds number.
- CHI BAR = Hypersonic interaction parameter based on surface conditions. $\bar{\chi} = M_{\infty}^3 \sqrt{C/Re_x}$
- V BAR = Hypersonic viscous parameter (includes planform effects). $\bar{V}_{\infty} = M_{\infty}^3 \sqrt{C/Re_x}$
- CF = Final average skin-friction coefficient based on freestream conditions (includes viscous-inviscid interaction in laminar results).
- CA & CN = Not used in present program.
- SUM CA = Not used in present program.
- SUM CN = Not used in present program.
- TW = Surface temperature, °R.
- TW/T = Wall to freestream temperature ratio.
- TW/TR = Wall to recovery temperature ratio.
- RE*/FT = Reynolds number based on reference conditions.
- CD = Not used in present program.
- CF/CFU = Ratio of skin friction with viscous-inviscid interaction to skin friction without interaction.

MARK III SKIN FRICTION OUTPUT DATA (continued)

- MACH = Mach number.
- V = Velocity, feet/second.
- V SOUND = Speed of sound, feet/second.
- P-PSF = Pressure, lb/ft².
- TEMP-R = Temperature, °R.
- RHO*10**4 = Density times 10⁴.
- VIS*10**7 = Viscosity times 10⁷.
- RE/FT = Reynolds number per foot.
- C STAR = Chapman-Rubesin viscosity coefficient evaluated at reference conditions.
 $C_{\infty}^* = (\mu^*/\mu_{\infty}) (T_{\infty}/T^*)$
- C = Chapman-Rubesin viscosity coefficient evaluated at wall conditions.
 $C = (\mu_w/\mu_{\infty}) (T_{\infty}/T_w)$
- V STAR = Hypersonic viscous parameter evaluated at reference conditions.
 $\overline{V}_{\infty}^* = M_{\infty} \sqrt{C^*/Re_x}$

At the request of the user, more detailed information may be printed concerning the Mark III skin-friction computations. This output is described on the following page.

MARK III SKIN FRICTION METHOD TEMPERATURE ITERATION OUTPUT

The output of the temperature iteration calculations shown below is controlled by the input flag, IS(I,9) on the Mark III Skin Friction Element Data Card. This information will be printed before the final local skin-friction data for each element.

KT = 1	TC1 = .100000E+03	TR1 = .100000F+03	TC2 = .165967E+04	TR2 = .165967E+04		
ITW = 1	GC1 = .226674E+04	GR1 = .298752E-01	QC2 = .207015E+04	QR2 = .226674E+04		
KT = 2	TC1 = .153520E+04	TR1 = .153520F+04	TC2 = .162537E+04	TR2 = .162537E+04		
ITW = 1	GC1 = .208509E+04	GR1 = .165947E+04	QC2 = .207425E+04	QR2 = .208509E+04		
KT = 1	TC1 = .162314E+04	TR1 = .162314F+04	TC2 = .165325E+04	TR2 = .165325E+04		
ITW = 2	GC1 = .223187E+04	GR1 = .207363E+04	QC2 = .222814E+04	QR2 = .223187E+04		
NW = 3	REAL GAS, REF. H/S-C SOLUTION.					
KT = 1	TWEG = 1652.6R	CF1 = .205316E-02	CF1(RE1) = 1.450579	ROMURA = 4.95840	H*/H1 = 14.5695	HAW/H1 = 62.6675
KT = 1	TC1 = .100000E+03	TR1 = .100000F+03	TC2 = .161597E+04	TR2 = .161597E+04		
ITW = 1	GC1 = .203725E+04	GR1 = .298752F-01	QC2 = .274476E+04	QR2 = .203725E+04		
KT = 2	TC1 = .242258E+04	TR1 = .242258F+04	TC2 = .174376E+04	TR2 = .174376E+04		
ITW = 1	GC1 = .276221E+04	GR1 = .102903E+05	QC2 = .275191E+04	QR2 = .276221E+04		
NW = 3	REAL GAS, REF. H/S-C SOLUTION.					
KT = 0	TWEG = 1742.5R	CF1 = .302950E-02	CF1(RE1) = .041782	ROMURA = .23193	H*/H1 = 14.5695	HAW/H1 = 66.1824

KT	=	Number of iterations required in calculating the equilibrium wall temperature (if = 11 then something is wrong).
ITW	=	Type of temperature iteration (= 1 for ideal gas, and = 2 for real gas).
NW	=	Wall temperature and skin-friction calculation flag (input as IS(I,6) on the Mark III Skin Friction Element Data Cards.
TC1	=	First value of temperature at which convective heating is calculated, °R.
TC2	=	Second value of temperature at which convective heating is calculated, °R.
TR1	=	First value of temperature at which radiation heating is calculated, °R.
TR2	=	Second value of temperature at which radiation heating is calculated, °R.
QC1	=	Convective heating rate at TC1, (ft-lb/ft ² sec).
QC2	=	Convective heating rate at TC2, (ft-lb/ft ² sec).
QR1	=	Radiation heating rate at TR1, (ft-lb/ft ² sec).
QR2	=	Radiation heating rate at TR2, (ft-lb/ft ² sec).
TWEG	=	Equilibrium (or input) wall temperature, °R.
CF1	=	Local skin-friction coefficient based on freestream conditions.
CF1(RE1)	=	Normalized skin-friction parameter (for laminar flow N = 2, for turbulent flow N = 5). $CF1(RE1) = C_f(Re_x)^{1/N}$
ROMURA	=	Laminar flow ratio of reference density-viscosity product to free-stream density-viscosity product $(\rho \mu^*/\rho_\infty \mu_\infty)$.

(continued)

MARK III SKIN FRICTION METHOD TEMPERATURE ITERATION OUTPUT (continued)

$H^*/H1$ = Ratio of reference condition enthalpy to freestream enthalpy.
 $HAW/H1$ = Ratio of adiabatic wall enthalpy to freestream enthalpy.

INTEGRAL BOUNDARY LAYER PROGRAM OUTPUT DATA (continued)

The following print out is controlled by the input parameter KPRE.

PRELIMINARY CALCULATIONS

STATION	PRES	UE	ME	POPTZ	VOVCR
1	2958.25952	2387.98625	1.428218	.079981	1.318529
2	614.61515	3549.12281	3.162177	.016617	1.959652
3	547.57253	3720.12664	3.400506	.014804	2.054072
4	424.37944	3765.00329	3.584237	.011474	2.078851
5	366.24570	3791.05978	3.689284	.009902	2.093238
6	317.65107	3811.23494	3.755260	.009129	2.104378
7	277.65107	3824			

- PRES = Static pressure at input station, lb/ft².
- UE = Surface velocity at input station, ft/sec (outside boundary layer).
- ME = Surface Mach number at input station (outside boundary layer).
- POPTZ = Ratio of static pressure at surface to relative total pressure at input station.
- VOVCR = Ratio of relative surface velocity to relative critical velocity at input station.

$$VOVCR = u_e / u_{cr} = \sqrt{\frac{2\gamma R}{\gamma + 1} \frac{T_1}{T_0}}$$

u_{cr} is the speed of sound at Mach 1, and is only a function of relative total temperature.

STATION	X	Y	S	SOL
1	99.00000	15.00000	0.00000	0.00000
2	95.55239	15.00000	4.00000	.04000
3	91.67993	15.00000	8.00000	.08000
4	87.76490	15.00000	12.00000	.12000
5	83.80004	15.00000	16.00000	.16000

- X = X-coordinate of input station, feet.
- Y = Y-coordinate of input station, feet.
- S = Distance along streamline from the first station, feet.
- SOL = Ratio of surface distance at station to the distance at the last station.

INTEGRAL BOUNDARY LAYER PROGRAM OUTPUT DATA (continued)

STATION	AE	TSE	TWAL	TAWL	TAWT	YBAR
1	1672.004	1163.295	1441.790	1569.122	1590.855	1396.606
2	1337.149	744.003	1013.941	1508.379	1549.313	1056.140
3	1173.368	572.907	957.513	1483.592	1532.361	976.290
4	1125.983	527.568	905.128	1477.024	1522.569	946.415

STATION	RW	SW	SUTHL	RMSW	RHSE	HEADW	HEADE	NUM	MURAR
1	0.0	.1	1.050	.119530E-02	.148146E-02	3408.090	4223.995	.642249E-03	.743623E-06
2	20359666.4	.4	1.192	.951247E-03	.129638E-02	5108.497	6961.958	.643879E-03	.637979E-06
3	26804101.0	.4	1.215	.552151E-03	.922823E-03	3532.797	5904.452	.106766E-02	.601071E-06
4	3246508.6	.4	1.228	.426632E-03	.748129E-03	2845.907	4990.499	.135009E-02	.589245E-06
5	70000000.7	.4	1.270	.376663E-03	.672222E-03	2522.531	4574.307	.135009E-02	.589245E-06

AE = Speed of sound at surface point external to the boundary layer, ft/sec.
 TSE = Static temperature at surface point external to boundary layer, °R.
 TWAL = Static wall temperature at surface point (laminar), °R.
 TAWL = Adiabatic wall temperature at surface point based on laminar recovery factor, °R.
 TAWT = Adiabatic wall temperature at surface point based on turbulent recovery factor, °R.
 TBAR = Reference temperature, °R.

RW = Reynolds number at wall.
 SW = Temperature function at wall, $(T_w/T_0) - 1$.
 SUTHL = Value of coefficient k_{su} in Sutherland's viscosity temperature formula.
 RMSW = Static density based on wall temperature, slug/ft³.
 RHSE = Static density based on temperature external to boundary layer, slug/ft³.
 HEADW = Velocity head based on density at wall, lb/ft².
 HEADE = Velocity head based on density external to boundary layer, lb/ft².
 NUM = Kinematic viscosity at wall, ft²/sec.
 MURAR = Dynamic viscosity based on reference temperature, lb-sec/ft².

SURFACE GRADIENTS

STATION	DUDS	DMDS	DMDL
1	222.326076	.255684	25.568416
2	112.145012	.202009	20.200940
3	30.122997	.098870	9.886981
4	12.219773	.037253	3.725300
5	9.071111	.027111	2.711111

STATION	DUDS	DMDS	DMDL
1	=	=	=
2	=	=	=
3	=	=	=
4	=	=	=
5	=	=	=

DUDS = Derivative of surface velocity with respect to surface distance, du_e/dS .
 DMDS = Derivative of surface Mach number with respect to surface distance, dM_e/dS .
 DMDL = DMDS times the surface distance at the last point.

INTEGRAL BOUNDARY LAYER PROGRAM OUTPUT DATA (continued)

LAMINAR DIFFERENTIAL EQUATION - SOLUTION FOR CORLN

NTAB	STAB	CTAB1	ANS1	ANS2	ANS3	ANS4	B	IFM1	TEM3	TEM4	TEM5	TEM6	TEM7
0	0.0000	0.0000	-.120	1.4282	1.4282	25.5684	0.0000	1.4080	.000637	0.0000	2.0307	.00006	0.0000
1	.2000	-.0143	-.120	1.4282	1.4794	25.3000	5.1618	1.4377	.000672	2.1630	1.9058	.00006	.00005
2	.4000	-.0263	-.133	1.4794	1.5305	25.0317	4.9771	1.4685	.000701	2.0348	1.7966	.00005	.00009
3	.6000	-.0365	-.146	1.5305	1.5816	24.7633	4.8233	1.5003	.000725	1.9090	1.7024	.00005	.00013
4	.8000	-.0452	-.159	1.5816	1.6328	24.4949	4.6909	1.5332	.000744	.0000	1.6333	.00005	.00013
5	1.0000	-.0522	-.172	1.6328	1.6840	24.2265	4.5738	1.5674	.000744	.0000	1.5674	.00005	.00013

NTAB = Counter on STAB, CTAB, XTAB, and YTAB tables.
 STAB = Surface distances obtained in solving laminar differential equation.
 CTAB1 = Correlation numbers (CORLN) obtained from CORML while solving laminar equation.
 ANS1,ANS2,ANS3,ANS4 = Values of SW, ME, ME at SS+DEL, and DMDL interpolated by LGRNGE calls in LAMNAR.

B = Temporary variable in LAMNAR and INTL.
 TEM1,TEM3,TEM4,TEM5,TEM6,TEM7 = Temporary variables.

LAMINAR CALCULATION OF INSTABILITY AND TRANSITION LOCATIONS

STATION	CORLN	SHEAR	DTH	FORMTR	SHAPL	RTHI	SHAPK	RCRIT	KBAR	DIFF	RTRAN
1	0.0000	.2246	7.7017	2.2241	0.0000	0.0	0.00000	237.6	.00265	976.4	1352.4
2	.1070	.3315	7.5338	1.6919	2.7721	376.0	.00370	280.0	.00180	952.5	1328.5
3	.1092	.3286	7.4117	1.6603	1.5497	243.9			.00149	943.9	1319.9
4	.0660	.2907	7.0817	1.5874	.9811	228.5					
5	.0638	.2878	7.0260	1.5522	1.0023	228.4					
6	.0810	.3000		1.5403		218.2					

CORLN = Correlation number.
 SHEAR = Shear parameter in LAMNAR.
 DTH = δ_{tr}/θ_{tr} in LAMNAR.
 FORMTR = Transformed form factor, H_{tr} .
 SHAPL = Pohlhausen shape factor based on boundary-layer thickness.
 RTHI = Incompressible momentum-thickness Reynolds number.
 SHAPK = Dimensionless shape factor based on momentum thickness.
 RCRIT = Critical incompressible momentum-thickness Reynolds number.
 KBAR = Mean shape factor based on momentum thickness.
 DIFF = Difference between transition and instability momentum-thickness Reynolds numbers.
 RTRAN = Incompressible momentum-thickness Reynolds number used in checking for transition point.

Note: Transition occurs when RTHI approaches RTRAN.

INTEGRAL BOUNDARY LAYER PROGRAM OUTPUT DATA (continued)

TURBULENT DIFFERENTIAL EQUATIONS - SOLUTION FOR F AND FURMI

S	F	FURMI	S	F	FURMI	S	F	FURMI	S	F	FURMI
0.05445	591.0	1.6570	0.06451	182.7	1.4540	0.07450	750.9	1.4214	0.08402	4015.0	1.4447
0.05460	1242.5	1.4545	0.10473	1401.9	1.4224	0.11479	1074.5	1.4108	0.12485	1800.9	1.4000
0.13490	2085.9	1.5944	0.14496	2400.1	1.3855	0.15502	4490.4	1.3805	0.16507	2695.1	1.3702
0.17513	2897.8	1.5721	0.18519	3099.2	1.3683	0.19524	5300.2	1.3648	0.20530	3501.5	1.3548
0.21536	3709.2	1.5500	0.21521	3798.5	1.3515	0.22527	6100.4	1.3491	0.23533	4302.8	1.3441

S = Distance along surface from first point, feet.
 F = Function of transformed momentum thickness, f.
 FORMI = Adiabatic form factor, H_1 .

PRINCIPAL BOUNDARY LAYER INFORMATION

INSTABILITY OCCURS AT STATION 2

TRANSITION DOES NOT OCCUR

SEPARATION DOES NOT OCCUR

LAMINAR BOUNDARY LAYER = STATIONS 1 TO 26

TURBULENT BOUNDARY LAYER DOES NOT OCCUR

STATION	X	S	DELSR	THET	DELTA	FORM	FURMI
1	99.000000	0.000000	0.000000	0.000000	0.000000	3.4804	2.5266
2	95.552387	4.000000	0.01761	0.00370	0.003990	4.7521	2.7331
3	91.679933	8.000000	0.03800	0.00600	0.007411	6.3363	2.8401
4	87.764901	12.000000	0.05592	0.00831	0.010411	6.7279	2.8104
5	83.819939	16.000000	0.07025	0.01011	0.012890		
6	79.860259	20.000000	0.08618				

X = X-coordinate, feet.
 S = Surface distance from first point, feet.
 DELSR = Displacement thickness, δ^* , feet.
 THET = Momentum thickness, θ , feet.
 DELTA = Full boundary-layer thickness, δ , feet.
 FORM = Form factor, H.
 FORMI = Adiabatic form factor, H_1 .

INTEGRAL BOUNDARY LAYER PROGRAM OUTPUT DATA (continued)

STATION	CF	TAUW	RTH	DTDY	NUSS	HTRAN	CRN
1	0.00000	0.00000	0.0	0.00	0.00	0.0000	2.026
2	.00026	1.31777	1885.8	165470.13	1338.65	410.9606	3.572
3	.00020	.69123	2009.5	89581.96	1362.26	222.4852	3.505
4	.00015	.41958	2248.5	69119.43	1502.88	171.6646	2.899
5	.00013	.33300	2481.5	58058.70	1624.95		

- CF = Skin friction coefficient at wall, C_f .
- TAUW = Shear stress at wall, lb/ft².
- RTH = Momentum-thickness Reynolds number.
- DTDY = Slope of temperature profile at wall, °R/ft.
- NUSS = Local Nusselt number, Nu_x .
- HTRAN = Heat transfer per unit area, ft-lb/sec-ft².
- CRN = Reynolds analogy parameter, C_{fR_w}/Nu_x .

VELOCITY PROFILES

STATION	Y/DELTA	Y	Y/XMAX	U	U/UE
0.0000	0.	0.	0.	0.00	0.0000
.0500	.199475E-03	.242691E-01	.391.84	.1196	
.1000	.398951E-03	.485382E-01	.759.62	.231A	
.1500	.598426E-03	.728073E-01	1102.21	.3363	
.2000	.797902E-03	.970764E-01	1418.78	.4329	
.2500	.997377E-03	.12134A	1708.73	.5214	
.3	1.197	.151	197.	.6	

- Y/DELTA = Boundary layer profile station, distance from surface / full boundary-layer thickness.
- Y = Distance from surface, feet.
- Y/XMAX = Distance from surface divided by the maximum value of X (X at last input station).
- U = Velocity within boundary layer, ft/sec.
- U/UE = Velocity within boundary layer divided by the velocity outside of the boundary layer at the station.

Note: Boundary layer velocity profiles will be printed for each surface station on the streamline.

FORCE SUMMATION OUTPUT DATA

The output data produced by the force summation routine is identical to that produced within the inviscid and viscous routines except for the addition of a tabulation of the summation data set and panel numbers used. This output is shown below.

SUPERSONIC/HYPERSONIC ARBITRARY-BODY PROGRAM, MARK IV MOD 0

PAGE 227

CASE

LAMINAR SKIN FRICTION

SUMMATION DATA SET NUMBER	3	0	0	0	0	0	0	0	0	0	0	0	0	0	0	0	0	0	0
1	0	0	0	0	0	0	0	0	0	0	0	0	0	0	0	0	0	0	0
2	0	0	0	0	0	0	0	0	0	0	0	0	0	0	0	0	0	0	0
3	0	0	0	0	0	0	0	0	0	0	0	0	0	0	0	0	0	0	0
4	0	0	0	0	0	0	0	0	0	0	0	0	0	0	0	0	0	0	0
5	0	0	0	0	0	0	0	0	0	0	0	0	0	0	0	0	0	0	0
6	0	0	0	0	0	0	0	0	0	0	0	0	0	0	0	0	0	0	0
7	0	0	0	0	0	0	0	0	0	0	0	0	0	0	0	0	0	0	0
8	0	0	0	0	0	0	0	0	0	0	0	0	0	0	0	0	0	0	0
9	0	0	0	0	0	0	0	0	0	0	0	0	0	0	0	0	0	0	0
10	0	0	0	0	0	0	0	0	0	0	0	0	0	0	0	0	0	0	0
11	0	0	0	0	0	0	0	0	0	0	0	0	0	0	0	0	0	0	0
12	0	0	0	0	0	0	0	0	0	0	0	0	0	0	0	0	0	0	0
13	0	0	0	0	0	0	0	0	0	0	0	0	0	0	0	0	0	0	0

MACH= 19.085 VEL= 20000.0 FT/SEC RE/FT = .44161E+06
ALT = 20000.
AIR

S REF = 152.00 SPAN = 8.30 MAC = 50.00
X CG = -18.60 Y CG = 0.00 Z CG = 1.00

FORCE DATA	C D	C L	C A	C Y	C N
ALPHA	L/D	C M	C LL	C LN	
BETA					
5.00	.01734	.01624	.01585	0.00000	.01769
0.00	.93689	.00021	0.00000	0.00000	
7.00	.02045	.04175	.01521	0.00000	
0.00	2.04188	0.00000		

In the sample shown above the summation data set printed is the result of the summation of 11 different sets of data. The first set consisted of data for panels #1 and #2. The second consisted of panels #3 and #4, the third set had only panel #5, etc.

STREAMLINE OPTION OUTPUT DATA

The basic output data from the Streamline Option is shown below.

```

STREAMLINE NUMBER 2
IPRINT= 2 ISAVE= 2 ISTART= 0 ISTOP= 0 ISMODE= 0
IPANL = 1 L = 22 DELTAS= 2.0000 XSI= -0.0000 YSI= -0.0000 ZSI= -0.0000

S X Y Z MACH P/PINF T/TINF
0.0000 99.0000 5.0000 -1.9950 1.4282 12.1439 2.9830
4.0000 95.5524 5.0000 -2.9448 3.1622 2.5230 1.3442
8.0000 91.6799 5.0000 -3.9302 3.4005 2.2478 1.2771
12.0000 87.7649 5.0000 -4.7631 3.5842 1.7421 1.1774
16.0000 83.8199 5.0000 -5.4362 3.6893 1.5035 1.1267
20.0000 79.8747 5.0000 -6.0045 3.7577 1.3861 1.0861

IPRINT = Print flag (input).
ISAVE = Data save flag (input).
ISTART = Streamline starting condition flag (input).
ISTOP = Stagnation point calculation flag (input).
ISMODE = Streamline mode calculation flag (input).
IPANL = Panel number on unit 4 for start of streamline (input).
L = Element number in panel for the start of streamline (input).
DELTAS = Streamline integration distance step interval (input).
XSI = X-coordinate of the streamline starting point (input).
YSI = Y-coordinate of the streamline starting point (input).
ZSI = Z-coordinate of the streamline starting point (input).
S = Surface distance from the streamline starting point.
X = X-coordinate of the streamline point.
Y = Y-coordinate of the streamline point.
Z = Z-coordinate of the streamline point.
MACH = Mach number at the streamline point.
P/PINF = Pressure ratio (P/P∞) at the streamline point.
T/TINF = Temperature ratio (T/T∞) at the streamline point.
    
```

APPENDIX A

INVISCID PRESSURE CALCULATION METHODS

An important feature of the Supersonic-Hypersonic Arbitrary-Body Program is the number and variety of pressure calculation methods available to the user. The significance of this capability can be felt in two ways. First, a proper choice of the method to be used on each component of a vehicle will give reliably accurate aerodynamic characteristics. Second, when the choice of methods is not clear several methods may be tried, the results compared, and a logical interpolation of the data used. The analysis of arbitrary complex shapes poses a difficult problem for the aerodynamicist as he must decide for a particular shape, Mach number, angle of attack range, and altitude, which pressure calculation method will give the most correct results. No computer program will be able to relieve the aerodynamicist of this task. Thus the quality of answers which can be obtained is related to the personal background and experience of the program user in the area of supersonic-hypersonic aerodynamics. Of course, if the program does not contain a pressure method suitable for a given problem, the user must attempt to devise one and add it to the program.

This Appendix presents a brief comparison of the various pressure calculation methods provided in this program. To assist the less experienced user a brief discussion is also presented of the more important pressure methods and of the key factors involved in selecting a method for a particular application.

COMPARISON OF METHODS

Presented in this section is a comparison of the force calculation methods available within the program. The comparison has been divided into three groups: (1) analysis techniques generally used for pointed slender configurations, (2) analysis methods for blunt shapes, and (3) force predictions in the free molecular regime.

Figures A-1 and A-2 present the pressure coefficient variation with impact angle for analysis techniques generally used on pointed slender components. Also presented for comparison purposes is the modified Newtonian theory with $K = 2.4$. This is the limiting value for wedge type flow as proposed by Lees in Reference 2. Figures A-3 to A-6 present the same data over a smaller impact-angle range. At $M = 20$ the modified Newtonian and the tangent-wedge empirical methods compare favorably with the "exact" oblique-shock calculations for impact angles from 0° to over 30° .

Figures A-7 and A-8 present a comparison of various techniques for both pointed and blunt configurations in expansion flow. It should be noted that the Van Dyke Unified method for expansion flow has been modified such that if a pressure coefficient of less than $-1/M^2$ is calculated

Contrails

for a given expansion angle the pressure coefficient is set equal to $-1/M^2$. This limiting value of pressure coefficient has been derived from analysis of experimental data (see References 3 and 4).

Blunt-body pressure-coefficient calculations are compared in Figures A-9 to A-12. The pressure-coefficient variation with impact angle is plotted in the form C_p/C_{pSTAG} as suggested by Lees in Reference 2.

The calculations for Newtonian Prandtl-Meyer utilized stagnation conditions behind a normal shock in an ideal gas.

Comparison of Free Molecular Flow calculations by the program and data presented in Reference 5 are shown in Figures A-13 through A-16. Flat-plate lift and drag coefficients are compared in Figure A-13, assuming specular reflection. Figures A-14 and A-15 present the lift and drag of a flat plate for the more realistic diffuse-reflection assumption. Finally, the drag coefficient for a sphere with both specular and diffuse reflection assumption is shown in Figures A-16.

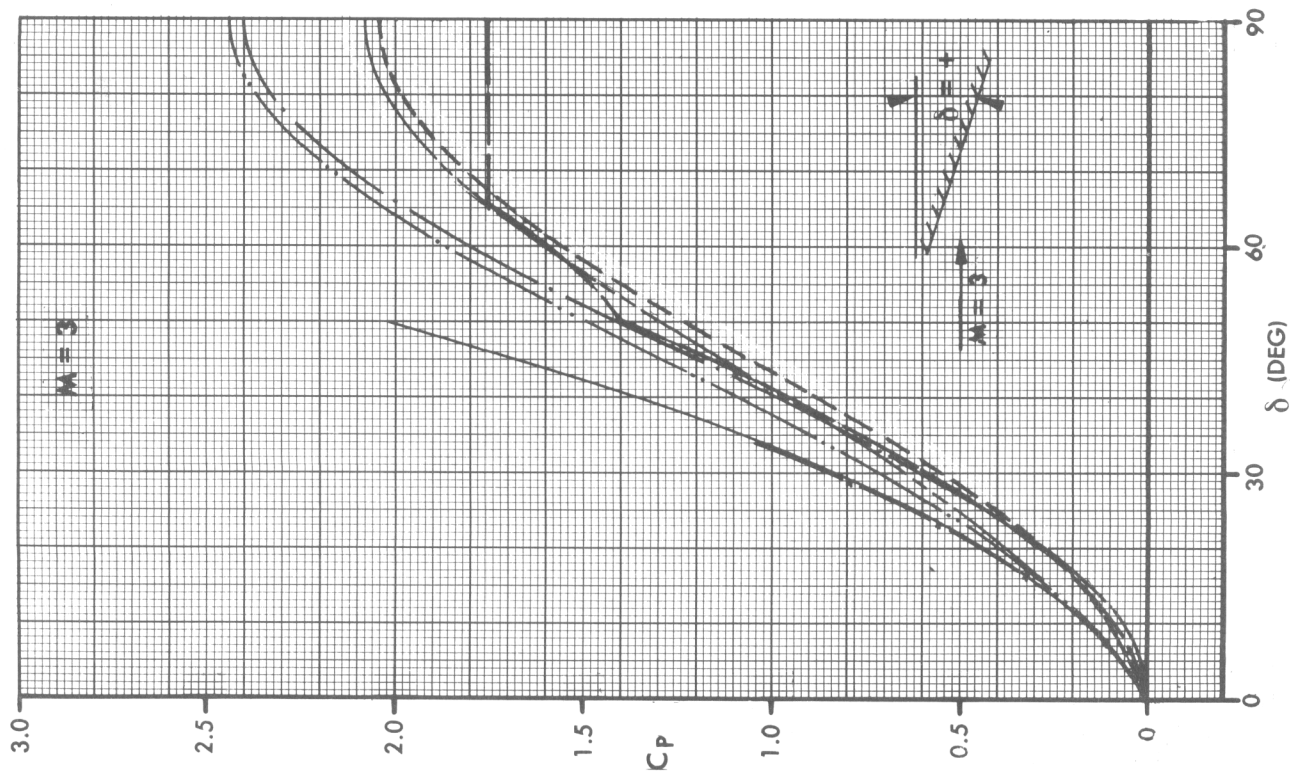
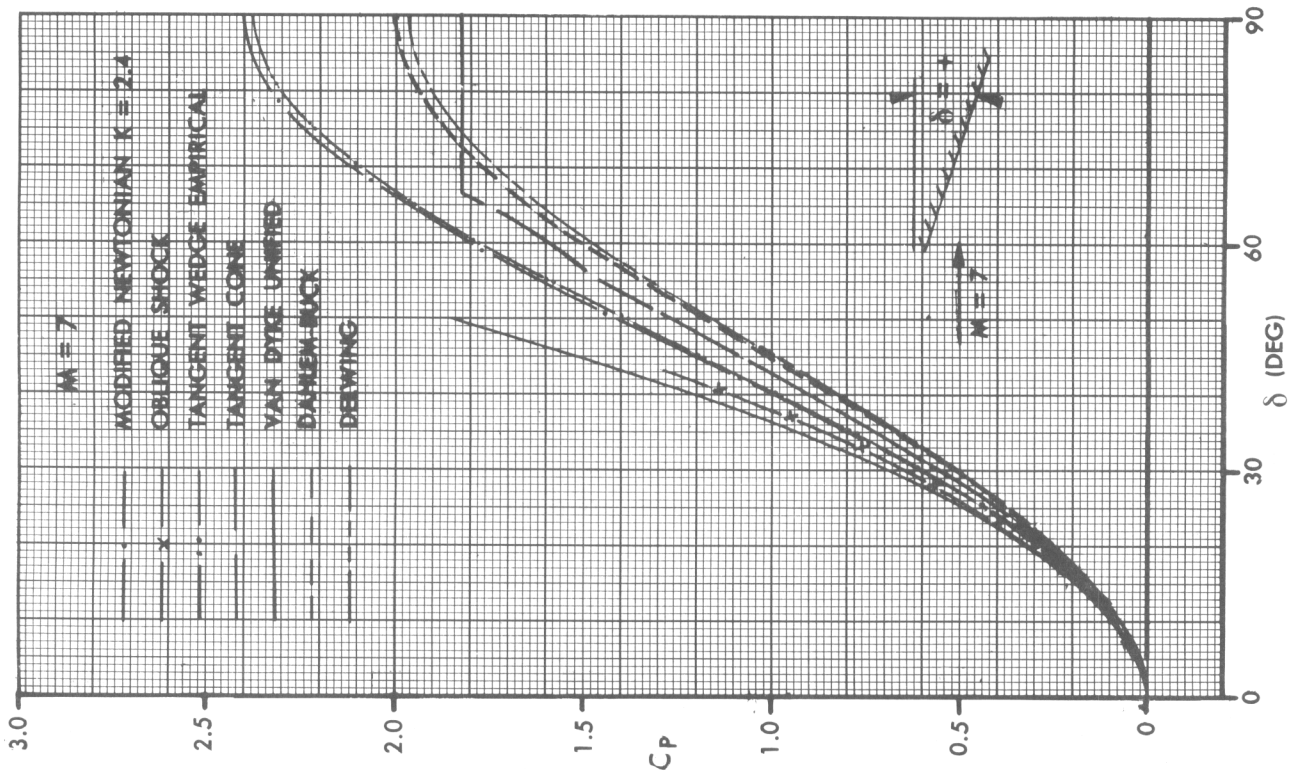

Figure A-1. Comparison of Pressure Prediction Methods for Sharp Bodies in Compression Type Flow

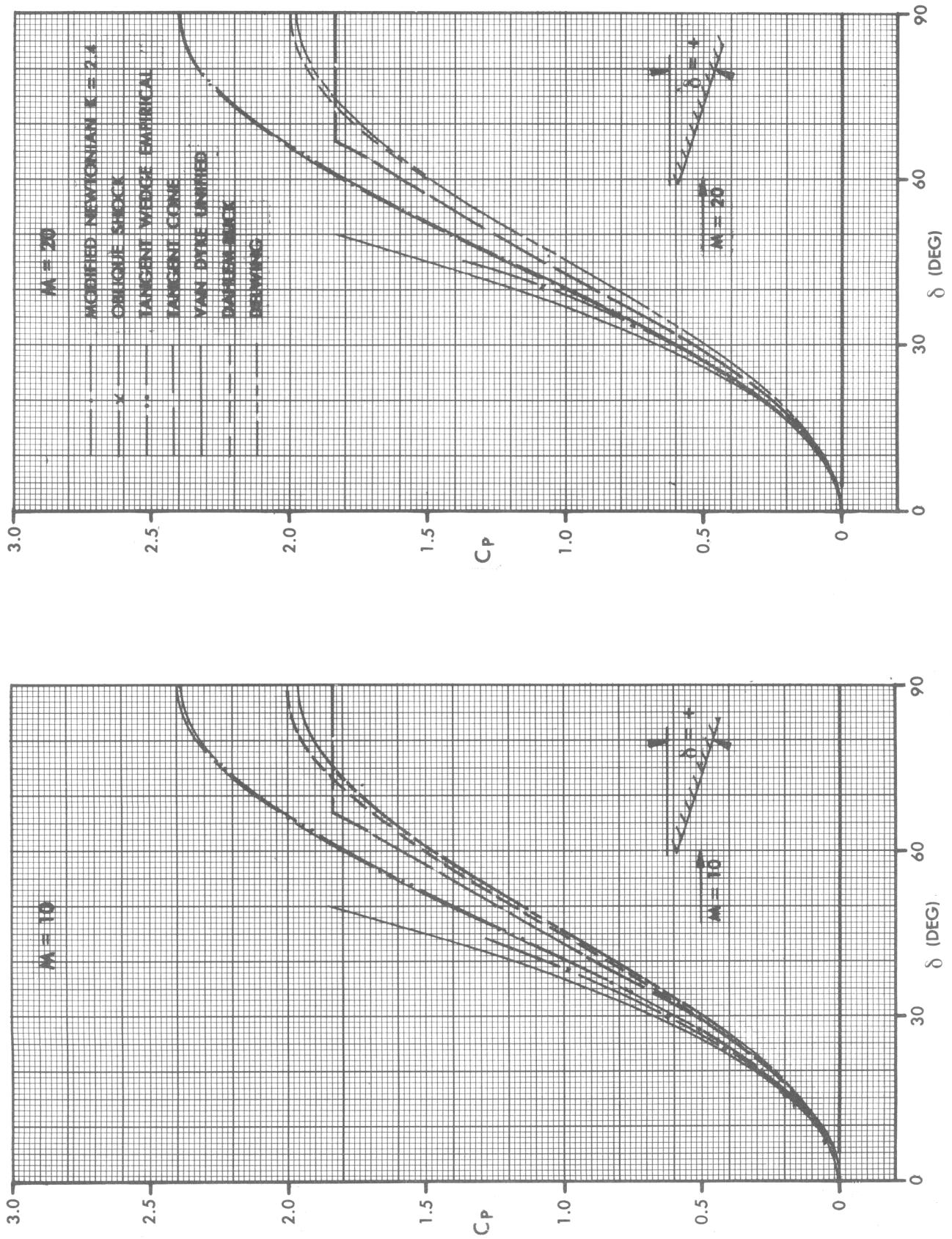

Figure A-2. Comparison of Pressure Prediction Methods for Sharp Bodies in Compression Type Flow

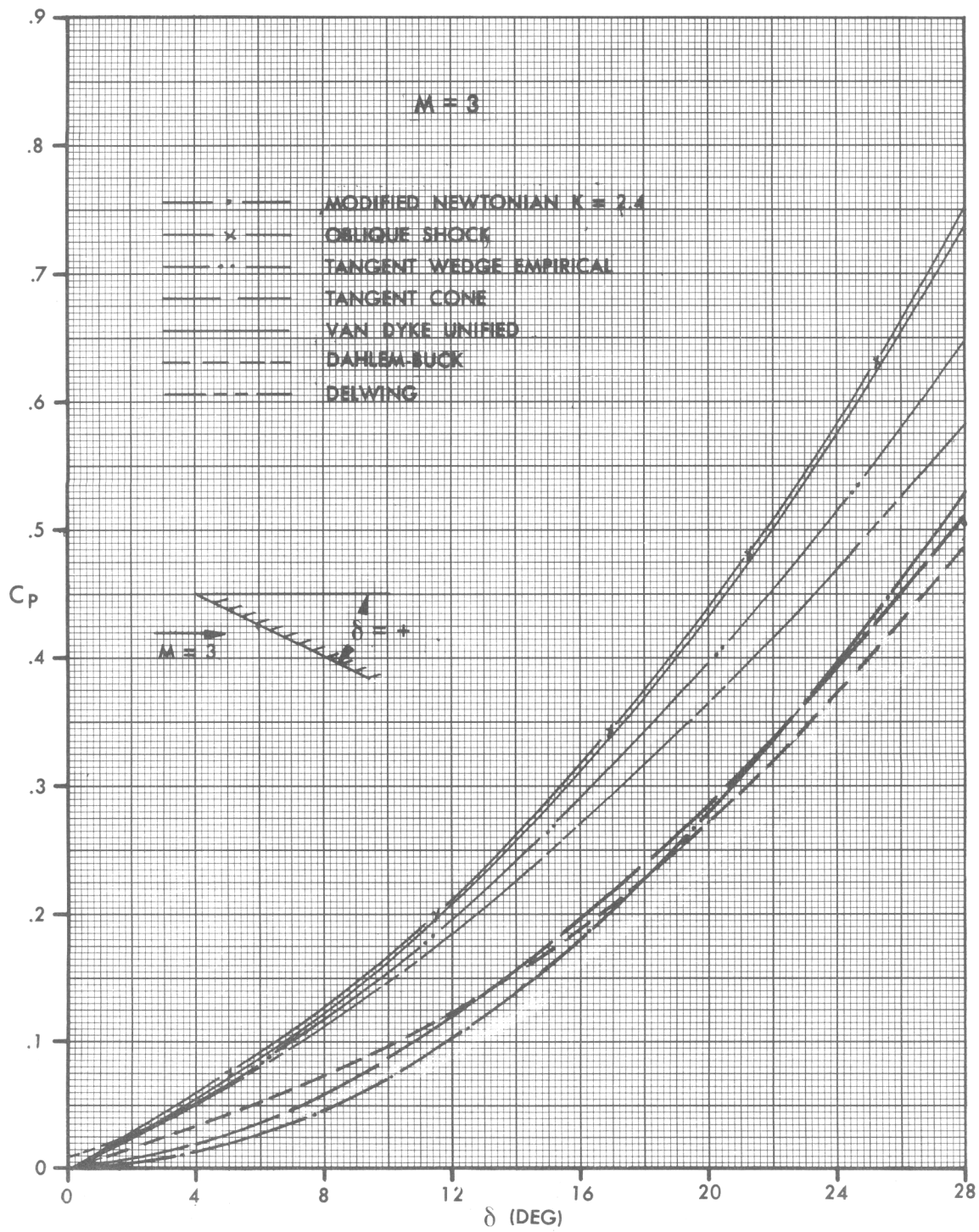

Figure A-3. Comparison of Pressure Prediction Methods for Sharp Bodies in Compression Type Flow

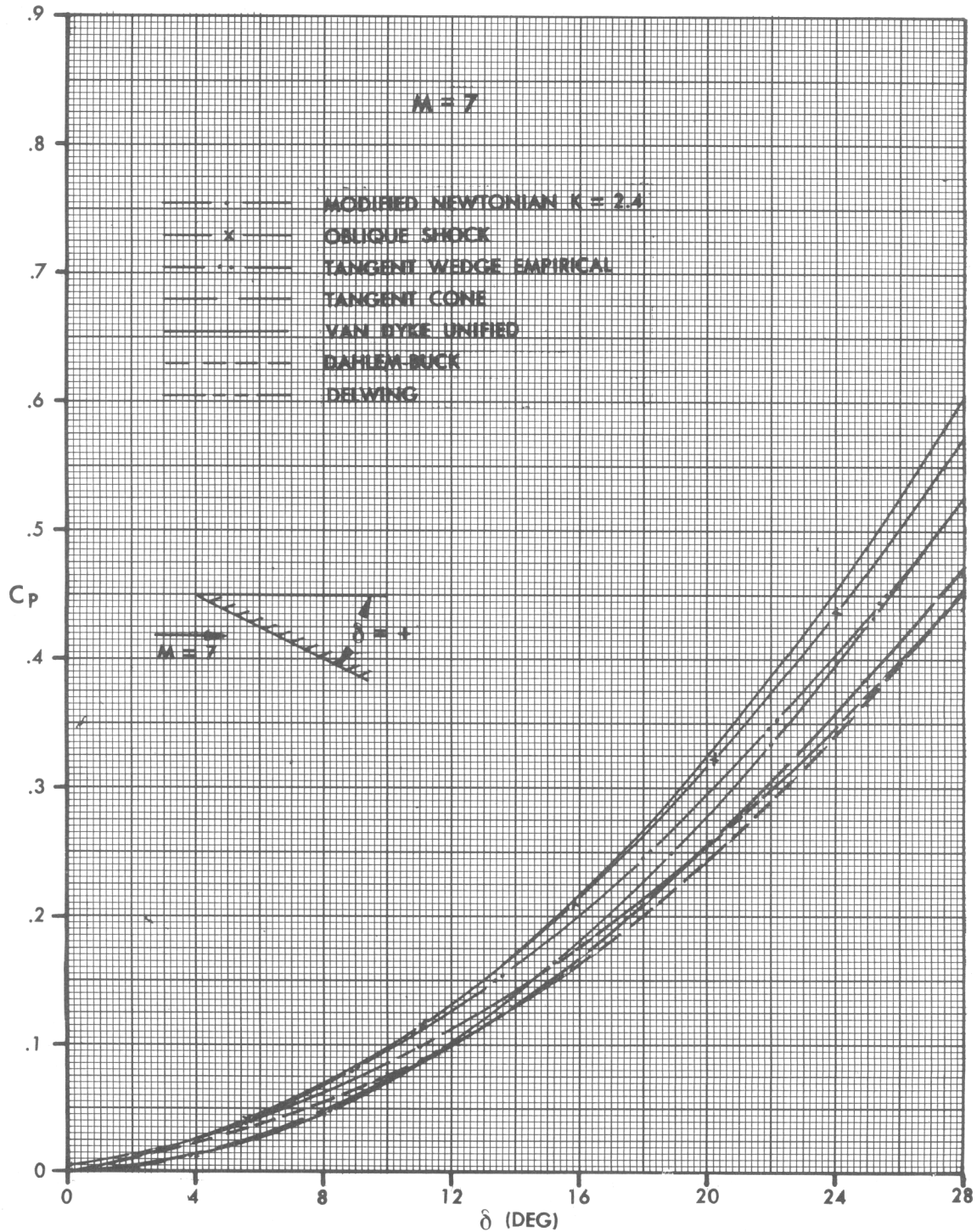

Figure A-4. Comparison of Pressure Prediction Methods for Sharp Bodies in Compression Type Flow

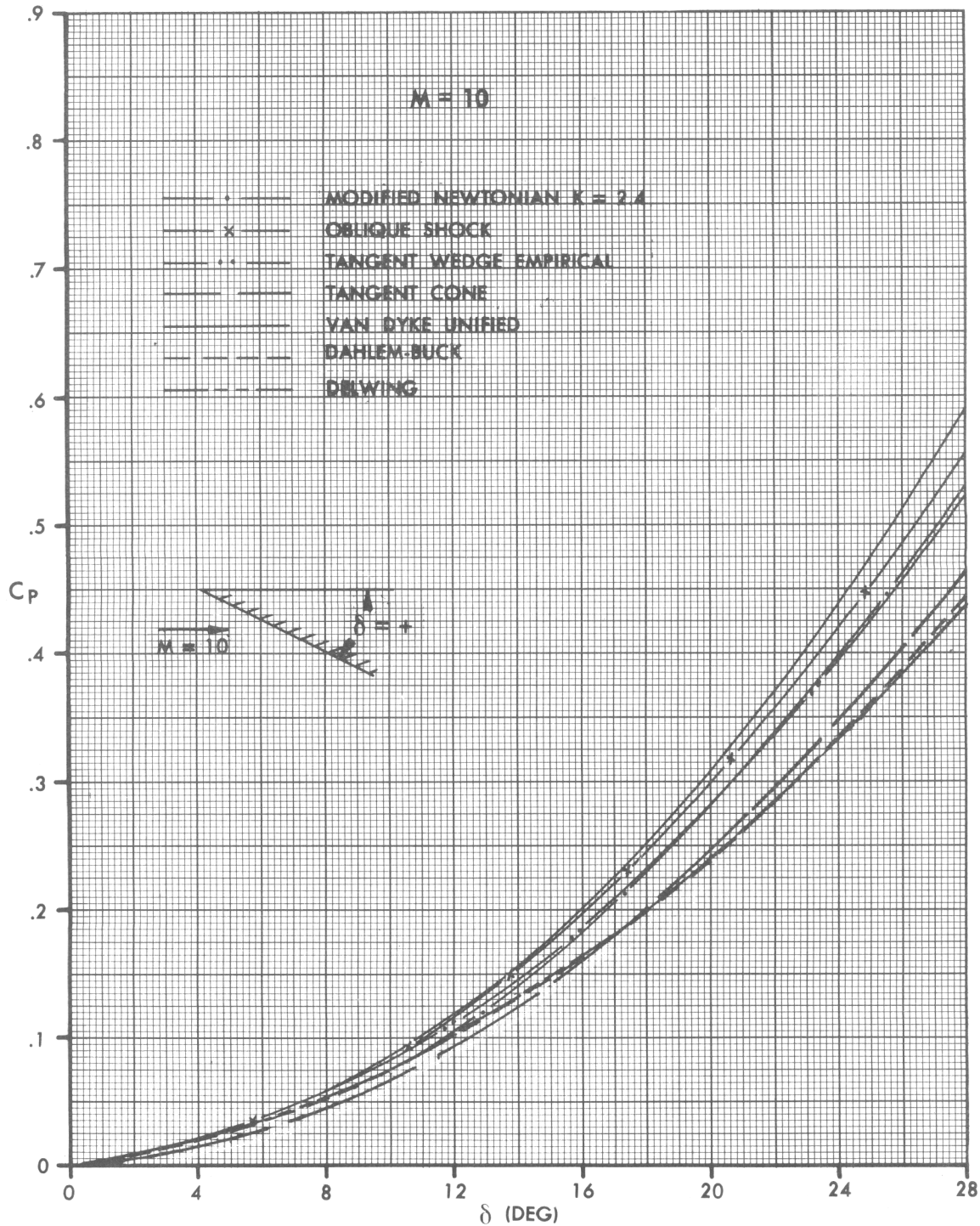

Figure A-5. Comparison of Pressure Prediction Methods for Sharp Bodies in Compression Type Flow

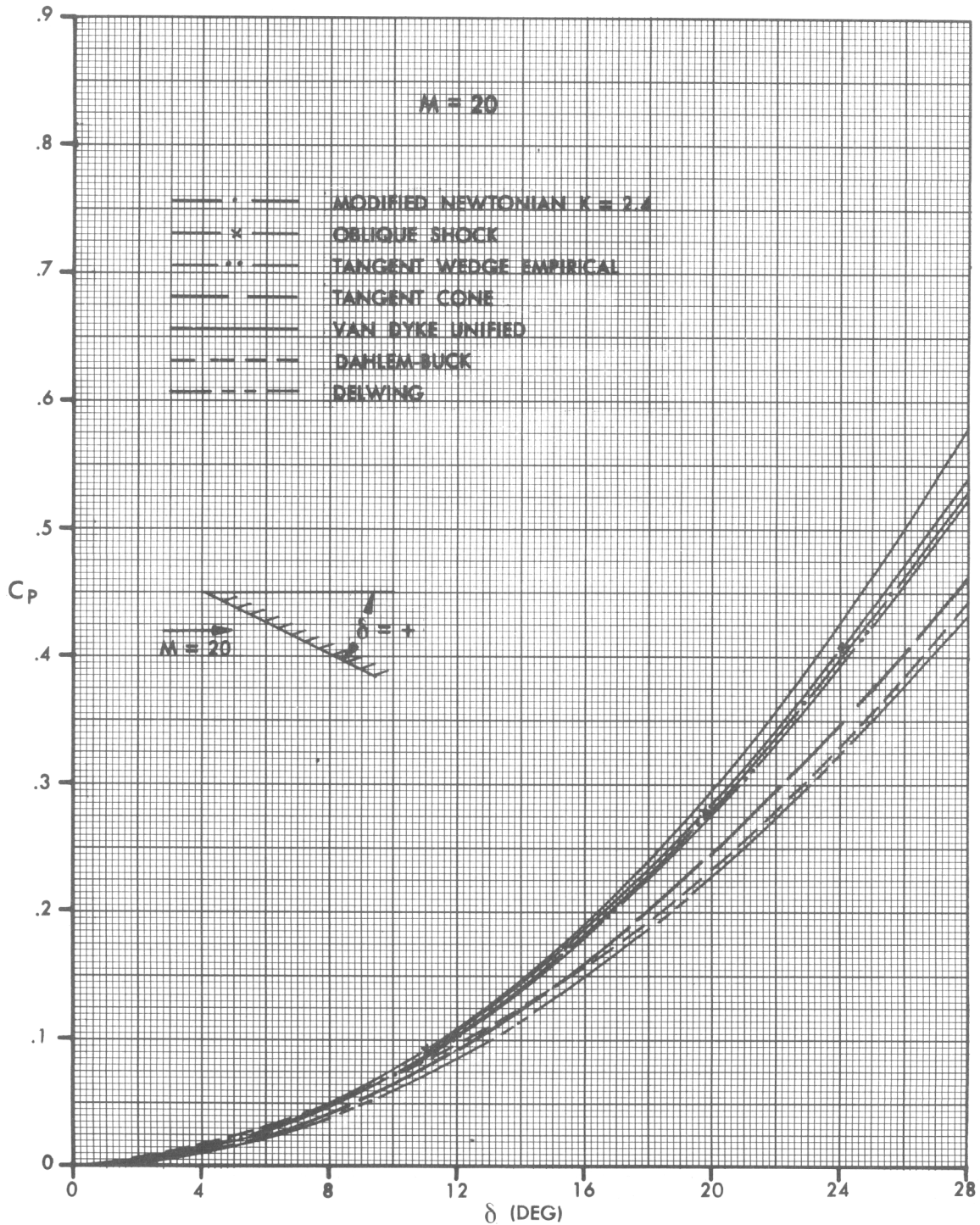

Figure A-6. Comparison of Pressure Prediction Methods for Sharp Bodies in Compression Type Flow

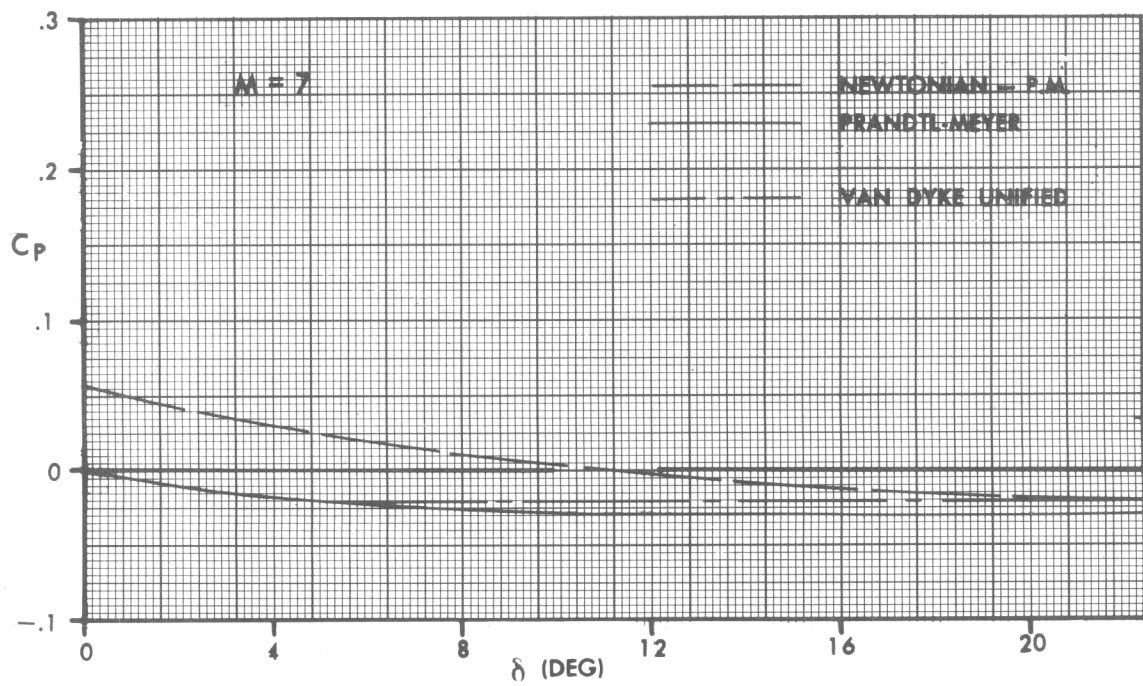
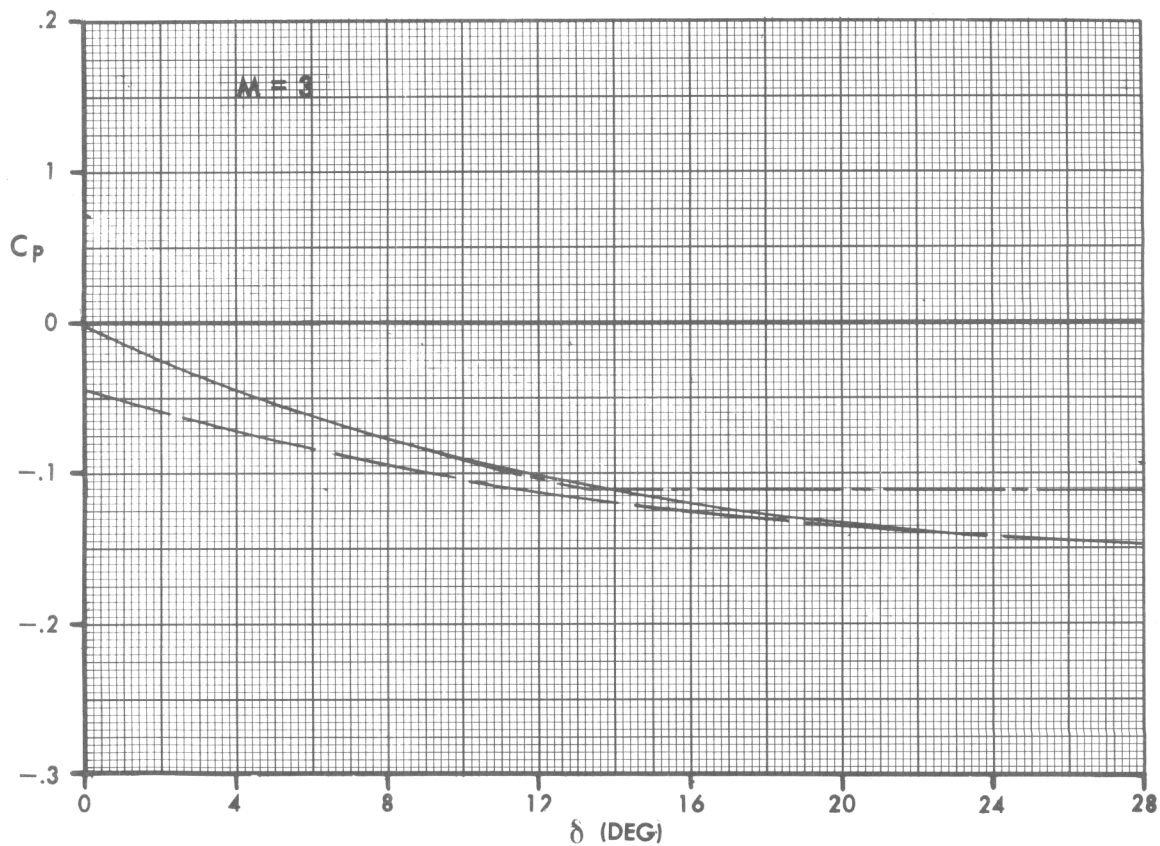

Figure A-7. Comparison of Pressure Prediction Techniques for Expansion Type Flow

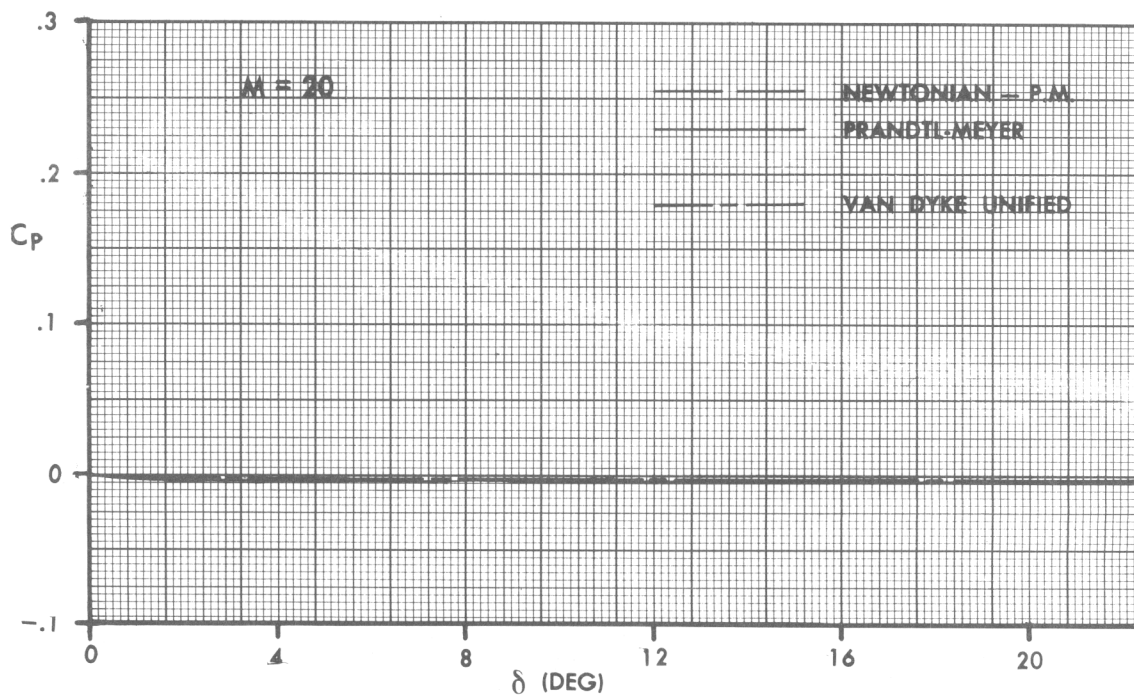
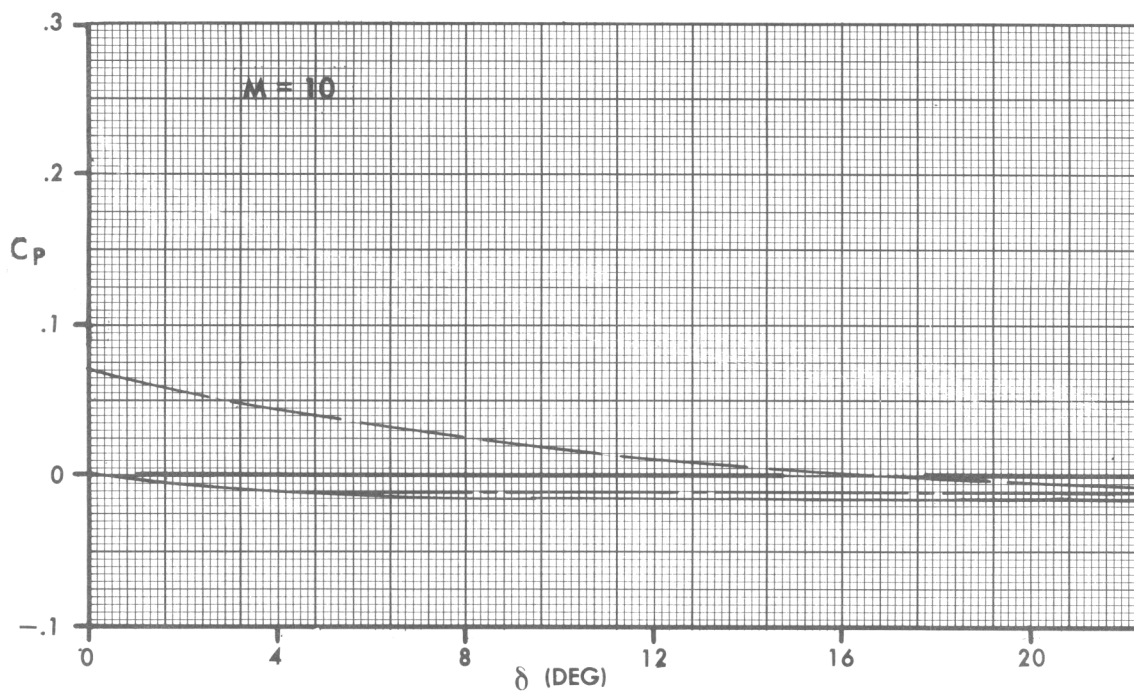

Figure A-8. Comparison of Pressure Prediction Techniques in Expansion Type Flow

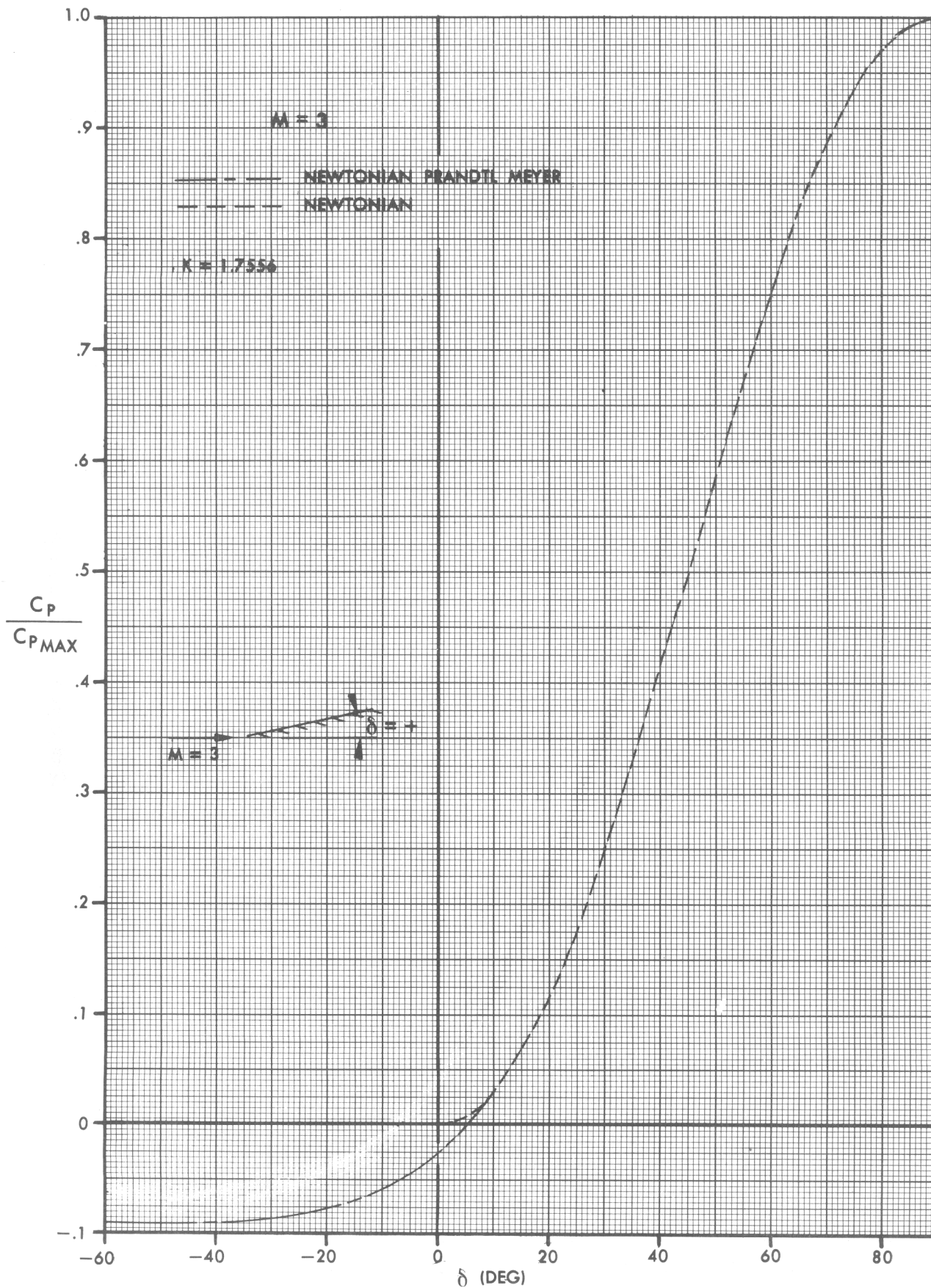

Figure A-9. Comparison of Blunt Body Pressure Estimation Techniques

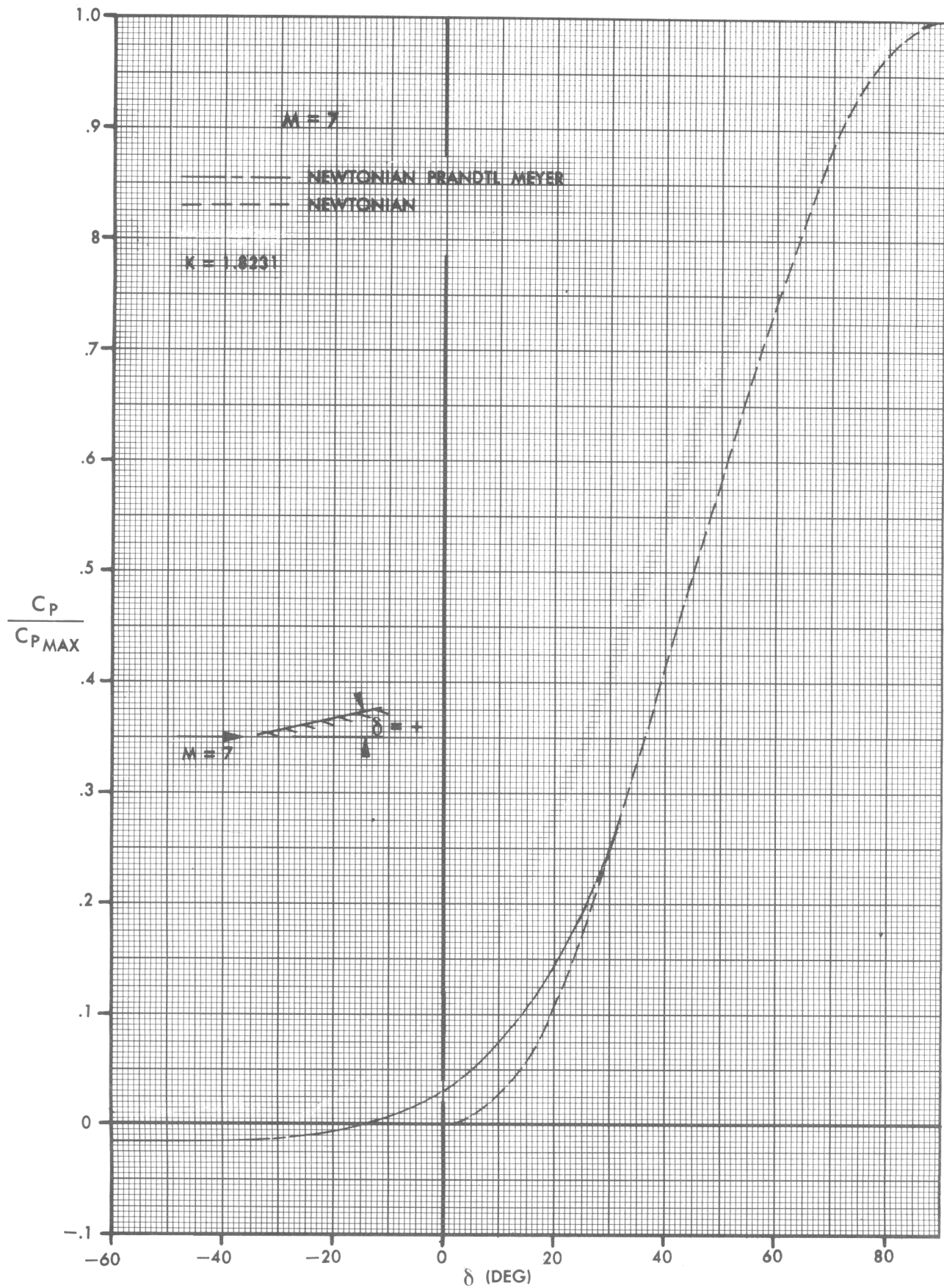

Figure A-10. Comparison of Blunt Body Pressure Estimation Techniques

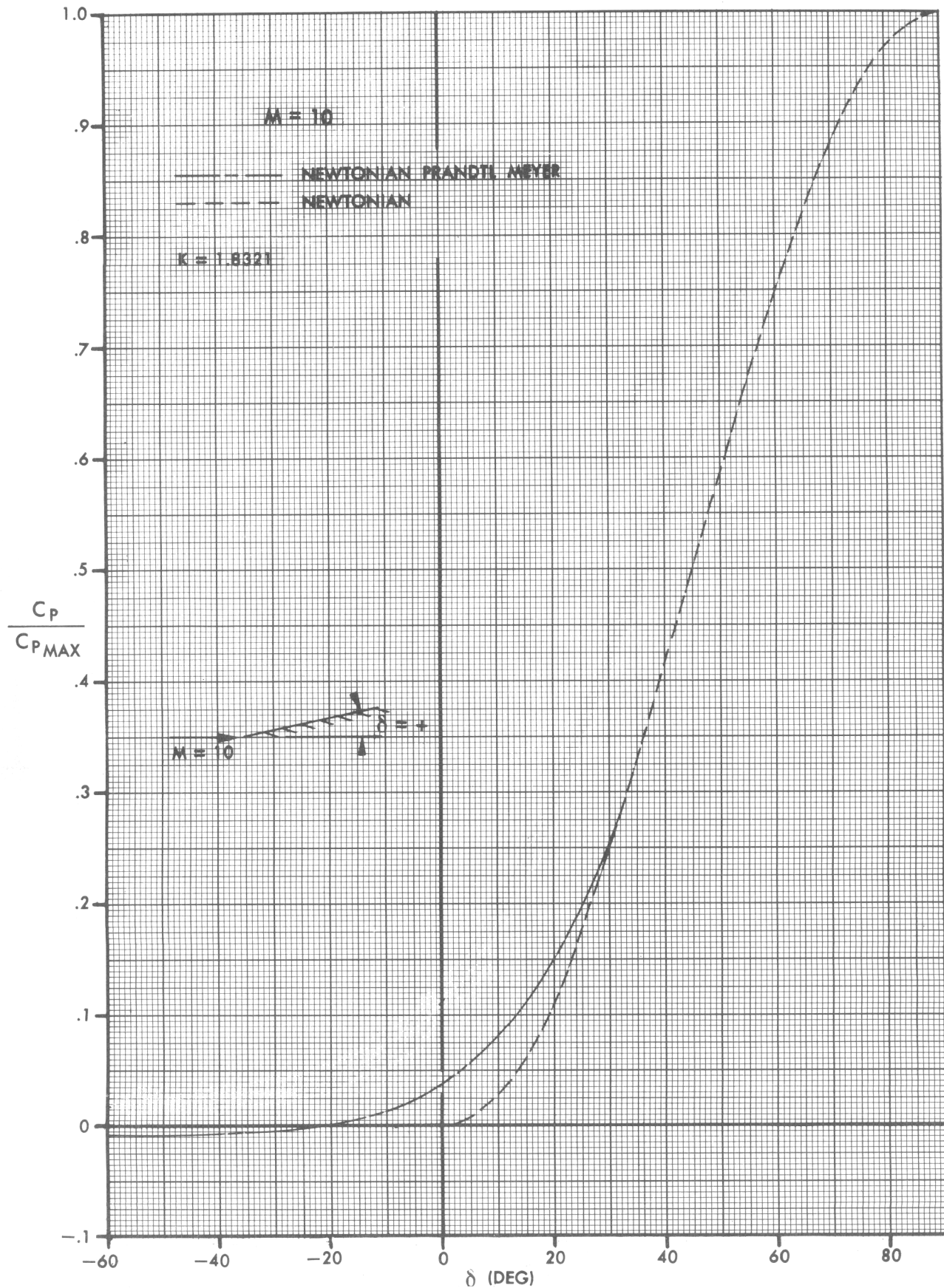

Figure A-11. Comparison of Blunt Body Pressure Estimation Techniques

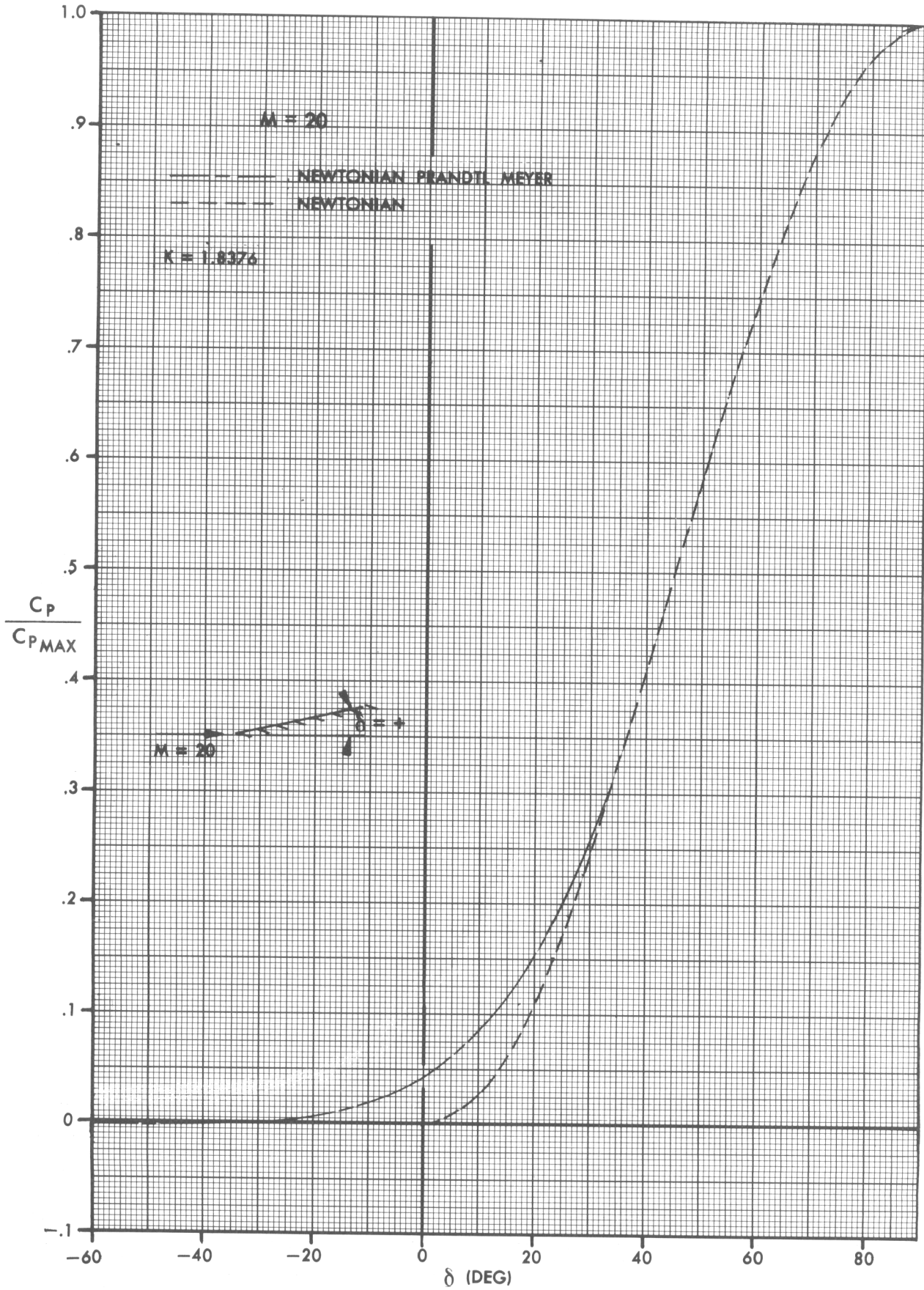

Figure A-12. Comparison of Blunt Body Pressure Estimation Techniques

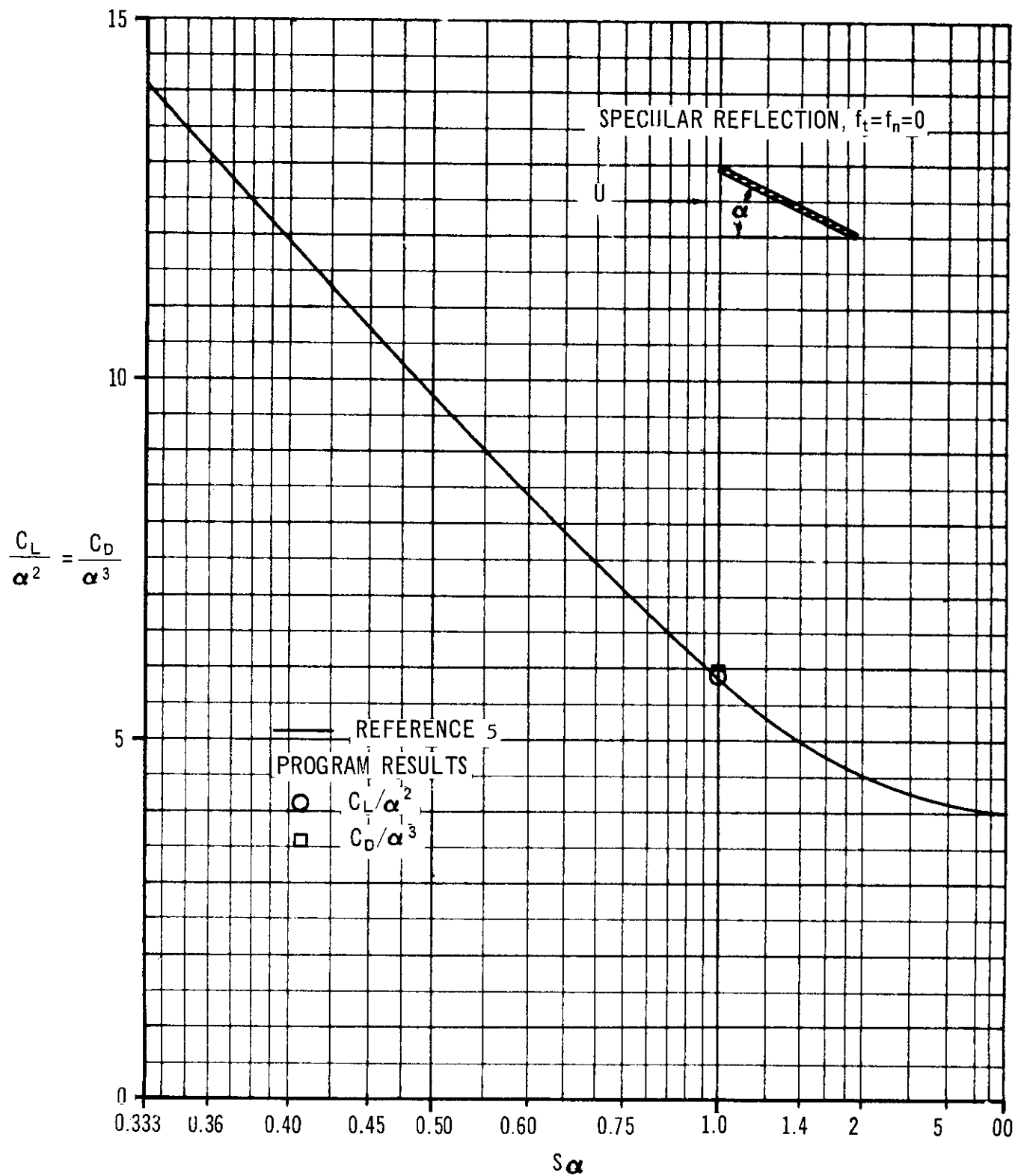

Figure A-13. Comparison of Free Molecular Flow Lift and Drag for a Flat Plate with Specular Reflection

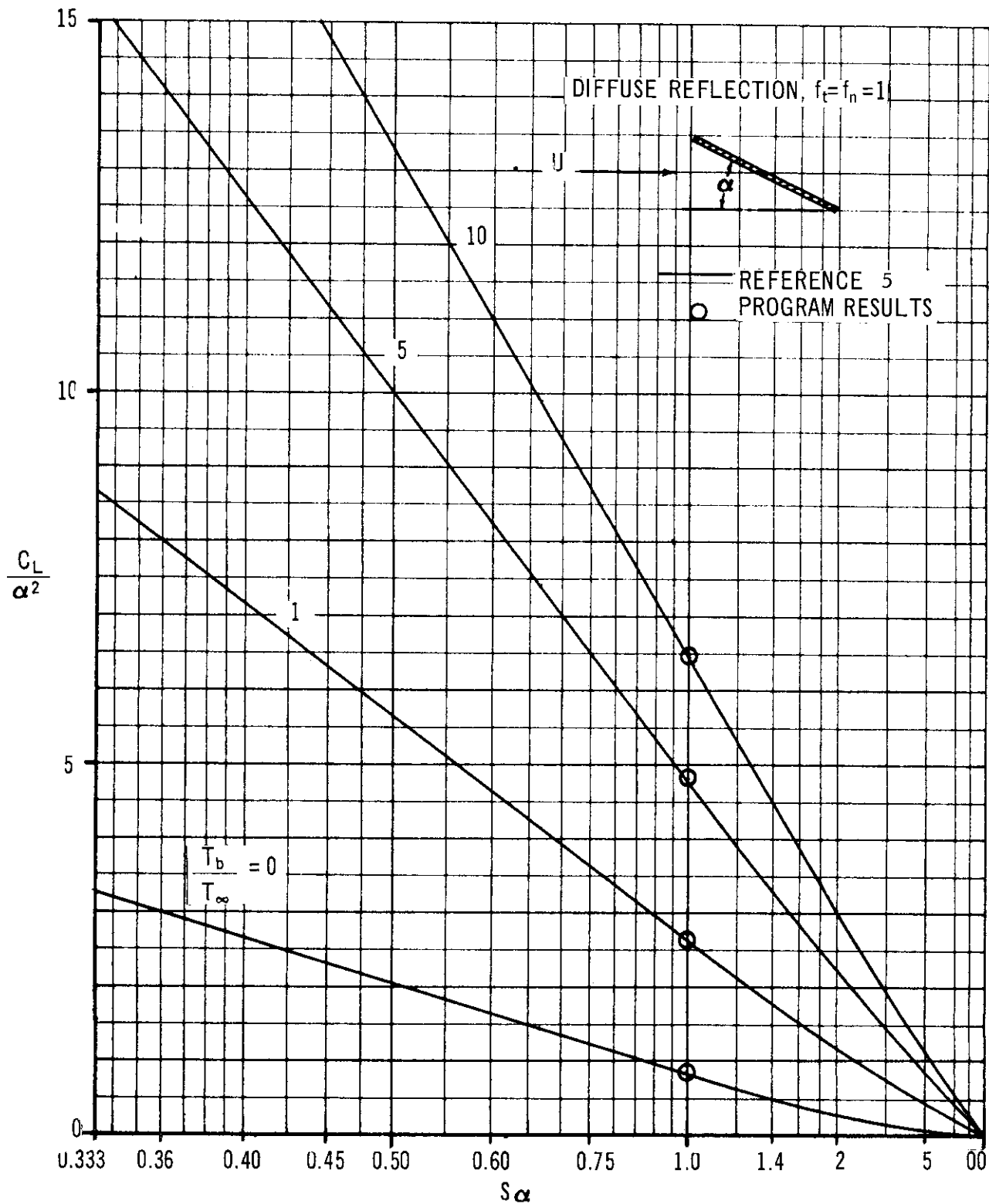

Figure A-14. Comparison of Free Molecular Lift on a Flat Plate with Diffuse Reflection

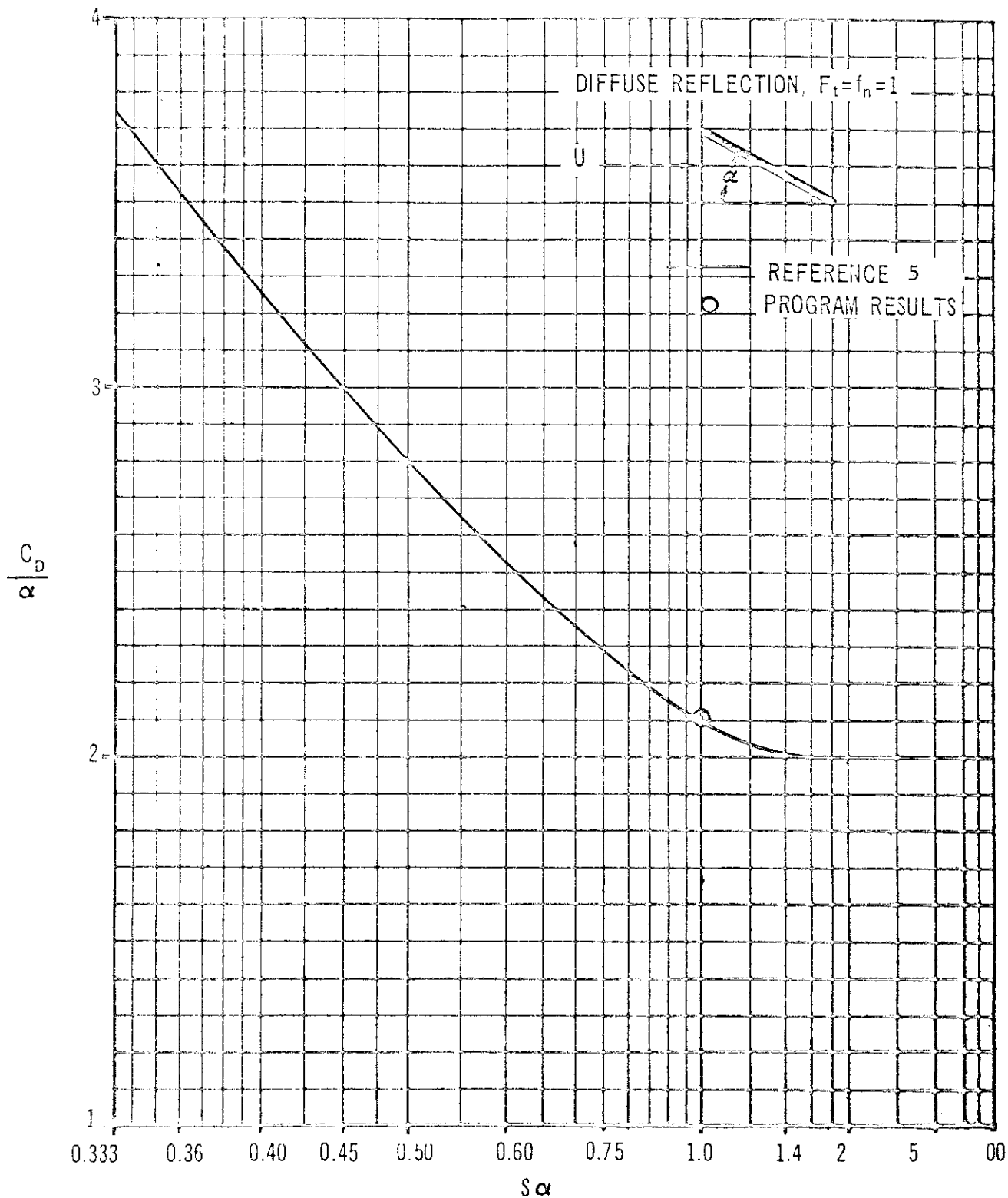

Figure A-15. Comparison of Free Molecular Drag on a Flat Plate with Diffuse Reflection

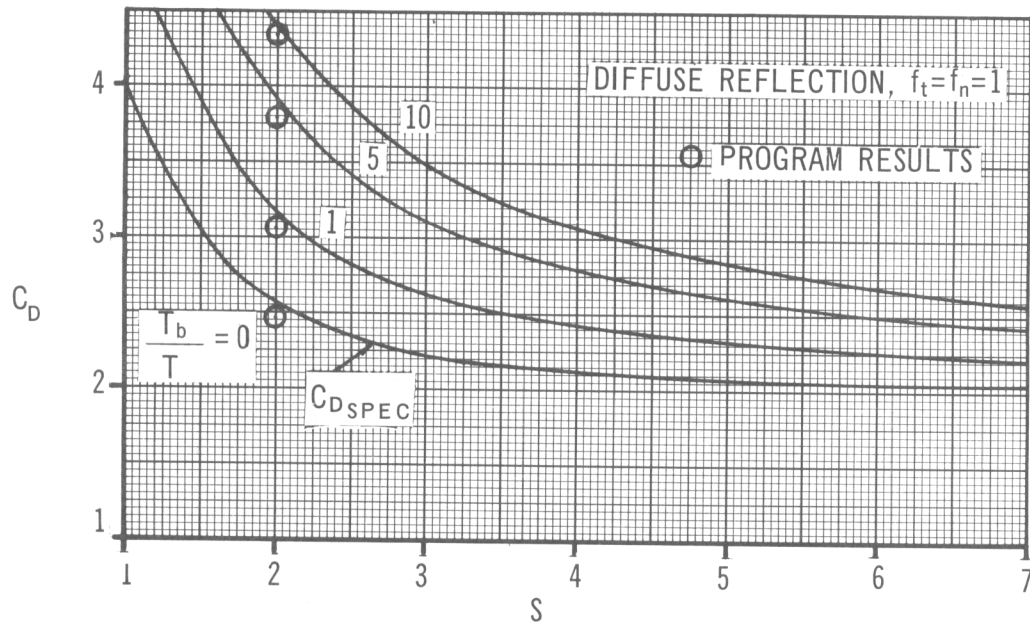

Figure A-16. Comparison of Free Molecular Drag on a Sphere with Diffuse Reflection

DISCUSSION OF PRESSURE METHODS

A brief review of the important features of some of the pressure calculation methods in the program is presented in the following discussions.

MODIFIED NEWTONIAN

Modified Newtonian is one of the most extensively used methods in hypersonic flow analysis. Its great utility lies in its ability to give reasonable answers for a great number of shapes with a very simple calculation technique. The capabilities derived from the ability to use variable K as a function of angle of attack is shown in Figure A-17. As shown in this figure the Modified Newtonian form permits application of tangent wedge (or tangent cone), an empirically defined equation for a given shape, or an effective K for a complete configuration at a given Mach number. Also, the effect of a real gas may be introduced by variation of K for very blunt bodies. In general the use of modified Newtonian theory may be divided into two groups for discussion purposes, (1) aerodynamically blunt configurations and, (2) aerodynamically sharp configurations. By aerodynamically blunt configurations it is meant that, although the leading edge may be sharp and pointed, the impact angle of the nose is greater than that for shock detachment. In true Newtonian flow ($M = \infty$, $\gamma = 1$) the variable K becomes 2.0.

Modified Newtonian (K other than 2.0) techniques have been shown to give reasonable results for a number of blunt bodies. The most commonly used form of modified Newtonian is to input for K the C_p stagnation derived from normal shock relations into the equation below.

$$C_p = K \sin^2 \delta$$

where δ = the surface angle to the free-velocity vector (impact angle)

The effects of a real gas may also be approximated in this manner. The comparison of Newtonian and experimental data is presented in References 6 to 8 for blunt body shapes. In general, modified Newtonian ($C_{p\text{STAG}} = K$) agrees with data for spheres if the Mach number is greater than 3. The pressure distribution on cylinders is not as good as on spheres. However, for impact angles of 90 degrees to approximately 60 degrees the agreement is reasonable but deteriorates as zero impact angle is reached. Nevertheless, for preliminary calculations the induced error in C_N and C_A may be acceptable. Examples of the comparison of modified Newtonian and experiment for spheres and cylinders are shown in Figure A-18. For curved, shock detached bodies with sharp leading edges of either two or three-dimensional shape, References 9 and 10 shown that $C_p = K \sin^2 \delta$ should be modified to the form

$$\frac{C_p}{C_{p\text{max}}} = \frac{\sin^2 \delta}{\sin^2 \delta_{\text{max}}}$$

which is sometimes called the generalized Newtonian theory. Comparison with other bodies is shown in Reference 11.

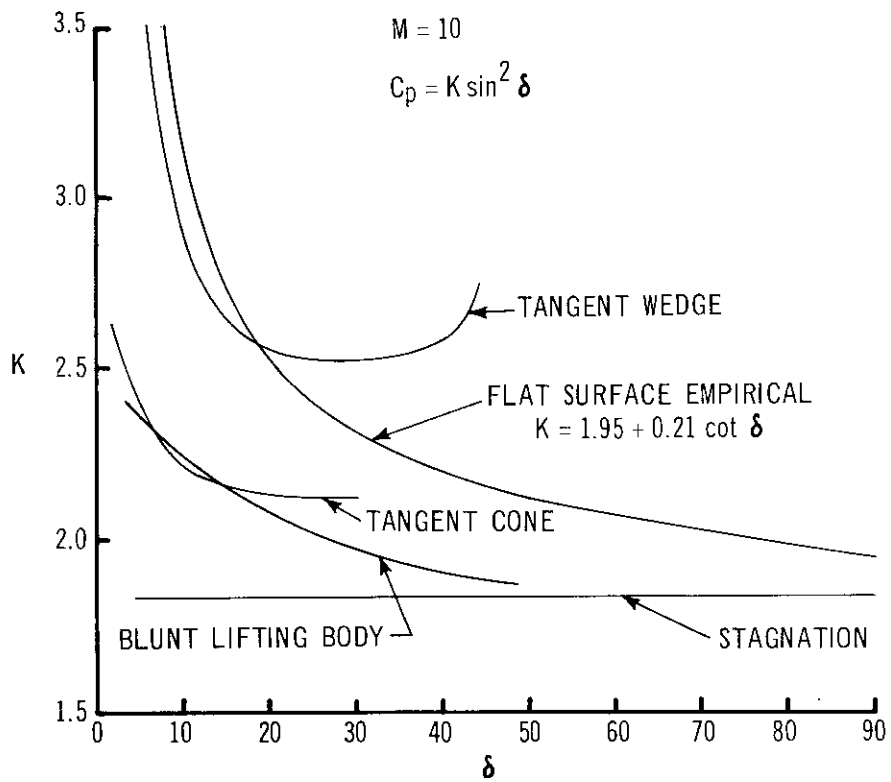

Figure A-17. Modified Newtonian Correlation Factors

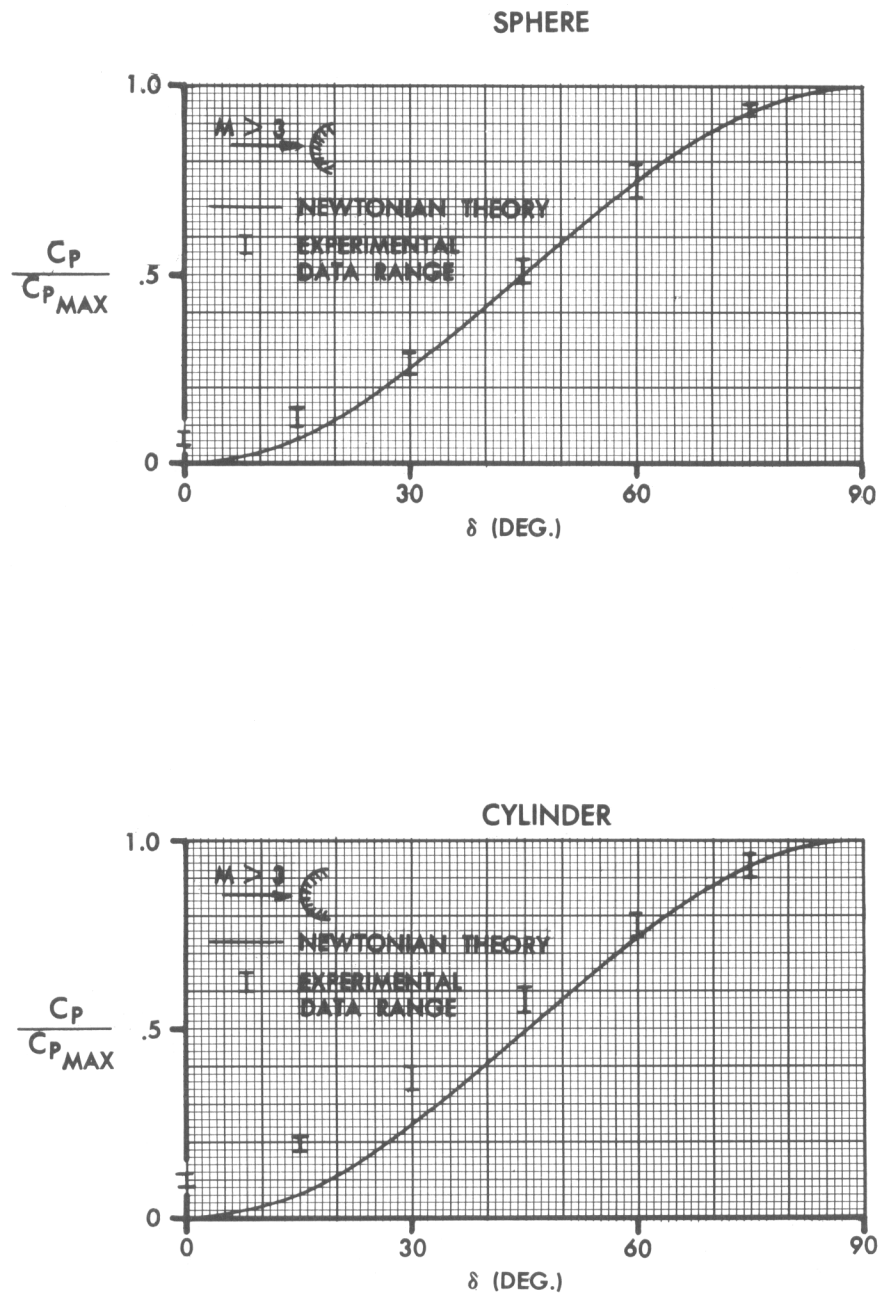

Figure A-18. Comparison of Experimental Pressures and Modified Newtonian Theory for Spheres and Cylinders

Contrails

Many approximations exist for sharp pointed bodies. Figures A-13 through A-16 include one form for the sharp wedge developed by Lees in Reference 2 for large Mach numbers

$$K = (\gamma + 1)$$

Also shown is the limiting form of the cone

$$K = \frac{2 (\gamma + 1) (\gamma + 7)}{(\gamma + 3)^2}$$

For large Mach numbers true Newtonian theory, therefore, closely approximates the limiting case for a cone rather than a wedge.

The main disadvantage of Newtonian theory is its inability to predict the flow field, and for some shapes, this effect can lead to predicted values which may be in serious disagreement with theory. Seiff in References 12 and 13 presents examples of these shapes and a method for obtaining more realistic results from a Newtonian flow concept.

MODIFIED NEWTONIAN + PRANDTL-MEYER

One of the several procedures for analyzing pressures on blunt leading edges is the Newtonian approximation. However, the Newtonian calculations decrease in accuracy downstream of the stagnation point where the impact angle approaches zero. The Modified Newtonian + Prandtl-Meyer calculation method improves the accuracy in the region of small impact angles. This method is fully described in Reference 14. The method provided in this program does not include real gas effects. It should be noted that for some flight conditions the effective value of γ may change significantly across the normal shock, for equilibrium flow of a real gas. In using this method a freestream Mach number greater than about 3 is required because of the matching techniques used for the pressure slopes. If this method is utilized for relatively sharp corners in supersonic flow the methods described above do not allow for the recompression that occurs further downstream. Also, incorrect pressures would be calculated if the slope approaches zero a large distance from the blunt nose since the effect of the reflected expansion waves is neglected. Sweep effects are not calculated using this method at the present time (i.e., the parameter P is calculated using the freestream Mach number). Thus, the modified Newtonian + Prandtl-Meyer force method should be used only in the region of the nose of a blunt body.

TANGENT WEDGE (Oblique Shock)

This force method utilizes the equations of NACA TR-1135 (Reference 15) to calculate the oblique shock pressure and flow parameters. The local element impact angle and freestream Mach number are used in these calculations. The oblique shock relationships are also used in the element strip shock-expansion method.

Contrails

The tangent wedge (oblique shock) method provided in the program is used right up to the wedge shock detachment angle. At higher local impact angles the program automatically switches to the Newtonian + Prandtl-Meyer method. This will give a discontinuity in pressure coefficient as the shock detachment point is passed. This problem can be avoided by the use of empirical tangent-wedge relationships.

As the tangent wedge method uses the local impact angle, the accuracy is configuration dependent. Basically, the tangent wedge approximation depends on the very thin shock layer frequently present at hypersonic speeds. That is, since the shock layer is thin and close to the body there is little change in the flow inclination or the pressure as one proceeds outward from the surface toward the shock. Thus, the values at the surface are assumed to be those immediately behind the shock. The shock angle and related flow parameters are determined by the application of the oblique shock method to a wedge whose angle equals the local impact angle of the body with respect to the freestream velocity vector.

In order to apply the tangent wedge approximation with some degree of confidence the following criteria should hold: (1) the body shape immediately upstream of the point of interest must not be blunt, (2) the density ratio across the shock should be small, and (3) the body curvature should be small, such that centrifugal pressure effects are negligible. These centrifugal force effects give rise to a pressure gradient across the shock layer. Also, these pressure gradients cause the streamlines to change shape and give a gradient in inclination angle across the shock layer.

TANGENT WEDGE EMPIRICAL

Comparison of the tangent wedge empirical method and oblique shock relationship is shown in Figures A-1 and A-2, and again in Figures A-3 through A-6. See TANGENT WEDGE (Oblique Shock) discussion for application criteria.

TANGENT CONE

One of the most versatile force calculation methods is the tangent cone technique. The calculation of cones under various conditions of pitch and yaw are an obvious application. Another application is the highly swept delta wing. For leading edge sweep angles greater than 80 degrees and hypersonic Mach numbers above 10, the tangent cone pressures agree reasonably well for the lower surface pressure coefficients for impact angles greater than 10 degrees. It should be noted that the Tangent Cone method in the Mark IV program is not the same as that used for the Tangent Cone Empirical method in the old Mark III program. The new Tangent Cone method is the combination of two approximate techniques, one yielding accurate results in the low supersonic range and the other in the high supersonic range, by the use of transition functions defined in terms of the appropriate similarity variables to provide uniformly valid solutions over the entire speed range. Specifically, second-order

slender-body theory is used for small values of the unified similarity parameter and the approximate solution of Hammitt and Murthy for large values.

Using this new Tangent Cone method the calculated pressure coefficients have been compared to exact results and, for Mach numbers greater than 2.0, the maximum error is less than 1 percent and in the hypersonic speed range the average error is of the order of 0.25. The accuracy of the predicted surface Mach numbers is extremely good (the order of 0.3 percent maximum error) throughout the speed range, except as bow-wave detachment is reached.

A comparison of tangent wedge and tangent cone calculations for delta wings of various leading edge sweeps is presented in Figure A-19. The experimental data presented are from Reference 6. These data were obtained with helium as a test gas and a test Mach number of 20.3. The sharp leading edge and the $t/L = 0.01$ data are presented with the sharp leading edge data flagged. Oblique shock characteristics were calculated by the curves of Reference 7 for helium. The tangent cone values agree well with the 85° sweep data at low angles, and with the 80° sweep at the higher angles of attack. On the other hand, the oblique shock tangent wedge calculations agree over most of the angle of attack range with the 70° sweep case. From the data presented for angles of attack greater than 10 degrees the tangent cone method would give reasonable values for an 80° swept delta wing. Also shown for comparison purposes is the modified Newtonian estimate with $K = \gamma + 1$ (also see shock-expansion method discussion).

VAN DYKE UNIFIED METHOD

In general this method is used for small deflection angles. Comparisons of the Van Dyke Unified method and oblique-shock and other methods may be obtained from Figures A-1 through A-6.

MODIFIED DAHLEM-BUCK METHOD

This is an extended form of the Dahlem-Buck method used in the Mark III program and has improved capabilities at the lower Mach numbers. The method uses an empirical relationship that approximates tangent-cone pressures at low impact angles and approaches Newtonian values at the high impact angles. This method is particularly useful for highly swept shapes when it is desired to use one pressure method over the entire surface of the vehicle. The comparison of the Modified Dahlem-Buck method and other techniques is shown in Figures A-1 through A-8.

SHOCK EXPANSION METHOD (Strip Theory)

The shock expansion method (which in its simplest form was first suggested by Epstein in Reference 10) considers only the first family of characteristics for calculation of the surface pressures. The method uses the oblique shock relationships at the nose (an attached shock is required) and then proceeds aft on the vehicle with either a Prandtl-

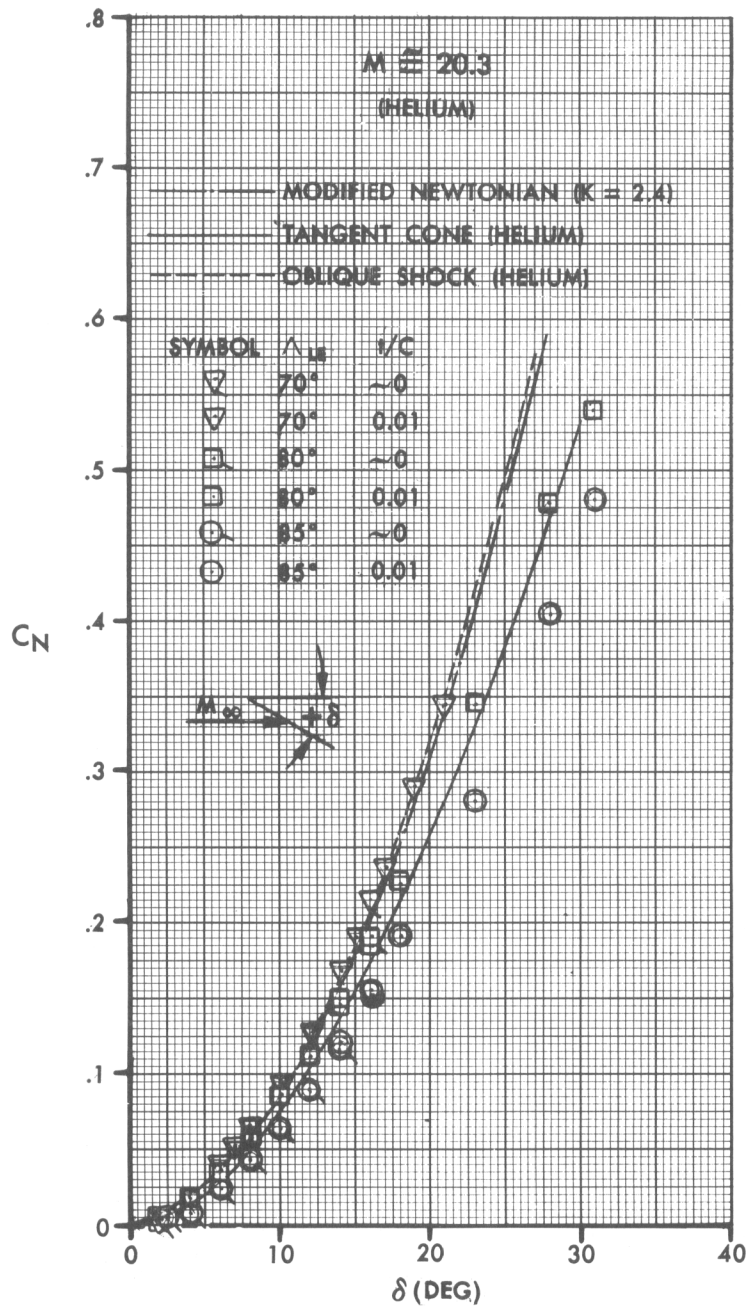

Figure A-19. Comparison of Oblique Shock and Tangent Cone Theories with Experimental Data for Highly Swept Delta Wings

Meyer expansion or another oblique shock. Computations using this method proceed along a strip of input elements until the last element in the strip is reached. The shock-expansion calculations are then started over again at the leading edge element of the next strip of elements. That is, the direction of the shock-expansion calculations (and therefore the angle between each element) is determined only by the input geometry data defining each strip of elements. This simple strip theory approach should not be confused with the Second-Order Shock-Expansion Method provided as part of the flow field calculation capabilities of the program. In the Second-Order Shock-Expansion Method the calculations are made along lines defined by cutting planes through the geometry data (which in general do not pass through the element centroids or even stay within a single streamwise strip of elements).

In the Shock Expansion (strip theory) method three pressure methods are available for the calculation of leading edge flow properties. These are: (1) tangent wedge (oblique shock) relationships, (2) the tangent cone technique and (3) the delta wing empirical method discussed later in this section. With these three methods a wide range of aerodynamic shapes may be evaluated.

Numerous reports show that, for angles of attack up to shock detachment, the application of the shock expansion method (with oblique shock used for the calculation of the leading edge properties) gives good agreement with the aerodynamic characteristics of highly swept or delta wings in hypersonic flight. However, for large sweep angles or low hypersonic Mach numbers the angle of attack for leading edge detachment becomes very small (when considered normal to the leading edge) and the range of application is considerably reduced (see Reference 16). Under the detached leading edge condition tangent-cone shock-expansion gives reasonable results for highly swept wings (i.e., $\Lambda_{LE} \approx 80^\circ$) over moderate angle of attack range. As shown previously in Figure A-19, there is an effect of sweep at these high Mach numbers such that past shock detachment empirical techniques would have to be utilized to cover the complete range of sweep angles.

An example of the use of shock expansion method to calculate the surface pressure distribution on a two-dimensional airfoil is presented in Reference 17. The shock expansion method is compared with characteristics solution at $M = \infty$ and $\gamma = 1.4$ in Figure A-20. For all Mach numbers up to 7.5 it was found that the results obtained by the shock-expansion method were indistinguishable from the characteristics calculations. For higher Mach numbers a slightly lower pressure was predicted by the shock-expansion procedure. Naturally, any three-dimensional effects will tend to reduce the two-dimensional characteristics predicted by the shock-expansion method. However, due to the large Mach number, the possible regions of influence at the tips are small for moderate deflections.

Application of the generalized shock-expansion method to bodies of revolution is discussed in Reference 18. In this mode the leading edge

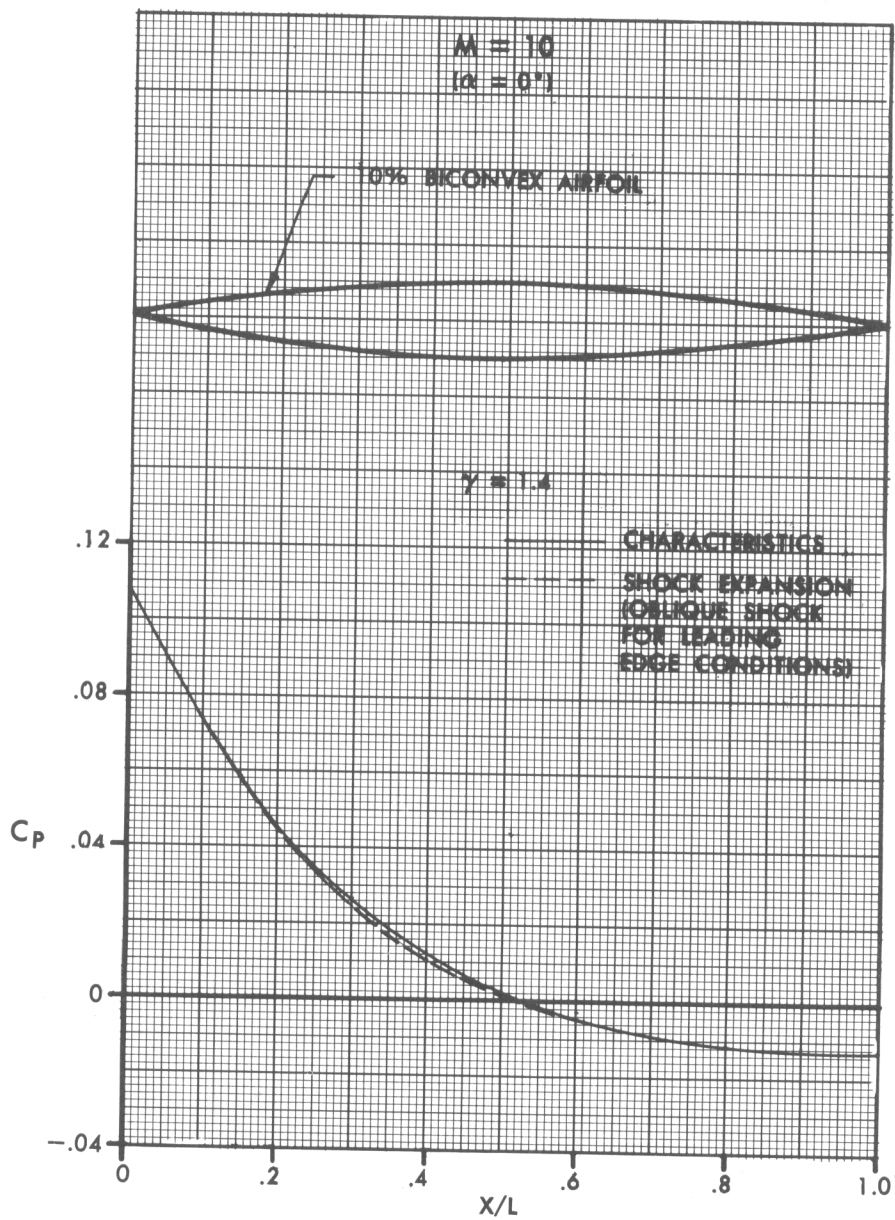

Figure A-20. Comparison of Shock Expansion and Characteristics Solution for the Surface Pressure Coefficient on a 10° Biconvex Airfoil

Contrails

properties are calculated by a tangent-cone and then the surface properties aft of the leading edge are calculated by a Prandtl-Meyer expansion. In general, the application of a two-dimensional calculation technique to three-dimensional bodies is possible when the divergence of streamlines in planes tangent to the surface can be considered negligible compared to those associated with the curvature of streamlines in planes normal to the surface. For the case of non-inclined bodies of revolution which are curved in the streamwise direction, this requirement is satisfied when the hyperonic similarity parameter $\kappa = M^d / \rho$ is greater than one. For the more general lifting case an additional constraint of $\alpha / \sigma_{\text{semivertex}} = 1$ is introduced. Reference 18 notes that good correlation of pressure was obtained when $\alpha/\sigma = 0.5$ and fair agreement at $\alpha/\sigma = 1.0$. Results from this reference are presented in Figures A-21 and A-22. Application of the basic shock-expansion technique at lower values of κ to various bodies should not include shapes which have large lengths of zero curvature as this can lead to incorrect values with respect to experiment. The simple case of a cone cylinder is presented in Figure A-23 for an example of this error.

The use of the shock-expansion strip pressure-calculation method in the inviscid pressure part of the program places certain requirements on the input geometry data as mentioned previously. This is caused by the fact that the program does not calculate streamlines on the surface but merely applies the shock-expansion process on each strip of elements, element by element (the second-order shock-expansion option in the Flow Field portion of the program does not have this problem). This means that the elements themselves become the streamline directions as far as the program is concerned. This means that the user must decide as he is loading the geometry just where the streamlines are to go. This is quite acceptable where two-dimensional surfaces are involved, or for axisymmetric bodies at small angles of attack. It is for these reasons that the strip shock-expansion pressure method should only be applied to these simple types of shapes and should not be used on some complex, completely arbitrary three-dimensional shape. For these more complex problems the second-order shock-expansion option of the Flow Field portion of the program should be used.

When using the shock-expansion strip pressure method each panel of the vehicle should be handled as a separate individual panel. The explanation for this requires a review of the procedure used in the shock-expansion strip calculations. First, we know that a panel of the vehicle can be orientated in two basic modes - in a normal cross-section mode with the first input column of elements stretching around the vehicle from the bottom to the top, or in a strip fashion with the first input column of elements starting at the front and running aft along the shape. On the Panel Identification Card these are identified by the orientation flag as IORN = 0 or = 1 respectively.

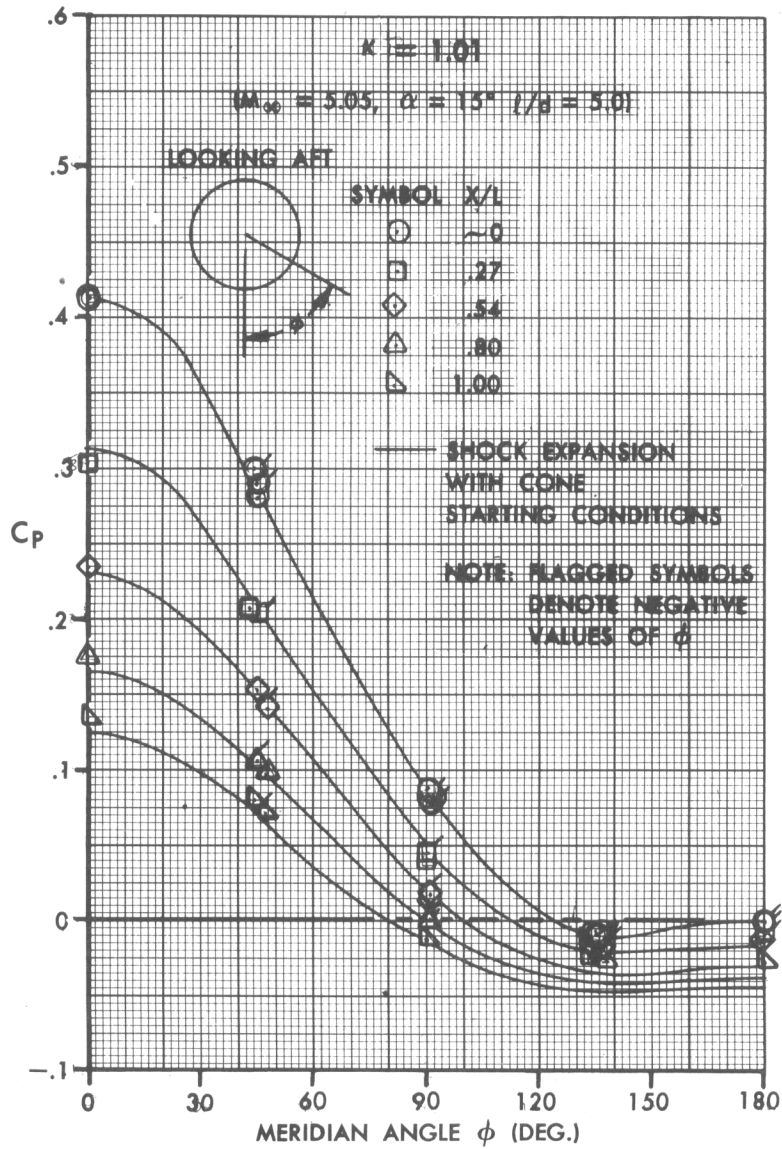

Figure A-21. Circumferential Variation of Pressure Coefficient on a Fineness Ratio 5 Ogive at 15 Degrees Angle of Attack

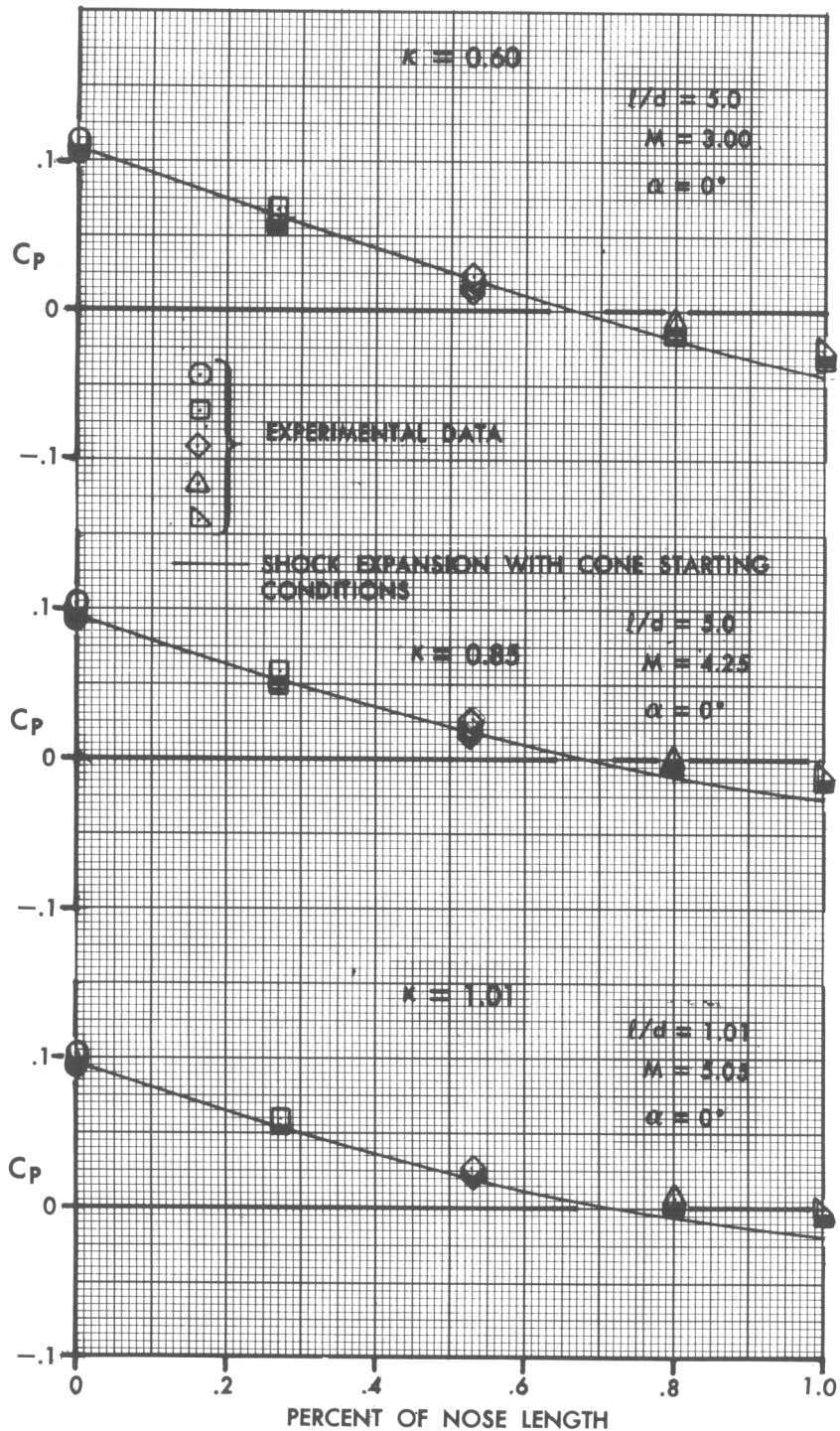

Figure A-22. Variation of Pressure Coefficient Along a Fineness Ratio 5 Ogive at Zero Angle of Attack

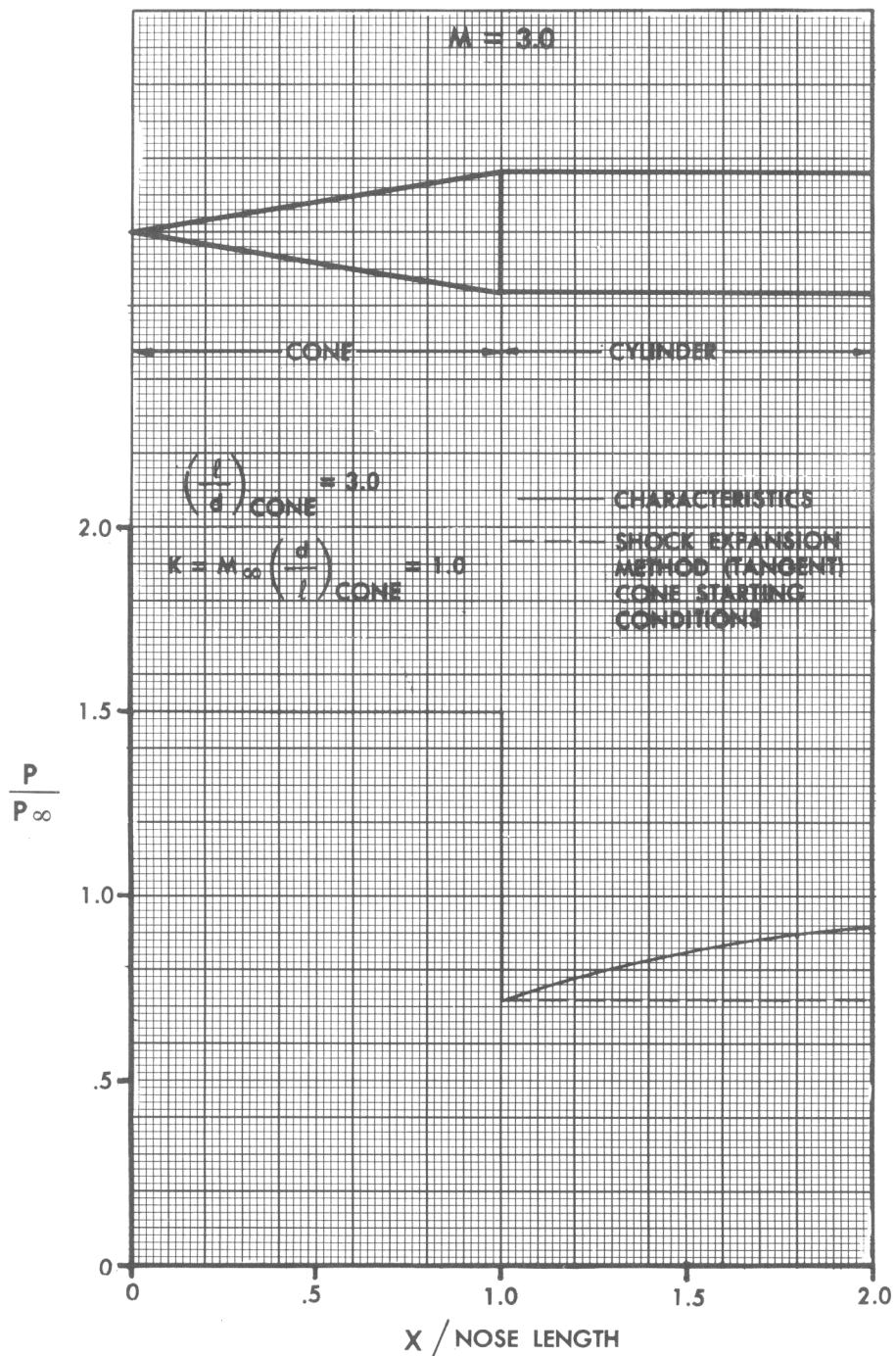

Figure A-23. Comparison of Shock Expansion and Characteristics Solutions for a Cone-Cylinder at M = 3.0

Contrails

Next, when the program starts to make the shock-expansion strip calculations it must decide which set of input elements represent the starting point for the shock-expansion strip process (these elements are termed the panel "leading edge elements"). If the flag IORN = 0, then the panel is in the normal cross-section orientation so the first input column of elements becomes the starting elements for the shock-expansion calculations and the "rows" of elements are assumed to define the streamline direction. If the flag IORN \geq 1, then the strip input method is used and the first element of each strip (the first row of elements) becomes the leading edge elements.

It is important to note that the program will always start the shock-expansion strip calculations with the "leading edge elements" of a panel, even though these elements may not be a physical surface leading edge (such as a wing leading edge). This is the usual occurrence in many applications. This shortcoming may be easily solved by a simple geometry loading technique. The basic trick is to make the leading elements of a panel (that are to be used in a shock-expansion strip mode) have the same angle relative to the flow as the physical leading edge does. A simple example of this is the flat lower surface of a re-entry vehicle where the flow expands from the forward ramp to the aft flat surface. For this case let us assume that on the forward ramp we are using oblique-shock pressures (tangent wedge), but that we wish to use the shock-expansion strip method for the turn at the corner between the forward ramp and the aft flat surface. In this case we would take a very narrow column of elements in the forward ramp just ahead of the corner and make this column the leading elements for the aft flat.

A similar useful trick is to make the leading elements have whatever shape is required to give the proper starting conditions for the shock-expansion, but make the elements so small that they themselves do not contribute a significant amount to the overall vehicle forces.

FREE MOLECULAR FLOW

At very high altitudes the various theoretical approaches based on continuum flow cease to be realistic. The criteria associated with the onset of free molecular flow is the mean free path of the molecules. If the mean free path is everywhere much greater than the characteristic vehicle dimension, the flow may be called free molecular flow.

The process of momentum transfer for this flow model is a function of the accommodation coefficients to be input to the program. These accommodation coefficients are related to the two general modes by which the molecules striking the body may be reflected.

The first model is called "specular" reflection. In this flow model the molecule is assumed to strike a smooth flat surface and leave with its normal velocity component completely reversed and its tangential component unchanged. The accommodation coefficients (f_t and f_n) are zero for specular reflection. The experimental evidence shows that this model is unrealistic. Thus, for practical applications the results obtained with specular reflection should only be used for comparison purposes.

Contrails

The surface roughness for standard surfaces on actual configurations is not "smooth" in the sense required for specular reflection. The second model notes this fact and assumes the molecules which strike the surface are trapped by the surface and then re-emitted. Any such reflection process which is not specular is called a "diffuse" reflection. For a completely diffuse reflection the accommodation coefficients (f_t , f_n) are equal to 1.0. Most of the experimental data obtained for f_t is in the area of 0.8 to 1.0 and it is generally assumed that f_n is also close to one.

The general assumptions made when calculating the free molecular flow for general shapes are: (1) completely diffuse reflection exists, and (2) constant temperature over a given vehicle section is assumed.

DELTA WING EMPIRICAL

A detailed explanation of this force calculation method appears in Volume II of this report. This method was derived from experimental data of 60 to 75 degrees sweep deltas at Mach numbers of 6.85 and 9.6. Pressure coefficients calculated by this method are compared with other calculation methods over a wide Mach number range in Figures A-1 through A-6. It should be noted that at a Mach number of 20 for the low to moderate angles of attack the method approximated Newtonian flow due to the high values of $M \sin \delta$.

Contrails

APPENDIX B

GEOMETRY DATA CHECKOUT

The preparation of the input data to describe a complex vehicle shape is the most difficult and time consuming aspect of the use of this program. Once the geometry data are prepared many aerodynamic studies may be conducted with only a small amount of additional input data preparation time. However, all of this aerodynamic output will be useless if the geometry data contains input errors. The importance of making a very thorough checkout of the input geometry data cannot be overemphasized. All too often the authors have received "checked-out" geometry data decks from users, only to find after a complete check that the decks contained numerous input errors.

The only complete and accurate way of checking out a complex geometry deck is through the use of a computer graphics program. Such a picture drawing program is not a part of the present release of the Mark IV program (although one will be added at a later date). However, this will not hinder anyone since all users of the Mark IV program have picture drawing capabilities that were supplied or developed for use with the old Mark III program. These programs can still be used to check out the geometry for the Mark IV program.

An interactive graphics CRT system is by far the best way of checking out arbitrary-body geometry data. The use of such a system is illustrated in Figures B-1 through B-3. The important characteristic of such a system is that the operator is able to have the machine draw a large number of pictures of the vehicle and its components at different angles and with different scales to zoom in on a given part of the shape. As the operator identifies problem areas of the geometry he can change angles and scales to more clearly define the input errors. The bad points can then be fixed and the pictures again drawn to verify the corrections.

Off-line hard copy CRT devices such as the SD-4060 or FR-80, or line drawing machines such as the CALCOMP may also be used in the geometry checkout process. Since these devices do not have the interaction capabilities described above, a larger number of picture angles and scales must be selected so that the batch job output pictures will thoroughly explore all aspects of the shape. A minimum set of drawings is shown in Figure B-4. In many cases drawings such as shown in Figures B-5 and B-6 will help in tracking down the more difficult input errors.



Figure B-1. Checking Out Geometry Data with IBM 2250 Interactive Graphics Device.

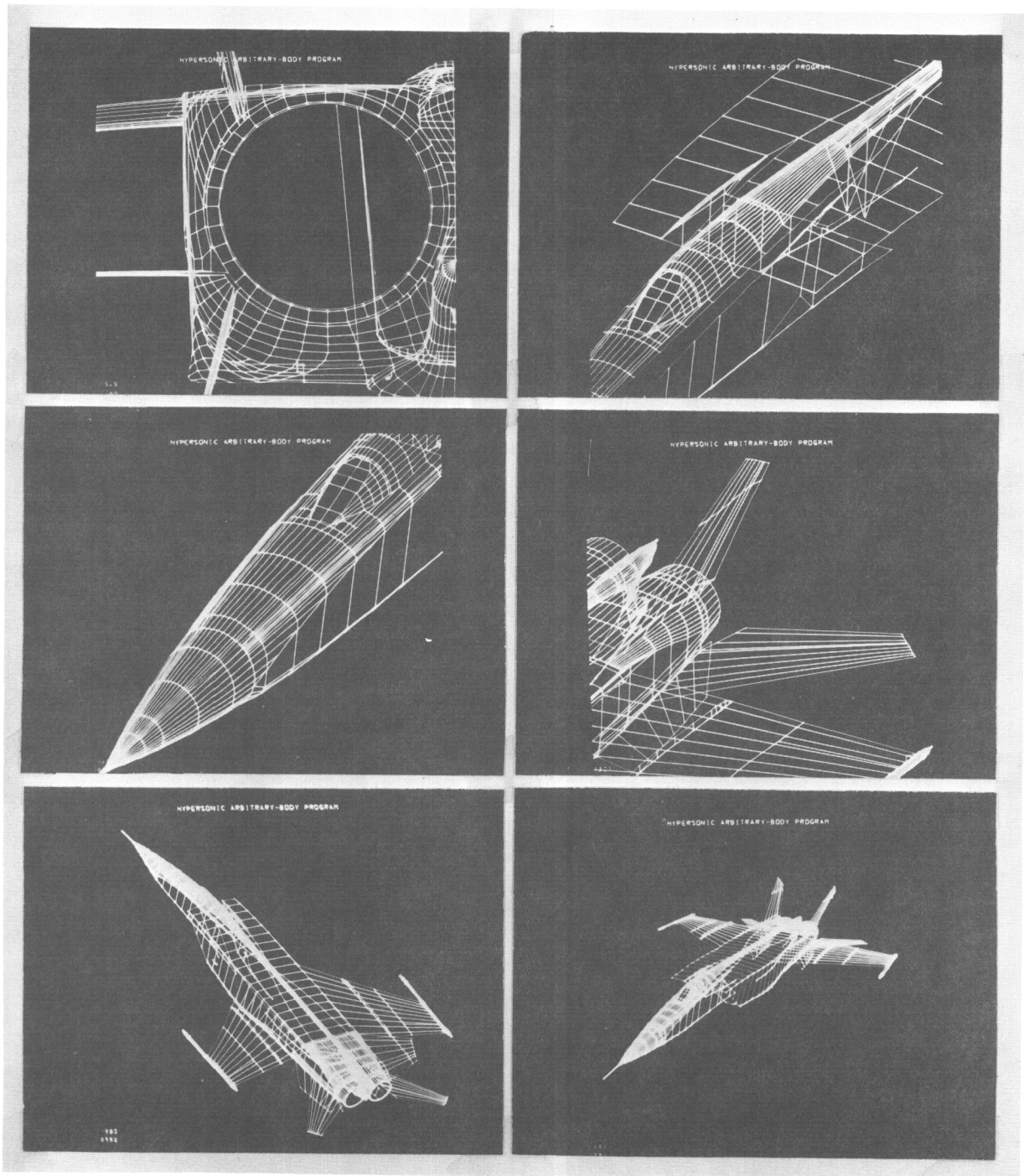

Figure B-2. Geometry Checkout With IBM 2250.

Contrails

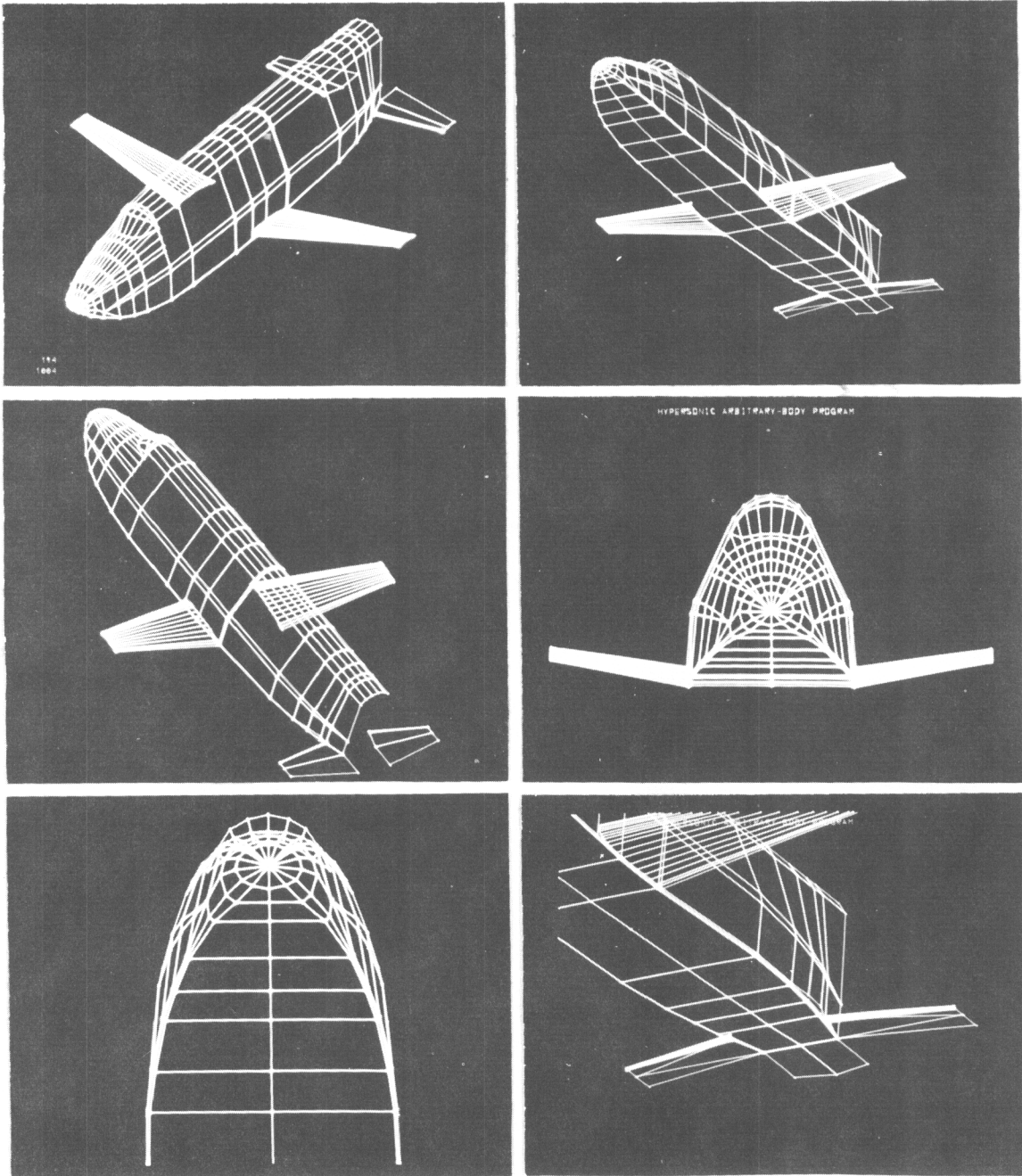

Figure B-3. Geometry Checkout with IBM 2250.

Contrails

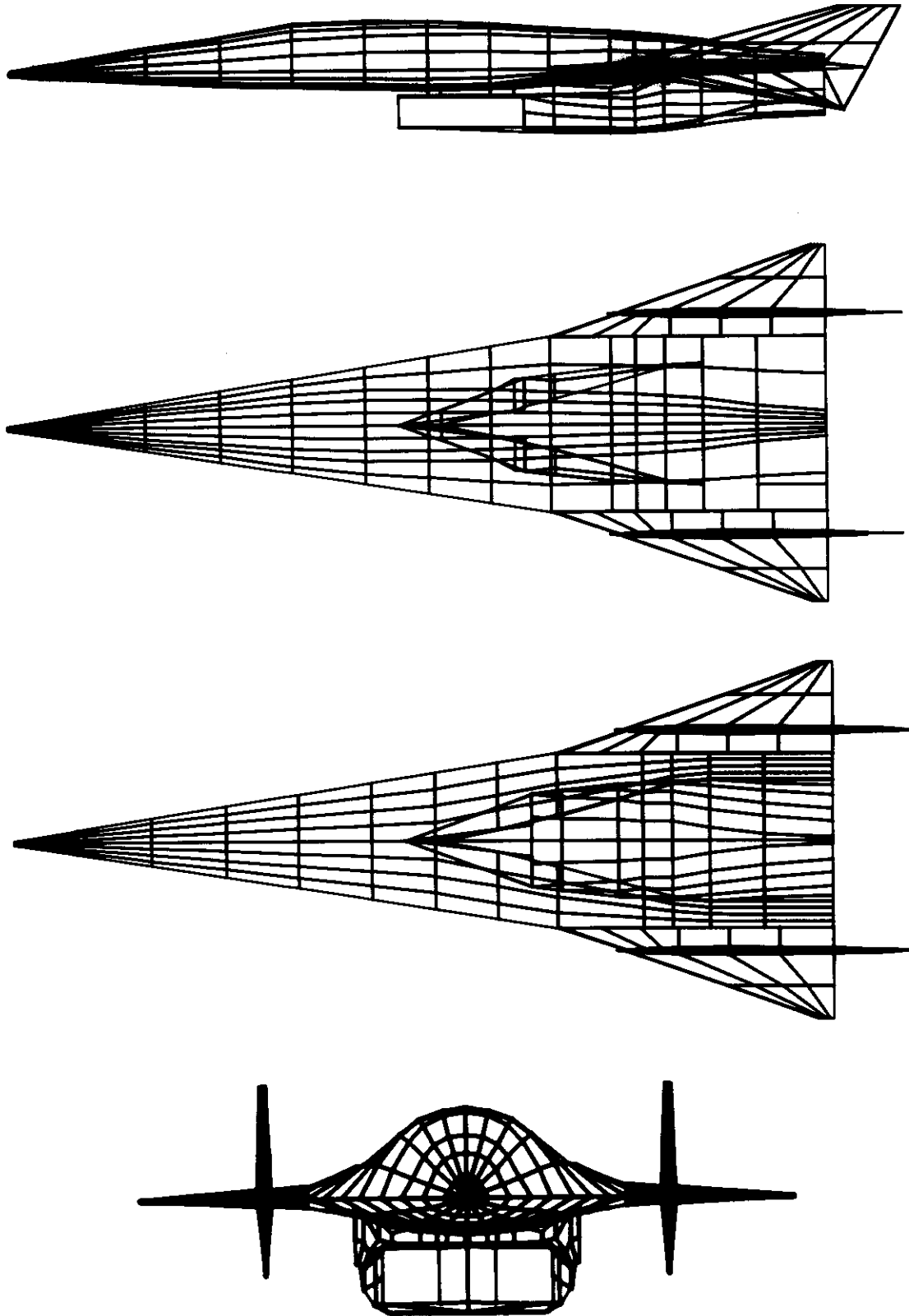

Figure B-4. Geometry Checkout Using Off-Line SD-4060 Program.

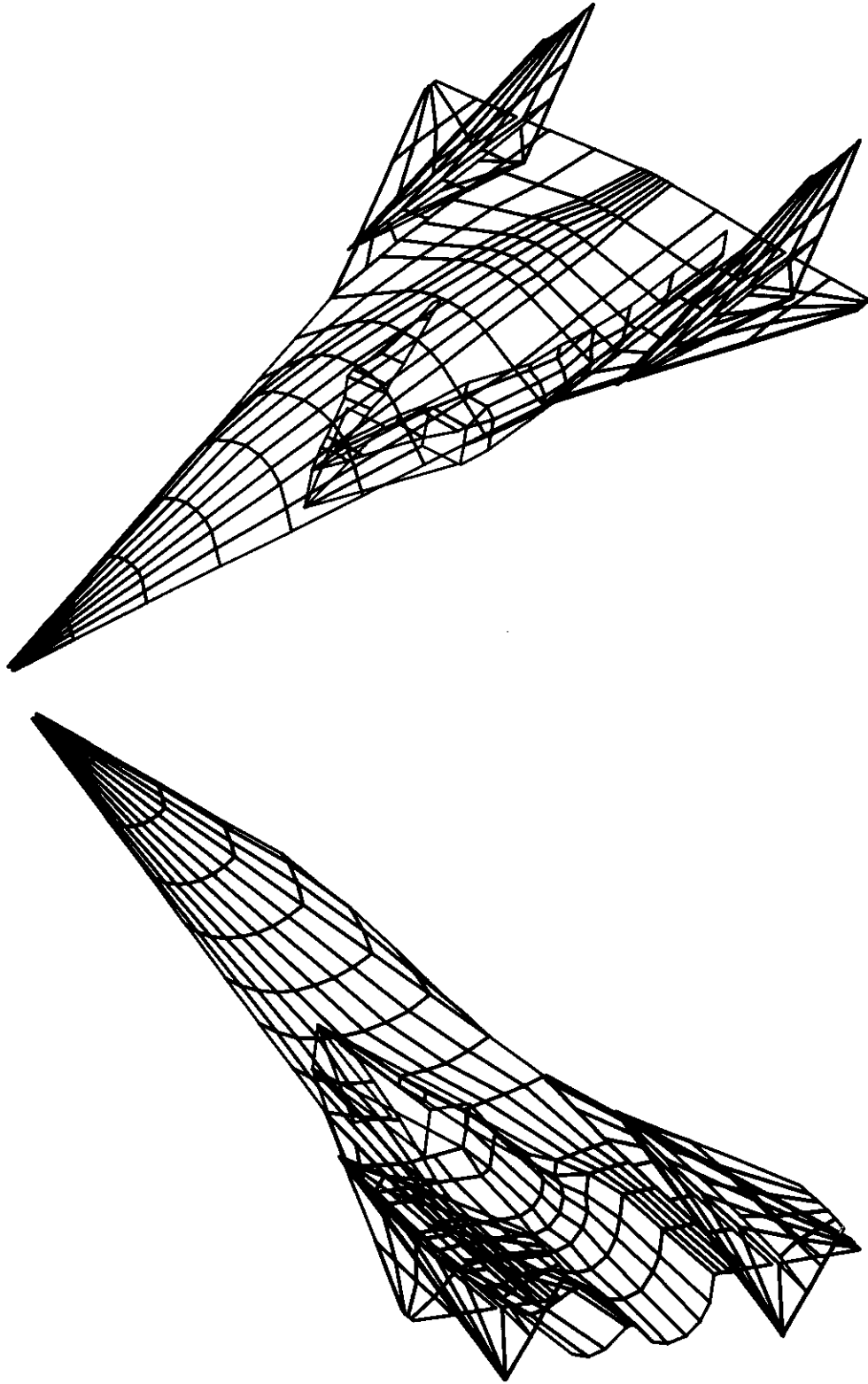

Figure B-4 (cont.) Geometry Checkout Using Off-Line SD-4060 Program.

Contrails

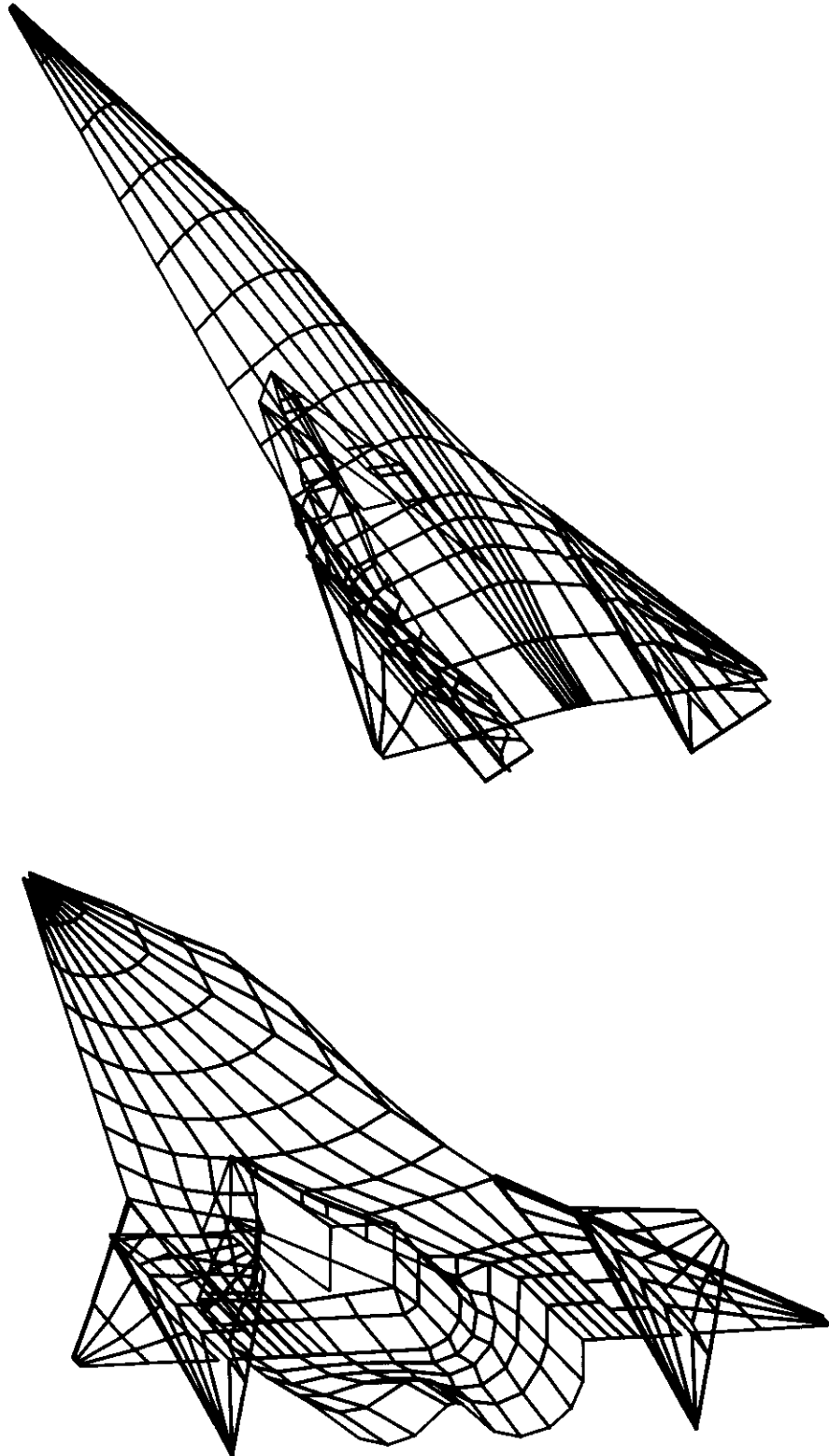

Figure B-4 (cont.) Geometry Checkout Using Off-Line SD-4060 Program.

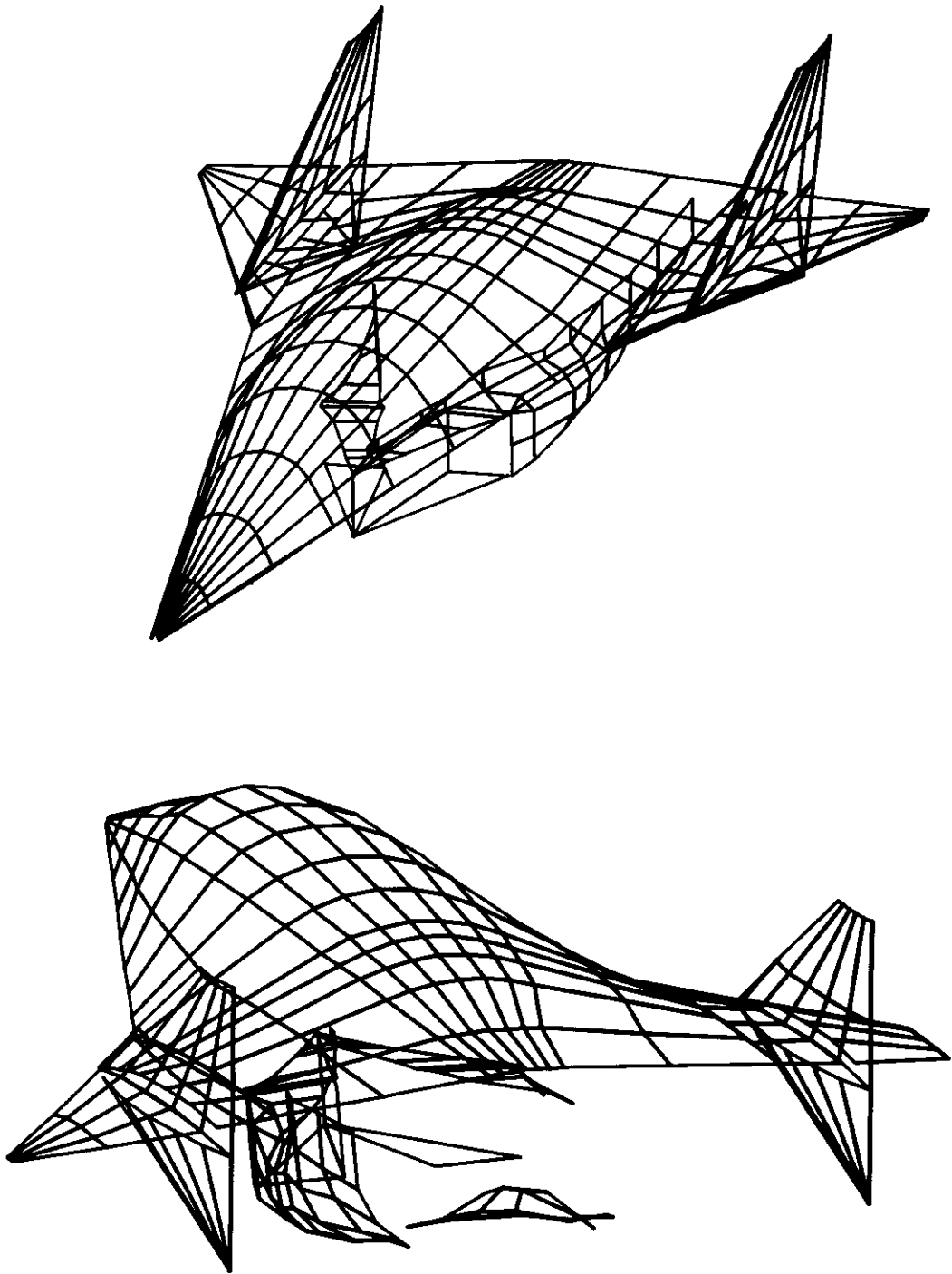

Figure B-4 (cont.) Geometry Checkout Using Off-Line SD-4060 Program.

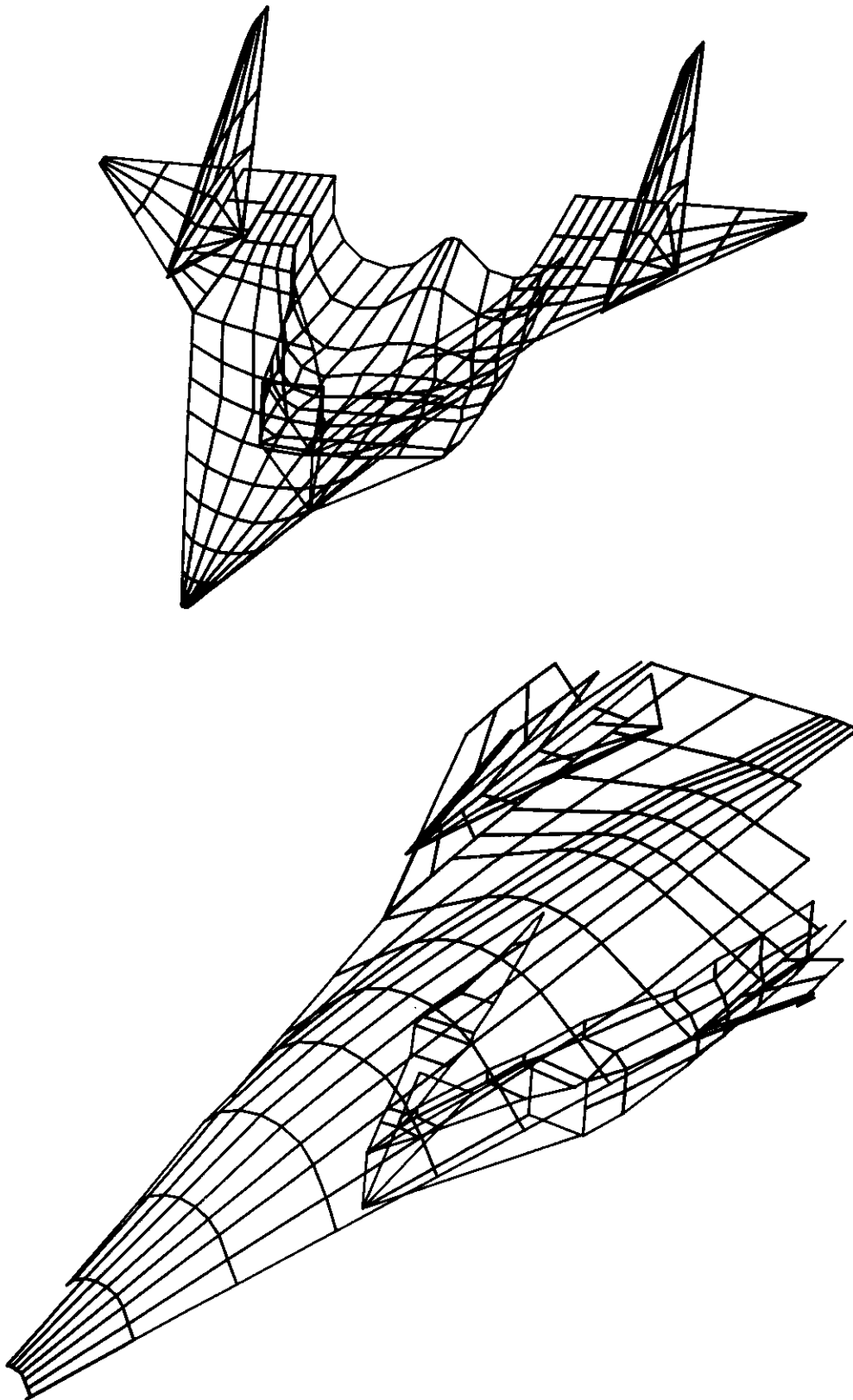

Figure B-4 (cont.) Geometry Checkout Using Off-Line SD-4060 Program.

Contrails

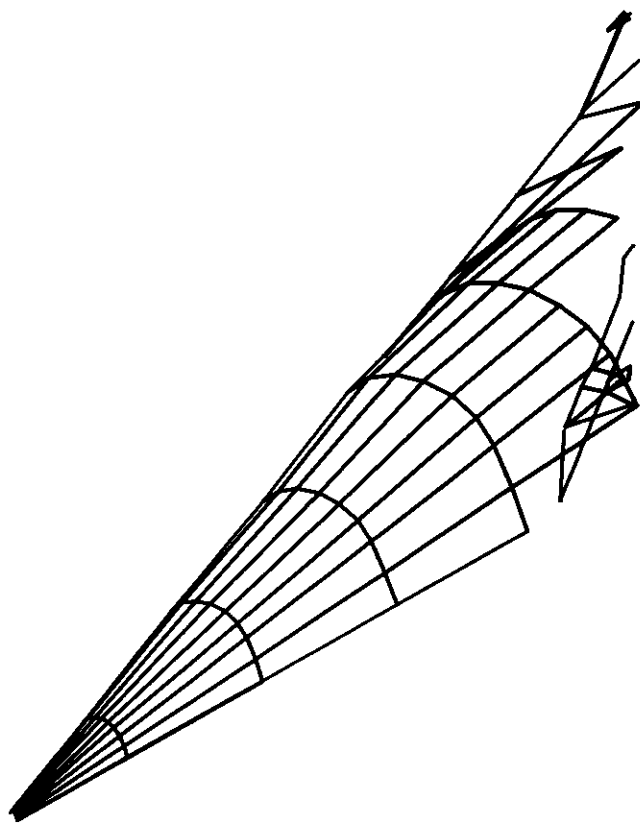
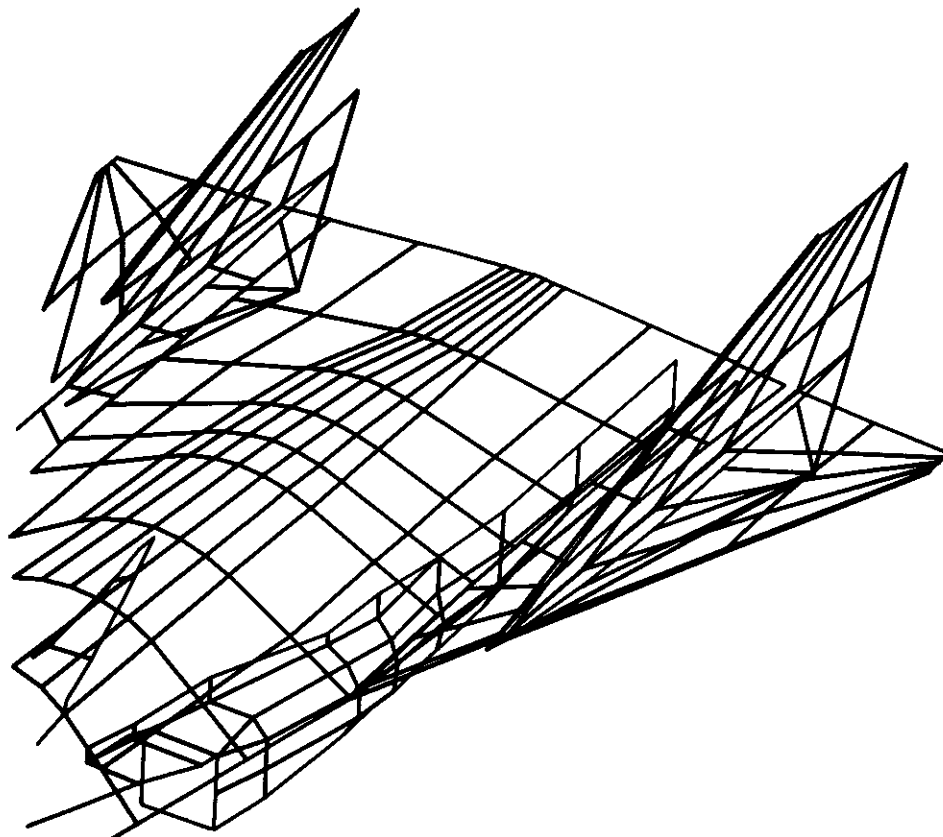

Figure B-4 (cont.) Geometry Checkout Using Off-Line SD-4060 Program.

Contrails

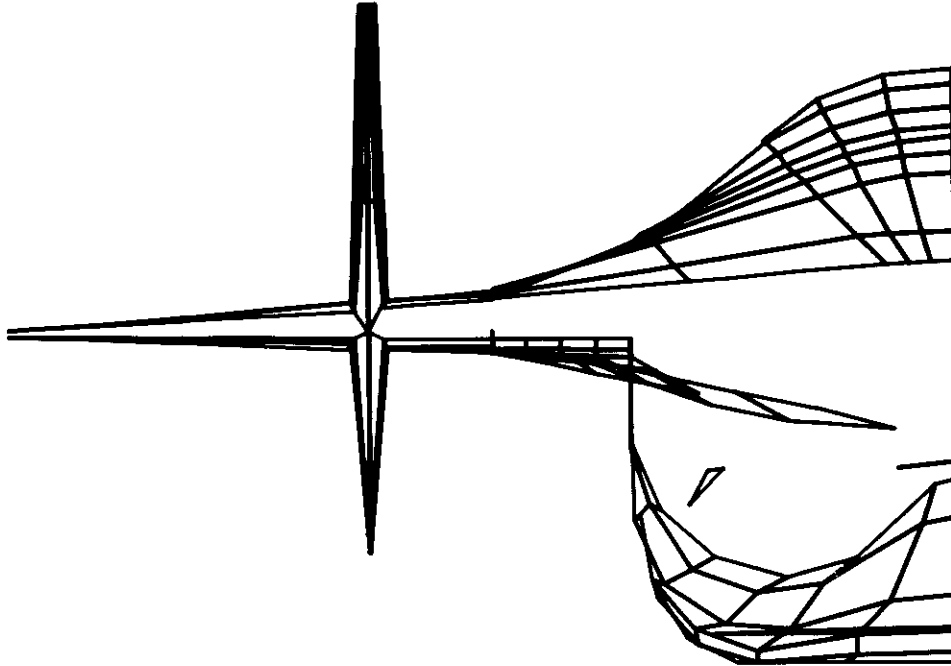
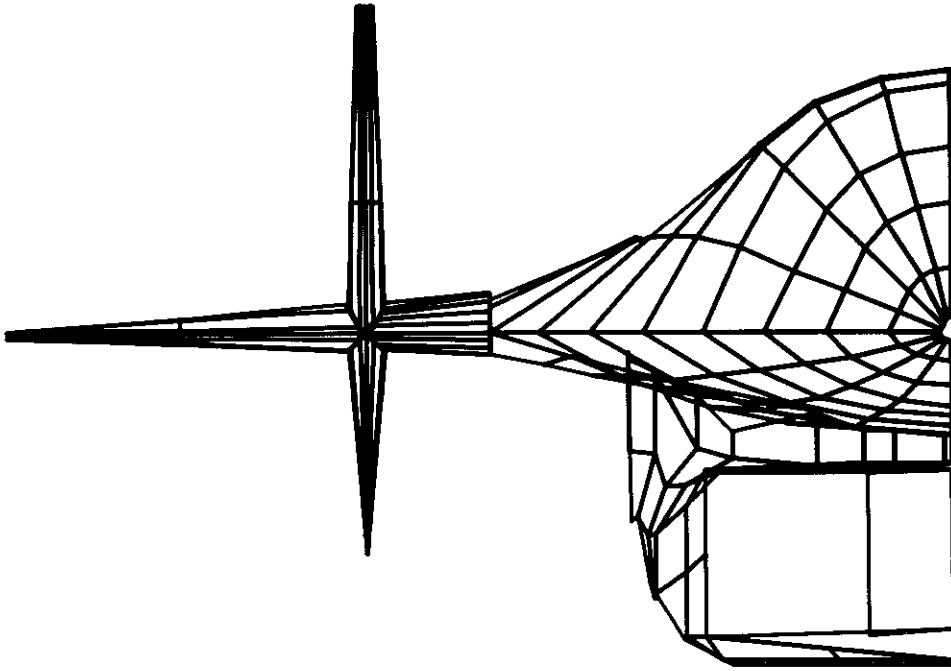

Figure B-4 (cont.) Geometry Checkout Using Off-Line SD-4060 Program.

HYPERSONIC ARBITRARY-BODY AERODYNAMIC PROGRAM
CRUISE VEHICLE (0,0,0) CASE 50

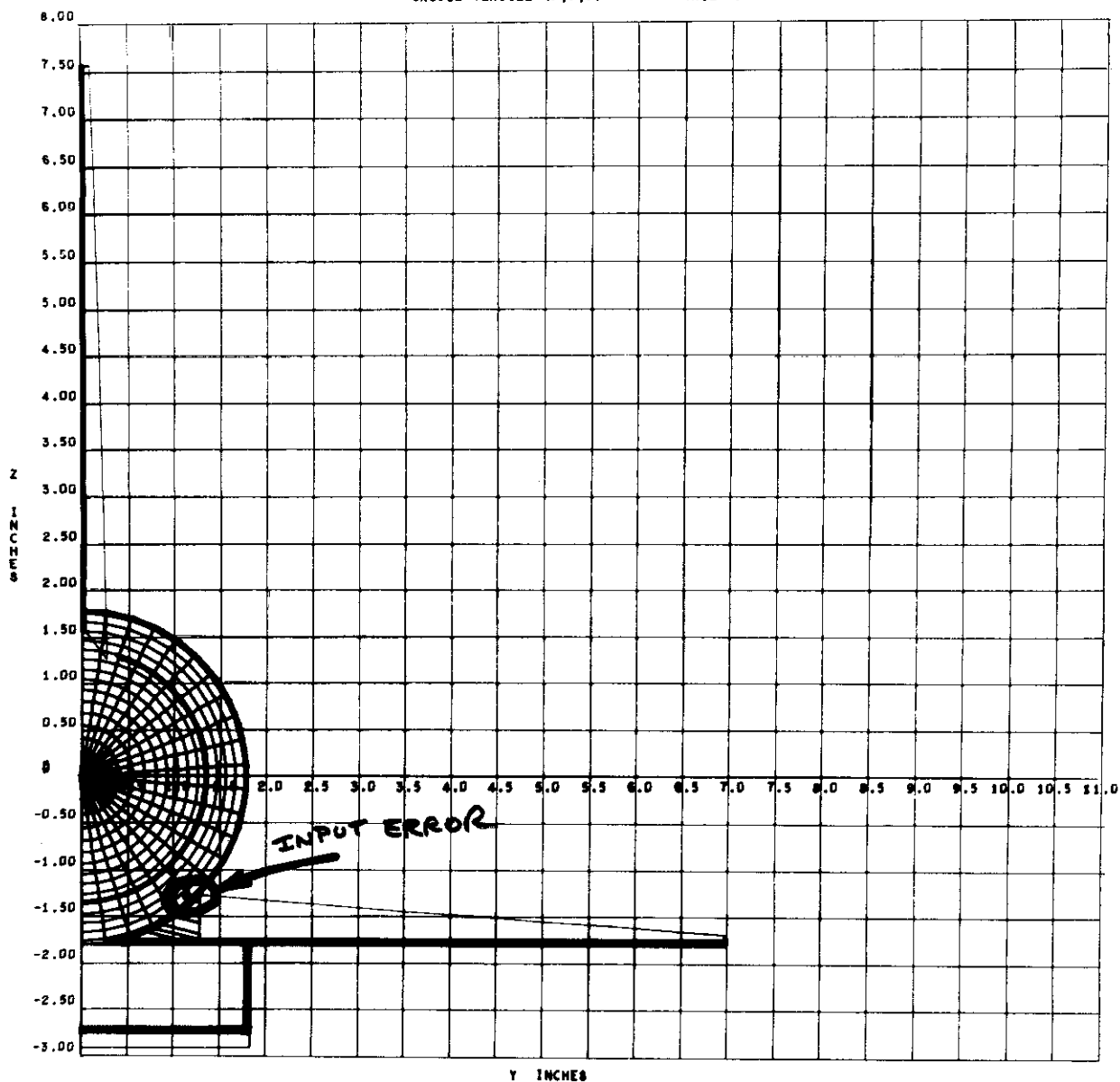

Figure B-5a. Case 50 With Input Error
(Normal Front View Scale)

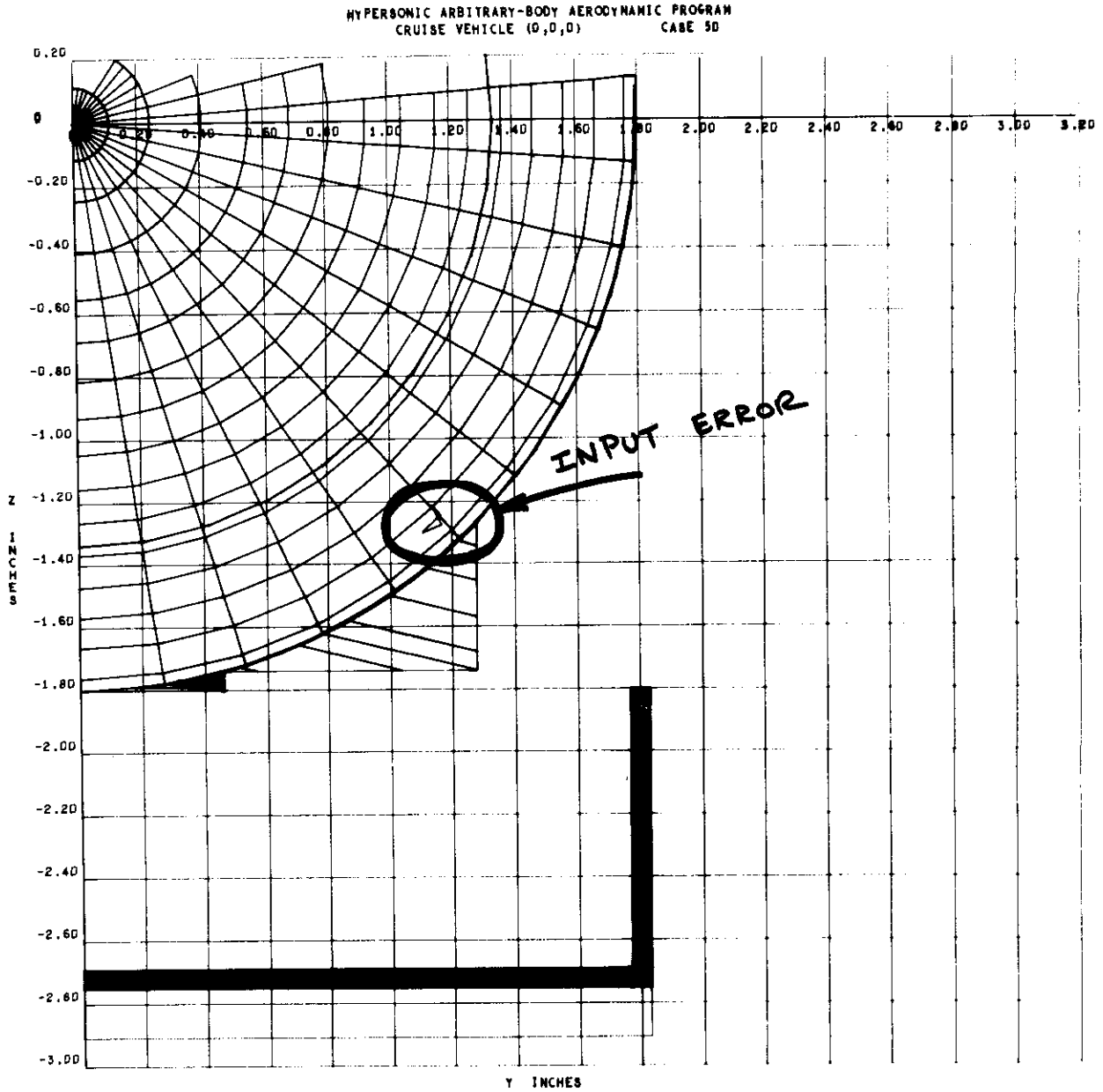

Figure B-5b. Extended Scale Front View of Case 50
With Input Error

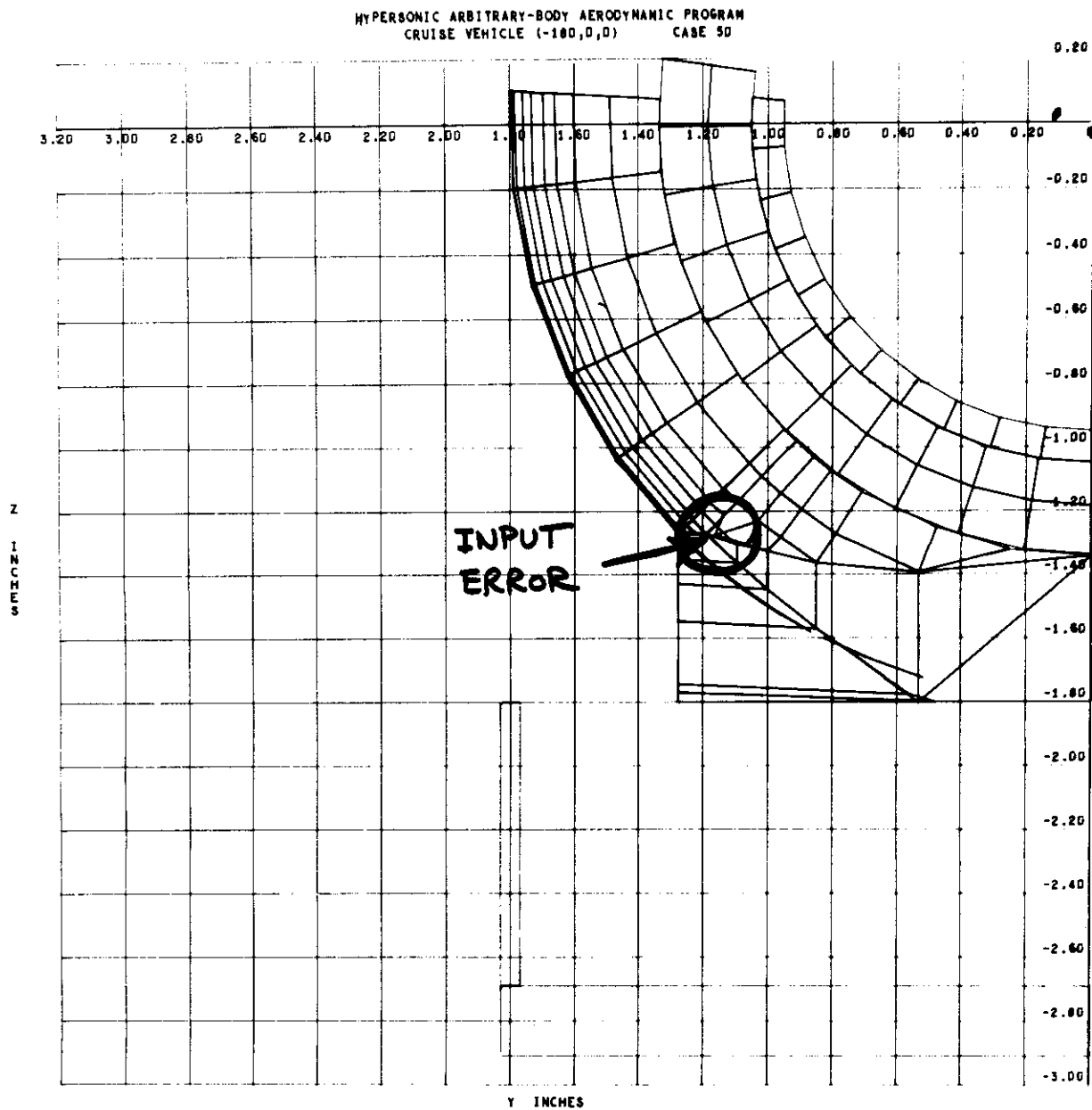

Figure B-5c.Case 50 Rear View (Extended Scale)
and Input Error

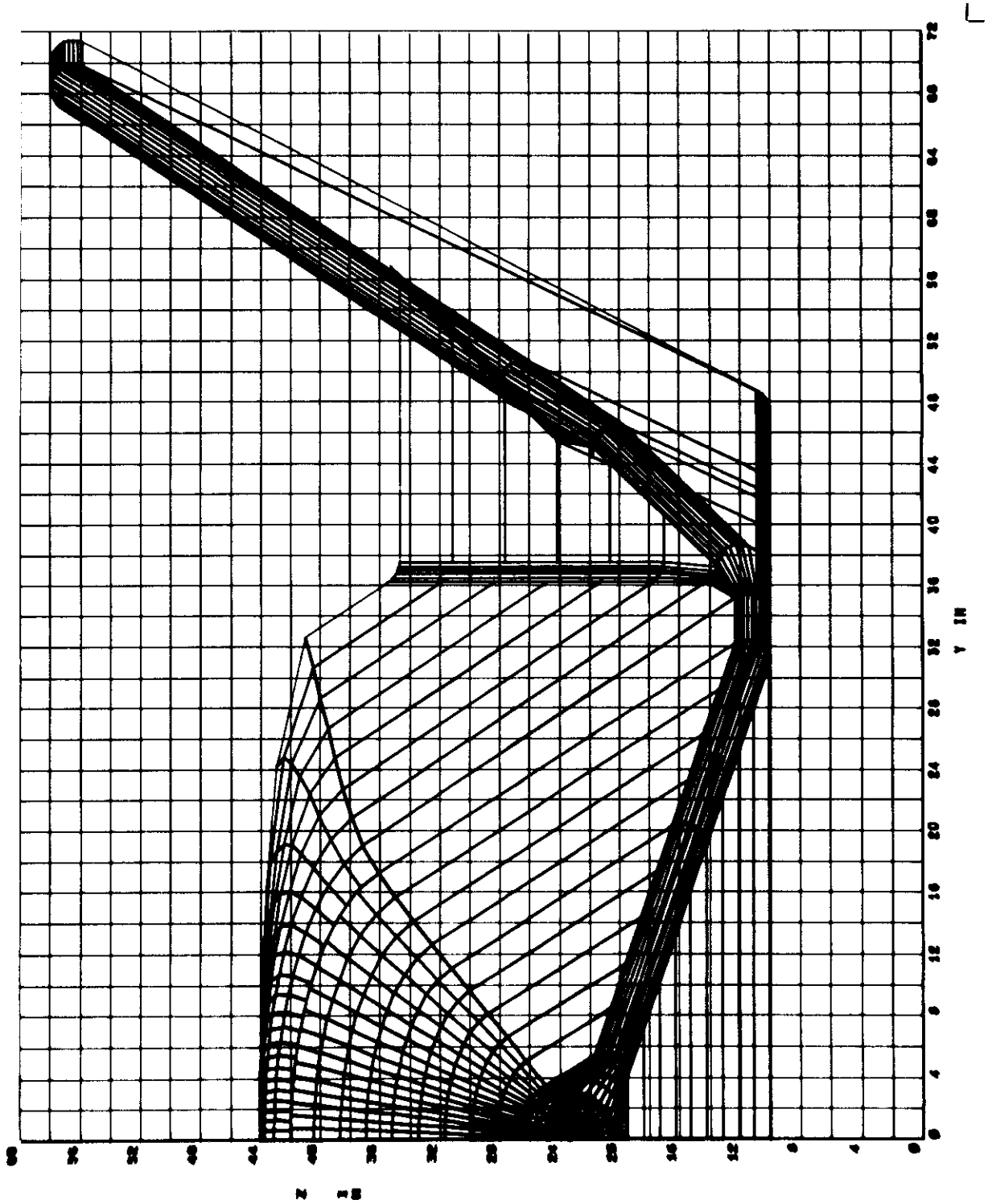

Figure B-6. Computer Drawn Front View

APPENDIX C SAMPLE PROBLEMS

The sample problems in this Appendix are presented with the hope that the user will be able to use them both to better understand the capabilities of the program, and to supplement the card-by-card input instructions so as to clarify their meaning. These sample problems should be studied carefully along with the detailed input instructions before attempting a run on the program. Each page of the listings on the following pages contains a header at the top to aid in locating the card columns in the listing. These first two header lines are therefore not an actual part of the input data decks. Also, the first card in each job is always the Executive Flag Card (see page 11) and this card is not included in these sample problem listings. It should be added to the deck in any attempts to run these problems on the computer.

Sample Problem # 1 (pages 215-220)

This is the same test case as was used in the User's Manual for the Mark III program. For use in the new Mark IV program it has been expanded slightly to illustrate the use of the new Shielding Option. This sample problem makes use of the Geometry Option, the Shielding Option, three passes into the Inviscid Option, the Viscous Option (using the old Mark III skin friction option), and the Summation Option. This is one of the standard test cases furnished to all users of the new Mark IV program.

Sample Problem # 2 (pages 221-222)

This problem was prepared to illustrate the use of the Streamline Calculation Option together with the new Integral Boundary Layer Method. The options used include the Geometry Option, Inviscid Pressures, Flow Field (Surface Data Transfer), Streamline, and Viscous (Integral Boundary Layer Option).

Sample Problem # 3 (pages 223-225)

This sample problem illustrates the use of some of the flow field options. It accesses geometry data that has been previously calculated and saved on the geometry storage unit on a different run. The Flow Field Option is used to generate the flow field for the vehicle wing. This flow field is then used in calculating the vehicle characteristics at three α - β conditions.

Sample Problem # 4 (page 226)

This problem illustrates how the Second-Order Shock-Expansion Flow Field can be used in the calculation of body Inviscid Pressures. The geometry data are assumed to be already stored on the geometry storage unit 4 on a previous run.

Sample Problem # 5 (pages 227-232)

This problem illustrates some of the other capabilities of the Flow Field Option of the program for a wing-body combination. After reading in the geometry data, flow field properties are calculated for five different meridian angles. The Inviscid Pressure Option is then used to calculate the forces with and without interference using only one of the previously calculated meridian angle sets of data.

Sample Problem # 6 (pages 233-256)

This sample problem is quite complex but illustrates the inherent flexibility of the program and some options which have not been presented in the previous examples. The configuration to be evaluated is the wind tunnel model of NASA TND-5885. The model characteristics for a body+wing and a body+wing+vertical fin are evaluated for Mach = 6.85 and $\alpha = 6.86^\circ$. The first step is the loading of the geometry data onto unit IOUT. This includes the inviscid geometry (panels 1 through 26), the body alone skin friction geometry (panels 27, 28, 29), the body+wing skin friction geometry (panels 27, 28, 30, 31), and the body+wing+vertical fin skin friction geometry (panels 27, 28, 30, 31, 32, 33). After the geometry has been loaded the vehicle aerodynamic characteristics are evaluated in the following steps:

1. Body flow fields for wing and vertical tail are generated.
2. Body alone inviscid pressures are determined.
3. Wing inviscid pressures (with interference flow fields generated by body). It should be noted that the body of this configuration has a secondary flow field (imbedded shock wave behind bow shock) due to a boundary layer diverter. Wing pressures are calculated with this taken into account.
4. Laminar skin friction for the body+wing configuration.
5. Vertical fin inviscid pressures (with interference flow field generated by the body). This includes the subtraction of the body contribution due to the area on the body now covered by the vertical fin. This is accomplished by using a negative reference area (S_{ref}). The base drag due to the blunt trailing edge of the vertical fin is also calculated.
6. Laminar skin friction for the vertical fin. This also includes a correction for the wetted area covered on the body by the vertical fin by use of a negative S_{ref} .
7. Turbulent skin friction for body+wing.
8. Turbulent skin friction for vertical fin with the correction for area covered by vertical fin (see step 6 above).
9. Summation of aerodynamic characteristics.
 - a. Body alone (to be used with wing), inviscid.
 - b. Body + wing inviscid (with interference).
 - c. Body + wing (with interference) inviscid + laminar skin friction.

Contrails

- d. Body + wing + vertical fin (with interference) inviscid.
 - e. Body + wing + vertical fin (with interference) inviscid + laminar skin friction.
 - f. Body + wing (with interference) inviscid + turbulent skin friction.
 - g. Body + wing + vertical fin (with interference) inviscid + turbulent skin friction.
10. Wing without interference effects.
11. Summation of aerodynamic characteristics.
- a. Body + wing (no interference) inviscid.
 - b. Body + wing (no interference) inviscid + laminar skin friction.
 - c. Body + wing (no interference) + vertical fin (with interference) inviscid + laminar skin friction.
 - d. Body + wing (no interference) inviscid + turbulent skin friction.
 - e. Body + wing (no interference) + vertical fin (with interference) inviscid + turbulent skin friction.

SAMPLE PROBLEM #1 (continued)

0	1	2	3	4	5	6	7	8
1234567890123456789012345678901234567890123456789012345678901234567890								
-16.0	0.0	3.550	0-17.0	0.0	3.762		67 I	7AER00450 ← (PANEL 3 cont.)
EMO 001			PANEL IDENTIFICATION CARD					
1 000	0.100	0.125	FLEMENT READ CONTROL CARD	0.077	0.140		67 E	3AFR00490
-0.125	0.056	0.150	2-0.125	0.037	0.156		67 E	3AER00500
-0.125	0.019	0.159	0-0.125	0.000	0.162		67 E	3AER00510
-1.00	0.273	0.200	1-1.00	0.239	0.260		67 E	3AER00520
-1.00	0.191	0.310	0-1.00	0.133	0.348		67 E	3AER00530
-1.00	0.059	0.372	0-1.00	0.000	0.380		67 E	3AER00540
-16.00	1.60	2.480	2-16.00	1.390	2.850		67 M	3AER00550
-16.00	1.10	3.140	0-16.00	0.780	3.360		67 M	3AER00560
-16.00	0.40	3.500	0-16.00	0.000	3.550		67 M	3AER00570
-17.50	1.520	2.680	1-17.50	1.330	3.020		67 M	3AER00580
-17.50	1.080	3.300	0-17.50	0.760	3.530		67 M	3AER00590
-17.50	0.400	3.660	0-17.50	0.000	3.710		67 M	3AER00600
-19.00	1.480	2.830	1-19.00	1.290	3.180		67 M	3AER00610
-19.00	1.030	3.420	0-19.00	0.730	3.620		67 M	3AER00620
-19.00	0.380	3.780	0-19.00	0.000	3.800		67 M	3AER00630
-19.00	1.480	2.830	2-19.00	1.290	3.180		67 M	3AER00640
-19.00	1.030	3.420	0-19.00	0.730	3.620		67 M	3AER00650
-19.00	0.380	3.780	0-19.00	0.000	3.800		67 M	3AER00660
-30.00	1.480	2.830	1-30.00	1.290	3.180		67 M	3AER00670
-30.00	1.030	3.420	0-30.00	0.730	3.620		67 M	3AER00680
-30.00	0.380	3.780	0-30.00	0.000	3.800		67 M	3AER00690
-1.0000000	0.0000000	0.0000000	2-1.0000000	0.0000000	0.0000000		Z	332B 0700
-1.0000001	0.0000000	0.0000000	1-1.0000001	0.0000001	0.0000001		Z	332B 0710
DHLP001			PANEL IDENTIFICATION CARD					
1 000	0.157	0.03H	FLEMENT READ CONTROL CARD	0.136	0.084		67 D	3AER00750
-0.125	0.100	0.126	2-0.125	0.346	0.037		67 D	3AER00760
-1.00	0.309	0.117	0-1.00	0.273	0.200		67 D	3AER00770
-1.00	0.346	0.032	2-1.00	0.321	0.087		67 H	3AER00780
-1.00	0.298	0.143	0-1.00	0.273	0.200		67 H	3AER00790
-9.00	1.805	-0.590	1-9.00	1.535	0.202		67 H	3AER00800
-9.00	1.262	0.80	0-9.00	0.990	1.390		67 M	3AER00810
-16.00	3.068	-0.778	1-16.00	2.60	0.260		67 H	3AER00820
-16.00	2.10	1.360	0-16.00	1.60	2.480		67 H	3AER00830
-16.00	3.068	-0.778	2-16.00	2.60	0.260		67 L	3AER00840
-16.00	2.100	1.360	0-16.00	1.60	2.480		67 L	3AER00850
-17.50	2.940	-0.640	1-17.50	2.47	0.460		67 L	3AER00860
-17.50	1.990	1.570	0-17.50	1.52	2.680		67 L	3AER00870

Reading in Geometry Data
Type 3 cards
(PANEL 4)

Reading in Geometry Data
Type 3 cards
(PANEL 5)

Contrails

SAMPLE PROBLEM #1 (continued)

0	1	2	3	4	5	6	7	8
1234567890123456789012345678901234567890123456789012345678901234567890								
-19.00	2.84	-0.40	1-19.00	2.385	0.675	0	67 L	3AER00880
-19.00	1.930	1.750	0-19.00	1.48	2.830	0	67 L	3AER00890
-19.00	2.840	-0.40	2-19.00	1.480	2.830	0	67 P	3AER00900
-30.00	2.10	1.34	1-30.00	1.480	2.830	0	67 P	3AER00910
-1.0000000	0.0000000	0.0000000	-1.0000000	0.0000001	0.0000000	0	Z	332H 0920
-1.0000001	0.0000000	0.0000000	-1.0000001	0.0000001	0.0000000	0.0000000	Z	332H 0930
N 001	20		PANEL IDENTIFICATION CARD					
1 000			FLEMENT READ CONTROL CARD					
-16.00	3.098	-0.848	2-16.00	3.09A	-0.848	0	67 N	3AER00970
-30.00	4.521	-0.848	1-30.00	5.580	1.340	0	67 N	3AER00980
-1.0000000	0.0000000	0.0000000	-1.0000000	0.0000001	0.0000000	0	Z	332B 0990
-1.0000001	0.0000000	0.0000000	-1.0000001	0.0000001	0.0000000	0.0000003	Z	332H 1000
0 001	20		PANEL IDENTIFICATION CARD					
1 000			FLEMENT READ CONTROL CARD					
-16.00	3.098	-0.848	2-16.00	3.09B	-0.848	0	67 O	3AER01040
-30.00	5.58	1.340	1-30.00	2.100	1.340	0	67 O	3AER01050
-1.0000000	0.0000000	0.0000000	-1.0000000	0.0000001	0.0000000	0	Z	332H 1060
-1.0000001	0.0000000	0.0000000	-1.0000001	0.0000001	0.0000000	0.0000003	Z	332R 1070
R 001	20		PANEL IDENTIFICATION CARD					
1 000			FLEMENT READ CONTROL CARD					
-23.166	0.166	3.800	2-23.084	0.144	3.800	0	67 R	3AER01110
-23.023	0.084	3.800	0-23.080	0.00	3.800	0	67 H	3AER01120
-30.166	0.166	7.500	1-30.084	0.144	7.500	0	67 R	3AER01130
-30.023	0.084	7.500	0-30.000	0.00	7.500	0	67 H	3AER01140
-1.0000000	0.0000000	0.0000000	-1.0000000	0.0000001	0.0000000	0	Z	332R 1150
-1.0000001	0.0000000	0.0000000	-1.0000001	0.0000001	0.0000000	0.0000003	Z	332H 1160
S 001	20		PANEL IDENTIFICATION CARD					
1 000			FLEMENT READ CONTROL CARD					
-23.166	0.166	3.800	2-30.166	0.166	7.500	0	67 S	3AER01200
-30.000	0.166	3.800	1-31.500	0.166	7.500	0	67 S	3AER01210
-1.0000000	0.0000000	0.0000000	-1.0000000	0.0000001	0.0000000	0	Z	332B 1220
-1.0000001	0.0000000	0.0000000	-1.0000001	0.0000001	0.0000000	0.0000003	Z	332R 1230
BF 001	20		PANEL IDENTIFICATION CARD					
1 000			FLEMENT READ CONTROL CARD					
-0.125	0.00	-0.162	2-0.125	0.00	-0.162	0	67 H	3AER01270
-1.00	0.00	-0.200	1-1.00	0.195	-0.200	0	67 B	3AER01280
-1.00	0.00	-0.20	2-1.00	0.195	-0.20	0	67 F	3AFR01290
-16.00	0.00	-1.00	1-16.00	2.95	-1.00	0	67 F	3AER01300
-1.0000000	0.0000000	0.0000000	-1.0000000	0.0000001	0.0000000	0	Z	332H 1310
-1.0000001	0.0000000	0.0000000	-1.0000001	0.0000001	0.0000000	0.0000003	Z	332R 1320
JI 001	20		PANEL IDENTIFICATION CARD					

(PANEL 5 cont.)

Reading in Geometry Data
Type 3 cards
(PANEL 6)

Reading in Geometry Data
Type 3 cards
(PANEL 7)

Reading in Geometry Data
Type 3 cards
PANEL 8

Reading in Geometry Data
Type 3 cards
(PANEL 9)

Reading in Geometry Data
Type 3 cards
(PANEL 10)

Reading in Geometry Data

SAMPLE PROBLEM #1 (continued)

0	1	2	3	4	5	6	7	8
1234567890123456789012345678901234567890123456789012345678901234567890								
1.000	0.00	-0.99466	2-15.90	ELFMENT READ CONTROL CARD	-0.99466	0	67J0	3AFR01360
-15.90	0.00	-1.00	1-16.00	1.00	-1.00	0	67J0	3AER01370
-16.00	0.00	-1.00	1-30.00	1.00	-1.00	0	67J0	3AFR01380
-30.00	0.00	0.00000000	0.00000000	0.00000000	0.00000000	0	Z	332R 1390
-1.00000001	0.00000000	0.00000000	-1.00000001	0.00000001	0.00000000	0	Z	332R 1400
J0EV011	20			PANEL IDENTIFICATION CARD				
1.000	2.920	-0.99466	2-16.00	ELFMENT HEAD CONTROL CARD	-1.00	0	67J0	3AFR01440
-15.90	3.100	-1.00	0-20.00	2.920	-1.00	0	67J0	3AER01450
-18.00	3.450	-1.00	0-24.00	3.270	-1.00	0	67J0	3AFR01460
-22.00	3.800	-1.00	0-28.00	3.620	-1.00	0	67J0	3AFR01470
-26.00	4.142	-1.00	0-15.90	3.980	-1.00	0	67J0	3AFR01480
-30.00	2.90	-1.00	0-18.00	2.90	-0.99466	1	67J0	3AFR01490
-16.00	2.90	-1.00	0-22.00	2.90	-1.00	0	67J0	3AFR01500
-20.00	2.90	-1.00	0-26.00	2.90	-1.00	0	67J0	3AER01510
-24.00	2.90	-1.00	0-30.00	2.90	-1.00	0	67J0	3AFR01520
-28.00	2.90	-0.99466	1-16.00	2.00	-1.00	0	67J0	3AFR01530
-15.90	2.00	-1.00	0-20.00	2.00	-1.00	0	67J0	3AER01540
-18.00	2.00	-1.00	0-24.00	2.00	-1.00	0	67J0	3AER01550
-22.00	2.00	-1.00	0-28.00	2.00	-1.00	0	67J0	3AFR01560
-26.00	2.00	-1.00	0-15.90	1.00	-0.99466	1	67J0	3AER01570
-30.00	1.00	-1.00	0-18.00	1.00	-1.00	0	67J0	3AFR01580
-20.00	1.00	-1.00	0-22.00	1.00	-1.00	0	67J0	3AER01590
-24.00	1.00	-1.00	0-26.00	1.00	-1.00	0	67J0	3AER01600
-28.00	1.00	-1.00	0-30.00	1.00	-1.00	0	67J0	3AER01610
-30.00	1.00	-1.00	2-30.50	1.00	-1.00	0	67FV	3AER01620
-30.00	4.142	-1.00	0-31.50	4.113	-1.00	0	67FV	3AER01630
-31.00	4.084	-1.00	0-32.50	4.056	-1.00	0	67FV	3AER01640
-32.00	4.028	-1.00	1-30.50	4.000	-1.00	0	67FV	3AER01650
-30.00	2.90	-1.00	0-31.50	2.90	-1.00	0	67FV	3AFR01660
-31.00	2.90	-1.00	0-32.50	2.90	-1.00	0	67FV	3AER01670
-32.00	2.90	-1.00	1-30.50	2.00	-1.00	0	67FV	3AER01680
-30.00	2.00	-1.00	0-31.50	2.00	-1.00	0	67FV	3AER01690
-31.00	2.00	-1.00	0-32.50	2.00	-1.00	0	67FV	3AER01700
-30.00	1.0	-1.00	1-30.50	1.0	-1.00	0	67FV	3AER01710
-31.00	1.0	-1.00	0-31.50	1.0	-1.00	0	67FV	3AER01720
-32.00	1.0	-1.00	0-32.50	1.0	-1.00	3	67FV	3AER01730
SF101	20			PANEL IDENTIFICATION CARD				
1.000	0.00	-0.162	2-16.00	ELFMENT CONTROL CARD	-1.00	0	67SF	3AER02030
-0.125				2.95				

Reading in Geometry Data
Type 3 cards
(PANEL 11)

Reading in Geometry Data
Type 3 cards
(PANEL 12)

Reading in Geometry Data
Type 3 cards
(PANEL 13)

SAMPLE PROBLEM #1 (continued)

0	1	2	3	4	5	6	7	8
123456789012345678901234567890123456789012345678901234567890								
-0.125	0.00	-0.162	1-16.00	0.00	-1.00	0	67SF	3AER02040
-16.00	1.00	-1.00	2-30.00	1.00	-1.00	0	67SF	3AER02050
-16.00	0.00	-1.00	1-30.00	0.00	-1.00	0	67SF	3AER02060
-16.00	2.95	-1.00	2-32.50	4.10	-1.00	0	67SF	3AER02070
-16.00	1.00	-1.00	1-32.50	1.00	-1.00	0	67SF	3AER02080
-16.00	3.098	-0.848	2-30.00	5.580	-0.848	0	67SF	3AER02090
-16.00	3.098	-0.848	1-30.00	4.321	0.848	0	67SF	3AER02100
-0.125	0.00	0.162	2-16.00	0.00	3.550	0	67SF	3AER02110
-0.125	0.100	0.125	1-16.00	1.60	2.480	0	67SF	3AER02120
-16.00	0.00	3.550	2-30.00	0.00	3.80	0	67SF	3AER02130
-16.00	1.60	2.480	1-30.00	1.480	2.830	0	67SF	3AER02140
-0.125	0.100	0.126	2-16.00	1.60	2.480	0	67SF	3AER02150
-0.125	0.157	0.038	1-16.00	3.098	-0.848	0	67SF	3AER02160
-16.00	1.60	2.480	2-30.00	1.480	2.830	0	67SF	3AER02170
-16.00	3.098	-0.848	1-30.00	2.10	1.340	0	67SF	3AER02180
-16.00	3.098	-0.848	2-30.00	2.10	1.340	0	67SF	3AER02190
-16.00	3.098	-0.848	1-30.00	5.580	1.340	5	67SF	3AER02200
TEST CASE NO. 1	INVTSCID							
233345								
19.0845	200000.0		AER0 FLAG CARD	0.5	FLIGHT CONDITION CARD			
152.0	30.0	8.3	-18.6	0.0	1.0			
5.0	0.0							
7.0	0.0							
10.0	0.0							
12.0	0.0							
15.0	0.0							
210								
0 1 2 3 4 510			SHIELDING TITLE CARD					
9 1 2 3 4 510			SHIELDING COMPONENT CARD					
80	TEST CASE NO. 1		SHIELDING COMPONENT CARD					
1 2	1		COMPONENT ORGANIZATION CARD					
1 11	2.0	1.0	1.0	1.0				
3 4	1		COMPONENT ORGANIZATION CARD					
5 31	2.0	1.0	1.0	1.0				
5	2		COMPONENT ORGANIZATION CARD					
6	2		COMPONENT ORGANIZATION CARD					
7	201		COMPONENT ORGANIZATION CARD					
8	201		COMPONENT ORGANIZATION CARD					
9	1		COMPONENT ORGANIZATION CARD					
10 3	2.0	1.0	1.0	1.0				

(PANEL 13 cont.)

Last card for GEM. option.
AER0. Title Card.
AER0. options are:
a. Shielding
b. Pressures
c. Pressures
d. Pressures
e. Viscous
f. Summation

Shielding Inputs

1st Pressure option
(PANELS 1 thru 10)
Component Forces 1 thru 8

SAMPLE PROBLEM #1 (continued)

0	1	2	3	4	5	6	7	8
1234567890123456789012345678901234567890123456789012345678901234567890								
21	SECOND HALF			COMPONENT ORGANIZATION CARD				
11	1	1.0	1.0	1.0	5.0001	3.001		
9	72	2.0		COMPONENT ORGANIZATION CARD				
12	2			COMPONENT ORGANIZATION CARD				
012	PRESSURES FOR SKIN FRICTION SURFACES							
13	100							
0503101	2.0	1.0	1.0	1.0				
011	LAMINAR SKIN FRICTION							
13	1	1	9					
110								
11010311123.7063	16.021	0.00	0.00	0.00		1.0	67	11AER03510
21010311114.1002	14.00	16.0210.718	1.00	1.00		1.0	67	11AER03520
31010311143.3696	16.50	11.50 0.00	1.00	1.00		1.0	67	11AER03530
41010311117.7211	14.00	0.00	1.00	1.00		1.0	67	11AER03540
51010311118.2417	16.644	0.00	1.00	1.00		1.0	67	11AER03550
61010311126.5187	14.00	16.6441.00	1.00	1.00		1.0	67	11AER03560
71010311124.3335	16.00	0.00	1.00	1.00		1.0	67	11A5963570
81010311138.8777	14.00	16.00 1.00	1.00	1.00		1.0	67	11AER03580
91010311124.0557	14.174	0.00	1.00	1.00		1.0	67	11AER03590

2nd Pressure option
(PANEL 11 and 12)
Component Forces 9 and 10
3rd Pressure option
(PANEL 13) No
Component Forces Saved

VISCOUS option
(PANEL 13)
9 skin friction surfaces
Component forces 11

SUMMATION option
a.) Component Forces
1 thru 8 are summed
b.) Component Forces
1 thru 10 are summed
c.) Component Forces
1 thru 11 are summed.

01110 0102030405060708
01110 01020304050607080910
11110 0102030405060708091011

SAMPLE PROBLEM #3

0 1 2 3 4 5 6 7 8
 123456789012345678901234567890123456789012345678901234567890

222 CASE 101A WING FLOW FIELD, INVISCID BODY AND WING PRESSURES

1133	4.5	3.402277	175.	0.03					
	107.58262	100.0	34.2657	0.0	0.0				
0.0	0.0	0.0	0.0	0.0	0.0				
2.0	0.0	0.0	0.0	0.0	0.0				
6.0	0.0	0.0	0.0	0.0	0.0				
0	10014.5								
	00010.0								
	1001120								
00211	-2.0								
01	0.0								
90.0	0.0								
02022.0	0.0								
1001120									
01211	-2.0								
12036.0	0.0								
1001120									
01211	-2.0								
1	11014.5								
01010.0	0.0								
1101111									
2	01022.0								
1101111									
2	11036.0								
1101111									
2	010								
010	010								
01	0505100	2.0	1.0	1.0	1.0				
0505000	2.0	1.0	1.0	1.0	1.0				
0505100	2.0	1.0	1.0	1.0	1.0				
011									
02	1305100	2.0	1.0	1.0	1.0				

Options are: AERφ, AERQφ, AERQφ
 AERφ: Title Card
 Options in 1st AERφ.
 a.) Flow Field Generation
 b.) Flow Field Interrogation
 c.) Pressures
 d.) Pressures

1st Flow Field option
 Generation of φ = 90°
 Flow Fields for 3
 α-β sets.

2nd Flow Field Option
 (Interrogation of Saved
 Flow Field data)

1st Pressure option
 No Detailed print for 2nd α-β set
 (PANEL 1) Force Component 1
 2nd Pressure option
 Calculation of Wing Pressures
 with Interference for 3 α-β
 sets. (PANEL 2) Force Component 2

Meridian cut and
 Flow Field
 Generation
 2nd α-β
 3rd α-β

1st α-β

BODY ALONE INVISCID COMPONENT

SAMPLE PROBLEM #3 (continued)

0	123456789012345678901234567890123456789012345678901234567890	1	2	3	4	5	6	7	8
211	0101								
212	0101								
213	0101								
CASE 101A	Interference cards								
3	0101								
4.5	3.402277	175.							
-102.58262	100.0		34.2857	0.0		003			
0.0	0.0					0.0			
2.0	0.0								
6.0	0.0								
011	AREA ON BODY COVERED BY WING								
03	100								
0505000	2.0	1.0	1.0	1.0	1.0	1.0			
CASE 101A	PRESSURES, SKIN FRI., PRESSURES, SKIN FRI., SUMMATION								
34340345									
4.5	3.402277	175.							
102.58262	100.0		34.2857	0.0		003			
0.0	0.0					0.0			
2.0	0.0								
6.0	0.0								
012	PRESSURES FOR BODY SKIN FRI. (1,2,3,5,7,8)								
04	100								
0505101	2.0	1.0	1.0	1.0	1.0	1.0			
011	TURBULENT SKIN FRICTION(BODY ALONE 1,2,3,5,7,8)								
04	1006								
110									
01100	2112129.61	1.389436	0.0	1.0	1.0	518.67518.67			
02100	2112198.72	1.527231	1.38941.0	1.0	1.0	518.67518.67			
03100	2112129.61	1.389436	0.0	1.0	1.0	518.67518.67			
05100	2112129.61	1.389436	0.0	1.0	1.0	518.67518.67			
07100	2112129.61	1.389436	0.0	1.0	1.0	518.67518.67			
08100	2112198.72	1.527231	1.38941.0	1.0	1.0	518.67518.67			
012	PRESSURES FOR BODY SKIN FRICTION(4,6)								
05	100								
0505101	2.0	1.0	1.0	1.0	1.0	1.0			
011	TURBULENT SKIN FRICTION(BODY ALONE 4,6)								
05	1002								
110									
04100	2112198.72	1.527231	1.38941.0	1.0	1.0	518.67518.67			
06100	2112198.72	1.527231	1.38941.0	1.0	1.0	518.67518.67			
011	TURBULENT SKIN FRICTION (BODY WITH WING 4,6)								

(2nd Pressure option const.)

AERD. Title Card 2nd AERD option AERD option is Pressures

Negative increment due to area covered on body due to wing (PANEL 3) Force Component 3

AERD. Title Card 3rd AERD option Options for this entry into AERD

1st option Pressures for Skin friction No Force Component is saved

2nd option VISCOS 6- skin friction surfaces (PANEL 4) Force Component 4

3rd option Pressures for Skin friction (PANEL 5) No Force Component is saved.

4th option VISCOS 2 skin friction surfaces (PANEL 5) Force Component 5

Contrails

SAMPLE PROBLEM #3 (continued)

0	1	2	3	4	5	6	7	8
123456789012345678901234567890123456789012345678901234567890								
05				1002				
110								
04100	2112145,9873	1.527231	1.38941.0	1.0	518.67518.67			
06100	2112145,9873	1.527231	1.38941.0	1.0	518.67518.67			
012	PRESSURES FOR WING SKIN FRICTION							
06	100							
1305101	2.0	1.0	1.0	1.0				
011	TURBULENT SKIN FRICTION FOR WING							
06	1004							
110								
09100	2112149,9086	.622293	0.0	1.0	0.0	518.67518.67		
10100	2112135,9064	.724815	.622290.0	0.0	0.0	518.67518.67		
11100	2112149,9086	.622293	0.0	1.0	0.0	518.67518.67		
12100	2112135,9064	.724815	.622290.0	0.0	0.0	518.67518.67		
1								
01000	01							
01010	010405							
01010	0103							
01010	01030406							
01010	010203							
11010	010203040607							

(Viscous option cont)

5th option Pressures for skin friction surfaces (PANEL 6) No Force Component is saved

6th option Viscous (PANEL 6) Force Component 7

SUMMATION option

- a.) Body Alone Inviscid
- b.) Body Alone Inviscid + Skin Fric.
- c.) Body (In Presence of Wing) Inviscid
- d.) Body (In Presence of Wing) Inviscid + Skin friction
- e.) Body + Wing Inviscid
- f.) Body + Wing Inviscid + Skin friction

SAMPLE PROBLEM #5

HYPERSONIC ARBITRARY-BODY PROGRAM INPUT DATA

0 1234567890123456789012345678901234567890123456789012345678901234567890

GEpm. and AERd options

12	08000 04	00	00	2	3	4	5	6	7	8
A	1 000	TND=6480	TEST CASE,	PANEL ID CARD	ELEMENT CONTROL CARD	CASE 99				
0.0	0.0	0.0	0.0	0.0	0.0	0.0	0.0	0.0	99 A	3AERO 1
0.0	0.0	0.0	0.0	0.0	0.0	0.0	0.0	0.0	99 A	3AERO 2
0.0	0.0	0.0	0.0	0.0	0.0	0.0	0.0	0.0	99 A	3AERO 3
0.0	0.0	0.0	0.0	0.0	0.0	0.0	0.0	0.0	99 A	3AERO 4
0.0	0.0	0.0	0.0	0.0	0.0	0.0	0.0	0.0	99 A	3AERO 5
0.0	0.0	0.0	0.0	0.0	0.0	0.0	0.0	0.0	99 A	3AERO 6
0.0	0.0	0.0	0.0	0.0	0.0	0.0	0.0	0.0	99 A	3AERO 7
0.0	0.0	0.0	0.0	0.0	0.0	0.0	0.0	0.0	99 A	3AERO 8
0.0	0.0	0.0	0.0	0.0	0.0	0.0	0.0	0.0	99 A	3AERO 9
-0.7000	0.0149	-0.17411	-0.7000	0.0442	0.0442	0.0442	0.0442	-0.16490	99 A	3AERO 10
-0.7000	0.0722	-0.15470	-0.7000	0.0979	0.0979	0.0979	0.0979	-0.13990	99 A	3AERO 11
-0.7000	0.1207	-0.12070	-0.7000	0.1399	0.1399	0.1399	0.1399	-0.09790	99 A	3AERO 12
-0.7000	0.1547	-0.07220	-0.7000	0.1649	0.1649	0.1649	0.1649	-0.04420	99 A	3AERO 13
-0.7000	0.1701	-0.01490	-0.7000	0.1701	0.1701	0.1701	0.1701	0.01490	99 A	3AERO 14
-0.7000	0.1649	0.04420	-0.7000	0.1547	0.1547	0.1547	0.1547	0.07220	99 A	3AERO 15
-0.7000	0.1399	0.09790	-0.7000	0.1207	0.1207	0.1207	0.1207	0.12070	99 A	3AERO 16
-0.7000	0.0442	0.16490	-0.7000	0.0722	0.0722	0.0722	0.0722	0.15470	99 A	3AERO 17
-2.1000	0.0334	-0.34651	-0.7000	0.0149	0.0149	0.0149	0.0149	0.17010	99 A	3AERO 18
-2.1000	0.1640	-0.35170	-2.1000	0.1004	0.1004	0.1004	0.1004	-0.37480	99 A	3AERO 19
-2.1000	0.2744	-0.27440	-2.1000	0.2226	0.2226	0.2226	0.2226	-0.31780	99 A	3AERO 20
-2.1000	0.3517	-0.16400	-2.1000	0.3748	0.3748	0.3748	0.3748	-0.22260	99 A	3AERO 21
-2.1000	0.3865	-0.03340	-2.1000	0.3865	0.3865	0.3865	0.3865	0.10040	99 A	3AERO 22
-2.1000	0.3748	0.10040	-2.1000	0.3517	0.3517	0.3517	0.3517	0.16400	99 A	3AERO 23
-2.1000	0.2226	0.31780	-2.1000	0.2744	0.2744	0.2744	0.2744	0.27440	99 A	3AERO 24
-2.1000	0.1004	0.37480	-2.1000	0.1640	0.1640	0.1640	0.1640	0.35170	99 A	3AERO 25
-3.5000	0.0495	-0.56521	-3.5000	0.1469	0.1469	0.1469	0.1469	0.58650	99 A	3AERO 26
-3.5000	0.2398	-0.51420	-3.5000	0.3254	0.3254	0.3254	0.3254	-0.46480	99 A	3AERO 27
-3.5000	0.4012	-0.40120	-3.5000	0.4648	0.4648	0.4648	0.4648	-0.52540	99 A	3AERO 28
-3.5000	0.5142	-0.23980	-3.5000	0.5481	0.5481	0.5481	0.5481	-0.32540	99 A	3AERO 29
-3.5000	0.5652	-0.04950	-3.5000	0.5652	0.5652	0.5652	0.5652	0.14690	99 A	3AERO 30
-3.5000	0.5481	0.14690	-3.5000	0.5142	0.5142	0.5142	0.5142	0.23980	99 A	3AERO 31
-3.5000	0.4648	0.32540	-3.5000	0.4012	0.4012	0.4012	0.4012	0.40120	99 A	3AERO 32
-3.5000	0.3254	0.46480	-3.5000	0.2398	0.2398	0.2398	0.2398	0.51420	99 A	3AERO 33
-3.5000	0.1469	0.54810	-3.5000	0.0495	0.0495	0.0495	0.0495	0.51420	99 A	3AERO 34
-4.9000	0.0634	-0.72521	-4.9000	0.1884	0.1884	0.1884	0.1884	0.56520	99 A	3AERO 35
								-0.70320	99 A	3AERO 36
										37

Reading in Geometry Data
Type 3 cards
(PANEL 1, Body)

SAMPLE PROBLEM #5 (continued)

0	1	2	3	4	5	6	7	8
123456789012345678901234567890123456789012345678901234567890	123456789012345678901234567890123456789012345678901234567890	123456789012345678901234567890123456789012345678901234567890	123456789012345678901234567890123456789012345678901234567890	123456789012345678901234567890123456789012345678901234567890	123456789012345678901234567890123456789012345678901234567890	123456789012345678901234567890123456789012345678901234567890	123456789012345678901234567890123456789012345678901234567890	123456789012345678901234567890123456789012345678901234567890
-65.0000	0.0713	4.08441	-65.0000	0.0000	4.08500	99 A 3AERO	23	
-69.3000	0.0724	4.14591	-69.3000	0.0000	4.14650	99 A 3AERO	25	
-70.0000	0.0724	4.14941	-70.0000	0.0000	4.15000	99 A 3AERO	26	
-70.7000	0.0724	4.14941	-70.7000	0.0000	4.15000	99 A 3AERO	27	
-79.0000	0.0724	4.14941	-79.0000	0.0000	4.15000	99 A 3AERO	28	
-81.0000	0.0724	4.14941	-81.0000	0.0000	4.15000	99 A 3AFRO	29	
-89.0000	0.0724	4.14941	-89.0000	0.0000	4.15000	99 A 3AERO	30	
-91.0000	0.0724	4.14941	-91.0000	0.0000	4.15000	99 A 3AERO	31	
-97.0000	0.0724	4.14941	-97.0000	0.0000	4.15000	99 A 3AERO	32	
-100.0000	0.0724	4.14941	-100.0000	0.0000	4.15003	99 A 3AERO	33	
8 011								
1 000								
-47.3990	4.1500	0.0	2 -53.0366	4.1500	0.33830	100 3WING	1	
-58.6742	4.1500	0.67650	-64.3118	4.1500	1.01480	100 3WING	2	
-69.9495	4.1500	1.35300	-75.5871	4.1500	1.01480	100 3WING	3	
-81.2247	4.1500	0.67650	-86.8623	4.1500	0.33830	100 3WING	4	
-92.5000	4.1500	0.0	-92.5000	4.1500	0.0	100 3WING	5	
-50.7230	5.7000	0.0	1 -55.9451	5.7000	0.31330	100 3WING	6	
-61.1672	5.7000	0.62670	-66.3894	5.7000	0.94000	100 3WING	7	
-71.6115	5.7000	1.25330	-76.8336	5.7000	0.94000	100 3WING	8	
-82.0557	5.7000	0.62670	-87.2778	5.7000	0.31330	100 3WING	9	
-92.5000	5.7000	0.0	-92.5000	5.7000	0.0	100 3WING	10	
-54.1550	7.3000	0.0	1 -58.9481	7.3000	0.28760	100 3WING	11	
-63.7412	7.3000	0.57520	-68.5344	7.3000	0.86280	100 3WING	12	
-73.3275	7.3000	1.15030	-78.1206	7.3000	0.86280	100 3WING	13	
-82.9137	7.3000	0.57520	-87.7068	7.3000	0.28760	100 3WING	14	
-92.5000	7.3000	0.0	-92.5000	7.3000	0.0	100 3WING	15	
-57.3720	8.8000	0.0	1 -61.7630	8.8000	0.26350	100 3WING	16	
-66.1540	8.8000	0.52690	-70.5450	8.8000	0.79040	100 3WING	17	
-74.9360	8.8000	1.05380	-79.3270	8.8000	0.79040	100 3WING	18	
-83.7180	8.8000	0.52690	-88.1090	8.8000	0.26350	100 3WING	19	
-92.5000	8.8000	0.0	-92.5000	8.8000	0.0	100 3WING	20	
-60.7780	10.3888	0.0	1 -64.7420	10.3888	0.23780	100 3WING	21	
-68.7060	10.3888	0.47570	-72.6700	10.3888	0.71350	100 3WING	22	
-76.6340	10.3888	0.95140	-80.5980	10.3888	0.71350	100 3WING	23	
-84.5620	10.3888	0.47570	-88.5260	10.3888	0.23780	100 3WING	24	
-92.4900	10.3888	0.0	-92.4900	10.3888	0.0	100 3WING	25	
-64.2100	11.9888	0.0	1 -67.7462	11.9888	0.21220	100 3WING	26	
-71.2825	11.9888	0.42430	-74.8187	11.9888	0.63650	100 3WING	27	
-78.3550	11.9888	0.84870	-81.8912	11.9888	0.63650	100 3WING	28	
-85.4275	11.9888	0.42430	-88.9637	11.9888	0.21220	100 3WING	29	

Completion of Reading in
PANEL 1
Note. Some PANEL 1
Type 3 cards have been
omitted for brevity

Reading in Geometry Data
Type 3 cards
(PANEL 2, Upper Wing)
Streamwise strips

SAMPLE PROBLEM #5 (continued)

0	1	2	3	4	5	6	7	8
1234567890123456789012345678901234567890123456789012345678901234567890								
-92.5000	11.9888	0.0	0.0	-92.5000	11.9888	0.0	100	3WING 30
-67.6650	13.6000	0.0	1	-70.7694	13.6000	0.18630	100	3WING 31
-73.8737	13.6000	0.37250	0.0	-76.9781	13.6000	0.55880	100	3WING 32
-80.0825	13.6000	0.74500	0.0	-83.1868	13.6000	0.55880	100	3WING 33
-86.2912	13.6000	0.37250	0.0	-89.3956	13.6000	0.18630	100	3WING 34
-92.5000	13.6000	0.0	0	-92.5000	13.6000	0.0	100	3WING 35
-70.7760	15.0508	0.0	1	-73.4915	15.0508	0.16290	100	3WING 36
-76.2070	15.0508	0.32590	0.0	-78.9225	15.0508	0.48880	100	3WING 37
-81.6380	15.0508	0.65170	0.0	-84.3535	15.0508	0.48880	100	3WING 38
-87.0690	15.0508	0.32590	0.0	-89.7845	15.0508	0.16290	100	3WING 39
-92.5000	15.0508	0.0	0	-92.5000	15.0508	0.0	100	3WING 40
-74.2070	16.6508	0.0	1	-76.4036	16.6508	0.13720	100	3WING 41
-78.7802	16.6508	0.27440	0.0	-81.0668	16.6508	0.41160	100	3WING 42
-83.3535	16.6508	0.54880	0.0	-85.6401	16.6508	0.41160	100	3WING 43
-87.9267	16.6508	0.27440	0.0	-90.2133	16.6508	0.13720	100	3WING 44
-92.5000	16.6508	0.0	0	-92.5000	16.6508	0.0	100	3WING 45
-77.5300	18.2000	0.0	1	-79.4012	18.2000	0.11230	100	3WING 46
-81.2725	18.2000	0.22450	0.0	-83.1437	18.2000	0.33680	100	3WING 47
-85.0150	18.2000	0.44910	0.0	-86.8862	18.2000	0.53680	100	3WING 48
-88.7575	18.2000	0.22450	0.0	-90.6287	18.2000	0.11230	100	3WING 49
-92.5000	18.2000	0.0	0	-92.5000	18.2000	0.0	100	3WING 50
-80.8110	19.7300	0.0	1	-82.2721	19.7300	0.08770	100	3WING 51
-83.7332	19.7300	0.17530	0.0	-85.1944	19.7300	0.26300	100	3WING 52
-86.6555	19.7300	0.35070	0.0	-88.1166	19.7300	0.26300	100	3WING 53
-89.5777	19.7300	0.17530	0.0	-91.0388	19.7300	0.08770	100	3WING 54
-92.5000	19.7300	0.0	0	-92.5000	19.7300	0.0	100	3WING 55
-84.2420	21.3300	0.0	1	-85.2742	21.3300	0.06190	100	3WING 56
-86.3065	21.3300	0.12390	0.0	-87.3387	21.3300	0.18580	100	3WING 57
-88.3710	21.3300	0.24770	0.0	-89.4032	21.3300	0.18580	100	3WING 58
-90.4355	21.3300	0.12390	0.0	-91.4677	21.3300	0.06190	100	3WING 59
-92.5000	21.3300	0.0	0	-92.5000	21.3300	0.0	100	3WING 60
-87.8230	23.0000	0.0	1	-88.4076	23.0000	0.03510	100	3WING 61
-88.9922	23.0000	0.07020	0.0	-89.5769	23.0000	0.10520	100	3WING 62
-90.1615	23.0000	0.14030	0.0	-90.7461	23.0000	0.10520	100	3WING 63
-91.3307	23.0000	0.07020	0.0	-91.9154	23.0000	0.03510	100	3WING 64
-92.5000	23.0000	0.0	0	-92.5000	23.0000	0.0	100	3WING 65
-92.5000	25.2000	0.0	1	-92.5000	25.2000	0.00000	100	3WING 66
-92.5000	25.2000	0.00000	0.0	-92.5000	25.2000	0.00000	100	3WING 67
-92.5000	25.2000	0.00000	0.0	-92.5000	25.2000	0.00000	100	3WING 68
-92.5001	25.2000	0.00000	0.0	-92.5001	25.2000	0.00000	100	3WING 69
-92.5001	25.2000	0.0	0	-92.5001	25.2000	0.0	100	3WING 70

(PANEL 2 cont.)

SAMPLE PROBLEM #5 (continued)

0	1	2	3	4	5	6	7	8
1234567890123456789012345678901234567890123456789012345678901234567890								
C 011	00	PANEL ID CARD						
1 000		FLPMENT CONTROL CARD						
-92.5000	25.2000	0.0	2	-92.5000	25.2000	-0.00000	100	SWING 71
-92.5000	25.2000	-0.00000		-92.5000	25.2000	-0.00000	100	SWING 72
-92.5000	25.2000	-0.00000		-92.5000	25.2000	-0.00000	100	SWING 73
-92.5001	25.2000	-0.00000		-92.5001	25.2000	-0.00000	100	SWING 74
-92.5001	25.2000	0.0	0	-92.5001	25.2000	0.0	0	SWING 75
-87.8230	23.0000	0.0	1	-88.4076	23.0000	-0.03510	100	SWING 76
-88.9922	23.0000	-0.07020		-89.5769	23.0000	-0.10520	100	SWING 77
-90.1615	23.0000	-0.14030		-90.7461	23.0000	-0.10520	100	SWING 78
-91.3307	23.0000	-0.07020		-91.9154	23.0000	-0.03510	100	SWING 79
-92.5000	23.0000	0.0	0	-92.5000	23.0000	0.0	0	SWING 80
-64.2420	21.3300	0.0	1	-85.2742	21.3300	-0.06190	100	SWING 81
-86.3065	21.3300	-0.12390		-87.5387	21.3300	-0.18580	100	SWING 82
-86.3710	21.3300	-0.24770		-84.4032	21.3300	-0.18580	100	SWING 83
-90.4355	21.3300	-0.12390		-91.4677	21.3300	-0.06190	100	SWING 84
-92.5000	21.3300	0.0	0	-92.5000	21.3300	0.0	0	SWING 85
-80.8110	19.7300	0.0	1	-82.2721	19.7300	-0.08770	100	SWING 86
-83.7332	19.7300	-0.17530		-85.1944	19.7300	-0.26300	100	SWING 87
-86.6555	19.7300	-0.35070		-88.1166	19.7300	-0.26300	100	SWING 88
-89.5777	19.7300	-0.17530		-91.0388	19.7300	-0.08770	100	SWING 89
-92.5000	19.7300	0.0	0	-92.5000	19.7300	0.0	0	SWING 90
-77.5300	18.2000	0.0	1	-79.4012	18.2000	-0.11230	100	SWING 91
-81.2725	18.2000	-0.22450		-83.1437	18.2000	-0.33680	100	SWING 92
-85.0150	18.2000	-0.44910		-86.8862	18.2000	-0.33680	100	SWING 93
-90.7575	18.2000	-0.22450		-90.6287	18.2000	-0.11230	100	SWING 94
-92.5000	18.2000	0.0	0	-92.5000	18.2000	0.0	0	SWING 95
-74.2070	16.6508	0.0	1	-76.4936	16.6508	-0.13720	100	SWING 96
-78.7802	16.6508	-0.27440		-81.0668	16.6508	-0.41160	100	SWING 97
-83.3535	16.6508	-0.54880		-85.6401	16.6508	-0.41160	100	SWING 98
-87.9207	16.6508	-0.27440		-90.2133	16.6508	-0.13720	100	SWING 99
-92.5000	16.6508	0.0	0	-92.5000	16.6508	0.0	0	SWING 100
-70.7760	15.0508	0.0	1	-73.4915	15.0508	-0.16290	100	SWING 101
-76.2070	15.0508	-0.32590		-78.9225	15.0508	-0.48880	100	SWING 102
-81.6360	15.0508	-0.65170		-84.3535	15.0508	-0.48880	100	SWING 103
-87.0690	15.0508	-0.32590		-89.7845	15.0508	-0.16290	100	SWING 104
-92.5000	15.0508	0.0	0	-92.5000	15.0508	0.0	0	SWING 105
-67.6650	13.6000	0.0	1	-70.7694	13.6000	-0.18630	100	SWING 106
-73.8737	13.6000	-0.37250		-76.9781	13.6000	-0.55880	100	SWING 107
-80.0825	13.6000	-0.74500		-83.1868	13.6000	-0.55880	100	SWING 108
-86.2912	13.6000	-0.37250		-89.3956	13.6000	-0.18630	100	SWING 109

Reading in Geometry Data
Type 3 cards
(PANEL 3, Lower Wing)
Streamwise strips

SAMPLE PROBLEM #5 (continued)

0	1	2	3	4	5	6	7	8
1234567890123456789012345678901234567890123456789012345678901234567890								
-92.5000	13.6000	0.0	0	-92.5000	13.6000	0.0	100	3WING 110
-64.2100	11.9888	0.0	1	-67.7462	11.9888	-0.21220	100	3WING 111
-71.2825	11.9888	-0.42430		-74.8187	11.9888	-0.63650	100	3WING 112
-78.3550	11.9888	-0.84870		-81.8912	11.9888	-0.63650	100	3WING 113
-85.4275	11.9888	-0.42430		-88.9637	11.9888	-0.21220	100	3WING 114
-92.5000	11.9888	0.0	0	-92.5000	11.9888	0.0	100	3WING 115
-60.7780	10.3888	0.0	1	-64.7420	10.3888	-0.23780	100	3WING 116
-68.7060	10.3888	-0.47570		-72.6700	10.3888	-0.71350	100	3WING 117
-76.6340	10.3888	-0.95140		-80.5980	10.3888	-0.71350	100	3WING 118
-84.5620	10.3888	-0.47570		-88.5260	10.3888	-0.23780	100	3WING 119
-92.4900	10.3888	0.0	0	-92.4900	10.3888	0.0	100	3WING 120
-57.3720	8.8000	0.0	1	-61.7430	8.8000	-0.26350	100	3WING 121
-66.1540	8.8000	-0.52690		-70.5450	8.8000	-0.79040	100	3WING 122
-74.9360	8.8000	-1.05380		-79.3270	8.8000	-0.79040	100	3WING 123
-83.7180	8.8000	-0.52690		-88.1090	8.8000	-0.26350	100	3WING 124
-92.5000	8.8000	0.0	0	-92.5000	8.8000	0.0	100	3WING 125
-54.1550	7.3000	0.0	1	-58.9441	7.3000	-0.28760	100	3WING 126
-63.7412	7.3000	-0.57520		-68.5344	7.3000	-0.86280	100	3WING 127
-73.3275	7.3000	-1.15030		-78.1206	7.3000	-0.86280	100	3WING 128
-82.9137	7.3000	-0.57520		-87.7068	7.3000	-0.28760	100	3WING 129
-92.5000	7.3000	0.0	0	-92.5000	7.3000	0.0	100	3WING 130
-50.7230	5.7000	0.0	1	-55.9451	5.7000	-0.31330	100	3WING 131
-61.1672	5.7000	-0.62670		-66.3894	5.7000	-0.94000	100	3WING 132
-71.6115	5.7000	-1.25330		-76.8336	5.7000	-0.94000	100	3WING 133
-82.0557	5.7000	-0.62670		-87.2778	5.7000	-0.31330	100	3WING 134
-92.5000	5.7000	0.0	0	-92.5000	5.7000	0.0	100	3WING 135
-47.3990	4.1500	0.0	1	-53.0366	4.1500	-0.53830	100	3WING 136
-58.6742	4.1500	-0.67650		-64.3118	4.1500	-1.01480	100	3WING 137
-69.9495	4.1500	-1.35300		-75.5871	4.1500	-1.01480	100	3WING 138
-81.2247	4.1500	-0.67650		-86.8623	4.1500	-0.33830	100	3WING 139
-92.5000	4.1500	0.0	0	-92.5000	4.1500	0.0	100	3WING 140
0	111	00						
				PANEL 10 CARD				
1 000				ELEMENT CONTROL CARD				
-45.90	3.44	0.0	0	2-69.675	3.90	1.375	0	99 C 3AERU 301
-92.50	4.150	0.0	0	-47.399	4.15	0.0	1	99 C 3AERU 302
-69.9495	4.15	1.35305		0-92.50	4.150	0.0	0	99 C 3AERU 303
-47.399	4.15	0.0	0	2-69.9495	4.15	-1.35305	0	99 C 3AERU 304
-92.50	4.15	0.0	0	0-45.90	3.44	0.0	1	99 C 3AERU 305
-69.675	3.90	-1.375		0-92.50	4.150	0.0	3	99 C 3AERU 306
1133								

(PANEL 3 cont.)

Reading in Geometry Data
Type 3 cards
PANEL 4 Wing-Body
Intersection
Streamwise strips
AERU Title Card
AERU options are
a.) Flow Field Generation
b.) Flow Field Interrogation
c.) Pressures
d.) Pressures

SAMPLE PROBLEM #5 (continued)

0	1	2	3	4	5	6	7	8
1234567890123456789012345678901234567890123456789012345678901234567890								
4.63	0.0	0.0	0.0	0.0	0.01			
1.0	1.0	1.0	-50.0	0.0				
6.20	0.0	0.0						
0	10 14.63	CASE 99 M=4.63 ALPHA=6.2 FLOW FIELD						
	1001 6.20 0.0	MDDSC M=4.63						
	1001120	ARSDTC ALPHA=6.2 CASE 99						
	00211	RDTC ALPHA=6.2 CASE 99						
	01	-150.0						
	0.0	0510						
	0.0	0.0	0.0	0.0	0.0	0.0	0.0	
	0.0	60.0	90.0	120.0	180.			
1	11 14.63	MOTC FLOW FIELD INTERROGATION						
	1101 6.2 0.0	MDDSC FLOW FIELD INTERROGATION						
	1101111	ARSDTC FLOW FIELD INTERROGATION						
	2	RDTC M=4.63 ALPHA=6.2 FLOW FIELD						
	010	ALPHA=6.2 DEG WING PRESS. WITH INTERFERENCE						
	020304	120						
	1305100	1.0	1.0	1.0	1.0	1.0	1.0	
	211	01 03 00						
	011	ALPHA=6.2 WING PRESSURES WITHOUT INTERFERENCE						
	020304	100						
	1305100	1.0	1.0	1.0	1.0	1.0	1.0	

1st Flow Field option (Generation)
5 Meridian flow fields
 $\phi = 0^\circ, 60^\circ, 90^\circ, 120^\circ, 180^\circ$

2nd Flow Field option
(Interrogation)

1st Pressure option
Wing Pressures with Interference
(PANEL 2,3,4)

2nd Pressure option
Wing Pressures without Interference
(PANEL 2,3,4)

SAMPLE PROBLEM #6

0 1 2 3 4 5 6 7 8
123456789012345678901234567890123456789012345678901234567890

Options
1.) GEOMETRY
2.) AEROP.

122222
0800 033 CASE 103 INVISCID AND VISCOUS GFOMETRY

01000	-0.0500	0.0540	0.5282	-0.0500	0.0532	0.53820	103 A	3AERO	6
	-0.0500	0.0507	0.54730	-0.0500	0.0468	0.55580	103 A	3AERO	7
	-0.0500	0.0414	0.56350	-0.0500	0.0347	0.57020	103 A	3AERO	8
	-0.0500	0.0270	0.57560	-0.0500	0.0185	0.57950	103 A	3AERO	9
	-0.0500	0.0094	0.58200	-0.0500	0.0000	0.58280	103 A	3AERO	10
	-0.0250	0.0900	0.52001	-0.0250	0.0886	0.53560	103 A	3AERO	11
	-0.0250	0.0846	0.55080	-0.0250	0.0779	0.56500	103 A	3AERO	12
	-0.0250	0.0689	0.57790	-0.0250	0.0579	0.58890	103 A	3AERO	13
	-0.0250	0.0450	0.59790	-0.0250	0.0308	0.60460	103 A	3AERO	14
	-0.0250	0.0156	0.60860	-0.0250	0.0000	0.61000	103 A	3AERO	15
	-0.0500	0.1200	0.50901	-0.0500	0.1182	0.52980	103 A	3AERO	16
	-0.0500	0.1128	0.55000	-0.0500	0.1039	0.56900	103 A	3AERO	17
	-0.0500	0.0919	0.58610	-0.0500	0.0771	0.60090	103 A	3AERO	18
	-0.0500	0.0660	0.61290	-0.0500	0.0410	0.62180	103 A	3AERO	19
	-0.0500	0.0208	0.62720	-0.0500	0.0000	0.62900	103 A	3AERO	20
	-1.0000	0.1800	0.48601	-1.0000	0.1773	0.51730	103 A	3AERO	21
	-1.0000	0.1691	0.54760	-1.0000	0.1559	0.57600	103 A	3AERO	22
	-1.0000	0.1379	0.60170	-1.0000	0.1157	0.62390	103 A	3AERO	23
	-1.0000	0.0900	0.64190	-1.0000	0.0616	0.65510	103 A	3AERO	24
	-1.0000	0.0313	0.66330	-1.0000	0.0000	0.66600	103 A	3AERO	25
	-2.0000	0.2720	0.44101	-2.0000	0.2679	0.48820	103 A	3AERO	26
	-2.0000	0.2556	0.53400	-2.0000	0.2356	0.57700	103 A	3AERO	27
	-2.0000	0.2084	0.61580	-2.0000	0.1748	0.64940	103 A	3AERO	28
	-2.0000	0.1360	0.67660	-2.0000	0.0930	0.69660	103 A	3AERO	29
	-2.0000	0.0472	0.70890	-2.0000	0.0000	0.71300	103 A	3AERO	30
	-3.0000	0.3530	0.39581	-3.0000	0.3476	0.45710	103 A	3AERO	31
	-3.0000	0.3317	0.51660	-3.0000	0.3057	0.57230	103 A	3AERO	32
	-3.0000	0.2704	0.62280	-3.0000	0.2269	0.66630	103 A	3AERO	33
	-3.0000	0.1745	0.70160	-3.0000	0.1207	0.72760	103 A	3AERO	34
	-3.0000	0.0613	0.74350	-3.0000	0.0000	0.74880	103 A	3AERO	35
	-4.0000	0.4280	0.35101	-4.0000	0.4215	0.42330	103 A	3AERO	36
	-4.0000	0.4022	0.49740	-4.0000	0.3707	0.56500	103 A	3AERO	37
	-4.0000	0.3279	0.62610	-4.0000	0.2751	0.67890	103 A	3AERO	38
	-4.0000	0.2140	0.72170	-4.0000	0.1464	0.75320	103 A	3AERO	39
	-4.0000	0.0743	0.77250	-4.0000	0.0000	0.77900	103 A	3AERO	40
	-6.0000	0.5580	0.26101	-6.0000	0.5495	0.55790	103 A	3AERO	41
	-6.0000	0.5243	0.45180	-6.0000	0.4832	0.54000	103 A	3AERO	42

Reading in Geometry Data
Type 3 cards
(PANEL)

SAMPLE PROBLEM #6 (continued)

0	1	2	3	4	5	6	7	8
1234567890123456789012345678901234567890123456789012345678901234567890	1234567890123456789012345678901234567890123456789012345678901234567890	1234567890123456789012345678901234567890123456789012345678901234567890	1234567890123456789012345678901234567890123456789012345678901234567890	1234567890123456789012345678901234567890123456789012345678901234567890	1234567890123456789012345678901234567890123456789012345678901234567890	1234567890123456789012345678901234567890123456789012345678901234567890	1234567890123456789012345678901234567890123456789012345678901234567890	1234567890123456789012345678901234567890123456789012345678901234567890
-6.0000	0.4275	0.61970	-6.0000	0.3587	0.68850	103 A 3AERD	43	
-6.0000	0.2790	0.74420	-6.0000	0.1908	0.78530	103 A 3AERD	44	
-6.0000	0.0969	0.81050	-6.0000	0.0000	0.81900	103 A 3AERD	45	
-6.5000	0.5850	0.23821	-6.5000	0.5761	0.53980	103 A 3AERD	46	
-6.5000	0.5497	0.43830	-6.5000	0.5066	0.53070	103 A 3AERD	47	
-6.5000	0.4481	0.61020	-6.5000	0.3760	0.68630	103 A 3AERD	48	
-6.5000	0.2925	0.74480	-6.5000	0.2001	0.78790	103 A 3AERD	49	
-6.5000	0.1016	0.81430	-6.5000	0.0000	0.82320	103 A 3AERD	50	
-7.0500	0.6100	0.21341	-7.0500	0.6007	0.51930	103 A 3AERD	51	
-7.0500	0.5732	0.42200	-7.0500	0.5283	0.51840	103 A 3AERD	52	
-7.0500	0.4673	0.60550	-7.0500	0.3921	0.68070	103 A 3AERD	53	
-7.0500	0.3050	0.74170	-7.0500	0.2086	0.78660	103 A 3AERD	54	
-7.0500	0.1059	0.81410	-7.0500	0.0000	0.82340	103 A 3AERD	55	
-7.5000	0.6180	0.19311	-7.5000	0.6086	0.50040	103 A 3AERD	56	
-7.5000	0.5807	0.40450	-7.5000	0.5352	0.50210	103 A 3AERD	57	
-7.5000	0.4734	0.59040	-7.5000	0.5972	0.66650	103 A 3AERD	58	
-7.5000	0.3090	0.72830	-7.5000	0.2114	0.77390	103 A 3AERD	59	
-7.5000	0.1073	0.80170	-7.5000	0.0000	0.81110	103 A 3AERD	60	
-8.0000	0.6200	0.17061	-8.0000	0.6106	0.27830	103 A 3AERD	61	
-8.0000	0.5826	0.38270	-8.0000	0.5369	0.48060	103 A 3AERD	62	
-8.0000	0.4749	0.56910	-8.0000	0.3985	0.64550	103 A 3AERD	63	
-8.0000	0.3100	0.70750	-8.0000	0.2121	0.75320	103 A 3AERD	64	
-8.0000	0.1077	0.78120	-8.0000	0.0000	0.79060	103 A 3AERD	65	
-9.3639	0.6200	0.15121	-9.3639	0.6106	0.25890	103 A 3AERD	66	
-9.3639	0.5826	0.36330	-9.3639	0.5369	0.46120	103 A 3AERD	67	
-9.3639	0.4749	0.54970	-9.3639	0.3985	0.62620	103 A 3AERD	68	
-9.3639	0.3100	0.68810	-9.3639	0.2121	0.73380	103 A 3AERD	69	
-9.3639	0.1077	0.76180	-9.3639	0.0000	0.77120	103 A 3AERD	70	
-10.6000	0.6200	0.13461	-10.6000	0.6106	0.24230	103 A 3AERD	71	
-10.6000	0.5826	0.34670	-10.6000	0.5369	0.44460	103 A 3AERD	72	
-10.6000	0.4749	0.53310	-10.6000	0.3985	0.60950	103 A 3AERD	73	
-10.6000	0.3100	0.67150	-10.6000	0.2121	0.71720	103 A 3AERD	74	
-10.6000	0.1077	0.74520	-10.6000	0.0000	0.75460	103 A 3AERD	75	
-12.0000	0.6200	0.11471	-12.0000	0.6106	0.22240	103 A 3AERD	76	
-12.0000	0.5826	0.32680	-12.0000	0.5369	0.42470	103 A 3AERD	77	
-12.0000	0.4749	0.51320	-12.0000	0.3985	0.58960	103 A 3AERD	78	
-12.0000	0.3100	0.65160	-12.0000	0.2121	0.69730	103 A 3AERD	79	
-12.0000	0.1077	0.72530	-12.0000	0.0000	0.73470	103 A 3AERD	80	
-14.0000	0.6200	0.08641	-14.0000	0.6106	0.19410	103 A 3AERD	81	
-14.0000	0.5826	0.29850	-14.0000	0.5369	0.39640	103 A 3AERD	82	
-14.0000	0.4749	0.48490	-14.0000	0.3985	0.56130	103 A 3AERD	83	

(PANEL 1 cont)

SAMPLE PROBLEM #6 (continued)

0	1	2	3	4	5	6	7	8
1234567890123456789012345678901234567890123456789012345678901234567890	103 A 3AERO	103 A 3AERO	103 A 3AERO	103 A 3AERO	103 A 3AERO	103 A 3AERO	103 A 3AERO	103 A 3AERO
-14.0000	0.3100	0.62330	-14.0000	0.2121	0.66900	103 A 3AERO	84	
-14.0000	0.1077	0.69700	-14.0000	0.0000	0.70640	103 A 3AERO	85	
-15.4000	0.6200	0.06661	-15.4000	0.6106	0.17430	103 A 3AERO	86	
-15.4000	0.5826	0.27870	-15.4000	0.5369	0.57660	103 A 3AERO	87	
-15.4000	0.4749	0.46510	-15.4000	0.3985	0.54150	103 A 3AERO	88	
-15.4000	0.3100	0.60350	-15.4000	0.2121	0.64920	103 A 3AERO	89	
-15.4000	0.1077	0.67720	-15.4000	0.0000	0.68660	103 A 3AERO	90	
-17.1000	0.6200	0.04251	-17.1000	0.6106	0.15020	103 A 3AERO	91	
-17.1000	0.5826	0.25460	-17.1000	0.5369	0.55250	103 A 3AERO	92	
-17.1000	0.4749	0.44100	-17.1000	0.3985	0.51740	103 A 3AERO	93	
-17.1000	0.3100	0.57940	-17.1000	0.2121	0.62510	103 A 3AERO	94	
-17.1000	0.1077	0.65310	-17.1000	0.0000	0.66250	103 A 3AERO	95	
-18.2000	0.6200	0.02701	-18.2000	0.6106	0.13470	103 A 3AERO	96	
-18.2000	0.5826	0.23910	-18.2000	0.5369	0.33700	103 A 3AERO	97	
-18.2000	0.4749	0.42550	-18.2000	0.3985	0.50190	103 A 3AERO	98	
-18.2000	0.3100	0.56390	-18.2000	0.2121	0.60900	103 A 3AERO	99	
-18.2000	0.1077	0.63760	-18.2000	0.0000	0.64700	103 A 3AERO	100	
-19.0000	0.5950	0.01421	-19.0000	0.5860	0.11750	103 A 3AERO	101	
-19.0000	0.5591	0.21770	-19.0000	0.5153	0.31170	103 A 3AERO	102	
-19.0000	0.4558	0.39670	-19.0000	0.3825	0.47000	103 A 3AERO	103	
-19.0000	0.2975	0.52950	-19.0000	0.2035	0.57330	103 A 3AERO	104	
-19.0000	0.1033	0.60020	-19.0000	0.0000	0.60920	103 A 3AERO	105	
-20.0000	0.5200	0.00001	-20.0000	0.5121	0.09030	103 A 3AERO	106	
-20.0000	0.4886	0.17790	-20.0000	0.4503	0.26000	103 A 3AERO	107	
-20.0000	0.3483	0.33420	-20.0000	0.3342	0.39830	103 A 3AERO	108	
-20.0000	0.2600	0.45030	-20.0000	0.1779	0.48860	103 A 3AERO	109	
-20.0000	0.0903	0.51210	-20.0000	0.0000	0.52000	103 A 3AERO	110	
-0.0500	0.0	0.47482	-0.0500	0.0094	0.47560	103 B 3AERO	6	
-0.0500	0.0185	0.47810	-0.0500	0.0270	0.48200	103 B 3AERO	7	
-0.0500	0.0347	0.48740	-0.0500	0.0414	0.49410	103 B 3AERO	8	
-0.0500	0.0468	0.50180	-0.0500	0.0507	0.51030	103 B 3AERO	9	
-0.0500	0.0532	0.51940	-0.0500	0.0540	0.52880	103 B 3AERO	10	
-0.2500	0.0	0.43001	-0.2500	0.0156	0.43140	103 B 3AERO	11	
-0.2500	0.0308	0.43540	-0.2500	0.0450	0.44210	103 B 3AERO	12	
-0.2500	0.0579	0.45110	-0.2500	0.0689	0.46210	103 B 3AERO	13	
-0.2500	0.0779	0.47500	-0.2500	0.0846	0.48920	103 B 3AERO	14	
-0.2500	0.0886	0.50440	-0.2500	0.0900	0.52000	103 B 3AERO	15	
-0.5000	0.0	0.38901	-0.5000	0.0208	0.39080	103 B 3AERO	16	
-0.5000	0.0410	0.39620	-0.5000	0.0600	0.40510	103 B 3AERO	17	
-0.5000	0.0771	0.41710	-0.5000	0.0919	0.43190	103 B 3AERO	18	
-0.5000	0.1039	0.44900	-0.5000	0.1128	0.46800	103 B 3AERO	19	

(PANEL 1 cont.)

SAMPLE PROBLEM #6 (continued)

0	1	2	3	4	5	6	7	8
123456789012345678901234567890123456789012345678901234567890								
-0.5000	0.1182	0.48820	-0.5000	0.1200	0.50900	103 B 3AERO	20	
-1.0000	0.0	0.30601	-1.0000	0.0313	0.30870	103 B 3AERO	21	
-1.0000	0.0616	0.31690	-1.0000	0.0900	0.33010	103 B 3AERO	22	
-1.0000	0.1157	0.30810	-1.0000	0.1379	0.37030	103 B 3AERO	23	
-1.0000	0.1559	0.39600	-1.0000	0.1691	0.42400	103 B 3AERO	24	
-1.0000	0.1773	0.45470	-1.0000	0.1800	0.48600	103 B 3AERO	25	
-2.0000	0.0	0.16901	-2.0000	0.0472	0.17310	103 B 3AERO	26	
-2.0000	0.0930	0.18540	-2.0000	0.1360	0.20540	103 B 3AERO	27	
-2.0000	0.1748	0.23260	-2.0000	0.2084	0.26620	103 B 3AERO	28	
-2.0000	0.2356	0.30500	-2.0000	0.2556	0.34800	103 B 3AERO	29	
-2.0000	0.2679	0.39380	-2.0000	0.2720	0.44100	103 B 3AERO	30	
-3.0000	0.0	0.04291	-3.0000	0.0613	0.04820	103 B 3AERO	31	
-3.0000	0.1207	0.06410	-3.0000	0.1765	0.09010	103 B 3AERO	32	
-3.0000	0.2269	0.12540	-3.0000	0.2704	0.16890	103 B 3AERO	33	
-3.0000	0.3057	0.21930	-3.0000	0.3317	0.27510	103 B 3AERO	34	
-3.0000	0.3476	0.33460	-3.0000	0.3530	0.39580	103 B 3AERO	35	
-4.0000	0.0	0.07701	-4.0000	0.0743	-0.07050	103 B 3AERO	36	
-4.0000	0.1464	-0.05120	-4.0000	0.2140	-0.01970	103 B 3AERO	37	
-4.0000	0.2751	0.02310	-4.0000	0.3279	0.07590	103 B 3AERO	38	
-4.0000	0.3707	0.13700	-4.0000	0.4022	0.20460	103 B 3AERO	39	
-4.0000	0.4215	0.27670	-4.0000	0.4280	0.35100	103 B 3AERO	40	
-6.0000	0.0	0.29701	-6.0000	0.0969	-0.28850	103 B 3AERO	41	
-6.0000	0.1908	0.26330	-6.0000	0.2790	-0.22220	103 B 3AERO	42	
-6.0000	0.3587	0.16650	-6.0000	0.4275	-0.09770	103 B 3AERO	43	
-6.0000	0.4832	0.01800	-6.0000	0.5243	0.07020	103 B 3AERO	44	
-6.0000	0.5495	0.16410	-6.0000	0.5580	0.26100	103 B 3AERO	45	
-6.5000	0.0	0.34681	-6.5000	0.1016	-0.33790	103 B 3AERO	46	
-6.5000	0.2001	0.31150	-6.5000	0.2925	-0.26840	103 B 3AERO	47	
-6.5000	0.3760	0.21000	-6.5000	0.4481	-0.13790	103 B 3AERO	48	
-6.5000	0.5066	0.05430	-6.5000	0.5497	0.03810	103 B 3AERO	49	
-6.5000	0.5761	0.13660	-6.5000	0.5850	0.23820	103 B 3AERO	50	
-7.0500	0.0	0.39661	-7.0500	0.1059	-0.38730	103 B 3AERO	51	
-7.0500	0.2086	0.35980	-7.0500	0.3050	-0.31490	103 B 3AERO	52	
-7.0500	0.3921	0.25390	-7.0500	0.4673	-0.17870	103 B 3AERO	53	
-7.0500	0.5283	0.09160	-7.0500	0.5732	0.00480	103 B 3AERO	54	
-7.0500	0.6007	0.10750	-7.0500	0.6100	0.21340	103 B 3AERO	55	
-8.0	.254552	.396602 1-8.0		.254552	.396602 0	103 B 3		
-8.0	.254552	.396602 0	-8.0000	0.3100	-0.36630	103 B 3AERO	57	
-8.0000	0.3985	-0.30430	-8.0000	0.4749	-0.27790	103 B 3AERO	58	
-8.0000	0.5369	-0.13940	-8.0000	0.5826	-0.04150	103 B 3AERO	59	
-8.0000	0.6106	0.06290	-8.0000	0.6200	0.17060	103 B 3AERO	60	

(PANEL 1 cont.)

SAMPLE PROBLEM #6 (continued)

0	1	2	3	4	5	6	7	8
123456789012345678901234567890123456789012345678901234567890								
-8.0000	.254552	-.396602	2	-8.0000	0.3100	-0.36630	103 B	3AERD 57
-8.0000	0.3985	-0.30430		-8.0000	0.4749	-0.22790	103 B	3AERD 58
-8.0000	0.5369	-0.13940		-8.0000	0.5426	-0.04150	103 B	3AERD 59
-8.0000	0.6106	0.06290		-8.0000	0.6200	0.17060	103 B	3AERD 60
8.5	.368	-.34	1-8.5		.368	-.340	103 B	3
-8.5000	0.3985	-0.31150		-8.5000	0.4749	-0.23500	103 B	3AERD 63
-8.5000	0.5369	-0.14650		-8.5000	0.5426	-0.04860	103 B	3AERD 64
-8.5000	0.6106	0.05580		-8.5000	0.6200	0.16350	103 B	3AERD 65
-8.5000	.368	-.340	2	-8.5000	0.4749	-0.23500	103 B	3AERD 63
-8.5000	0.5369	-0.14650		-8.5000	0.5426	-0.04860	103 B	3AERD 64
-8.5000	0.6106	0.05580		-8.5000	0.6200	0.16350	103 B	3AERD 65
-9.3639	.497	-.23	1-9.3639		.497	-.23	103 B	3
-9.3639	0.5369	-0.15880		-9.3639	0.5826	-0.06080	103 B	3AERD 69
-9.3639	0.6106	0.04350		-9.3639	0.6200	0.15120	103 B	3AERD 70
-9.3639	.497	-.23	2-9.3639		.5369	-.1588	103 B	3
-9.3639	.5826	-.0608	0-9.3639		.6106	.0435	103 B	3
-9.3639	.620	.1512	0-10.2		.590	-.065	103 B	3
-10.2	.590	-.065	0-10.2		.590	-.065	103 B	3
-10.2000	0.6106	0.03170	-10.2000		0.6200	0.13930	103 B	3AERD 75
-10.2	.59	-.065	2-10.2		.6106	.03170	103 B	3AERD
-10.2	.62	.13930	0-10.8		.620	.130793	103 B	3AERD
-10.8	.62	.130793	0-10.8		.62	.130793	103 B	3AERD
-1.000000	0.000000	0.000000	-1.000000		0.000000	0.000000	Z	332B 3001
-1.000001	0.000000	0.000000	-1.000001		0.000001	0.000000	Z	332B 3002
0.02001	00							
0.1000								
-7.05	0.0	-.396602	2-7.05		0.0	-0.396602	103 M	3AERD 400
-8.0	0.254552	.448884	1-8.0		0.254552	-0.396602	103 M	3AERD 401
-8.5	0.368	.4764	1-8.5		0.368	-0.34	103 M	3AERD 402
-9.363872	0.497	.523942	1-9.363872		0.497	-0.23	103 M	3AERD 403
-10.2	0.590	.569957	1-10.2		0.590	-0.065	103 M	3AERD 404
-10.8	0.62	.6029771	1-10.8		0.62	0.130793	103 M	3AERD 405
-12.0	0.62	.669017	1-12.0		0.62	0.1147	103 M	3AERD 406
-14.0	0.62	.779084	1-14.0		0.62	0.0864	103 M	3AERD 407
-15.031624	0.62	.838000	1-15.031624		0.62	0.070634	103 M	3AERD 408
-16.0	0.62	.889150	1-16.0		0.62	0.056867	103 M	3AERD 409
-16.0	0.62	-.0.89	2-16.0		0.62	-0.89	103 M	3AERD 413
-16.0	0.62	-.0.89	0-16.0		0.62	-0.89	103 M	3AERD 414
-16.0	0.62	-.0.75	0-16.0		0.62	-0.52	103 M	3AERD 415
-16.0	0.62	-.0.36	0-16.0		0.62	-0.23	103 M	3AERD 416
-16.0	0.62	-.0.11	0-16.0		0.62	+0.056867	103 M	3AERD 417

(PANEL 1 cont.)

Reading in Geometry Data
Type 3 cards
(PANEL 2)

SAMPLE PROBLEM #6 (continued)

1	2	3	4	5	6	7	8
0	1234567890123456789012345678901234567890123456789012345678901234567890						
-17.1	0.31	0.955	1-17.1	0.432	-0.830	0	103 M 3AERO 418
-17.1	0.47	0.790	0-17.1	0.495	-0.755	0	103 M 3AERO 419
-17.1	0.555	-0.670	0-17.1	0.608	-0.51	0	103 M 3AERO 420
-17.1	0.62	-0.36	0-17.1	0.62	-0.23	0	103 M 3AERO 421
-17.1	0.67	-0.11	0-17.1	0.62	+0.0425	0	103 M 3AERO 422
-17.86	0.0	-0.991512	1-17.86	0.125	-0.735	0	103 M 3AERO 423
-17.86	0.230	-0.64	0-17.86	0.325	-0.565	0	103 M 3A5RO 424
-17.86	0.415	-0.500	0-17.86	0.490	-0.410	0	103 M 3AERO 425
-17.86	0.55	-0.320	0-17.86	0.595	-0.220	0	103 M 3AERO 426
-17.86	0.615	-0.11	0-17.86	0.620	+0.030424	0	103 M 3AERO 427
-1.0000000	0.0000000	0.0000000	1.0000000	0.0000000	0.0000000	0	Z 332H 3001
-1.0000001	0.0000000	0.0000000	1.0000001	0.0000001	0.0000000	0	Z 332H 3002
01000	00						
-7.05	0.0	0.396602	2-7.05	0.0	-0.596602	0	103 K 3AERO1100
-8.0	0.0	0.48884	1-8.0	0.254552	-0.48884	0	103 K 3AERO1101
-8.5	0.0	0.476400	1-8.5	0.368	-0.476400	0	103 K 3AERO1102
-9.363872	0.0	-0.523942	1-9.363872	0.497	-0.523942	0	103 K 3AERO1103
-10.2	0.0	-0.569957	1-10.2	0.59	-0.569957	0	103 K 3AERO1104
-10.8	0.0	-0.602977	1-10.8	0.62	-0.602977	0	103 K 3AERO1105
-12.0	0.0	-0.669017	1-12.0	0.62	-0.669017	0	103 K 3AERO1106
-14.0	0.0	-0.779084	1-14.0	0.62	-0.779084	0	103 K 3AERO1107
-16.0	0.0	-0.89150	1-16.0	0.62	-0.89150	0	103 K 3AERO1108
-17.1	0.0	-0.949687	1-17.1	0.31	-0.949687	0	103 K 3AERO1109
-17.86	0.0	-0.991512	1-17.86	0.0	-0.991512	0	103 K 3AERO1110
-1.0000000	0.0000000	0.0000000	1.0000000	0.0000000	0.0000000	0	Z 332H 3001
-1.0000001	0.0000000	0.0000000	1.0000001	0.0000001	0.0000000	0	Z 332H 3002
01000	00						
-17.86	0.0	-0.991512	2-17.86	0.125	-0.735	0	103MM 3AERO 423
-17.86	0.230	-0.64	0-17.86	0.325	-0.565	0	103MM 3A5RO 424
-17.86	0.415	-0.500	0-17.86	0.490	-0.410	0	103MM 3AERO 425
-17.86	0.55	-0.320	0-17.86	0.595	-0.220	0	103MM 3AERO 426
-17.86	0.615	-0.11	0-17.86	0.620	+0.030424	0	103MM 3AERO 427
-18.2	0.0	-0.9	1-18.2	0.11	-0.65	0	103MM 3AERO 428
-18.2	0.205	-0.575	0-18.2	0.30	-0.52	0	103MM 3AERO 429
-18.2	0.383	-0.460	0-18.2	0.460	-0.39	0	103MM 3AERO 430
-18.2	0.525	-0.305	0-18.2	0.570	-0.205	0	103MM 3AERO 431
-18.2	0.605	-0.102	0-18.2	0.62	+0.027	0	103MM 3AERO 432
-19.0	0.0	-0.70	1-19.0	0.10	-0.59	0	103MM 3AERO 433
-19.0	0.20	-0.55	0-19.0	0.292	-0.505	0	103MM 3AERO 434

(PANEL 2 cont.)

Reading in Geometry Data
Type 3 Cards
(PANEL 3)

Reading in Geometry Data
Type 3 cards
(PANEL 4)

SAMPLE PROBLEM #6 (continued)

0	1	2	3	4	5	6	7	8
1234567890123456789012345678901234567890123456789012345678901234567890								
-19.0	0.375	-0.45	0-19.0	0.450	-0.38	0	103MM	3AERU 435
-19.0	0.510	-0.295	0-19.0	0.560	-0.202	0	103MM	3AERU 436
-19.0	0.583	-0.10	0-19.0	0.595	+0.014217	0	103MM	3AERU 437
-20.0	0.0	-0.52	1-20.0	0.09	-0.51	0	103MM	3AERU 438
-20.0	0.175	-0.485	0-20.0	0.260	-0.45	0	103MM	3AERU 439
-20.0	0.335	-0.595	0-20.0	0.395	-0.335	0	103MM	3AERU 440
-20.0	0.450	-0.26	0-20.0	0.485	-0.175	0	103MM	3AERU 441
-20.0	0.510	-0.09	0-20.0	0.52	0.0	0	103MM	3AERU 442
-1.0000000	0.0000000	0.0000000	-1.0000000	0.0000001	0.0000000	0	Z	332B 3001
-1.0000001	0.0000000	0.0000001	-1.0000001	0.0000001	0.0000000	0	Z	332B 3002
005001	00							
01000								
0.2500	0.0	0.54202	0.2500	0.0	0.54200	0	103 I	3AERU 1
0.2500	0.0	0.54200	0.2500	0.0	0.54200	0	103 I	3AERU 2
0.2500	0.0	0.54200	0.2500	0.0	0.54200	0	103 I	3AERU 3
0.2500	0.0	0.54200	0.2500	0.0	0.54200	0	103 I	3AERU 4
0.2500	0.0	0.54200	0.2500	0.0	0.54200	0	103 I	3AERU 5
-0.0500	0.0540	0.52881	-0.0500	0.0532	0.53820	0	103 I	3AERU 6
-0.0500	0.0507	0.54730	-0.0500	0.0468	0.55580	0	103 I	3AERU 7
-0.0500	0.0414	0.56350	-0.0500	0.0347	0.57020	0	103 I	3AERU 8
-0.0500	0.0270	0.57560	-0.0500	0.0185	0.57950	0	103 I	3AERU 9
-0.0500	0.0094	0.58200	-0.0500	0.0000	0.58280	0	103 I	3AERU 10
0.2500	0.0	0.54202	0.2500	0.0	0.54200	0	103 I	3AERU 1
0.2500	0.0	0.54200	0.2500	0.0	0.54200	0	103 I	3AERU 2
0.2500	0.0	0.54200	0.2500	0.0	0.54200	0	103 I	3AERU 3
0.2500	0.0	0.54200	0.2500	0.0	0.54200	0	103 I	3AERU 4
0.2500	0.0	0.54200	0.2500	0.0	0.54200	0	103 I	3AERU 5
-0.0500	0.0	0.47481	-0.0500	0.0094	0.47560	0	103 I	3AERU 6
-0.0500	0.0185	0.47810	-0.0500	0.0270	0.48200	0	103 I	3AERU 7
-0.0500	0.0347	0.48740	-0.0500	0.0414	0.49410	0	103 I	3AERU 8
-0.0500	0.0468	0.50180	-0.0500	0.0507	0.51030	0	103 I	3AERU 9
-0.0500	0.0532	0.51940	-0.0500	0.0540	0.52880	0	103 I	3AERU 10
-1.0000000	0.0000000	0.0000000	-1.0000000	0.0000001	0.0000000	0	Z	332B 3001
-1.0000001	0.0000000	0.0000001	-1.0000001	0.0000001	0.0000000	0	Z	332B 3002
006001	00							
01000								
0.0	0.0	0.53102	0.0	0.0	0.53100	0	103 J	3AERU 1
0.0	0.0	0.53100	0.0	0.0	0.53100	0	103 J	3AERU 2
0.0	0.0	0.53100	0.0	0.0	0.53100	0	103 J	3AERU 3
0.0	0.0	0.53100	0.0	0.0	0.53100	0	103 J	3AERU 4
0.0	0.0	0.53100	0.0	0.0	0.53100	0	103 J	3AERU 5

(PANEL 4 cont.)

Reading in Geometry Data
Type 3 cards
(PANEL 5)

Reading in Geometry Data
Type 3 cards
PANEL 6

SAMPLE PROBLEM #6 (continued)

0	1	2	3	4	5	6	7	8
1234567890123456789012345678901234567890123456789012345678901234567890	0.0	0.0	0.53100	0.0	0.0	0.53100	103 J 3AERU	6
	0.0	0.0	0.53100	0.0	0.0	0.53100	103 J 3AERU	7
	0.0	0.0	0.53100	0.0	0.0	0.53100	103 J 3AERU	8
	0.0	0.0	0.53100	0.0	0.0	0.53100	103 J 3AERU	9
	0.0	0.0	0.53100	0.0	0.0	0.53100	103 J 3AERU	10
	0.0050	0.0078	0.50940	-0.0050	0.0147	0.51330	103 J 3AERU	11
	-0.0050	0.0197	0.51940	-0.0050	0.0225	0.52680	103 J 3AERU	12
	-0.0050	0.0225	0.53480	-0.0050	0.0197	0.54220	103 J 3AERU	13
	-0.0050	0.0147	0.54830	-0.0050	0.0078	0.55220	103 J 3AERU	14
	-0.0050	0.0000	0.55360	-0.0050	-0.0078	0.55220	103 J 3AERU	15
	-0.0050	-0.0147	0.54830	-0.0050	-0.0197	0.54220	103 J 3AERU	16
	-0.0050	-0.0225	0.53480	-0.0050	-0.0225	0.52680	103 J 3AERU	17
	-0.0050	-0.0197	0.51940	-0.0050	-0.0147	0.51330	103 J 3AERU	18
	-0.0050	-0.0078	0.50940	-0.0050	-0.0000	0.50900	103 J 3AERU	19
	-0.0200	0.0	0.48821	-0.0200	0.0144	0.49070	103 J 3AERU	20
	-0.0200	0.0270	0.49800	-0.0200	0.0364	0.50920	103 J 3AERU	21
	-0.0200	0.0414	0.52290	-0.0200	0.0414	0.53750	103 J 3AERU	22
	-0.0200	0.0364	0.55120	-0.0200	0.0270	0.56230	103 J 3AERU	23
	-0.0200	0.0144	0.56960	-0.0200	0.0000	0.57220	103 J 3AERU	24
	-0.0200	0.0144	0.56960	-0.0200	-0.0270	0.56230	103 J 3AERU	25
	-0.0200	0.0364	0.55120	-0.0200	-0.0414	0.53750	103 J 3AERU	26
	-0.0200	-0.0414	0.52290	-0.0200	-0.0364	0.50920	103 J 3AERU	27
	-0.0200	-0.0270	0.49800	-0.0200	-0.0144	0.49070	103 J 3AERU	28
	-0.0200	-0.0000	0.48820	-0.0400	0.0	0.47711	103 J 3AERU	29
	-0.0400	0.0179	0.48820	-0.0400	0.0336	0.48930	103 J 3AERU	30
	-0.0400	0.0452	0.50320	-0.0400	0.0515	0.52030	103 J 3AERU	31
	-0.0400	0.0515	0.53840	-0.0400	0.0452	0.55550	103 J 3AERU	32
	-0.0400	0.0336	0.56940	-0.0400	0.0179	0.57840	103 J 3AERU	33
	-0.0400	0.0000	0.58160	-0.0400	-0.0179	0.57840	103 J 3AERU	34
	-0.0400	-0.0336	0.56940	-0.0400	-0.0452	0.55550	103 J 3AERU	35
	-0.0400	-0.0515	0.53840	-0.0400	-0.0515	0.52030	103 J 3AERU	36
	-0.0400	-0.0452	0.50320	-0.0400	-0.0336	0.48930	103 J 3AERU	37
	-0.0400	-0.0179	0.48820	-0.0400	-0.0000	0.47710	103 J 3AERU	38
	-0.0500	0.0	0.47481	-0.0500	0.0185	0.47810	103 J 3AERU	39
	-0.0500	0.0347	0.48740	-0.0500	0.0468	0.50180	103 J 3AERU	40
	-0.0500	0.0532	0.51940	-0.0500	0.0532	0.54820	103 J 3AERU	41
	-0.0500	0.0468	0.55580	-0.0500	0.0347	0.57020	103 J 3AERU	42
	-0.0500	0.0185	0.57950	-0.0500	0.0000	0.58280	103 J 3AERU	43
	-0.0500	-0.0185	0.57950	-0.0500	-0.0347	0.57020	103 J 3AERU	44
	-0.0500	-0.0468	0.55580	-0.0500	-0.0532	0.53820	103 J 3AERU	45
	-0.0500	-0.0532	0.51940	-0.0500	-0.0468	0.50180	103 J 3AERU	46

(PANEL 6 cont.)

SAMPLE PROBLEM #6 (continued)

0	1	2	3	4	5	6	7	8
1234567890123456789012345678901234567890123456789012345678901234567890								
-0.0500	-0.0347	0.48740	-0.0500	0.0185	0.47810	103 J	3AERO	47
-0.0500	0.0000	0.47480	-0.0500	0.0	0.47481	103 J	3AERO	48
-0.0500	0.0185	0.47810	-0.0500	0.0347	0.48740	103 J	3AERO	49
-1.0000000	0.0000000	0.0000000	-1.0000000	0.0000001	0.0000000	Z	332B	3001
-1.0000001	0.0000000	0.0000000	-1.0000001	0.0000001	0.0000000	Z	332B	3002
0007001	00							
01000								
-7.05	0.0	0.586602	2-7.05	0.0	-0.396602	103 D	3AERO	400
-8.0	0.254552	-0.638821	1-8.0	0.254552	-0.396602	103 D	3AERO	401
-8.5	0.368	-0.677675	1-8.5	0.368	-0.34	103 D	3AERO	402
-9.563872	0.497	-0.709600	1-9.563872	0.497	-0.23	103 D	3AERO	403
-10.2	0.590	-0.732616	1-10.2	0.590	-0.065	103 D	3AERO	404
-10.80	0.62	-0.740041	1-10.80	0.62	0.150793	103 D	3AERO	405
-12.0	0.62	-0.743669	1-12.0	0.62	0.1147	103 D	3AERO	406
-14.0	0.62	-0.766359	1-14.0	0.62	0.0864	103 D	3AERO	407
-15.031624	0.62	-0.778063	1-15.031624	0.62	0.070634	103 D	3AERO	408
-16.0	0.62	-0.89	1-16.0	0.62	0.056867	103 D	3AERO	409
-16.0	0.62	-0.89	2-16.0	0.62	-0.89	103 D	3AERO	413
-16.0	0.62	-0.89	0-16.0	0.62	-0.89	103 D	3AERO	414
-16.0	0.62	-0.75	0-16.0	0.62	-0.52	103 D	3AERO	415
-16.0	0.62	-0.56	0-16.0	0.62	-0.23	103 D	3AERO	416
-16.0	0.62	-0.11	0-16.0	0.62	+0.056867	103 D	3AERO	417
-17.1	0.31	-0.955	1-17.1	0.432	-0.830	103 D	3AERO	418
-17.1	0.47	-0.790	0-17.1	0.495	-0.755	103 D	3AERO	419
-17.1	0.555	-0.670	0-17.1	0.608	-0.51	103 D	3AERO	420
-17.1	0.62	-0.56	0-17.1	0.62	-0.23	103 D	3AERO	421
-17.1	0.62	-0.11	0-17.1	0.62	+0.0425	103 D	3AERO	422
-17.86	0.0	-0.991512	1-17.86	0.125	-0.735	103 D	3AERO	423
-17.86	0.230	-0.804	0-17.86	0.325	-0.565	103 D	3AERO	424
-17.86	0.415	-0.500	0-17.86	0.490	-0.410	103 D	3AERO	425
-17.86	0.55	-0.570	0-17.86	0.595	-0.220	103 D	3AERO	426
-17.86	0.615	-0.11	0-17.86	0.620	+0.030424	103 D	3AERO	427
-8.0	0.254552	-0.638821	2-8.0	0.254552	-0.638821	103 D	3AERO	443
-8.423395	0.368	-0.662094	1-8.5	0.368	-0.677675	103 D	3AERO	444
-8.904829	0.497	-0.688557	1-9.363872	0.497	-0.709600	103 D	3AERO	445
-9.251910	0.59	-0.707635	1-10.2	0.59	-0.732616	103 D	3AERO	446
-9.563872	0.62	-0.715790	1-10.8	0.62	-0.740041	103 D	3AERO	447
-1.0000000	0.0000000	0.0000000	-1.0000000	0.0000001	0.0000000	Z	332B	3001
-1.0000001	0.0000000	0.0000001	-1.0000001	0.0000001	0.0000000	Z	332B	3002
0008011	00							
01000								

(PANEL 6 cont.)

Reading in Geometry Data
Type 3 cards
(PANEL 7)

Reading in Geometry Data
Type 3 cards
(PANEL 8)

SAMPLE PROBLEM #6 (continued)

0	1	2	3	4	5	6	7	8
123456789012345678901234567890123456789012345678901234567890								
-9.3639	0.6200	-0.71382	-10.2155	0.6200	-0.72490	103	3103	1
-11.0670	0.6200	-0.75600	-11.9186	0.6200	-0.74710	103	3103	2
-12.7702	0.6200	-0.75820	-13.6217	0.6200	-0.76920	103	3103	3
-14.4733	0.6200	-0.78030	-15.0438	0.6200	-0.78780	103	3103	4
-15.3229	0.6200	-0.82670	-16.1686	0.6200	-0.94470	103	3103	5
-17.0143	0.6200	-1.06280	-17.8600	0.6200	-1.18080	103	3103	6
-10.7820	1.0000	-0.79171	-11.4914	1.0000	-0.80100	103	3103	7
-12.2009	1.0000	-0.81020	-12.9103	1.0000	-0.81950	103	3103	8
-13.6197	1.0000	-0.82870	-14.3291	1.0000	-0.83790	103	3103	9
-15.0386	1.0000	-0.84720	-15.7479	1.0000	-0.85340	103	3103	10
-15.7464	1.0000	-0.88580	-16.4509	1.0000	-0.98410	103	3103	11
-17.1554	1.0000	-1.06250	-17.8600	1.0000	-1.18080	103	3103	12
-1.000000	0.000000	0.000000	-1.000000	0.000000	0.000000	Z 332H	3001	
-1.000001	0.000000	0.000000	-1.000001	0.000001	0.000000	Z 332H	3002	
0099011	00							
01000								
-10.7820	1.0000	-0.79172	-11.4914	1.0000	-0.80100	103	3103	7
-12.2009	1.0000	-0.81020	-12.9103	1.0000	-0.81950	103	3103	8
-13.6197	1.0000	-0.82870	-14.3291	1.0000	-0.83790	103	3103	9
-15.0386	1.0000	-0.84720	-15.7479	1.0000	-0.85340	103	3103	10
-15.7464	1.0000	-0.88580	-16.4509	1.0000	-0.98410	103	3103	11
-17.1554	1.0000	-1.06250	-17.8600	1.0000	-1.18080	103	3103	12
-12.6480	1.5000	-0.84431	-13.1704	1.5000	-0.90110	103	3103	13
-13.6928	1.5000	-0.90790	-14.2152	1.5000	-0.91470	103	3103	14
-14.7376	1.5000	-0.92150	-15.2600	1.5000	-0.92830	103	3103	15
-15.7824	1.5000	-0.93510	-16.1324	1.5000	-0.93970	103	3103	16
-16.3036	1.5000	-0.96360	-16.8224	1.5000	-1.03600	103	3103	17
-17.3412	1.5000	-1.10840	-17.8600	1.5000	-1.18080	103	3103	18
-1.000000	0.000000	0.000000	-1.000000	0.000000	0.000000	Z 332H	3001	
-1.000001	0.000000	0.000000	-1.000001	0.000001	0.000000	Z 332H	3002	
0010011	00							
01000								
-12.6480	1.5000	-0.89432	-13.1704	1.5000	-0.90110	103	3103	13
-13.6928	1.5000	-0.90790	-14.2152	1.5000	-0.91470	103	3103	14
-14.7376	1.5000	-0.92150	-15.2600	1.5000	-0.92830	103	3103	15
-15.7824	1.5000	-0.93510	-16.1324	1.5000	-0.93970	103	3103	16
-16.3036	1.5000	-0.96360	-16.8224	1.5000	-1.03600	103	3103	17
-17.3412	1.5000	-1.10840	-17.8600	1.5000	-1.18080	103	3103	18
-14.5140	2.0000	-0.99691	-14.8494	2.0000	-1.00120	103	3103	19
-15.1847	2.0000	-1.00560	-15.5201	2.0000	-1.01000	103	3103	20
-15.8555	2.0000	-1.01440	-16.1908	2.0000	-1.01870	103	3103	21

(PANEL 8 cont.)

Reading in Geometry Data
Type 3 cards
(PANEL 9)

Reading in Geometry Data
Type 3 cards
(PANEL 10)

Contrails

SAMPLE PROBLEM #6 (continued)

0	1	2	3	4	5	6	7	8
12345678901234567890123456789012345678901234567890								
-16,5262	2,0000	-1,02310	-16,7509	2,0000	-1,02600	103	3103	22
-16,8608	2,0000	-1,04140	-17,1939	2,0000	-1,08780	103	3103	23
-17,5269	2,0000	-1,13430	-17,8600	2,0000	-1,18080	103	3103	24
-1,000000	0,000000	0,000000	-1,000000	0,000000	0,000000	Z	332R	3001
-1,000001	0,000000	0,000000	-1,000001	0,000001	0,000000	Z	332R	3002
0011011	00							
01000	2,0000	-0,99692	-14,8494	2,0000	-1,00120	103	3103	19
-14,5140	2,0000	-1,00560	-15,5201	2,0000	-1,01000	103	3103	20
-15,1847	2,0000	-1,01440	-16,1908	2,0000	-1,01870	103	3103	21
-15,8555	2,0000	-1,02310	-16,7509	2,0000	-1,02600	103	3103	22
-16,5262	2,0000	-1,04140	-17,1939	2,0000	-1,08780	103	3103	23
-16,8608	2,0000	-1,04140	-17,1939	2,0000	-1,08780	103	3103	24
-17,5269	2,0000	-1,13430	-17,8600	2,0000	-1,18080	103	3103	25
-16,3800	2,5000	-1,09941	-16,5283	2,5000	-1,10130	103	3103	26
-16,6767	2,5000	-1,10330	-16,8250	2,5000	-1,10520	103	3103	27
-16,9733	2,5000	-1,10710	-17,1217	2,5000	-1,10910	103	3103	28
-17,2700	2,5000	-1,11100	-17,3694	2,5000	-1,11230	103	3103	29
-17,4180	2,5000	-1,11490	-17,5653	2,5000	-1,113970	103	3103	30
-17,7126	2,5000	-1,16020	-17,8600	2,5000	-1,18080	103	3103	31
-1,000000	0,000000	0,000000	-1,000000	0,000001	0,000000	Z	332H	3001
-1,000001	0,000000	0,000000	-1,000001	0,000001	0,000000	Z	332H	3002
0012011	00							
01000	2,5000	-1,09942	-16,5283	2,5000	-1,10130	103	3103	25
-16,3800	2,5000	-1,10330	-16,8250	2,5000	-1,10520	103	3103	26
-16,6767	2,5000	-1,10710	-17,1217	2,5000	-1,10910	103	3103	27
-16,9733	2,5000	-1,11100	-17,3694	2,5000	-1,11230	103	3103	28
-17,2700	2,5000	-1,11490	-17,5653	2,5000	-1,113970	103	3103	29
-17,4180	2,5000	-1,16020	-17,8600	2,5000	-1,18080	103	3103	30
-17,7126	2,5000	-1,18081	-17,8601	2,8965	-1,18080	103	3103	31
-17,8600	2,8965	-1,18080	-17,8603	2,8965	-1,18080	103	3103	32
-17,8602	2,8965	-1,18080	-17,8605	2,8965	-1,18080	103	3103	33
-17,8604	2,8965	-1,18080	-17,8607	2,8965	-1,18080	103	3103	34
-17,8606	2,8965	-1,18080	-17,8607	2,8965	-1,18080	103	3103	35
-17,8607	2,8965	-1,18080	-17,8608	2,8965	-1,18080	103	3103	36
-17,8609	2,8965	-1,18080	-17,8610	2,8965	-1,18080	103	3103	36
-1,000000	0,000000	0,000000	-1,000000	0,000001	0,000000	Z	332R	3001
-1,000001	0,000000	0,000000	-1,000001	0,000001	0,000000	Z	332R	3002
0013001	00							
01000	2,5000	-0,92	2-16,0	0,62	-0,89	103	N 3	
-16,0	0,62	-1,08	1-17,1	0,62	-0,955	103	N 3	
-17,10	0,62							

(PANEL 10 cont.)

Reading in Geometry Data
Type 3 cards
(PANEL 11)

Reading in Geometry Data
Type 3 cards
(PANEL 12)

Reading in Geometry Data
Type 3 cards
(PANEL 13)

SAMPLE PROBLEM #6 (continued)

0	1	2	3	4	5	6	7	8
1234567890123456789012345678901234567890123456789012345678901234567890								
-17.86	0.62	-1.181512	1-17.86	0.62	0.62	-0.991512	0	103 N 3
-1.000000	0.000000	0.000000	-1.000000	0.000000	0.000000	0.000000	0	Z 332B 3001
-1.000000	0.000000	0.000000	-1.000000	0.000000	0.000000	0.000000	0	Z 332B 3002
0014001	00							
01000								
-16.0	0.62	-0.89	2-16.0	0.62	0.62	-0.89	0	103 Q 3AERU1700
-17.1	0.62	-0.955	1-17.1	0.31	0.31	-0.955	0	103 Q 3AERU1701
-17.86	0.62	-0.991512	1-17.86	0.0	0.0	-0.991512	0	103 Q 3AERU1702
-1.000000	0.000000	0.000000	-1.000000	0.000000	0.000000	0.000000	0	Z 332B 3001
-1.000000	0.000000	0.000000	-1.000000	0.000000	0.000000	0.000000	0	Z 332B 3002
0015011	00							
01000								
-17.8600	2.8965	-1.18582	-17.8601	2.8965	2.8965	-1.18580	103	3103 43
-17.8602	2.8965	-1.18580	-17.8603	2.8965	2.8965	-1.18580	103	3103 44
-17.8604	2.8965	-1.18580	-17.8605	2.8965	2.8965	-1.18580	103	3103 45
-17.8606	2.8965	-1.18580	-17.8607	2.8965	2.8965	-1.18580	103	3103 46
-17.8607	2.8965	-1.18580	-17.8608	2.8965	2.8965	-1.18580	103	3103 47
-17.8609	2.8965	-1.18580	-17.8610	2.8965	2.8965	-1.18580	103	3103 48
-16.3799	2.5000	-1.10441	-16.5278	2.5000	2.5000	-1.11250	103	3103 49
-16.6758	2.5000	-1.12070	-16.8238	2.5000	2.5000	-1.12880	103	3103 50
-16.9718	2.5000	-1.13700	-17.1198	2.5000	2.5000	-1.14510	103	3103 51
-17.2678	2.5000	-1.15320	-17.5670	2.5000	2.5000	-1.15870	103	3103 52
-17.4158	2.5000	-1.16140	-17.8538	2.5000	2.5000	-1.16950	103	3103 53
-17.7118	2.5000	-1.17770	-17.8598	2.5000	2.5000	-1.18580	103	3103 54
-1.000000	0.000000	0.000000	-1.000000	0.000000	0.000000	0.000000	Z 332B 3001	
-1.000000	0.000000	0.000000	-1.000000	0.000000	0.000000	0.000000	Z 332B 3002	
0016011	00							
01000								
-16.3799	2.5000	-1.10442	-16.5278	2.5000	2.5000	-1.11250	103	3103 49
-16.6758	2.5000	-1.12070	-16.8238	2.5000	2.5000	-1.12880	103	3103 50
-16.9718	2.5000	-1.13700	-17.1198	2.5000	2.5000	-1.14510	103	3103 51
-17.2678	2.5000	-1.15320	-17.5670	2.5000	2.5000	-1.15870	103	3103 52
-17.4158	2.5000	-1.16140	-17.8538	2.5000	2.5000	-1.16950	103	3103 53
-17.7118	2.5000	-1.17770	-17.8598	2.5000	2.5000	-1.18580	103	3103 54
-14.5139	2.0000	-1.00191	-14.8485	2.0000	2.0000	-1.02030	103	3103 55
-15.1831	2.0000	-1.03870	-15.5177	2.0000	2.0000	-1.05710	103	3103 56
-15.8523	2.0000	-1.07540	-16.1868	2.0000	2.0000	-1.09380	103	3103 57
-16.5214	2.0000	-1.11220	-16.7456	2.0000	2.0000	-1.12450	103	3103 58
-16.8560	2.0000	-1.13060	-17.1906	2.0000	2.0000	-1.14900	103	3103 59
-17.5252	2.0000	-1.16740	-17.8598	2.0000	2.0000	-1.18580	103	3103 60
-1.000000	0.000000	0.000000	-1.000000	0.000000	0.000000	0.000000	Z 332B 3001	

(PANEL 13 cont.)

Reading in Geometry Data
Type 3 cards
(PANEL 14)

Reading in Geometry Data
Type 3 cards
(PANEL 15)

Reading in Geometry Data
Type 3 cards
(PANEL 16)

SAMPLE PROBLEM #6 (continued)

0	1	2	3	4	5	6	7	8
123456789012345678901234567890123456789012345678901234567890								
-1.0000001	0.0000000	0.0000000	-1.0000001	0.0000001	0.0000001	0.0000000	Z 332H 3002	(PANEL 16 cont.)
0017011	00							
01000	2.0000	-1.00192	-14.8485	2.0000	-1.02030	103	3103	55
-14.5139	2.0000	-1.03870	-15.5177	2.0000	-1.05710	103	3103	56
-15.1831	2.0000	-1.07540	-16.1868	2.0000	-1.09380	103	3103	57
-15.8523	2.0000	-1.11220	-16.7456	2.0000	-1.12450	103	3103	58
-16.5214	2.0000	-1.13060	-17.1906	2.0000	-1.14900	103	3103	59
-16.8560	2.0000	-1.16740	-17.8598	2.0000	-1.18580	103	3103	60
-17.5252	1.5000	-0.89931	-13.1691	1.5000	-0.92800	103	3103	61
-12.6479	1.5000	-0.95660	-14.2115	1.5000	-0.98530	103	3103	62
-13.6903	1.5000	-1.01390	-15.2539	1.5000	-1.04260	103	3103	63
-14.7327	1.5000	-1.07120	-16.1243	1.5000	-1.09040	103	3103	64
-15.7751	1.5000	-1.09980	-16.8174	1.5000	-1.12850	103	3103	65
-16.2962	1.5000	-1.15710	-17.8598	1.5000	-1.18580	103	3103	66
-17.3386	0.0000000	0.0000002	-1.0000000	0.0000001	0.0000000	Z 332H 3001		
-1.0000001	0.0000000	0.0000001	-1.0000001	0.0000001	0.0000000	Z 332H 3002		
0018011	00							
01000	1.5000	-0.89932	-13.1691	1.5000	-0.92800	103	3103	61
-12.6479	1.5000	-0.95660	-14.2115	1.5000	-0.98530	103	3103	62
-13.6903	1.5000	-1.01390	-15.2539	1.5000	-1.04260	103	3103	63
-14.7327	1.5000	-1.07120	-16.1243	1.5000	-1.09040	103	3103	64
-15.7751	1.5000	-1.09980	-16.8174	1.5000	-1.12850	103	3103	65
-16.2962	1.5000	-1.15710	-17.8598	1.5000	-1.18580	103	3103	66
-17.3386	1.0000	-0.79671	-11.4897	1.0000	-0.83560	103	3103	67
-10.7819	1.0000	-0.87450	-12.9053	1.0000	-0.91350	103	3103	68
-12.1975	1.0000	-0.95240	-14.3209	1.0000	-0.99130	103	3103	69
-13.6131	1.0000	-1.03020	-15.75029	1.0000	-1.05620	103	3103	70
-15.0287	1.0000	-1.06910	-16.4442	1.0000	-1.10800	103	3103	71
-15.7364	1.0000	-1.14690	-17.8598	1.0000	-1.18580	103	3103	72
-17.1520	0.0000000	0.0000002	-1.0000000	0.0000001	0.0000000	Z 332B 3001		
-1.0000000	0.0000000	0.0000001	-1.0000001	0.0000001	0.0000000	Z 332B 3002		
0019011	00							
01000	1.0000	-0.79672	-11.4897	1.0000	-0.83560	103	3103	67
-10.7819	1.0000	-0.87450	-12.9053	1.0000	-0.91350	103	3103	68
-12.1975	1.0000	-0.95240	-14.3209	1.0000	-0.99130	103	3103	69
-13.6131	1.0000	-1.03020	-15.75029	1.0000	-1.05620	103	3103	70
-15.0287	1.0000	-1.06910	-16.4442	1.0000	-1.10800	103	3103	71
-15.7364	1.0000	-1.14690	-17.8598	1.0000	-1.18580	103	3103	72
-17.1520	0.0000000	0.0000002	-1.0000000	0.0000001	0.0000000	Z 332B 3001		
-1.0000001	0.0000000	0.0000001	-1.0000001	0.0000001	0.0000000	Z 332B 3002		
0019011	00							
01000	1.0000	-0.79672	-11.4897	1.0000	-0.83560	103	3103	67
-10.7819	1.0000	-0.87450	-12.9053	1.0000	-0.91350	103	3103	68
-12.1975	1.0000	-0.95240	-14.3209	1.0000	-0.99130	103	3103	69
-13.6131	1.0000	-1.03020	-15.75029	1.0000	-1.05620	103	3103	70
-15.0287	1.0000	-1.06910	-16.4442	1.0000	-1.10800	103	3103	71
-15.7364	1.0000	-1.14690	-17.8598	1.0000	-1.18580	103	3103	72

Reading in Geometry Data
Type 3 cards
(PANEL 17)

Reading in Geometry Data
Type 3 cards
(PANEL 18)

Reading in Geometry Data
Type 3 cards
(PANEL 19)

SAMPLE PROBLEM #6 (continued)

0	1	2	3	4	5	6	7	8
1234567890123456789012345678901234567890123456789012345678901234567890								
-9.3638	0.6200	-0.71881	-10.2134	0.6200	-0.76550	103	3103	73
-11.0630	0.6200	-0.81220	-11.9126	0.6200	-0.85890	103	3103	74
-12.7622	0.6200	-0.90560	-13.6118	0.6200	-0.95230	103	3103	75
-14.4614	0.6200	-0.99900	-15.0306	0.6200	-1.03030	103	3103	76
-15.3110	0.6200	-1.04570	-16.1606	0.6200	-1.09240	103	3103	77
-17.0102	0.6200	-1.13910	-17.8598	0.6200	-1.18580	103	3103	78
-1.0000000	0.0000000	0.0000000	-1.0000000	0.0000001	0.0000000	Z	332H	3001
-1.0000001	0.0000000	0.0000001	-1.0000001	0.0000001	0.0000003	Z	332B	3002
0020011	00							
01000								
-9.3638	0.6200	-0.71882	-10.2134	0.6200	-0.76550	103	3103	73
-11.0630	0.6200	-0.81220	-11.9126	0.6200	-0.85890	103	3103	74
-12.7622	0.6200	-0.90560	-13.6118	0.6200	-0.95230	103	3103	75
-14.4614	0.6200	-0.99900	-15.0306	0.6200	-1.03030	103	3103	76
-15.3110	0.6200	-1.04570	-16.1606	0.6200	-1.09240	103	3103	77
-17.0102	0.6200	-1.13910	-17.8598	0.6200	-1.18580	103	3103	78
-7.0499	0.0	-0.59161	-8.1309	0.0	-0.65100	103	3103	79
-9.2119	0.0	-0.71040	-10.2929	0.0	-0.76990	103	3103	80
-11.3739	0.0	-0.82930	-12.4548	0.0	-0.88870	103	3103	81
-13.5358	0.0	-0.94810	-14.2601	0.0	-0.98790	103	3103	82
-14.6168	0.0	-1.00750	-15.6978	0.0	-1.06700	103	3103	83
-16.7768	0.0	-1.12640	-17.8598	0.0	-1.18580	103	3103	84
-1.0000000	0.0000000	0.0000002	-1.0000000	0.0000001	0.0000000	Z	332H	3001
-1.0000001	0.0000000	0.0000001	-1.0000001	0.0000001	0.0000003	Z	332B	3002
0021001	00							
01000								
-20.0	0.0	0.52	2-20.0	0.0903	.5121	103	3AERO	3
-20.0	.1779	.4886	0-20.0	.260	.4503	103	3AERO	3
-20.0	.3342	.3983	0-20.0	.3983	.3342	103	3AFRO	3
-19.0	0.0	.6092	1-19.0	.1033	.6002	103	3AERO	3
-19.0	.2035	.5733	0-19.0	.2975	.5295	103	3AERO	3
-19.0	.2975	.5295	0-19.0	.2975	.5295	103	3AERO	3
-18.20	0.0	.647	1-18.20	.1077	.6376	103	3AERO	3
-18.20	.2121	.6096	0-18.20	.273	.603	103	3AERO	3
-17.1	0.0	.6625	1-17.1	.1077	.65310	103	3AERO	3
-17.1	.14	.647	0-17.1	.14	.647	103	3AERO	3
-15.4	0.0	.6866	1-15.4	.0085	.685A	103	3AERO	3
-15.40	.017	.685	0-15.23	.0025	.687813	1	103	3AFRO
-15.23	.0025	.687813	0-15.23	.0025	.687813	1	103	3AFRO
-1.0000000	0.0000000	0.0000002	-1.0000000	0.0000001	0.0000000	Z	332H	3001
-1.0000001	0.0000000	0.0000001	-1.0000001	0.0000001	0.0000003	Z	332B	3002

(PANEL 19 cont.)

Reading in Geometry Data
Type 3 cards
(PANEL 20)

Reading in Geometry Data
Type 3 cards
(PANEL 21)

SAMPLE PROBLEM #6 (continued)

0	123456789012345678901234567890123456789012345678901234567890	7	Z 332B 3002	8	
0023001		00			
01000					
-20.012699	.2605	.70	2-20.994195	0.0	2.4
-17.85	.296	.435	1-20.994195	0.0	2.40
-19.86	.1779	.4886	2-20.012699	.2605	.70
-19.89	.0903	.5121	1-20.012699	.1779	.70
-19.90A	0.0	.520	1-20.012699	.0903	.70
-1.000000	0.000000	0.000000	1-20.012699	0.0	.70
-1.000001	0.000000	0.000000	-1.000000	0.000000	0.000000
0024001	00	0.000000	-1.000001	0.000001	0.000000
01000					
-17.86	0.62	-1.181512	2-17.86	0.62	-.991512
-17.86	0.0	-1.181512	1-17.86	0.0	-.991512
-1.000000	0.000000	0.000000	-1.000000	0.000000	0.000000
-1.000001	0.000000	0.000000	-1.000001	0.000001	0.000000
0025011	00	0.000000			
01000					
-7.0403	0.0	-0.58862	-7.0406	0.0	-0.58800
-7.0408	0.0	-0.58780	-7.0413	0.0	-0.58750
-7.0423	0.0	-0.58720	-7.0443	0.0	-0.58680
-7.0462	0.0	-0.58660	-7.0501	0.0	-0.58660
-9.3543	0.6200	-0.71581	-9.3546	0.6200	-0.71520
-9.3548	0.6200	-0.71500	-9.3553	0.6200	-0.71470
-9.3563	0.6200	-0.71440	-9.3582	0.6200	-0.71400
-9.3602	0.6200	-0.71380	-9.3640	0.6200	-0.71380
-10.7720	1.0000	-0.79371	-10.7723	1.0000	-0.79310
-10.7725	1.0000	-0.79290	-10.7731	1.0000	-0.79260
-10.7741	1.0000	-0.79230	-10.7761	1.0000	-0.79190
-10.7781	1.0000	-0.79170	-10.7821	1.0000	-0.79170
-12.6380	1.5000	-0.89631	-12.6383	1.5000	-0.89570
-12.6385	1.5000	-0.89550	-12.6391	1.5000	-0.89520
-12.6401	1.5000	-0.89480	-12.6421	1.5000	-0.89440
-12.6441	1.5000	-0.89420	-12.6481	1.5000	-0.89420
-14.5040	2.0000	-0.99881	-14.5043	2.0000	-0.99830
-14.5045	2.0000	-0.99810	-14.5051	2.0000	-0.99780
-14.5061	2.0000	-0.99740	-14.5081	2.0000	-0.99700
-14.5101	2.0000	-0.99680	-14.5141	2.0000	-0.99680
-16.3700	2.5000	-1.10141	-16.3703	2.5000	-1.10080
-16.3705	2.5000	-1.10060	-16.3710	2.5000	-1.10030

(PANEL 22 cont.)

Reading in Geometry Data
Type 3 cards
(PANEL 23)

Reading in Geometry Data
Type 3 cards
(PANEL 24)

Reading in Geometry Data
Type 3 cards
(PANEL 25)

SAMPLE PROBLEM #6 (continued)

0	1	2	3	4	5	6	7	8
123456789012345678901234567890123456789012345678901234567890								
-16.3721	2.5000	-1.09990	-16.3741	2.5000	-1.09950	103	3	23
-16.3761	2.5000	-1.09930	-16.3801	2.5000	-1.09930	103	3	24
-17.8500	2.8965	-1.18281	-17.8503	2.8965	-1.18220	103	3	25
-17.8505	2.8965	-1.18220	-17.8510	2.8965	-1.18170	103	3	26
-17.8521	2.8965	-1.18110	-17.8541	2.8965	-1.18090	103	3	27
-17.8561	2.8965	-1.18070	-17.8601	2.8965	-1.18070	103	3	28
-17.8500	2.8965	-1.18282	-17.8502	2.8965	-1.18340	103	3	29
-17.8504	2.8965	-1.18360	-17.8509	2.8965	-1.18400	103	3	30
-17.8519	2.8965	-1.18050	-17.8539	2.8965	-1.18510	103	3	31
-17.8559	2.8965	-1.18550	-17.8598	2.8965	-1.18590	103	3	32
-16.3700	2.5000	-1.10141	-16.3702	2.5000	-1.10200	103	3	33
-16.3704	2.5000	-1.10220	-16.3709	2.5000	-1.10260	103	3	34
-16.3719	2.5000	-1.10310	-16.3739	2.5000	-1.10370	103	3	35
-16.3759	2.5000	-1.10410	-16.3798	2.5000	-1.10450	103	3	36
-14.5040	2.0000	-0.99881	-14.5042	2.0000	-0.99940	103	3	37
-14.5045	2.0000	-0.99970	-14.5049	2.0000	-1.00000	103	3	38
-14.5059	2.0000	-1.00050	-14.5079	2.0000	-1.00110	103	3	39
-14.5099	2.0000	-1.00150	-14.5139	2.0000	-1.00200	103	3	40
-12.6380	1.5000	-0.89631	-12.6382	1.5000	-0.89690	103	3	41
-12.6385	1.5000	-0.89710	-12.6389	1.5000	-0.89750	103	3	42
-12.6399	1.5000	-0.89790	-12.6419	1.5000	-0.89860	103	3	43
-12.6439	1.5000	-0.89900	-12.6479	1.5000	-0.89940	103	3	44
-10.7720	1.0000	-0.79371	-10.7722	1.0000	-0.79430	103	3	45
-10.7725	1.0000	-0.79450	-10.7729	1.0000	-0.79490	103	3	46
-10.7739	1.0000	-0.79540	-10.7759	1.0000	-0.79600	103	3	47
-10.7779	1.0000	-0.79640	-10.7819	1.0000	-0.79680	103	3	48
-9.3543	0.6200	-0.71581	-9.3545	0.6200	-0.71630	103	3	49
-9.3547	0.6200	-0.71660	-9.3552	0.6200	-0.71690	103	3	50
-9.3561	0.6200	-0.71740	-9.3580	0.6200	-0.71800	103	3	51
-9.3599	0.6200	-0.71840	-9.3638	0.6200	-0.71880	103	3	52
-7.0403	0.0	-0.58861	-7.0405	0.0	-0.58910	103	3	53
-7.0407	0.0	-0.58940	-7.0412	0.0	-0.58970	103	3	54
-7.0422	0.0	-0.59020	-7.0441	0.0	-0.59080	103	3	55
-7.0460	0.0	-0.59120	-7.0499	0.0	-0.59160	103	3	56
-1.000000	0.000000	0.000000	-1.000000	0.000000	0.000000	Z 3328	3001	
-1.000001	0.000000	0.000000	-1.000001	0.000000	0.000000	Z 3328	3002	
01000	0.0	2.40002	-19.9242	0.0006	2.40000	103	3	1
-19.9240	0.0008	2.40000	-19.9250	0.0011	2.40000	103	3	2
-19.9245	0.0016	2.40000	-19.9280	0.0021	2.40000	103	3	3

(PANEL 25 cont)

Reading in Geometry Data
Type 3 cards
(PANEL 26)

SAMPLE PROBLEM #6 (continued)

0	1	2	3	4	5	6	7	8
123456789012345678901234567890123456789012345678901234567890								
-19.9300	0.0024	2.40000	-19.9340	0.0026	2.40000	103	3	4
-18.8250	0.0	2.00001	-18.8252	0.0006	2.00000	103	3	5
-18.8255	0.0008	2.00000	-18.8260	0.0011	2.00000	103	3	6
-18.8270	0.0016	2.00000	-18.8290	0.0021	2.00000	103	3	7
-18.8310	0.0024	2.00000	-18.8350	0.0026	2.00000	103	3	8
-17.4510	0.0	1.50001	-17.4512	0.0006	1.50000	103	3	9
-17.4515	0.0008	1.50000	-17.4520	0.0011	1.50000	103	3	10
-17.4530	0.0016	1.50000	-17.4550	0.0021	1.50000	103	3	11
-17.4570	0.0024	1.50000	-17.4610	0.0026	1.50000	103	3	12
-16.0780	0.0	1.00001	-16.0782	0.0006	1.00000	103	3	13
-16.0785	0.0008	1.00000	-16.0790	0.0011	1.00000	103	3	14
-16.0800	0.0016	1.00000	-16.0820	0.0021	1.00000	103	3	15
-16.0840	0.0024	1.00000	-16.0880	0.0026	1.00000	103	3	16
-15.2200	0.0	0.68781	-15.2202	0.0006	0.68780	103	3	17
-15.2205	0.0008	0.68780	-15.2210	0.0011	0.68780	103	3	18
-15.2220	0.0016	0.68780	-15.2240	0.0021	0.68780	103	3	19
-15.2260	0.0024	0.68780	-15.2300	0.0026	0.68780	103	3	20
-1.000000	0.000000	0.000000	-1.000000	0.000001	0.000000	Z 332B	3001	
-1.000001	0.000000	0.000000	-1.000001	0.000001	0.000000	Z 332B	3002	
027001	00							
01000	0.0	.542	2.25	0.0	.542	0	103SF 3	101
.25	0.0	.396602	1-7.05	.43	-.22	0	103SF 3	102
-7.05	0.0	.542	2.25	0.0	.542	0	103SF 3	201
.25	.43	.22	1-7.05	.61	.213398	0	103SF 3	202
.25	0.0	.542	2.25	0.0	.542	0	103SF 3	301
-7.05	.61	.213398	1-7.05	.42	.635	0	103SF 3	302
.25	0.0	.542	2.25	0.0	.542	0	103SF 3	401
-7.05	.42	.635	1-7.05	0.0	.83	3	103SF 3	402
028001	00							
01000	0.0	.396602	2-7.05	.43	-.22	0	103SF 3	701
-7.05	.46	.25	1-9.0	.46	-.25	0	103SF 3	702
-9.0	.43	.22	2-7.05	.61	.213398	0	103SF 3	801
-7.05	.46	.25	1-10.8	.62	.13	0	103SF 3	802
-9.0	.61	.213398	2-7.05	.42	.635	0	103SF 3	901
-7.05	.52	0.0	1-20.0	.37	.365	0	103SF 3	902
-20.0	.52	.635	2-7.05	0.0	.83	0	103SF 3	1001
-7.05	.37	.365	1-20.0	0.0	.52	3	103SF 3	1002
-20.0	.37	.365						
029001	00							
01000	0.0							

(PANEL 26 cont.)

Reading in Geometry Data
Type 3 cards
(PANEL 27)

Skin Friction Geometry

Reading in Geometry Data
Type 3 cards
(PANEL 28)

Skin Friction Geometry

Reading in Geometry Data
Type 3 cards
PANEL 29
Skin Friction Geometry

SAMPLE PROBLEM #6 (continued)

0	1	2	3	4	5	6	7	8
123456789012345678901234567890123456789012345678901234567890								
-7.05	0.0	-.396602	2-7.05	0.0	0.0	-.396602	0	103SF 3 1501
-10.8	0.0	-.60	1-10.8	0.62	0.62	-.60	0	103SF 3 1502
-10.8	0.0	-.60	2-10.8	0.62	0.62	-.60	0	103SF 3 1601
-17.86	0.0	-.991512	1-16.0	.62	.62	-.89	0	103SF 3 1602
-7.05	0.0	-.396602	2-7.05	0.0	0.0	-.396602	00	103SF 3 1701
-10.8	0.62	-.60	1-10.8	0.62	0.62	.13	0	103SF 3 1702
-10.8	.62	-.6	2-10.8	.62	.62	.13	0	103SF 3 1801
-20.0	.52	-.52	1-20.0	.52	.52	0.0	3	103SF 3 1802
0030001	00							
01000	0.0	-.586602	2-7.05	0.0	0.0	-.586602	0	103SF 3 501
-7.05	0.62	-.73	1-10.8	0.62	0.62	.13	0	103SF 3 502
-10.8	.62	-.73	2-10.8	.62	.62	.13	0	103SF 3 601
-20.0	.52	-.52	1-20.0	.52	.52	0.0	3	103SF 3 602
0031001	00							
01000	0.0	-.586602	2-7.05	0.0	0.0	-.586602	0	103SF 3 1101
-7.05	2.89653	1.181512	1-15.03	0.62	0.62	-.7878	0	103SF 3 1102
-17.86	2.89653	1.181512	2-15.03	0.62	0.62	-.7878	0	103SF 3 1201
-17.86	2.89653	1.181512	1-17.86	0.62	0.62	-1.181512	0	103SF 3 1202
-7.05	0.0	-.586602	2-7.05	0.0	0.0	-.586602	0	103SF 3 1301
-17.86	0.0	1.181512	1-17.86	2.89653	2.89653	-1.181512	3	103SF 3 1302
0032001	00							
01000	0.0025	.687813	2-19.934	0.0025	0.0025	2.40	0	103SF 3 1401
-15.23	.3983	.3302	1-20.994	.0025	.0025	2.40	3	103SF 3 1402
-20.0	0.0							
0033111	00							
01000	0.0	.68713	2-19.9087	0.0	0.0	.52	0	103SF 3 1901
-15.23	0.0	.68713	1-19.85	.296	.296	.435	3	103SF 3 1902
BODY MERIDIAN CUT FOR FLOWFIELD								
111111								
6.86	7.2067	4.349776	600.	001				
31.3115	0.0	7.2067	-12.5	0.0	0.0			
6.65								
0								
10016.86								
10016.85								
1001120								
00211	3.0							
01020305								

(PANEL 29)

Reading in Geometry Data
Type 3 cards
(PANEL 30)
Skin Friction Geometry

Reading in Geometry Data
Type 3 cards
(PANEL 31)
Skin Friction Geometry

Reading in Geometry Data
Type 3 cards
(PANEL 32)
Skin Friction Geometry

Reading in Geometry Data
Type 3 cards
(PANEL 33)
Skin Friction Geometry
Last card in GEM. option
1st card in 1st AERD option
Options for 1st AERD entry
1 thru 6 is Flow Field

1st Flow Field option
Generation of Flow Field for
Wing Lower Surface $y=0.0$ to 0.62
 $\phi = 0^\circ$ (PANEL 1,2,3,5)

CASE 103 BODY FLOW FIELD
-40.0
0110

SAMPLE PROBLEM #6 (continued)

0	1234567890123456789012345678901234567890123456789012345678901234567890	1	2	3	4	5	6	7	8
.25	0.0	.542	0.0	-1.53318	0.0	0.0	0.0	0.0	0.0
0.0									
1	11016.86								
11016.85									
1101111									
2									
1	11016.86								
11016.85									
1202120									
00211	-3.0	-40.0							
01020305	0.0	0.0							
.25	46.8	542	0.0	-1.53318	0.0				
35.2		56.8	61.6	64.8					
1	11016.86								
11016.85									
1102111									
2									
1	11016.86								
11016.85									
1203120									
00211	-3.0	-40.0							
01	0.0	0.110							
.25		.542	0.0	-1.53318	0.0				
180.0									
1	11016.86								
11016.85									
11016.85									
1103111									
2									
CASE 103	INVISCID	BUILDUP							
333333333333333									
6.86	7.2067	4.349776	600.0	001					
31.5115		7.2067	-12.5	0.0	0.0				
6.85									
010	SECT. J BODY NOSE CAP								
06	100								
0202000	1.822598	1.0	1.0	1.0	1.0				

1st Flow Field option

2nd Flow Field option
Read and Print of Flow Field Information for 1st Flow Field option ($\phi = 0^\circ$)

3rd Flow Field option
Generation of Flow Field for Wing Upper and Lower Surfaces (Uses PANEL 1,2,3,5)

$\phi = 35.2^\circ$ for Wing $y = 0.62$ to 1.0
 $\phi = 46.8$ for Wing $y = 1.0$ to 1.5
 $\phi = 56.8$ for Wing $y = 1.5$ to 2.0
 $\phi = 61.6$ for Wing $y = 2.0$ to 2.5
 $\phi = 64.8$ for Wing $y = 2.5$ to 2.896

4th Flow Field option
Read and Print of 3rd Flow Field Info.

5th Flow Field option
Generation of Flow Field for Vertical Fin (PANEL 1)
 $\phi = 180^\circ$

6th Flow Field option
Read and Print of 5th Flow Field Information $\phi = 180^\circ$

Last card in 1st AERCP. option
2nd AERCP. options

1st option in 2nd entry into AERCP. is Pressures
Body Nose Cap Inviscid Pressures
(PANEL 6) Force Component 1

SAMPLE PROBLEM #6 (continued)

0	1	2	3	4	5	6	7	8
1234567890123456789012345678901234567890123456789012345678901234567890								
011	BODY	100						130
010407	1,822598	1.0	1.0	1.0				140
0501000	LOWER SURFACE	Y=0.0 TO 0.62	WING					150
011	110							160
0905100	1,822598	1.0	1.0	1.0	13.0	3.0		180
211	0101	UPPER AND LOWER WING	Y=0.62 TO 1.0		Interference card			190
011	110							160
08191314	1,822598	1.0	1.0	1.0	13.0	3.0		220
0905100	0201010201	UPPER AND LOWER WING	Y=1.0 TO 1.5		Interference card			230
211	011							160
0918	1,822598	1.0	1.0	1.0	13.0	3.0		260
0905100	0202010202	UPPER AND LOWER WING	Y=1.5 TO 2.0		Interference card			270
011	110							160
0905100	1,822598	1.0	1.0	1.0	13.0	3.0		300
211	0203010203	UPPER AND LOWER WING	Y=2.0 TO 2.5		Interference card			310
011	116							160
0905100	1,822598	1.0	1.0	1.0	13.0	3.0		340
211	0204010204	UPPER AND LOWER WING	Y=2.5 TO 2.896531		Interference card			350
011	1215							160
0905100	1,822598	1.0	1.0	1.0	13.0	3.0		380
211	0205010205	WING L.E. (SECTION C)						390
011	100							400
25	0202000	1,822598	1.0	1.0	1.0			420
011	24	WING INBOARD BASE	ARFA (SECTION P)					430
0506000	1,822598	1.0	1.0	1.0				440
012	27283031	SKIN FRICTION PRESSURES						450
0501101	1,822598	1.0	1.0	1.0				460
011	27283031	LAMINAR WING=BODY SKIN FRICTION	1013					470
110	01	1 71102.0648	0.5875	0.0	1.0	1.0	518,67518.67	480
02	1 71102.0648	0.5875	0.0	1.0	1.0	1.0	518,67518.67	490

2nd option in 2nd entry into AERD is Pressures
 Body Inviscid Pressures
 (PANELS 1,4,7) Force Component 2
 3rd option in 2nd entry into AERD is Pressures
 Wing lower surface $\psi=0.0$ to 0.62
 (PANEL 20) Force Component 3
 4th option in 2nd entry into AERD is Pressures
 Wing Upper & Lower surfaces $\psi=0.62$ to 1.0
 (PANEL 8, 13, 14, 19) Force Component 4
 5th option in 2nd entry into AERD is Pressures
 Wing upper and lower surfaces $\psi=1.0$ to 1.5
 (PANEL 9, 18) Force Component 5
 6th option in 2nd entry into AERD is Pressures
 Wing Upper and Lower surfaces $\psi=1.5$ to 2.0
 (PANEL 10, 17) Force Component 6
 7th option in 2nd entry into AERD is Pressures
 Wing Upper and Lower surfaces $\psi=2.0$ to 2.15
 (PANEL 11, 16) Force Component 7
 8th option in 2nd entry into AERD is Pressures
 Wing Upper and Lower Surfaces $\psi=2.15$ to 2.896
 (PANEL 12, 15) Force Component 8
 9th option in 2nd entry into AERD is Pressures
 (PANEL 25) Force Component 9
 10th option in 2nd entry into AERD is Pressures
 (PANEL 24) Force Component 10
 11th option in 2nd entry into AERD is Pressures (for skin friction surfaces)
 (PANEL 27, 28, 30, 31) No Force Component is saved
 12th option in 2nd entry into AERD is Viscous (Mark III Methods)
 Body + Wing Laminar Skin Friction
 Total of 13 Skin Friction Surfaces
 (PANEL 27, 28 30, 31) Force Component 11

SAMPLE PROBLEM #6 (continued)

0	1	2	3	4	5	6	7	8
1234567890	1234567890	1234567890	1234567890	1234567890	1234567890	1234567890	1234567890	1234567890
03	1 71102.0648	0.5875	0.0	1.0	518.67518.67			
04	1 71102.0648	0.5875	0.0	1.0	518.67518.67			
05	1 71100.497	0.1625	0.58751.0	1.0	518.67518.67			
06	1 71101.506	0.3120	0.58751.0	1.0	518.67518.67			
07	1 71106.29835	1.079167	0.58751.0	1.0	518.67518.67			
08	1 71106.29835	1.079167	0.58751.0	1.0	518.67518.67			
09	1 711001.40256	0.3120	0.0	1.0	518.67518.67			
10	1 7110 8.0850	0.766	0.51201.0	1.0	518.67518.67			
11	1 71106.6068	0.73325	0.0	1.0	518.67518.67			
12	1 71103.96669	0.34683	0.473320.0	0.0	518.67518.67			
13	1 711015.65575	0.90833	0.0	1.0	518.67518.67			
011	VERTICAL FIN SIDES (SECTION H)							
22	110							
0303100	1.822598	1.0	1.0	1.0				
211	0301010301							
011	VERTICAL FIN L.E. (SECTION E)							
26	100							
0202 00	1.822598	1.0	1.0	1.0				
011	VERTICAL FIN BASE AREA (SECTION L)							
23	100							
0306000	1.822598	1.0	1.0	1.0				
CASE 103	AREA COVERED BY VERTICAL FIN							
3								
6.86	7.2067	4.349776	600.0	001				
-31.3115	7.2067	7.2067	-12.5	0.0				
6.85								
011	AREA COVERED BY VERTICAL FIN							
21	100							
0501000	1.822598	1.0	1.0	1.0				
CASE 103								
34								
6.86	7.2067	4.349776	600.0	001				
31.3115	7.2067	7.2067	-12.5	0.0				
6.85								
012	VERTICAL FIN SKIN FRICTION (PRESSURE CALCULATION)							
32	100							
0303101	1.822598	1.0	1.0	1.0				
011	VERTICAL FIN LAMINAR SKIN FRICTION							
32	1001							
110								
1	1 71105.364277	0.39625	0.0	1.0	0.22292518.67518.67			

(Body + Wing Laminar Skin Friction cont.)

13th option in 2nd entry into AERQ. is Vertical Fin Sides (with interference) (PANEL 22) Force Component 12

14th option in 2nd entry into AERQ. is (PANEL 26) Force Component 13

15th option in 2nd entry into AERQ. is (PANEL 23) Force Component 14

1st card in 3rd entry into AERQ. is option for 3rd entry into AERQ. is Pressures

Inviscid Pressures for Area on Body Covered by Vertical Fin (PANEL 21) Force Component 15

Last card for 3rd entry into AERQ. is 1st card in 4th entry into AERQ. AERQ options are:

a) Pressures
b) Viscous

1st option in 4th entry into AERQ. is Pressures (for skin friction surfaces) (PANEL 32) No Force Component is saved

2nd option in 4th entry into AERQ. is Viscous (Mark III Methods) Vertical Fin Laminar Skin Friction

1 skin friction surface
PANEL 32 Force Component 16

Last card in 4th entry into AERQ. 103

SAMPLE PROBLEM #6 (continued)

0	1234567890123456789012345678901234567890123456789012345678901234567890	1	2	3	4	5	6	7	8
34	AREA ON BODY COVERED BY VERTICAL FIN								
6,86	7.2067	4.349776	600.0	001					700
6,85	7.2067	7.2067	-12.5	0.0	0.0				71
012	AREA COVERED BY VERTICAL FIN ON BODY SKIN FRI	PRESS.							720
35	1000								
0303101	1.822598	1.0	1.0	1.0					
011	SKIN FRICTION FOR AREA COVERED BY VERT. FIN								
33	1001								
110	1 1 7110.8655	.37667	1.290	1.0	1.0	518.67518.67			
TURBULENT SKIN FRICTION									
34343453335									
6,86	7.2067	4.349776	600.0	001					700
6,85	7.2067	7.2067	-12.5	0.0	0.0				710
012	TURB. SKIN FRICTION BODY + WING								
27283031	1.822598	1.0	1.0	1.0					
0505201	100								
011	TURB. SKIN FRICTION BODY + WING								
27283031									
110	0 21102.0648	0.5875	0.0	1.0	1.0	518.67518.67			
02	0 21102.0648	0.5875	0.0	1.0	1.0	518.67518.67			
03	0 21102.0648	0.5875	0.0	1.0	1.0	518.67518.67			
04	0 21102.0648	0.5875	0.0	1.0	1.0	518.67518.67			
05	0 21100.497	0.1425	0.58751.0	1.0	1.0	518.67518.67			
06	0 21101.506	0.3120	0.58751.0	1.0	1.0	518.67518.67			
07	0 21104.29835	1.079167	0.58751.0	1.0	1.0	518.67518.67			
08	0 21106.29835	1.079167	0.58751.0	1.0	1.0	518.67518.67			
09	0 211001.40256	0.3120	0.0	1.0	1.0	518.67518.67			
10	0 21108.0850	0.766	0.31201.0	1.0	1.0	518.67518.67			
11	0 21106.6068	.473325	0.0	1.0	0.0	518.67518.67			
12	0 21103.96669	.234683	.473320.0	0.0	0.0	518.67518.67			
13	0 211015.65575	.900833	0.0	1.0	0.0	518.67518.67			
012	PRESS. FOR TURB. SKIN FRI. VERT. FIN								
32	100								
0305201	1.822598	1.0	1.0	1.0					
011	TURB. SKIN FRICTION FOR VERT. FIN								
32	1001								

1st card in 5th entry into AERφ.
AERφ options are:

- a) Pressures
- b) Viscous

1st option in 5th entry into AERφ. is Pressures (for skin friction surfaces) (PANEL 33) No Force Component is saved

2nd option in 5th entry into AERφ. is Viscous (Mark III Methods) Vertical Fin Laminar Skin Friction (PANEL 33) Force Component 17
1st card in 6th entry into AERφ. Options for 6th entry into AERφ.

1st option in 6th entry into AERφ is Pressures (For skin friction surfaces) (PANEL 27,28,30,31) No Force Component is saved

2nd option in 6th entry into AERφ is Viscous (Mark III Methods)

Body + Wing Turbulent Skin Friction

Total of 13 Skin Friction Surfaces (PANEL 27,28,30,31) Force Component 18

3rd option in 6th entry into AERφ is Pressures (for skin friction surfaces) (PANEL 32) No Force Component is saved

4th option in 6th entry into AERφ. is Viscous (Mark III Methods) Vertical Fin Turbulent Skin Friction

1 Skin friction surface (PANEL 32) Force Component 19

SAMPLE PROBLEM #6 (continued)

0	1	2	3	4	5	6	7	8	
1234567890123456789012345678901234567890123456789012345678901234567890									
110	1	0	21105,364277	0.0	1.0	.22292518,67518,67	103		(Vertical Fin Turbulent Skin Friction cont.)
012			PRESS. FOR TURB. SKIN. FRI. AREA COVERED BY V, FIN						5th option in 6th entry into AERD. is Pressures (For skin friction surfaces)
33			1.00						(PANEL 33) No Force Component is saved
0505201	1.0	1.0	1.0	1.0					6th option in 6th entry into AERD. is Viscous (Mark III Method) Body Area Covered by Vertical Fin
011			TURB. SKIN FRI. FOR AREA COVERED BY V, FIN						(PANEL 33) Force Component 20
33			1001						7th option in 6th entry into AERD. is Summation
110	1	0	21107,8655	1.290	1.0	518,67518,67	103		
1			0102						Body Alone (to be used with wing) Inviscid
01100			01020304050607080910						Body + Wing Inviscid (with interference)
01100			0102030405060708091011						Body + Wing Inviscid (with interference) + Laminar Skin Friction
01100			0102030405060708091012131415						Inviscid
01100			0102030405060708091011121314151617						Inviscid + Laminar Skin Friction
01100			0102030405060708091018						Inviscid + Turbulent skin Friction
01100			0102030405060708091018121314151920						Inviscid + Turbulent Skin Friction
011									8th option in 6th entry into AERD. is Pressures
20			100						Wing Lower Surface $\gamma=0.0$ to $\gamma=0.62$ No Interference
0501100	1.0	1.0	1.0	1.0					(PANEL 20) Force Component 21
011			08091011121516171819100						9th option in 6th entry into AERD. is Pressures
0905100	1.0	1.0	1.0	1.0					Wing outboard of $\gamma=0.62$ No Interference
011									PANEL 8, 9, 10, 11, 12, 13, 16, 17, 18, 19
1314			100						Force Component 22
0905100	1.0	1.0	1.0	1.0					10th option in 6th entry into AERD. is Pressures
1			01020910212223						(PANEL 13, 14) No interference
01100			0102091021222311						Force Component 23
01100			0102091021222311121314151617						11th option in 6th entry into AERD. is Summation
01100			0102091021222318						Body + Wing (No interference) Inviscid + Laminar Skin Friction
11100			0102091021222318121314151920						Body + Wing (No interference) Inviscid + Vertical Fin (with interference) + Laminar Skin Friction
									Body + Wing (No interference) Inviscid + Turbulent Skin Friction
									Body + Wing (No interference) Inviscid + Vertical Fin (with interference) + Turbulent Skin Friction

REFERENCES

1. Gentry, A. E., and Smyth, D. N., Hypersonic Arbitrary-Body Aerodynamic Computer Program, Mark III Version, Volume I User's Manual, Volume II Program Formulation and Listings, Douglas Report D4C 61552 (AD-851 811 and AD-851 812), April 1968.
2. Lees, L., Hypersonic Flow, Fifth International Aeronautical Conference Proceedings, June 1955.
3. McLellan, C. H., Bertram, M. H., and Moore, J. A., An Investigation of Four Wings of Square Planform at a Mach Number of 6.86 in the Langley 11-inch Hypersonic Tunnel, NACA RML51D17, June 1951.
4. Collingbourne, J. R., An Empirical Prediction Method for the Non-Linear Normal Force on Thin Wings at Supersonic Speeds, Aeronautical Research Council CP-662, Great Britain, 1963.
5. Hayes, W. D., and Probstein, R. F., Hypersonic Flow Theory, Vol. 5, Academic Press, 1959.
6. Witcofski, R. D., and Marcum, D. C., Jr., Effect of Thickness and Sweep Angle on the Longitudinal Aerodynamic Characteristics of Slab Delta Planforms at a Mach Number of 20, NASA TN D-3459, June 1966.
7. Henderson, A., Jr., and Braswell, D. O., Charts for Conical and Two Dimensional Oblique Shock Flow Parameters in Helium at Mach Numbers From About 1 to 100, NASA TN D-819, June 1961.
8. Gregorek, G. M., Nark, T. C., and Lee, J. D., An Experimental Investigation of the Surface Pressure and Laminar Boundary Layer on a Blunt Flat Plate in Hypersonic Flow, Vol. I, ASD-TDR-62-792, March 1963.
9. Lee, J. D., Pressures on the Blunt Plate Wing at Supersonic and Hypersonic Speeds, FDL-TDR-64-102, July 1964.
10. Epstein, P. S., On the Air Resistance of Projectiles, Proc. Nat. Academy Sci. U.S.A., Vol. 17, pages 532-547, 1931.
11. Love, E. S., Generalized Newtonian Theory, Journal of Aerospace Sciences (Readers Forum), Vol. 26, No. 5, May 1959, pages 314-315.
12. Seiff, A., Secondary Flow Fields Embedded in Hypersonic Shock Layers, NASA TN D-1304, May 1962.
13. Seiff, A., and Whiting, E. E., Calculation of Flow Fields from Bow Wave Profiles for the Downstream Region of Blunt Nosed Circular Cylinders in Axial Hypersonic Flight, NASA TN D-1147, 1961.

Contrails

14. Kaufman, L. G., II., Pressure Estimation Techniques for Hypersonic Flows Over Blunt Bodies, Journal of Astronautical Sciences, Volume X, No. 2, Summer 1963.
15. Ames Research Staff, Equations, Tables and Charts for Compressible Flow, NACA TR-1135, 1953.
16. Fetterman, D. E., A Method for Predicting the Normal Force Characteristics of Delta Wings at Angles of Attack from 0° to 90° , NASA TMX-757, March 1963.
17. Eggers, A. J., and Syvertson, C. A., Inviscid Flow about Airfoils at High Supersonic Speeds, NACA TN 2646, March 1952.
18. Savin, Raymond, Application of the Generalized Shock Expansion Method to Inclined Bodies of Revolution Traveling at High Supersonic Airspeeds, NACA TN 3349, April 1955.

UNCLASSIFIED

SECURITY CLASSIFICATION OF THIS PAGE (When Data Entered)

REPORT DOCUMENTATION PAGE		READ INSTRUCTIONS BEFORE COMPLETING FORM
1. REPORT NUMBER AFFDL-TR-73-159 VOLUME I	2. GOVT ACCESSION NO.	3. RECIPIENT'S CATALOG NUMBER
4. TITLE (and Subtitle) THE MARK IV SUPERSONIC-HYPERSONIC ARBITRARY-BODY PROGRAM, VOLUME I - USER'S MANUAL	5. TYPE OF REPORT & PERIOD COVERED Final	
	6. PERFORMING ORG. REPORT NUMBER	
7. AUTHOR(s) Arvel E. Gentry Douglas N. Smyth Wayne R. Oliver	8. CONTRACT OR GRANT NUMBER(s) F33615-72-1675	
9. PERFORMING ORGANIZATION NAME AND ADDRESS Douglas Aircraft Company, McDonnell Douglas Corp. 3855 Lakewood Blvd. Long Beach, California 90846	10. PROGRAM ELEMENT, PROJECT, TASK AREA & WORK UNIT NUMBERS	
11. CONTROLLING OFFICE NAME AND ADDRESS Air Force Flight Dynamics Laboratory AFFDL/FXG Wright-Patterson AFB, Ohio	12. REPORT DATE November 1973	
	13. NUMBER OF PAGES 268	
14. MONITORING AGENCY NAME & ADDRESS (if different from Controlling Office)	15. SECURITY CLASS. (of this report) Unclassified	
	15a. DECLASSIFICATION/DOWNGRADING SCHEDULE N/A	
16. DISTRIBUTION STATEMENT (of this Report) Approved for public release; distribution unlimited.		
17. DISTRIBUTION STATEMENT (of the abstract entered in Block 20, if different from Report)		
18. SUPPLEMENTARY NOTES		
19. KEY WORDS (Continue on reverse side if necessary and identify by block number)		
Aerodynamics	Supersonic	FORTRAN
Arbitrary	Hypersonic	Graphics
Three-Dimensional	Flow	
Shapes	Computers (Digital)	
20. ABSTRACT (Continue on reverse side if necessary and identify by block number)		
<p>This report describes a digital computer program system that is capable of calculating the supersonic and hypersonic aerodynamic characteristics of complex arbitrary three-dimensional shapes. This program is identified as the Mark IV Supersonic-Hypersonic Arbitrary-Body Computer Program. This program is a complete reorganization and expansion of the old Mark III Hypersonic Arbitrary-Body Program. The Mark IV program has a number of new capabilities that extend its applicability down into the supersonic speed range.</p>		

20. ABSTRACT (continued)

The outstanding features of this program are its flexibility in covering a very wide variety of problems and the multitude of program options available. The program is a combination of techniques and capabilities necessary in performing a complete aerodynamic analysis of supersonic and hypersonic shapes. These include: vehicle geometry preparation; computer graphics to check out the geometry; analysis techniques for defining vehicle component flow field effects; surface streamline computations; the shielding of one part of a vehicle by another; calculation of surface pressures using a great variety of pressure calculation methods including embedded flow field effects; and computation of skin friction forces and wall temperature.

Although the program primarily uses local-slope pressure calculation methods that are most accurate at hypersonic speeds, its capabilities have been extended down into the supersonic speed range by the use of embedded flow field concepts. This permits the first order effects of component interference to be accounted for.

The program is written in FORTRAN for use on CDC or IBM types of computers.

The program is documented in three volumes. Volume I is primarily a User's Manual, Volume II gives the Program Formulation, and Volume III contains the Program Listings.