

WADC TECHNICAL REPORT 52-101
PART 2

**EQUIPMENT FOR TESTING THE CREEP PROPERTIES OF METALS
UNDER INTERMITTENT STRESSING AND HEATING CONDITIONS**

Part 2. Current Modifications

*Lawrence A. Shepard
Carl D. Wiseman
C. Dean Starr
John E. Dorn*

University of California

August 1954

**Materials Laboratory
Contract No. AF 33(038)-11502
RDO No. 614-13 (A-C)**

**Wright Air Development Center
Air Research and Development Command
United States Air Force
Wright-Patterson Air Force Base, Ohio**

Contrails

FOREWORD

This report was prepared by the University of California, under USAF Contract No. AF 33(038)-11502. The contract was initiated under Research and Development Order No. 614-13, "Design and Evaluation Data for Structural Metals", and was administered under the direction of the Materials Laboratory, Directorate of Research, Wright Air Development Center, with Mr. E. L. Horne acting as project engineer.

WADC TR 52-101 Pt 2

Contrails

ABSTRACT

Four creep testing units were constructed at the University of California to test the creep strength of aircraft metals under intermittent loading and heating conditions. The equipment was designed to permit operations of loading, unloading, heating and cooling of the test specimen to occur automatically and periodically on a preset cycle. Special care was taken to provide smooth and vibration-free function of the equipment. Provisions were made for the accurate and continuous recording of both strains and temperature throughout the test.

PUBLICATION REVIEW

This report has been reviewed and is approved.

FOR THE COMMANDER:

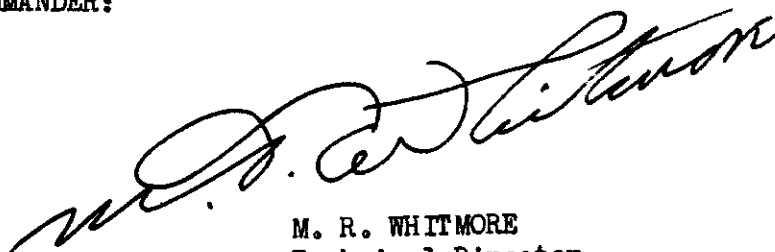

M. R. WHITMORE
Technical Director
Materials Laboratory
Directorate of Research

Contrails
TABLE OF CONTENTS

| | <u>Page</u> |
|--|-------------|
| Introduction | 1 |
| Description of the Equipment | 2 |
| (A) Loading and Unloading | 10 |
| (B) Furnace Design and Temperature Cycling | 14 |
| (C) Specimen Design | 17 |
| (D) Automatic Recording Apparatus | 19 |
| Discussion of Overall Operation | 21 |
| Summary | 23 |

LIST OF ILLUSTRATIONS

| <u>Figure</u> | <u>Page</u> |
|--|-------------|
| 1. Side View of Testing Units | 4 |
| 2. Fulcrum and Alignment Flexure Plates and Strain Gage . . | 5 |
| 3. Front View of Testing Units | 7 |
| 4. Lower Specimen Mounting and Spider | 8 |
| 5. Controlling and Recording Instrument Panels | 9 |
| 6. Block Diagram of Electrical Control System | 11 |
| 7. Schematic Representation of Loading and Unloading System | 12 |
| 8. Schematic Representation of Circuitry for Direct Electrical Resistance Heating of the Creep Specimen . . . | 16 |
| 9. Design of Creep Test Specimen | 18 |
| 10. Detail of Grating Arrangement for Strain Recording . . . | 20 |
| 11. A Section of a Strain and Temperature Record for Cyclic Loading | 22 |

Contrails

INTRODUCTION

Because metal structures designed for high temperature application are frequently subjected to histories of variable stress and temperature, a need exists for design criteria which will include the effects of such possible or expected variations on the strength of engineering metals. In the study of the creep resistance of metals, laboratory testing has been confined in the past mainly to tests under conditions of constant stress and temperature. Extrapolation of such creep data to cover conditions of variable stress and temperature is impractical at present for two important reasons:

First, no suitable theory of creep exists to date which will permit the unequivocal extension of constant stress and temperature data to cover the case of variable conditions even for pure metals. It should be noted, however, that considerable progress is being made in this direction.

Second, the complex metallurgical changes such as aging and precipitation which are attendant on creep of almost any of the high strength alloys are known to be highly dependent upon the stress and temperature, adding an additional complication to the a priori extrapolation of creep data under constant conditions to those where stress and temperature are varying.

In view of the need for design data for creep under varying conditions, an empirical approach to the problem seems called for. Just such an experimental program has been initiated by the Wright Air Development Center for the study of the creep of a range of metals and alloys of greatest interest to the aircraft designer, under a series of varying stress and temperature conditions which would approximate in the laboratory the actual conditions of service.

Contrails

One portion of this program, a study of the effects of intermittent loading and heating on the creep properties of aircraft alloys was undertaken at the University of California. As additional experience was acquired by use of the equipment to carry out this study as described in Part 1 of this technical report, improvements and modifications were made which resulted in equipment which operated more satisfactorily. The equipment as modified, is described herein.

Test data obtained with the equipment described and analyses of results are presented in WADC Technical Report 53-336 "The Creep Properties of Metals Under Intermittent Stressing and Heating Conditions."

DESCRIPTION OF THE EQUIPMENT

Four automatically operated and autographically recording creep testing units were designed and constructed at the University of California. The machines and auxiliary control equipment were designed to permit automatic loading and unloading of the test specimen, heating of the specimen to test temperature and cooling it to room temperature periodically in any preset cycle. Associated autographic recording equipment was incorporated to provide a continuous record of strain and temperature which may be read to one ten thousandth of an inch and one degree Fahrenheit respectively. Extreme care was taken to minimize vibration, to assure steady and uniform loading and unloading and to subject the specimen to a constant and axial tensile load.

An outline of the design and construction of the units will be given in this section of the report whereas the working details will be elaborated in the sections that follow.

The basic design of the present machines is not markedly dissimilar from the design of common types of tensile creep testing machines, as

illustrated in the photograph of Figure 1. A vertical column supporting a horizontal lever arm is mounted on a high inertia concrete base which in turn is insulated from ground vibration by double isomode pads between the high inertia concrete base and the concrete floor. The concrete floor, which was cast directly on the ground, is about three feet below the wooden working floor. This was done in order to separate the creep units from the building structure and thus reduce the transmission of floor vibrations to the units. The higher elevation of the working floor area also permits easy accessibility for mounting the specimens and adjusting the units. Weights for loading the specimens are placed on a weight pan suspended through a pin at the back of the 10 to 1 ratio lever arm. Adjustable counterweights have been placed on the front of the lever arm in order to facilitate compensation for the dead load of the lever arm as well as the additional loads arising from the auxiliary fixtures for mounting the specimen and the strain gages. In order to reduce the objectionable and variable effects of friction inherent in conventional designs, a sensitive flexure plate was substituted for the commonly used knife edge at the fulcrum of the beam as shown in the photograph of Fig. 2. For the same reason a set of two sensitive orthogonally aligned flexure plates was substituted for each of the two universal joints commonly employed in series with the specimen in order to reduce the bending of the specimen and thus permit pure tensile loading. Tests on repeated loadings and unloadings including removal and remounting of the specimens have revealed consistently uniform results on axial stressing of the specimen, thus verifying the satisfactory results obtained by these innovations.

The specimen is heated in a split furnace, the two halves of which separate vertically to facilitate specimen mounting and to permit specimen

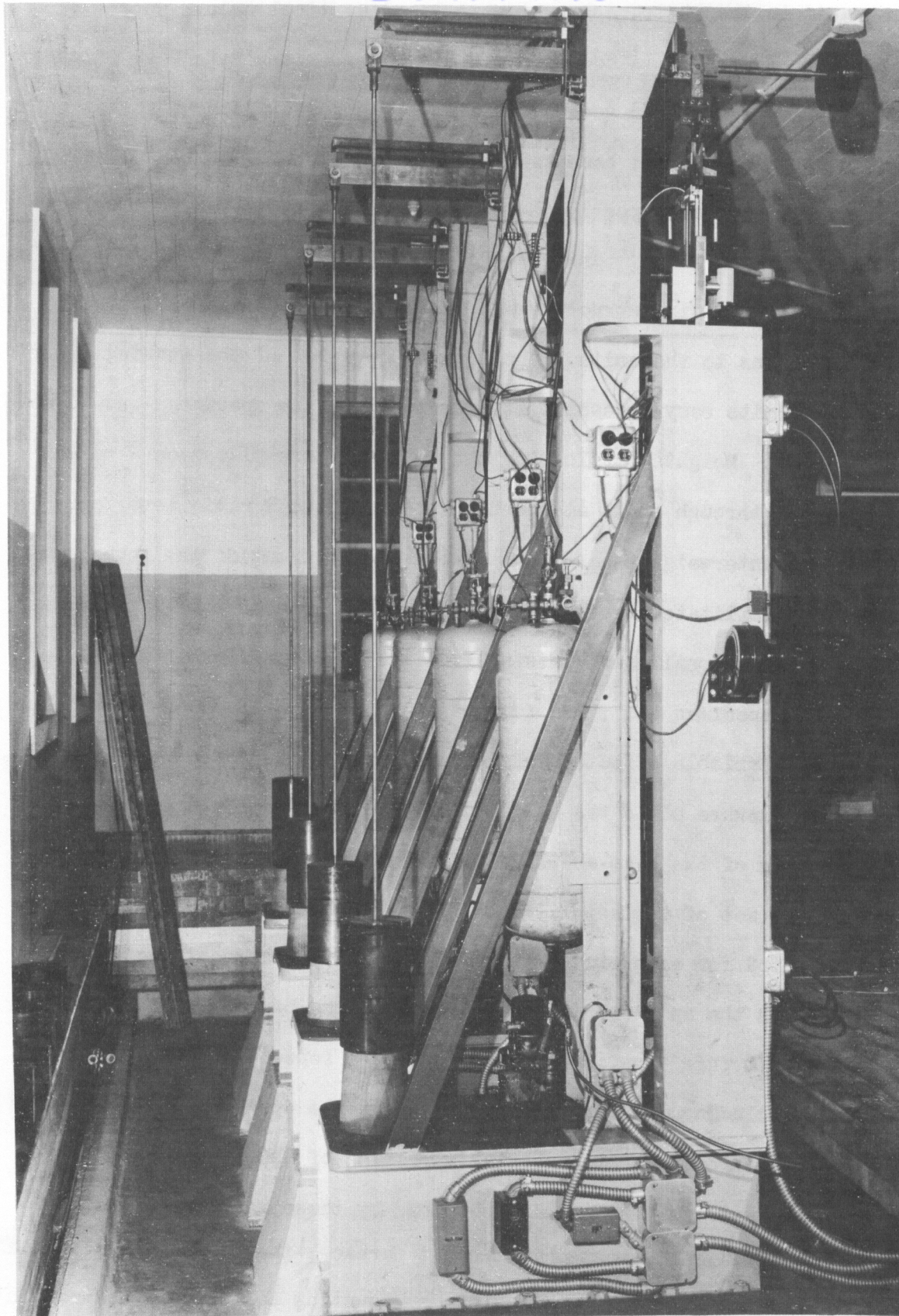
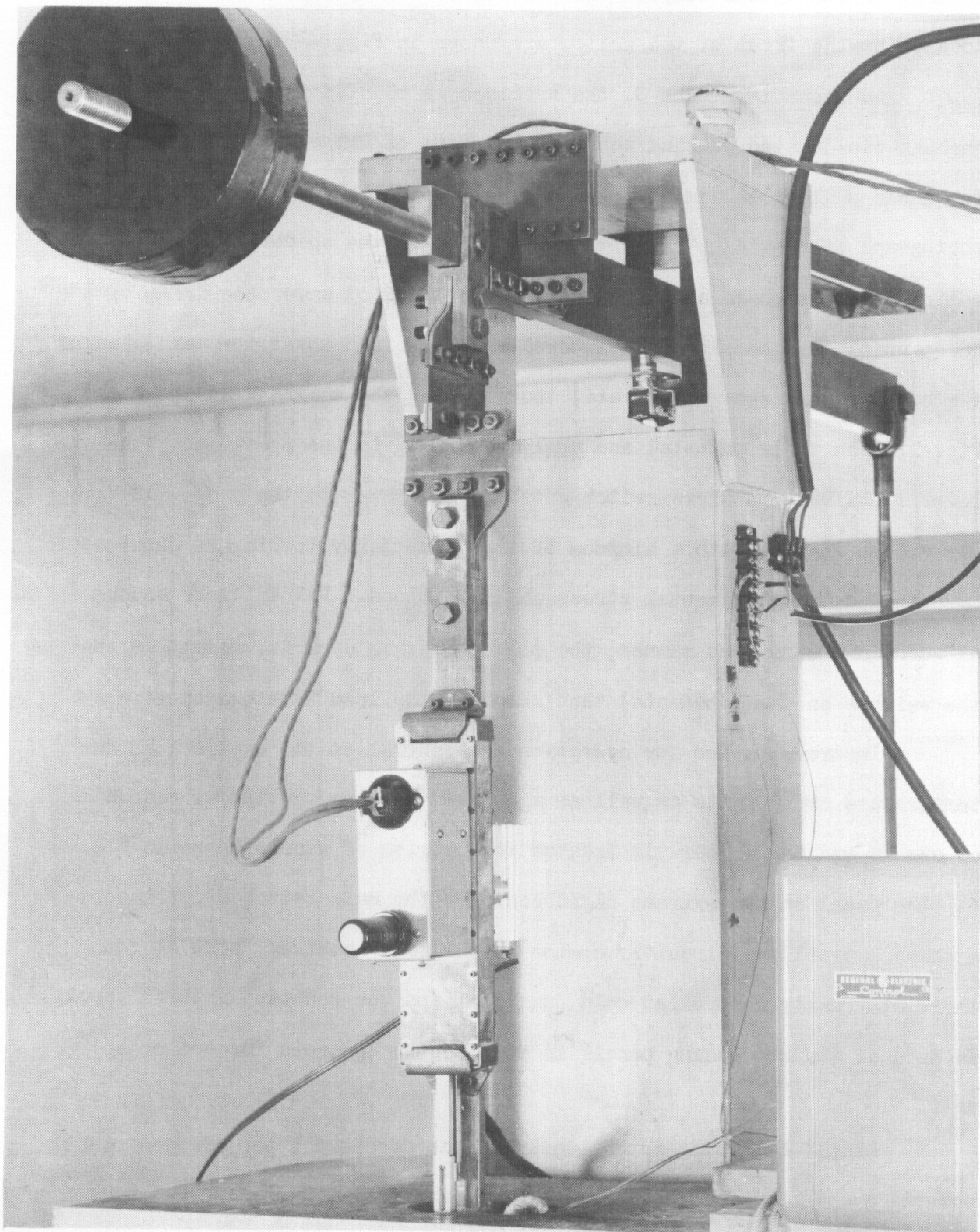

Figure 1. SIDE VIEW OF TESTING UNITS



**Figure 2. FULCRUM AND ALIGNMENT FLEXURE PLATES
AND STRAIN GAGE**

Contrails

cooling in the cyclic temperature portion of the operation. The furnaces, located at the front of the units, are shown in Figure 3.

As shown in Figure 3, the specimen is mounted to the lever arm through pin jointed pulling tabs and two sets of orthogonal flexure plates. The lower pulling tab is attached to the spider shown at the bottom of the photograph of Fig. 4. The vertical position of the spider is fixed by the motion of a piston in an hydraulic cylinder located under the frame of the creep unit. As the piston is lowered, the specimen moves downward causing the back of the lever to elevate, thus lifting the weights, as shown in Fig. 1, from their pedestal and applying a load to the specimen. When the lever is balanced a micro-switch cuts off the power to the pump. In this way smooth loading with a minimum of irregular jerky loading is obtained, as revealed by experimental stress determinations. Unloading is accomplished in the reverse manner; the piston, moving upwards, resettles the the weights on their pedestal thus removing the load from the specimen.

Instrumentation for operation and control of the cyclic load and temperature creep units as well as apparatus for the continuous recording of strain and temperature is located in a series of panels shown in Fig. 5. The panel on the extreme right contains the main switches for each machine, as well as circuitry common to the four machines, such as the thermostatically controlled cold junction, and the constant voltage supply. In each of the succeeding panels is mounted the controls for one creep unit.

A self-balancing potentiometric recorder at the top of each panel records temperature and strain. Below it are thermocouple suppression selector switches and dials for limiting the strain magnification on the record. An a-c resistance bridge type controller immediately beneath



FIGURE 3. FRONT VIEW OF TESTING UNITS

WADC TR 52-101 Pt 2

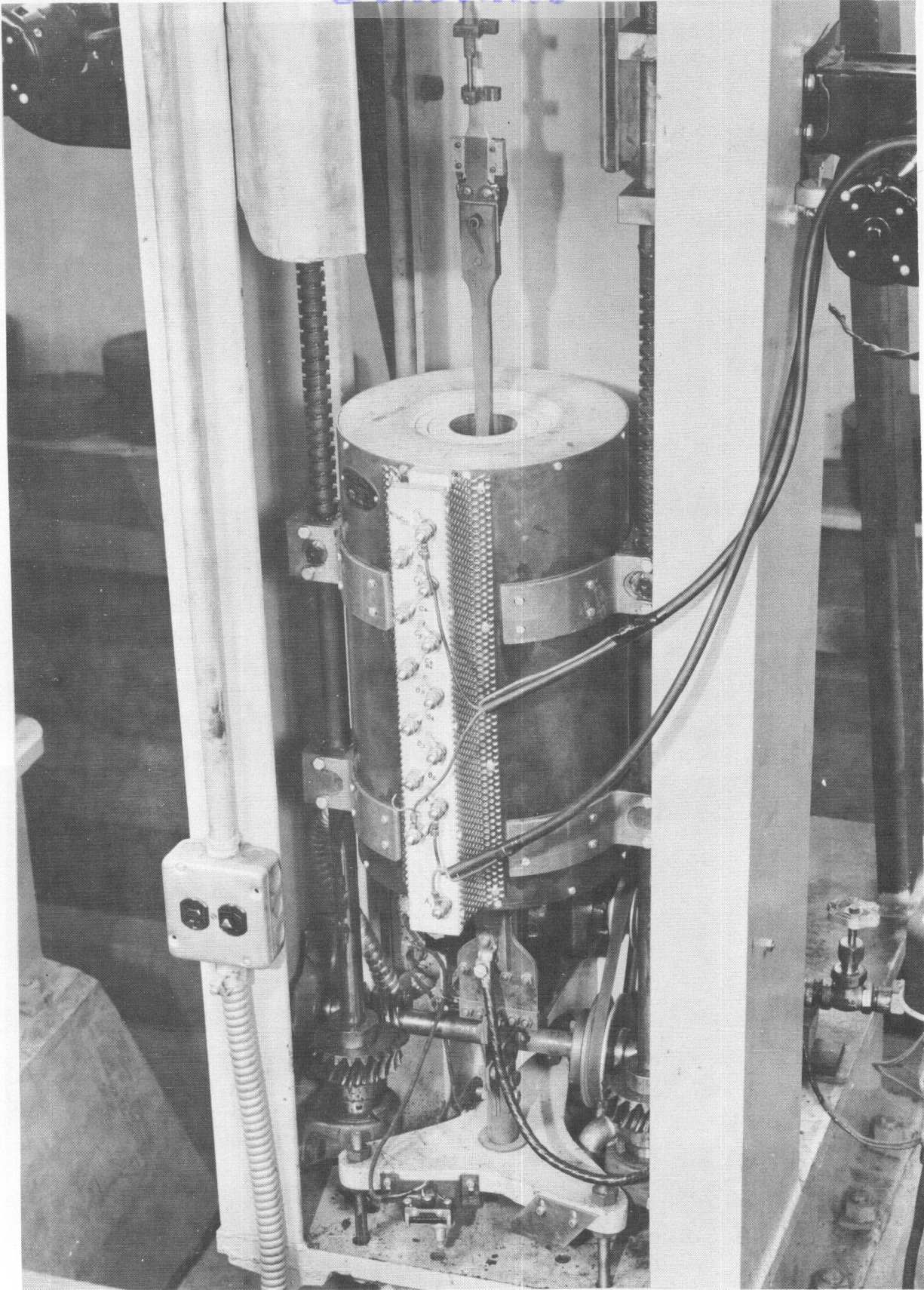

Figure 4. LOWER SPECIMEN MOUNTING AND SPIDER

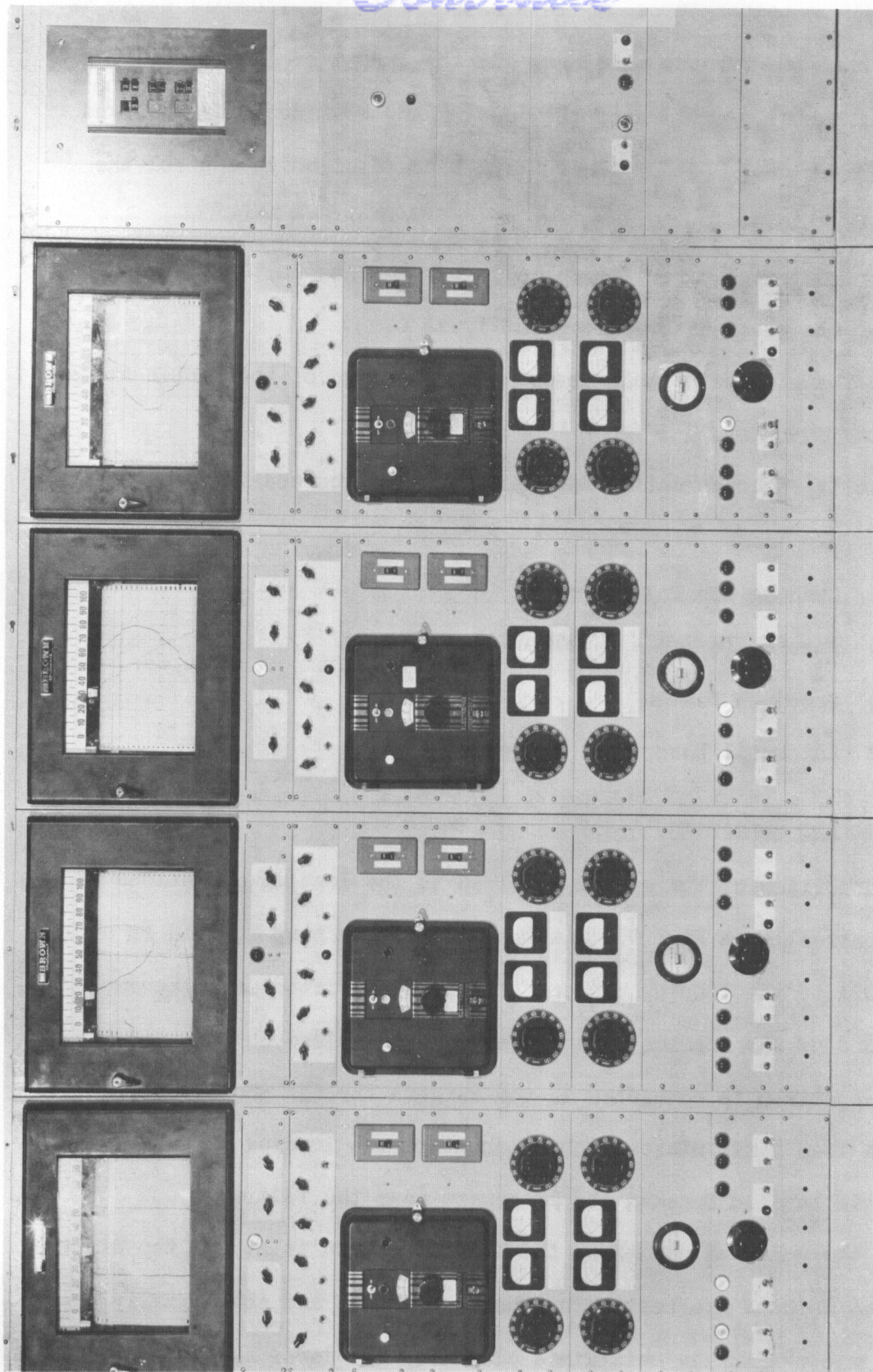

FIGURE 5. CONTROLLING AND RECORDING INSTRUMENT PANELS

controls furnace temperatures, while the four auto transformers below it supply power to the furnace windings. In the lowest panel are the toggle switches for manual operation of the loading and heating apparatus, and the timer driven cams, behind the central black dial which control the automatic operations.

The electrical circuitry for all four testing units is shown schematically in block diagram form in Figure 6.

The above description gives the basic design of the cyclic stress creep testing machines.

Details of construction and operation will be considered in the following order:

- (A) Loading and Unloading
- (B) Furnace Design and Temperature Cycling
- (C) Specimen Design
- (D) Automatic Recording Apparatus

(A) LOADING AND UNLOADING:

The portion of the system involved in the loading operations is shown schematically in Fig. 7. A motor driven gear pump is used to apply a head of oil to the loading piston. The loading piston is attached to the lower end of the specimen, and extends the specimen on downward movement. The specimen is connected to the weights through the lever arm linkage. A load limit microswitch which stops the loading operation at completion is located beneath the lever arm near the fulcrum.

In the unloaded position, the loading piston is at the top of its travel. The weights are resting on their pedestal, and the normally open load limit microswitch is maintained closed by the lever arm. When either the manual or automatic loading switch is closed, the circuit is completed

Control

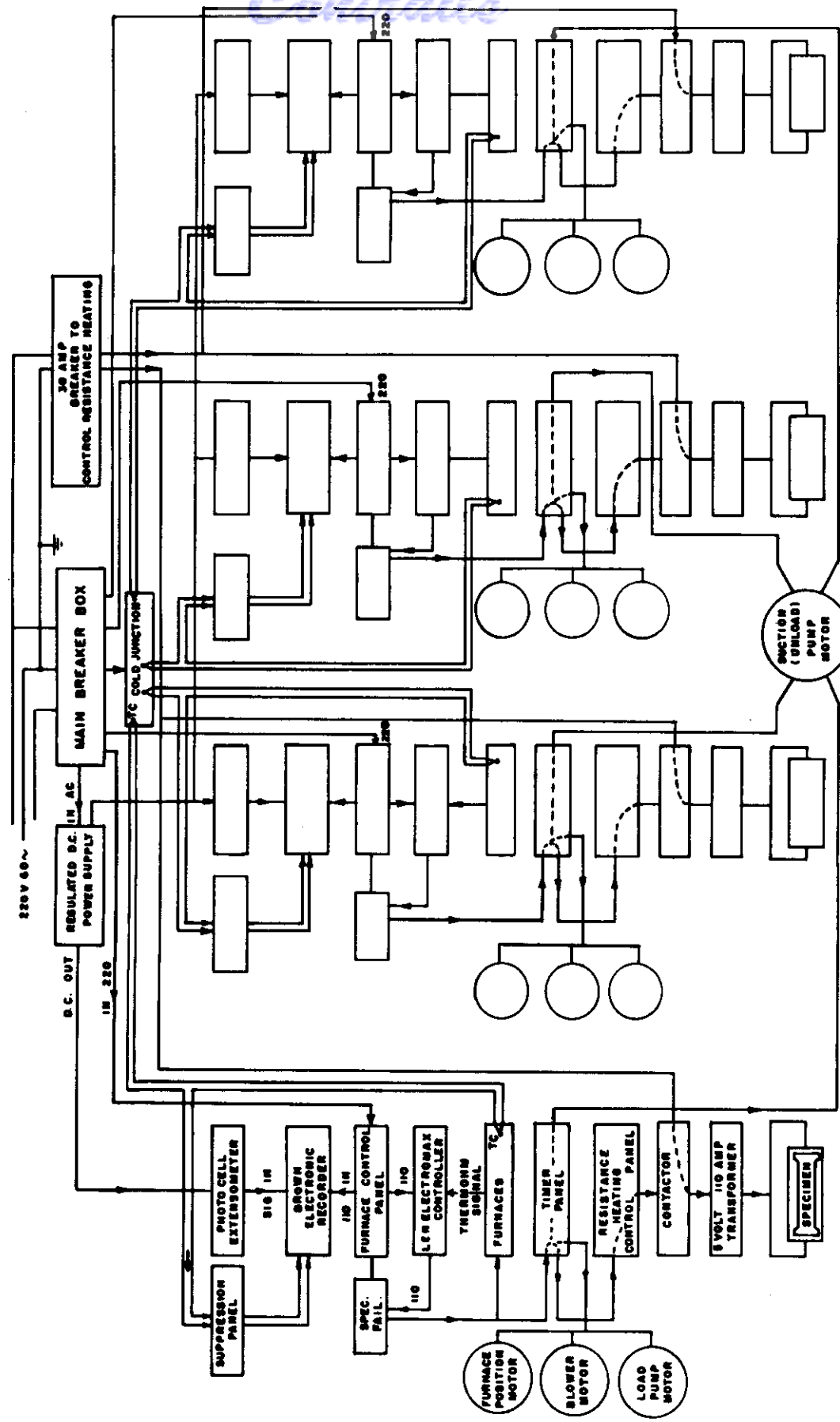

FIGURE 6 BLOCK DIAGRAM OF ELECTRICAL CONTROL SYSTEM

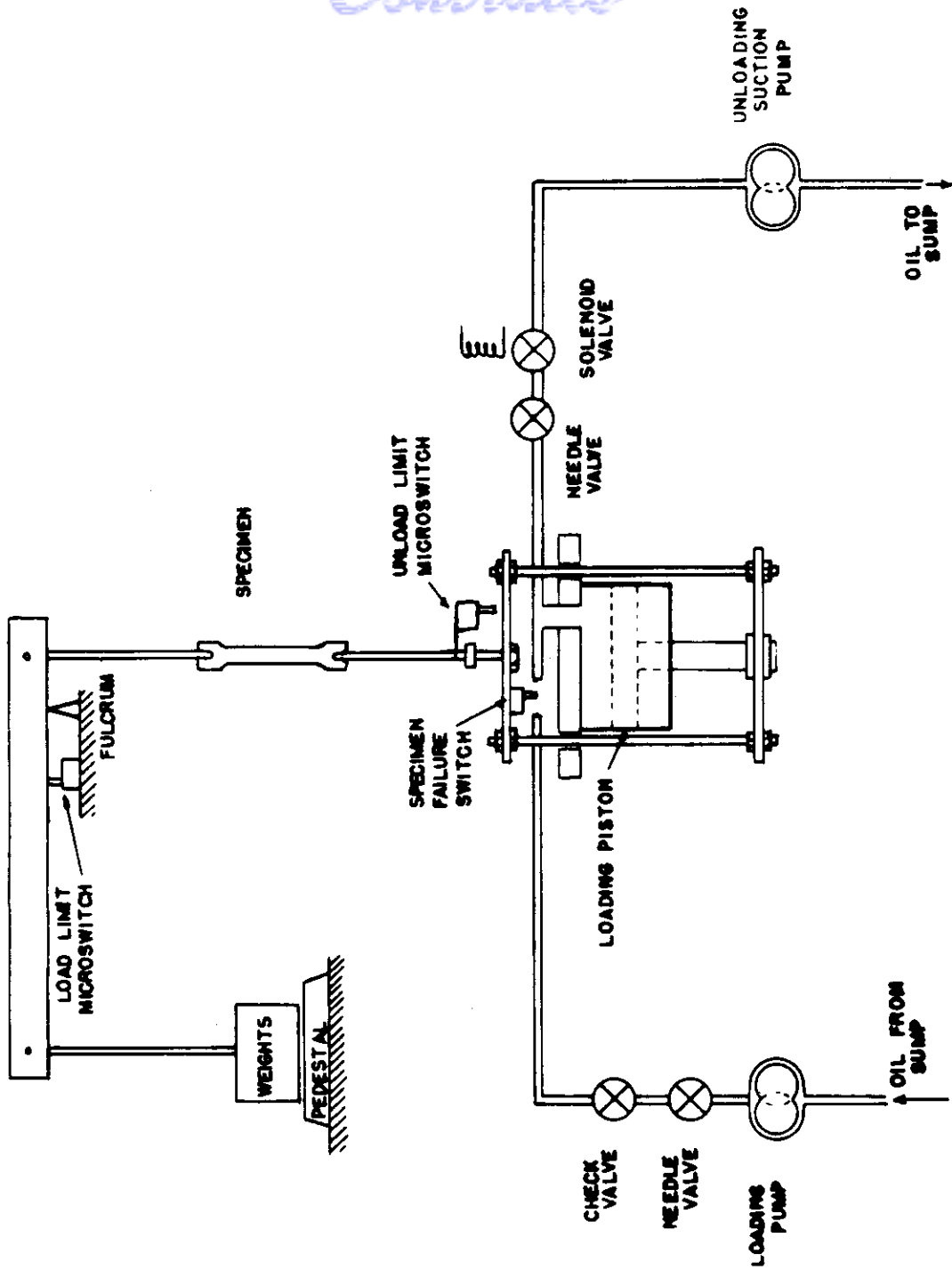

FIGURE 7 SCHEMATIC REPRESENTATION OF LOADING AND UNLOADING SYSTEM

to the gear pump motor and oil is supplied to the loading piston at a constant rate. The loading piston is forced downwards, thereby loading the specimen. The load on the specimen is increased steadily until the weights are raised from their pedestal. The pump continues to operate until the lever arm is in level position. The load limit microswitch is set to open at this point and the operation of the pump is stopped.

The rate of loading is controlled by a needle valve, and the oil pressure behind the needle valve is maintained constant by a bypass relief valve built into the pump. A check valve prevents oil from flowing back through the pump while the specimen is under load.

The lever arm is kept at level position throughout the load cycle by the action of the load limit microswitch. As the back end of the lever arm is lowered, due either to specimen strain or oil leakage, the lever closes the switch and the pump operates until the arm is brought back to the level position at which time the switch again opens.

A schematic layout of the unloading portion of the system is also shown in Fig. 7. A normally closed solenoid valve maintains a closed pressure system until unloading begins. Upon manual or automatic time clock switching, the solenoid valve opens, and simultaneously the motor driven suction pump begins operation, gradually relieving the pressure on the loading piston and drawing it upwards. The rate of flow of oil from the piston is controlled by a needle valve. As the piston is raised, the weights at the back of the lever arm are lowered to their pedestal. Unloading continues until the load on the specimen is completely relieved. At this point, the normally closed unload limit microswitch is opened, closing the solenoid valve and stopping the pump operation.

A switch located at the side of the machine enables the operator to bypass the unload limit microswitch and operate the suction pump manually. The loading piston can thus be raised to any desired position. Its purpose is to facilitate the insertion of new specimens.

A specimen failure switch connected to the loading piston stops all operations of the machine and associated controlling and recording devices after the specimen breaks.

(B) FURNACES AND TEMPERATURE CYCLING:

The nichrome wound resistance type furnaces used in this investigation differ from those ordinarily encountered in creep apparatus in that they are made in two halves, split horizontally as shown in Fig. 3. In operation, the furnace halves are brought together to heat the specimen, or separated to facilitate specimen cooling. Each half contains two separate windings with individually variable power supplies. Furnace calibrations made over the extended specimen length demonstrate that temperature uniformity within one degree Fahrenheit is readily obtainable under steady state conditions.

The temperature of each furnace is controlled by an a-c resistance bridge type controller into which is incorporated adjustable heat impulse rate and proportioning band circuits. The temperature sensing element is a platinum resistance thermometer located near the furnace liner in the upper furnace.

The furnaces are mounted on a pair of motor driven lead screws which were designed with a reciprocating thread so that the furnaces may be brought together or separated with the motor driving continuously in the same direction. Limit switches automatically stop the driving motor when the furnaces reach the open or closed positions.

Contrails

To obtain the high test temperature with the rapidity required for temperature cycling, auxiliary electrical resistance heat is supplied to supplement the furnace heat for a limited time at the start of the high temperature portion of the cycle by passing a high current at low voltage directly through the specimen. A schematic representation of the circuitry for direct electrical resistance heating is shown in Figure 8. The current is supplied by 5 volt, 115 amp transformer mounted on the machine frame, and controlled by paralleled 18 ohm cone heaters in series with the primary of the transformer. The current is brought through heavy leads to the stainless steel pulling tabs which carry it up into the furnace to the specimen. Heating at almost any desired rate is thus made possible.

Electrical resistance heating starts as the furnaces close, and is discontinued by a switch on the timer at a fixed time after the start of the heating cycle. This period of time is chosen so as to bring the specimen within about ten degrees of test temperature by resistance heat. Rate of resistance heating is controlled by adjusting the primary current in the transformer, to bring the specimen to temperature in about two-thirds the time allotted for specimen heating. The time to resistance heat a specimen to a fixed temperature has been shown by repeated testing to remain relatively constant from the start of loading to specimen failure, practically independent of the strain.

The procedure for temperature cycling is then as follows: With the specimen at room temperature, the furnaces are open, though maintained at test temperature. A continuous stream of cooling air is supplied to the specimen surfaces from either side by the blowers located on the frame of the machine.

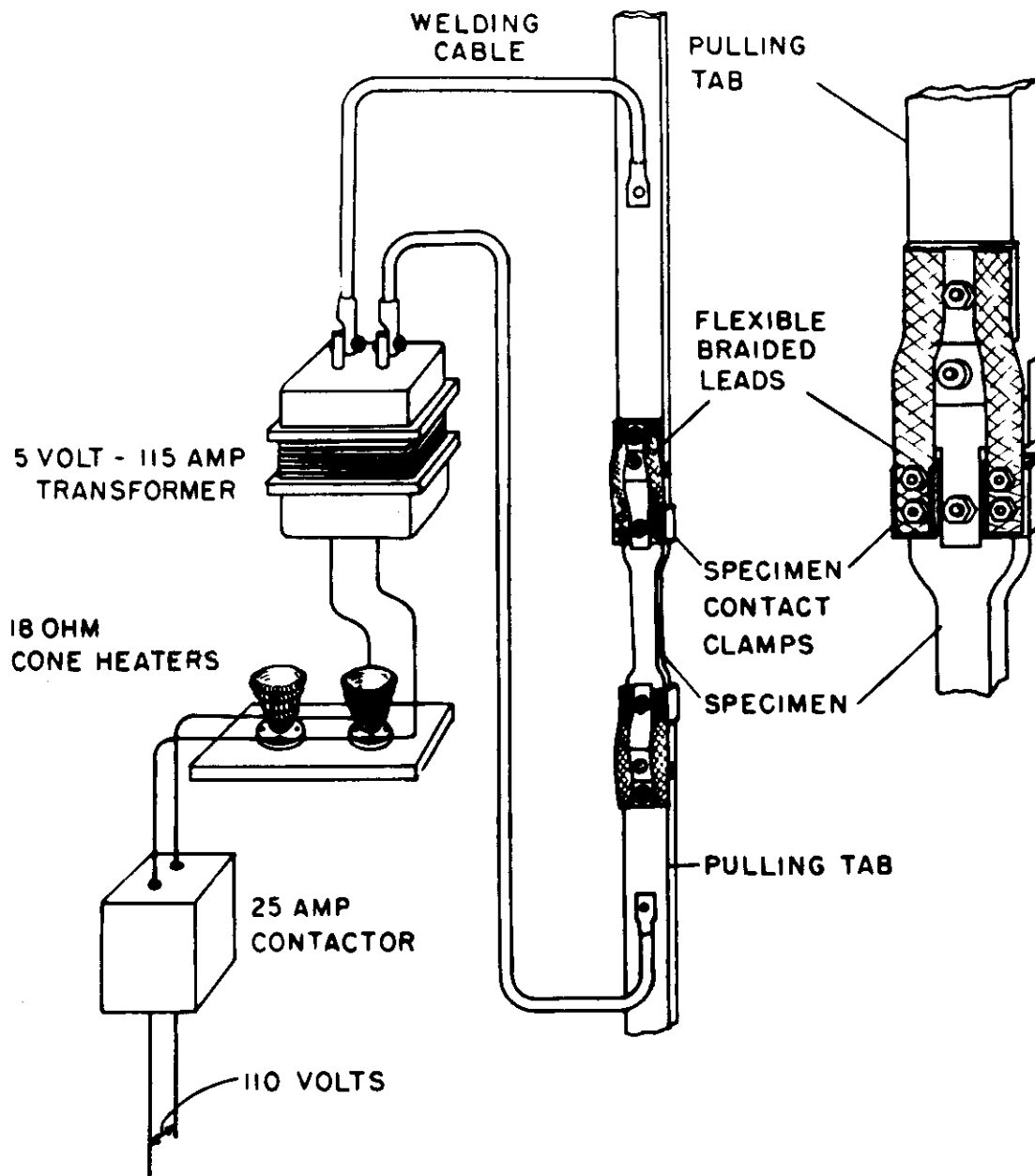

**FIG.8 SCHEMATIC REPRESENTATION OF CIRCUITRY FOR
FOR DIRECT ELECTRICAL RESISTANCE HEATING
OF THE CREEP SPECIMEN**

Control

When specimen heating is called for, on automatic switching, the furnace motor is actuated to bring the furnaces together, and the blowers are turned off. At the same moment, the 25 amp contactor is closed, supplying current to the transformer, and electrical resistance heat to the specimen. After the appropriate period of time, a second switch on the timer opens the 25 amp relay, stopping the resistance heating and allowing the specimen to approach furnace temperature at a more gradual rate.

When the timer calls for cooling of the specimen to room temperature, the furnaces separate, and the blowers play a stream of cool air on the specimen. The blowers operate throughout the room temperature portion of the cycle.

(C) SPECIMEN DESIGN:

The specimen type used in almost all of the tests in this program shown in Fig. 9, is of the conventional design used at the University of California, being seven inches long overall, with a three and one half inch long reduced section, one half inch wide, one inch radius curves to the shoulders, and one inch wide shoulders.* Extensometer clamps are applied to the reduced section of the specimen in a jig at a spacing of two inches before mounting the specimen in the furnace.

* A tandem type specimen design which was discussed in WADC TR 52-101, Part 1 of this project was used in the earlier tests, but was found unsuited to our needs. Though creep data obtained from testing this type of specimen is valid through the secondary range, apparent creep in the third stage is dependent on which section, short or long, begins its rapid straining first. As much of the data desired lay in the region of tertiary creep, use of this type of specimen was given up.

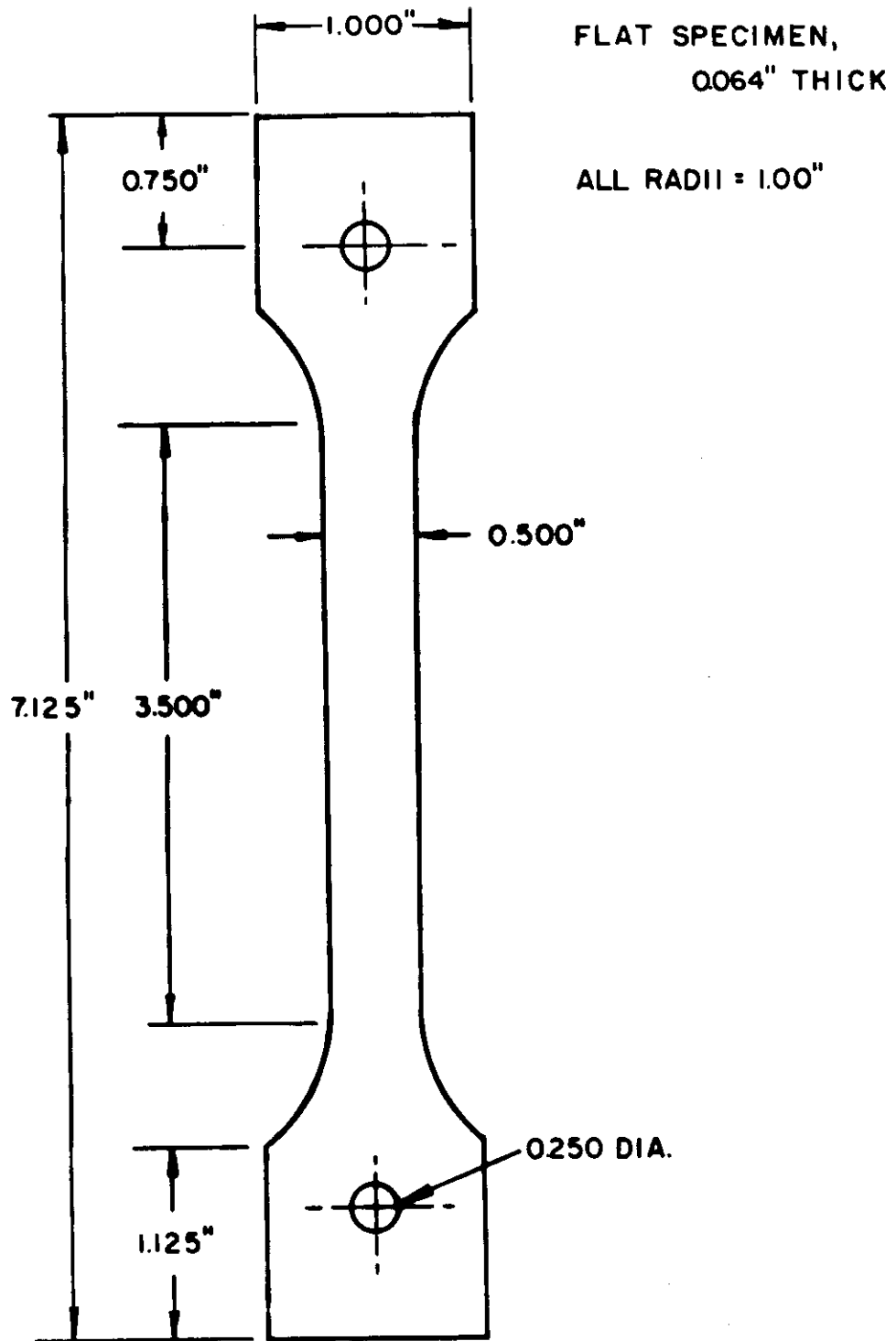

FIG. 9 DESIGN OF CREEP TEST SPECIMEN
WADC TR 52-101 Pt 2 18

(D) AUTOMATIC RECORDING APPARATUS:

Temperatures at the upper and lower specimen gage points as well as the specimen elongation are recorded continuously and automatically by a twelve point self-balancing potentiometric recorder. The recorder circuit was revised to increase the sensitivity of the detecting and balancing systems, and to permit simultaneous recording of both temperature and strain.

In order to obtain high accuracy in temperature recording, zero suppression circuits were introduced into the potentiometer circuit which subtract out the larger portion of the thermocouple voltage in steps of four millivolts. Thus, the width of the chart is used to record only a small part of the temperature (one hundred twenty-five degrees with the iron-constantan thermocouples being used) and specimen temperatures may be read with ease to an accuracy of one degree fahrenheit.

Each recorder is provided with two such suppression circuits to permit the recording of temperatures in the vicinities of both the test temperature and room temperature. During the automatic temperature cycling, a switching relay connects one circuit as the furnaces close and the specimen heats, and the other as the furnaces open. A complete and accurate record of temperature during cycling is thus obtained.

A small, thermostatically controlled heater in an aluminum block serves as the thermocouple cold junction. The couples are set in wells in the block, and accurately maintained at a constant temperature well above the ambient atmospheric temperatures ordinarily encountered.

The strain measuring device adopted for use in these tests to produce a recordable strain measure is shown photographically in Fig. 2 and schematically in Fig. 10. It consists, basically, of two ruled glass

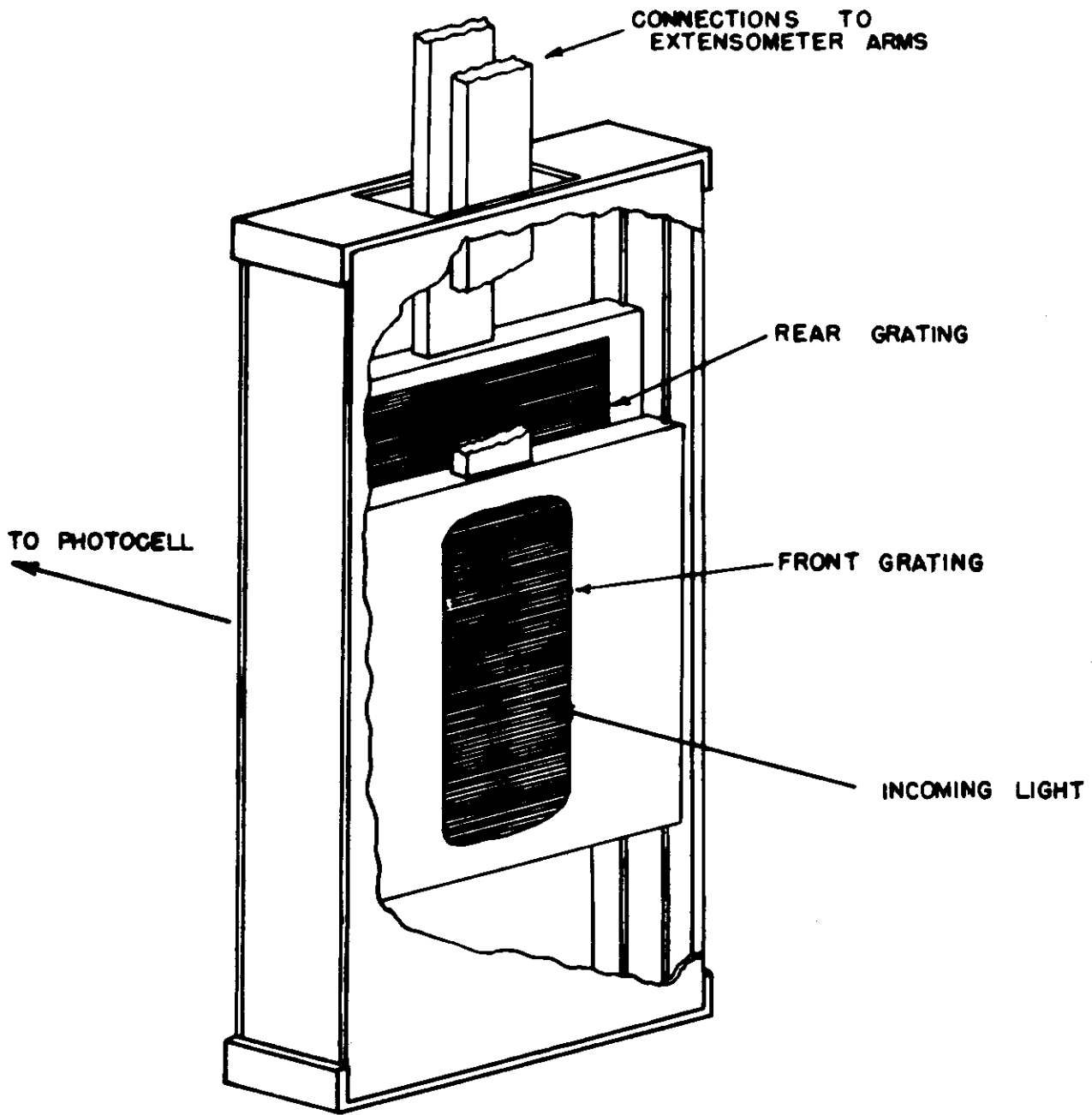

FIG. 10 DETAIL OF GRATING ARRANGEMENT FOR
STRAIN RECORDING

Continued

gratings which are displaced parallel to one another as the specimen strains. The gratings are attached by the extensometer arms to either end of the specimen gage length. The lines and spaces on the gratings are of equal width, each being five thousandths of an inch. Light passing through the gratings is caused to vary periodically in intensity, from maximum brightness when the lines on the two gratings are superimposed upon each other, to maximum darkness when the lines of one grating are opposite the spaces on the other, as the specimen strains. This periodic intensity variation is registered on a photocell, the output of which is fed to the twelve point recorder. The resulting strain record appears as an angular wave, with elongations of five thousandths of an inch magnified to the width of the chart.

The advantage of this method of recording is immediately apparent. Instead of limiting the entire strain record to the width of the chart, a folded record, such as this apparatus in effect produces, permits the recording of large strains to good accuracy. Furthermore, calibration of the devices over the entire expected strain range is not necessary, as the sensitivity remains constant regardless of the strain. An example of the strain record produced in this way is shown in Fig. 11.

DISCUSSION OF OVERALL OPERATION

The automatic operations of the loading and unloading mechanisms, and the heating and cooling mechanisms which are discussed in Sections A and B are controlled by a single sequence timer. Intermittent loading and intermittent heating operations may be performed simultaneously in any desired phase relationship by appropriate settings of the timer cams which control the separate functions.

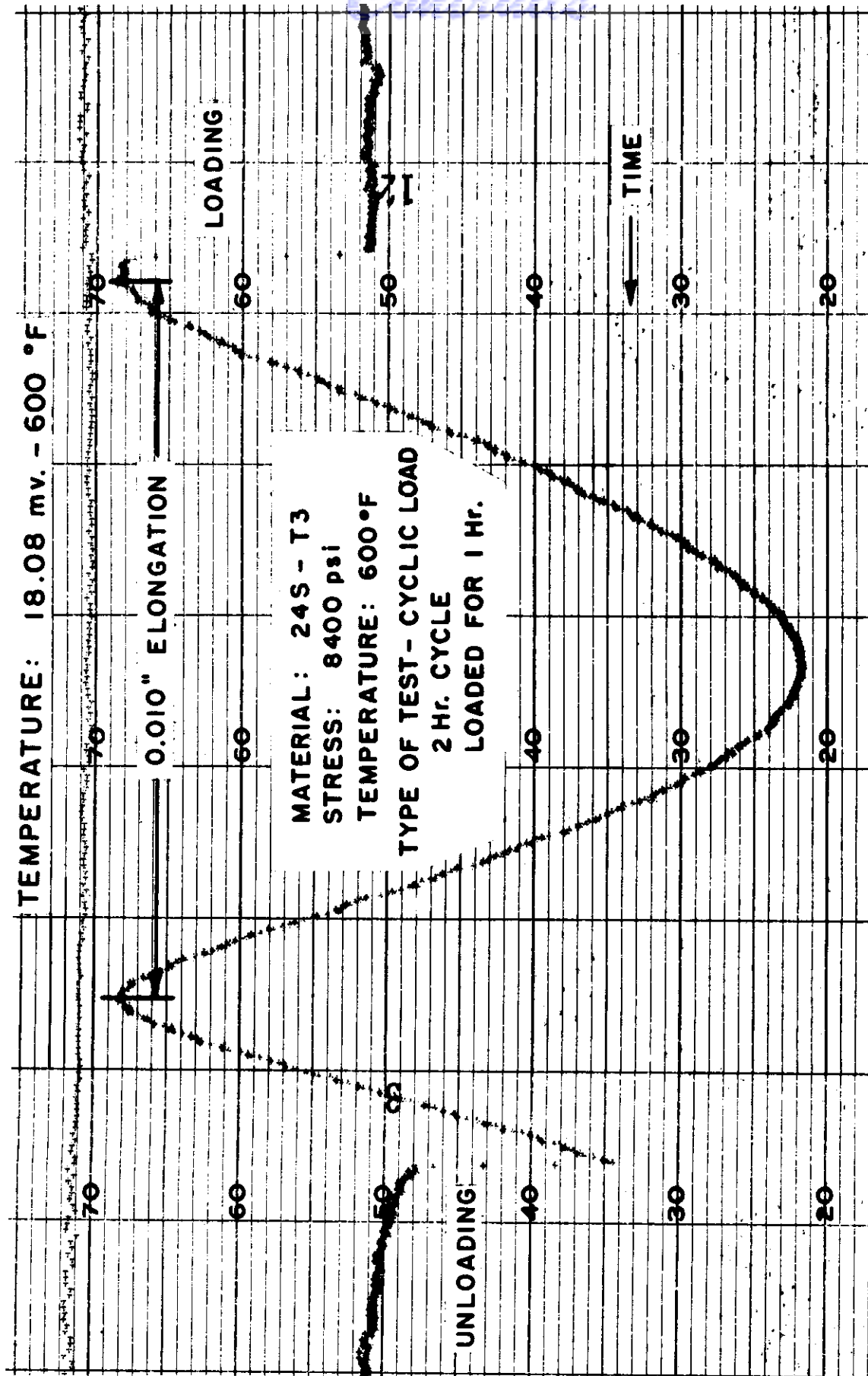

FIG. II. A SECTION OF A STRAIN AND TEMPERATURE RECORD FOR CYCLIC LOADING.

Contrails

Testing with the intermittent load and temperature creep machines is not appreciably more difficult than with ordinary creep equipment despite their apparent complexity. Mechanically, the machines function simply and well as long as they are periodically properly oiled and greased. The electronic portion of the operation requires both understanding and surveillance, as might be expected in view of the many factors that are controlled. However, once a test program has been established, its contribution has been shown in practice to be consistent and satisfactory.

SUMMARY

Design and operation of equipment for the creep testing of aircraft metals under conditions of intermittent loading and heating cycles is described in the report.

Considerable attention is given to innovations introduced into the design to assure smooth and steady operation as well as even, uniform change from one test condition to the next.

Details of a method for continuous and accurate strain recording used in these tests are given.