

WADC TECHNICAL REPORT 58-365
ASTIA DOCUMENT NO. 206075

**DETERMINATION OF TENSILE, COMPRESSIVE, BEARING
AND SHEAR PROPERTIES OF SHEET STEELS
AT ELEVATED TEMPERATURES**

**J. ROBERT KATTUS
JAMES B. PRESTON
HERMAN L. LESSLEY**

SOUTHERN RESEARCH INSTITUTE

NOVEMBER 1958

**MATERIALS LABORATORY
CONTRACT No. AF 33(616)-3876
PROJECT No. 7360**

**WRIGHT AIR DEVELOPMENT CENTER
AIR RESEARCH AND DEVELOPMENT COMMAND
UNITED STATES AIR FORCE
WRIGHT-PATTERSON AIR FORCE BASE, OHIO**

McGregor & Werner Midwest Corp., Dayton, O.
15-367-500-1-20-59

FOREWORD

This report was prepared by Southern Research Institute under USAF Contract No. AF 33(616)-3876. This contract was initiated under Project No. 7360, "Materials Analysis and Evaluation Techniques," Task No. 73605, "Design Data for Metals". It was administered under the direction of the Materials Laboratory, Directorate of Laboratories, Wright Air Development Center, with Mr. A. Brisbane acting as project engineer.

This report covers work conducted from January 1957 to May 1958.

In addition to the authors, the following men contributed to the project:

1. F. R. O'Brien
2. J. B. Rittenberry
3. E. R. Rohrbach
4. S. L. Englebert
5. Page Farmer

ABSTRACT

The tensile, compressive, bearing, and shear properties of the following sheet metals were determined at various temperatures after exposure times of from 1/2 hour to 1000 hours at the test temperature:

1. A-236 austenitic alloy, quenched and tempered
2. 17-7 PH stainless steel, RH 950 condition
3. Thermold J alloy steel, quenched and tempered
4. Type 420 stainless steel, quenched and tempered
5. Type 422 stainless steel, quenched and tempered
6. 17-22 A (S) alloy steel, quenched and tempered

The A-286 alloy was tested over a temperature range from 75° F to 1200° F, the Thermold J from 75° F to 1100° F, and the other alloys from 75° F to 1000° F.

In all of the test alloys, the strength properties and moduli of elasticity decreased with increasing temperatures. The strength properties of the Thermold J, Type 420, Type 422, and 17-22 A (S) tended to decrease by varying amounts with increasing exposure times at the higher test temperatures. These decreases in strength are believed to be associated with structural changes produced by tempering. At lower temperatures, the properties of these materials did not vary significantly with exposure time, indicating that the structures were stable at those temperatures. The strength properties of the A-286 alloy and the 17-7 PH (RH 950) stainless varied somewhat erratically with increasing exposure times at the higher test temperatures as a result, probably, of aging phenomena in both of these precipitation-hardening alloys.

The simple ratio relationships between various properties under equivalent test conditions were approximately equal in magnitude and in consistency to those previously determined for other materials and reported in WADC Technical Report 56-340. For the entire ranges of materials and conditions used in this work, the consistency of the various property relationships ranged from + 17% to + 71%. Precise data on the mechanical properties of aircraft-structural materials can be obtained only by testing under the desired condition.

PUBLICATION REVIEW

This report has been reviewed and is approved.

FOR THE COMMANDER:



RICHARD R. KENNEDY
Chief, Metals Branch
Materials Laboratory

TABLE OF CONTENTS

<u>Section</u>	<u>Page</u>
I. INTRODUCTION.....	1
1.1 Purpose of the Program.....	1
1.2 History of the Test Program.....	1
II. SCOPE.....	2
2.1 Test Materials.....	2
2.2 Test Conditions.....	2
2.3 Properties Measured.....	5
III. PREPARATION OF TEST SPECIMENS.....	7
IV. TESTING EQUIPMENT.....	9
4.1 Compression Test Fixture.....	9
4.2 Tensile Test Fixture.....	11
4.3 Bearing Test Fixture.....	11
4.4 Shear Test Fixture.....	16
4.5 Extensometers.....	16
4.6 Stress-Strain Recorder.....	21
4.7 Test Furnace.....	22
4.8 Temperature Control System.....	24
V. CALIBRATIONS AND ACCURACY.....	24
5.1 Load.....	24
5.2 Bearing and Postyield Tensile Extensometers.....	24
5.3 Preyield Tensile and Compressive Extensometers.....	25
5.4 Tensile Elongation.....	28
5.5 Temperature Measurement.....	28
VI. TEST PROCEDURE.....	28
VII. TEST RESULTS.....	33
7.1 A-286 Alloy Sheet, Quenched and Tempered.....	34
7.2 17-7 PH Stainless Steel Sheet, RH 950 Condition... Tempered.....	35
7.3 Thermold J Alloy Steel Sheet, Quenched and Tempered.....	36
7.4 Type 420 Stainless Steel Sheet, Quenched and Tempered.....	38
7.5 Type 422 Stainless Steel Sheet, Quenched and Tempered.....	39
7.6 17-22 A (S) Alloy Steel Sheet, Quenched and Tempered.....	40

TABLE OF CONTENTS (Continued)

<u>Section</u>	<u>Page</u>
VIII. DISCUSSION.....	41
IX. CONCLUSIONS	46
BIBLIOGRAPHY.....	48
X. FIGURES AND TABLES OF TEST RESULTS.....	49
10.1 A-286 Alloy Sheet, Quenched and Tempered.....	49
10.2 17-7 PH Stainless Steel Sheet, RH 950 Condition .	85
10.3 Thermold J Alloy Steel Sheet, Quenched and Tempered.....	116
10.4 Type 420 Stainless Steel Sheet, Quenched and Tempered.....	153
10.5 Type 422 Stainless Steel Sheet, Quenched and Tempered.....	188
10.6 17-22 A (S) Alloy Steel Sheet, Quenched and Tempered.....	222
10.7 Comparative Figures and Tables	257

LIST OF ILLUSTRATIONS

<u>Figure No.</u>		<u>Page</u>
1	Dimensions of test specimens.....	8
2	Compression test fixture	10
3	Compression test fixtures in position in the test furnace ..	12
4	Tensile test apparatus	13
5	Bearing test apparatus	14
6	Diagram of bearing test specimen assembled to pull rods showing method of extensometer attachment	15
7	Shear test fixture	17
8	Strain-gage transducers and transducer mounts for tensile and compression extensometer	19
9	Postyield extensometer	20
10	Test apparatus showing position of the test furnace for the tensile, bearing, and shear tests.....	23
11	Setup for checking accuracy, reproducibility, and linearity of preyield tensile and compressive extensometer	26
12	Calibrating device.....	27
13	Tensile test specimen showing location of thermocouples and corresponding temperature-distribution survey	29
14	Shear specimen set in test fixture showing location of thermocouples and corresponding temperatures during temperature-distribution survey	30
15	Bearing test specimen showing location of thermocouples and corresponding temperatures during temperature-distribution survey	31

LIST OF ILLUSTRATIONS (Continued)

<u>Figure No.</u>		<u>Page</u>
16	Compression-test specimen showing location of thermocouples and corresponding temperature during temperature-distribution survey.....	32
17	Effect of exposure time on the ultimate tensile strength and ultimate shear strength of quenched and tempered A-286 austenitic alloy at different temperatures.....	50
18	Effect of exposure time on the tensile and compressive yield strength of quenched and tempered A-286 austenitic alloy sheet at different temperatures.....	51
19	Effect of exposure time on the tensile and compressive moduli of elasticity and percent elongation of quenched and tempered A-286 austenitic alloy sheet at different temperatures.....	52
20	Effect of exposure time on the tensile rupture strength of quenched and tempered A-286 austenitic alloy sheet at different temperatures.....	53
21	Effect of exposure time on the bearing ultimate and yield strengths of quenched and tempered A-286 austenitic alloy sheet at different temperatures.....	54
22	Elevated temperature strength properties as percent room-temperature properties for quenched and tempered A-286 austenitic alloy sheet at different exposure times.....	55
23	Elevated-temperature properties as percent room-temperature properties for quenched and tempered A-286 austenitic alloy sheet at different exposure times.....	56
24	Elevated temperature strength properties as percent room-temperature properties for quenched and tempered A-286 austenitic alloy sheet at different exposure times.....	57
25	Tensile stress-strain curves for quenched and tempered A-286 austenitic alloy sheet at various temperatures and exposure times	58

LIST OF ILLUSTRATIONS (Continued)

Figure No.

Page

26	Tensile postyield stress-strain curves for quenched and tempered A-286 austenitic alloy sheet at various temperatures and exposure times.....	59
27	Tensile postyield stress-strain curves for quenched and tempered A-286 austenitic alloy sheet at various temperatures and exposure times.....	60
28	Tensile postyield stress-strain curves for quenched and tempered A-286 austenitic alloy sheet at various temperatures and exposure times.....	61
29	Compressive stress-strain curves for quenched and tempered A-286 austenitic alloy sheet at various temperatures and exposure times.....	62
30	Bearing stress-deformation curves for quenched and tempered A-286 austenitic alloy sheet at various temperatures and one-half-hour exposure time.....	63
31	Bearing stress-deformation curves for quenched and tempered A-286 austenitic alloy sheet at various temperatures and ten-hour exposure time.....	64
32	Bearing stress-deformation curves for quenched and tempered A-286 austenitic alloy sheet at various temperatures and one-hundred-hour exposure time.....	65
33	Bearing stress-deformation curves for quenched and tempered A-286 austenitic alloy sheet at various temperatures and one-thousand-hour exposure time.....	66
34	Tangent-modulus vs. compressive-stress curves for quenched and tempered A-286 austenitic alloy sheet at 75° F and 600° F and different exposure times.....	67
35	Tangent-modulus vs. compressive-stress curves for quenched and tempered A-286 austenitic alloy sheet at 800° and 1000° and different exposure times.....	68
36	Tangent-modulus vs. compressive-stress curves for quenched and tempered A-286 austenitic alloy sheet at 1100° and 1200° and different exposure times.....	69

LIST OF ILLUSTRATIONS(Continued)

<u>Figure No.</u>		<u>Page</u>
37	Effect of exposure time on the ultimate tensile strength and ultimate shear strength of 17-7 PH stainless steel (RH 950 condition) at different temperatures.....	86
38	Effect of exposure time on the tensile and compressive yield strength of 17-7 PH stainless steel sheet (RH 950 condition) at different temperatures.....	87
39	Effect of exposure time on the tensile and compressive moduli of elasticity and percent elongation of 17-7 PH stainless steel sheet (RH 950 condition) at different temperatures.....	88
40	Effect of exposure time on the tensile rupture strength of 17-7 PH stainless steel sheet (RH 950 condition) at different temperatures.....	89
41	Effect of exposure time on the ultimate bearing strength of 17-7 PH stainless steel sheet (RH 950 condition) at different temperatures.....	90
42	Effect of exposure time on the bearing yield strength of 17-7 PH stainless steel sheet (RH 950 condition) at different temperatures.....	91
43	Elevated-temperature strength properties as percent room-temperature properties for 17-7 PH stainless steel sheet (RH 950 condition) at different exposure times.....	92
44	Elevated-temperature properties as percent room-temperature properties for 17-7 PH stainless steel sheet (RH 950 condition) at different exposure times.....	93
45	Elevated-temperature strength properties as percent room-temperature properties for 17-7 PH stainless steel sheet (RH 950 condition) at different exposure times.....	94
46	Elevated-temperature strength properties as percent room-temperature properties for 17-7 PH stainless steel sheet (RH 950 condition) at different exposure times.....	95

LIST OF ILLUSTRATIONS (Continued)

<u>Figure No.</u>		<u>Page</u>
47	Tensile stress-strain curves for 17-7 PH stainless steel sheet (RH 950 condition) at various temperatures and exposure times.....	96
48	Tensile postyield stress-strain curves for 17-7 PH stainless steel sheet (RH 950 condition) at various temperatures and exposure times.....	97
49	Tensile postyield stress-strain curves for 17-7 PH stainless steel sheet (RH 950 condition) at various temperatures and exposure times.....	98
50	Compressive stress-strain curves for 17-7 PH stainless steel sheet (RH 950 condition) at various temperatures and exposure times.....	99
51	Bearing stress-deformation curves for 17-7 PH stainless steel sheet (RH 950 condition) at various temperatures and one-half-hour exposure times.....	100
52	Bearing stress-deformation curves for 17-7 PH stainless steel sheet (RH 950 condition) at various temperatures and ten-hour exposure time.....	101
53	Bearing stress-deformation curves for 17-7 PH stainless steel sheet (RH 950 condition) at various temperatures and one-hundred-hour exposure time.....	102
54	Bearing stress-deformation curves for 17-7 PH stainless steel sheet (RH 950 condition) at various temperatures and one-thousand-hour exposure time.....	103
55	Tangent-modulus vs. compressive-stress curves for 17-7 PH stainless steel sheet (RH 950 condition) at 75° F and 600° F and different exposure times.....	104
56	Tangent-modulus vs. compressive-stress curves for 17-7 PH stainless steel sheet (RH 950 condition) at 800° F and 1000° F and different exposure times.....	105

LIST OF ILLUSTRATIONS (Continued)

<u>Figure No.</u>		<u>Page</u>
57	Effect of exposure time on the ultimate tensile strength and ultimate shear strength of quenched and tempered Thermold J alloy steel at different temperatures.....	117
58	Effect of exposure time on the tensile and compressive yield strength of quenched and tempered Thermold J alloy steel sheet at different temperatures.....	118
59	Effect of exposure time on the tensile and compressive moduli of elasticity and percent elongation of quenched and tempered Thermold J alloy steel sheet at different temperatures.....	119
60	Effect of exposure time on the tensile rupture strength of quenched and tempered Thermold J alloy steel sheet at different temperatures.....	120
61	Effect of exposure time on the bearing ultimate and yield strengths of quenched and tempered Thermold J alloy steel sheet at different temperatures.....	121
62	Elevated-temperature strength properties as percent room-temperature properties for quenched and tempered Thermold J alloy steel sheet at different exposure times.....	122
63	Elevated-temperature properties as percent room-temperature properties for quenched and tempered Thermold J alloy steel sheet at different exposure times.....	123
64	Elevated-temperature strength properties as percent room-temperature properties for quenched and tempered Thermold J alloy steel sheet at different exposure times.....	124
65	Elevated-temperature strength properties as percent room-temperature properties for quench and tempered Thermold J alloy steel sheet at different exposure times.....	125
66	Tensile stress-strain curves for quenched and tempered Thermold J alloy steel sheet at various temperatures and exposure times.....	126
67	Tensile postyield stress-strain curves for quenched and tempered Thermold J alloy steel sheet at various temperatures and exposure times.....	127

LIST OF ILLUSTRATIONS (Continued)

<u>Figure No.</u>		<u>Page</u>
68	Tensile postyield stress-strain curves for quenched and tempered Thermold J alloy steel sheet at various temperatures and exposure times.....	128
69	Tensile postyield stress-strain curves for quenched and tempered Thermold J alloy steel sheet at various temperatures and exposure times.....	129
70	Compressive stress-strain curves for quenched and tempered Thermold J alloy steel sheet at various temperatures and exposure times.....	130
71	Compressive stress-strain curves for quenched and tempered Thermold J alloy steel sheet at various temperatures and exposure times.....	131
72	Bearing stress-deformation curves for quenched and tempered Thermold J alloy steel sheet at various temperatures and one-half-hour exposure time.....	132
73	Bearing stress-deformation curves for quenched and tempered Thermold J alloy sheet steel at various temperatures and ten-hour exposure time.....	133
74	Bearing stress-deformation curves for quenched and tempered Thermold J alloy steel sheet at various temperatures and one-hundred-hour exposure time.....	134
75	Bearing stress-deformation curves for quenched and tempered Thermold J alloy steel sheet at various temperatures and one-thousand-hour exposure time.....	135
76	Tangent-modulus vs. compressive-stress curves for quenched and tempered Thermold J alloy steel sheet at 75° F and 600° F and different exposure times.....	136
77	Tangent-modulus vs. compressive-stress curves for quenched and tempered Thermold J alloy steel sheet at 800° F and 1000° F and different exposure times.....	137

LIST OF ILLUSTRATIONS(Continued)

<u>Figure No.</u>		<u>Page</u>
78	Tangent-modulus vs. compressive-stress curves for quenched and tempered Thermold J alloy steel sheet at 1100° F and different exposure times.....	138
79	Effect of exposure time on the ultimate tensile strength and ultimate shear strength of quenched and tempered Type 420 stainless steel at different temperatures.....	154
80	Effect of exposure time on the tensile and compressive yield strength of quenched and tempered Type 420 stainless steel sheet at different temperatures.....	155
81	Effect of exposure time on the tensile and compressive moduli of elasticity and percent elongation of quenched and tempered Type 420 stainless steel sheet at different temperatures.....	156
82	Effect of exposure time on the tensile rupture strength of quenched and tempered Type 420 stainless steel sheet at different temperatures.....	157
83	Effect of exposure time on the bearing ultimate and yield strengths of quenched and tempered Type 420 stainless steel sheet at different temperatures.....	158
84	Elevated-temperature strength properties as percent room-temperature properties for quenched and tempered Type 420 stainless steel sheet at different exposure times.	159
85	Elevated-temperature properties as percent room-temperature properties for quenched and tempered Type 420 stainless steel sheet at different exposure times.....	160
86	Elevated-temperature strength properties as percent room-temperature properties for quenched and tempered Type 420 stainless steel sheet at different exposure times.....	161

LIST OF ILLUSTRATIONS (Continued)

<u>Figure No.</u>		<u>Page</u>
87	Elevated-temperature strength properties as percent room-temperature properties for quenched and tempered Type 420 stainless steel sheet at different exposure times.....	162
88	Tensile stress-strain curves for quenched and tempered Type 420 stainless steel sheet at various temperatures and exposure times.....	163
89	Tensile postyield stress-strain curves for quenched and tempered Type 420 stainless steel sheet at various temperatures and exposure times.....	164
90	Tensile postyield stress-strain curves for quenched and tempered Type 420 stainless steel sheet at various temperatures and exposure times.....	165
91	Compressive stress-strain curves for quenched and tempered Type 420 stainless steel sheet at various temperatures and exposure times.....	166
92	Bearing stress-deformation curves for quenched and tempered Type 420 stainless steel sheet at various temperatures and one-half-hour exposure time.....	167
93	Bearing stress-deformation curves for quenched and tempered Type 420 stainless steel sheet at various temperatures and ten-hour exposure time.....	168
94	Bearing stress-deformation curves for quenched and tempered Type 420 stainless steel sheet at various temperatures and one-hundred-hour exposure time.....	169
95	Bearing stress-deformation curves for quenched and tempered Type 420 stainless steel sheet at various temperatures and one-thousand-hour exposure time.....	170
96	Tangent-modulus vs. compressive-stress curves for quenched and tempered Type 420 stainless steel sheet at 75° F and 400° F and different exposure times.....	171

LIST OF ILLUSTRATIONS (Continued)

<u>Figure No.</u>		<u>Page</u>
97	Tangent-modulus vs. compressive-stress curves for quenched and tempered Type 420 stainless steel sheet at 600° F and 800° F and different exposure times.....	172
98	Tangent-modulus vs. compressive-stress curves for quenched and tempered Type 420 stainless steel sheet at 1000° F and different exposure times.....	173
99	Effect of exposure time on the ultimate tensile strength and ultimate shear strength of quenched and tempered Type 422 stainless steel at different temperatures.....	189
100	Effect of exposure time on the tensile and compressive yield strength of quenched and tempered Type 422 stainless steel sheet at different temperatures.....	190
101	Effect of exposure time on the tensile and compressive moduli of elasticity and percent elongation of quenched and tempered Type 422 stainless steel sheet at different temperatures.....	191
102	Effect of exposure time on the tensile rupture strength of quenched and tempered Type 422 stainless steel sheet at different temperatures.....	192
103	Effect of exposure time on the bearing ultimate and yield strengths of quenched and tempered Type 422 stainless steel sheet at different temperatures.....	193
104	Elevated-temperature strength properties as percent room-temperature properties for quenched and tempered Type 422 stainless steel sheet at different exposure times.	194
105	Elevated temperature properties as percent room-temperature properties for quenched and tempered Type 422 stainless steel sheet at different exposure times.....	195
106	Elevated-temperature properties as percent room-temperature properties for quenched and tempered Type 422 stainless steel sheet at different exposure times.....	196

LIST OF ILLUSTRATIONS (Continued)

<u>Figure No.</u>		<u>Page</u>
107	Tensile stress-strain curves for quenched and tempered Type 422 stainless steel sheet at various temperatures and exposure times.....	197
108	Tensile postyield stress-strain curves for quenched and tempered Type 422 stainless steel sheet at various temperatures and exposure times.....	198
109	Tensile postyield stress-strain curves for quenched and tempered Type 422 stainless steel sheet at various temperatures and exposure times.....	199
110	Compressive stress-strain curves for quenched and tempered Type 422 stainless steel sheet at various temperatures and exposure times.....	200
111	Bearing stress-deformation curves for quenched and tempered Type 422 stainless steel sheet at various temperatures and one-half-hour exposure time.....	201
112	Bearing stress-deformation curves for quenched and tempered Type 422 stainless steel sheet at various temperatures and ten-hour exposure time.....	202
113	Bearing stress-deformation curves for quenched and tempered Type 422 stainless steel sheet at various temperatures and one-hundred-hour exposure time.....	203
114	Bearing stress-deformation curves for quenched and tempered Type 422 stainless steel sheet at various temperatures and one-thousand-hour exposure time.....	204
115	Tangent-modulus vs. compressive-stress curves for quenched and tempered Type 422 stainless steel sheet at 75° F and 400° F and different exposure times.....	205
116	Tangent-modulus vs. compressive-stress curves for quenched and tempered Type 422 stainless steel sheet at 600° F and 800° F and different exposure times.....	206
117	Tangent-modulus vs. compressive-stress curves for quenched and tempered Type 422 stainless steel sheet at 1000° F and different exposure times.....	207

LIST OF ILLUSTRATIONS (Continued)

Figure No.

Page

118	Effect of exposure time on the ultimate tensile strength and ultimate shear strength of quenched and tempered 17-22 A (S) alloy steel at different temperatures.....	223
119	Effect of exposure time on the tensile and compressive yield strength of quenched and tempered 17-22 A (S) alloy steel sheet at different temperatures.....	224
120	Effect of exposure time on the tensile and compressive moduli of elasticity and percent elongation of quenched and tempered 17-22 A (S) alloy steel sheet at different temperatures.....	225
121	Effect of exposure time on the tensile rupture strength of quenched and tempered 17-22 A (S) alloy steel sheet at different temperatures.....	226
122	Effect of exposure time on the bearing ultimate and yield strengths of quenched and tempered 17-22 A (S) alloy steel sheet at different temperatures.....	227
123	Elevated-temperature strength properties as percent room-temperature properties for quenched and tempered 17-22 A (S) alloy steel sheet at different exposure times.....	228
124	Elevated-temperature properties as percent room-temperature properties for quenched and tempered 17-22 A (S) alloy steel sheet at different exposure times.....	229
125	Elevated-temperature strength properties as percent room-temperature properties for quenched and tempered 17-22 A (S) alloy steel sheet at different exposure times.....	230
126	Elevated-temperature strength properties as percent room-temperature properties for quenched and tempered 17-22 A (S) alloy steel sheet at different exposure times...	231
127	Tensile stress-strain curves for quenched and tempered 17-22 A (S) alloy steel sheet at various temperatures and exposure times.....	232

LIST OF ILLUSTRATIONS (Continued)

<u>Figure No.</u>		<u>Page</u>
128	Tensile postyield stress-strain curves for quenched and tempered 17-22 A (S) alloy steel sheet at various temperatures and exposure times.....	233
129	Tensile postyield stress-strain curves for quenched and tempered 17-22 A (S) alloy steel sheet at various temperatures and exposure times.....	234
130	Compressive stress-strain curves for quenched and tempered 17-22 A (S) alloy steel at various temperatures and exposure times.....	235
131	Bearing stress-deformation curves for quenched and tempered 17-22 A (S) alloy steel sheet at various temperatures and one-half-hour exposure time.....	236
132	Bearing stress-deformation curves for quenched and tempered 17-22 A (S) alloy steel sheet at various temperatures and ten-hour exposure time.....	237
133	Bearing stress-deformation curves for quenched and tempered 17-22 A (S) alloy steel sheet at various temperatures and one-hundred-hour exposure time.....	238
134	Bearing stress-deformation curves for quenched and tempered 17-22 A (S) alloy steel sheet at various temperatures and one-thousand-hour exposure time.....	239
135	Tangent-modulus vs. compressive-stress curves for quenched and tempered 17-22 A (S) alloy steel sheet at 75° F and 400° F and different exposure times.....	240
136	Tangent-modulus vs. compressive-stress curves for quenched and tempered 17-22 A (S) alloy steel sheet at 600° F and 800° F and different exposure times.....	241
137	Tangent-modulus vs. compressive-stress curves for quenched and tempered 17-22 A (S) alloy steel sheet at 1000° F and different exposure times.....	242
138	Effect of temperature on the ultimate tensile strength of the test materials after exposures of 1000 hours and 0.5 hour.....	258

LIST OF ILLUSTRATIONS (Continued)

Figure No.		Page
139	Effect of temperature on the compressive yield strength of the test materials after exposures of 1000 hours and of 0.5 hour.....	259
140	Effect of temperature on six ratio relationships of properties of quenched and tempered A-286 austenitic alloy sheet.....	260
141	Effect of temperature on four ratio relationships of properties of quenched and tempered A-286 austenitic alloy sheet.....	261
142	Effect of temperature on six ratio relationships of properties of 17-7 PH (RH 950) stainless steel sheet.....	262
143	Effect of temperature on four ratio relationships of properties of 17-7 PH (RH 950) stainless steel sheet.....	263
144	Effect of temperature on six ratio relationships of properties of quenched and tempered Thermold J alloy steel sheet.....	264
145	Effect of temperature of four ratio relationships of properties of quenched and tempered Thermold J alloy steel sheet.....	265
146	Effect of Temperature on six ratio relationships of properties of quenched and tempered Type 420 stainless steel sheet.....	266
147	Effect of temperature on four ratio relationships of properties of quenched and tempered Type 420 stainless steel sheet.....	267
148	Effect of temperature on six ratio relationships of properties of quenched and tempered Type 422 stainless steel sheet.....	268
149	Effect of temperature on four ratio relationships of properties of quenched and tempered Type 422 stainless steel sheet.....	269

LIST OF ILLUSTRATIONS (Continued)

<u>Figure No.</u>		<u>Page</u>
150	Effect of temperature on six ratio relationships of properties of quenched and tempered 17-22 A (S) alloy steel sheet.....	270
151	Effect of temperature on four ratio relationships of properties of quenched and tempered 17-22 A (S) alloy steel sheet.....	271

LIST OF TABLES

<u>Table No.</u>		<u>Page</u>
1	Mechanical Properties of Test Materials Reported by Manufacturers.....	3
2	Chemical Analysis of Test Materials Reported by Manufacturers.....	4
3	Test Materials, Test Temperatures, and Exposure Times for Tensile, Compression, Bearing, and Shear Tests.....	6
4	Tensile Properties of 0.062-In. A-286 Austenitic Alloy Sheet at Different Temperatures and Holding Times.....	70
5	Tensile Strength of 3/16-In. A-286 Austenitic Alloy Plate at Different Temperatures and Holding Times..	75
6	Compressive Properties of 0.062-In. A-286 Austenitic Alloy Sheet at Different Temperatures and Holding Times.....	77
7	Shear Strength of 3/16-In. A-286 Austenitic Alloy Plate at Different Temperatures and Holding Times..	79
8	Bearing Properties of 0.062-In. A-286 Austenite Alloy Sheet at Different Temperatures and Holding Times..	81
9	Bearing Properties of 0.062-In. A-286 Austenitic Alloy Sheet at Different Temperatures and Holding Times.....	83
10	Tensile Properties of 0.062-In. 17-7 PH Stainless Steel Sheet at Different Temperatures and Holding Times.....	106
11	Tensile Strength of 3/16-In. 17-7 PH Stainless Steel Plate at Different Temperatures and Holding Times.....	109
12	Compressive Properties of 0.062-In. 17-7 PH Stainless Steel Sheet at Different Temperatures and Holding Times.....	110

LIST OF TABLES (Continued)

<u>Table No.</u>		<u>Page</u>
13	Shear Strength of 3/16-In. 17-7 PH Stainless Steel Plate at Different Temperatures and Holding Times.....	111
14	Bearing Properties of 0.062-In. 17-7 PH Stainless Steel Sheet at Different Temperatures and Holding Times.....	112
15	Bearing Properties of 0.062-In. 17-7 PH Stainless Steel Sheet at Different Temperatures and Holding Times.....	114
16	Tensile Properties of 0.062-In. Thermold J Alloy Steel Sheet at Different Temperatures and Holding Times.....	139
17	Tensile Strength of 3/16-In. Thermold J Alloy Steel Plate at Different Temperatures and Holding Times..	143
18	Compressive Properties of 0.062-In. Thermold J Alloy Steel Sheet at Different Temperatures and Holding Times.....	145
19	Shear Strength of 3/16-In. Thermold J Alloy Steel Plate at Different Temperatures and Holding Times..	147
20	Bearing Properties of 0.062-In. Thermold J Alloy Steel Sheet at Different Temperatures and Holding Times.....	149
21	Bearing Properties of 0.062-In. Thermold J Alloy Steel Sheet at Different Temperatures and Holding Times.....	151
22	Tensile Properties of 0.062-In. Type 420 Stainless Steel Sheet at Different Temperatures and Holding Times.....	174

LIST OF TABLES (Continued)

<u>Table No.</u>		<u>Page</u>
23	Tensile Strength of 3/16-In. Type 420 Stainless Steel Plate at Different Temperatures and Holding Times.....	178
24	Compressive Properties of 0.062-In. Type 420 Stainless Steel Sheet at Different Temperatures and Holding Times.....	180
25	Shear Strength of 3/16-In. Type 420 Stainless Steel Plate at Different Temperatures and Holding Times..	182
26	Bearing Properties of 0.062-In. Type 420 Stainless Steel Sheet at Different Temperatures and Holding Times.....	184
27	Bearing Properties of 0.062-In. Type 420 Stainless Steel Sheet at Different Temperatures and Holding Times.....	186
28	Tensile Properties of 0.062-In. Type 422 Stainless Steel Sheet at Different Temperatures and Holding Times.....	208
29	Tensile Strength of 3/16-In. Type 422 Stainless Steel Plate at Different Temperatures and Holding Times..	212
30	Compressive Properties of 0.062-In. Type 422 Stainless Steel Sheet at Different Temperatures and Holding Times.....	214
31	Shear Strength of 3/16-In. Type 422 Stainless Steel Plate at Different Temperatures and Holding Times.....	216
32	Bearing Properties of 0.062-In. Type 422 Stainless Steel Sheet at Different Temperatures and Holding Times	218

LIST OF TABLES (Continued)

<u>Table No.</u>		<u>Page</u>
33	Bearing Properties of 0.062-In. Type 422 Stainless Steel Sheet at Different Temperatures and Holding Times.....	220
34	Tensile Properties of 0.062-In. 17-22 A (S) Alloy Steel Sheet at Different Temperatures and Holding Times.....	243
35	Tensile Strength of 3/16-In. 17-22 A (S) Alloy Steel Plate at Different Temperatures and Holding Times	247
36	Compressive Properties of 0.062-In. 17-22 A (S) Alloy Steel Sheet at Different Temperatures and Holding Times.....	249
37	Shear Strength of 3/16-In. 17-22 A (S) Alloy Steel Plate at Different Temperatures and Holding Times.....	251
38	Bearing Properties of 0.062-In. 17-22 A (S) Alloy Steel Sheet at Different Temperatures and Holding Times.....	253
39	Bearing Properties of 0.062-In. 17-22 A (S) Alloy Steel Sheet at Different Temperatures and Holding Times.....	255
40	Ratio Relationships of Properties of Test Metals at Room Temperature.....	272
41	Maximum and Minimum Ratio Relationships of Properties of Test Metals Over Range of Temperature and Exposure Time.....	273

DETERMINATION OF TENSILE, COMPRESSIVE, BEARING
AND SHEAR PROPERTIES OF SHEET STEELS
AT ELEVATED TEMPERATURES

SECTION I. INTRODUCTION

1.1 Purpose of the Program

Many alloys at certain temperature levels are not susceptible to structural changes. Elevated-temperature properties under these conditions are determined by the magnitude of the temperature alone. Under alloying and temperature conditions that do bring about structural changes, such as precipitation and grain growth, the elevated-temperature properties of metals are functions of both temperature and time at temperature. Design data based on elevated temperature tests with the standard exposure time of 30 minutes are not necessarily applicable to aircraft parts that will be used for extended periods of time at elevated temperatures.

The purpose of this investigation was to determine the effects of exposure times up to 1000 hours at test temperature on the elevated-temperature tensile, compressive, bearing, and shear properties of six aircraft-structural sheet steels.

1.2 History of the Test Program

Under Contracts AF 33(616)-2741 and AF 33(616)-3224, Southern Research Institute has carried out a previous program on the determination of tensile, compressive, bearing, and shear properties of ferrous and non-ferrous structural sheet metals at elevated temperatures. The results of the program were reported in WADC Technical Report 56-340, which was released for publication in October 1956. The basic test equipment and methods used in this present project were developed during that first program and were described in detail in the report.

1 Manuscript released by authors Sept 1958 for publication as a WADC
Technical Report

SECTION II. SCOPE

2.1 Test Materials

The test metals and the heat-treated conditions in which they were tested were as follows:

1. A-236 austenitic age-hardening alloy—1800° F 1 hr argon atmosphere, O. Q., 1325° F 16 hr, A. C.
2. 17-7 PH stainless steel—RH 950 condition—1750° F 10 min argon atmosphere, A. C., -100° F 8 hr, 950° F 1 hr, A. C.
3. Thermold J alloy steel—1350° F 15 min argon atmosphere, A. C., 1000° F 2 hr, A. C., 1000° F 2 hr, A. C.
4. Type 420 stainless steel—1300° F 15 min argon atmosphere, O. Q., 900° F 3 hr, A. C.
5. Type 422 stainless steel—1900° F 15 min argon atmosphere, O. Q., 1000° F 2 hr, A. C.
6. 17-22 A (S) low-alloy steel—1750° F 15 min argon atmosphere, O. Q., 1300° F 1 hr, A. C.

For each test metal all test specimens were heat treated simultaneously.

The mechanical properties and chemical analyses, furnished by the manufacturers of these materials, are shown in Tables 1 and 2. Two thicknesses of each material—0.062 in. and 3/16 in.—were required to provide for the various specimen designs that were used in this investigation. As shown in Tables 1 and 2, both thicknesses were obtained from the same heats of Thermold J, Type 422, and 17-22 A (S), whereas it was necessary to obtain the two thicknesses from different heats of A-286, 17-7 PH, and Type 420.

2.2 Test Conditions

Test temperatures ranged from room temperature to 1200° F for the A-286 alloy, to 1100° F for the Thermold J tool steel, and to 1000° F for the other test materials. Exposure times of the test specimens at the test temperatures prior to testing ranged from 1/2 hour to 1000 hours. The range of exposure times was the same for all of the test materials. An

WADC TR 58-365

Mechanical Properties of Test Materials Reported by Manufacturers

Table 1

Material	Heat No.	Form	Condition ¹	YS, psi	UTS, psi	% Elong.	Hardness
A-286	B-10205	0.062-in. sheet	b	86,400	152,700	23	28.0 RC
A-286	C-9643	3/16-in. plate	b	70,300	146,100	25	30.5 RC
17-7 PH	56788	0.062-in. sheet	a	48,600	121,000	42.0	87.5 RB
17-7 PH	55464	3/16-in. plate	a	37,600	116,800	39.0	87.0 RB
			d	177,200	193,200	9.0	42.0 RC
			a	156,000	189,500	11.0	41.5 RC
Thermoid J	D-19256	0.062-in. sheet	c				57.0 RC
Thermoid J	D-19256	3/16-in. plate	c				57.0 RC
Type 420	143563	0.062-in. sheet	a				
Type 420	143564	3/16-in. plate	a				
Type 422	E-142761	0.062-in. sheet	a				
Type 422	E-142761	3/16-in. plate	a				
17-22 A (S)	D-19178	0.062-in. sheet	a				79/82 RB
17-22 A (S)	D-19178	3/16-in. plate	a				83/84 RB

1. Condition
 a. Hot rolled, annealed, and pickled
 b. Heat treatment — 1800° F 1 hr, A. C., 1300° F 16 hr, A. C.
 c. Heat treatment — 1850° F 5 min, A. C., 900° F 2 hr, A. C.
 d. TH-1050, 1400° F 90 min, A. C. to R. T. and W. C. to 60° F, 1050° F 90 min, A. C.

WADC TR 58-365

Table 2
Chemical Analysis of Test Materials Reported by Manufacturers

Material	Heat No.	Composition-Percent											
		C	Mn	Si	S	P	Cr	Ni	Mo	V	Ti	Al	Fe
A-286	B 10205 ¹	0.033	1.52	0.56	0.005	0.016	15.35	25.35	1.27	0.24	2.02	0.22	Rem
A-286	C 9643 ¹	0.044	1.48	0.70	0.005	0.024	15.46	24.47	1.24	0.23	2.08	0.25	Rem
Thermold J D 19256 ¹		0.520	0.30	1.09	0.005	0.017	5.05	1.53	1.40	1.05			Rem
17-7 PH	55464 ²	0.088	0.59	0.47	0.016	0.018	17.62	7.17				1.23	Rem
17-7 PH	56788 ²	0.079	0.71	0.36	0.009	0.019	17.41	7.27				1.22	Rem
Type 422	E 142761 ³	0.22	0.68	0.36	0.018	0.019	11.71	0.69	0.94	0.26	0.93	Rem	Rem
Type 420	E 143564 ³	0.33	0.40	0.40	0.013	0.013	13.42					Rem	Rem
Type 420	143563 ³	0.30	0.51	0.43	0.008	0.018	13.25					Rem	Rem
17-22 A (S) ⁴	D19178 ¹	0.30	0.51	0.55	0.008	0.016	1.19		0.50	0.23		Rem	Rem

1. Produced by Universal-Cyclops
 2. Produced by Armco Steel Corp.
 3. Produced by Crucible Steel Co.
 4. This alloy designation is used by Timken Roller Bearing Co. who developed the alloy. Universal-Cyclops designated the same alloy as 14 MV

outline of the test temperatures and exposure times for the various materials is shown in Table 3.

For the 1/2-hour exposure times, each specimen was heated, aged, and tested in one continuous operation in the testing furnace. The longer exposure times were carried out in separate aging furnaces. After the specimens were exposed in the aging furnaces at the required temperature for ten minutes less than the nominal exposure times shown in Table 3, they were air cooled. During the tests, the specimens were reheated in about 20 minutes in the testing furnace to the same exposure temperature, held for ten minutes, and then tested.

2.3 Properties Measured

Tensile, compressive, and bearing properties were determined on the 0.062-in. -thick sheet materials, whereas shear properties were determined on specimens machined from the 3/16-in. plate. Tensile tests were also conducted on the 3/16-in. plate in order to provide a direct comparison of tensile strength between the two thicknesses of each test metal.

In tensile tests on 0.062-in. sheet, the complete stress-strain curves were recorded, and the following properties were determined: 0.2%-offset yield strength, ultimate tensile strength, modulus of elasticity, rupture strength based on the original specimen cross-sectional area, rupture strength based on the final specimen cross-sectional area, and total elongation. In tensile tests on 3/16-in. plate, only the ultimate tensile strength was determined.

Compressive stress-strain curves were recorded through the 0.2%-offset yield point, and the following compression properties were determined: 0.2%-offset yield strength, modulus of elasticity, and tangent modulus at various stress levels up to the 0.2%-offset yield strength.

In the bearing tests, stress-deformation curves were recorded through the yield point. The bearing yield strength and ultimate bearing strength were reported for each bearing test. The bearing specimens were loaded in tension through two clevis pins that fit snugly in bearing holes at opposite ends of the specimens. The deformation recorded in these tests was that which occurred in the smaller bearing hole, which was 1/4-in. in diameter. This deformation was equivalent to the relative displacement of the center line of the 1/4-in. bearing pin with respect to the original center line of the 1/4-in. bearing hole. Bearing failures consisted of fractures of the test specimens adjacent to this bearing pin. Bearing yield strength was defined as the stress that produces a permanent deformation of 0.05-in. which is equivalent to 2% of

1. Thickness of 0.062-in. and 3/16-in. for tensile tests, 0.062-in. for compressive and bearing tests, and 0.125 diameter machined from 3/16-in. plate for shear tests.
 2. Time of exposure of test specimens to elevated temperatures prior to testing at the same elevated temperatures.

Material, Sheet	Heat-Treatment	Test Temperature, ° F	Exposure Time, 2 Hrs
17-7 PH (RH 950) Stainless steel	1750° F, 10 min, A. C. -100° F, 8 hr 950° F, 1 hr, A. C.	RT, 600, 800, 1000	1/2, 10, 100, 1000
Thermoid J Alloy steel	1850° F, 15 min, A. C. 1000° F, 2 hr, A. C. 1000° F, 2 hr, A. C.	RT, 600, 800, 1000, 1100	1/2, 10, 100, 1000
Type 420 Stainless steel	1800° F, 15 min, O. Q. 900° F, 3 hr, A. C.	RT, 400, 600, 800, 1000	1/2, 10, 100, 1000
Type 422 Stainless steel	1900° F, 15 min, O. Q. 1000° F, 2 hr, A. C.	RT, 400, 600, 800, 1000	1/2, 10, 100, 1000
17-22 A (S) Low-alloy steel	1750° F, 15 min, O. Q. 1300° F, 1 hr, A. C.	RT, 400, 600, 800, 1000	1/2, 10, 100, 1000
A-286 austenitic age-hardening alloy	1800° F, 1 hr, O. Q. 1325° F, 16 hr, A. C.	RT, 600, 800, 1000, 1100, 1200	1/2, 10, 100, 1000

Test Materials, Test Temperatures, and Exposure Times for Tensile, Compression, Bearing, and Shear Tests

Table 3

WADC TR 58-265

9

the bearing hole diameter. For the calculation of bearing stresses from load measurements, the bearing area was considered to be the area of contact between the 1/4-in. bearing pin and the bearing hole projected onto a plane perpendicular to the direction of loading. This area is equivalent to the product of the diameter of the 1/4-in. bearing pin and the thickness of the bearing specimens.

Ultimate shear strength was the only property measured in the shear tests. No deformation measurements were made in these tests. The type of shear-testing fixture used produced shear failures across two cross sections of the pin-type specimens. Shear strength values, therefore, were determined by dividing the ultimate load by twice the cross-sectional area of the specimens.

Hardness determinations were made on all test specimens at room temperature after the completion of the tests.

SECTION III. PREPARATION OF TEST SPECIMENS

The dimensions of the various types of test specimens are shown in Fig. 1. Two sets of bearing specimens with edge-distance to hole-diameter ratios of 1.5 to 1 and of 2.0 to 1 were tested at all combinations of temperatures and exposure times employed in this investigation. The edge distance is defined as the distance from the center line of the 1/4-in. bearing hole to the adjacent edge of the specimen.

The major axis of all test specimens was oriented in the direction of rolling.

Stress-strain characteristics were determined within a 2-in. gage length on the tensile specimens and within a 1-in. gage length on the compression specimens.

In order to facilitate proper loading alignment in the compression tests, special care was taken in machining the compression specimens to insure that the loaded ends were parallel to each other and perpendicular to the longitudinal axis of the specimens.

All of the tensile, compression, and bearing specimens were machined to the final dimensions before they were heat treated and exposed to the aging temperature. The ends of the compression specimens

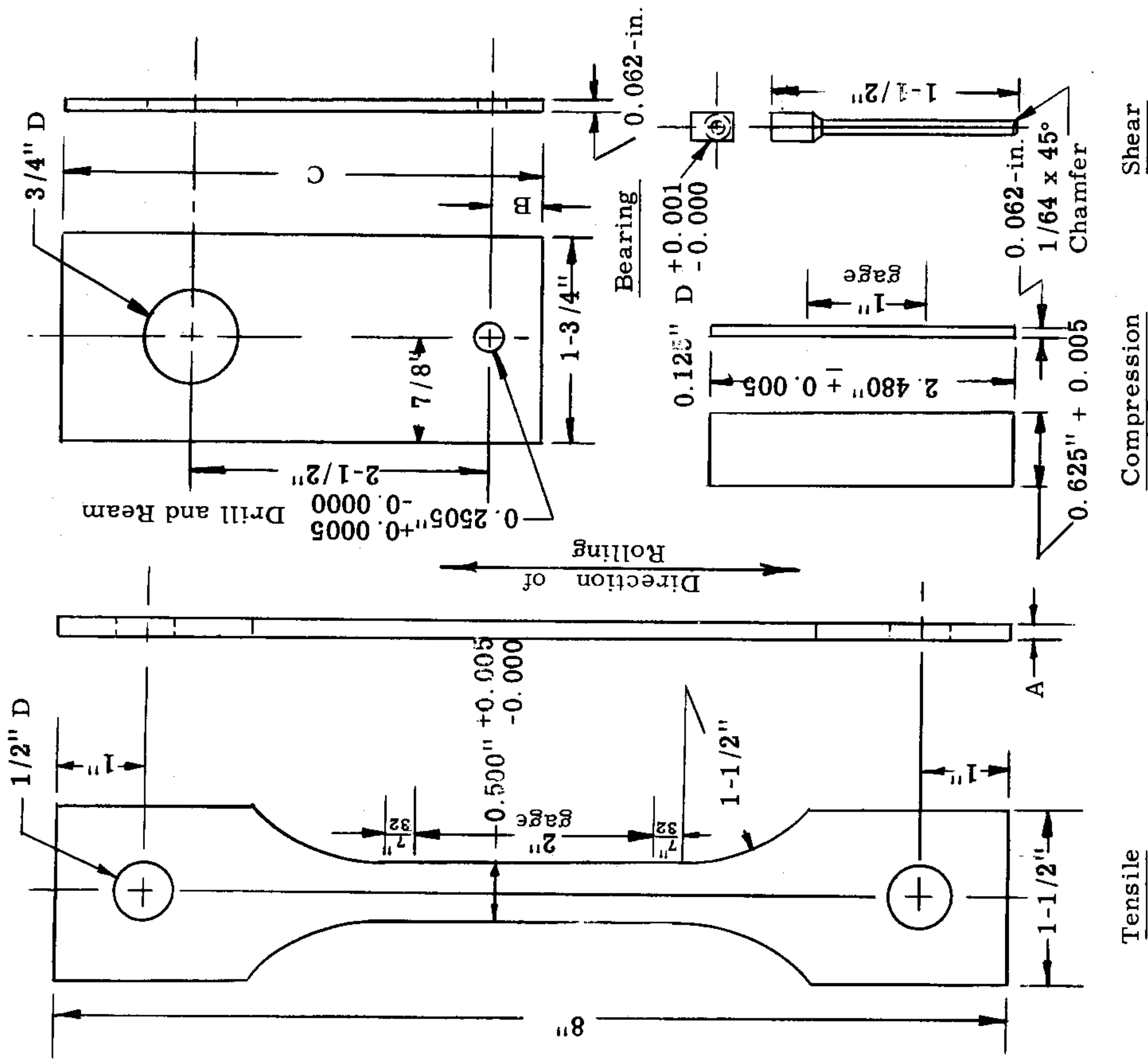

- A. 0.062-in. and 3/16-in.
- B. 0.500-in. and 0.375-in.
- C. 4-1/8-in. when B = 0.500; 4in. when B = 0.375

Fig. 1. Dimensions of Test Specimens

were ground slightly after heat treatment to insure flatness, smoothness, and proper loading alignment. Since slight distortion or warping of the shear specimens prevented them from fitting easily into the test fixture, they were machined oversize and heat treated before being ground to the final dimensions.

SECTION IV. TESTING EQUIPMENT

The following are the main items of equipment used in the tests:

1. A 120,000 lb-capacity Baldwin universal testing machine, which was used for loading in all tests.
2. Suitable loading fixtures for the tensile, bearing, compression, and shear tests. These fixtures were designed and made at Southern Research Institute.
3. Preyield and postyield extensometers for the tensile tests, an extensometer for the compression test, and an extensometer for the bearing tests. These fixtures were designed and made at Southern Research Institute.
4. A load-deformation recorder. A standard Baldwin automatic graphic recorder was modified and adapted for this work.
5. A furnace in which the elevated-temperature tests were carried out. This furnace was designed and built at Southern Research Institute.

Most of these items were described in detail in WADC Technical Report 56-340. For the present work, however, several modifications have been made primarily in the compression fixture and in the test furnace. The discussions of the test equipment that follow are intended to review the previous descriptions and to point out the modifications.

4.1 Compression Test Fixture

The compression test fixture, as shown in Fig. 2, consisted of a socket, a loading plunger, a subpress, and two guide blocks, all of which were made of quenched and tempered tool steel. The principal modifications were the addition of a socket to facilitate loading alignment and the incorporation of vertical grooves in the faces of the guide blocks to reduce friction.

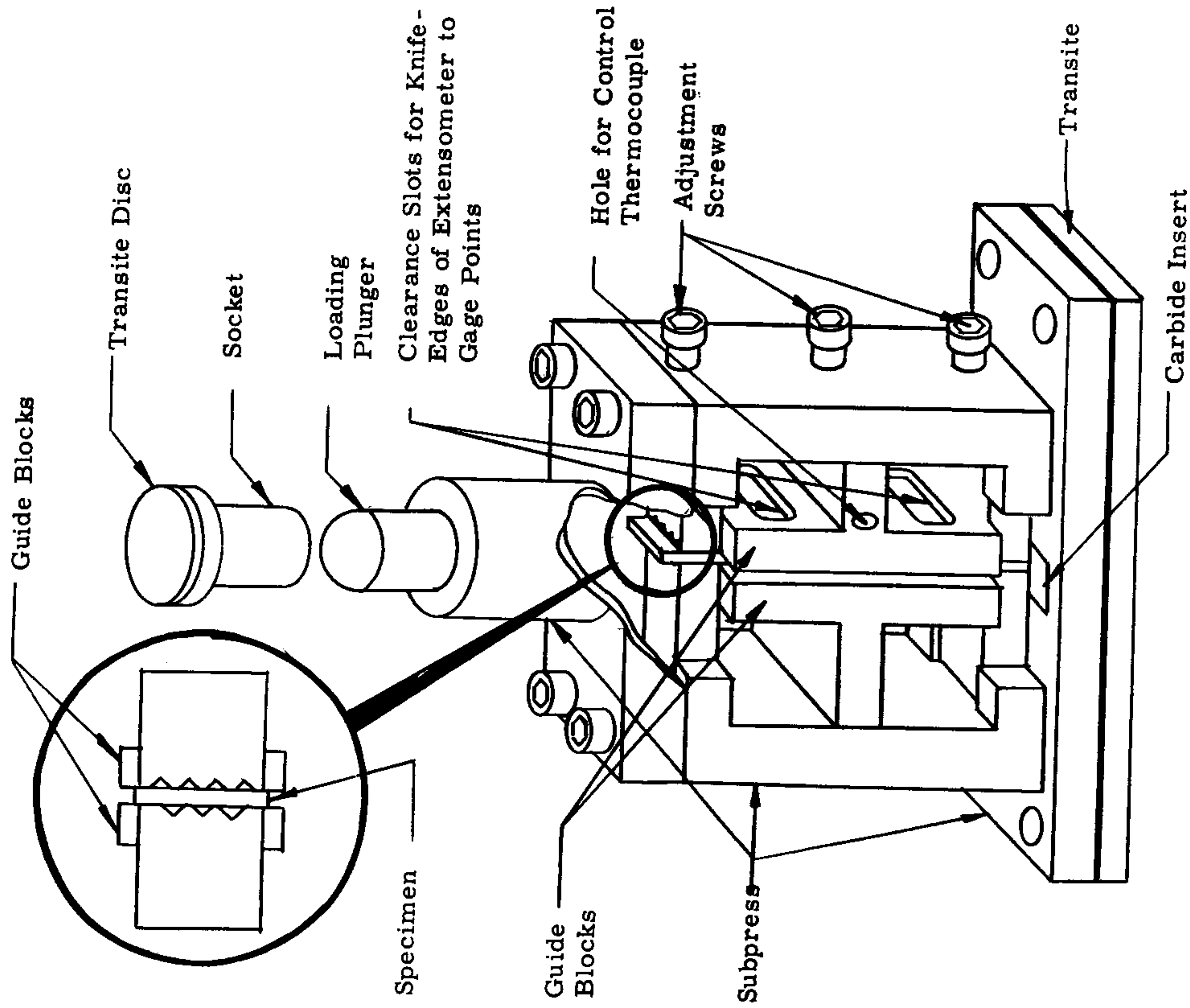

Fig. 2. Compression Test Fixture

To support the concentrated compressive load from the specimen, a carbide insert was incorporated into the base plate of the subpress. The fixture was supported in the furnace, as shown in Fig. 3, on a structural steel pedestal. The pedestal, which extended through the bottom of the furnace, rested on the lower crosshead of the testing machine. A 1/4-in.-thick transite plate separated the fixture from the pedestal. The transite plate contributed to temperature uniformity in the specimens by minimizing heat loss through the pedestal. Also shown in Fig. 3 is the upper end of the compression extensometer.

The guide blocks were necessary to support the specimens and to prevent buckling of the specimens under compressive loading. In order to minimize friction between the guide blocks and the specimens, V-grooves were cut in the bearing surfaces of the guide blocks parallel to the direction of loading. The grooves in the guide block supporting one side of the specimen were offset from the grooves in the other guide block as shown in Fig. 2. Also, to minimize friction the compression specimens were thoroughly cleaned and lubricated with Molykote. Support pressure on the specimens was controlled by three adjustment screws. To provide a uniform support pressure, the screws were tightened to 5 in. lbs with a torque wrench.

All parts of the subpress were accurately machined to insure, as nearly as possible, perfect vertical alignment of the specimen and the loading plunger. Also facilitating loading alignment was the socket, as shown in Fig. 2, that formed a ball-and-socket joint with the loading plunger. The top of the socket, which was covered with a transite disc to minimize heat losses, was loaded by a heavy rod that extended from the upper crosshead of the testing machine.

4.2 Tensile Test Fixture

The tensile specimens were loaded through two pull rods that extended from the upper and lower crossheads of the testing machine and formed clevis linkages with the shoulders of the specimens as shown in Figure 4. Both the clevis pins, which were 1/2-in. in diameter, and the pull rods, which were 1-1/8-in. in diameter, were made of quenched and tempered tool steel.

Figure 4 also shows the extensometer attached to a specimen with the extension rods extending below the specimen and the transducers attached to the lower ends of the extension rods.

4.3 Bearing Test Fixture

A photograph of the bearing-test setup including the fixture, extensometer, and a specimen is shown in Fig. 5. Fig. 6 is a schematic

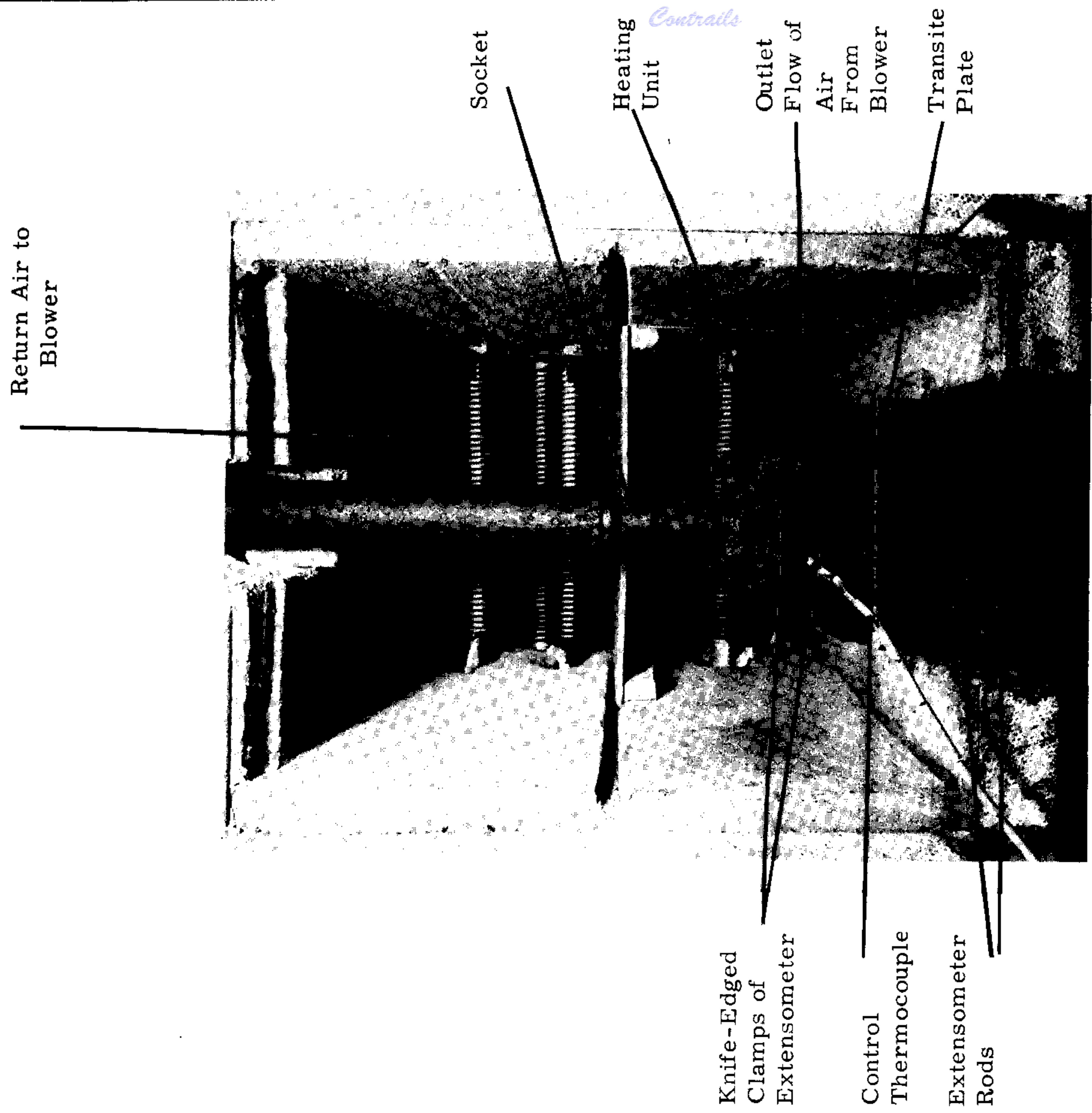

Fig. 3. Compression Test Fixtures in Position in the Test Furnace

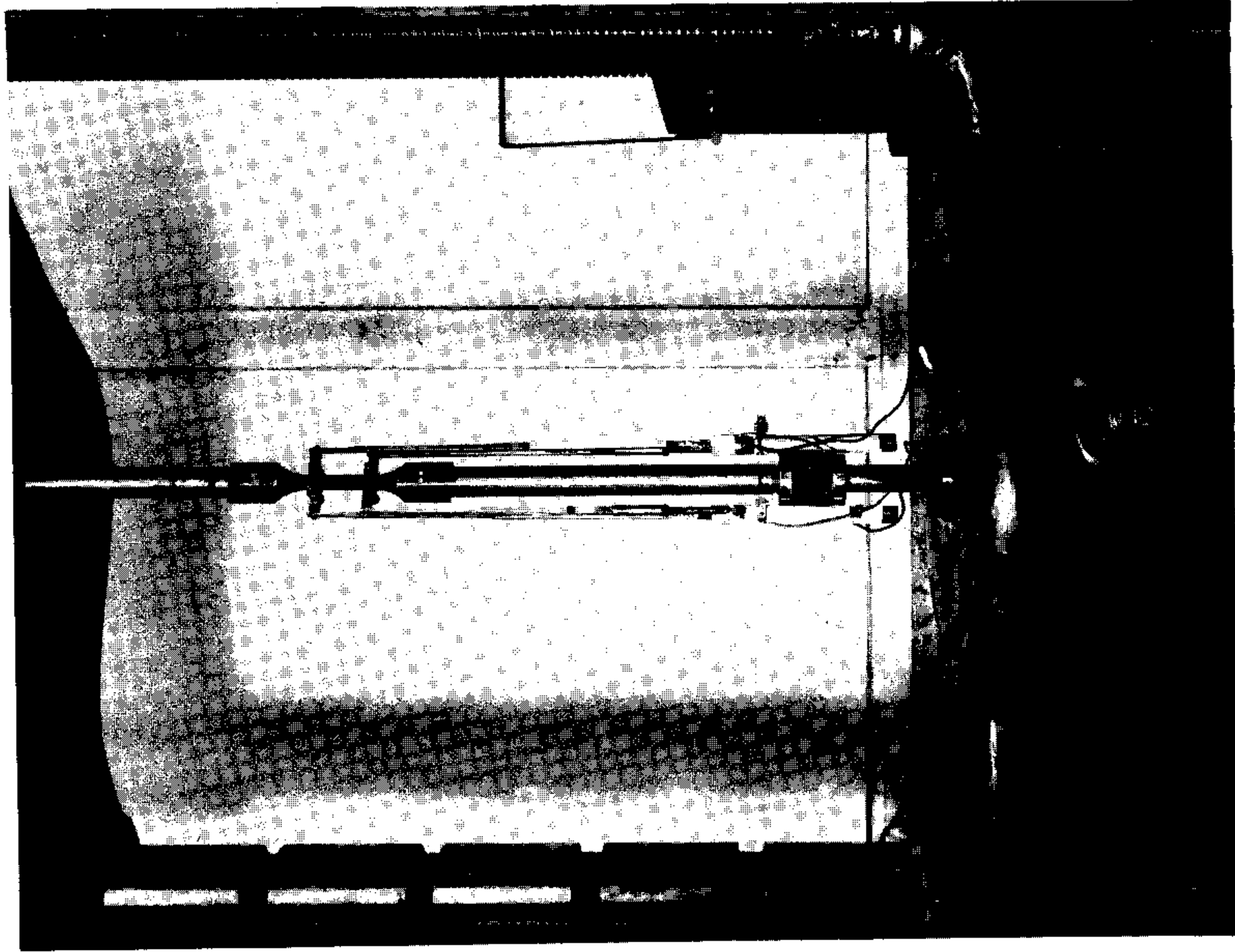

Fig. 4. Tensile Test Apparatus

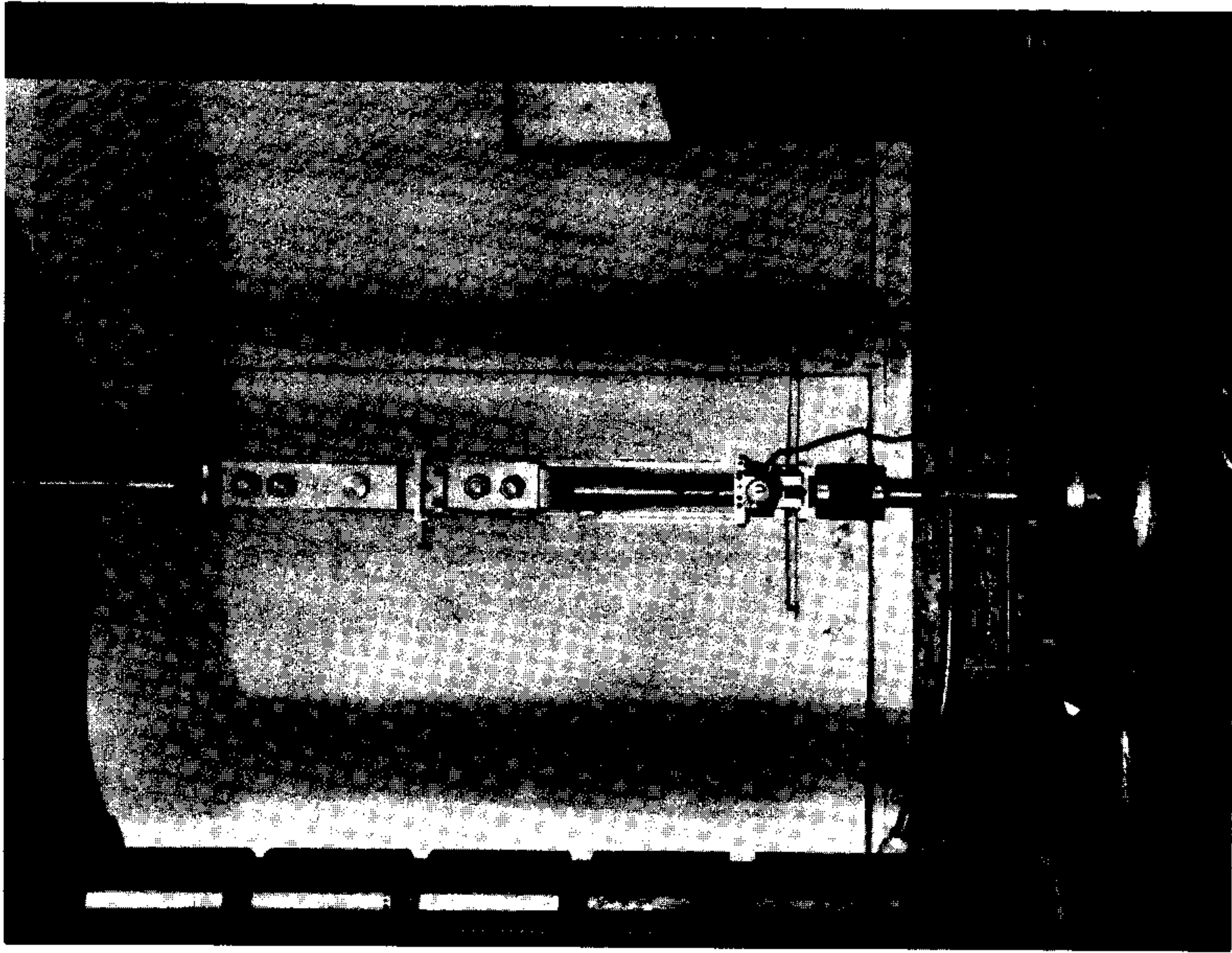

Fig. 5. Bearing Test Apparatus

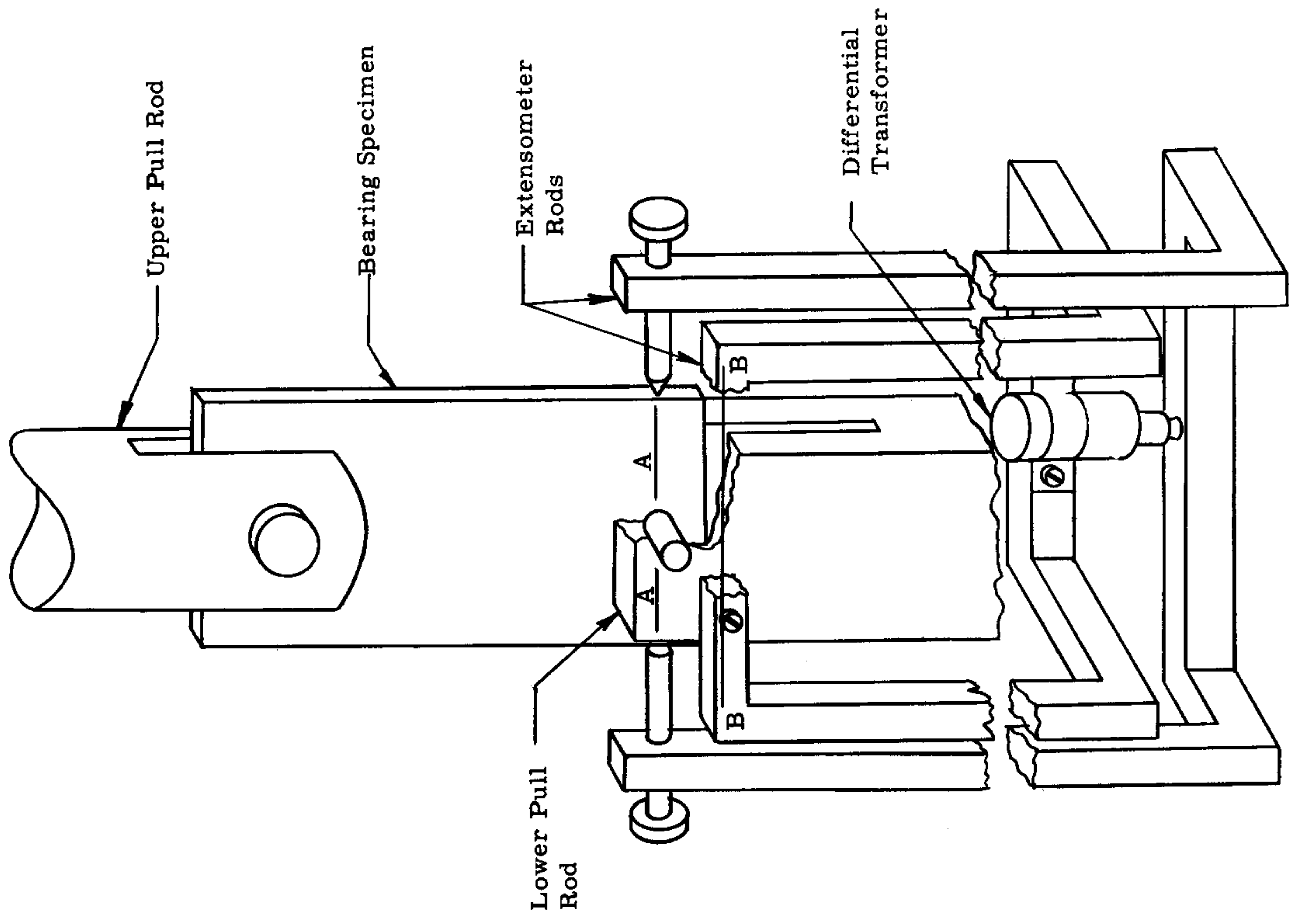

Fig. 6. Diagram of Bearing Test Specimen Assembled to Pull Rods Showing Method of Extensometer Attachment.

illustration of the loading mechanism and of the method of extensometer attachment. The bearing specimens were loaded by two pull rods through clevis linkages at each end of the specimens as shown in Fig. 6. The pull rods and bearing pins were made of hardened and tempered tool steel.

4.4 Shear Test Fixture

The shear-test fixture included two pull rods with 1/4-in. slots in one end of each. These pull rods formed clevis linkages with a 1/4-in. -thick center plate as shown in Fig. 7. A 1/2-in. diameter bolt was used for one clevis pin; the shear test specimen was the other clevis pin. The pull rods and center plate were made of quenched and tempered tool steel. Hard, replaceable inserts with 1/8-in. inside diameters were fitted into the bottom clevis holes in the pull rod and in the center plate. These inserts prevented deformation in the fixture in the vicinity of load application to the shear specimens. Both hardened-tool-steel and sintered-carbide inserts were used successfully in this application. The carbide inserts tended to shatter after about five tests or less. Whereas no difficulty was experienced with shattering of the tool-steel inserts, they tended to deform appreciably during tests at temperatures above 1000° F. At test temperatures up to 1000° F, therefore, the tool-steel inserts were used; at higher temperatures carbide inserts were used. Each set of inserts was replaced after twelve or less tests, so that no appreciably deformed inserts were used in any of the tests.

As the shear fixture was loaded in tension, the specimen was held rigid, with little deformation, until it sheared in the two planes that formed the interfaces between the bottom pull rod and the center plate.

4.5 Extensometers

Two extensometers were used in the tensile tests. Up to the yield point, a very sensitive and accurate "preyield" extensometer, which was actuated by SR-4 strain-gage transducers, was used. Beyond the yield point, the plastic strain was measured by a less sensitive "postyield" extensometer, which had a differential-transformer transducer. Since two extensometers of different sensitivities were used in the tensile tests, the complete stress-strain curves were recorded in two segments. The first segment, from zero load through the yield point, was recorded on an expanded scale for the accurate determination of modulus of elasticity and yield strength; the second segment, from the yield point to rupture, was recorded on a compressed scale for the determination of ultimate strength, rupture strength, and the general shape of the stress-strain curve.

The preyield extensometer for the tensile tests and the compression extensometer were almost identical in design and in operation. They

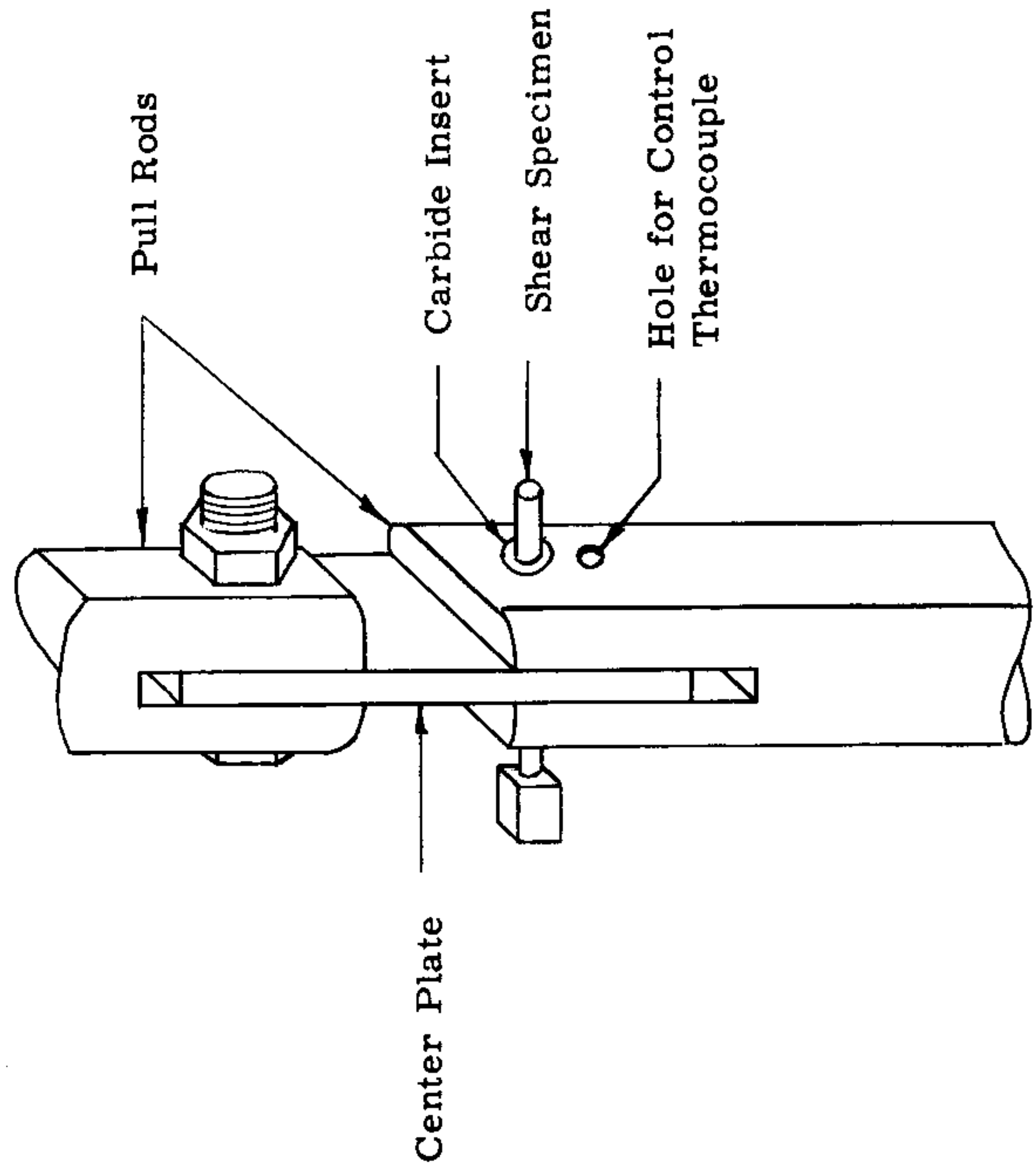

Fig. 7. Shear Test Fixture

consisted of the following parts, all of which are shown on a tensile specimen in Fig. 4.

1. Hardened steel knife edges, which were screw-fastened across the width of the specimens at the gage points.
2. Two sets of stainless steel extension rods, which extended downward from the knife edges out of the test furnace on opposite sides of the specimen.
3. Two SR-4 strain-gage transducers and two steel transducer mounts, which were attached to the lower ends of the extension rods.

The various parts of the transducer mounts and strain-gage transducers are shown in Fig. 8. As the tensile and compression specimens were loaded, the relative displacement between the gage points was transferred through the extension rods and the transducer mounts to the SR-4 strain gages, which were 6 in. long.

A thin beryllium-copper strip was fastened in a horizontal position to the guides of both transducer mounts. This strip prevented any lateral displacement of one mount with respect to the other. The strip, however, was quite flexible in the vertical direction and did not interfere with any differential displacement in the direction of loading. This provision for differential displacement in the direction of loading was necessary to detect and to average the differences in strain on two sides of the specimen.

The active SR-4 strain gages of the tensile and compressive extensometers were connected in a bridge circuit with two dummy gages. Excitation for these extensometers and for all other extensometers used in this work was provided in the form of 15-volt, 60-cycle AC from a transformer in the recorder. The output from the bridge circuit, which was calibrated in terms of strain, was fed into an autographic stress-strain recorder.

When the strain in the tensile tests exceeded the yield point, the circuit of the preyield extensometer was disengaged and that of the postyield extensometer was engaged to feed its calibrated output into the autographic recorder.

A diagram of the tensile postyield extensometer is shown in Fig. 9. The linear-differential-transformer transducer was actuated from the crosshead of the testing machine through a wedge that produced a suitable reduction ratio of crosshead travel to core travel.

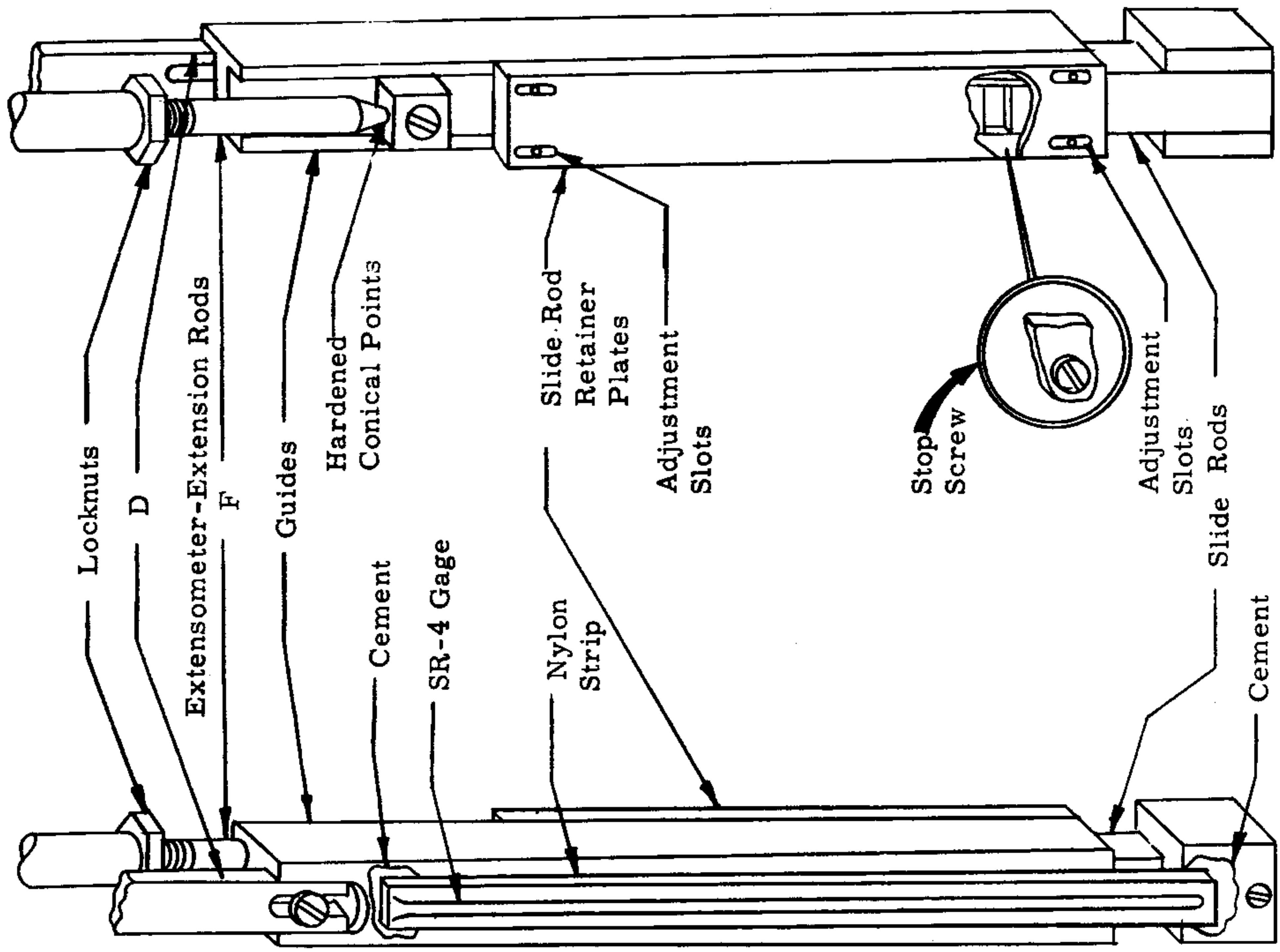

Fig. 8. Strain-Gage Transducers and Transducer Mounts for Tensile and Compression Extensometer

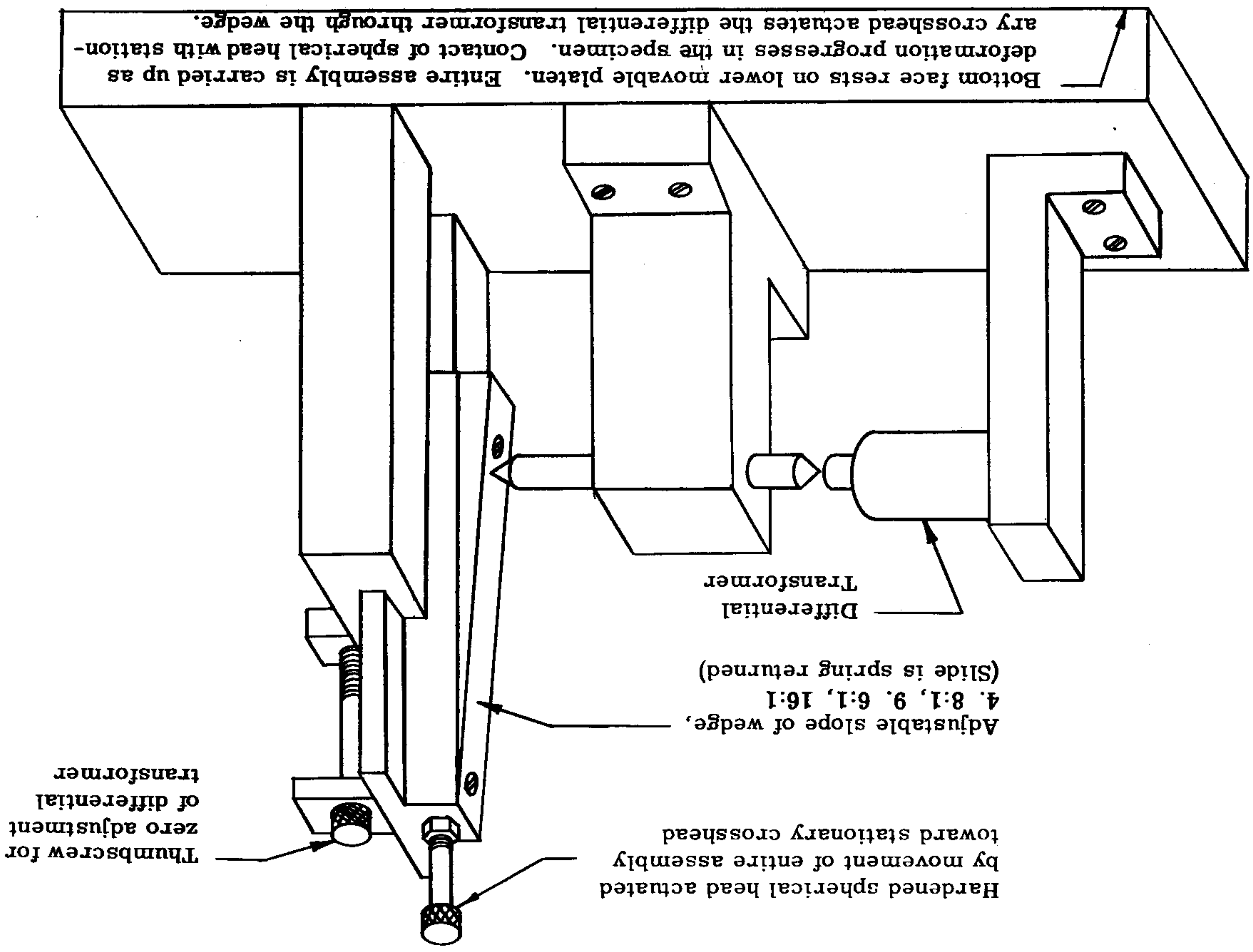

Fig. 9. Postyield Extensometer

The extensometer used in the bearing tests is shown in Fig. 5 and is illustrated schematically in Fig. 6. This extensometer is a modification of one commonly used in elevated-temperature tensile tests. One set of extensometer rods was attached to the edges of the specimen on the horizontal center line of the 1/4-in. bearing hole, which is designated as AA in Fig. 6. The other set of extensometer rods was fastened to the lower pull rod along line BB. Thin brass strips, which can be seen in Fig. 5, were connected between the horizontal sections at the lower end of the extensometer rods. These strips prevented any lateral displacement between the extensometer rods without interfering with vertical displacement.

As the load was applied to the bearing specimen, the extensometer sensed the change in the displacement between lines AA and BB. Since the pull rods and bearing pin had relatively large cross sections in comparison with the specimens, the deformation in these parts was generally negligible. The displacement detected by the extensometer, therefore, was equivalent to the vertical deformation of the 1/4-in. bearing hole.

The calibrated output of the differential transformer of the bearing extensometer was fed into an autographic recorder that recorded the stress-deformation curves.

4.6 Stress-Strain Recorder

All of the stress-strain curves obtained in this work were recorded on a Baldwin autographic recorder. The recorder was originally designed and calibrated to operate in conjunction with a Baldwin universal testing machine and with linear-differential-transformer strain transducers. The load channel was mechanically driven from the weighing element of the testing machine. The strain channel was a self-balancing electronic circuit. Provisions were built into this recorder to mechanically vary the load calibration and the strain calibration at several convenient levels on the record charts.

In order to make the recorder self-balancing with strain-gage transducers, it was modified by the addition of a ten-turn potentiometer, which was geared to the balancing motor in the recorder. The potentiometer was wired into one corner of the strain-gage bridge circuit of the extensometer. As the tensile or compression specimens were strained, unbalancing the bridge circuit, the signal caused the balancing motor to drive the recorder in the proper direction to rebalance the bridge by means of the potentiometer. With this circuit, several convenient levels of strain calibration could be achieved on the recorder chart by a change of gears between the balancing motor and the balancing potentiometer.

During the tensile tests, the strain-gage bridge circuit of the preyield extensometer actuated the recorder until the 0.2 %-offset yield strength was exceeded. A manually operated switch, which was added to the recorder, was then used to shift to the differential-transformer circuit of the postyield extensometer. The recorder adjusted itself to the proper strain level on the condensed scale used in conjunction with the postyield extensometer, and then the postyield curve was recorded until the specimen fractured.

4.7 Test Furnace

The circulating-air furnace that was described in WADC Technical Report 56-340 was modified considerably for the present work. The modifications were intended primarily to provide for better insulation, longer life of heating elements, better temperature control, and quicker changing of specimens. The furnace is shown in position for the tensile, bearing, and shear tests in Fig. 10.

The Rockwool insulation in the original furnace was replaced with a complete lining of fire brick, which provided better insulation and better resistance to the higher test temperatures. Six edge-wound ribbon-type resistance heating elements with a total capacity of 12 kilowatts were installed to replace the original wire heating coils. The edge-wound elements were much sturdier than the wire coils; and, too, three were installed in the upper air duct and three in the lower air duct of the furnace in such a manner that each could be removed individually for repairs or replacement. These heating elements were wired in series with a saturable reactor, which provided a sensitive and continuous control of heat input.

Slots, extending from the front edges to the opening for the test fixtures, were cut into the top and bottom of the heating chamber. With the furnace door open, these slots allowed the test operator to roll the furnace away from the testing machine between tests without disturbing the test fixture. With the test furnace thus removed from the work area, the operator could change specimens unhampered by heat radiated from the furnace walls. After the furnace was rolled away, the door was closed and the circulating air kept at test temperature while a new specimen was installed. When the furnace was placed back into testing position, the specimen was heated to test temperature within a few minutes. The slots and exposed areas of the openings for the test fixtures were covered with suitably shaped asbestos boards to prevent excessive losses of heat and of air.

Air was circulated in the furnace, by means of a vane-type blower, through the lower duct toward the test chamber, up through the test chamber, and back through the upper duct. This direction of air flow provided better temperature uniformity than the opposite direction did.

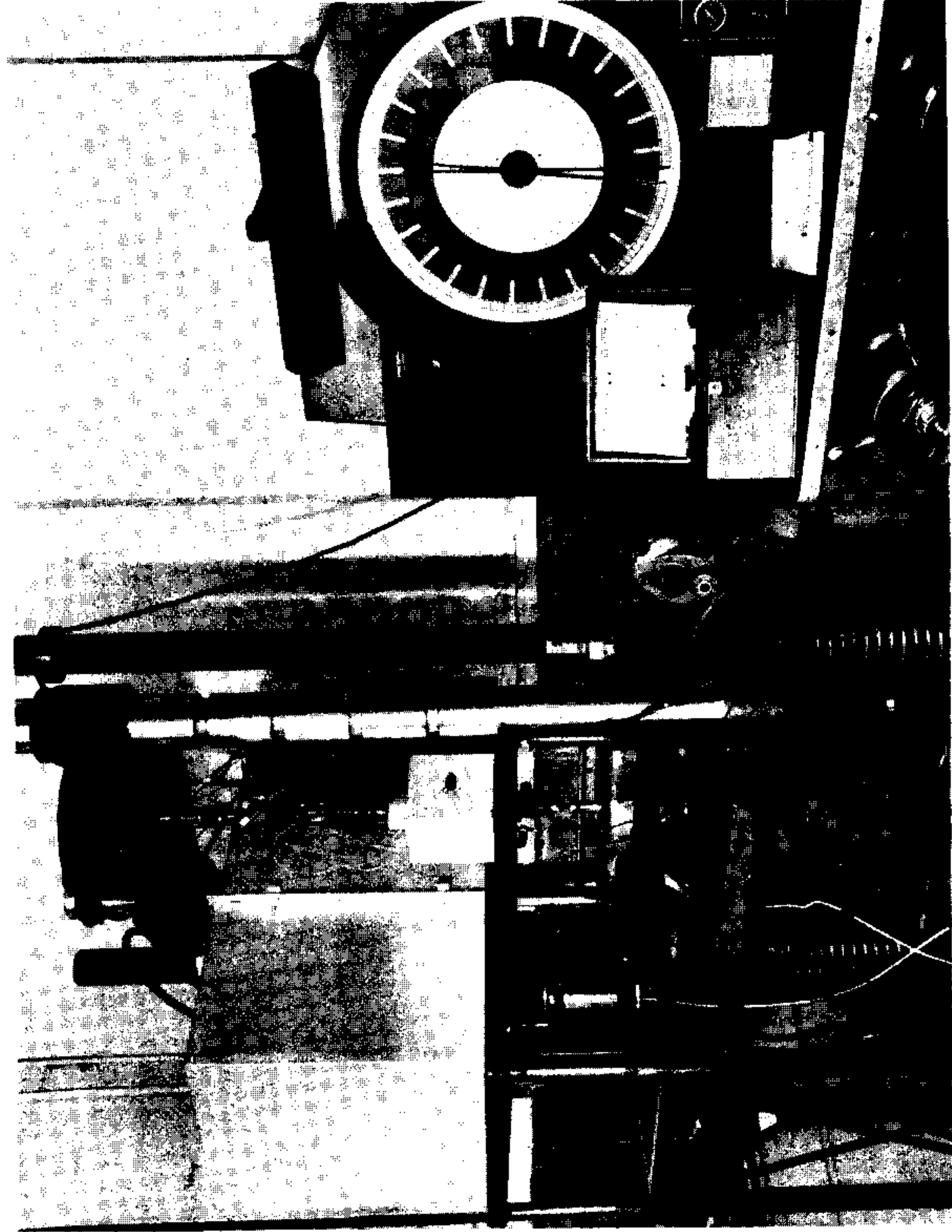

Fig. 10. Test Apparatus Showing Position of the Test Furnace for the Tensile, Bearing, and Shear Tests

4.8 Temperature-Control System

The temperature of the test specimen was measured by a thermocouple, which was in contact with the specimen. Responding to the output of the thermocouple, a Foxboro Controller in conjunction with the saturable reactor regulated the current to the heating elements to maintain an almost constant temperature at the specimen. All six of the heating elements and the saturable reactor were connected in series across a 220-volt, 60-cycle power line. Two predetermined power levels were available to the controller for selection by means of a switching action that occurred at the control temperature. Whenever the temperature of the specimen was below the predetermined control temperature, the controller selected the larger power level, which was present to provide a temperature rise. Whenever the temperature of the specimen was higher than the control temperature, the controller selected the lower power level which allowed a slight decline in the test temperature. As the controller cycled between the two power levels the temperature of the specimen was held to a cyclic variation of not more than $\pm 5^\circ$ F.

SECTION V. CALIBRATIONS AND ACCURACY

5.1 Load

The load calibration of the Baldwin testing machine that was used in this work was checked by means of proving rings. The indicated load was consistently accurate within $\pm 1\%$ of the actual value throughout the entire range of the machine.

5.2 Bearing and Postyield Tensile Extensometer

These extensometers employed Baldwin differential-transformer transducers, the calibrations being furnished by the manufacturer. The ratio of displacement on the strain axis of the recorder chart to core displacement could be controlled to levels of 250, 500, 1000 by proper gearing of the recorder drive mechanism. These calibrations are believed to be accurate to within $\pm 3\%$ since this level of accuracy is usually obtainable with linear-differential- transformer transducers.

The error introduced by the detection of postyield strain at the crosshead was determined roughly by comparing measured total elongation with that indicated on the stress-strain curves. In general, the indicated plastic strain was from 5% to 40% higher than the measured strain.

5.3 Preyield Tensile and Compressive Extensometer

The accuracy, reproducibility, and linearity of the calibrations of these extensometers were checked by means of the apparatus shown in Fig. 11. This apparatus consisted of a Tuckerman optical strain gage and Autocollimator, the extensometer, a Baldwin SR-4 strain indicator, and a calibrating device, on which the extensometer and the Tuckerman gage could be equally deflected. The calibrating device is shown in Fig. 12.

With this apparatus, the extensometer and the Tuckerman gage were deflected simultaneously in equal increments, and the readings of the Tuckerman gage were plotted against the output of the strain gages as measured by the strain indicator. As discussed in WADC Technical Report 56-340, a statistical analysis of repeated calibrations of this type indicated that in the preyield tensile extensometer the probable error did not exceed 0.5% in 67% of the tests; in the compression extensometer the probable error did not exceed 1.0% in 67% of the tests. Experience in using these extensometers indicates, however, that these levels of accuracy were not consistently achieved, especially in tests at elevated temperatures.

Although reading errors, instrument errors, and errors in the primary standard (Tuckerman gage) probably contributed minor inaccuracies to the calibration and the use of these extensometers, it is believed that the greatest sources of error were mechanical. Mechanical errors can be caused by non-rigidity in certain structural parts of the extensometers and by slippage in the joints or the knife edges. Although this type of error was probably quite small in the calibrations, which were carried out at room temperature, it was probably more severe at elevated temperatures where inconsistencies in modulus values were greater than would be indicated by the accuracy and reproducibility of the calibrations.

In order to calibrate the strain scale of the recorder for use with these extensometers, the apparatus shown in Fig. 11 was used except that the extensometer output was fed into the recorder instead of into the strain analyzer. The calibrating device was actuated to several convenient increments of displacement as indicated by the Tuckerman strain gage; at each increment, the corresponding displacement on the recorder chart was read. Such calibrations, which were run at least once each week on both extensometers, were found to be accurate, reproducible, and linear to the degree indicated by the statistical analysis discussed above.

Extensometer
Rods
Tuckerman
Gage
Active Gages
Dummy Gages
Calibrating
Device
Autocollimator

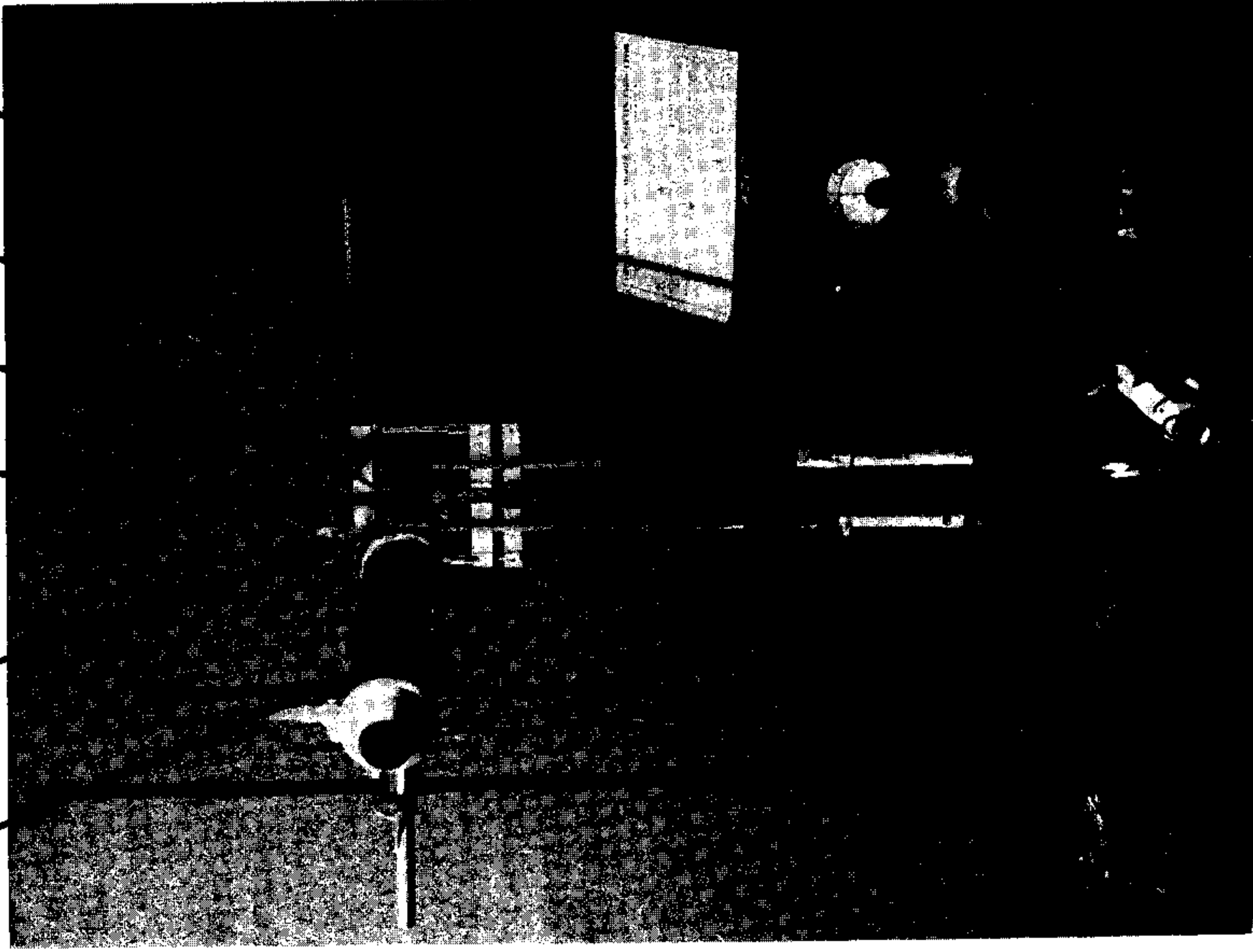

Fig. 11. Setup for Checking Accuracy, Reproducibility, and Linearity of Preyield Tensile and Compressive Extensometer

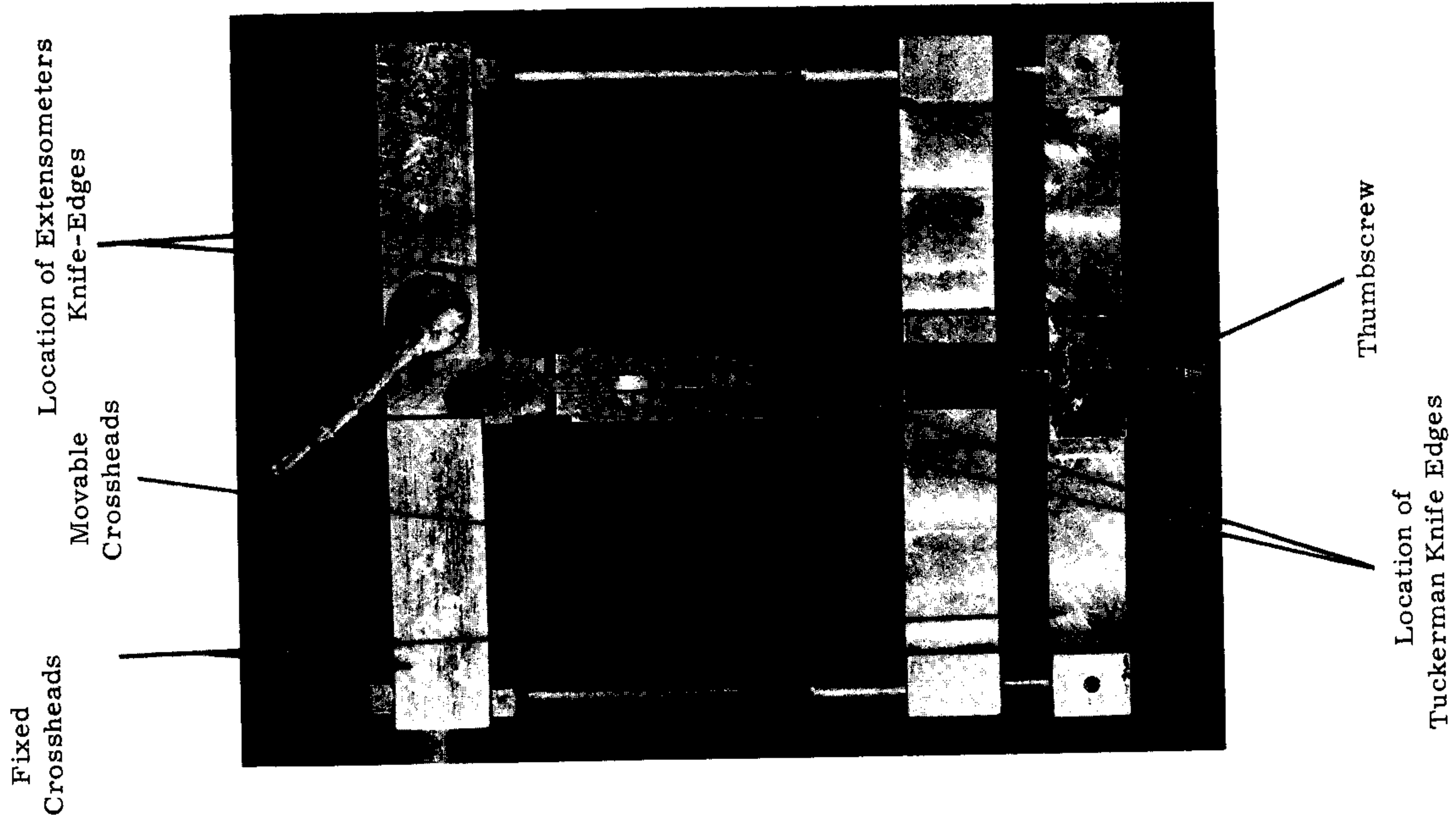

Fig. 12. Calibrating Device

5.4 Tensile Elongation

Total elongation of the tensile specimens was measured with a scale graduated in hundredths of an inch. Since this scale could be read to the nearest **0.01** in., the measurements were accurate within **+ 0.25%** elongation.

5.5 Temperature Measurement

Chromel-alumel thermocouples were used for temperature measurement in this work. These thermocouples are guaranteed by the manufacturer to be accurate within **+ 0.75%** of the measured temperature in degrees Fahrenheit.

Surveys of temperature distribution were made on specimens of all types while they were in their normal testing positions. In these surveys, four thermocouples, in addition to the normal control couple, were positioned on or near the specimens as designated by the numbers **1, 2, 3,** and **4,** in Fig. **13, 14, 15,** and **16.** The tables on these illustrations show equilibrium temperatures at the various thermocouple positions while the control couple was maintained at various test temperatures.

The temperature distributions were reasonably uniform at all test temperatures and with each type of specimen. The greatest nonuniformities, which occurred at the higher test temperatures in the compression and shear specimens, were **+8° F** and **-7° F.** The improved temperature uniformities over those reported in WADC Technical Report **56-430** were a result of the following modifications in the test furnace: one, the reversal of the direction of air flow in the heating chamber from downward to upward; second, the inclusion of heating elements in both the top and bottom air ducts, resulting in more uniform radiation of heat to the test fixtures.

SECTION VI. TEST PROCEDURE

For most conditions of temperature and exposure time, three or more tests of each type were conducted on each test material. At **1100° F** and **1200° F,** however, the bearing tests on Thermold J alloy steel and on **A-286** alloy were not completed since the test fixture tended to deform because of the relatively high strength of the specimens in comparison to that of the fixture at those temperatures.

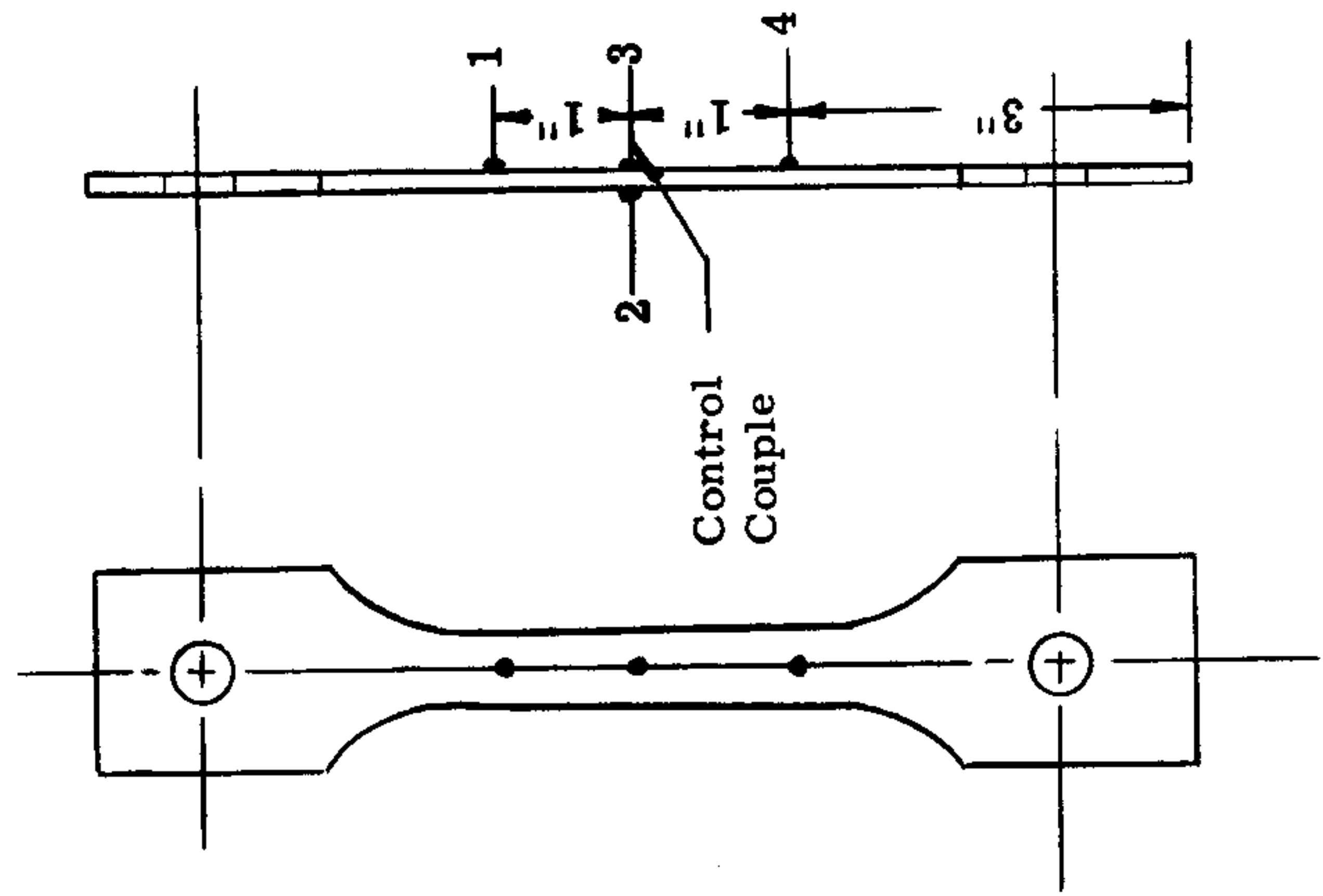

Controller Temperature Setting, ° F

Thermocouples	400	600	800	1000	1200
1	398	594	800	1002	1202
2	398	594	802	1003	1204
3	399	594	799	1002	1198
4	400	597	798	1002	1198

Cyclic-Control Variation + 5° F

Fig. 13. Tensile Test Specimen Showing Location of Thermocouples and Corresponding Temperature-Distribution Survey.

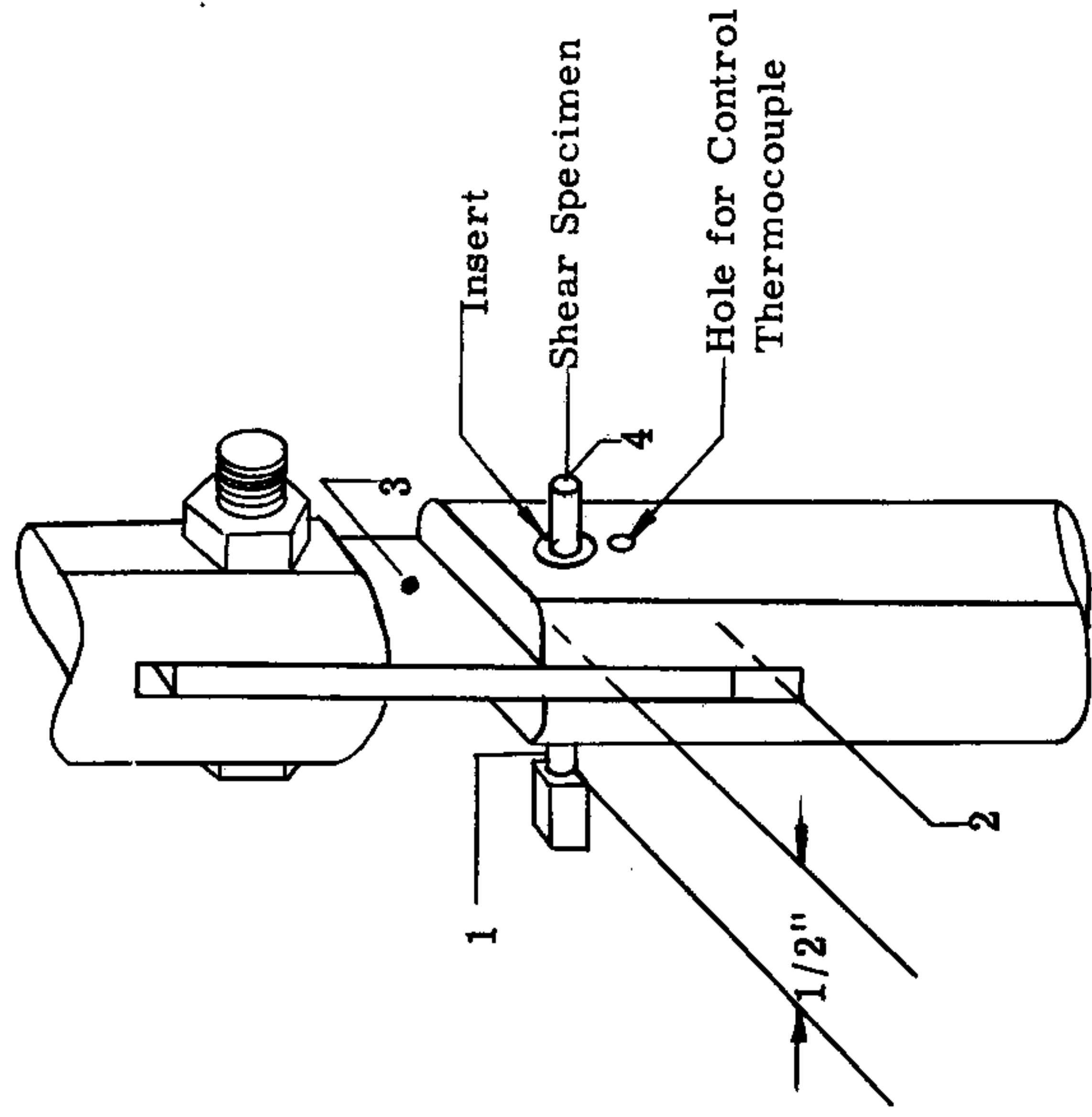

Thermocouples	Controller Temperature Setting, ° F				
	400	600	800	1000	1200
1	399	596	801	1003	1204
2	399	597	802	1006	1208
3	399	597	802	1006	1207
4	396	597	800	1002	1201

Cyclic-Control Variation +5° F

Fig. 14. Shear Specimen Set in Test Fixture Showing Location of Thermocouples and Corresponding Temperatures During Temperature-Distribution Survey.

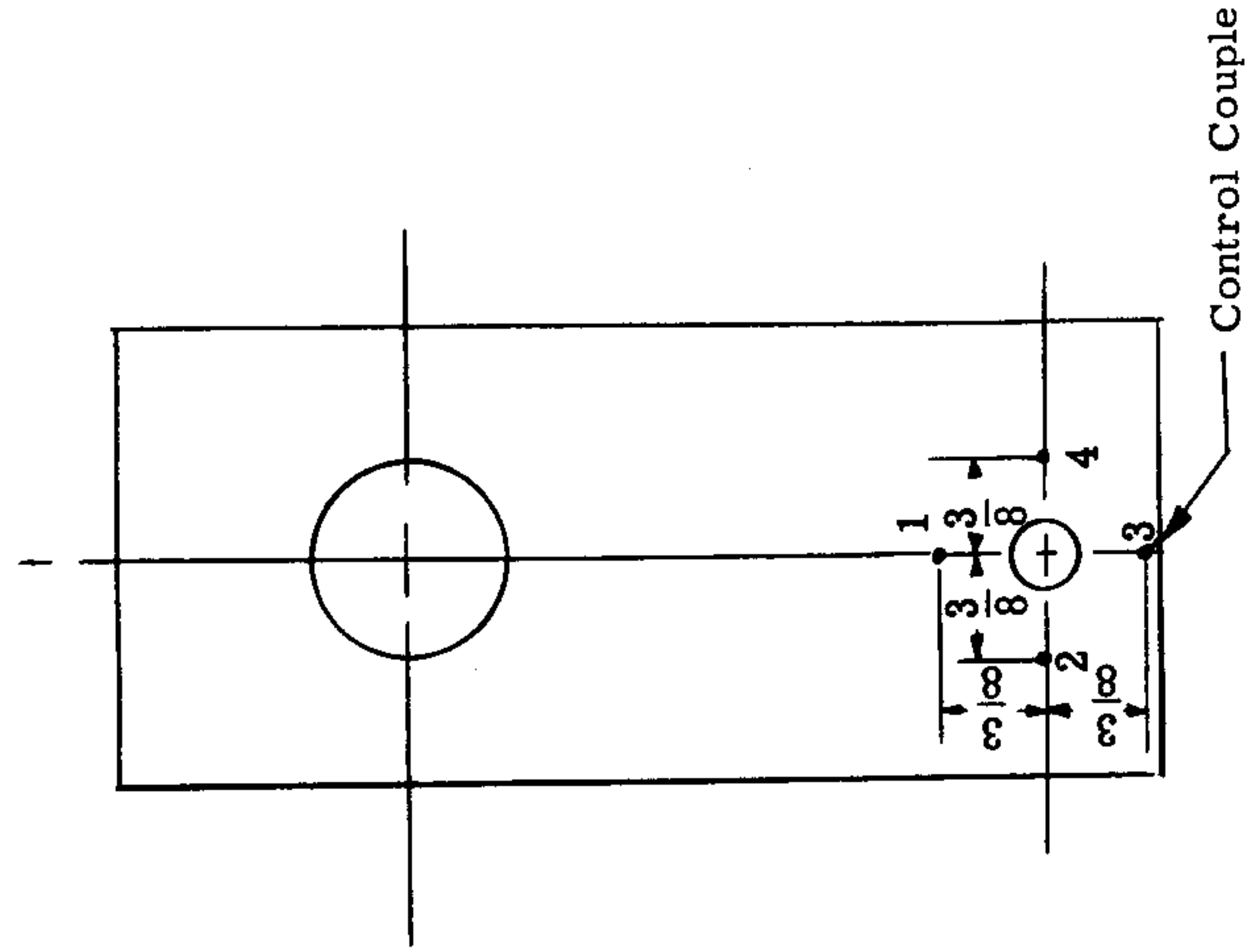

Temp. at Thermocouples

	Controller Temperature Setting, ° F				
1	400	600	800	1000	1200
2	402	600	800	997	1199
3	401	598	801	1001	1205
4	397	603	801	1000	1205

Cyclic-Control Variation $\pm 5^\circ$ F

Fig. 15. Bearing-Test Specimen Showing Location of Thermocouples and Corresponding Temperatures During Temperature-Distribution Survey

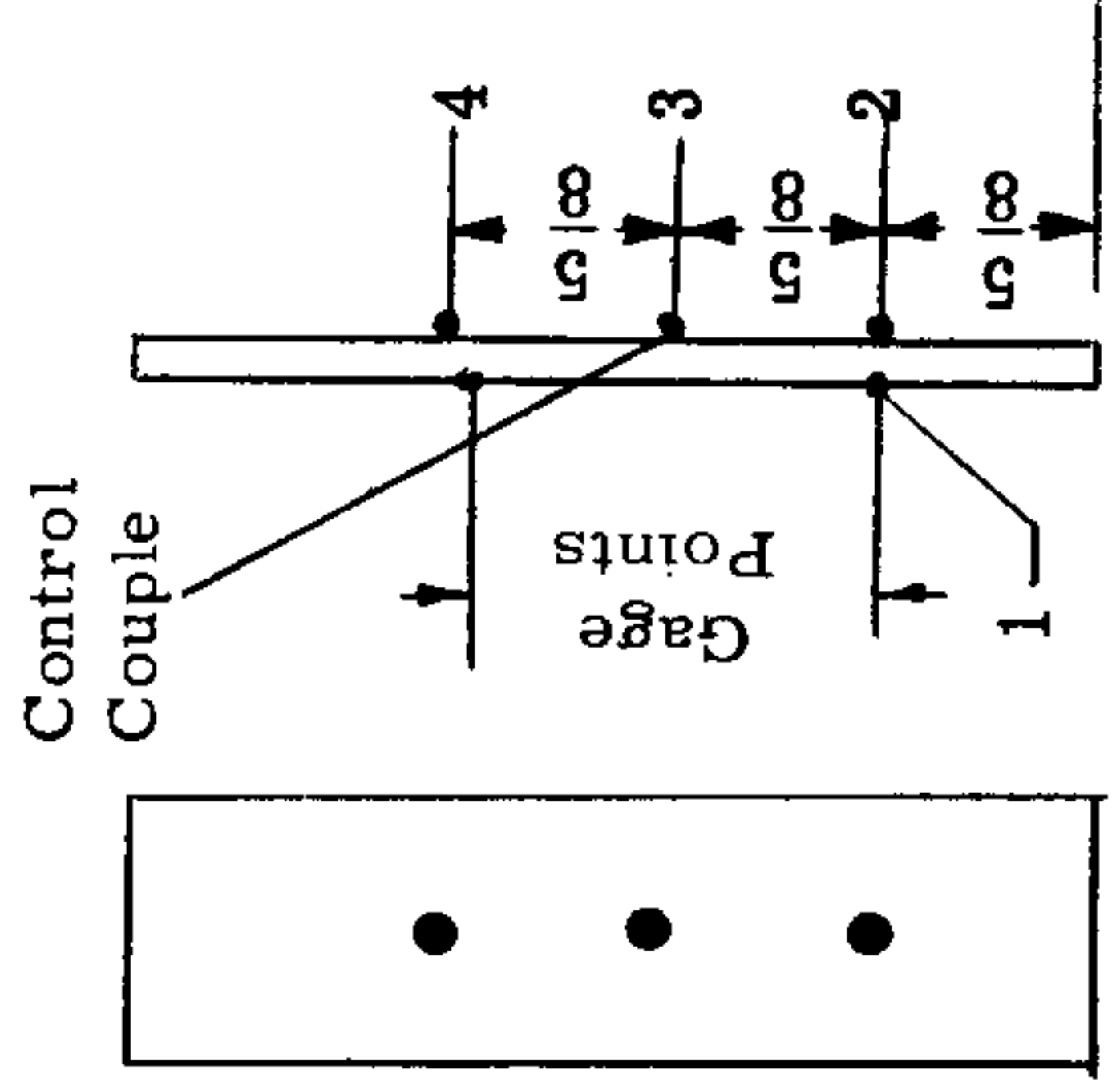

Temp. at Thermocouples

Thermocouples	400	600	800	1000	1200
1	395	598	794	993	1193
2	395	598	798	998	1195
3	400	603	798	998	1200
4	400	602	800	1000	1202

Controller Temperature Setting, °F

Cyclic-Control Variation + 5° F

Fig. 16. Compression-Test Specimen Showing Location of Thermocouples and Corresponding Temperature During Temperature-Distribution Survey.

Up to the 0.2%-offset yield point, the tensile and compression tests were run at a strain rate of 0.0025 in./in./min. Above the yield point in the tensile tests, the strain rate was increased to 0.020 in./in./min. In the shear and bearing tests, the crosshead speed was set at a rate equivalent to that used in the compression tests.

SECTION VII. TEST RESULTS

The test results are shown in graphical form in Fig. 17 through Fig. 137, and they are shown in tabulated form in Tables 4 through 39. In the tables, graphs, and discussion below, the results are grouped for the different test materials in the following order:

1. A-286 austenitic alloy
2. 17-7 PH stainless steel
3. Thermold J alloy steel
4. Type 420 stainless steel
5. Type 422 stainless steel
6. 17-22 A (S) alloy steel

Four types of graphs are shown in the following order for each test material:

1. Properties as functions of exposure time at the elevated testing temperatures. The points on these curves represent the average values shown in the tabulated data.
2. Properties as functions of temperature at constant exposure times. In these curves properties are expressed as percentages of room-temperature properties. Average property values were also used in plotting these curves.
3. A typical stress-strain curve for tensile, compression, and bearing tests under each condition. Each of these

curves is a reproduction of the recorded data from one specific test, and does not represent an average. The preyield and postyield tensile stress-strain curves were plotted on separated pages so that a number of curves could be shown on a single page.

4. A typical curve showing tangent modulus as a function of stress for each compression test condition. Each of these curves also represent results obtained in one specific test rather than average results.

The exposure time for the room temperature tests was considered to be 1000 hours. No data representing shorter holding times at room temperature can be presented since the test metals had been at room temperature for a considerable period of time before being tested.

7.1 A-286 Alloy Sheet, Quenched and Tempered

The test results for this alloy are shown graphically in Fig. 17 through 36 and are tabulated in Tables 4 through 9. Fig. 17 shows very little difference in the tensile strengths of the 0.062-in. sheet and 3/16-in. plate throughout the ranges of temperature and of exposure time covered by this work.

In general, variations in exposure time from 1/2 hour to 1000 hours at the various test temperature had no major or consistent effects upon the strength properties and modulus of elasticity of this alloy. Although some small increases in strength and some small decreases in strength occurred after holding times of 100 hours and 1000 hours, particularly at the higher test temperatures, these effects were rather small and inconsistent. Since the A-286 is a precipitation-hardening alloy, it is believed that these fluctuations in strength were a result of precipitation phenomena.

The tensile percent-elongation values of the A-286 alloy were affected very little by variations in temperature and in holding time. After 1/2-hour exposures at temperatures from 600° F to 1200° F, all elongation values were in the range 20% to 27%; after 1000-hour exposures at the same temperatures, the elongation values were in the range 17% to 21%.

Fig. 22, 23, and 24 show that the strength properties and modulus of elasticity of A-286 alloy decreased only a small amount as temperature was increased from 75° F to 1200° F, all of these properties at 1200° F being about 70% or more of the room-temperature properties. At 1200° F, this alloy retained about 90% or more of its room-temperature tensile and compressive yield strengths.

As shown in Fig. 26, 27, and 28, the tensile stress-strain curves of this alloy had a sharp downward discontinuity just before rupture. The shape of the postyield tensile stress-strain curves changed slightly with increasing temperature, the strain at which the ultimate strength was reached decreasing from near the rupture point at 75° F to only slightly beyond the yield point at 1200° F. The compressive stress-strain curves and the bearing stress-deformation curves for this alloy had conventional shapes as shown in Fig. 29 through 33.

Variations in exposure time had no consistent effects upon the compressive tangent modulus curves for this material.

7.2 17-7 PH Stainless Steel Sheet, RH 950 Condition

Tables 10 through 15 and Fig. 37 through 56 show the test results for the 17-7 PH stainless steel sheet in the RH 950 condition.

As shown in Fig. 37, under most test conditions the ultimate tensile strength of the 0.062-in. sheet was somewhat higher than that of the 3/16-in. plate. The differences in ultimate tensile strength ranged from about 2000 psi to 22,000 psi.

With the exception of ultimate shear strength, the strength properties of this alloy increased considerably with increasing exposure times at 300° F. At 600° F, the effects of exposure time on the strength properties were, in general, rather small and inconsistent. At 1000° F, some of the strength properties increased, whereas others remained constant or decreased slightly with increasing exposure times. The ultimate shear strength and tensile and compressive moduli of elasticity of this alloy were not significantly affected by variations in exposure time at any of the test temperatures. The tendency for this alloy to increase in strength with increasing exposure at 800° F was probably a result of increased precipitation hardening over that obtained in the heat treatment. The 600° F test temperature was probably not high enough to effect appreciable additional precipitation, whereas the alloy probably tended to overage at 1000° F.

Fig. 39 shows that, whereas the tensile percent elongation of the 17-7 PH (RH 950) was not greatly affected by exposure time, the elongation decreased slightly with increasing temperature up to 600° F and then increased considerably with further increases in temperature up to 1000° F.

The strength properties of this alloy, as shown in Fig. 43 through 46, decreased only moderately with increasing temperatures up to 800° F and then decreased sharply with further increases in temperature, most

strength properties at 1000° F being about 40% of the room-temperature strength. Tensile and compressive modulus-of-elasticity values decreased about 20% to 30% as temperature was increased from 75° F to 1000° F.

At 75° F and 600° F, the stress-strain curves of this material, as shown in Fig. 48, contained a considerable flat portion at the ultimate load, which occurred about midway between the yield point and the rupture point. At 800° F and 1000° F, the ultimate load was reached at a strain only slightly beyond the yield point, and then the load decreased continuously until the specimens ruptured.

The compressive tangent-modulus curves of this material were not appreciably changed by variations in exposure time at 600° F, whereas the increasing stress levels reached in the tangent-modulus curves with the longer exposure times at 800° F and at 1000° F reflect the improved compressive strength with increasing exposure time.

7.3 Thermold J Alloy Steel Sheet, Quenched and Tempered

The test data for the Thermold J alloy are tabulated in Tables 16 through 21 and are illustrated in Fig. 57 through 78.

The ultimate tensile strength of the 3/16-in. plate was somewhat higher than the ultimate strength of the 0.062-in. sheet at all test temperatures as shown in Fig. 57. This difference in strength was probably the result of a slight amount of decarburization that occurred during the austenitizing treatment at 1850° F. The decarburized surface layer would be expected to have a greater relative effect on the thinner material. Similar variations between the tensile strengths of the 0.062-in. sheet and the 3/16-in. plate were found, probably for the same reason, in the Type 420 stainless, Type 422 stainless, and 17-22 A (S) alloys.

Increasing exposure times from 0.5 hour to 1000 hour had no significant effect upon the strength properties of Thermold J alloy at temperatures up to 800° F. Over the same range of exposure times at 1000° F and at 1100° F, however, all of the strength properties decreased considerably. Since the test material had been tempered at 1000° F, its structure was, undoubtedly, reasonably stable at lower temperatures. The prolonged exposures at 1000° F and 1100° F, however, had an effect equivalent to additional tempering, which produces coalescence of the carbides and an associated decreased strength.

With the possible exceptions of the large decrease in tensile modulus and moderate decrease in compressive modulus with long exposures at 1100° F, the variations in modulus of elasticity with changes in holding

time are not believed to be significant. The decreases in modulus with increasing exposures at 1100° F are associated with corresponding decreases in tensile and compressive strength, which are a result of structural changes as discussed above. Under these conditions of low strength and structural instability, it is probable that the alloy has poor resistance to creep, i. e. poor resistance to plastic flow below the apparent proportional limit. Modulus-of-elasticity measurements in such materials are quite sensitive to changes in strain rate, modulus apparently decreasing with decreasing strain rate. Such variations in modulus determinations do not represent true changes in elastic properties but, rather, are a result of plastic flow that occurs during the apparent elastic portion of the tests. Since the tensile and compressive tests were run at relatively slow strain rates, it is believed that such plastic flow resulted in the low apparent modulus values in Thermold J after long exposures at 1100° F.

Little variation in tensile elongation occurred in the Thermold J alloy as exposure times were increased from 0.5 hour to 1000 hours at 600° F and 800° F. The tensile elongation increased slightly at 1000° F and increased greatly at 1100° F when exposure times were extended to 1000 hours. These increases were, undoubtedly, associated with the decreases in strength and the structural instabilities discussed above. With increasing temperature, tensile elongation changed very little between 75° F and 600° F and then increased considerably between 600° F and 1100° F.

As shown in Fig. 62 through 65, most of the strength properties of the Thermold J alloy decreased to about 80% of their room-temperature levels as temperature was increased to 800° F and then decreased more sharply with further increases in temperature, the sharper drops in strength occurring in the specimens with the longer exposure times. Tensile and compressive moduli values also decreased with increasing temperatures, but not as sharply as the strength properties.

In the plastic portions of the tensile stress-strain curves, the ultimate load tended to occur at about the same value of strain regardless of the test temperature. As the temperature was increased from 600° F to 1100° F, however, the degree of strain on the descending portion of the curves beyond the ultimate load increased considerably. At 600° F, the descending portion of the stress-strain curves beyond the ultimate load was marked by several abrupt variations in load, the load decreasing sharply and then increasing sharply several times. With each sharp decrease, a "popping" noise was emitted from the specimen. It is believed that each sharp decrease was a result of a sudden small amount of slippage along certain crystallographic planes. This sudden rapid slippage resulted in a small amount of yielding in the specimen that allowed the

load to decrease. The load then increased again until it was sufficiently high to cause another sudden slippage phenomenon. Once this process started it was repeated until the specimen broke.

At temperatures up to 800° F, the compressive-tangent-modulus curves for Thermold J alloy were not significantly affected by changes in exposure time. As a result of the declining compressive strength with increasing exposure times at 1000° F and 1100° F, the stress levels for the tangent modulus curves decreased with increasing exposure times.

7.4 Type 420 Stainless Steel Sheet, Quenched and Tempered

Tables 22 through 27 contain data from tests on Type 422 stainless steel; Fig. 79 through 98 are graphical illustrations of the same data.

In this material, the 3/16-in.-thick plate consistently had slightly higher tensile strength than the 0.062-in.-thick sheet as shown in Fig. 79.

At test temperatures up to 800° F, variations in exposure time had no significant effect upon the strength properties and the tensile elongation of this alloy. Increasing exposure times at 1000° F, however, resulted in appreciable decreases in all strength properties and in increased elongation. Since, in the original heat treatment, the Type 420 had been tempered at 1000° F, the structure was, apparently, stable at lower temperatures. At the 1000° F exposure temperature, however, further tempering---carbide coalescence---resulted in decreased strength and increased elongation. The compressive and tensile moduli of elasticity of this material were not appreciably affected by variations in exposure time and associated structural changes.

The tensile elongation of the Type 420 changed very little with changes in temperature between 75° F and 800° F. When the temperature was increased to 1000° F, the elongation approximately doubled.

The strength properties of this material, in general, decreased less than 20% as the temperature was increased from 75° F to 800° F. As the temperature was increased from 800° F to 1000° F, the strength properties dropped sharply to levels between 60% and 30% or less of the same properties at room temperature. Tensile and compressive moduli of elasticity decrease less rapidly with increasing temperature, the values at 1000° F being 70% or more of those at room temperature.

In the tensile stress-strain curves at temperatures up to 800° F, the ultimate tensile strength was reached after about one half or more of

the plastic strain had occurred as shown in Fig. 89 and 90. At 1000° F, however, the ultimate strength was reached just beyond the yield point. As in the Thermold J alloy at 600° F, Fig. 89 shows that the plastic strain in the Type 420 stainless at 600° F occurred in a very discontinuous manner after the ultimate load was reached. Each sharp decrease in load was again accompanied by a "popping" noise, which is believed to be associated with sudden small amounts of slippage on certain crystallographic planes.

The compressive tangent-modulus curves for this material were affected very little by changes in exposure time at temperatures up to 800° F. At 1000° F, the stress levels for the tangent-modulus curves decreased with increasing exposure times because of the decreasing compressive strength.

7.5 Type 422 Stainless Steel Sheet, Quenched and Tempered

The test data for this material are tabulated in Tables 28 through 33 and are illustrated in Fig. 99 through 117. In the various tables and graphs for this material, it will be noted that, with the exception of ultimate tensile strength, the data for the 10-hour exposure time at 400° F are not shown. Whereas all tests representing this condition were run, the strength values were unusually low because, it is believed, the specimens were inadvertently aged at 1200° F instead of at 400° F. Additional tensile specimens, both from the 0.062-in. sheet and from the 3/16-in. plate, were prepared and tested after 10-hour exposure at 400° F. As shown in Fig. 99, the ultimate tensile strengths determined in these check tests were in close agreement with the results for the other exposure times. Although sufficient time was not available for a complete set of check tests, it is felt that the checks on the ultimate strength prove that the original data were erroneous, and that no unusual effects on the strength of this alloy are produced by a 10-hour exposure at 400° F.

Fig. 99 shows that the strength of the 3/16-in. plate was somewhat higher than that of the 0.062-in. sheet at all test temperatures.

Variations in exposure time had no effect upon the strength properties of this alloy at temperatures up to 800° F. The strength properties tended to decrease only slightly with increasing exposure times at 1000° F, which is equivalent to the tempering temperature used in the heat treatment of this alloy. This decrease in strength was, undoubtedly, a result of the continuation of the tempering process during the exposures at 1000° F. No significant changes in tensile and compressive modulus of elasticity occurred as a result of variations in exposure time at any of the test temperatures.

As shown in Fig. 101, only minor variations in tensile elongation occurred in Type 422 stainless steel as a result of variations in exposure time. The percent elongation, which was practically constant at temperatures between 75° F and 800° F, increased appreciably when the temperature was increased from 800° F to 1000° F.

Both the strength properties and the moduli of elasticity of the Type 422 stainless decreased at a rather moderate and uniform rate with increasing temperatures from 75° F to 1000° F. At 1000° F, most of these properties were approximately 60% or more of the same properties at room temperature.

Fig. 108 and 109 show that very little change occurred in the shape of the tensile stress-strain curves as the temperature varied between 75° F and 800° F, rupture occurring at only a small degree of strain beyond the ultimate load. At 1000° F, the ultimate load occurred at a smaller amount of strain, and the specimens elongated a great deal more beyond the ultimate load.

The compressive tangent-modulus curves, as shown in Fig. 115, 116, and 117, varied only slightly with changes in exposure time, the largest variations occurring at 1000° F as a result of the decrease in strength with increasing exposure time.

7.6 17-22 A (S) Alloy Steel Sheet, Quenched and Tempered

The test results for this alloy, which are given in Tables 34 through 39, are plotted in Fig. 118 through 137. Fig. 118 shows that the 3/16-in. plate had somewhat higher tensile strength than the 0.062-in. sheet at all test temperatures.

Variations in exposure time, in general, had only minor and rather inconsistent effects upon all of the properties of this alloy. At 1000° F, some of the strength properties tended to decrease slightly with increasing exposure times, whereas the other strength properties remained practically constant; at lower temperatures, some of the strength properties tended to increase slightly with increasing exposure times, whereas the other strength properties remained practically constant.

Variations in temperature and in exposure time had very little effect upon the tensile elongation of this alloy, all of the values that were determined falling in the range 11% to 18% as shown in Fig. 120.

The ultimate-strength and rupture-strength properties of the 17-22 A (S) alloy remained almost constant as the temperature was increased from 75° F to 600° F, whereas most of the yield-strength properties decreased somewhat in this temperature range. This behavior of the strength properties of 17-22 A (S) alloy at temperatures between 75° F and 600° F is typical of low-alloy steels and of carbon steels. It is a result of strain aging, which is believed to be associated with a migration of carbon atoms to dislocation sites in the lattice structure when the metal is plastically strained. At temperatures up to about 700° F the carbon atoms tend to "pin" the dislocations, which phenomenon has a strengthening effect. Since plastic strain is necessary for strain aging, the strengthening effect is usually greater on ultimate strength and on rupture strength than on yield strength. At 1000° F, all of the strength properties of the 17-22 A (S) alloy, with the exception of the tensile rupture strength were in the range 60% to 80% of the room-temperature values. The tensile rupture strength at 1000° F, however, had decreased to 20% to 40% of the room-temperature rupture strength. As the temperature was increased from 75° F to 1000° F, the tensile and compressive moduli of elasticity of this alloy decreased continuously to values equivalent to about 60% to 80% of the room-temperature values.

At temperatures up to 600° F, all of the stress-strain curves for this material were quite similar in shape, the stress falling off rapidly to the rupture point immediately after the ultimate load had been reached as shown in Fig. 128. Fig. 129 shows that, at 800° F, the ultimate load occurred at a relatively lower degree of strain approximately midway between the yield point and the rupture point. At 1000° F, the ultimate load was reached just beyond the yield point, and then the load decreased gradually until the rupture point was approached.

Variations in exposure time had no consistent effects upon the compressive tangent-modulus curves for this alloy as shown in Fig. 135 through 137.

SECTION VIII. DISCUSSION

Fig. 138 and 139 show comparisons of the strengths of the test alloys after exposures of 1000 hours and of 1/2 hour at the various test temperatures, Fig. 138 representing ultimate tensile strengths and Fig. 139 representing compressive yield strengths.

As shown in these illustrations, at temperatures up to 800° F, the higher strengths were exhibited by the Thermold J, 17-7 PH (RH 950), the and Type 420 alloys, whereas progressively lower strengths were found in the Type 422, A-286, and 17-22 A (S) alloys. These strength levels, however, do not necessarily provide valid comparisons of the optimum strengths obtainable in all of the test alloys. The Type 422 stainless, for example, was tempered at 1000° F whereas the Type 420 was tempered at 900° F. The lower tempering temperature accounts for the higher strength in the Type 420. A more valid comparison would have been obtained if these two stainless alloys had been tempered at equal temperatures. The two alloy steels—Thermold J and 17-22 A (S)—were tempered to widely different hardness levels, Thermold J being tempered at 1000° F and the 17-22 A (S) at 1300° F, which is a relatively high tempering temperature for a low-alloy steel of this type. Tempering treatments to equivalent hardness levels would have provided a sounder basis for comparison of the properties of these two alloys.

As the temperature was increased above 800° F, the strength of the Thermold J, 17-7 PH (RH 950), and Type 420 decreased sharply, whereas the strength of the Type 422 and 17-22 A (S) decreased only moderately. The A-286 decreased in ultimate tensile strength only slightly and in compressive strength negligibly as the temperature was increased from 75° F to 1200° F. At temperatures above 1000° F after the exposure time of 1000 hours, the strength of the A-286 exceeded those of all other test metals. After the one-half-hour exposure at temperatures of 1000° F and above, only the strength of the Thermold J exceeded that of the A-286. The strength of the Type 422 stainless, which was relatively low at low temperatures, equaled or exceeded those of the Type 420 and 17-7 PH (RH 950) alloys at 1000° F.

Fig. 138 and 139 show plainly the decreases in strength in the Thermold J, Type 420 and Type 422 with increasing exposure times at 1000° F as discussed previously. They also show the large increase in strength in the 17-7 PH (RH 950) with increasing exposure time at 800° F and the fluctuations in strength in the A-286, as a result of precipitation phenomena, at temperatures between 800° F and 1200° F.

In order to show any simple correlations among the different properties, the following ratio relationships were determined for each test material at each test temperature:

1. Ultimate bearing strength, $e/d = 2$, to ultimate shear strength.
2. Ultimate bearing strength, $e/d = 2$, to ultimate tensile strength.

WADC TR 58-365

3. Ultimate bearing strength, $e/d = 2$, to ultimate bearing strength, $e/d = 1.5$.
4. Tensile modulus of elasticity to compressive modulus of elasticity.
5. Tensile rupture strength (based on original cross-sectional area) to ultimate tensile strength.
6. Tensile rupture strength (based on final cross-sectional area) to ultimate tensile strength.
7. Ultimate shear strength to ultimate tensile strength.
8. Bearing yield strength, $e/d = 2$, to tensile yield strength.
9. Bearing yield strength, $e/d = 2$, to bearing yield strength, $e/d = 1.5$.
10. Compressive yield strength to tensile yield strength.

In order to detect any important effects of exposure time on these ratios, they were calculated both for the tests carried out after the one-half-hour exposure time and for tests carried out after the one-thousand-hour exposure time at each test temperature. Only property values determined under the same conditions of temperature and of exposure time were used in calculating the individual values of the ratio relationships.

The ratio relationships are shown as functions of temperature in Fig. 140 through 151. For legibility, the plots of the various relationships are shown on two graphs for each test material.

In all of the test metals, some fluctuations occurred in the ratio relationships as a result of variations in temperature and in exposure time. In most instances, these fluctuations were minor and inconsistent and are not believed to be significant. None of the ratio relationships in the A-286 alloy, for example, changed greatly with increasing temperature or with increasing exposure time. In general, the ratios of ultimate bearing strength ($e/d = 2$) to ultimate shear strength tended to decrease appreciably with increasing temperatures, whereas the ratios of ultimate shear strength to ultimate tensile strength increased over the same temperature range. These effects, which were only minor in A-286 alloy and in 17-22 A (S) alloy, were quite pronounced in the other test alloys. The ratios of tensile rupture strength (based on both the original and on the final cross-sectional areas of

the specimens) to ultimate tensile strength tended to decrease with increasing temperatures, although these effects were not entirely consistent in the A-286, 17-7 PH (RH 950), and Type 422 alloys.

In most of the test alloys, the change in exposure time from 1/2 hour to 1000 hours resulted in deviations in some of the ratio relationships primarily at the higher test temperatures. These deviations, which were most pronounced in the 17-7 PH (RH 950), Thermold J, Type 420 alloys, were, in general, quite inconsistent and are not believed to be highly significant.

Table 40, which shows the ratio relationships for all of the test metals at room temperature, provides an indication of the consistency of the ratios among different alloys at a single temperature and a single exposure time, the exposure time for the room-temperature tests being considered infinite. The ratios shown in Table 40 are reasonably consistent among the different test materials; $\pm 20\%$ about the middle of the range is the greatest percentage variation, occurring in the ratio of tensile rupture strength (based on the final cross-sectional area of the specimen) to ultimate tensile strength. For a number of the ratio relationships at room temperature—ultimate bearing strength ($e/d = 2$) to ultimate tensile strength, ultimate bearing strength ($e/d = 2$) to ultimate bearing strength ($e/d = 1.5$), and tensile modulus to compressive modulus—the variations about the middle of the range were less than $\pm 5\%$.

For each test metal, Table 41 shows the maximum and minimum ratio relationships based upon the test results for the 1/2-hour and 1000-hour exposure times over the entire range of test temperatures. The over-all ranges of ratio relationships for the combined test metals are also shown in this Table. These over-all relationships varied about their mean values by the following percentages:

1. Ult. bearing str., $e/d = 2$, to ult. bearing str. $e/d = 1.5$, $\pm 17\%$.
2. Ult. bearing str., $e/d = 2$, to ult. tensile str., $\pm 18\%$.
3. Compressive yield str. to tensile yield str., $\pm 18\%$.
4. Bearing yield str., $e/d = 2$, to tensile yield str., $\pm 23\%$.
5. Bearing yield str., $e/d = 2$, to bearing yield str., $e/d = 1.5$, $\pm 25\%$.
6. Tensile mod. of elast. to compressive mod. of elast., $\pm 30\%$.

7. Ult. shear str. to ult. tensile str., $\pm 30\%$.
8. Ult. bearing str., $e/d = 2$, to ult. shear str., $\pm 33\%$.
9. Tensile rup. str. (based on final cross-sectional area) to ultimate tensile strength $\pm 54\%$.
10. Tensile rup. str. (based on original cross-sectional area) to ultimate tensile strength $\pm 71\%$.

The general magnitudes of the various ratio relationships were quite similar to those determined for other alloys in previous work as reported in WADC Technical Report 56-340. The variations of the relationships about their means were also of the same order of magnitude, although somewhat less consistency would be expected in the present values since they were based upon data for 1/2-hour and 1000-hour exposure times rather than upon data that represented 1/2-hour exposure times and the averages for all exposure times as in the previous work.

As in the previous work, the numerical values of some of the ratio relationships can be explained on the basis of the configuration of the specimen and the method of load application. In the bearing specimens, for example, which usually failed in shear, the ratio of sheared area in specimens with $e/d = 2$ to sheared area in specimens with $e/d = 1.5$ was 1.33. This ratio is roughly equivalent to the ratio relationships of the ultimate bearing strengths of the two types of bearing specimens. In general, the ratios of bearing yield strength for the two types of specimens were slightly lower. These facts show that the ultimate-bearing-strength values varied in proportion to the sheared fracture area, which increased in proportion to the edge-distance to hole-diameter ratio. Since the bearing-yield strength values did not consistently increase to a similar degree with increasing shear area, it is believed that bearing yield strength is governed more by the characteristics of the metal immediately adjacent to the bearing hole than by the entire area that subsequently fails in shear.

Since both the bearing specimens and the shear specimens failed in shear, the ratio of the fracture areas correlated roughly with the ratio relationships of ultimate bearing strength to ultimate shear strength. The ratio of the fracture area in bearing specimens with $e/d = 2$ to the fracture area in the shear specimens was 2.83, which is near the middle of the range of the ratio of ultimate bearing strength to ultimate shear strength for all test metals.

The greatest scatter in the ratio relationships occurred in the 17-7 PH (RH 950) alloy. As shown in Table 41, of the ten types of ratio relationships

reported, both the maximum and minimum values for four of the relationships in the combined test results were determined by the maximum and minimum values for the 17-7 PH (RH 950) alloy. In two other relationships, either the combined maximum value or the combined minimum value was determined by the 17-7 PH (RH 950) alloy. The reason for the unusually large scatter in the ratio relationships of this alloy is not known.

SECTION IX. CONCLUSIONS

The strength properties of the six test alloys, in general, decreased only slightly with increasing temperature from 75° F to 800° F. With further increases in temperature, the alloys with higher room-temperature strength—Thermold J, 17-7 (RH 950), and Type 420—were weakened decidedly. Of the materials with lower room-temperature strength, the Type 422 and 17-22 A (S) weakened only moderately at temperatures up to 1000° F and the A-286 weakened only slightly at temperatures up to 1200° F. The moduli of elasticity of the various alloys decreased moderately, but consistently, with increasing temperatures. Tensile elongation values reacted erratically with changes in temperature, the higher elongations usually occurring at the highest test temperatures.

As a result of tempering reactions, the strength of the Thermold J and Type 420 decreased considerably and the strength of the 17-22 A (S) and Type 422 decreased slightly with increasing exposure times from 1/2-hour to 1000 hours at temperatures of 1000° F and above. At lower temperatures, since the structures apparently were stable, the properties of these alloys were not significantly affected by variations in exposure time. With increasing exposure times, precipitation phenomena resulted in an appreciable increase in the strength of 17-7 PH (RH 950) stainless at 800° F and in irregular fluctuations in the strength properties of the A-286 alloy at temperatures between 800° F and 1200° F. At other test temperatures, the 17-7 PH (RH 950) and the A-286 alloys were not appreciably affected by changes in exposure time. Moduli-of-elasticity values were not significantly affected and tensile-elongation values were affected only moderately or not at all by variations in exposure time, elongation values usually increasing when strength decreased as a result of prolonged exposures.

A comparison and correlation of the various properties showed that their ratio relationships for equivalent test conditions varied somewhat with differences in the material, in the temperature, and in the exposure time. For

Contrails

this reason, it is not possible to calculate highly accurate design data for a given property by means of a general factor relating that property to another property that has been determined experimentally. Precise and reliable data on the tensile, compressive, bearing, and shear properties of aircraft-structural materials can presently be obtained only by testing under the desired conditions.

Nevertheless, if the relationships that were determined in this work are used with a full understanding of their inaccuracies and their limitations, they will provide a fair indication of certain properties by calculation from a different property determination. The accuracy and consistency of the ratio relationships between different properties improves as the range of conditions from which they are obtained and to which they are applied becomes more restricted. For example, for the tests at room temperature, three of the ten relationships that were determined varied by less than + 5%, whereas only one varied as much as +20% among the six test alloys. When tests for the entire ranges of temperature and exposure time for all test materials are considered, the accuracy and reproducibility among the ten ratio relationships varied from + 17% to + 71%.

BIBLIOGRAPHY

1. Wilson, Bruce L., "Characteristics of Tuckerman Strain Gage," Proceedings ASTM, 40:1017, 1944.
2. Flanigan, A. E., Tedsen, L. E., and Dorn, J. E., "Compressive Properties of Aluminum Alloy Sheet at Elevated Temperatures," Proceedings ASTM, 46:951, 1956.
3. Flanigan, A. E., Tedsen, L. E., and Dorn, J. E., "Bearing Properties of 24S-T Sheet and Shear Strength of 24S-T Rivets at Elevated Temperatures," Trans. ASM, 38:789, 1947.
4. Templin, R. L., "Some Factors Affecting Strain Measurement in Tests of Metals," Proceedings ASTM, 34, Part II, 1934.
5. Tuckerman, L. B., "Optical Strain Gages and Extensometers," Proceedings ASTM, 23:602, Part II, 1923.
6. Perry, C. C., and Lissner, H. R., "The Strain Gage Primer," McGraw-Hill, 1955.
7. Doerr, D. D., "Determination of Physical Properties of Non-Ferrous Structural Sheet Materials at Elevated Temperatures," AF Technical Report No. 6517, Part 1, Dec. 1951 and Part I Supplement 1, Feb. 1953 for WADC by Armour Research Foundation under Contract No. AF 33-(038)-8681.
8. Doerr, D. D., "Determination of Physical Properties of Ferrous and Non-Ferrous Structural Sheet Materials at Elevated Temperatures," AF Technical Report No. 6517, Part 2 for WADC by Armour Research Foundation under Contract AF 33(038)-8681.
9. Miller, Donald., "Determination of Physical Properties of Ferrous and Non-Ferrous Structural Sheet Materials at Elevated Temperatures," AF Technical Report No. 6517, Part 3, June 1954, and Part 4, Dec. 1954 for WADC by Armour Research Foundation under Contract No. AF 33-(038)-8681.
10. Meyer, Richard D., "Applications of Unbonded-Type Resistance Gages," Instruments, March 1946, pp 136-139.
11. Mahen, H. M., "A High-Precision One-Inch Electrical Extensometer," Instruments, Sept. 1946, pp 502-505.
12. Melonas, John V., and Kattus, J. Robert, "Determination of Tensile, Compressive, Bearing, and Shear Properties of Ferrous and Non-Ferrous Structural Sheet Metals at Elevated Temperatures," WADC Technical Report 56-340, by Southern Research Institute under Contracts No. AF 33(616)-2741 and AF 33(616)-3224, October 1956

SECTION X. FIGURES AND TABLES OF TEST RESULTS

10.1 A-286 Alloy Sheet, Quenched and Tempered

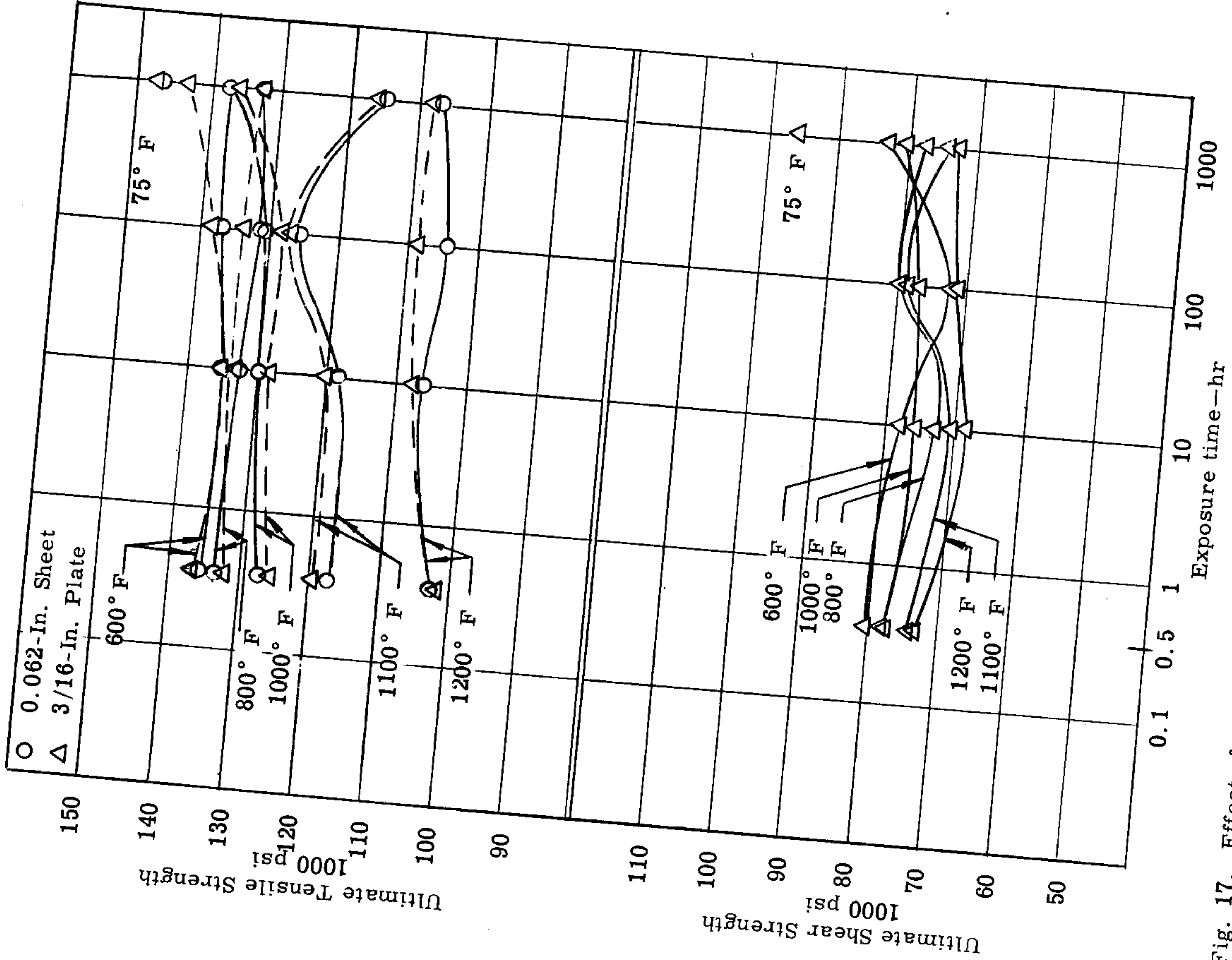

Fig. 17. Effect of exposure time on the ultimate tensile strength and ultimate shear strength of quenched and tempered A-286 austenitic alloy at different temperatures.

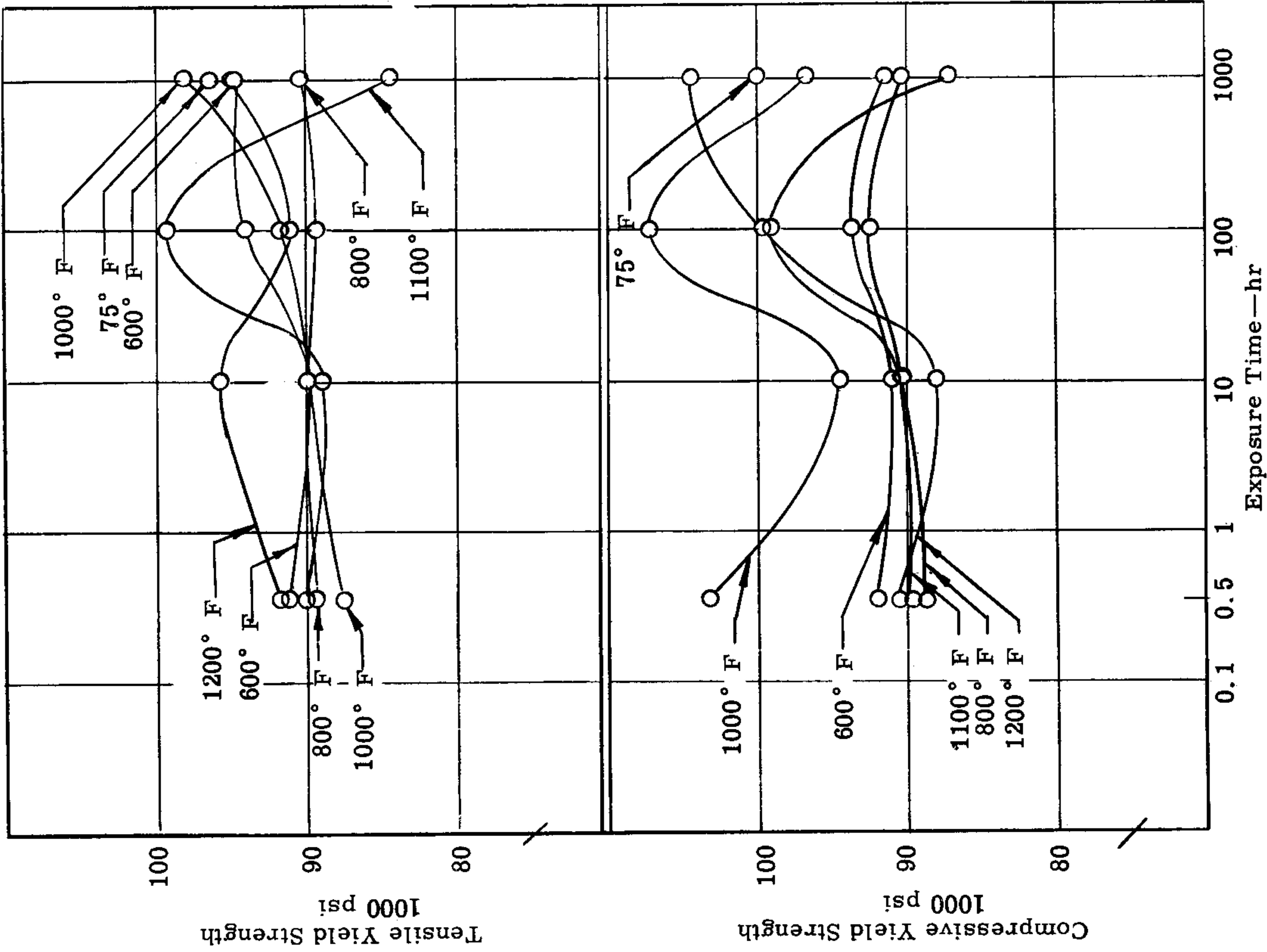

Fig. 18. Effect of exposure time on the tensile and compressive yield strength of quenched and tempered A-286 austenitic alloy sheet at different temperatures.

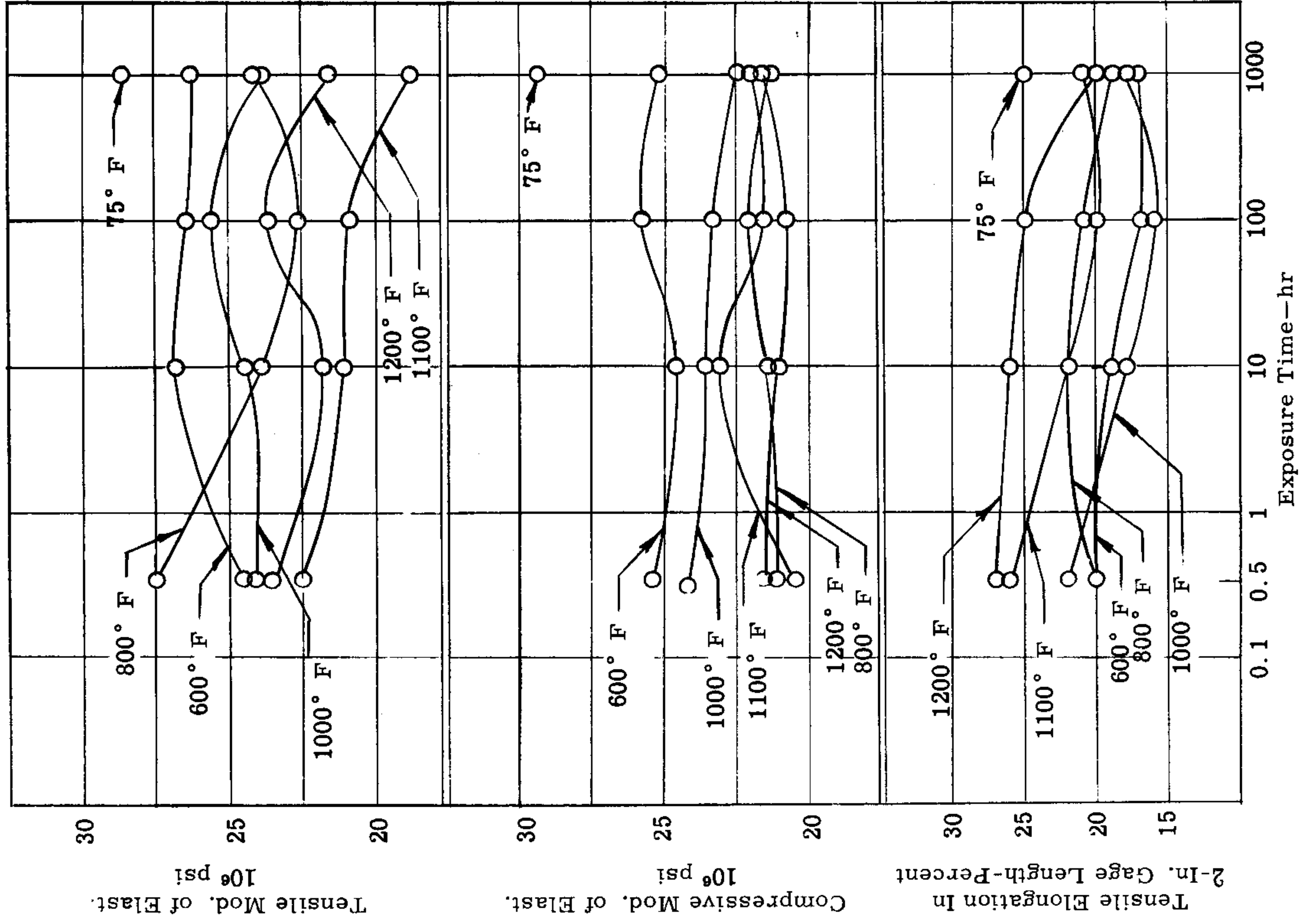

Fig. 19. Effect of exposure time on the tensile and compressive moduli of A-286 austenitic alloy sheet at different temperatures.

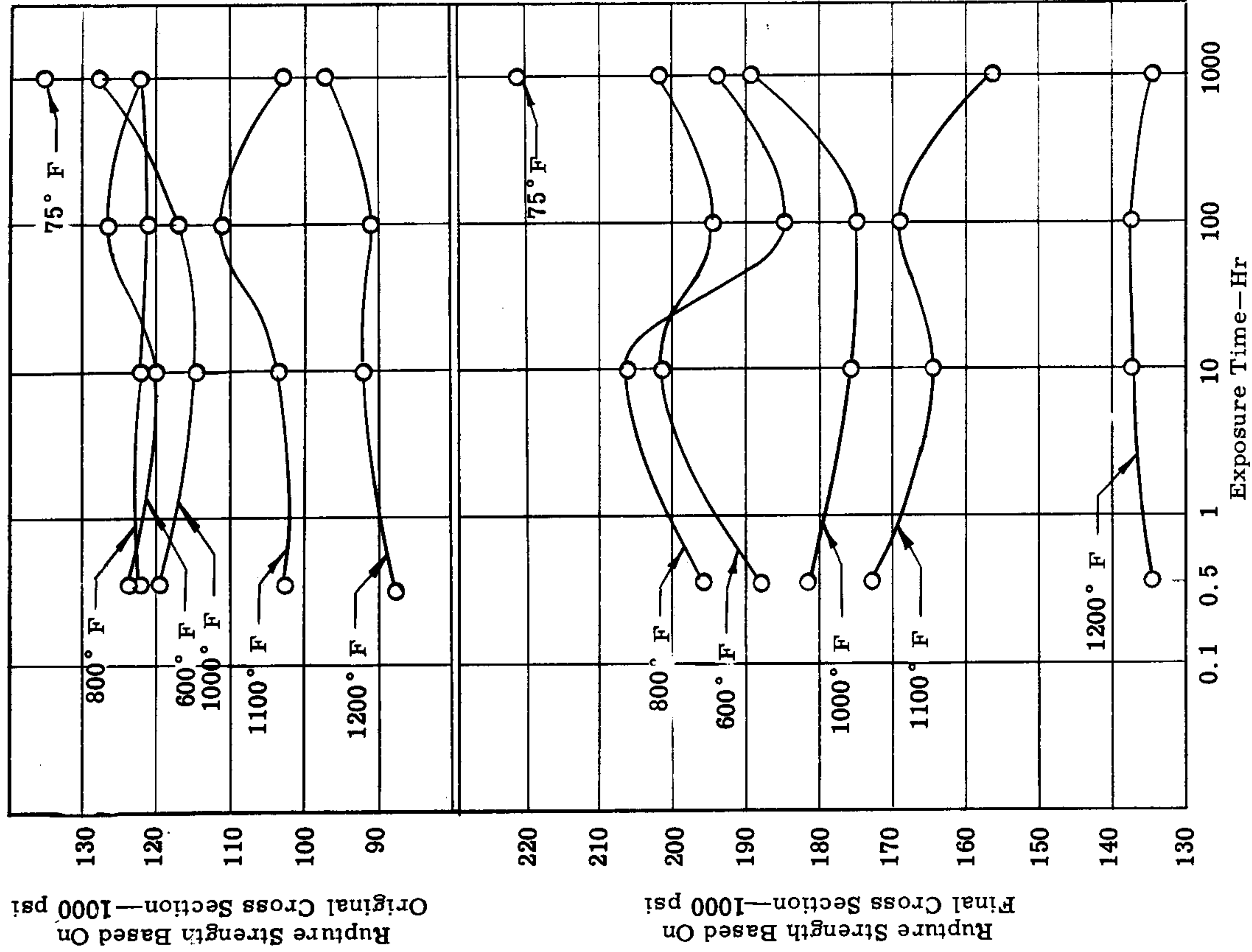

Fig. 20. Effect of exposure time on the tensile rupture strength of quenched and tempered A-286 austenitic alloy sheet at different temperatures.

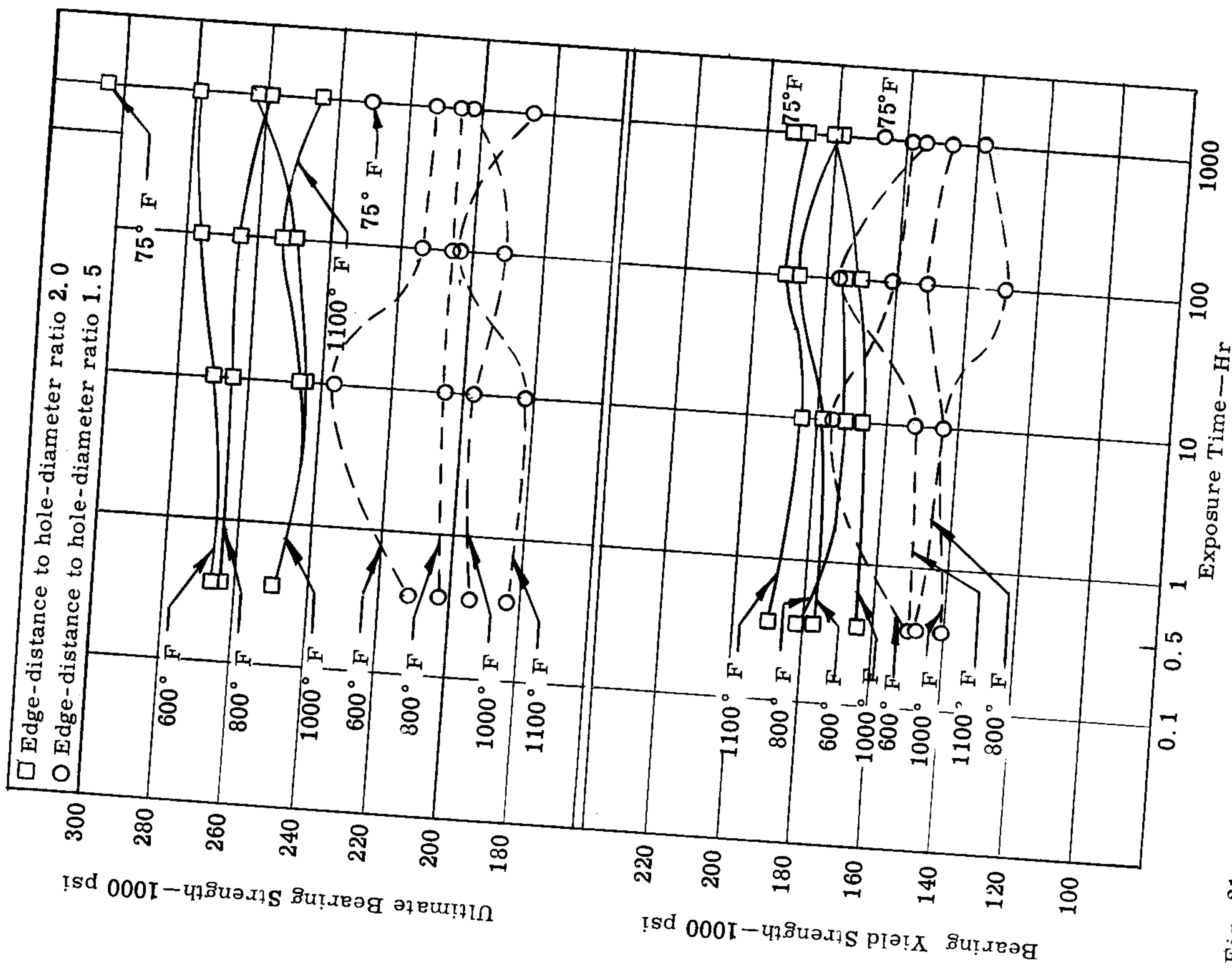

Fig. 21. Effect of exposure time on the bearing ultimate and yield strengths of quenched and tempered A-286 austenitic alloy sheet at different temperatures.

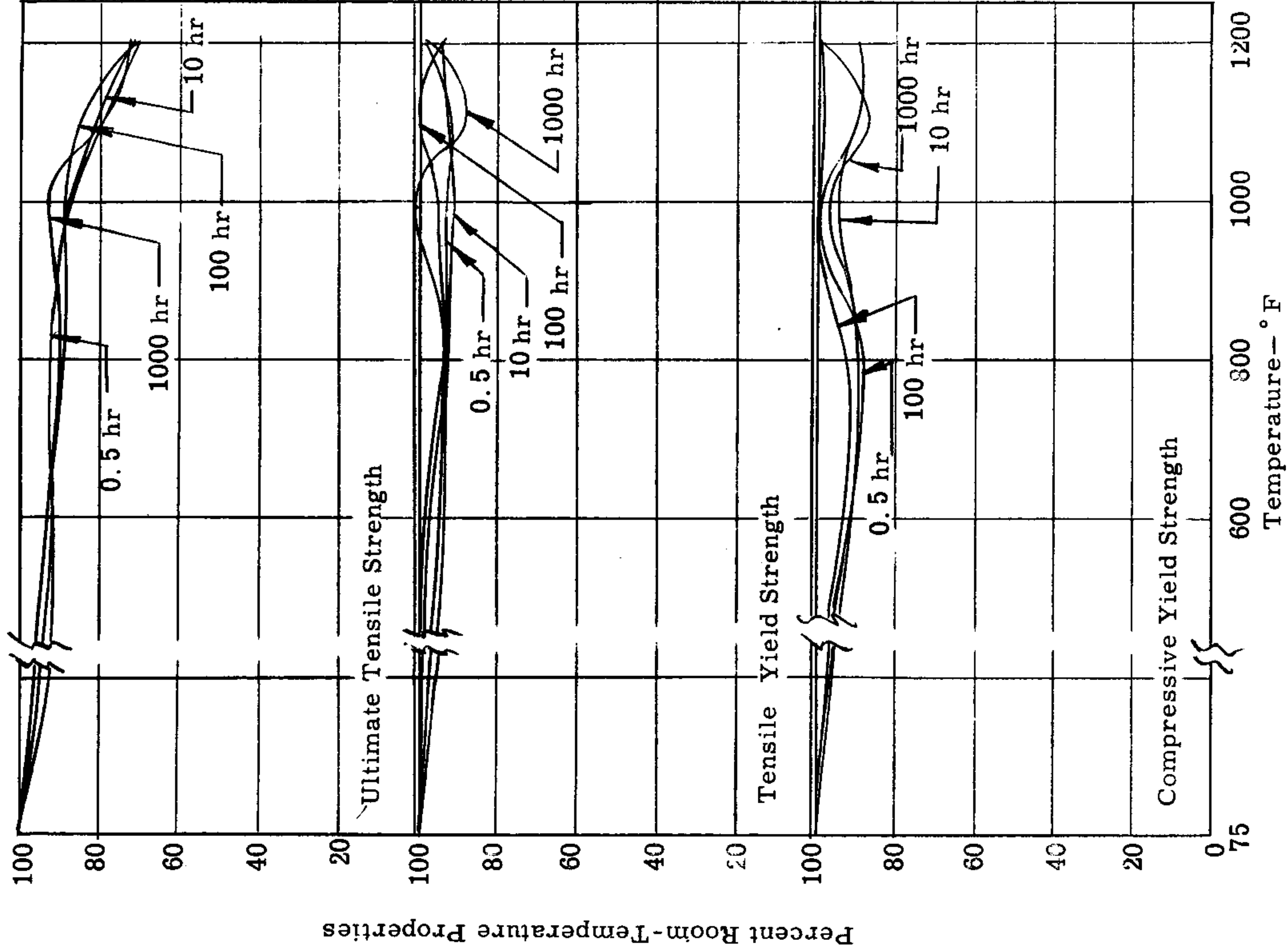

Fig. 22. Elevated-temperature strength properties as percent of room-temperature properties for quenched and tempered A-286 austenitic alloy sheet at different exposure times

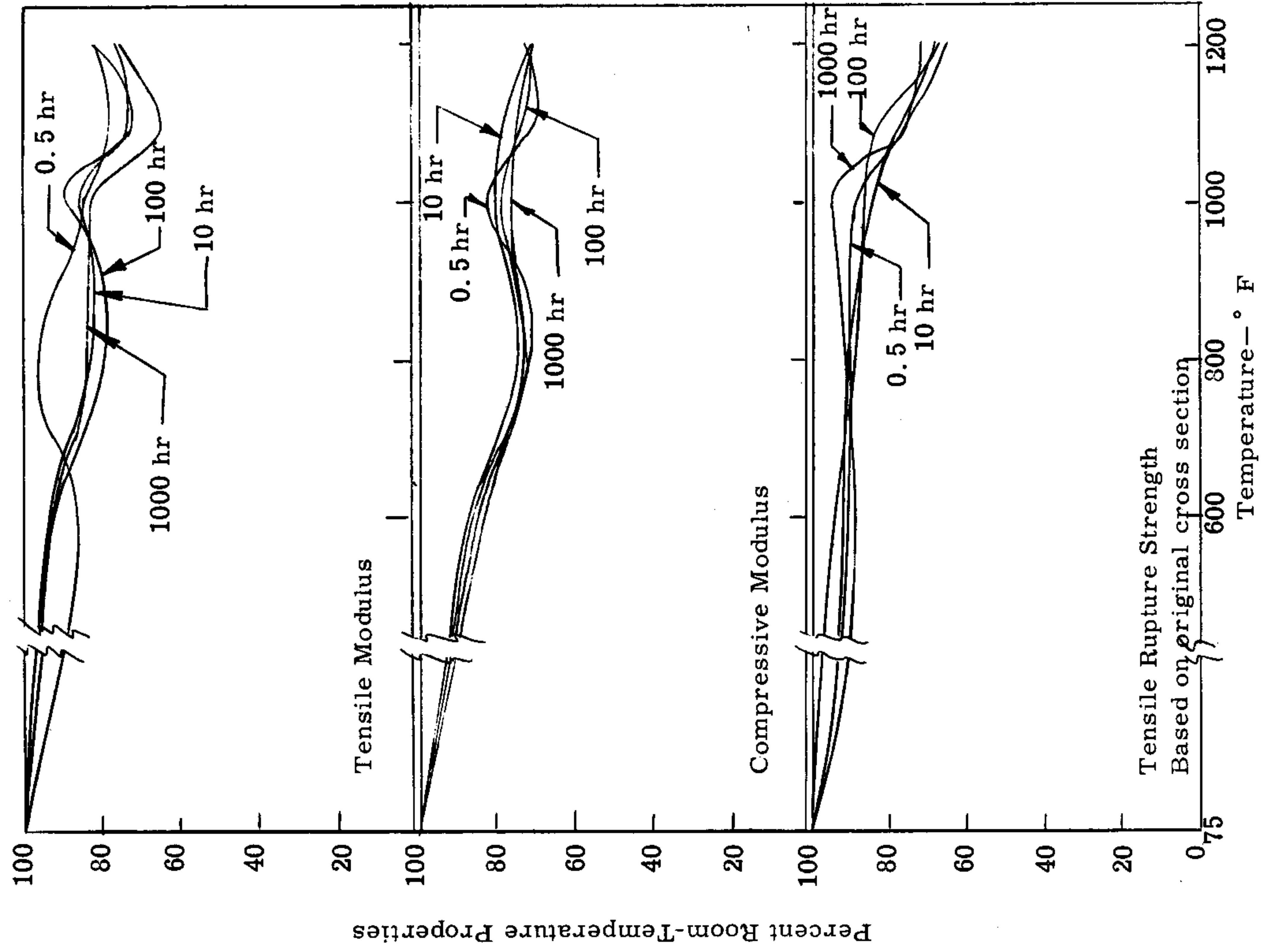

Fig. 23. Elevated-temperature properties as percent of room-temperature properties for quenched and tempered A-286 austenitic alloy sheet at different exposure times

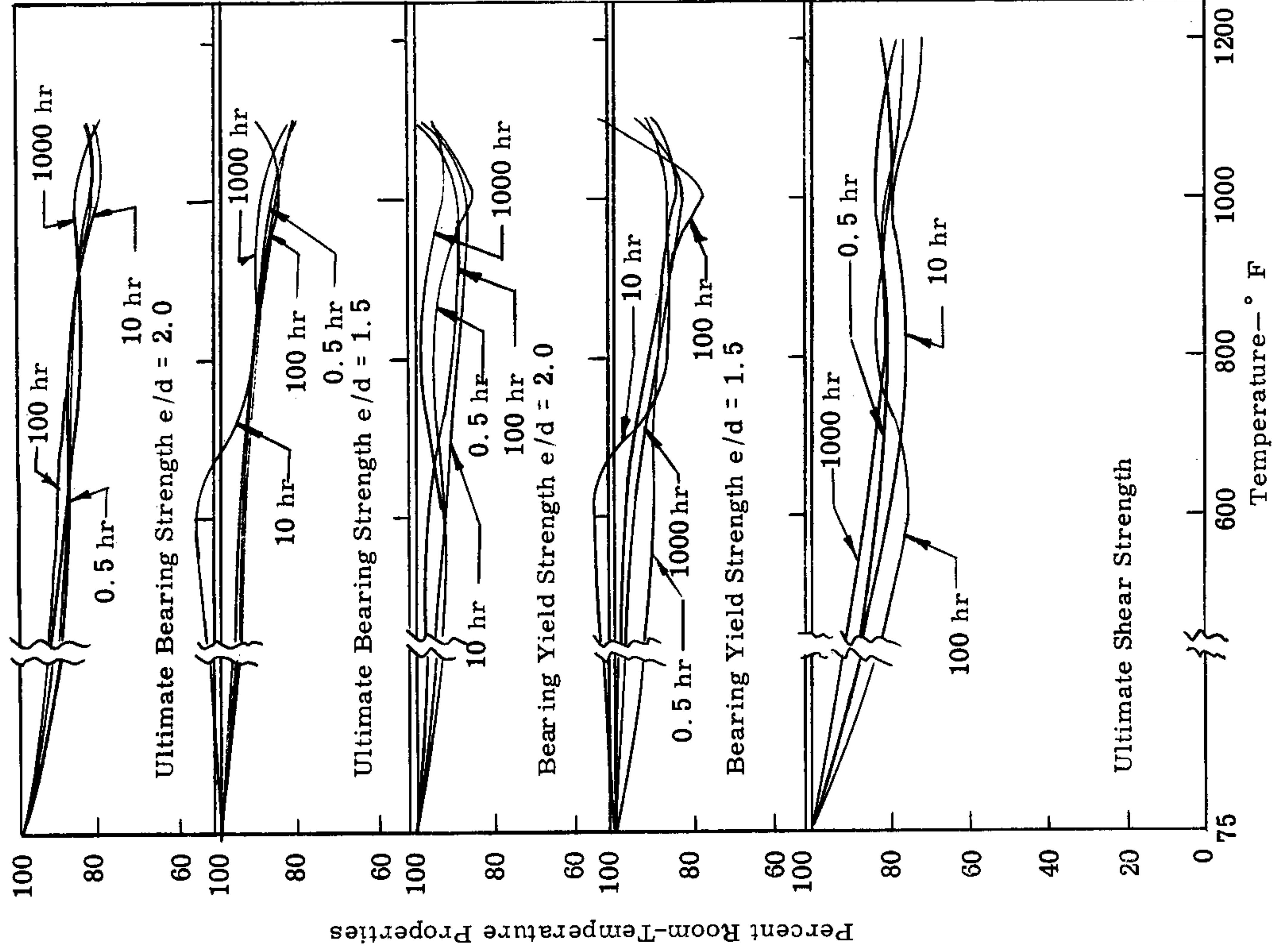

Fig. 24. Elevated-temperature strength properties as percent of room-temperature properties for quenched and tempered A-286 austenitic alloy sheet at different exposure times.

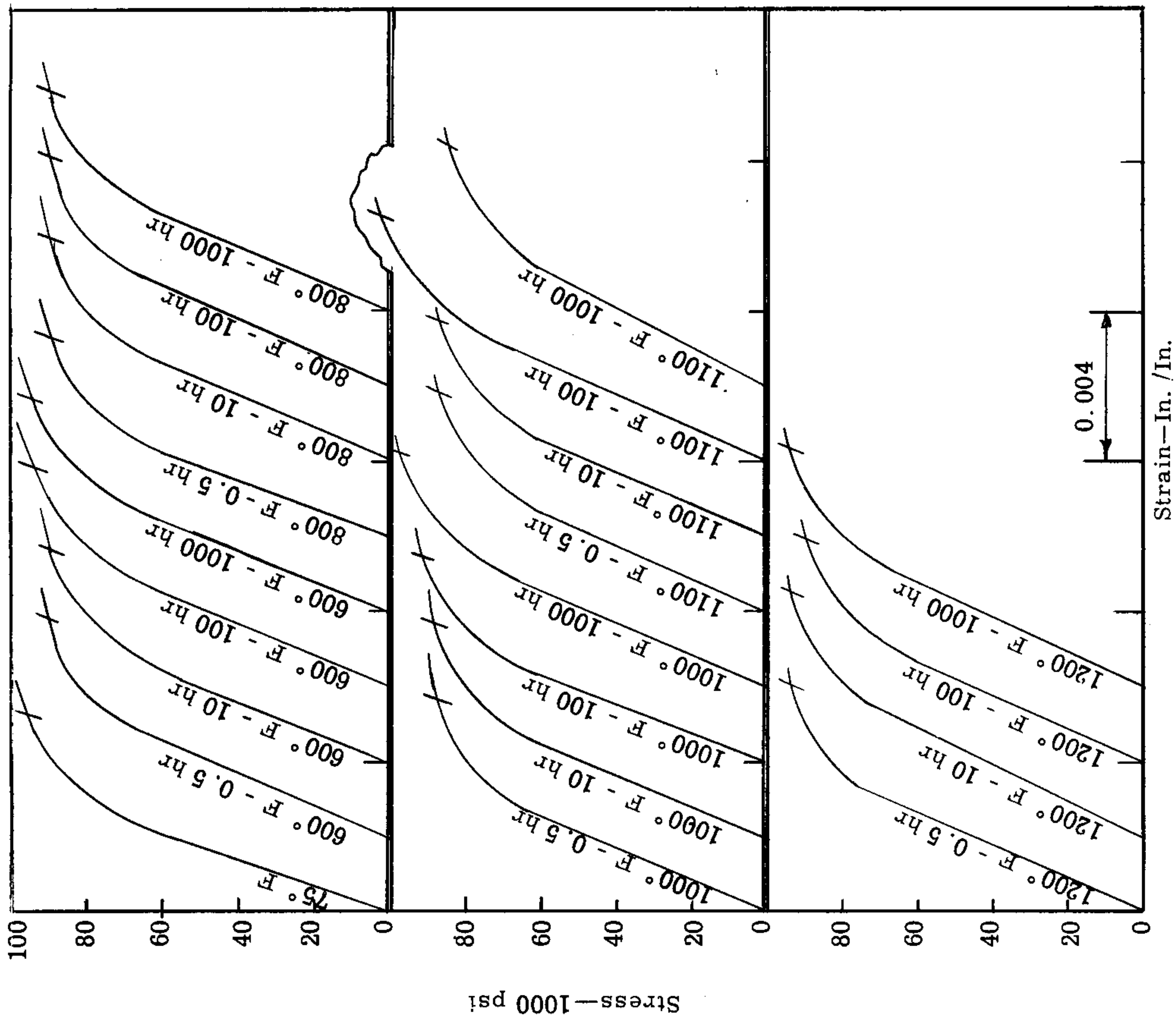

Fig. 25. Tensile stress-strain curves for quenched and tempered A-286 austenitic alloy sheet at various temperatures and exposure times.

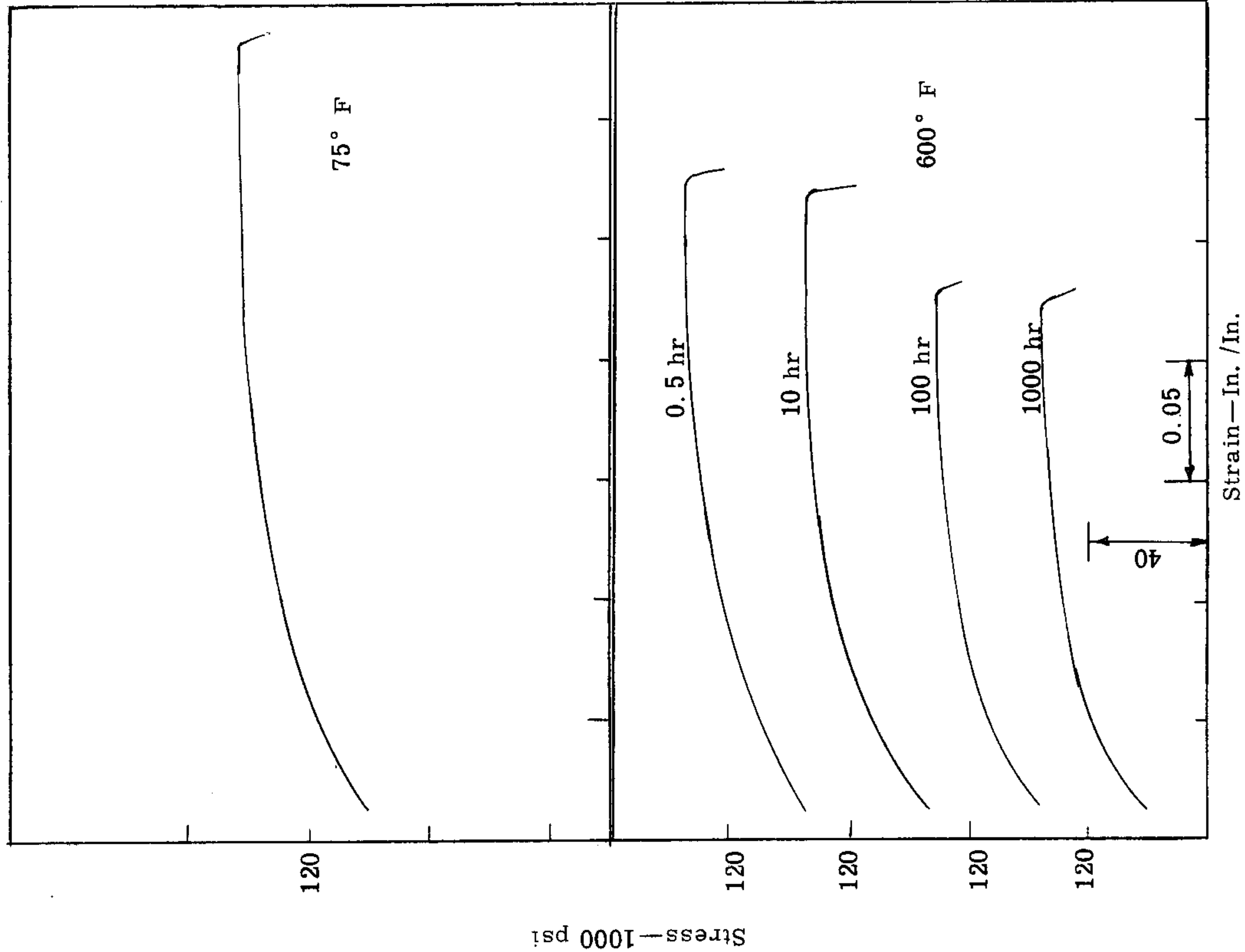

Fig. 26. Tensile postyield stress-strain curves for quenched and tempered A-286 austenitic alloy sheet at various temperatures and exposure times.

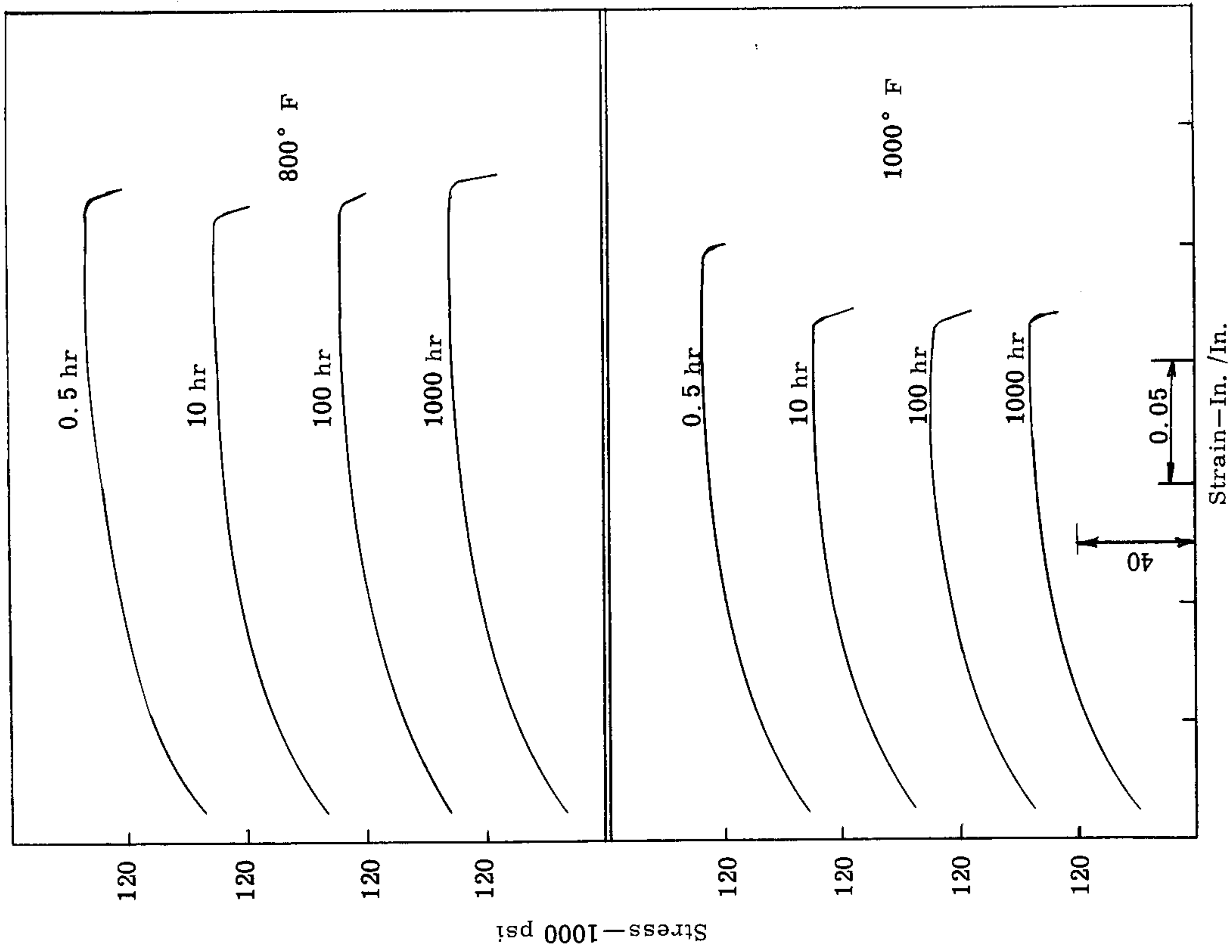

Fig. 27. Tensile postyield stress-strain curves for quenched and tempered A-286 austenitic alloy sheet at various temperatures and exposure times.

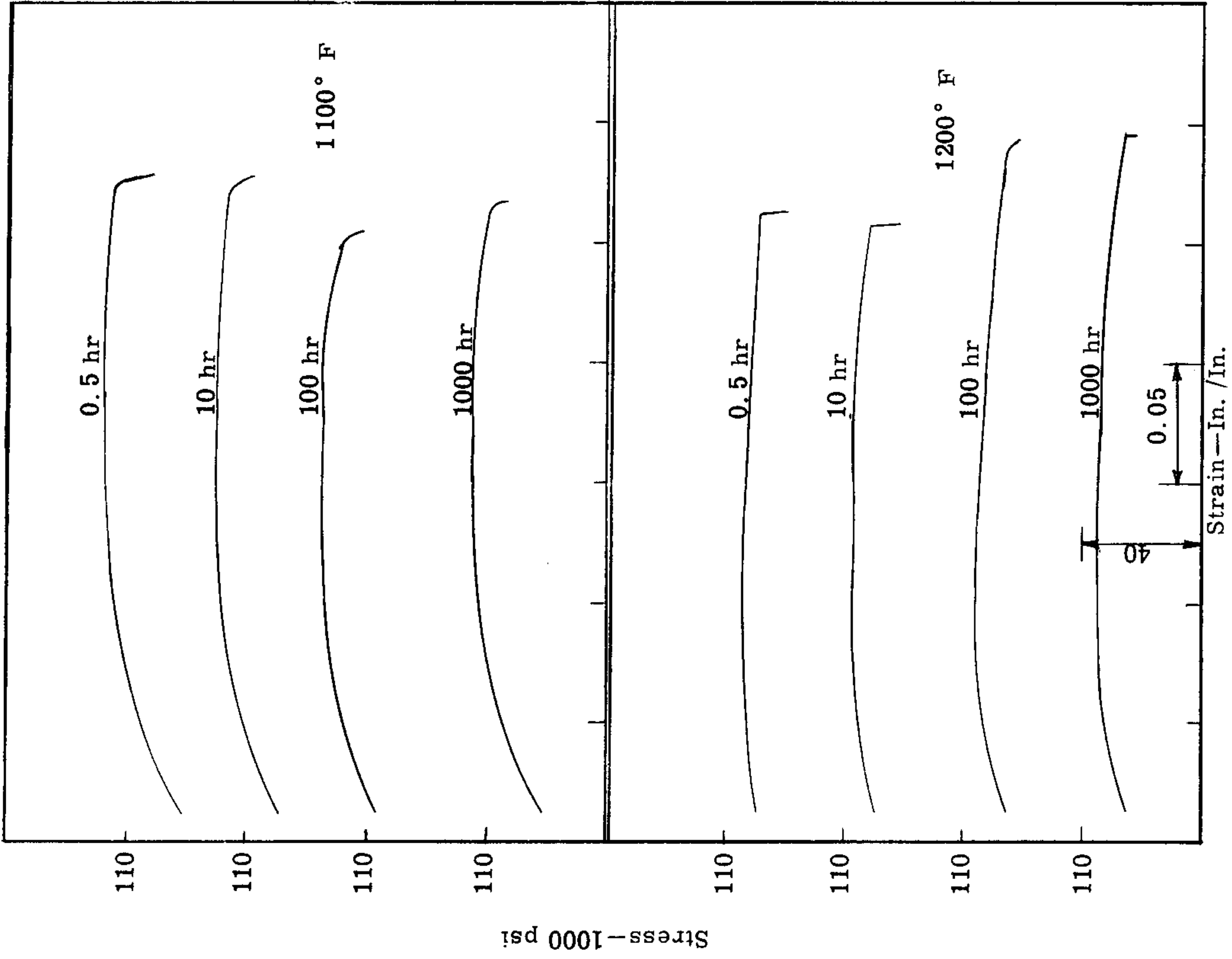

Fig. 28. Tensile postyield stress-strain curves for quenched and tempered A-286 austenitic alloy sheet at various temperatures and exposure times.

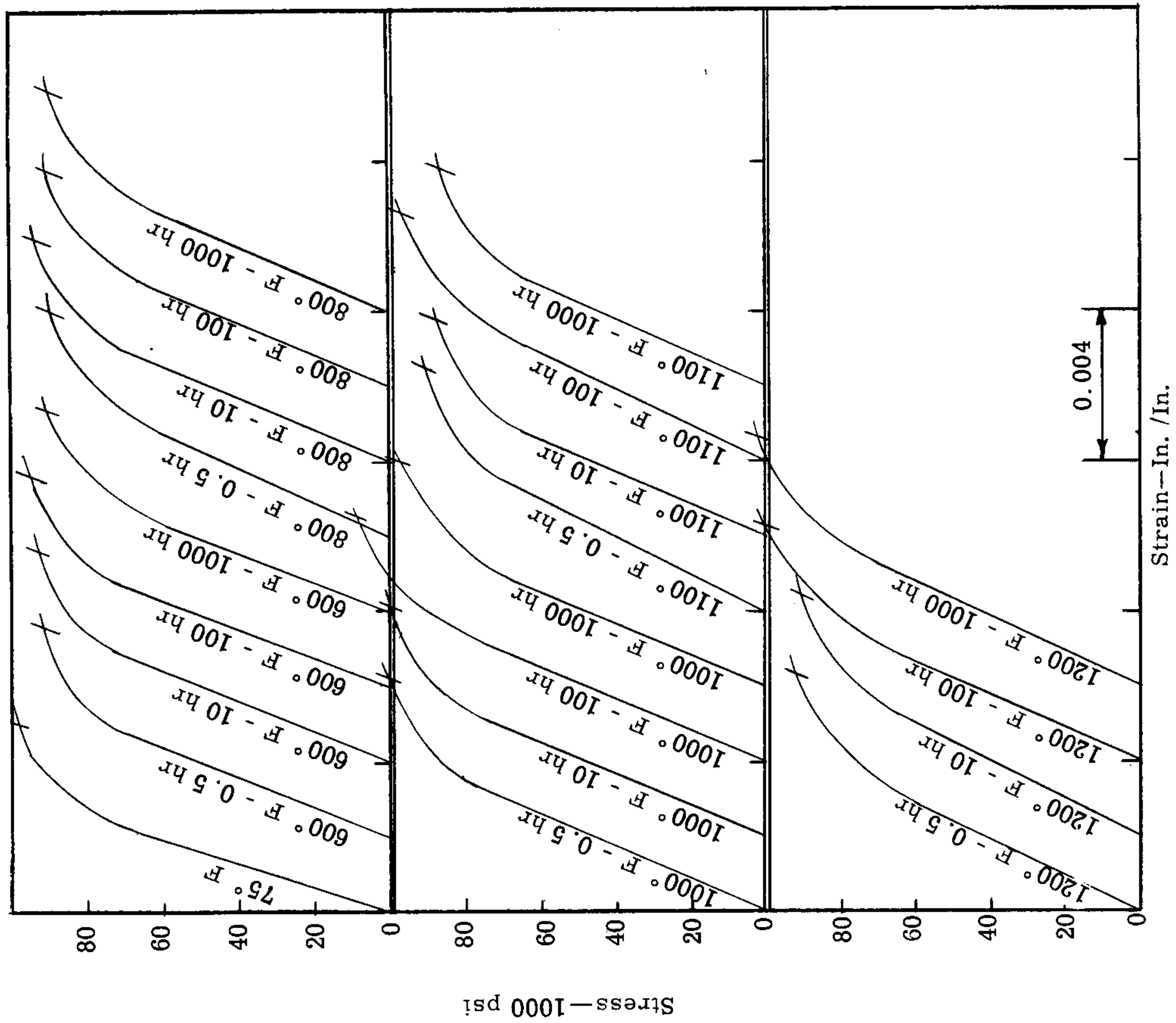

Fig. 29. Compressive stress-strain curves for quenched and tempered A-286 austenitic alloy sheet at various temperatures and exposure times.

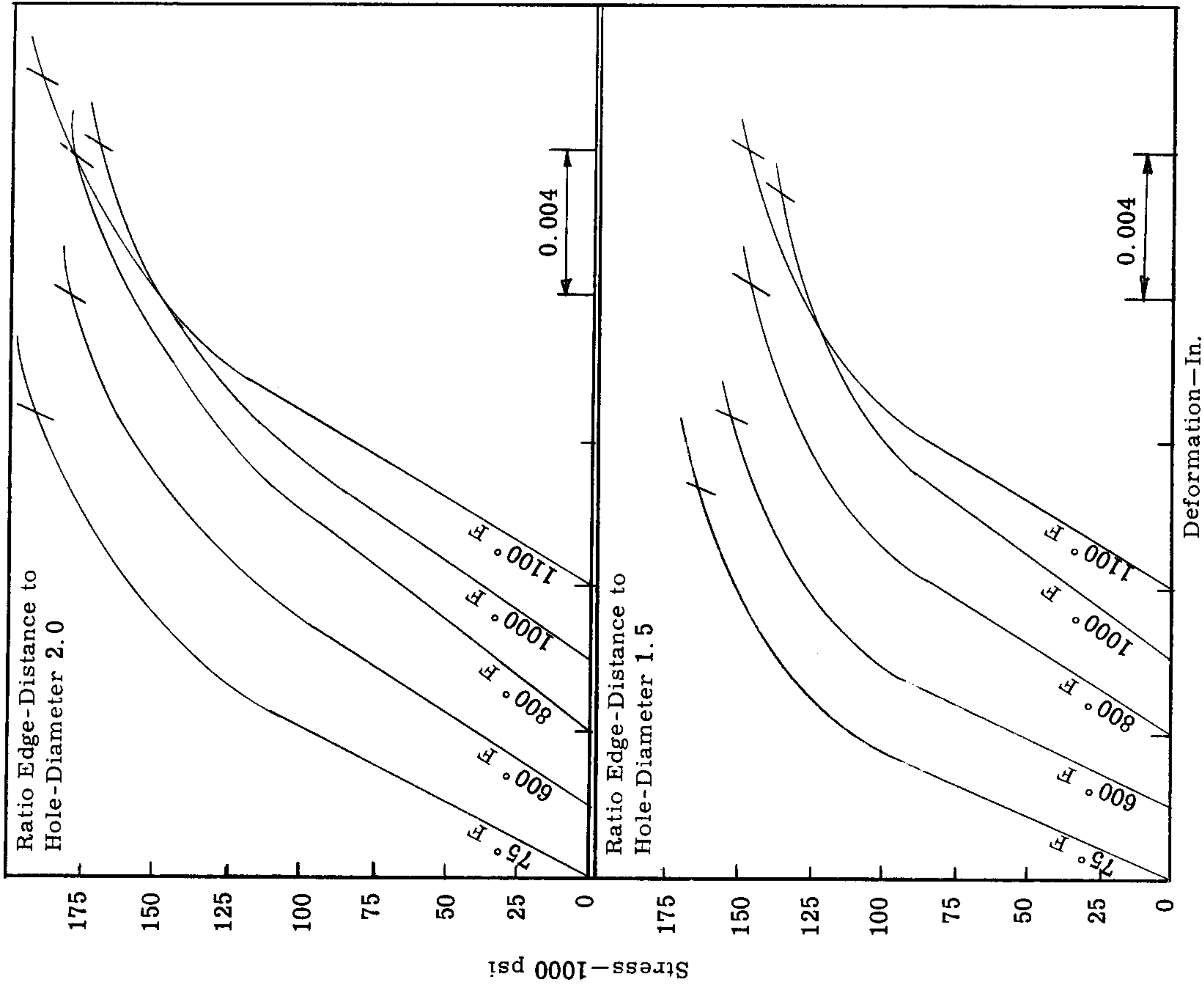

Fig. 30. Bearing stress-deformation curves for quenched and tempered A-286 austenitic alloy sheet at various temperatures and one-half hour exposure time

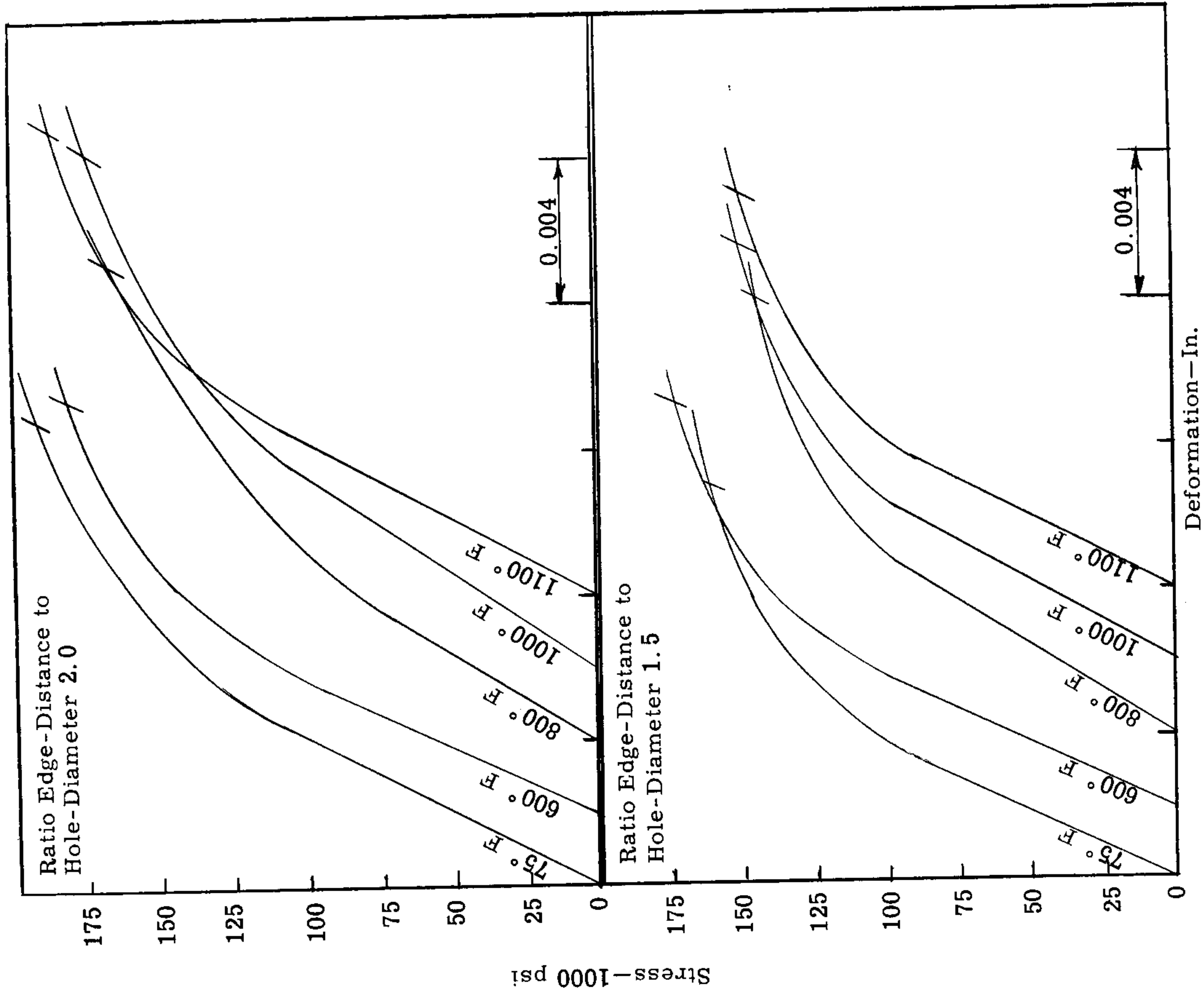

Fig. 31. Bearing stress-deformation curves for quenched and tempered A-286 austenitic alloy sheet at various temperatures and ten-hour exposure time.

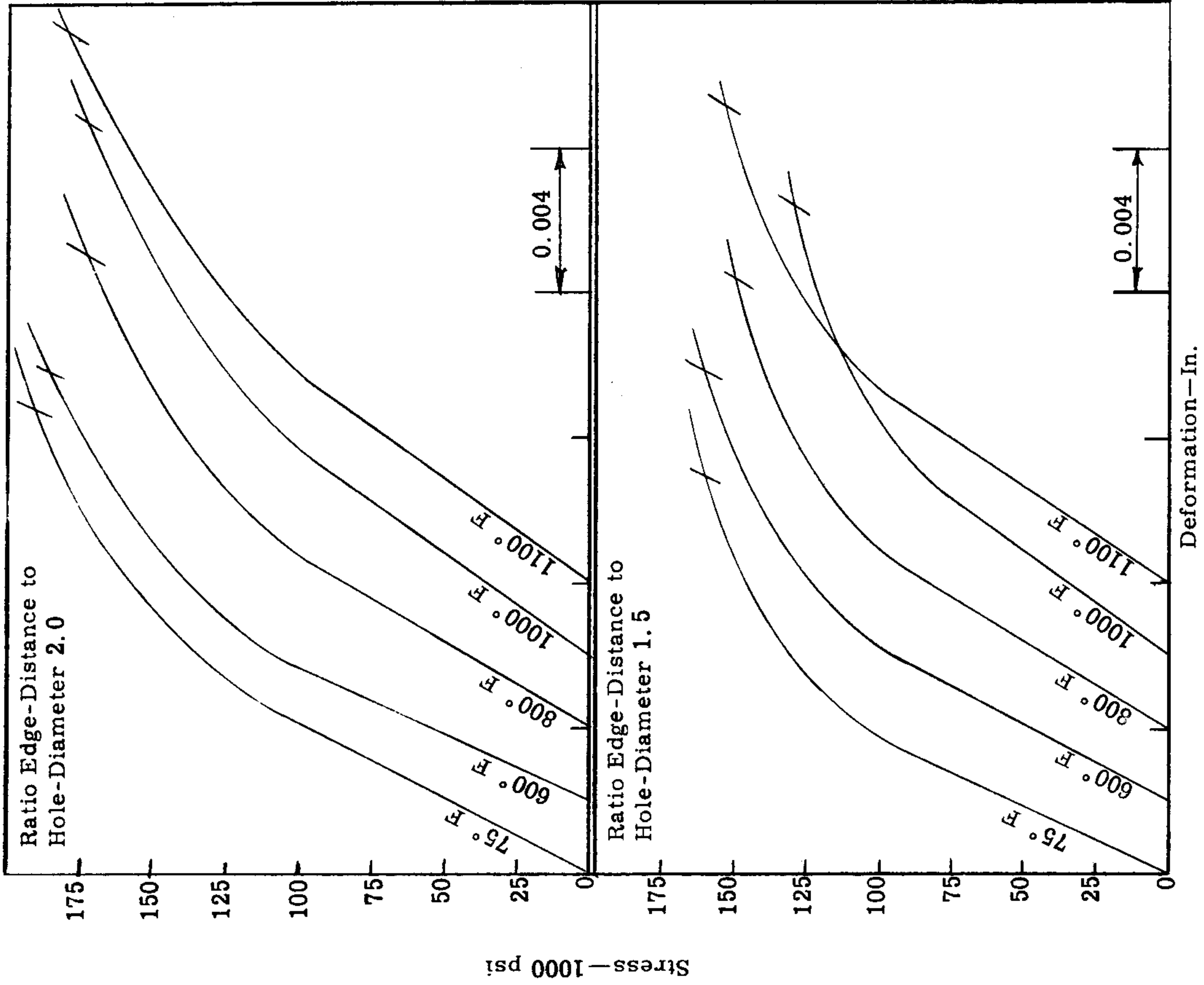

Fig. 32. Bearing stress-deformation curves for quenched and tempered A-286 austenitic alloy sheet at various temperatures and one-hundred-hour exposure time.

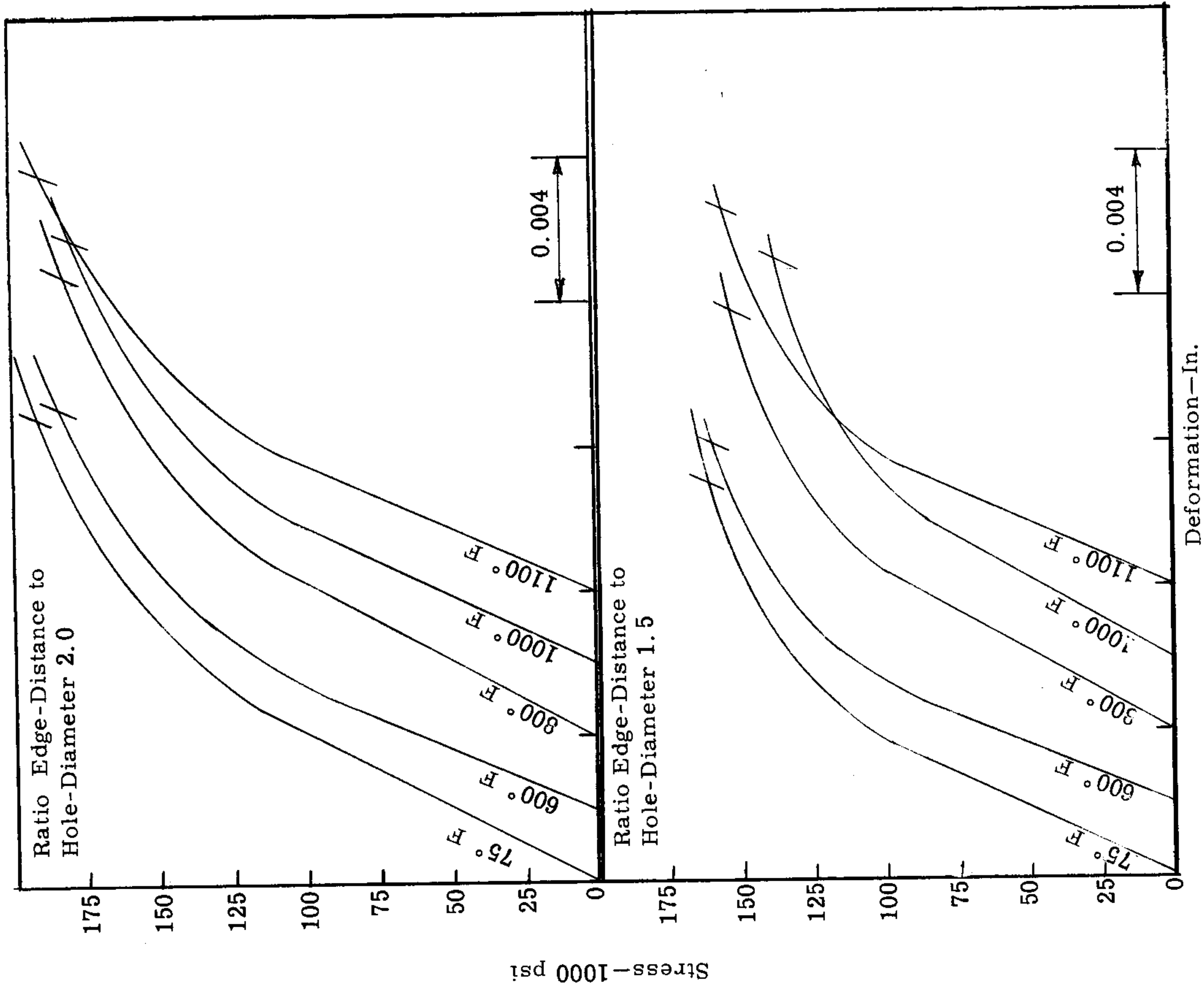

Fig. 33. Bearing stress-deformation curves for quenched and tempered A-286 austenitic alloy sheet at various temperatures and one-thousand-hour exposure time.

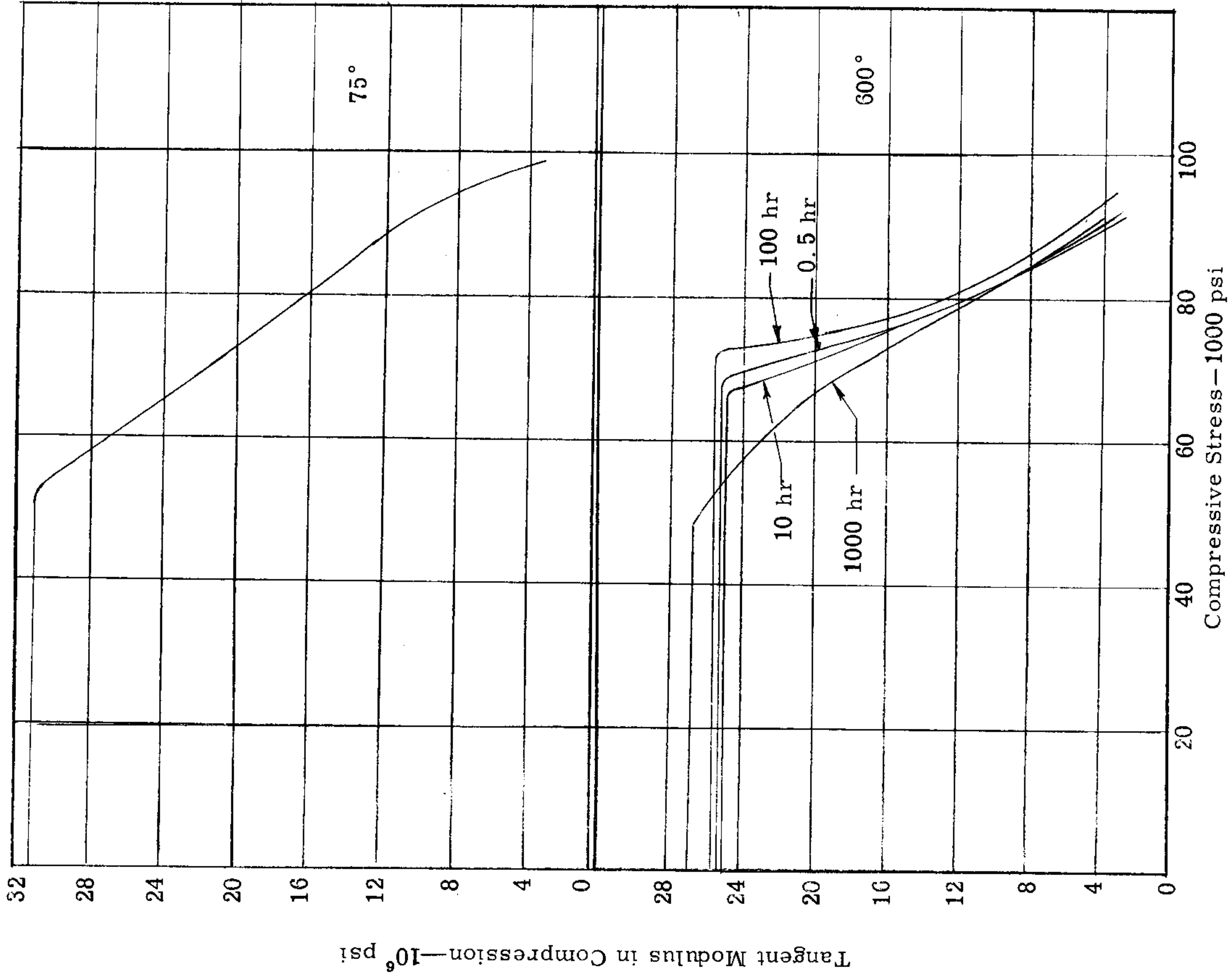

Fig. 34. Tangent-modulus vs. compressive-stress curves for quenched and tempered A-286 austenitic alloy sheet at 75° F and 600° F and different exposure times.

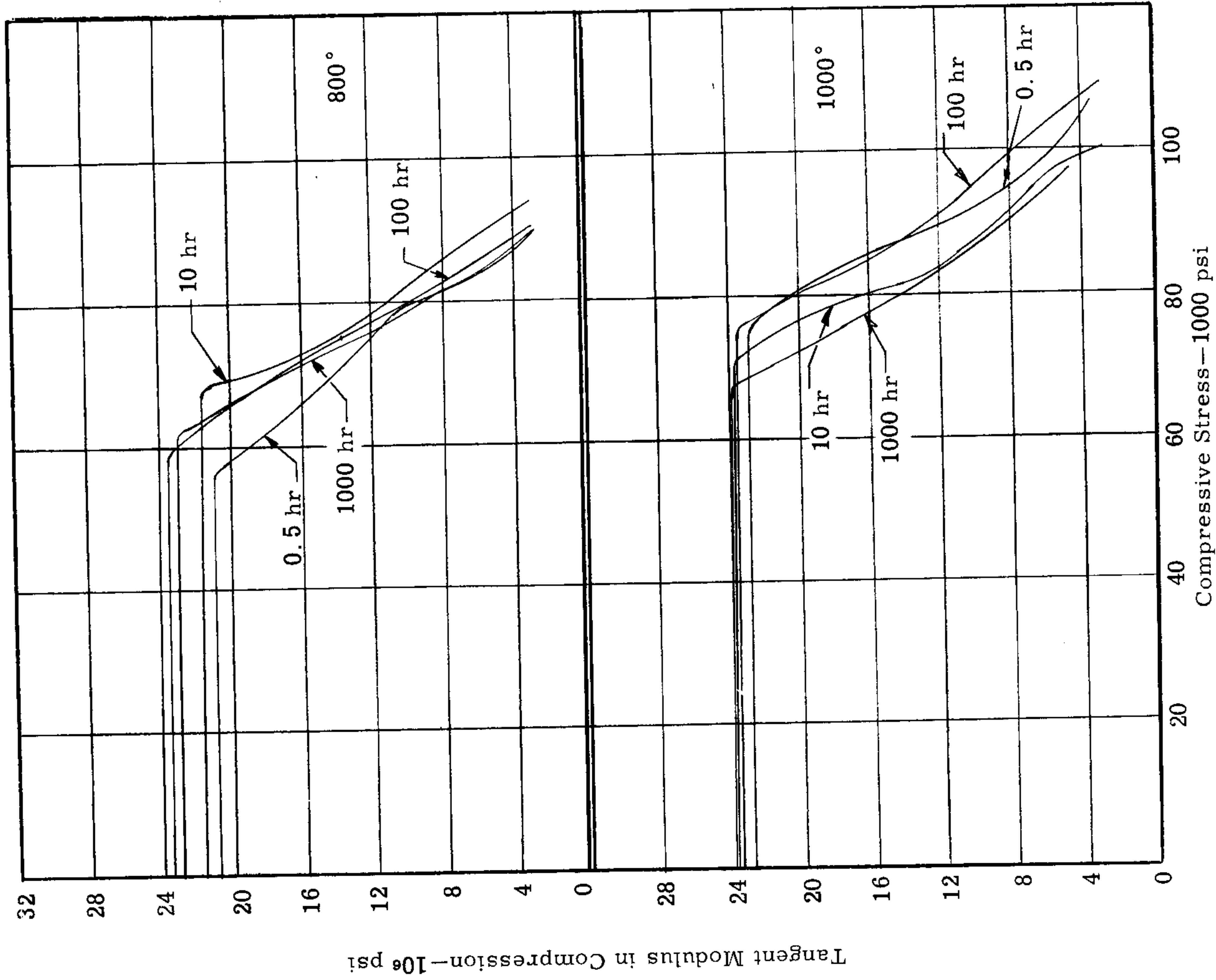

Fig. 35. Tangent-modulus vs. compressive stress-curves for quenched and tempered A-286 austenitic alloy sheet at 800° and 1000° and different exposure times.

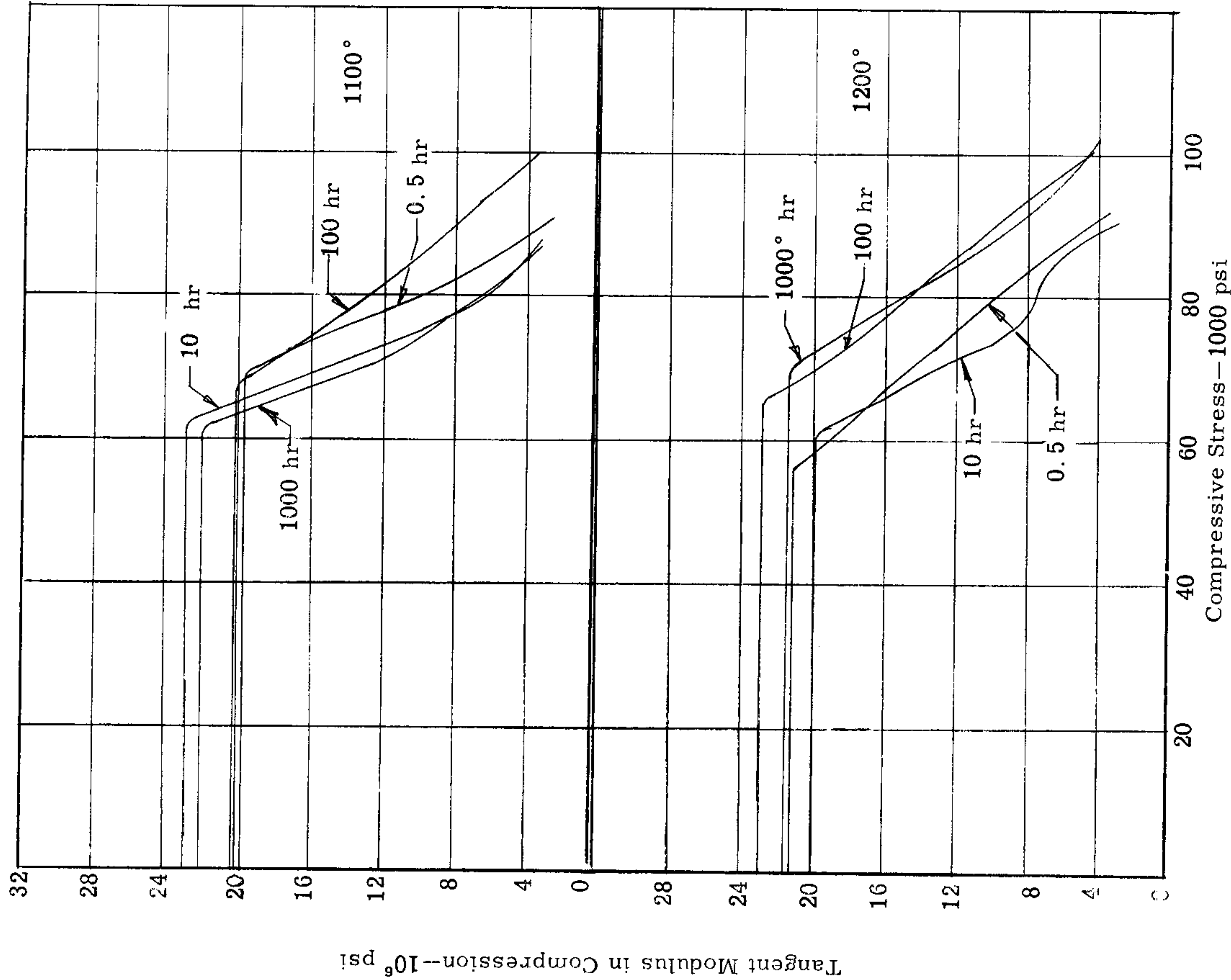

Fig. 36. Tangent-modulus vs. compressive-stress curves for quenched and tempered A-286 austenitic alloy sheet at 1100° F and 1200° F and different exposure times.

Tensile Properties of 0.062-In. A-286 Austenitic Alloy Sheet at Different Temperatures and Holding Times

Table 4

Temp °F	RT	Avg	600	0.5	600	Avg	10	600	100	600	Avg	1000	600	Avg
Temp	RT	Avg	600	0.5	600	Avg	10	600	100	600	Avg	1000	600	Avg
1000 psi	1000 psi	1000 psi	1000 psi	1000 psi	1000 psi	1000 psi	1000 psi	1000 psi	1000 psi	1000 psi	1000 psi	1000 psi	1000 psi	1000 psi
YS	YS	YS	YS	YS	YS	YS	YS	YS	YS	YS	YS	YS	YS	YS
UTS	UTS	UTS	UTS	UTS	UTS	UTS	UTS	UTS	UTS	UTS	UTS	UTS	UTS	UTS
ME	ME	ME	ME	ME	ME	ME	ME	ME	ME	ME	ME	ME	ME	ME
Elong. %	Elong. %	Elong. %	Elong. %	Elong. %	Elong. %	Elong. %	Elong. %	Elong. %	Elong. %	Elong. %	Elong. %	Elong. %	Elong. %	Elong. %
Hardi R45N	Hardi R45N	Hardi R45N	Hardi R45N	Hardi R45N	Hardi R45N	Hardi R45N	Hardi R45N	Hardi R45N	Hardi R45N	Hardi R45N	Hardi R45N	Hardi R45N	Hardi R45N	Hardi R45N
RS ²	RS ²	RS ²	RS ²	RS ²	RS ²	RS ²	RS ²	RS ²	RS ²	RS ²	RS ²	RS ²	RS ²	RS ²
RS ²	RS ²	RS ²	RS ²	RS ²	RS ²	RS ²	RS ²	RS ²	RS ²	RS ²	RS ²	RS ²	RS ²	RS ²
98.7	149.5	28.7	28.7	28.7	28.7	28.7	28.7	28.7	28.7	28.7	28.7	28.7	28.7	28.7
96.0	143.8	28.6	28.6	28.6	28.6	28.6	28.6	28.6	28.6	28.6	28.6	28.6	28.6	28.6
94.6	146.8	27	27	27	27	27	27	27	27	27	27	27	27	27
96.4	146.7	28.6	28.6	28.6	28.6	28.6	28.6	28.6	28.6	28.6	28.6	28.6	28.6	28.6
91.5	135.0	24.3	24.3	24.3	24.3	24.3	24.3	24.3	24.3	24.3	24.3	24.3	24.3	24.3
90.5	136.0	24.5	24.5	24.5	24.5	24.5	24.5	24.5	24.5	24.5	24.5	24.5	24.5	24.5
91.5	135.0	24.6	24.6	24.6	24.6	24.6	24.6	24.6	24.6	24.6	24.6	24.6	24.6	24.6
91.2	135.3	24.5	24.5	24.5	24.5	24.5	24.5	24.5	24.5	24.5	24.5	24.5	24.5	24.5
90.3	136.0	26.2	26.2	26.2	26.2	26.2	26.2	26.2	26.2	26.2	26.2	26.2	26.2	26.2
89.6	134.0	26.9	26.9	26.9	26.9	26.9	26.9	26.9	26.9	26.9	26.9	26.9	26.9	26.9
90.2	135.0	27.4	27.4	27.4	27.4	27.4	27.4	27.4	27.4	27.4	27.4	27.4	27.4	27.4
90.0	135.0	26.8	26.8	26.8	26.8	26.8	26.8	26.8	26.8	26.8	26.8	26.8	26.8	26.8
97.2	139.5	27.7	27.7	27.7	27.7	27.7	27.7	27.7	27.7	27.7	27.7	27.7	27.7	27.7
95.4	138.6	25.2	25.2	25.2	25.2	25.2	25.2	25.2	25.2	25.2	25.2	25.2	25.2	25.2
90.0	132.0	26.6	26.6	26.6	26.6	26.6	26.6	26.6	26.6	26.6	26.6	26.6	26.6	26.6
94.2	136.7	26.5	26.5	26.5	26.5	26.5	26.5	26.5	26.5	26.5	26.5	26.5	26.5	26.5
93.5	137.0	24.2	24.2	24.2	24.2	24.2	24.2	24.2	24.2	24.2	24.2	24.2	24.2	24.2
95.0	138.0	27.8	27.8	27.8	27.8	27.8	27.8	27.8	27.8	27.8	27.8	27.8	27.8	27.8
96.0	137.0	26.8	26.8	26.8	26.8	26.8	26.8	26.8	26.8	26.8	26.8	26.8	26.8	26.8
94.8	137.3	26.3	26.3	26.3	26.3	26.3	26.3	26.3	26.3	26.3	26.3	26.3	26.3	26.3
122.2	134.0	31	31	31	31	31	31	31	31	31	31	31	31	31
125.5	137.0	31	31	31	31	31	31	31	31	31	31	31	31	31
120.5	134.0	32	32	32	32	32	32	32	32	32	32	32	32	32
120.5	137.0	31	31	31	31	31	31	31	31	31	31	31	31	31
126.9	135.5	34	34	34	34	34	34	34	34	34	34	34	34	34
124.0	134.0	34	34	34	34	34	34	34	34	34	34	34	34	34
123.4	137.0	34	34	34	34	34	34	34	34	34	34	34	34	34
126.9	135.5	34	34	34	34	34	34	34	34	34	34	34	34	34
197.0	197.0	197.0	197.0	197.0	197.0	197.0	197.0	197.0	197.0	197.0	197.0	197.0	197.0	197.0
190.0	190.0	190.0	190.0	190.0	190.0	190.0	190.0	190.0	190.0	190.0	190.0	190.0	190.0	190.0
197.0	197.0	197.0	197.0	197.0	197.0	197.0	197.0	197.0	197.0	197.0	197.0	197.0	197.0	197.0
203.2	203.2	203.2	203.2	203.2	203.2	203.2	203.2	203.2	203.2	203.2	203.2	203.2	203.2	203.2
205.5	205.5	205.5	205.5	205.5	205.5	205.5	205.5	205.5	205.5	205.5	205.5	205.5	205.5	205.5
196.0	196.0	196.0	196.0	196.0	196.0	196.0	196.0	196.0	196.0	196.0	196.0	196.0	196.0	196.0
201.6	201.6	201.6	201.6	201.6	201.6	201.6	201.6	201.6	201.6	201.6	201.6	201.6	201.6	201.6
206.0	206.0	206.0	206.0	206.0	206.0	206.0	206.0	206.0	206.0	206.0	206.0	206.0	206.0	206.0
186.5	186.5	186.5	186.5	186.5	186.5	186.5	186.5	186.5	186.5	186.5	186.5	186.5	186.5	186.5
214.0	214.0	214.0	214.0	214.0	214.0	214.0	214.0	214.0	214.0	214.0	214.0	214.0	214.0	214.0
202.2	202.2	202.2	202.2	202.2	202.2	202.2	202.2	202.2	202.2	202.2	202.2	202.2	202.2	202.2

70

WADC TR 58-365

Tensile Properties of 0.062-In. A-286 Austenitic Alloy Sheet at Different Temperatures and Holding Times

Temp ° F	Holding Time, hr	YS 1000 psi	UTS 1000 psi	ME 10 ⁶ psi	Elong %	Hard ¹ R45N	RS ² 1000 psi	RS ³ 1000 psi
800	0.5	89.5	133.5	27.2	20	32	122.4	189.5
		89.5	133.5	27.9	19	34	122.4	210.0
800	10	89.5	133.5	-	20	34	122.4	187.5
		89.5	133.5	27.5	20	33	122.4	195.7
800	100	89.2	131.8	24.5	22	32	128.0	219.0
		91.2	134.2	23.5	21	31	120.2	205.0
800	1000	90.0	132.4	23.6	22	32	118.8	194.8
		90.1	132.4	23.9	22	32	122.3	206.3
800	1000	90.5	134.0	23.1	21	29	121.2	188.8
		88.8	130.5	21.5	21	32	121.8	188.5
800	1000	88.8	129.2	23.2	20	32	120.5	178.0
		89.4	131.2	22.6	21	31	121.2	185.1
800	1000	90.0	130.0	22.5	20	31	123.0	194.0
		90.0	132.0	24.7	19	32	117.6	186.0
800	1000	91.7	135.0	25.4	19	32	120.0	202.5
		90.6	132.3	24.2	19	32	122.2	194.2
1000	0.5	86.5	127.5	23.2	22	34	124.0	199.0
		87.5	127.5	25.2	22	34	119.2	169.0
1000	0.5	89.5	127.0	24.2	22	34	116.0	177.0
		87.8	127.3	24.2	22	34	119.7	181.7

Table 4 (continued)

Tensile Properties of 0.062-In. A-286 Austenitic Alloy⁴ Sheet at Different Temperatures and Holding Times

Table 4 (continued)

Temp ° F	Holding Time, hr	YS 1000 psi	UTS 1000 psi	ME 10 ⁶ psi	Elong %	Hard ¹ R45N	RS ² 1000 psi	RS ³ 1000 psi
Avg	10	89.0	130.0	23.0	18	31	110.0	167.0
		91.5	130.0	25.5	18	31	119.0	177.0
		89.0	129.3	25.0	17	32	116.0	183.0
		89.8	129.8	24.5	18	31	115.0	175.7
1000	100	90.7	129.8	26.3	16	32	116.5	177.2
		92.4	130.5	22.7	16	31	117.4	178.2
		92.2	131.6	27.8	16	31	117.2	170.0
Avg	1000	91.8	130.6	25.6	16	31	117.0	175.1
		98.0	138.0	24.5	18	33	130.0	193.0
		98.0	137.2	23.5	18	34	126.0	187.0
		98.5	136.8	23.8	18	34	128.0	189.0
Avg	1000	98.2	137.3	23.9	18	34	128.0	189.7
1100	0.5	87.5	116.0	22.4	28	29	99.6	177.5
		90.0	117.5	21.7	24	29	103.0	181.0
		93.5	119.0	23.4	26	29	106.0	160.0
Avg	1100	90.3	117.5	22.5	26	29	102.8	172.8
		88.0	117.0	20.2	22	26	102.5	169.5
		87.5	118.5	23.0	23	28	101.0	149.0
		92.0	120.0	20.1	22	28	108.0	175.0
Avg	1100	89.2	118.5	21.1	22	27	103.8	164.5

Tensile Properties of 0.62-In. A-286 Austenitic Alloy Sheet at Different Temperatures and Holding Times

Temp ° F	Holding Time, hr	YS 1000 psi	UTS 1000 psi	ME 10 ⁶ psi	Elong. %	Hard ¹ R45N	RS ² 1000 psi	RS ³ 1000 psi
1100	100	103.0	125.5	22.2	20	36	111.0	183.0
		96.0	126.0	19.9	20	34	113.0	167.5
		99.7	126.0	20.7	21	33	110.0	157.3
Avg		99.5	125.8	20.9	20	34	111.3	169.2
1100	1000	85.2	115.0	19.0	20	31	103.8	153.2
		85.3	116.5	19.0	20	33	103.2	166.0
		84.2	113.2	18.5	22	30	101.5	150.5
Avg		84.9	114.9	18.8	21	31	102.8	156.5
1200	0.5	89.0	102.0	23.1	31	28	86.5	132.9
		92.0	103.0	24.4	25	30	91.1	136.5
		94.5	103.5	23.0	27	30	86.5	132.9
Avg		91.8	102.8	23.5	27	29	88.0	134.1
1200	10	94.4	106.8	20.7	27	33	92.8	138.5
		97.5	107.0	21.5	24	32	92.6	136.5
		-	105.5	23.5	27	32	91.4	136.5
Avg		95.9	106.4	21.9	26	32	92.2	137.1
1200	100	91.2	104.6	22.7	26	34	84.4	137.3
		92.1	106.0	25.7	23	34	92.8	140.5
		90.3	106.5	22.7	25	35	96.8	134.5
Avg		91.2	105.7	23.7	25	34	91.3	137.4

Table 4 (continued)

1. Hardness determinations made at room temperature after tests.
 2. Rupture strength based on original cross section.
 3. Rupture strength based on final cross section.
 4. Heat treatment — 1800° F 1 hr argon atmosphere, O. Q., 1325° F 16 hr, A. C.

Temp ° F	1200	1000	Avg	YS	UTS	ME	Elong %	Hard ¹ R45N	RS ²	RS ³
	94.8	94.8	95.0	110.8	106.2	21.5	18	36	102.1	142.5
	96.2	94.2	94.2	106.2	104.5	22.4	22	35	97.0	133.5
	94.8	94.2	94.2	106.2	104.5	21.1	20	35	92.8	127.6
	94.8	94.2	95.0	110.8	107.1	21.6	20	35	97.3	134.5

Table 4 (continued)
 Tensile Properties of 0.062-In. A-286 Austenitic Alloy Sheet at Different Temperatures and Holding Times

WADC TR 58-365

Tensile Strength of 3/16-In. A-286 Austenitic Alloy³ Plate at Different Temperatures and Holding Times

Table 5

Holding Time, hr	Temp ° F	1/2		10		100		1000	
		UTS ¹ 1000 psi	Hard ² RC	UTS 1000 psi	Hard ² RC	UTS 1000 psi	Hard ² RC	UTS 1000 psi	Hard ² RC
RT	Avg								
		147.0	30	150.1	31	145.7	30	146.7	30
600	Avg								
		135.3	30	136.5	33	138.0	33	144.0	32
600	136.5	30	135.2	32	138.4	32	141.0	32	
	135.9	31	134.7	31	138.2	32	143.5	32	
600	138.2	30	133.5	31	-	-	144.2	32	
	136.5	30	135.0	32	138.2	32	143.2	32	
800	131.6	31	133.5	34	132.5	34	131.5	33	
	131.2	29	134.0	34	136.5	34	134.0	33	
800	132.9	30	134.0	33	133.0	34	132.0	33	
	132.8	31	133.0	33	132.5	34	132.0	33	
Avg									
		132.1	30	133.6	33	133.6	34	132.4	33

Tensile Strength of 3/16-In. A-286 Austenitic Alloy Plate at Different Temperatures and Holding Times

Table 5 (continued)

Holding Time, hr	Temp ° F	1/2		10		100		1000	
		UTS ¹ 1000 psi	Hard ² RC	UTS 1000 psi	Hard RC	UTS 1000 psi	Hard RC	UTS 1000 psi	Hard RC
1000	124.8	30	129.2	31	128.3	34	136.0	35	136.0
	124.0	31	128.2	31	128.5	34	136.0	35	136.0
	125.0	29	129.3	31	129.0	34	136.0	35	136.0
	130.0	30	127.0	31	-	-	-	-	-
	125.8	30	128.4	31	128.6	34	136.0	35	136.0
Avg									
1100	119.2	28	121.0	27	125.4	32	117.3	28	117.3
	119.8	29	118.0	28	128.0	32	115.8	29	115.8
	120.2	28	122.0	28	128.0	32	116.0	29	116.0
	119.7	28	120.3	28	127.1	32	116.5	29	116.5
	102.0	29	107.2	30	108.7	33	106.5	35	106.5
1200	102.0	28	107.5	31	109.0	35	108.6	35	108.6
	102.5	29	109.0	30	108.5	33	109.2	33	109.2
	102.2	29	107.9	30	108.7	34	108.1	34	108.1

1. Ultimate tensile strength.
 2. Hardness determinations made at room temperature after tests.
 3. Heat treatment - 1800° F 1 hr Argon atmosphere, O. Q., 1325° F 16 hr, A. C.

WADC TR58-365

76

Table 6
Compressive Properties of 0.062-In. A-286 Austenitic Alloy¹ Sheet at Different Temperatures and Holding Times

Hold. Time hr	Temp °F	1/2		10		100		1000																				
		CYS ¹	ME	CYS	ME	CYS	ME	CYS	ME																			
RT	99.0	98.5	28.6	31.2	31	99.0	28.6	31.2	31																			
										102.5	28.4	30	100.0	29.4	31													
Avg	91.8	25.0	30	91.8	24.8	31	94.5	25.5	31							90.5	26.5	33	22.6	32	92.0	22.6	32	26.5	32	92.0	26.5	32
										89.2	22.4	30	90.8	20.0	31													
88.9	21.1	30	90.3	21.5	30	92.5	22.1	31	90.3							23.8	30	22.8	29	89.3	20.8	31	93.6	21.5	29	94.0	18.8	31
										102.0	25.7	31	96.0	23.5	31													
106.5	22.9	31	100.0	23.7	30	109.0	23.5	30	96.8							23.5	30	23.5	34	106.5	22.9	31	94.6	23.7	31	109.0	23.5	30
										Avg	103.2	24.2	94.6	23.6	31													

WADC TR 58-365

77

Table 6 (continued)
Compressive Properties of 0.062-In. A-286 Austenitic Alloys Plate at
Different Temperatures and Holding Times

Hold. Time hr	Temp °F	1/2		10		100		1000		
		CYS ¹ 1000 psi	ME 10 ⁶ psi	Hard ² R45N	CYS 1000 psi	ME 10 ⁶ psi	Hard R45N	CYS 1000 psi	ME 10 ⁶ psi	Hard R45N
1/2	1100	90.5	19.7	31	90.2	22.8	30	90.2	22.8	32
	Avg	89.8	19.7	32	93.0	22.9	30	86.5	21.9	32
1200	1100	92.0	21.1	34	90.2	23.1	31	87.3	22.1	32
	Avg	92.1	22.2	34	90.6	23.5	31	85.3	21.7	32
16 hr	1100	90.5	19.7	31	90.2	22.8	30	90.2	22.8	32
	Avg	87.5	19.7	32	91.0	22.9	30	86.5	21.9	32
16 hr	1100	90.5	21.6	34	90.6	23.5	31	90.2	22.8	32
	Avg	87.5	22.2	34	91.0	23.5	31	86.5	21.7	32
16 hr	1100	90.5	19.7	31	90.2	22.8	30	90.2	22.8	32
	Avg	87.5	19.7	32	91.0	22.9	30	86.5	21.9	32
16 hr	1100	90.5	21.1	34	90.2	23.1	31	90.2	22.1	32
	Avg	87.5	22.2	34	90.6	23.5	31	86.5	21.7	32
16 hr	1100	90.5	19.7	31	90.2	22.8	30	90.2	22.8	32
	Avg	87.5	19.7	32	91.0	22.9	30	86.5	21.9	32
16 hr	1100	90.5	21.6	34	90.6	23.5	31	90.2	22.1	32
	Avg	87.5	22.2	34	91.0	23.5	31	86.5	21.7	32
16 hr	1100	90.5	19.7	31	90.2	22.8	30	90.2	22.8	32
	Avg	87.5	19.7	32	91.0	22.9	30	86.5	21.9	32
16 hr	1100	90.5	21.1	34	90.2	23.1	31	90.2	22.1	32
	Avg	87.5	22.2	34	90.6	23.5	31	86.5	21.7	32
16 hr	1100	90.5	19.7	31	90.2	22.8	30	90.2	22.8	32
	Avg	87.5	19.7	32	91.0	22.9	30	86.5	21.9	32
16 hr	1100	90.5	21.6	34	90.6	23.5	31	90.2	22.1	32
	Avg	87.5	22.2	34	91.0	23.5	31	86.5	21.7	32
16 hr	1100	90.5	19.7	31	90.2	22.8	30	90.2	22.8	32
	Avg	87.5	19.7	32	91.0	22.9	30	86.5	21.9	32
16 hr	1100	90.5	21.1	34	90.2	23.1	31	90.2	22.1	32
	Avg	87.5	22.2	34	90.6	23.5	31	86.5	21.7	32

1. Compressive yield strength.
2. Hardness determinations made at room temperature after tests.
3. Heat treatment - 1800° F 1 hr argon atmosphere, O. Q., 1325° F 16 hr, A. C.

WADC TR 58-365
78

Table 7 (continued)
Shear Strength of 3/16-In. A-286 Austenitic Alloy Plate at
Different Temperatures and Holding Times

Holding Time, hr	Temp °F	1/2		10		100		1000	
		Hard RC	USS 1000 psi	Hard RC	USS 1000 psi	Hard RC	USS 1000 psi	Hard RC	USS 1000 psi
1100	69.4	24	72.2	30	78.0	30	74.3	30	74.3
	76.0	-	70.2	32	78.6	31	74.5	31	74.5
1200	74.3	20	70.2	31	78.0	30	73.7	30	73.7
	77.7	-	70.8	-	78.2	30	74.1	-	74.1
Avg	74.3	22	72.2	32	78.0	31	74.1	30	74.1
	74.3	22	70.8	31	78.2	30	73.8	30	73.8
1200	72.2	22	68.7	30	71.6	31	69.7	31	69.7
	73.5	28	69.0	31	74.0	33	73.8	31	73.8
Avg	74.6	31	68.0	30	74.0	31	75.0	31	75.0
	73.4	27	68.5	30	71.6	32	72.8	31	72.8

1. Ultimate shear strength.
 2. Hardness determinations made at room temperature after tests.
 3. Heat treatment - 1800° F 1 hr argon atmosphere; O.Q., 1325° F 16 hr, A.C.

WADC TR 58-365

08

Bearing Properties⁴ of 0.062-In. A-286 Austenite Alloy⁵ Sheet at Different Temperatures and Holding Times

Hold. Time hr	Temp °F	1/2		10		100		1000									
		BYS ¹	UBS ²	Hard ³	R45N	BYS	UBS	Hard	R45N	BYS	UBS	Hard	R45N				
RT	162.2	217.0	214.0	30	163.5	214.0	30	163.5	217.0	214.0	30	168.0	237.0	31	167.5	237.0	33
		162.2	214.0	30	163.5	214.0	30	163.5	217.0	214.0	30	168.0	237.0	31	167.5	237.0	33
Avg	159.0	213.0	212.7	32	155.5	212.7	32	155.5	213.0	212.7	32	156.2	213.0	34	164.5	215.0	-
		213.0	212.7	32	155.5	212.7	32	155.5	213.0	212.7	32	156.2	213.0	34	164.5	215.0	-
600	146.0	209.0	213.0	32	177.2	238.0	33	161.5	216.0	216.0	33	161.7	216.0	33	161.7	216.0	33
		209.0	213.0	32	177.2	238.0	33	161.5	216.0	216.0	33	161.7	216.0	33	161.7	216.0	33
Avg	150.8	211.0	211.0	32	172.5	235.0	32	161.7	213.0	213.0	33	161.7	213.0	33	161.7	213.0	33
		211.0	211.0	32	172.5	235.0	32	161.7	213.0	213.0	33	161.7	213.0	33	161.7	213.0	33
800	151.5	206.0	201.5	32	144.0	206.0	34	-	203.0	203.0	32	152.0	203.0	32	151.0	203.0	33
		206.0	201.5	32	144.0	206.0	34	-	203.0	203.0	32	152.0	203.0	32	151.0	203.0	33
Avg	148.5	201.5	201.5	32	144.8	203.0	33	151.0	207.5	207.5	33	151.0	207.5	33	151.0	207.5	33
		201.5	201.5	32	144.8	203.0	33	151.0	207.5	207.5	33	151.0	207.5	33	151.0	207.5	33
1000	136.5	193.0	193.0	35	140.0	194.5	33	117.5	189.0	189.0	34	128.5	189.0	34	128.5	189.0	34
		193.0	193.0	35	140.0	194.5	33	117.5	189.0	189.0	34	128.5	189.0	34	128.5	189.0	34
Avg	149.2	203.0	203.0	32	144.6	205.7	33	152.0	206.0	206.0	32	147.5	206.0	32	147.5	206.0	32
		203.0	203.0	32	144.6	205.7	33	152.0	206.0	206.0	32	147.5	206.0	32	147.5	206.0	32

Table 8

1. Bearing yield strength.
2. Ultimate bearing strength.
3. Hardness determinations made at room temperature after tests.
4. Edge-distance to hole-diameter ratio 1.5
5. Heat treatment - 1800° F 1 hr argon atmosphere, O. Q., 1325° F 16 hr, A. C.

Hold. Time Hr	Temp °F	1/2		10		100	
		BYS ¹ 1000 psi	UBS ² Hard ³	BYS 1000 psi	UBS Hard	BYS 1000 psi	UBS Hard
1100	152.0	148.5	31	155.6	31	177.0	32
		182.0	31	150.0	31	175.0	32
1200	157.7	150.2	31	152.5	31	176.4	32
		183.5	31	151.8	31	175.0	32
AVG	-	154.6	-	154.7	34	178.8	34
		151.5	-	154.7	34	178.8	34
AVG	-	154.6	31	154.7	34	178.8	34
		151.5	30	154.7	34	178.8	34

Table 8 (continued)
Bearing Properties* of 0.062-In. A-286 Austenitic Alloy⁵ Sheet at Different Temperatures and Holding Times

WADC TR 58-365

32

Bearing Properties⁴ of 0.062-In. A-286 Austenitic Alloy⁵ Sheet at Different Temperatures and Holding Times

Table 9

Hold. Time hr	Temp ° F	1/2		10		100		1000	
		BYS ¹ UBS ²	Hard ³ R45N	BYS UBS	Hard R45N	BYS UBS	Hard R45N	BYS UBS	Hard R45N
RT		180.0	274.0	180.0	272.0	191.0	276.5	181.0	305.0
	33	179.5	266.4	175.0	269.0	185.0	278.5	185.0	304.0
600		176.5	265.0	181.0	269.0	188.5	275.0	178.5	305.0
	33	175.0	263.5	187.5	274.0	187.5	274.0	174.0	307.0
Avg		177.7	267.2	178.7	270.0	188.0	276.0	179.2	305.3
	33	185.0	266.0	187.5	267.0	176.8	263.0	205.0	305.3
800		180.0	263.0	163.7	261.5	175.8	269.0	-	304.0
	34	185.0	266.0	187.5	267.0	176.8	263.0	205.0	304.0
Avg		182.5	265.0	172.6	265.0	175.4	265.0	184.5	305.0
	33	171.0	251.0	168.0	242.0	173.0	249.0	187.0	264.0
1000		164.0	249.0	175.5	252.0	-	249.0	175.0	264.0
	36	160.0	249.0	158.5	249.0	169.0	249.0	181.0	261.0
Avg		165.0	249.7	167.3	244.3	171.0	249.0	181.0	263.0
	35	165.0	249.7	167.3	244.3	171.0	249.0	181.0	263.0

Bearing Properties of 0.062-In. A-286 Austenitic Alloy Sheet at Different Temperatures and Holding Times

Table 9 (continued)

Hold. Time	Temp ° F	1/2		10		100		1000		
		BYS ¹	UBS ²	Hard ³	BYS	UBS	Hard	BYS	UBS	Hard
1100		190.5	249.2	32	181.5	245.5	32	179.5	254.5	33
		190.5	252.0	32	186.2	248.0	32	191.0	256.0	33
190.5		190.5	250.5	32	186.2	243.0	32	206.0	249.0	34
		190.5	250.5	32	184.6	245.5	32	192.1	253.1	33
Avg		190.5	250.5	32	184.6	245.5	32	192.1	253.1	33

1. Bearing yield strength.
2. Ultimate bearing strength.
3. Hardness determinations made at room temperature after tests.
4. Edge-distance to hole-diameter ratio 2.0
5. Heat treatment -1800° F 1 hr argon atmosphere, O. Q., 1325° F 16 hr, A. C.

10.2 17-7 PH Stainless Steel Sheet, RH 950 Condition

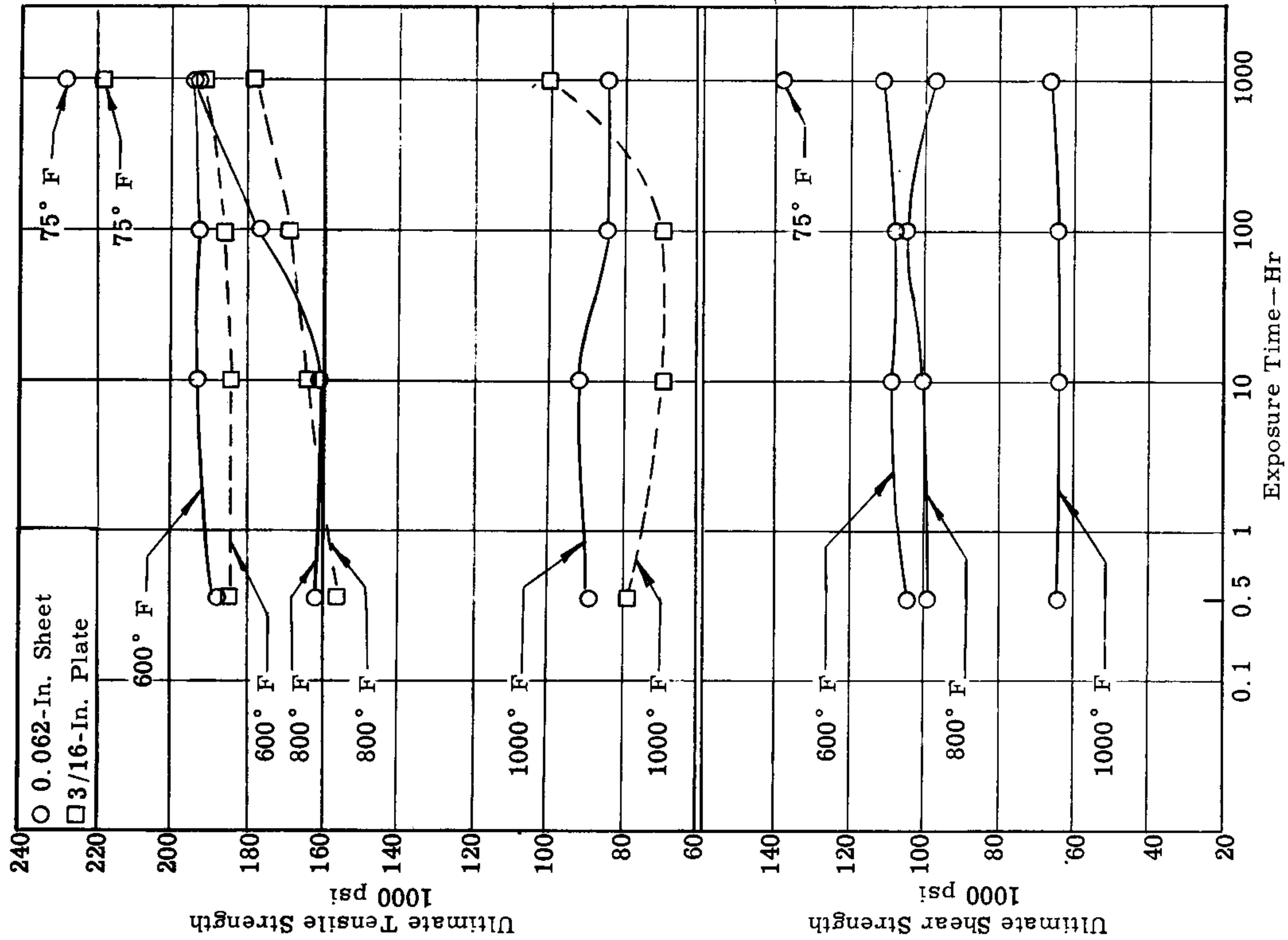

Fig. 37. Effect of exposure time on the ultimate tensile strength and ultimate shear strength of 17-7 PH stainless steel (RH 950 condition) at different temperatures.

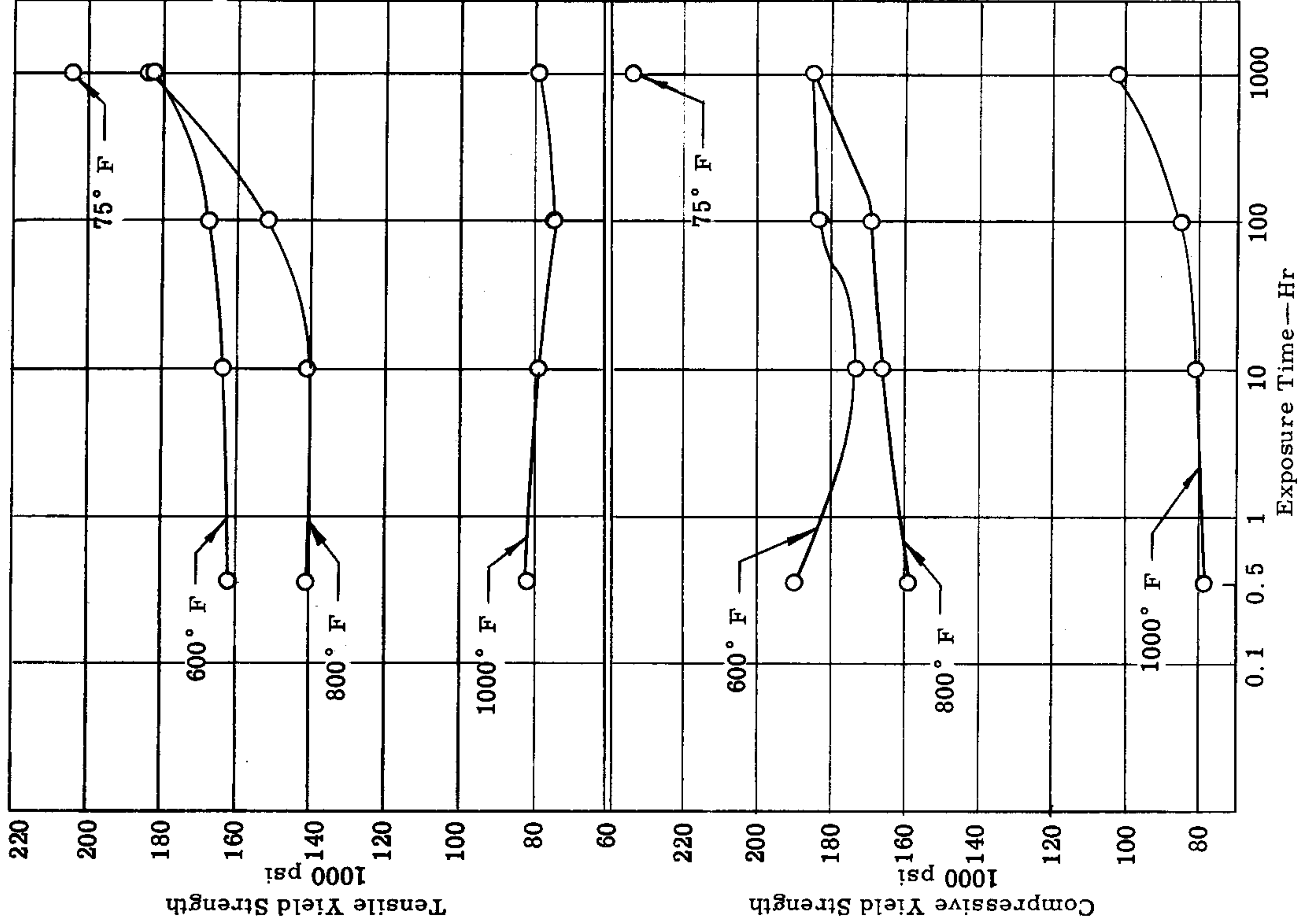

Fig. 38. Effect of exposure time on the tensile and compressive yield strength of 17-7 PH stainless steel sheet (RH 950 condition) at different temperatures.

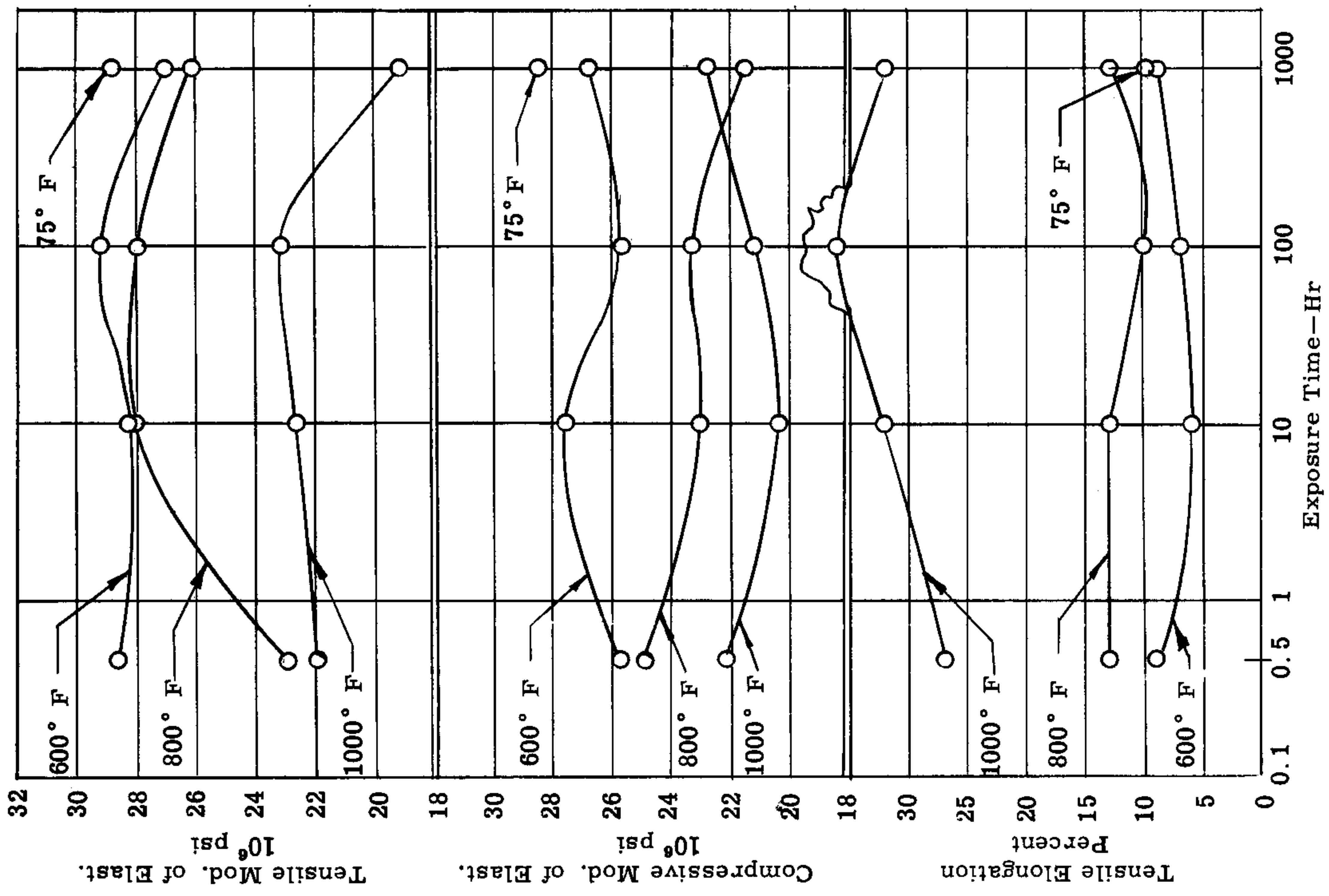

Fig. 39. Effect of exposure time on the tensile and compressive moduli of elasticity and percent elongation of 17-7 PH stainless steel sheet (RH 950 condition) at different temperatures.

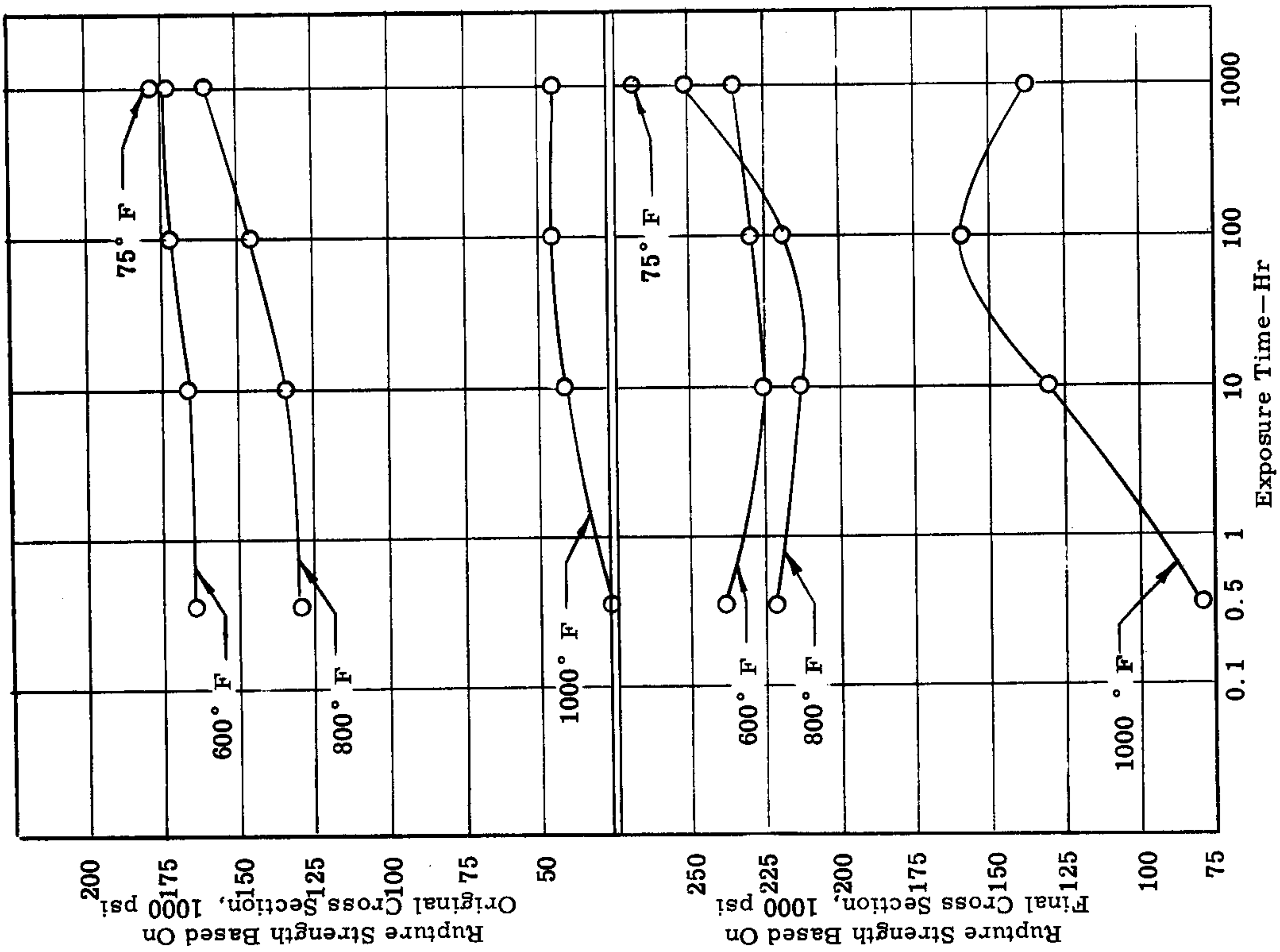

Fig. 40. Effect of exposure time on the tensile rupture strength of 17-7 PH stainless steel sheet (RH 950 condition) at different temperatures.

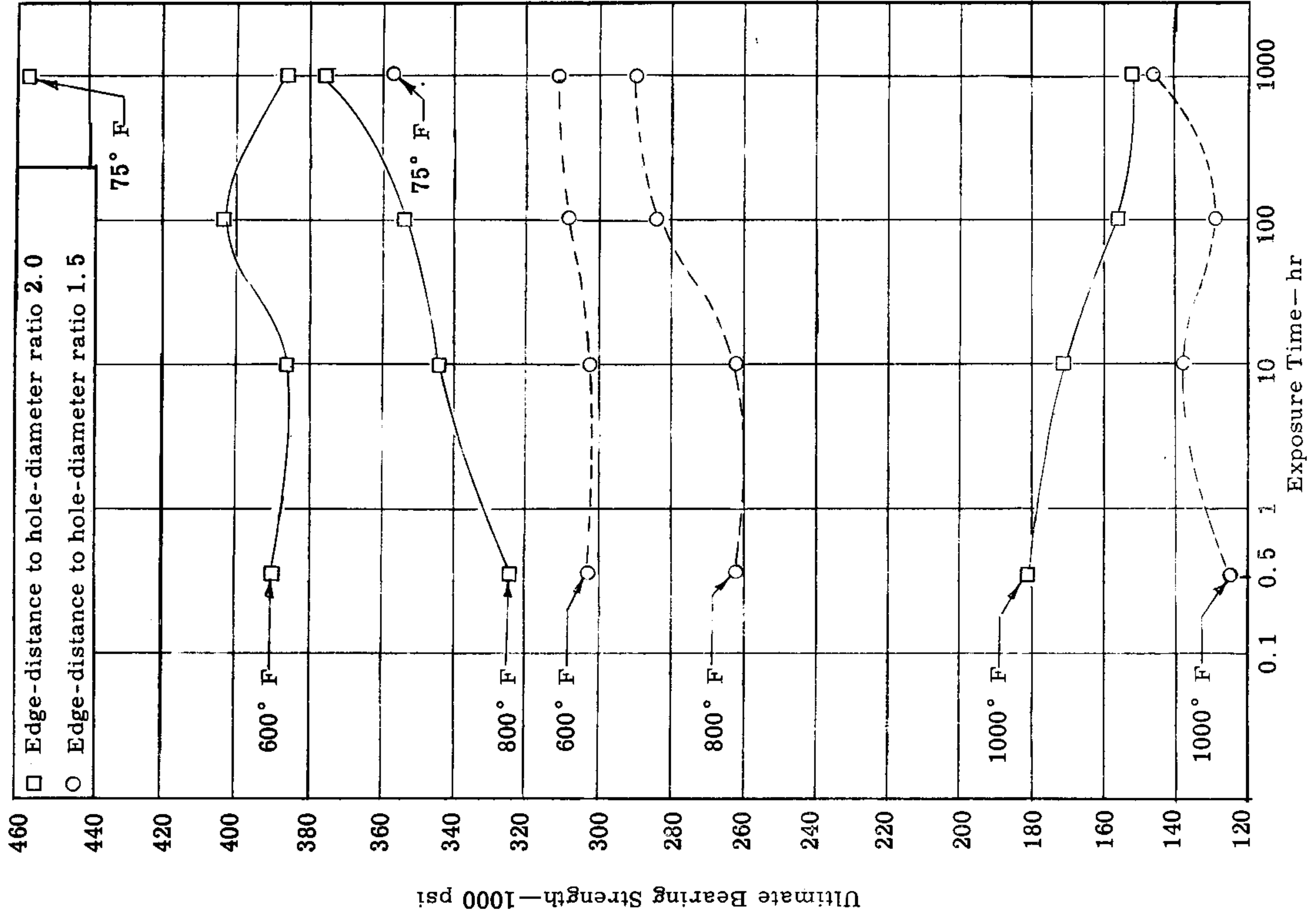

Fig. 41 Effect of exposure time on the ultimate bearing strength of 17-7 PH stainless steel sheet (RH 950 condition) at different temperatures.

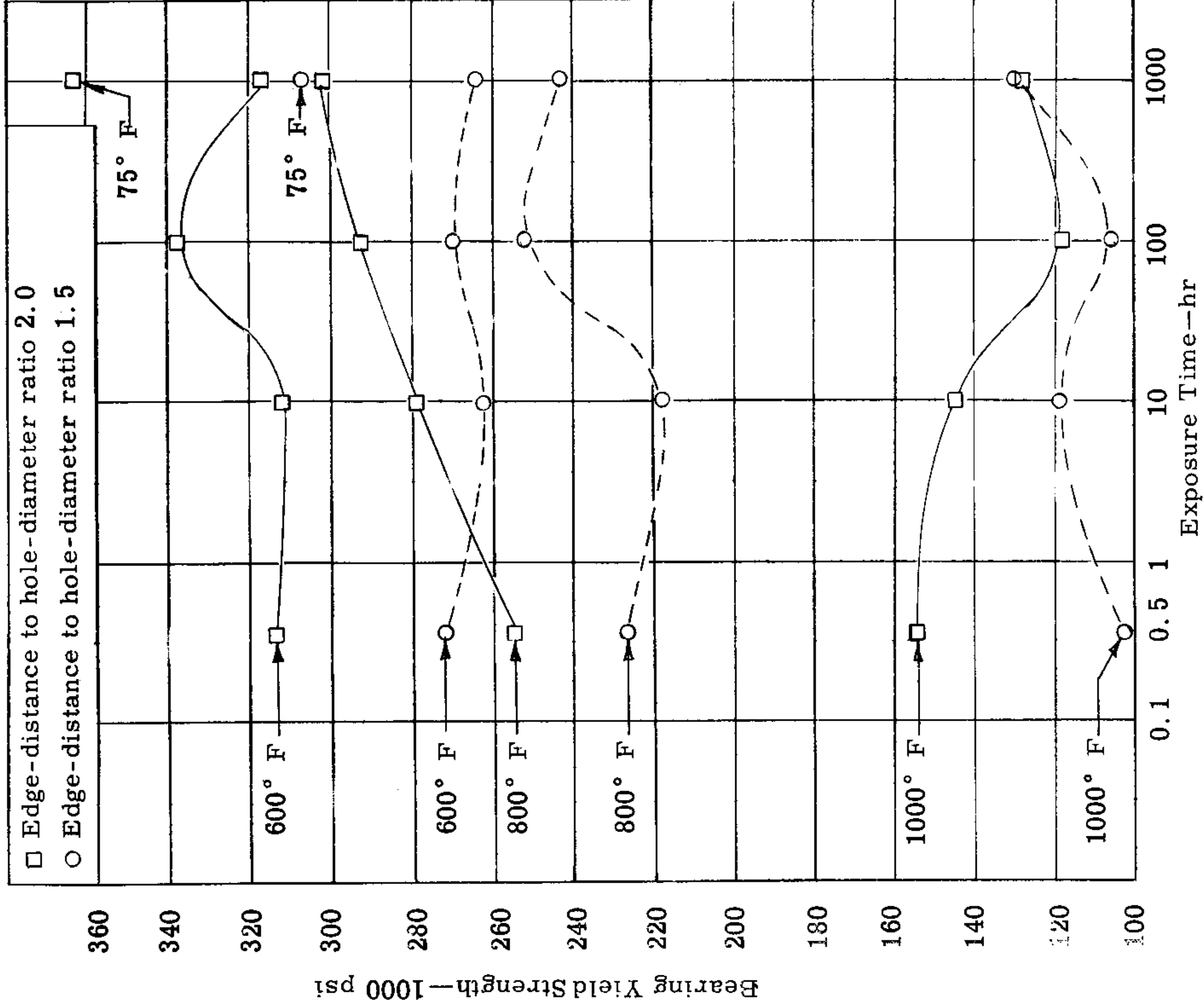

Fig. 42. Effect of exposure time on the bearing yield strength of 17-7 PH stainless steel sheet (RH 950 condition) at different temperatures.

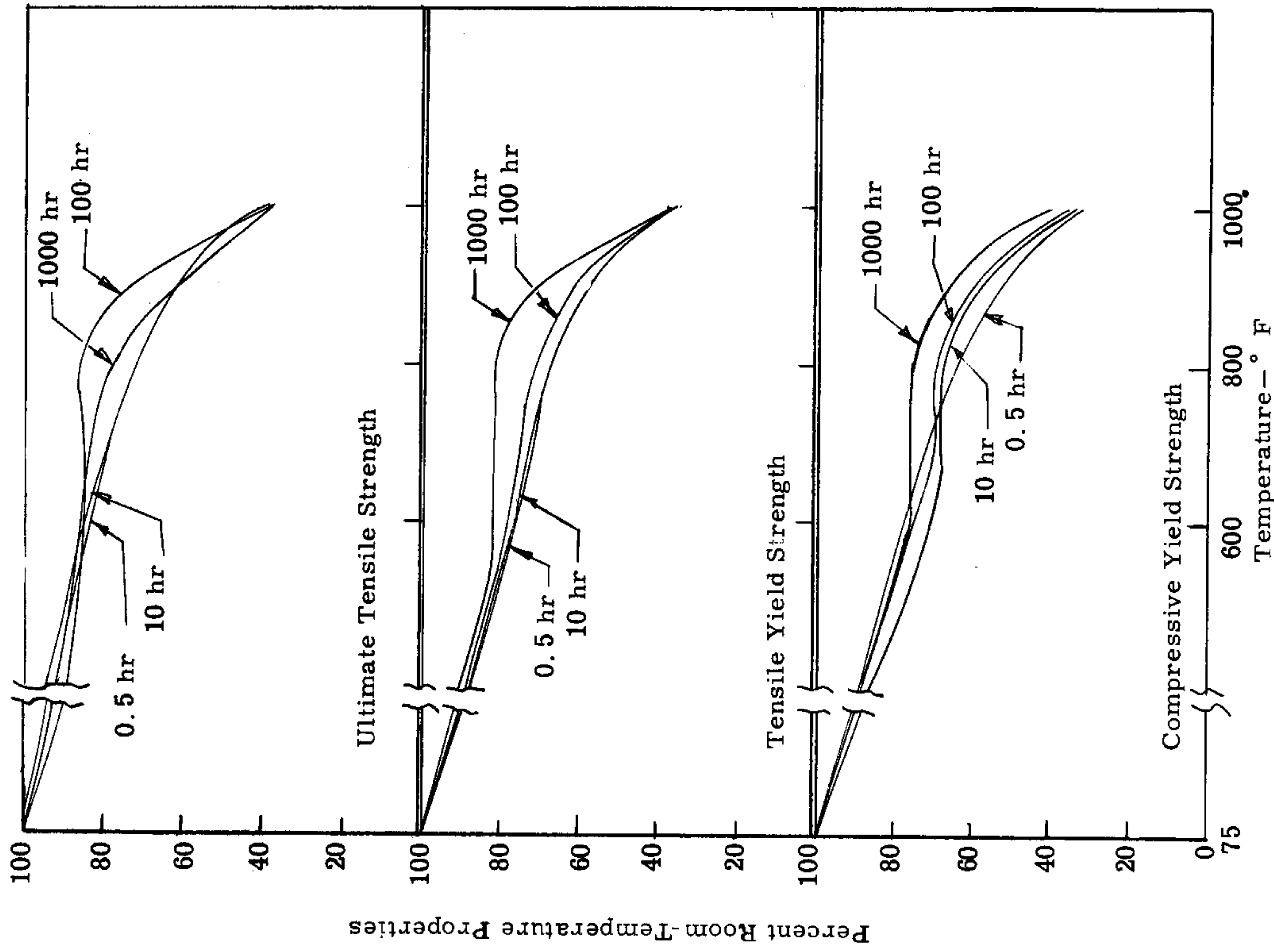

Fig. 43. Elevated-temperature strength properties as percent of room-temperature properties for 17-7 PH stainless steel sheet (RH 950 condition) at different exposure times

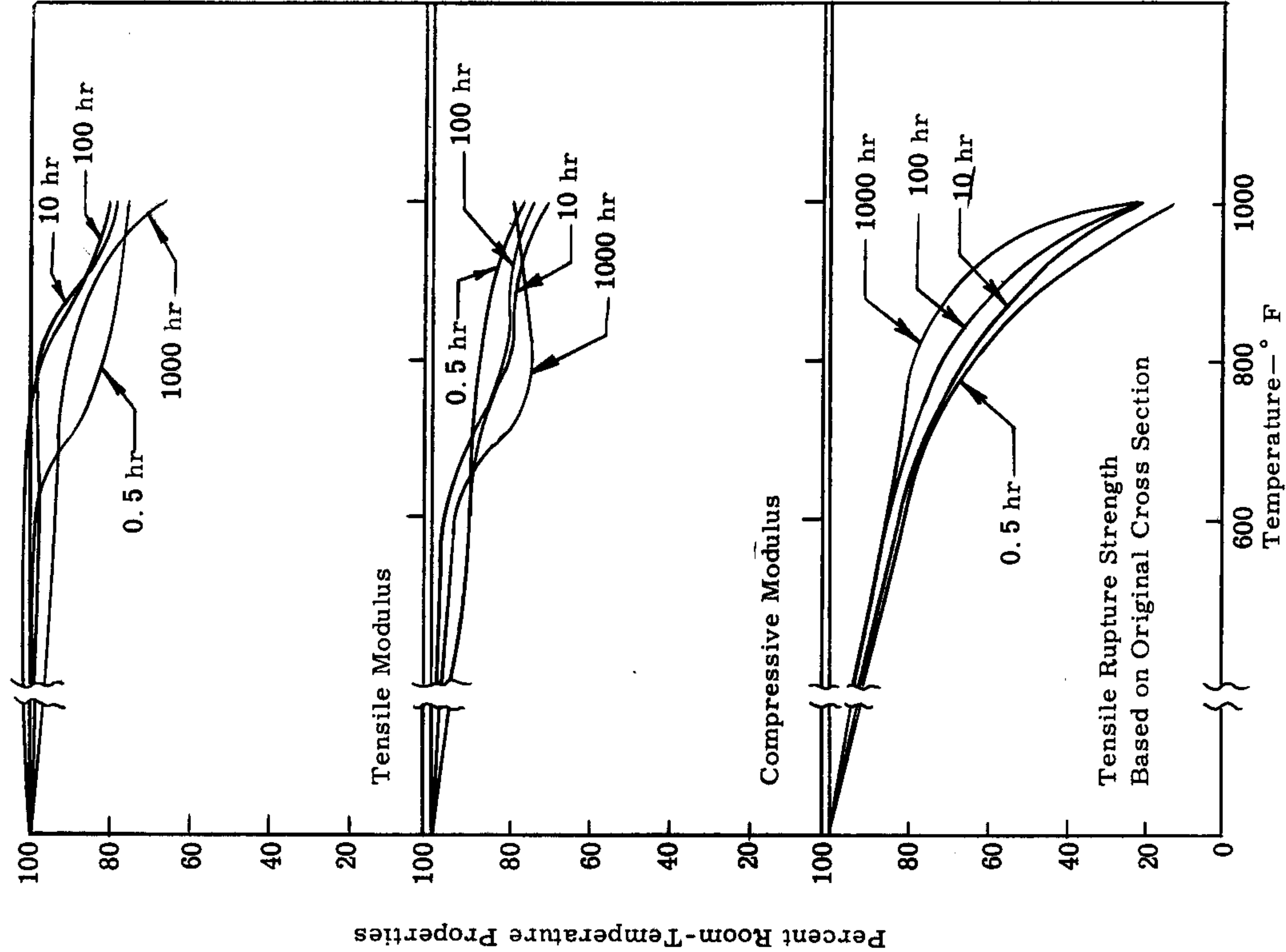

Fig. 44. Elevated temperature properties as percent of room-temperature properties for 17-7 PH stainless steel sheet (RH 950 condition) at different exposure times.

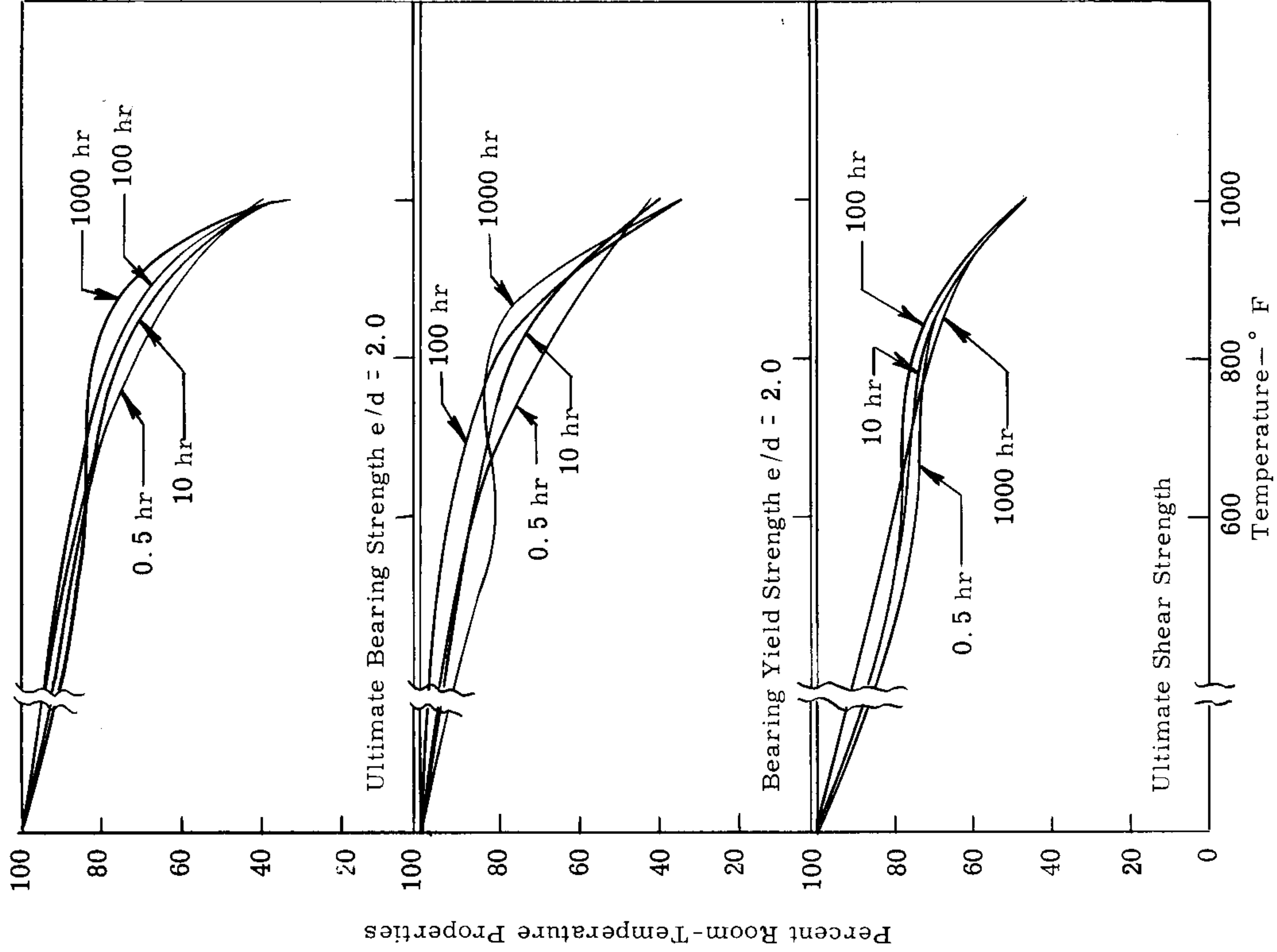

Fig. 45. Elevated-temperature strength properties as percent of room-temperature properties for 17-7 PH stainless steel sheet (RH 950 condition) at different exposure times.

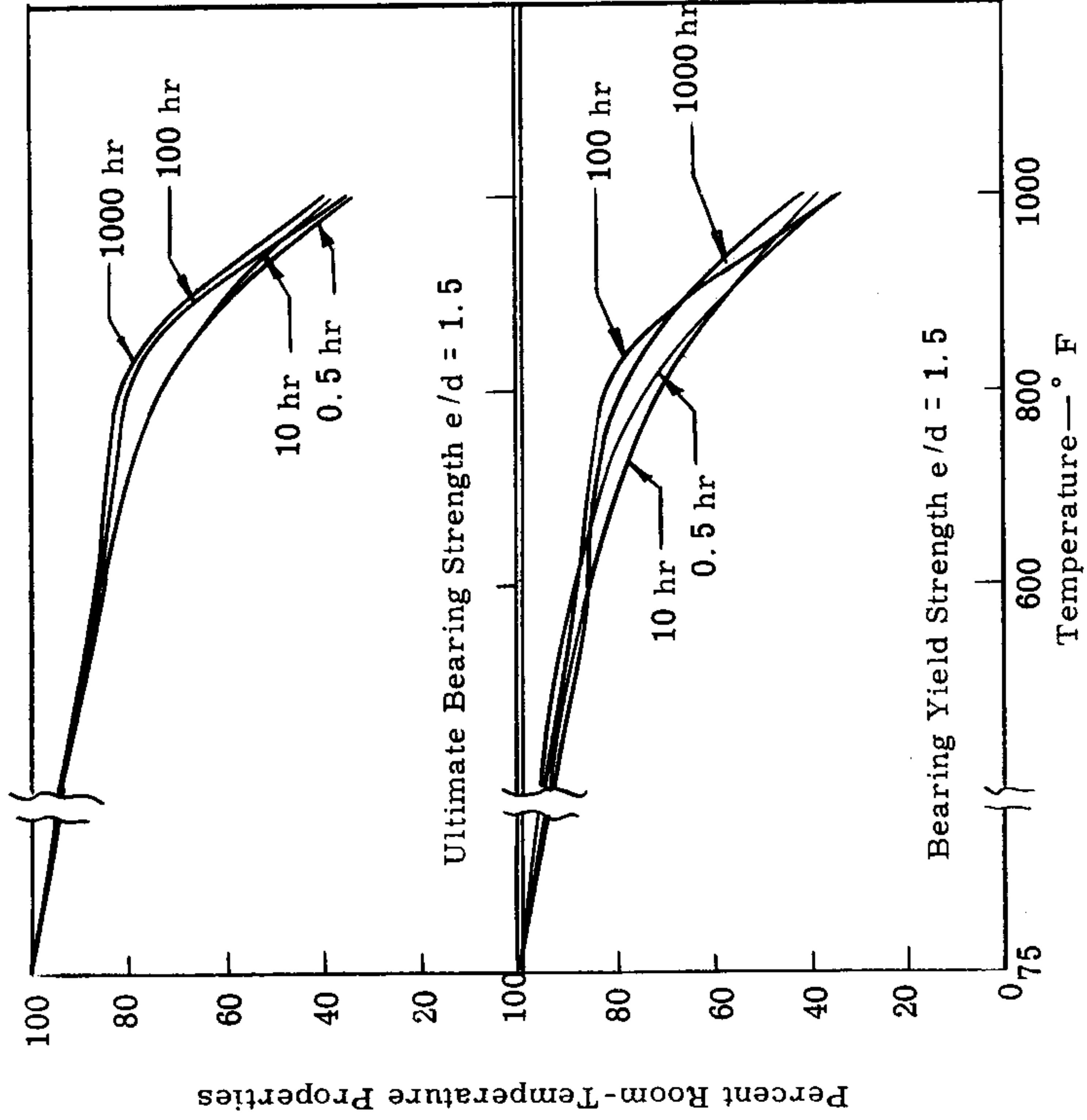

Fig. 46. Elevated-temperature strength properties as percent of room-temperature properties for 17-7 PH stainless steel sheet (RH 350 condition) at different exposure times.

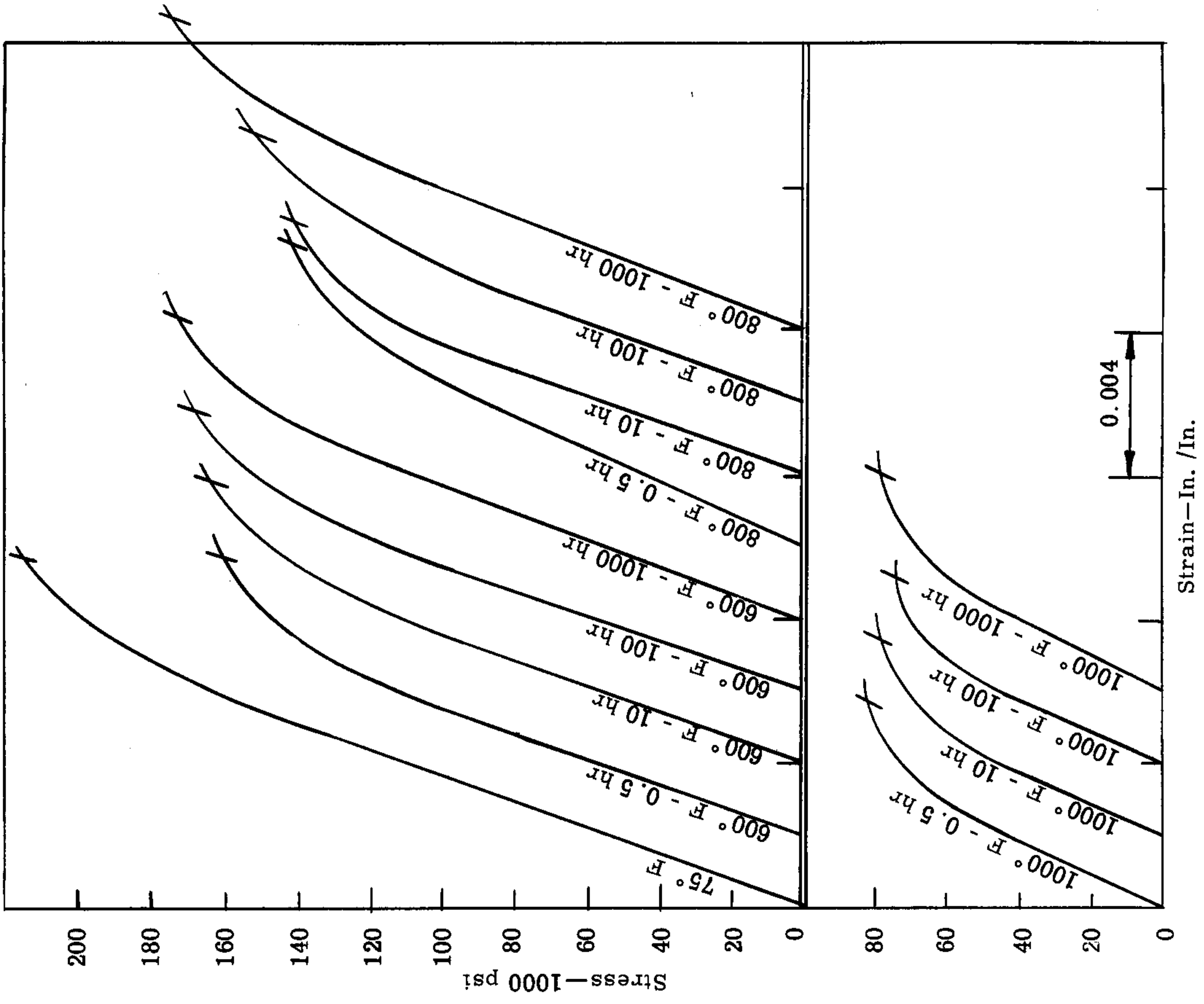

Fig. 47. Tensile stress-strain curves for 17-7 PH stainless steel sheet (RH 950 condition) at various temperatures and exposure times.

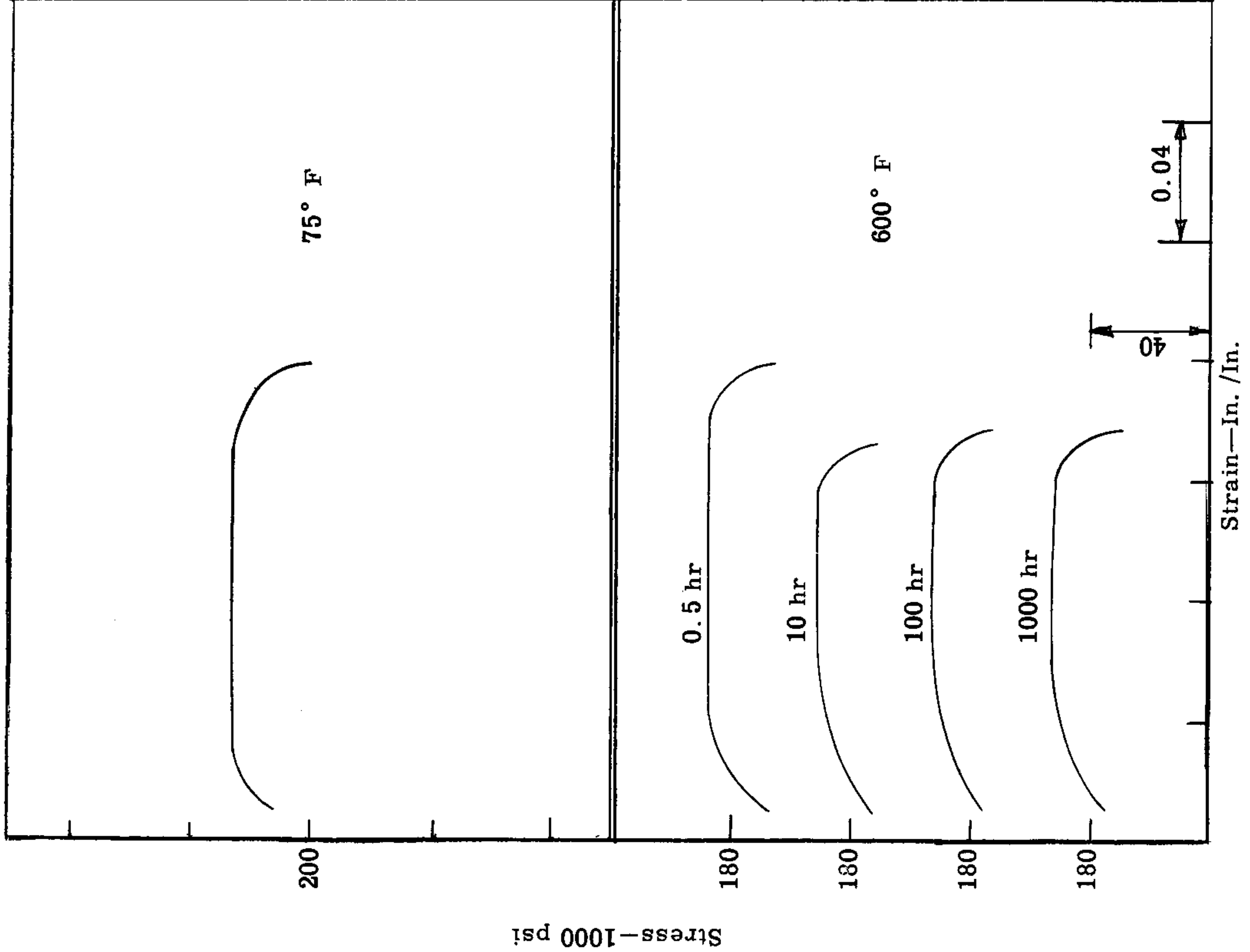

Fig. 48. Tensile postyield stress-strain curves for 17-7 PH stainless steel sheet (RH 950 condition) at various temperatures and exposure times.

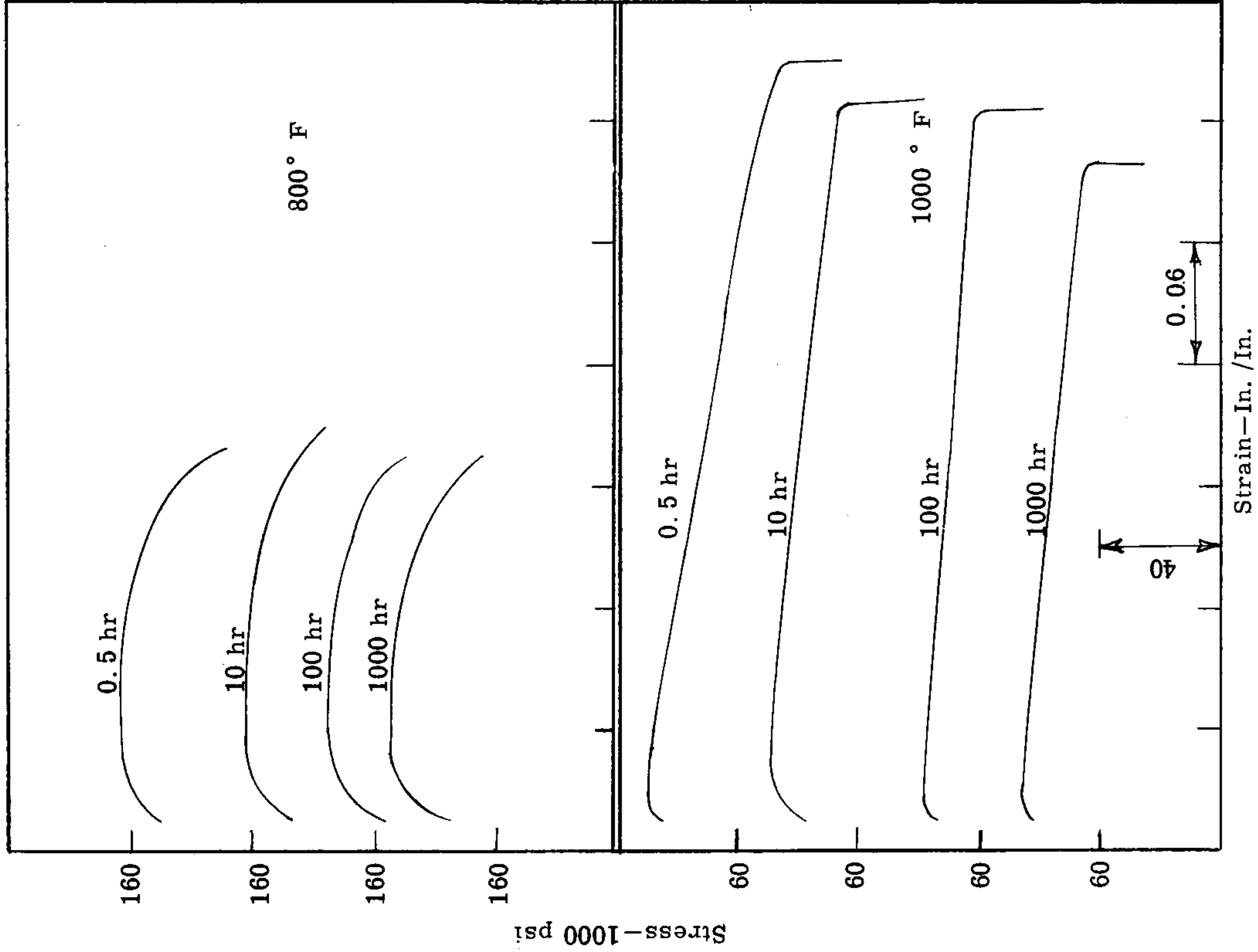

Fig. 49. Tensile postyield stress-strain curves for 17-7 PH stainless steel sheet (RH 950 condition) at various temperatures and exposure times.

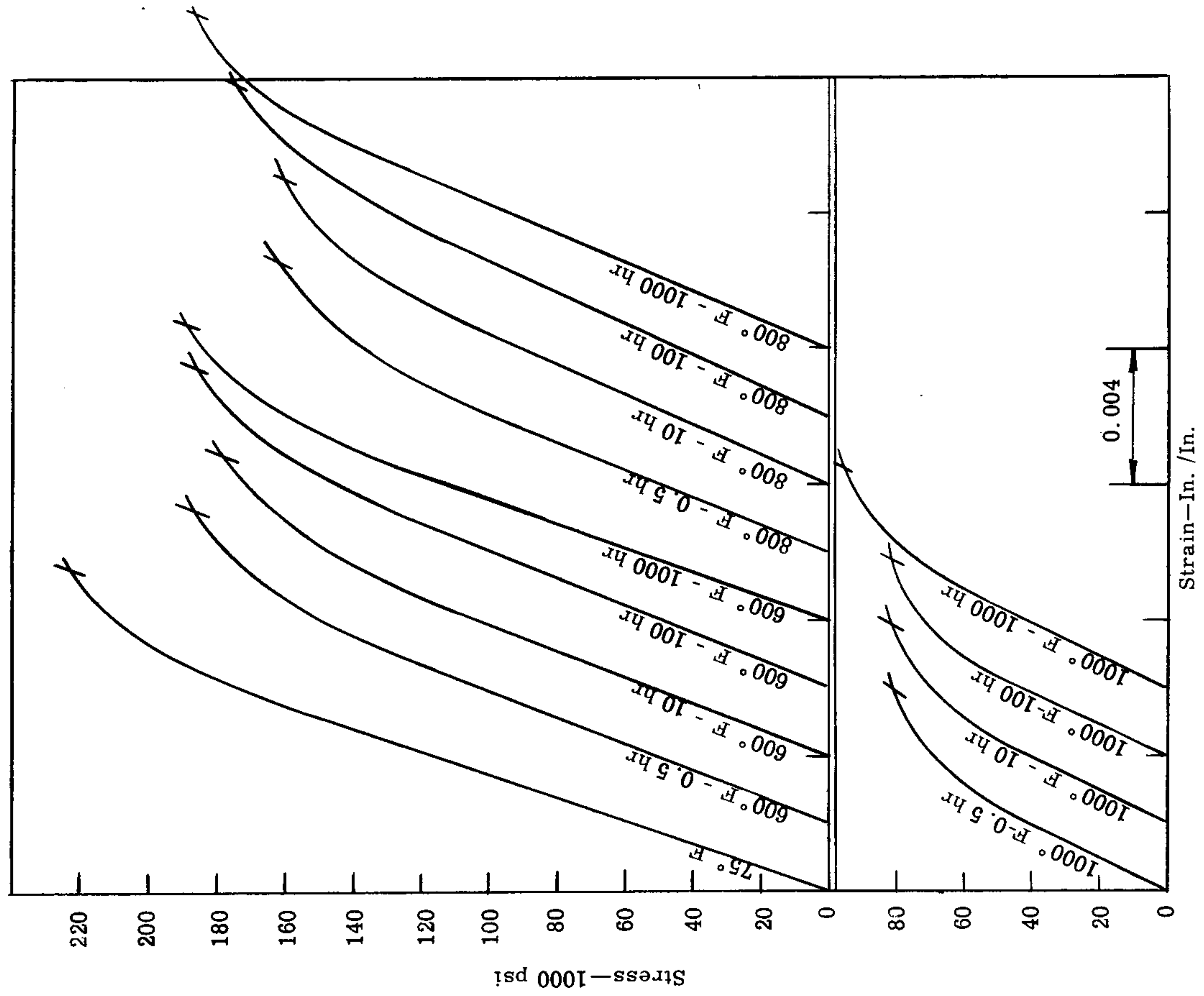

Fig. 50. Compressive stress-strain curves for 17-7 PH stainless steel sheet (RH 950 condition) at various temperatures and exposure times.

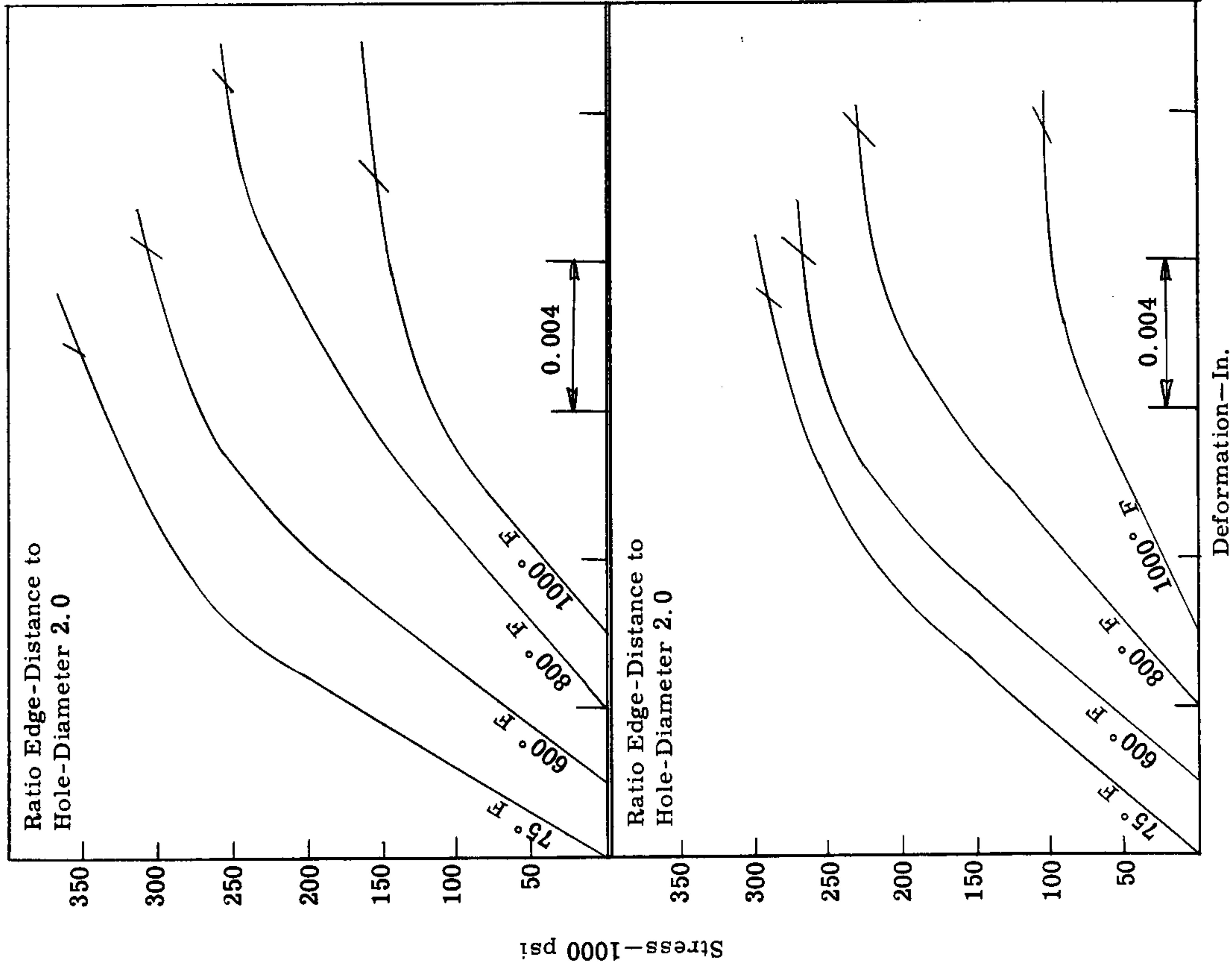

Fig. 51. Bearing stress-deformation curves for 17-7 PH stainless steel sheet (RH 950 condition) at various temperatures and one-half-hour exposure time.

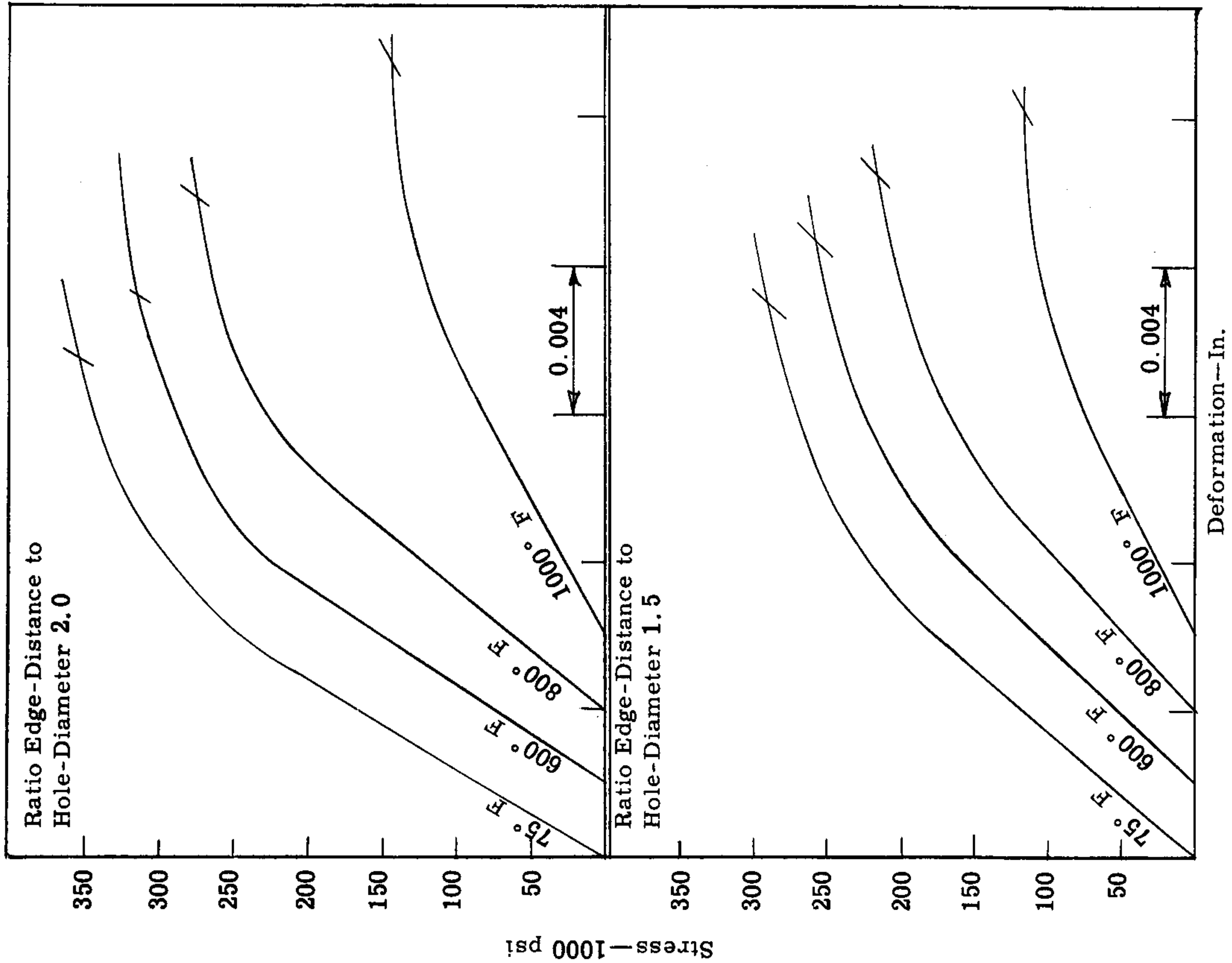

Fig. 52. Bearing stress-deformation curves for 17-7 PH stainless steel sheet (RH 950 condition) at various temperatures and ten-hour exposure time.

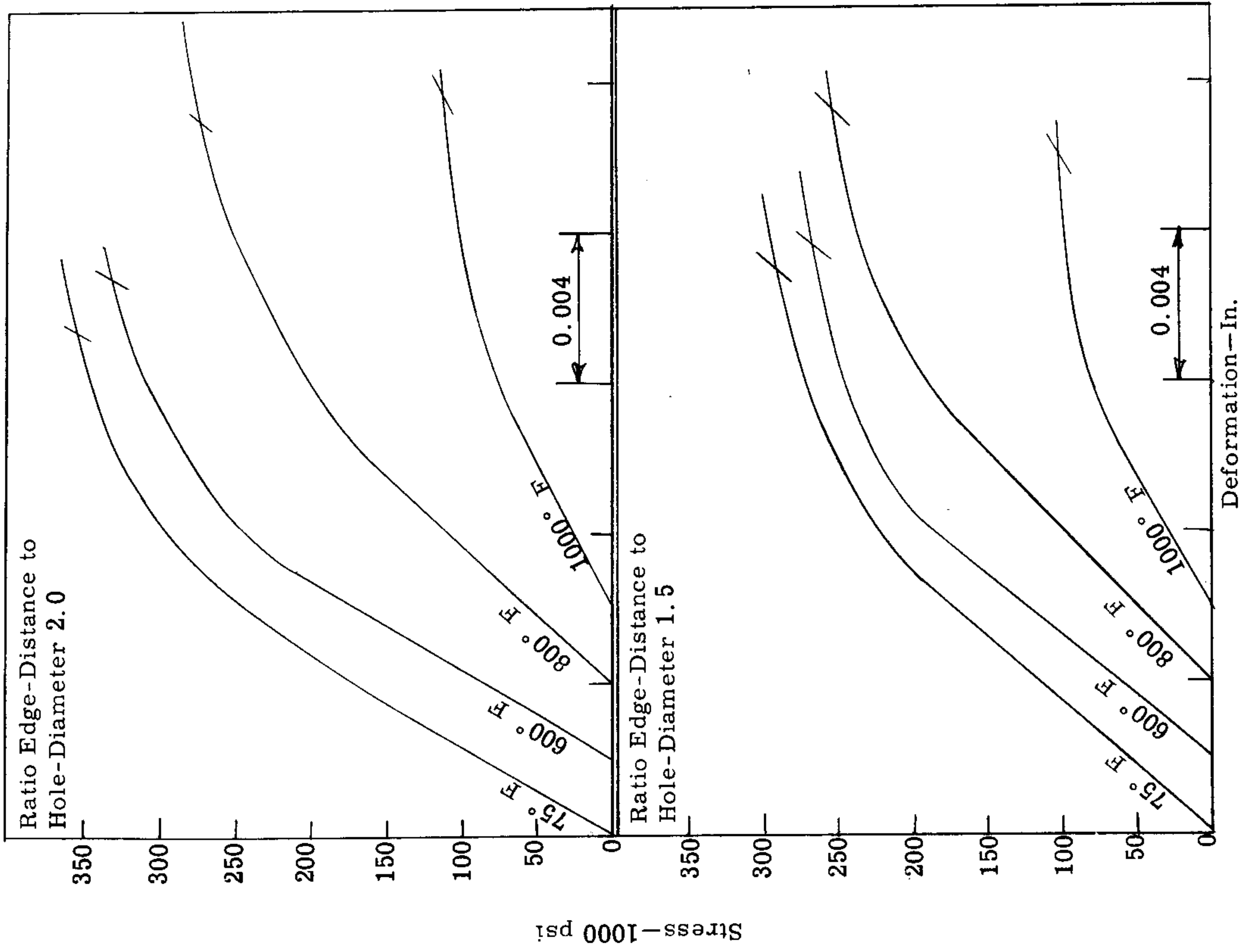

Fig. 53. Bearing stress-deformation curves for 17-7 PH stainless steel sheet (RH 950 condition) at various temperatures and one-hundred-hour exposure time.

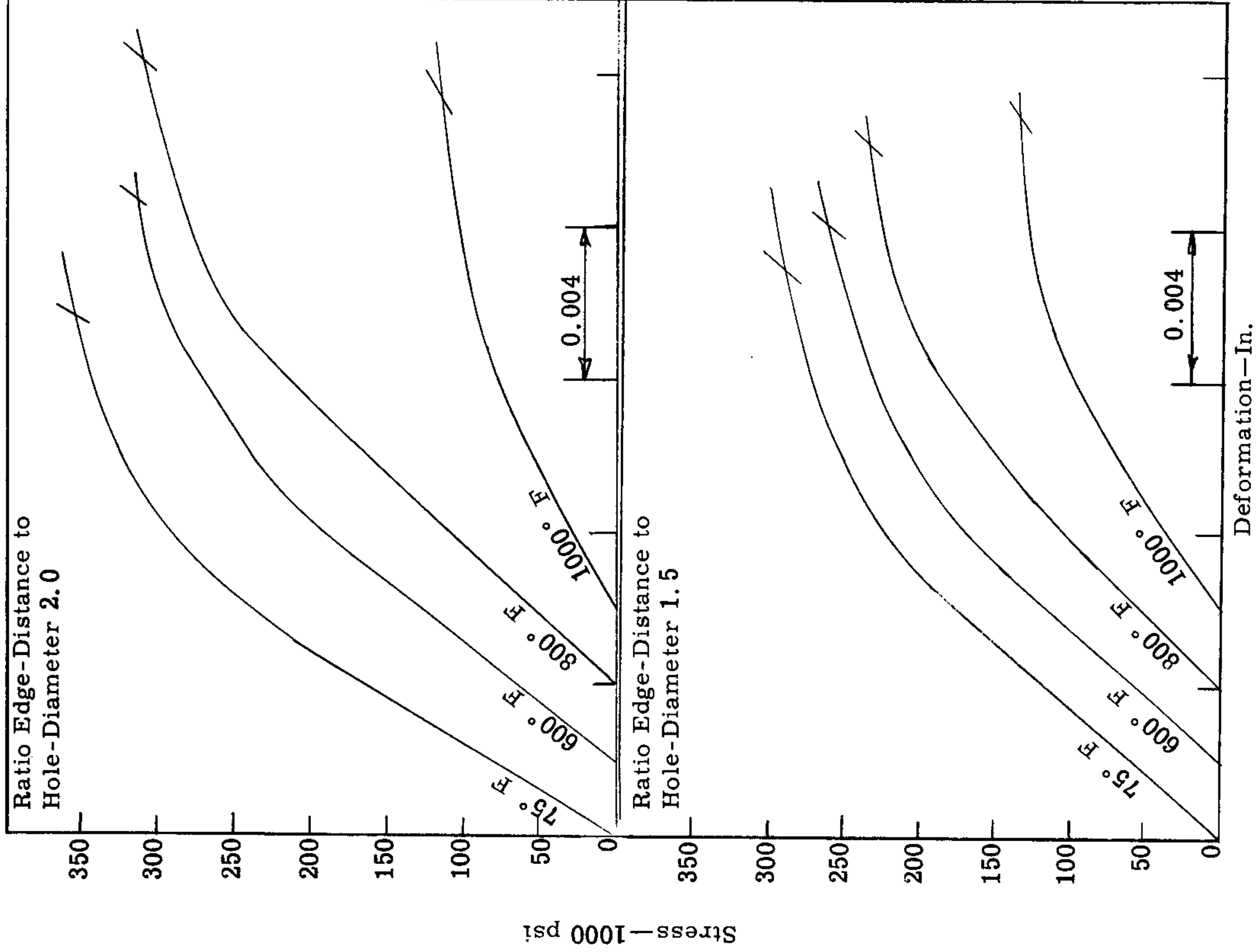

Fig. 54. Bearing stress-deformation curves for 17-7 PH stainless steel sheet (RH 950 condition) at various temperatures and one-thousand-hour exposure time.

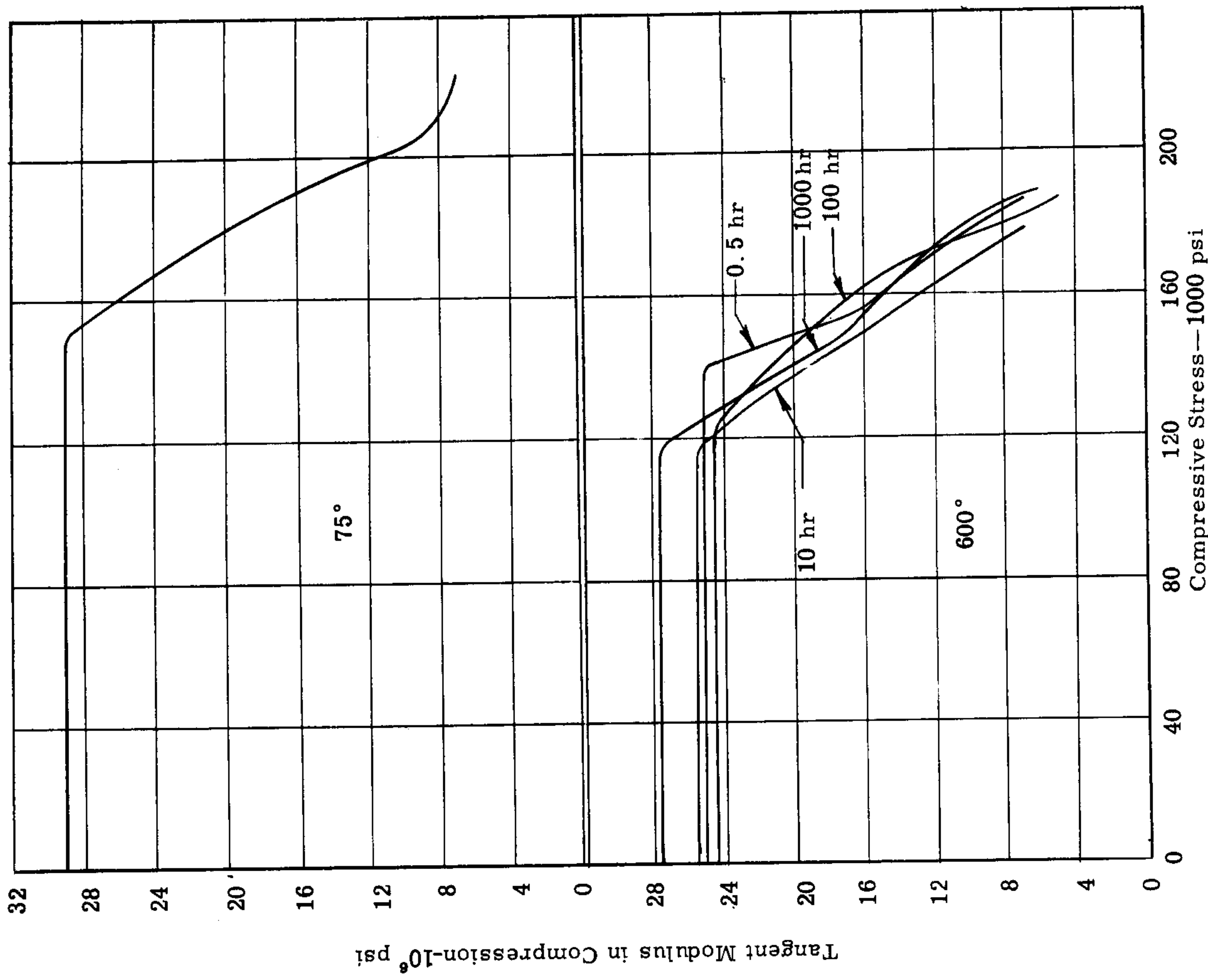

Fig. 55. Tangent-modulus vs. compressive-stress curves for 17-7 PH stainless steel sheet (RH 950 condition) at 75° F and 600° F and different exposure times.

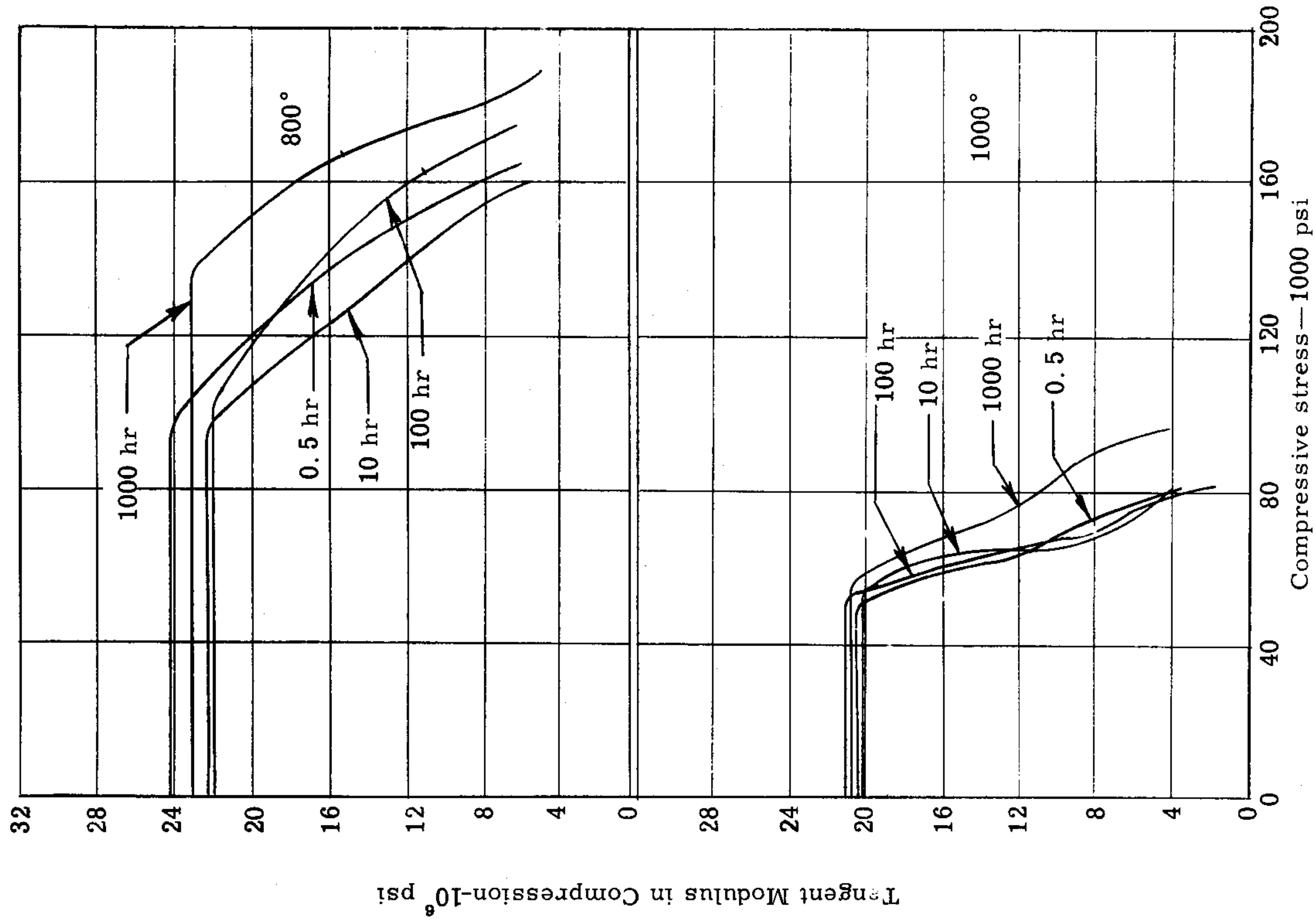

Fig. 56. Tangent-modulus vs. compressive-stress curves for 17-7 PH stainless steel sheet (RH 950 condition) at 800° F and 1000° F and different exposure times.

Tensile Properties of 0.062-In. 17-7 PH Stainless Steel¹ Sheet at Different Temperatures and Holding Times

Temp ° F	Holding Time, hr	YS 1000 psi	UTS 1000 psi	ME 10 ⁶ psi	Elong. %	Hard ¹ R45N	RS ² 1000 psi	RS ³ 1000 psi
RT	-	208.0	226.5	29.3	10	53	200.0	255.0
		215.0	229.0	28.9	10	54	210.0	285.0
		218.5	229.0	28.3	11	52	200.2	267.0
Avg		213.8	228.2	28.8	10	53	203.4	269.0
600	0.5	159.3	186.5	29.4	9	53	163.5	235.0
		160.5	187.5	28.4	9	53	166.5	238.5
		165.0	190.5	28.3	10	53	163.5	242.0
Avg		161.6	188.2	28.7	9	53	164.5	238.5
600	10	158.0	192.5	-	5	53	162.5	197.5
		-	-	27.5	4	54	-	-
		162.8	195.0	-	8	53	164.0	241.0
Avg		172.0	191.5	29.2	8	-	172.0	239.0
		164.3	193.0	28.3	6	53	166.2	225.8
600	100	163.5	195.5	31.0	6	53	176.5	235.0
		170.0	192.8	33.7	7	53	173.5	225.0
		171.2	192.2	23.0	8	53	166.5	230.2
Avg		168.2	193.5	29.2	7	53	172.2	230.1
600	1000	171.0	192.5	25.5	9	53	167.0	241.0
		171.0	193.0	28.1	9	53	169.5	237.0
		177.0	197.0	27.4	9	55	183.5	228.0
Avg		173.0	194.2	27.0	9	54	173.3	235.3

WADC TR 58-365

106

Tensile Properties of 0.062-In. 17-7 PH Stainless Steel¹ Sheet at Different Temperatures and Holding Times

Temp ° F	Holding Time, hr	YS 1000 psi	UTS 1000 psi	ME 10 psi	Elong. %	Hard ¹ R45N	RSz 1000 psi	RS ₃ 1000 psi
800	0.5	141.0	162.5	22.7	9	53	134.0	201.0
		142.0	159.5	23.2	16	52	128.5	250.0
		140.0	163.0	24.1	14	53	128.5	217.0
Avg		141.0	161.7	23.3	13	53	130.3	222.7
		141.5	159.5	26.8	16	53	129.0	222.2
		138.2	162.2	30.5	12	53	137.8	202.2
800	10	143.2	161.6	27.4	11	54	135.5	215.0
		141.0	161.1	28.2	13	53	134.1	213.1
		145.8	175.0	27.9	9	54	150.0	213.0
Avg	100	155.0	173.2	29.1	10	55	136.5	234.2
		152.1	176.9	28.0	10	54	146.2	218.7
		173.5	193.3	25.5	12	57	157.5	252.0
800	1000	174.5	195.0	27.6	12	56	166.6	266.0
		175.5	195.4	25.2	16	58	160.6	237.0
		174.5	194.6	26.1	13	57	161.6	251.7
Avg	0.5	79.0	89.6	22.7	33	53	—	—
		84.5	88.4	21.2	22	53	27.8	83.5
		83.2	89.5	22.2	27	52	24.7	74.0
1000	0.5	82.2	89.2	22.0	27	53	26.2	78.8
		84.5	88.4	21.2	22	53	27.8	83.5
		83.2	89.5	22.2	27	52	24.7	74.0
Avg		82.2	89.2	22.0	27	53	26.2	78.8

Table 10(continued)

107

WADC TR 58-365

Tensile Properties of 0.062-In. 17-7 PH Stainless Steel³ Sheet at Different Temperatures and Holding Times

Temp °F	Holding Time, hr	YS 1000 psi	UTS 1000 psi	ME 10 ⁶ psi	Elong. %	Hard ¹ R45N	RS ² 1000 psi	RS ³ 1000 psi
1000	10	72.2	88.8	19.3	33	53	39.1	119.5
	Avg	78.6	91.8	22.7	32	54	41.8	130.8
	100	75.2	88.5	25.6	31	54	55.0	189.0
1000	100	75.5	88.0	21.3	42	53	43.8	141.0
	Avg	73.7	78.0	22.7	35	49	39.1	147.4
	1000	77.2	84.5	19.0	35	51	43.1	149.2
1000	1000	78.2	85.3	18.8	34	51	45.5	125.0
	Avg	81.6	86.5	19.7	28	50	48.0	139.5
	1000	79.0	85.4	19.2	32	51	45.5	137.9

1. Hardness determinations made at room temperature after tests.
2. Rupture strength based on original cross section.
3. Rupture strength based on final cross section.
4. RH 950 condition — 1750° F 10 min argon atmosphere, A. C., -100° F 8 hr, 950° F 1 hr, A. C.

Tensile Strength of 3/16-In. 17-7 PH Stainless Steels Plate at Different Temperatures and Holding Times

Holding Time, hr	Temp ° F	1/2		10		100		1000	
		UTS ¹ 1000 psi	Hard ² RC	UTS ¹ 1000 psi	Hard ² RC	UTS ¹ 1000 psi	Hard ² RC	UTS ¹ 1000 psi	Hard ² RC
RT	Avg	184.2	46	183.8	46	186.5	47	191.0	46
		183.5	46	185.6	47	186.2	47	191.2	46
600	Avg	184.1	46	183.9	47	186.5	47	192.1	46
		184.4	45	182.1	46	187.0	47	193.0	46
800	Avg	149.0	46	168.0	48	167.5	48	178.7	50
		158.0	48	164.5	48	169.5	48	176.0	50
800	Avg	157.8	47	165.9	49	169.5	49	179.0	49
		159.3	47	160.0	48	168.8	49	181.0	49
1000	Avg	79.92	45	71.60	46	79.20	46	103.0	37
		78.24	46	68.50	46	79.20	45	101.0	36
1000	Avg	77.04	45	70.70	46	80.75	46	97.20	34
		81.64	45	—	—	—	—	—	—
	Avg	79.21	45	70.27	46	79.72	46	100.4	36

1. Ultimate tensile strength.
 2. Hardness determinations made at room temperature after tests.
 3. RH 950 Condition - 1750° F 10 min argon atmosphere, A.C., -100° F 8 hr, 950° F 1 hr, A. C.

Table 12
Compressive Properties of 0.062-In. 17-7 PH Stainless Steel Sheet at
Different Temperatures and Holding Times

Hold. Time	Temp °F		Temp °F		Temp °F		Temp °F		Temp °F		Temp °F		Temp °F	
	1000	psi	1000	psi	1000	psi	1000	psi	1000	psi	1000	psi	1000	psi
1/2	CYS	ME	Hard ²	R45N	CYS	ME	Hard	R45N	CYS	ME	Hard	R45N	CYS	ME
	1000	psi	1000	psi	1000	psi	1000	psi	1000	psi	1000	psi	1000	psi
10	CYS	ME	Hard	R45N	CYS	ME	Hard	R45N	CYS	ME	Hard	R45N	CYS	ME
	1000	psi	1000	psi	1000	psi	1000	psi	1000	psi	1000	psi	1000	psi
100	CYS	ME	Hard	R45N	CYS	ME	Hard	R45N	CYS	ME	Hard	R45N	CYS	ME
	1000	psi	1000	psi	1000	psi	1000	psi	1000	psi	1000	psi	1000	psi
1000	CYS	ME	Hard	R45N	CYS	ME	Hard	R45N	CYS	ME	Hard	R45N	CYS	ME
	1000	psi	1000	psi	1000	psi	1000	psi	1000	psi	1000	psi	1000	psi
RT	CYS	ME	Hard	R45N	CYS	ME	Hard	R45N	CYS	ME	Hard	R45N	CYS	ME
	1000	psi	1000	psi	1000	psi	1000	psi	1000	psi	1000	psi	1000	psi
Avg	CYS	ME	Hard	R45N	CYS	ME	Hard	R45N	CYS	ME	Hard	R45N	CYS	ME
	1000	psi	1000	psi	1000	psi	1000	psi	1000	psi	1000	psi	1000	psi
600	CYS	ME	Hard	R45N	CYS	ME	Hard	R45N	CYS	ME	Hard	R45N	CYS	ME
	1000	psi	1000	psi	1000	psi	1000	psi	1000	psi	1000	psi	1000	psi
Avg	CYS	ME	Hard	R45N	CYS	ME	Hard	R45N	CYS	ME	Hard	R45N	CYS	ME
	1000	psi	1000	psi	1000	psi	1000	psi	1000	psi	1000	psi	1000	psi
800	CYS	ME	Hard	R45N	CYS	ME	Hard	R45N	CYS	ME	Hard	R45N	CYS	ME
	1000	psi	1000	psi	1000	psi	1000	psi	1000	psi	1000	psi	1000	psi
Avg	CYS	ME	Hard	R45N	CYS	ME	Hard	R45N	CYS	ME	Hard	R45N	CYS	ME
	1000	psi	1000	psi	1000	psi	1000	psi	1000	psi	1000	psi	1000	psi
1000	CYS	ME	Hard	R45N	CYS	ME	Hard	R45N	CYS	ME	Hard	R45N	CYS	ME
	1000	psi	1000	psi	1000	psi	1000	psi	1000	psi	1000	psi	1000	psi
Avg	CYS	ME	Hard	R45N	CYS	ME	Hard	R45N	CYS	ME	Hard	R45N	CYS	ME
	1000	psi	1000	psi	1000	psi	1000	psi	1000	psi	1000	psi	1000	psi

1. Compressive yield strength
 2. Hardness determinations made at room temperature after tests.
 3. RH 950 Condition - 1750° F 10 min argon atmosphere, A. C., -100° F 8 hr, 950° F 1 hr, A. C.

1. Ultimate shear strength.
2. Hardness determinations made at room temperature after tests.
3. RH 950 Condition - 1750° F 10 min argon atmosphere, A.C., -100° F 8 hr, 950° F 1 hr, A.C.

Holding Time, hr	Temp °F	1/2		10		100		1000	
		USS ¹	Hard ²	USS	Hard	USS	Hard	USS	Hard
RT	Avg	105.8	-	106.5	44	105.0	46	110.0	46
		101.5	35	109.9	44	109.0	46	113.0	47
600	Avg	104.5	-	109.8	44	110.0	47	-	-
		106.5	43	108.5	45	-	-	-	-
800	Avg	98.6	39	97.1	40	108.5	47	102.5	48
		99.0	40	104.1	42	99.2	47	95.5	48
800	Avg	103.8	38	101.3	40	105.5	46	94.5	48
		96.7	42	-	-	-	-	-	-
1000	Avg	67.1	42	63.0	40	63.5	41	63.0	39
		65.5	37	65.5	39	66.0	42	69.3	40
1000	Avg	61.3	42	-	-	-	-	-	-
		64.5	39	63.8	39	64.5	41	67.2	40

Shear Strength of 3/16-In. 17-7 PH Stainless Steel³ Plate at Different Temperatures and Holding Times

Table 13

WADC TR 58-365

111

Bearing Properties⁴ of 0.062-In. 17-7 PH Stainless Steel⁵ Sheet at Different Temperatures and Holding Times

Table 14

Hold. Time hr	Temp ° F	1/2		10		100		1000	
		BYS ¹ UBS ²	Hard ³ R45N	BYS UBS	Hard R45N	BYS UBS	Hard R45N	BYS UBS	Hard R45N
RT	358.0	316.0	358.0	316.0	358.0	316.0	358.0	316.0	358.0
	355.0	300.0	355.0	300.0	355.0	300.0	355.0	300.0	355.0
	361.0	317.0	361.0	317.0	361.0	317.0	361.0	317.0	361.0
	352.0	295.0	352.0	295.0	352.0	295.0	352.0	295.0	352.0
	356.5	307.0	356.5	307.0	356.5	307.0	356.5	307.0	356.5
600	-	300.0	300.0	307.0	263.0	307.0	263.0	310.5	266.5
	273.0	307.0	260.0	275.0	263.0	309.0	263.0	311.0	257.0
	270.0	303.0	277.0	265.5	310.5	257.0	265.5	314.5	268.5
	273.0	301.0	253.0	275.0	307.0	265.0	275.0	305.0	265.0
	272.0	302.8	262.5	269.6	308.4	264.3	269.6	311.3	264.3
800	216.0	255.0	224.5	255.0	286.0	243.2	255.0	290.0	245.5
	231.0	263.0	217.0	244.0	282.0	236.0	244.0	288.0	236.0
	234.0	268.0	212.0	257.0	285.0	248.0	257.0	292.0	248.0
	227.0	262.0	217.5	252.0	284.3	243.2	252.0	290.0	243.2
	-	-	-	-	-	-	-	-	-
AVG	227.0	262.0	217.5	252.0	284.3	243.2	252.0	290.0	243.2
	234.0	268.0	212.0	244.0	282.0	236.0	244.0	288.0	236.0
	216.0	255.0	224.5	255.0	286.0	243.2	255.0	290.0	245.5
	273.0	301.0	253.0	275.0	307.0	265.0	275.0	305.0	265.0
	272.0	302.8	262.5	269.6	308.4	264.3	269.6	311.3	264.3

WADC TR 58-365

112

Bearing Properties of 0.062-In. 17-7 PH Stainless Steels Sheet at Different Temperatures and Holding Times

Hold. Time	Temp °F	1/2		10		100		1000	
		UBS ²	BYS ¹	UBS	BYS	UBS	BYS	UBS	BYS
hr	°F	1000 psi		1000 psi		1000 psi		1000 psi	
		Hard ³	R45N	Hard	R45N	Hard	R45N	Hard	R45N
1000	105.0	135.0	55	119.5	54	129.0	47	149.0	45
	99.0	121.0	54	113.0	53	129.0	45	146.0	45
	105.0	118.0	55	123.5	53	130.0	47	145.0	43
	103.0	124.7	55	118.7	53	106.2	46	146.7	44

1. Bearing yield strength.
2. Ultimate bearing strength.
3. Hardness determinations made at room temperature after tests.
4. Edge-distance to hole-diameter ratio 1.5.
5. RH 950 Condition - 1750° F 10 min argon atmosphere, A. C., -100° F, 8 hr, 950° F 1 hr, A. C.

Table 14 (continued)

Bearing Properties⁴ of 0.062-In. 17-7 PH Stainless Steel⁵ Sheet at Different Temperatures and Holding Times

Table 15

Hold. Time hr	Temp ° F	1/2		10		100		1000	
		BYS ¹ UBS ²	Hard ³ R45N	BYS UBS	Hard R45N	BYS UBS	Hard R45N	BYS UBS	Hard R45N
RT	Avg	325.0	397.0	311.0	387.0	344.0	397.0	325.0	387.0
	54	320.0	390.3	312.0	383.0	338.0	402.0	315.0	387.0
	53	311.0	390.0	-	386.0	332.0	405.0	312.0	382.0
	53	299.0	384.5	313.0	387.0	337.0	408.0	315.0	388.0
600	Avg	313.7	390.5	312.0	385.8	337.8	403.0	316.8	386.0
	54	325.0	397.0	311.0	387.0	344.0	397.0	325.0	387.0
	53	320.0	390.3	312.0	383.0	338.0	402.0	315.0	387.0
	53	311.0	390.0	-	386.0	332.0	405.0	312.0	382.0
800	Avg	262.0	314.5	272.0	341.0	296.5	351.0	299.0	376.0
	54	255.0	323.0	276.0	345.0	284.0	355.0	296.0	376.0
	53	262.0	314.5	272.0	341.0	296.5	351.0	299.0	376.0
	53	248.5	338.0	285.0	345.0	300.0	357.0	311.0	376.0
Avg	255.2	325.2	279.0	344.5	293.5	354.5	302.0	376.0	
	-	-	283.0	347.0	-	-	-	-	
	255.2	325.2	279.0	344.5	293.5	354.5	302.0	376.0	
	255.2	325.2	279.0	344.5	293.5	354.5	302.0	376.0	

Table 15 (continued)

Bearing Properties⁴ of 0.062-In. 17-7 PH Stainless Steel⁵ Sheet at Different Temperatures and Holding Times

Hold. Time hr	Temp ° F	1/2		10		100		1000	
		BYS ¹ 1000 psi	UBS ² 1000 psi	BYS ¹ 1000 psi	UBS ² 1000 psi	BYS ¹ 1000 psi	UBS ² 1000 psi	BYS ¹ 1000 psi	UBS ² 1000 psi
		Hard ³ R45N	BYS ¹ 1000 psi	Hard ³ R45N	BYS ¹ 1000 psi	Hard ³ R45N	BYS ¹ 1000 psi	Hard ³ R45N	BYS ¹ 1000 psi
		48	143.0	50	173.0	46	158.0	39	146.0
		52	146.0	52	173.0	48	155.0	40	145.0
		51	146.0	52	169.0	45	157.0	40	166.0
		50	145.0	51	171.7	46	156.7	40	152.3
		50	181.3	50	178.0	46	158.0	39	146.0
		51	190.0	52	176.0	48	155.0	40	145.0
		51	158.0	52	149.0	45	157.0	40	166.0
		50	154.7	52	149.0	46	156.7	40	152.3
			181.3		178.0		158.0		146.0
			190.0		176.0		155.0		145.0
			158.0		149.0		157.0		166.0
			154.7		149.0		156.7		152.3
			181.3		178.0		158.0		146.0
			190.0		176.0		155.0		145.0
			158.0		149.0		157.0		166.0
			154.7		149.0		156.7		152.3

1. Bearing yield strength.
2. Ultimate bearing strength.
3. Hardness determinations made at room temperature after tests.
4. Edge-distance to hole-diameter ratio 2.0.
5. RH 950 condition—1750°F 10 min argon atmosphere, A. C., -100° F 8 hr, 950° F 1 hr, A. C.

10.3 Thermold J Alloy Steel Sheet, Quenched and Tempered

WADC TR 58-365

116

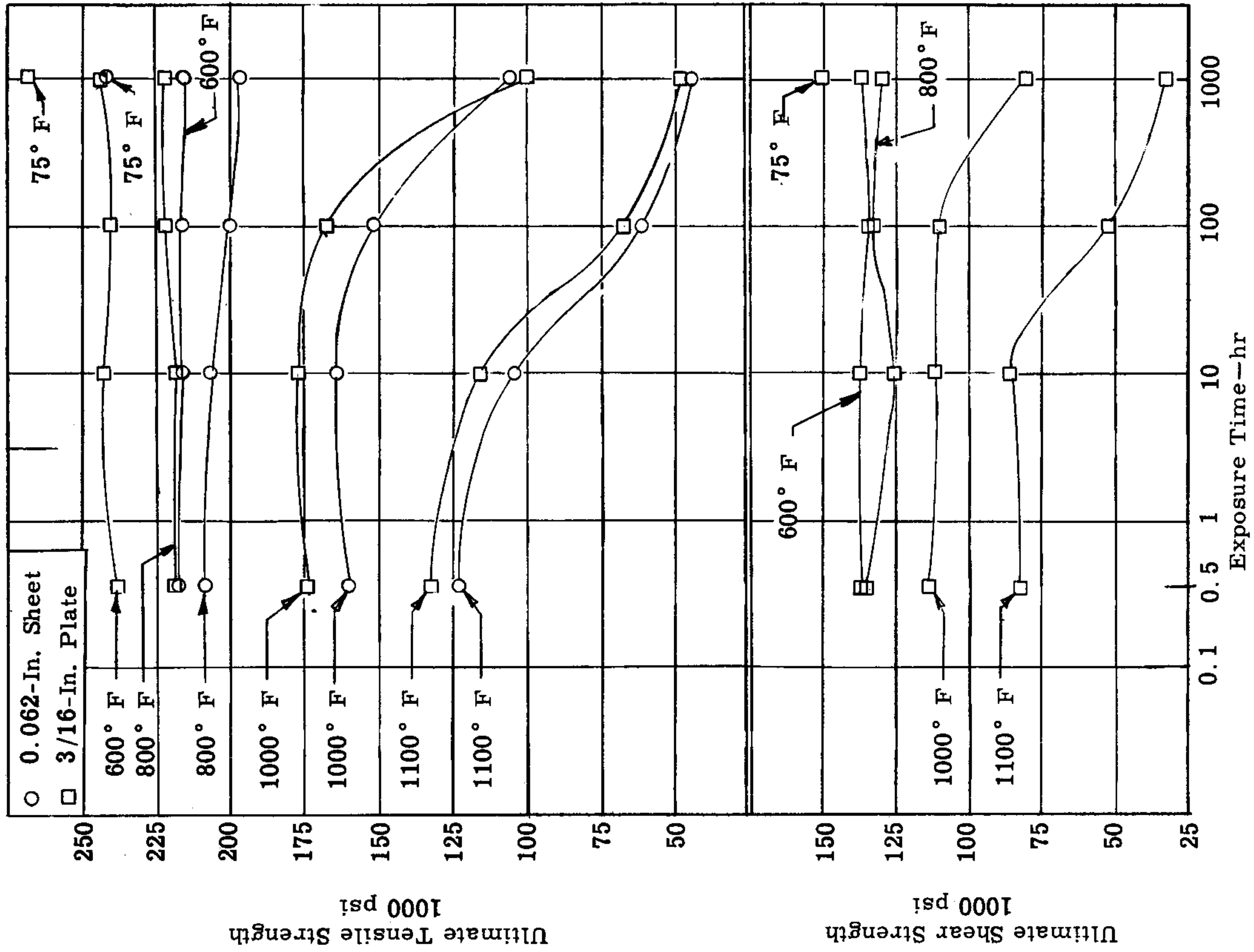

Fig. 57. Effect of exposure time on the ultimate tensile strength and ultimate shear strength of quenched and tempered Thermold J alloy steel at different temperatures.

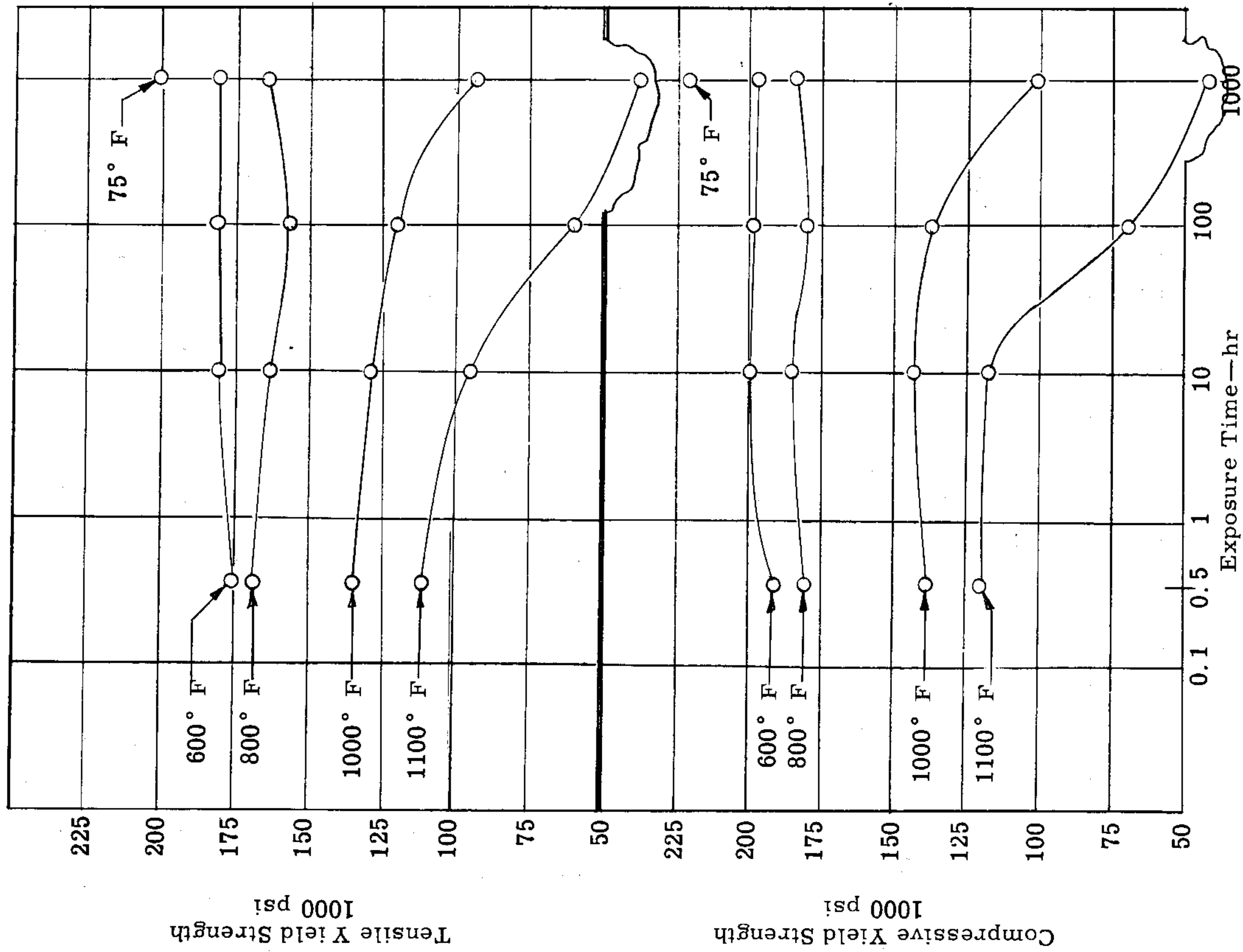

Fig. 58. Effect of exposure time on the tensile and compressive yield strength of quenched and tempered Thermold J alloy steel sheet at different temperatures.

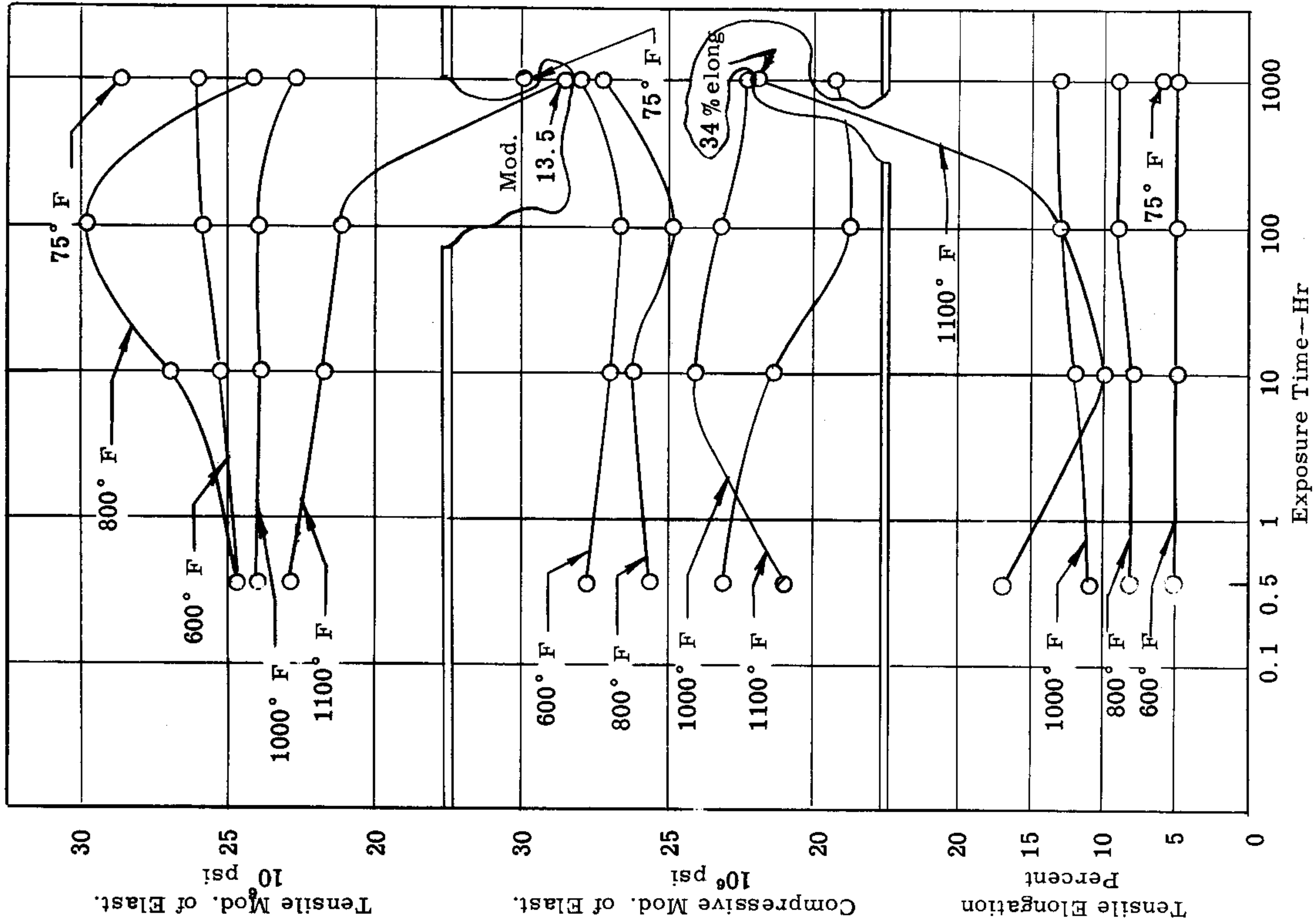

Fig. 59. Effect of exposure time on the tensile and compressive moduli of elasticity and percent elongation of quenched and tempered Thermold J alloy steel sheet at different temperatures.

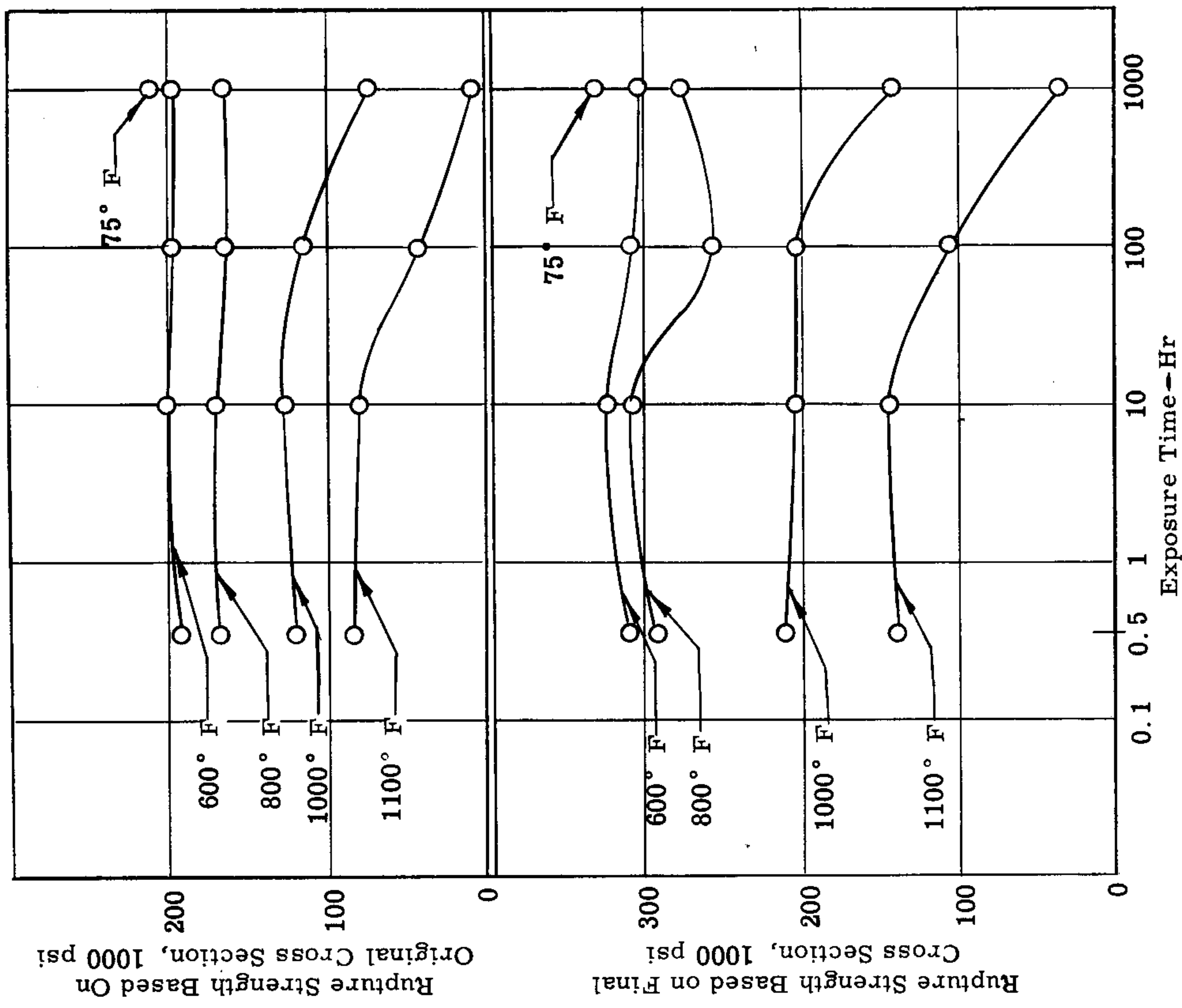

Fig. 60. Effect of exposure time on the tensile rupture strength of quenched and tempered Thermold J alloy steel sheet at different temperatures.

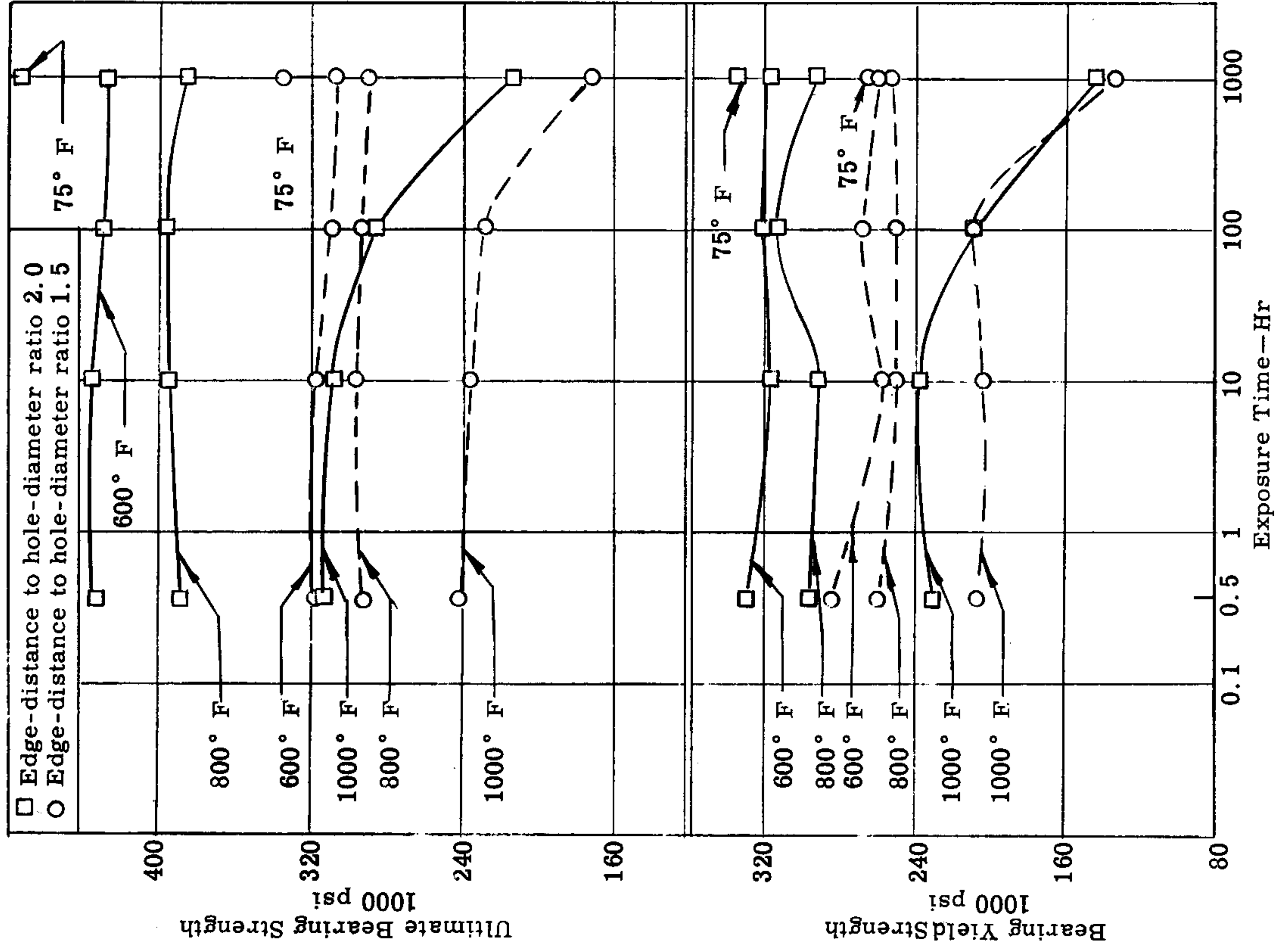

Fig. 61. Effect of exposure time on the bearing ultimate and yield strengths of quenched and tempered Thermold J alloy steel sheet at different temperatures

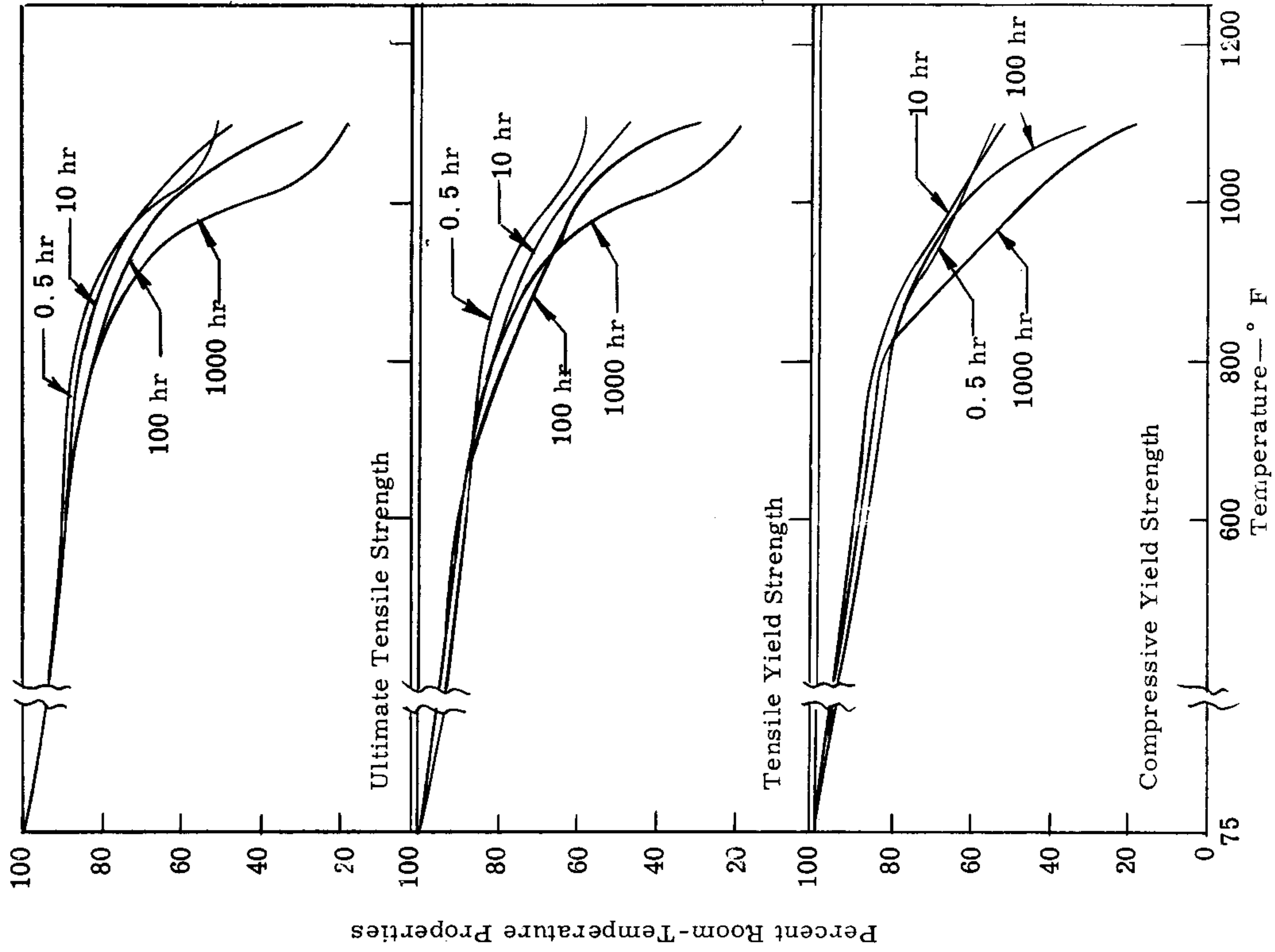

Fig. 62. Elevated-temperature strength properties as percent of room-temperature properties for quenched and tempered Thermold J alloy steel sheet at different exposure times.

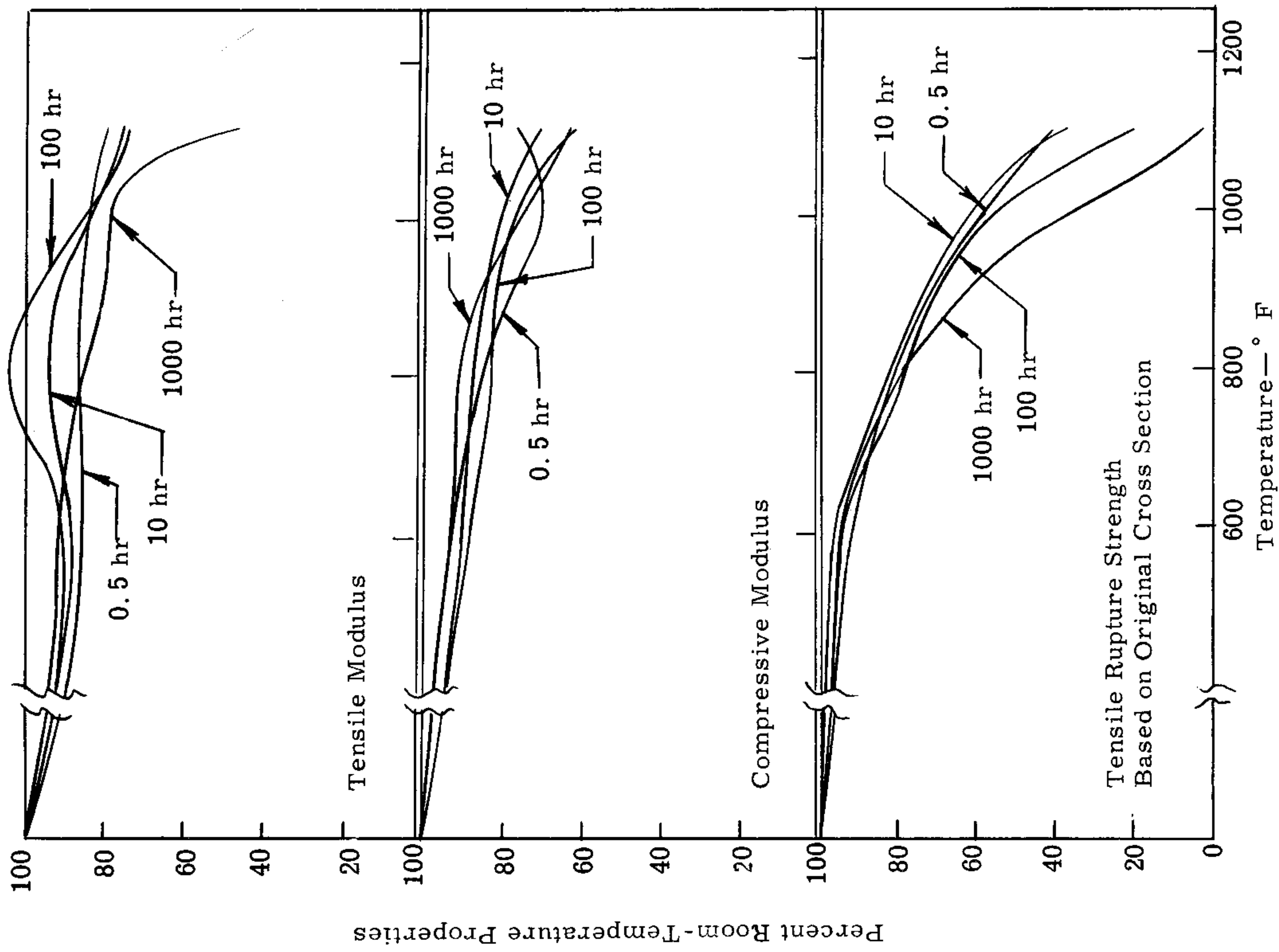

Fig. 63. Elevated-temperature properties as percent of room-temperature properties for quenched and tempered Thermold J alloy steel sheet at different exposure times.

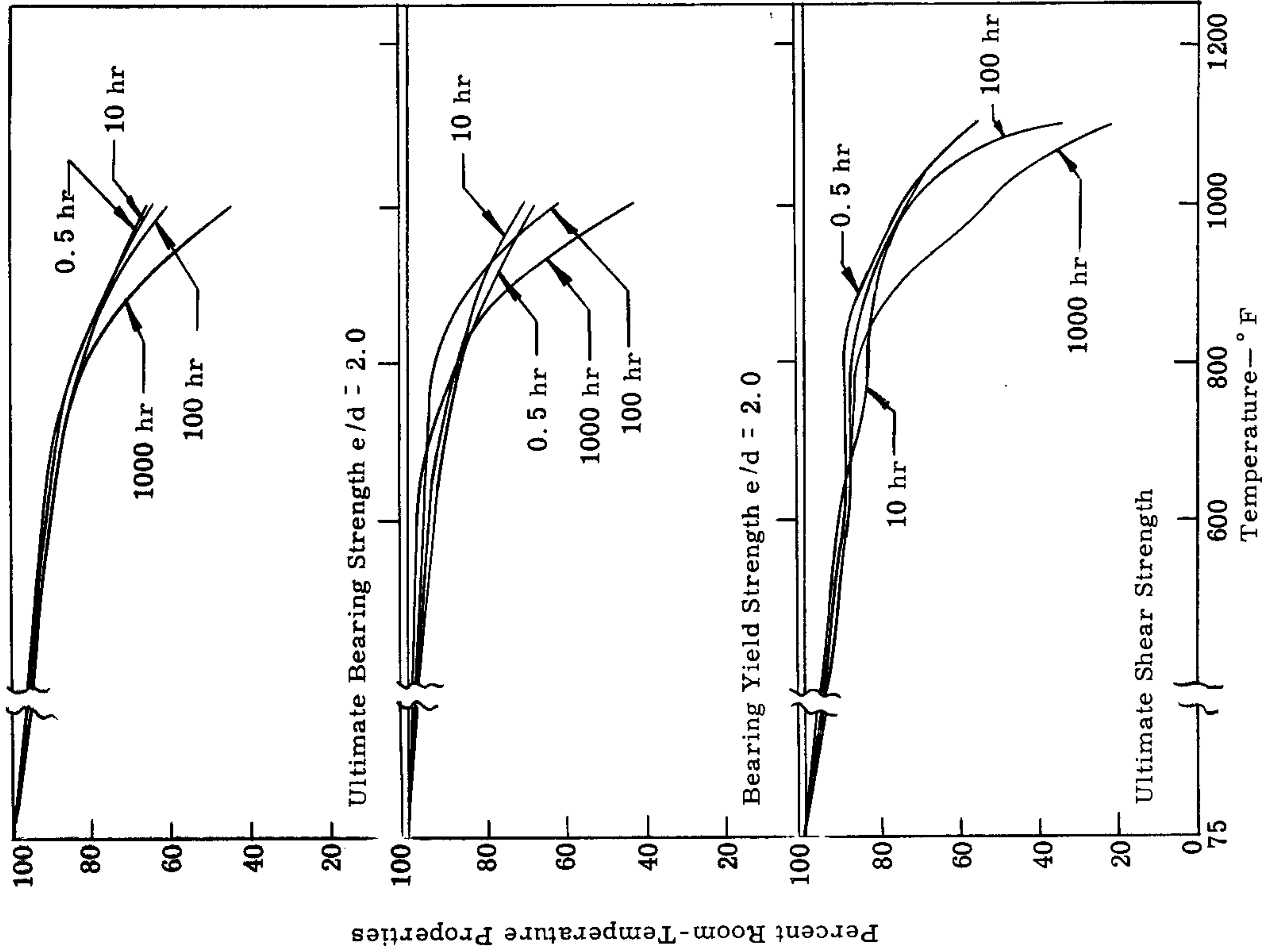

Fig. 64. Elevated-temperature strength properties as percent of room-temperature properties for quenched and tempered Thermold J alloy steel sheet at different exposure times.

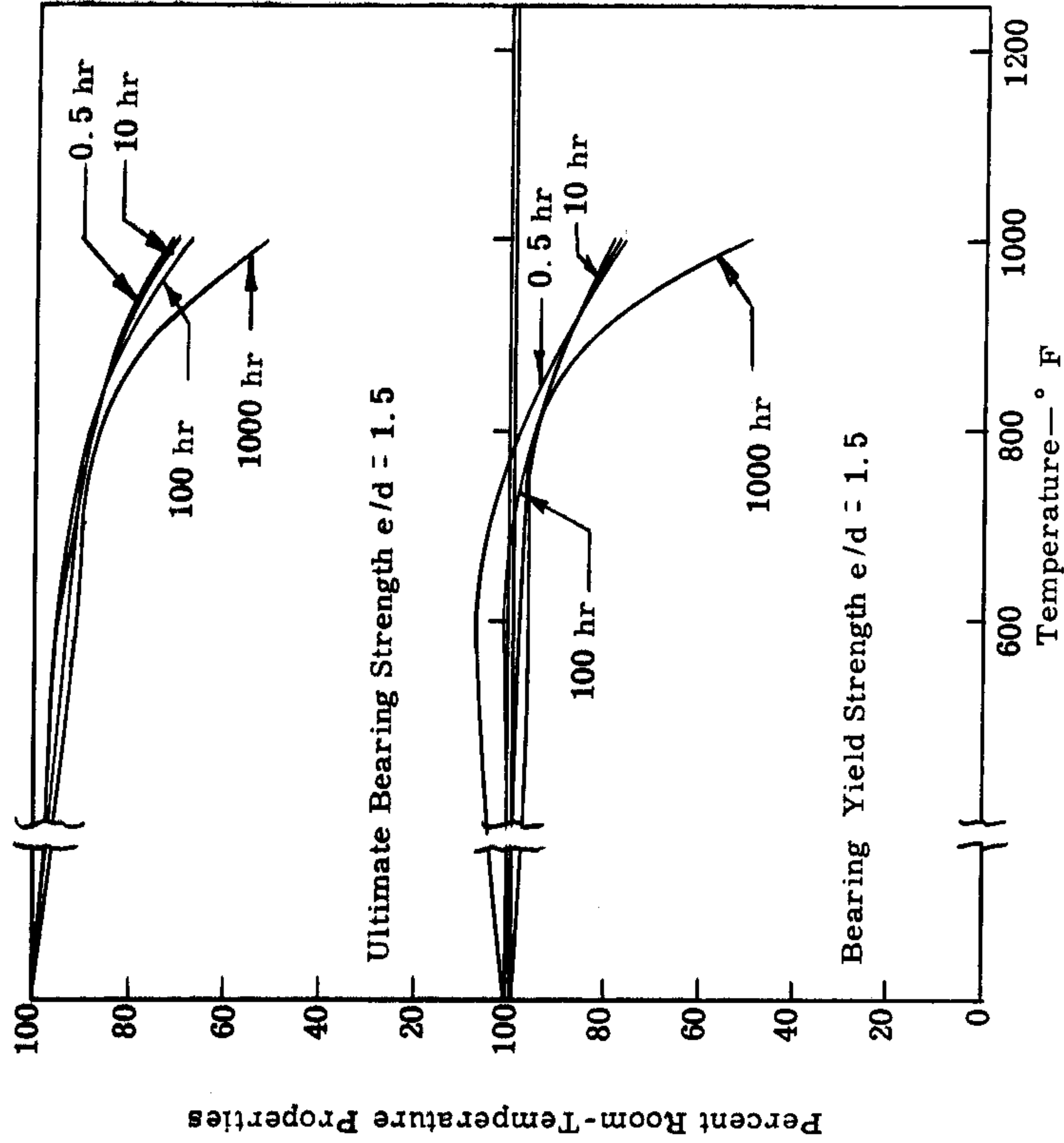

Fig. 65. Elevated-temperature strength properties as percent of room-temperature properties for quenched and tempered Thermold J alloy steel sheet at different exposure times.

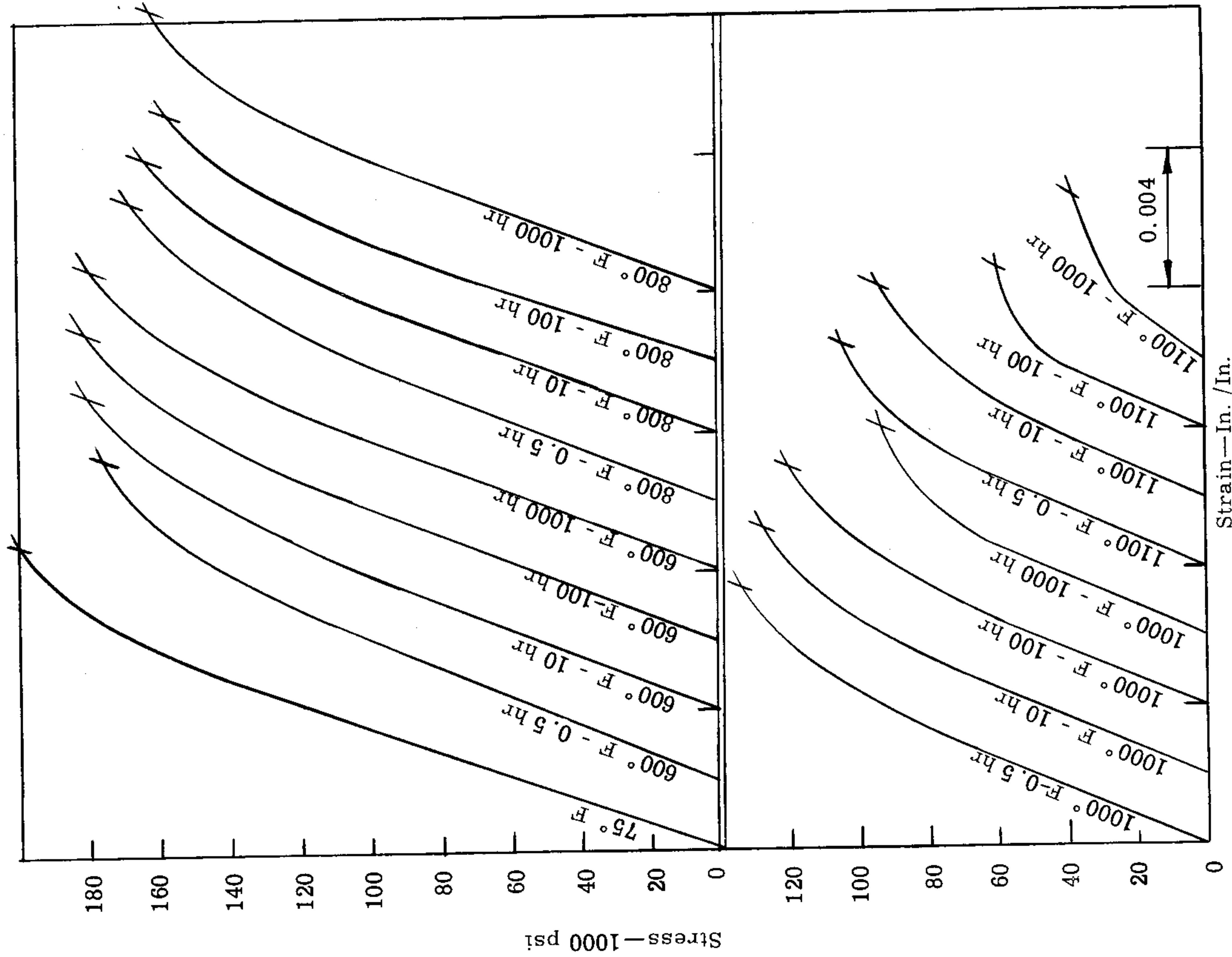

Fig. 66. Tensile stress-strain curves for quenched and tempered Thermold J alloy steel sheet at various temperatures and exposure times.

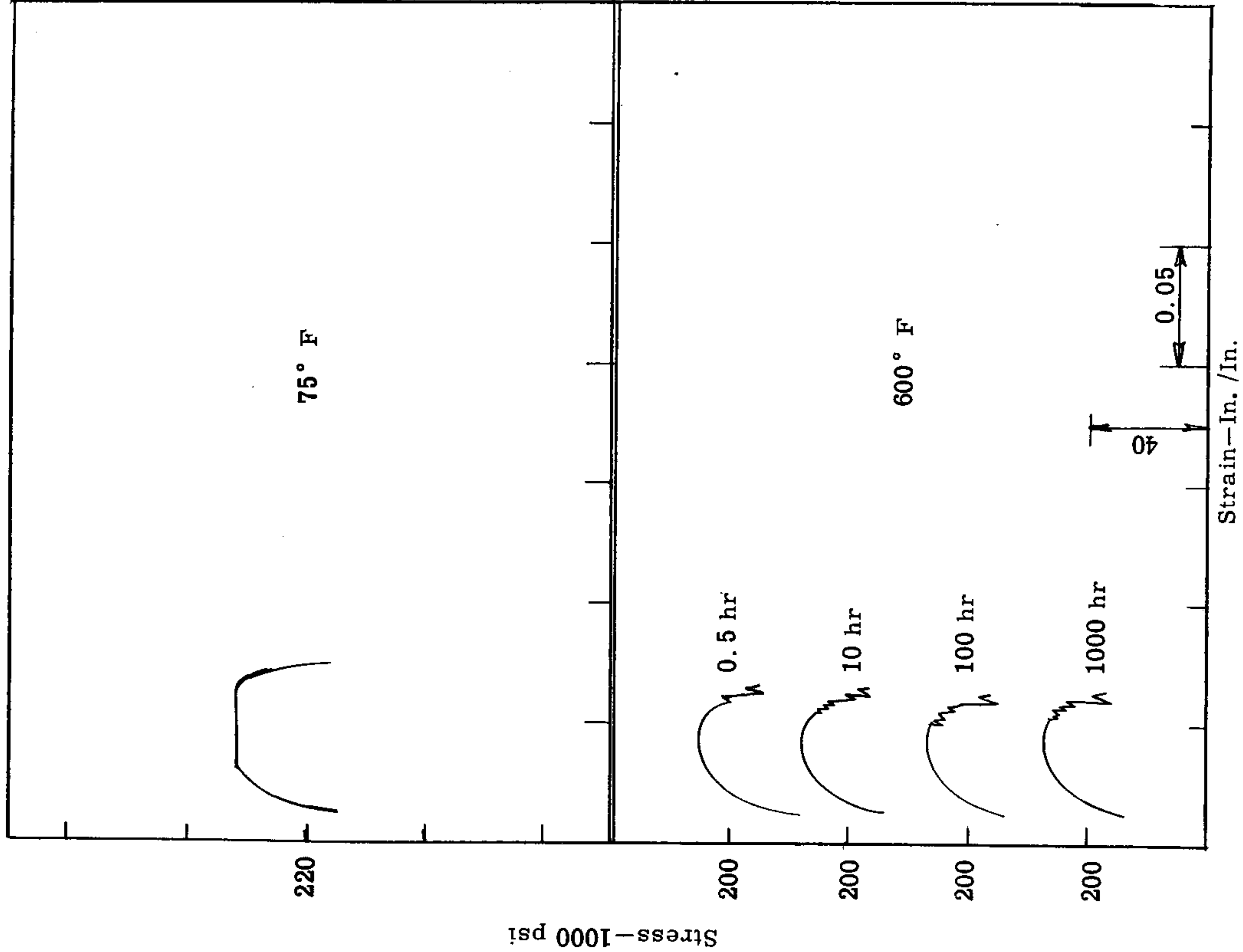

Fig. 67. Tensile postyield stress-strain curves for quenched and tempered Thermold J alloy steel sheet at various temperatures and exposure times.

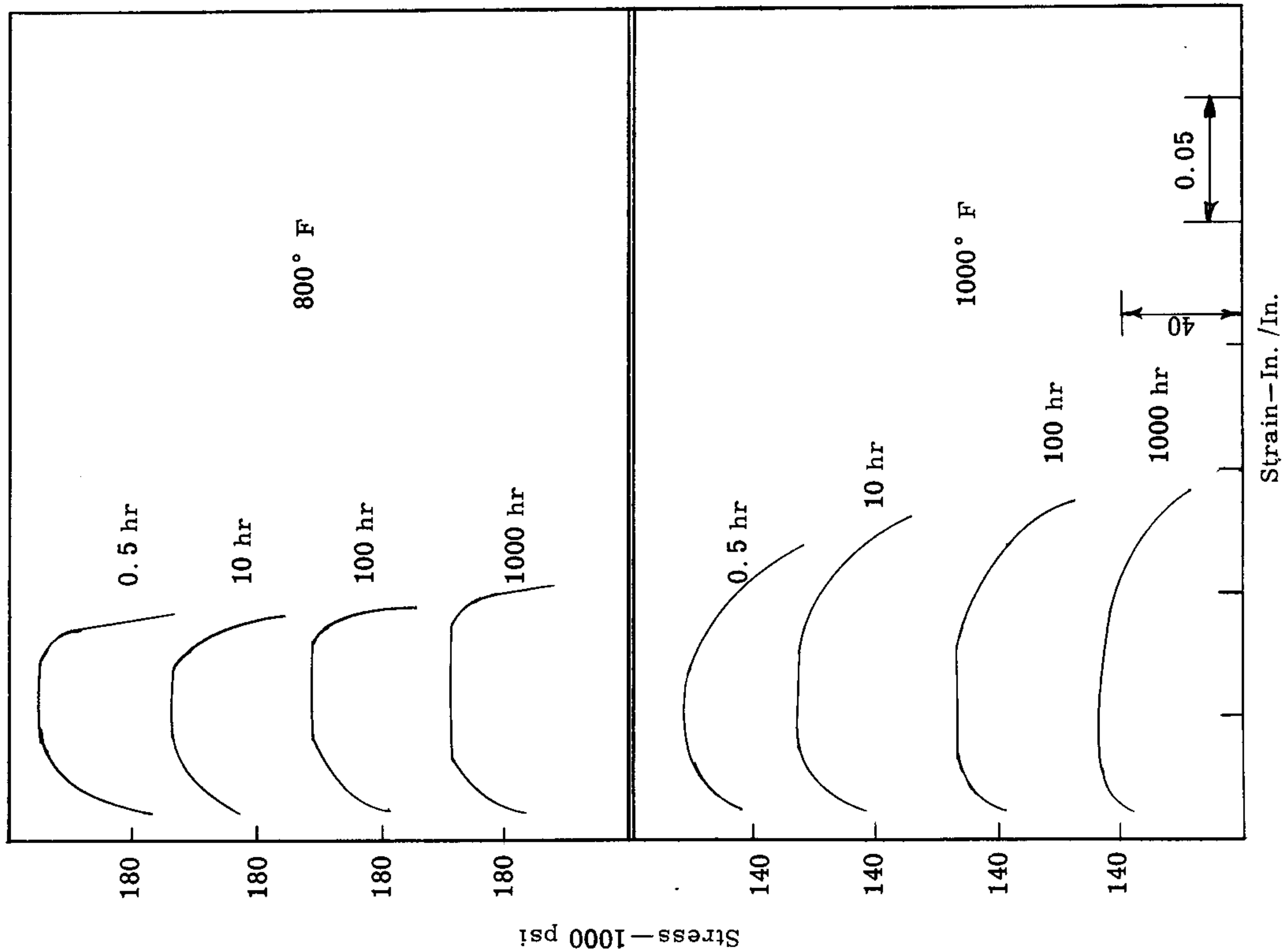

Fig. 68. Tensile postyield stress-strain curves for quenched and tempered Thermold J alloy steel sheet at various temperatures and exposure times.

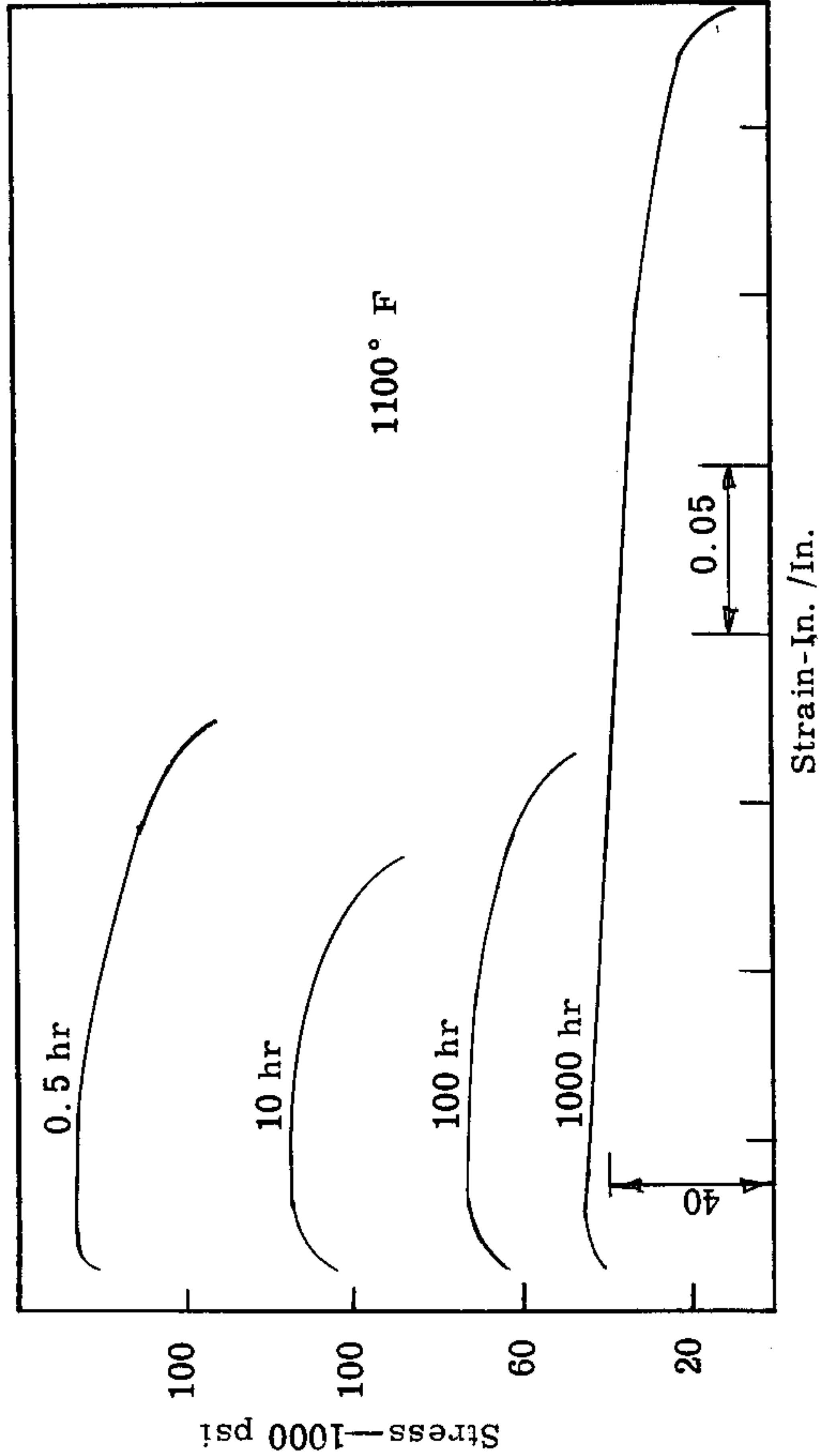

Fig. 69. Tensile postyield stress-strain curves for quenched and tempered Thermold J alloy steel sheet at various temperatures and exposure times.

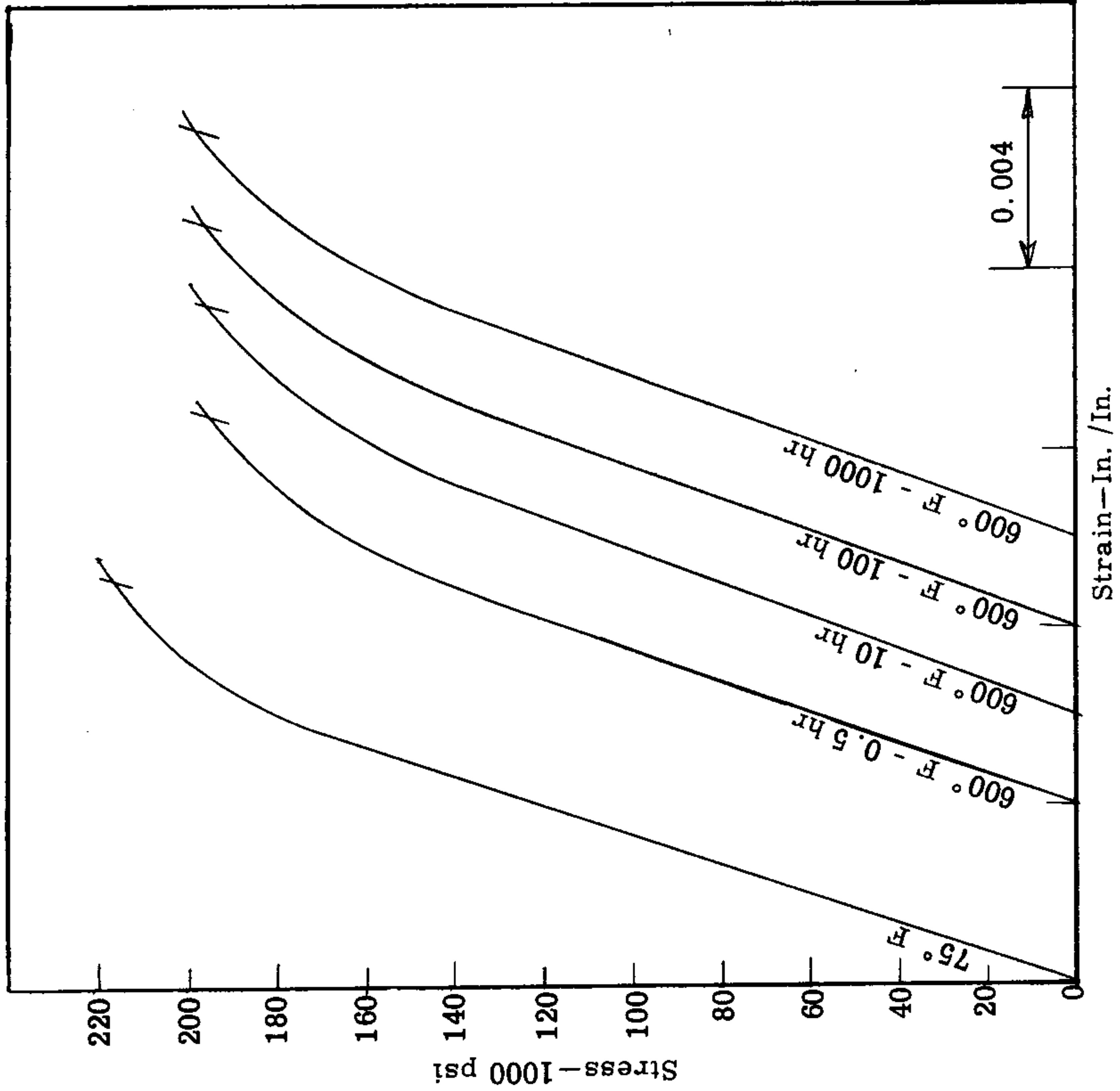

Fig. 70. Compressive stress-strain curves for quenched and tempered Thermold J alloy steel sheet at various temperatures and exposure times.

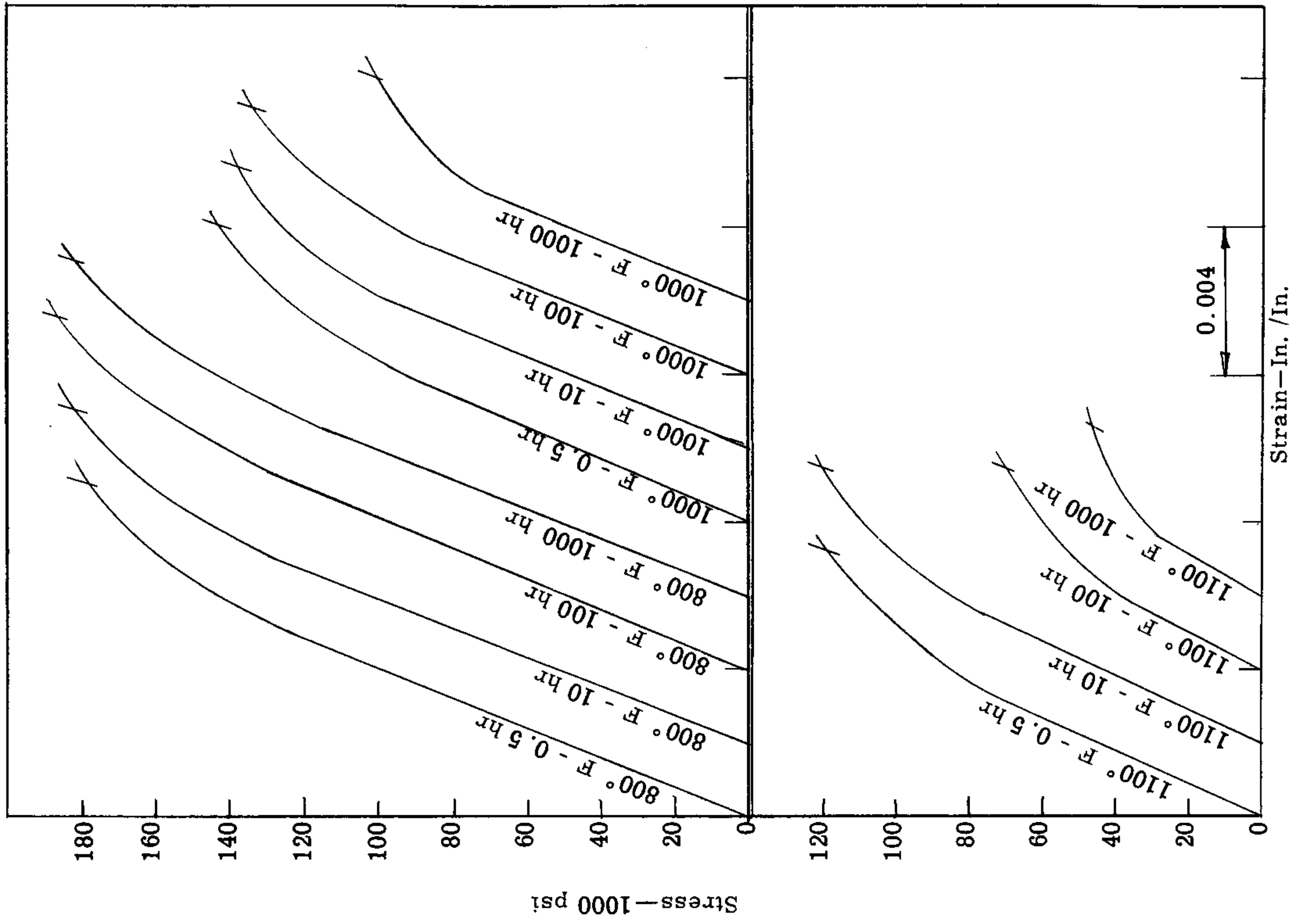

Fig. 71. Compressive stress-strain curves for quenched and tempered Thermold J alloy steel sheet at various temperatures and exposure times

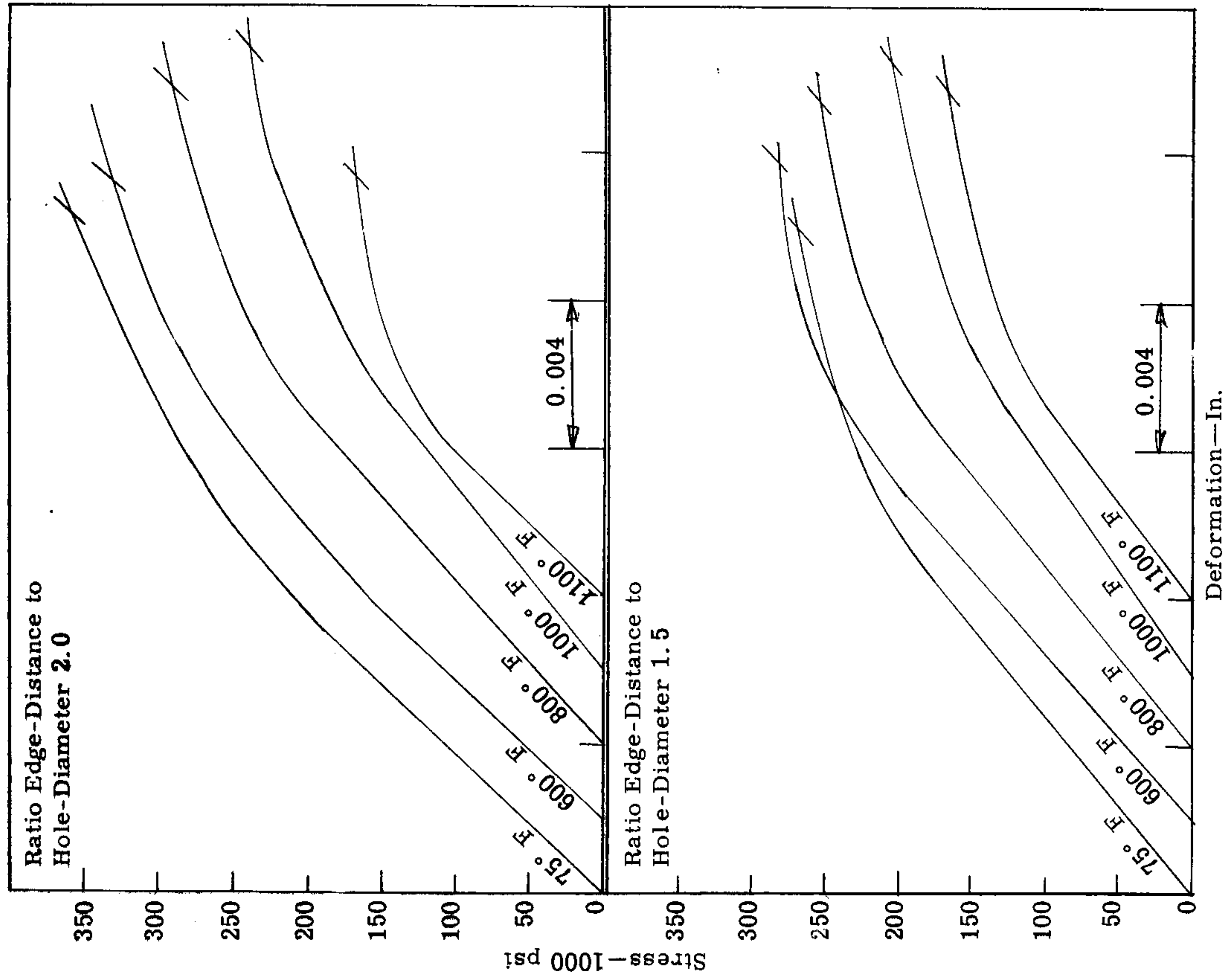

Fig. 72. Bearing stress-deformation curves for quenched and tempered Thermold J alloy steel sheet at various temperatures and one-half-hour exposure time

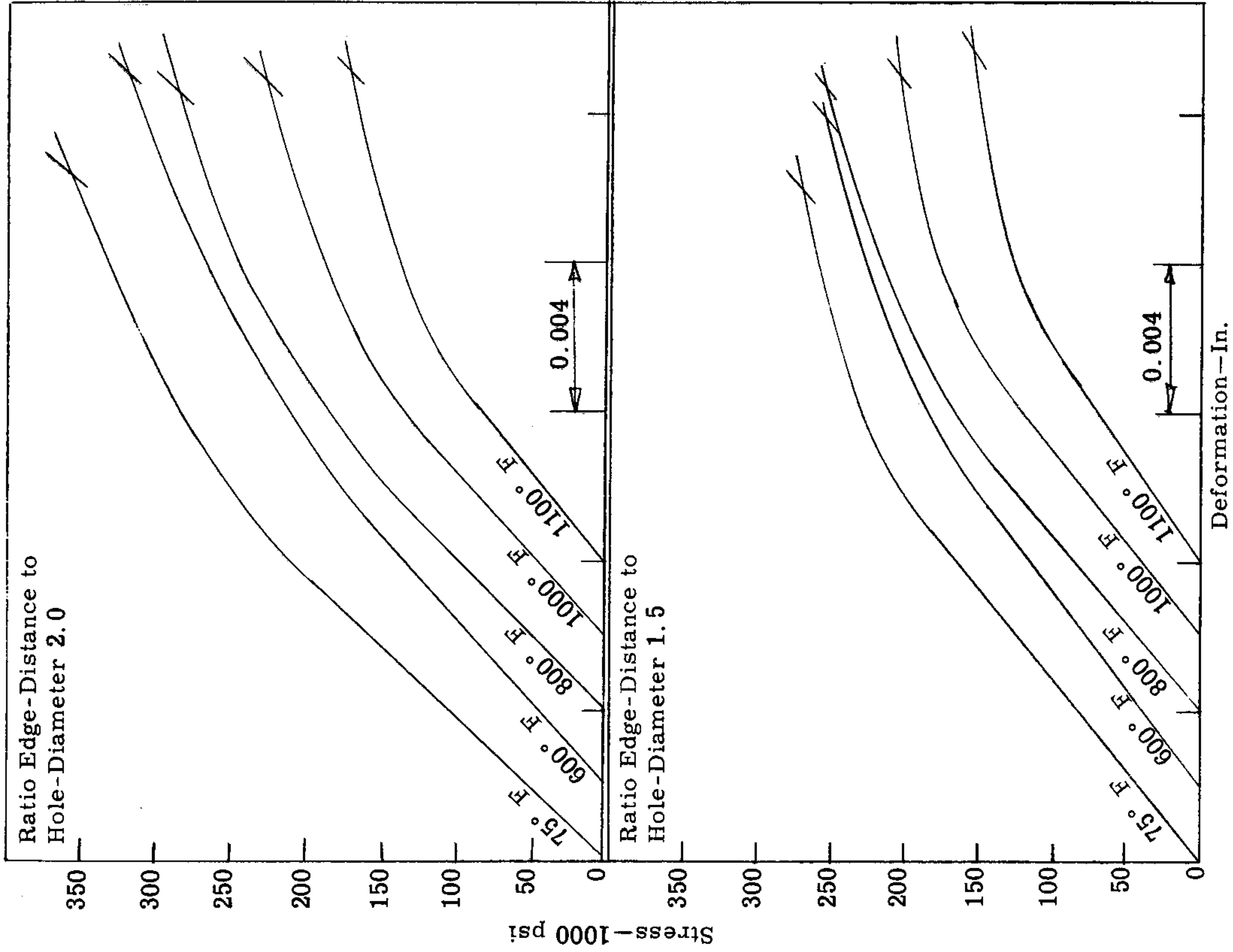

Fig. 73. Bearing stress-deformation curves for quenched and tempered Thermold J alloy steel sheet at various temperatures and ten-hour exposure time.

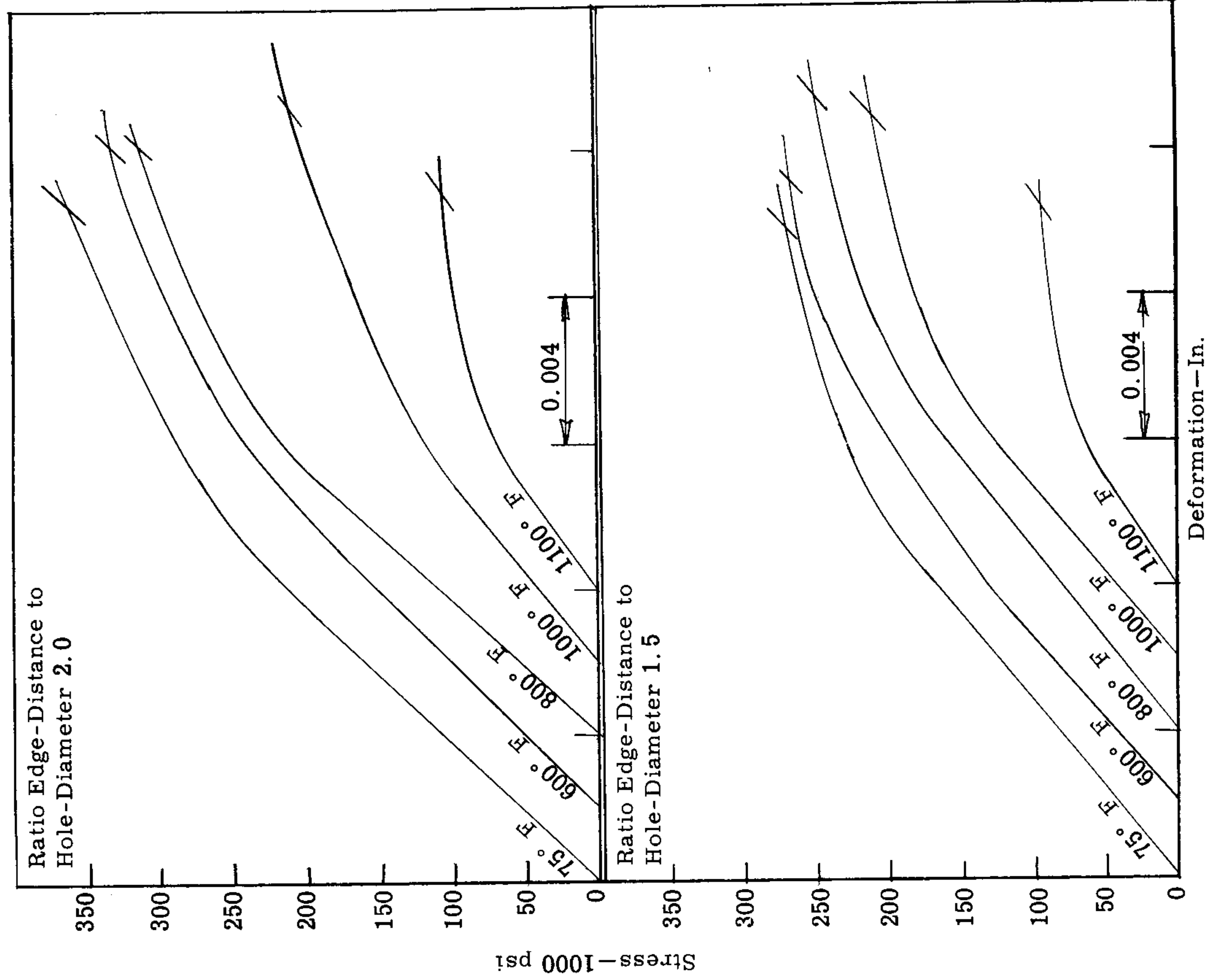

Fig. 74. Bearing stress-deformation curves for quenched and tempered Thermold J alloy steel sheet at various temperatures and one-hundred-hour exposure time.

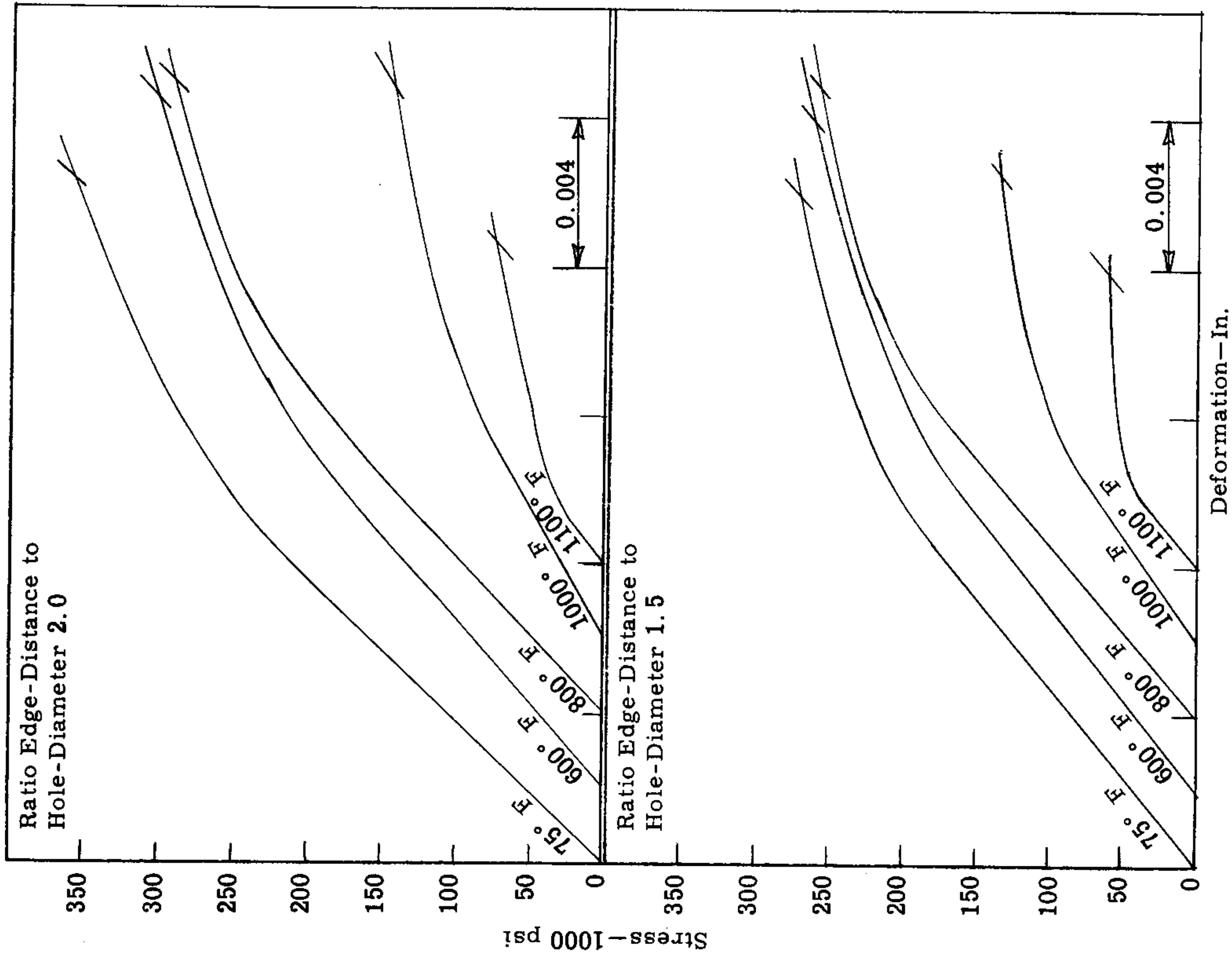

Fig. 75. Bearing stress-deformation curves for quenched and tempered Thermold J alloy steel sheet at various temperatures and one-thousand-hour exposure time.

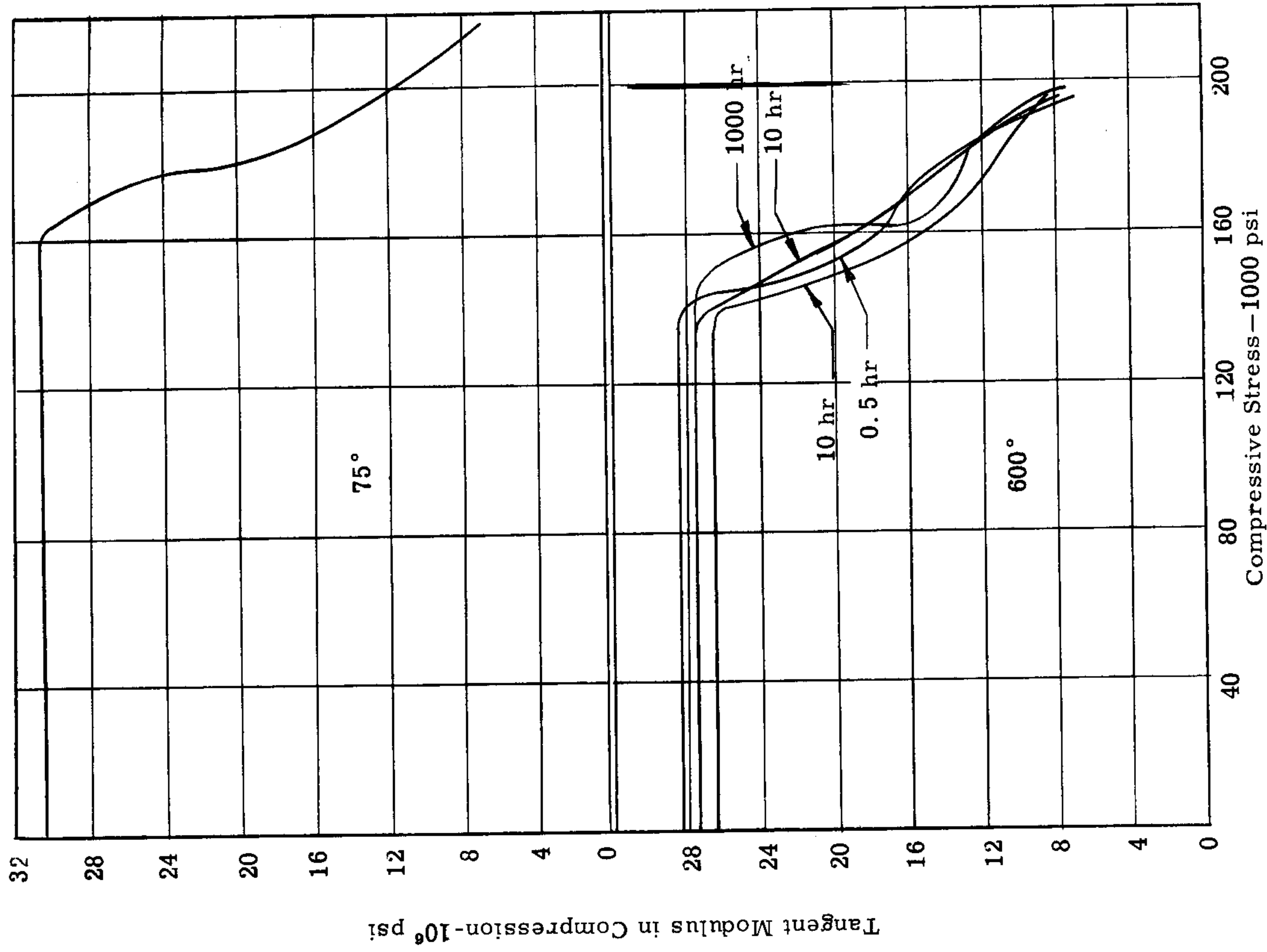

Fig. 76. Tangent-modulus vs. compressive-stress curves for quenched and tempered Thermold J alloy steel sheet at 75° F and 600° F and different exposure times.

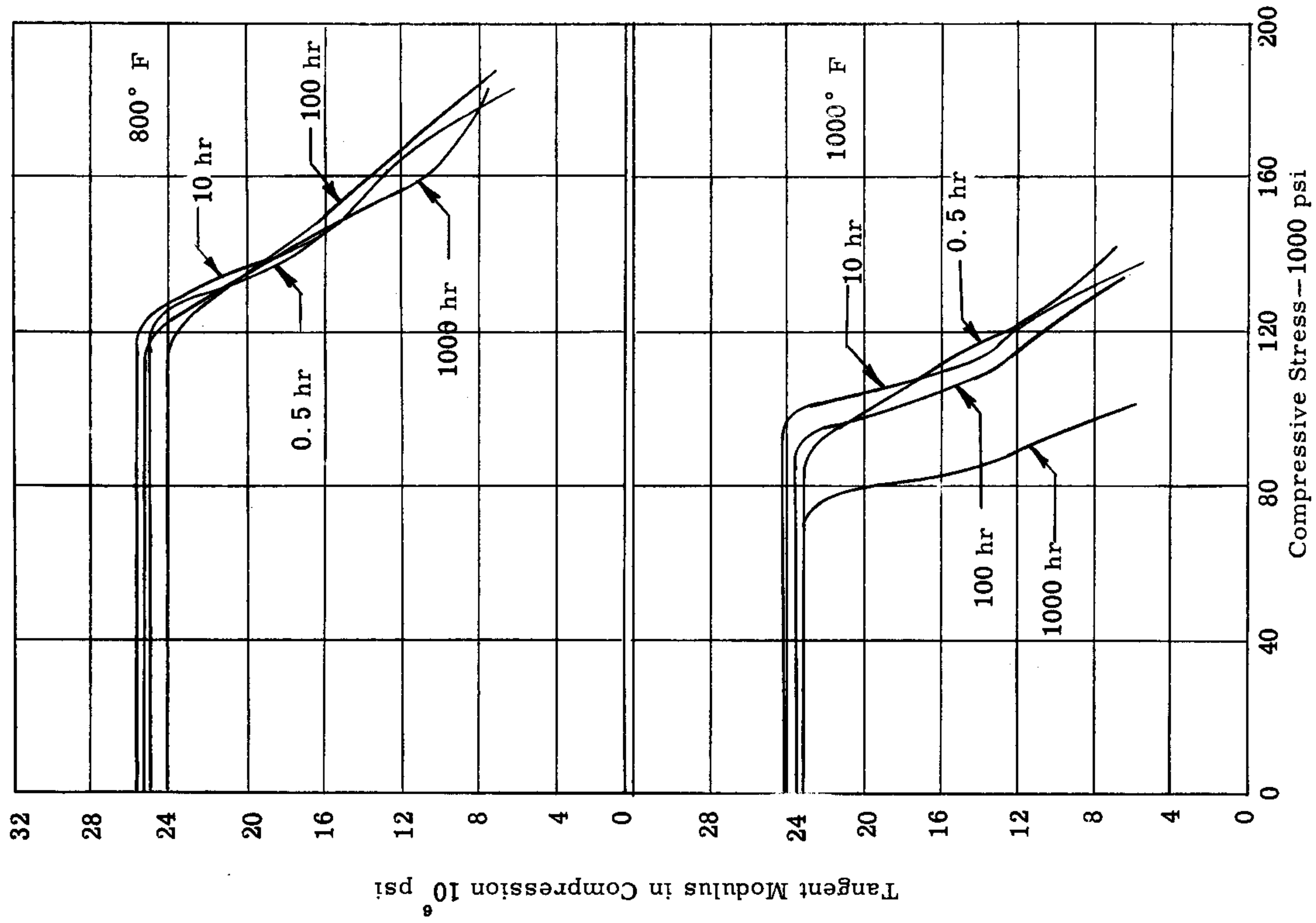

Fig. 77. Tangent-modulus vs. compressive-stress curves for quenched and tempered Thermold J alloy steel sheet at 800° F and 1000° F and different exposure times.

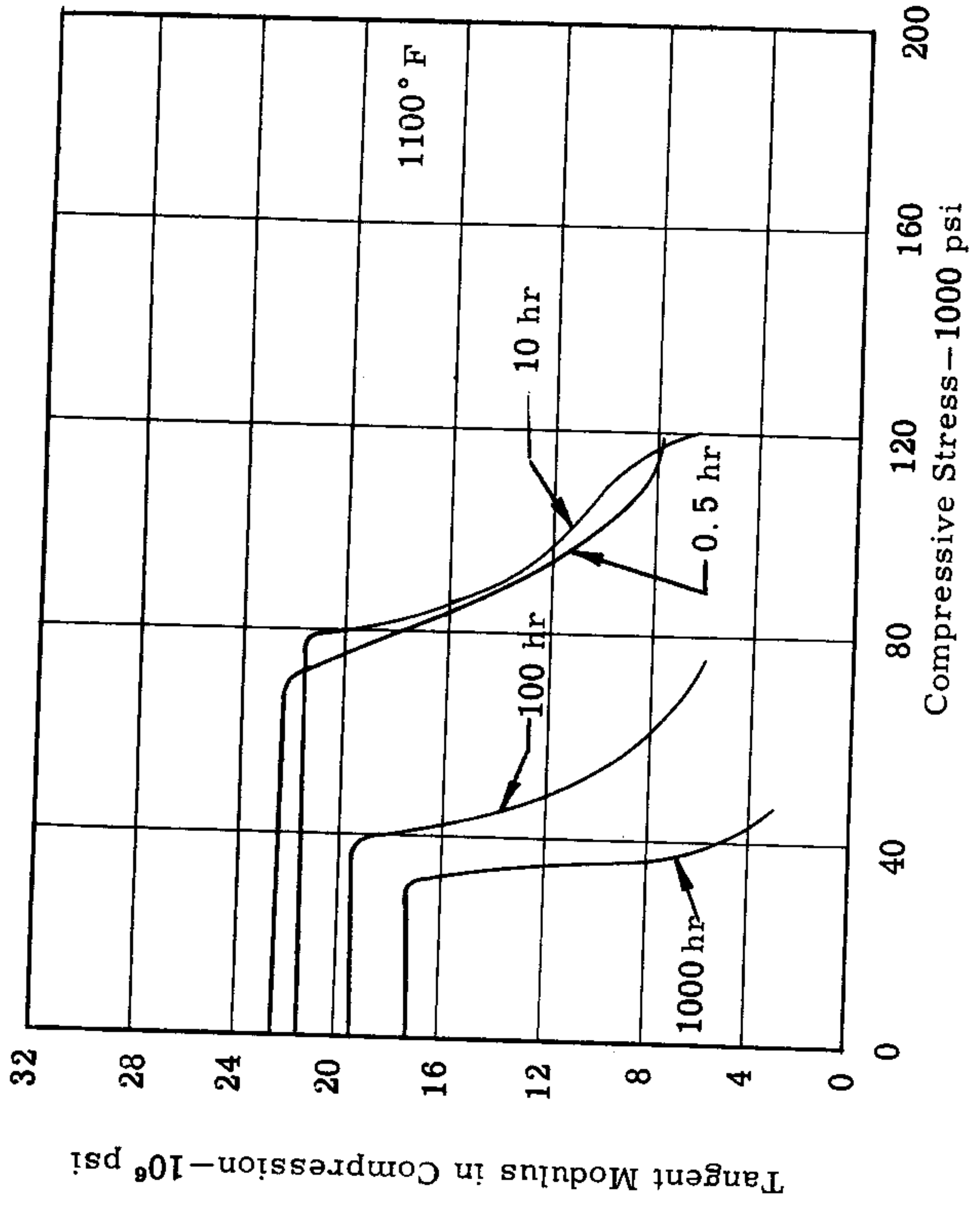

Fig. 78. Tangent modulus vs. compressive-stress curves for quenched and tempered Thermold J alloy steel sheet at 1100° F and different exposure times.

Tensile Properties of 0.062-In. Thermold J Alloy Steel Sheet at Different Temperatures and Holding Times

Temp ° F	Holding Time, hr	YS 1000 psi	UTS 1000 psi	ME 10 ⁶ psi	Elong. %	Hard ¹ R45N	RS ² 1000 psi	RS ³ 1000 psi
RT		195.2	234.0	29.1	6	53	201.0	344.0
		206.0	244.5	28.7	7	52	213.5	325.0
		201.0	246.0	28.4	6	53	216.0	321.0
Avg		200.7	241.5	28.7	6	53	210.2	330.0
600	0.5	174.3	211.0	25.3	5	48	190.8	313.0
		177.2	226.5	24.8	5	50	194.2	287.5
		176.0	216.0	24.0	4	48	195.0	329.0
Avg		175.8	217.8	24.7	5	49	193.3	309.8
600	10	182.2	216.2	25.7	5	47	194.8	313.0
		180.2	217.0	24.4	5	53	205.5	359.0
		179.5	217.0	25.9	5	47	205.0	297.0
Avg		180.6	216.7	25.3	5	49	201.8	323.0
600	100	188.2	217.0	25.1	5	50	194.0	311.5
		179.0	216.5	26.5	5	52	201.5	327.0
		177.0	214.0	26.1	5	50	197.4	285.0
Avg		181.4	216.2	25.9	5	51	197.6	307.8
600	1000	179.0	215.0	26.5	5	50	195.6	299.0
		180.0	214.5	26.7	5	49	201.0	296.0
		181.5	216.0	25.1	5	52	196.6	311.0
Avg		180.2	215.2	26.1	5	50	197.7	302.0

Tensile Properties of 0.062-In. Thermold J Alloy Steel¹ Sheet at Different Temperatures and Holding Times

Temp ° F	Holding Time, hr	YS 1000 psi	UTS 1000 psi	ME 10 ⁶ psi	Elong. %	Hard ¹ R45N	RS ² 1000 psi	RS ³ 1000 psi
800	0.5	174.5	210.0	25.0	8	52	168.0	323.0
		166.5	210.0	23.8	8	51	166.5	278.0
		165.5	206.0	25.6	8	51	171.5	280.0
800	10	168.8	208.7	24.8	8	51	168.7	293.7
		166.0	207.0	30.8	9	50	171.5	312.0
		163.5	204.0	25.2	8	51	169.0	294.0
800	100	—	204.0	29.0	9	54	166.0	208.0
		157.0	194.0	29.5	10	53	157.0	294.0
		157.0	202.5	31.1	8	51	169.0	268.0
800	1000	160.0	198.0	23.1	9	51	165.0	278.0
		159.5	193.0	24.0	9	52	167.5	279.5
		172.5	198.5	25.6	9	52	161.0	270.5
1000	0.5	140.0	162.0	23.2	11	55	124.0	214.5
		134.0	157.5	24.9	11	56	116.5	202.0
		131.0	161.0	—	10	55	123.5	218.0
Avg		135.0	160.2	24.0	11	55	121.3	211.5

WADC TR 58-365 140

Tensile Properties of 0.062-In. Thermold J Alloy Steel Sheet at Different Temperatures and Holding Times

Temp °F	Holding Time, hr	YS 1000 psi	UTS 1000 psi	ME 10 ⁶ psi	Elong. %	Hard ¹ R45N	RS ² 1000 psi	RS ³ 1000 psi
1000	10	128.0	164.0	24.2	15	49	124.0	214.0
	Avg	128.3	164.2	23.9	12	49	127.0	203.3
1000	100	114.8	149.5	27.2	13	49	122.2	205.0
	Avg	125.5	153.9	22.8	13	50	115.0	217.0
1000	1000	93.9	107.5	21.4	14	44	78.8	141.0
	Avg	100.2	110.2	22.4	12	47	84.8	144.4
1100	0.5	105.0	122.0	22.9	16	49	82.5	149.2
	Avg	116.0	123.5	22.9	17	49	79.5	127.5
1100	10	100.5	115.2	20.5	8	51	83.2	145.5
	Avg	114.0	126.0	22.9	17	49	92.6	143.0
144.2		95.4	114.6	21.8	10	52	80.4	144.2
	Avg	91.3	115.5	22.0	9	52	87.4	124.0

141

WADC TR 58-365

1. Hardness determinations made at room temperature after tests.
2. Rupture strength based on original cross section.
3. Rupture strength based on final cross section.
4. Heat treatment - 1850° F 15 min argon atmosphere, A. C., 1000° F 2 hr, 1000° F 2 hr, A. C.

Temp ° F	1100	100	1100	1000	AVG	AVG	1000° F		AVG	
							YS	UTS		ME
	58.3	74.8	23.9	16	49	43.2	102.5	107.0	106.5	105.3
	59.8	75.2	17.8	12	50	44.5	102.5	107.0	106.5	105.3
	59.8	73.0	22.0	11	50	43.7	102.5	107.0	106.5	105.3
	59.3	74.3	21.2	13	50	43.8	102.5	107.0	106.5	105.3
	37.5	43.7	13.8	33	24	7.3	33.5	35.6	36.7	35.3
	37.5	44.5	13.7	35	25	7.8	33.5	35.6	36.7	35.3
	37.5	44.6	12.9	33	24	7.8	33.5	35.6	36.7	35.3
	37.5	44.3	13.5	34	24	7.6	33.5	35.6	36.7	35.3

Table 16 (continued)
Tensile Properties of 0.062-In. Thermoid J Alloy Steel Sheet at Different Temperatures and Holding Times

WADC TR 58-365 142

Tensile Strength of 3/16-In. Thermold J Alloy Steel³ Plate at Different Temperatures and Holding Times

Holding Time, hr	Temp ° F	1/2		10		100		1000	
		UTS ¹ 1000 psi	Hard ² RC	UTS 1000 psi	Hard RC	UTS 1000 psi	Hard RC	UTS 1000 psi	Hard RC
RT									
	Avg								
	600	237.0	50	242.0	50	239.0	50	242.0	50
		238.0	48	243.0	51	242.0	46	244.0	51
		240.0	49	242.0	50	240.0	46	243.0	50
600									
	Avg								
	800	218.0	46	217.5	47	222.0	48	222.2	51
		218.0	48	217.0	48	221.0	49	222.0	50
		-	-	219.0	48	222.0	49	220.0	48
Avg									
	800	218.0	47	217.8	48	221.7	49	221.4	50
		218.0	47	217.8	48	221.7	49	221.4	50
		218.0	47	217.8	48	221.7	49	221.4	50
		218.0	47	217.8	48	221.7	49	221.4	50

Table 17

WADC TR 58-365

143

1. Ultimate tensile strength
 2. Hardness determinations made at room temperature after tests.
 3. Heat treatment - 1850° F 15 min argon atmosphere, A. C., 1000° F 2 hr, 1000° F 2 hr, A. C.

Holding Time, hr	Temp ° F	1000		1100		1300		1500		1700		1850	
		UTS ¹ 1000 psi	Avg RC	UTS ¹ 1000 psi	Avg RC	UTS ¹ 1000 psi	Avg RC	UTS ¹ 1000 psi	Avg RC	UTS ¹ 1000 psi	Avg RC	UTS ¹ 1000 psi	Avg RC
		172.0	49	167.0	50	183.0	49	174.0	49	179.0	49	178.0	49
		174.0	49	174.0	49	174.0	49	174.0	49	174.0	49	174.0	49
		134.9	49	134.9	49	134.9	49	134.9	49	134.9	49	134.9	49
		132.0	46	132.0	46	132.0	46	132.0	46	132.0	46	132.0	46
		130.2	49	130.2	49	130.2	49	130.2	49	130.2	49	130.2	49
		132.4	48	132.4	48	132.4	48	132.4	48	132.4	48	132.4	48
		115.0	47	115.0	47	115.0	47	115.0	47	115.0	47	115.0	47
		114.0	46	114.0	46	114.0	46	114.0	46	114.0	46	114.0	46
		118.7	47	118.7	47	118.7	47	118.7	47	118.7	47	118.7	47
		115.9	47	115.9	47	115.9	47	115.9	47	115.9	47	115.9	47
		164.8	50	164.8	50	164.8	50	164.8	50	164.8	50	164.8	50
		169.0	49	169.0	49	169.0	49	169.0	49	169.0	49	169.0	49
		168.0	49	168.0	49	168.0	49	168.0	49	168.0	49	168.0	49
		167.3	49	167.3	49	167.3	49	167.3	49	167.3	49	167.3	49
		66.0	47	66.0	47	66.0	47	66.0	47	66.0	47	66.0	47
		70.0	46	70.0	46	70.0	46	70.0	46	70.0	46	70.0	46
		67.8	47	67.8	47	67.8	47	67.8	47	67.8	47	67.8	47
		42	42	42	42	42	42	42	42	42	42	42	42
		48.2	42	48.2	42	48.2	42	48.2	42	48.2	42	48.2	42
		48.0	42	48.0	42	48.0	42	48.0	42	48.0	42	48.0	42
		48.1	42	48.1	42	48.1	42	48.1	42	48.1	42	48.1	42

Table 17 (continued)
 Tensile Strength of 3/16-In. Thermold J Alloy Steel³ Plate at
 Different Temperatures and Holding Times

WADC TR 58-365

Compressive Properties of 0.062-In. Thermold J Alloy Steel³ Sheet at Different Temperatures and Holding Times

Hold. Time hr	Temp ° F	1/2		10		100		1000			
		CYS 1000 psi	ME 10 ⁶ psi	Hard ² R45N	CYS 1000 psi	ME 10 ⁶ psi	Hard R45N	CYS 1000 psi	ME 10 ⁶ psi	Hard R45N	
RT	222.2	28.7	48	28.7	48	222.2	48	28.7	48	222.2	48
		30.5	47	30.5	47	217.0	47	30.5	47	217.0	47
Avg	30.8	30.8	46	30.8	46	223.0	46	30.8	46	223.0	46
		30.0	47	30.0	47	220.7	47	30.0	47	220.7	47
600	196.0	28.4	49	28.4	49	196.5	49	28.4	49	196.5	49
		26.5	48	26.5	48	198.5	48	26.5	48	198.5	48
Avg	188.8	28.4	49	28.4	49	201.0	51	28.4	49	201.0	51
		27.8	49	27.8	49	198.7	50	27.8	49	198.7	50
800	182.5	25.8	50	25.8	50	187.0	47	25.8	50	187.0	47
		26.2	49	26.2	49	176.2	48	26.2	49	176.2	48
Avg	180.3	26.2	49	26.2	49	176.5	48	26.2	49	176.5	48
		24.9	49	24.9	49	179.9	48	24.9	49	179.9	48
1000	141.2	18.4	48	18.4	48	138.0	49	18.4	48	138.0	49
		23.2	48	23.2	48	134.0	49	23.2	48	134.0	49
Avg	132.0	21.5	48	21.5	48	142.0	49	21.5	48	142.0	49
		21.0	48	21.0	48	138.0	49	21.0	48	138.0	49

WADC TR 58-365

145

Compressive Properties of 0.062-In. Thermold J Alloy Steel³ Sheet at Different Temperatures and Holding Times

Hold. Time hr	Temp ° F	1/2		10		100		1000																				
		CYS 1000 psi	ME 10 ⁶ psi	Hard ² R45N	CYS 1000 psi	ME 10 ⁶ psi	Hard R45N	CYS 1000 psi	ME 10 ⁶ psi	Hard R45N																		
RT	Avg	196.0	28.4	49	196.5	26.6	49	196.5	29.1	49	198.0	27.9	49	198.0	27.9	49	195.5	28.7	50	198.0	27.4	49	197.2	28.0	49			
		188.5	26.5	48	202.0	27.5	51	198.5	27.5	50	198.0	27.9	49	198.0	27.9	49	198.0	27.9	49	198.0	27.4	49	198.0	27.4	49	198.0	27.4	49
600	Avg	182.5	25.8	50	191.0	29.4	47	187.0	24.1	50	183.2	25.2	50	182.5	25.8	50	183.2	25.2	50	183.2	25.2	50	183.2	25.2	50	183.2	25.2	50
		180.3	26.2	49	183.4	23.6	48	176.2	26.6	48	184.5	27.1	49	180.3	26.2	49	184.5	27.1	49	184.5	27.1	49	184.5	27.1	49	184.5	27.1	49
800	Avg	178.8	24.9	49	182.2	25.6	48	176.5	23.9	46	183.8	29.9	49	178.8	24.9	49	183.8	29.9	49	183.8	29.9	49	183.8	29.9	49	183.8	29.9	49
		180.5	25.6	49	185.5	26.2	48	179.9	24.9	48	183.8	27.4	49	180.5	25.6	49	183.8	27.4	49	183.8	27.4	49	183.8	27.4	49	183.8	27.4	49
1000	Avg	141.2	18.4	48	138.0	24.2	49	138.0	24.9	49	101.0	23.3	46	141.2	18.4	48	138.0	24.2	49	101.0	23.3	46	141.2	18.4	48	141.2	18.4	48
		142.2	23.2	48	146.0	22.5	49	134.0	23.7	47	104.5	17.1	47	142.2	23.2	48	146.0	22.5	49	104.5	17.1	47	142.2	23.2	48	142.2	23.2	48
Avg	Avg	138.5	21.0	48	143.7	24.1	49	138.0	23.2	48	101.8	22.3	47	138.5	21.0	48	143.7	24.1	49	101.8	22.3	47	138.5	21.0	48	138.5	21.0	48
		132.0	21.5	48	147.0	25.7	49	142.0	21.1	48	100.0	26.5	47	132.0	21.5	48	147.0	25.7	49	100.0	26.5	47	132.0	21.5	48	132.0	21.5	48

WADC TR 58-365

145

Table 18 (continued)

Compressive Properties of 0.062-In. Thermold J Alloy Steel Sheet at Different Temperatures and Holding Times

Hold. Time	Temp °F	1000	Avg
1/2	CYS ¹	120.8	120.3
	10 ⁶ ME	22.4	23.1
10	Hard ²	48	48
	1000 psi	120.0	117.0
100	ME	21.6	21.4
	10 ⁶ Hard	49	47
1000	CYS	107.0	107.0
	1000 psi	22.0	20.7
1000	ME	71.5	69.3
	10 ⁶ Hard	45	47
1000	CYS	20.4	19.6
	1000 psi	39	40
1000	ME	46.5	42.7
	10 ⁶ Hard	39	39
1000	CYS	17.4	17.6
	1000 psi	22.9	22.9
1000	ME	19.3	19.3
	10 ⁶ Hard	20	21

1. Compressive yield strength.
 2. Hardness determinations made at room temperature after tests.
 3. Heat treatment - 1850 ° F 15 min. argon atmosphere, A. C., 1000° F 2 hr, 1000° F 2 hr, A. C.

Table 19
 Shear Strength of 3/16-In. Thermoid J Alloy Steels Plate at
 Different Temperatures and Holding Times

Holding Time, hr	Temp ° F	1/2		10		100		1000	
		USS ¹ 1000 psi	Hard ² RC	USS 1000 psi	Hard RC	USS 1000 psi	Hard RC	USS 1000 psi	Hard RC
RT	Avg								
	45	142.5	45	142.5	45	155.0	45	155.0	45
600	Avg								
	45	142.0	51	138.0	53	140.0	48	133.5	45
600	130.0	45	135.5	33	135.0	46	142.2	50	
	137.5	47	136.5	42	127.5	46	133.6	47	
600	Avg								
	48	136.5	48	136.7	43	134.2	47	136.4	47
800	140.0	53	126.0	39	133.0	49	129.0	49	
	128.0	51	124.0	45	135.0	52	132.0	51	
800	Avg								
	52	138.0	52	127.0	39	131.0	52	128.5	50
800	135.3	52	125.7	41	133.0	51	129.8	50	
	113.0	50	111.0	45	110.0	46	83.3	36	
1000	116.0	44	113.0	45	110.0	46	77.3	37	
	111.5	50	111.5	45	-	-	80.0	36	
1000	Avg								
	48	113.5	48	111.8	45	110.0	46	80.2	36

WADC TR 58-365 147

Table 19 (continued)
 Shear Strength of 3/16-In. Thermoid J Alloy Steel's Plate at
 Different Temperatures and Holding Times

Holding Time, hr	Temp ° F	1/2		10		100		1000	
		USS ¹ 1000 psi	Hard ² RC	USS 1000 psi	Hard RC	USS 1000 psi	Hard RC	USS 1000 psi	Hard RC
	1100	89.2	42	84.7	40	53.5	35	31.5	19
		77.8	40	86.8	43	53.3	34	33.0	18
		80.4	41	86.2	43	49.5	35	32.2	18
	Avg	82.5	41	85.9	42	52.1	35	32.2	18

1. Ultimate shear strength.
2. Hardness determinations made at room temperature after tests.
3. Heat treatment -1850° F 15 min argon atmosphere, A. C., 1000° F 2 hr, 1000° F 2 hr, A. C.

Bearing Properties^a of 0.062-In. Thermold J Alloy Steel^b Sheet at Different Temperatures and Holding Times

Table 20

Hold. Time hr	Temp ° F	1/2			10			100			1000		
		BYS ¹ UBS ²	Hards R45N	1000 psi	BYS ¹ UBS ²	Hards R45N	1000 psi	BYS ¹ UBS ²	Hards R45N	1000 psi	BYS ¹ UBS ²	Hards R45N	1000 psi
RT	Avg	285.0	318.0	253.0	321.0	268.0	312.0	264.0	303.0	290.0	352.0	48	49
		285.0	324.0	265.0	314.0	263.5	310.0	246.0	306.0	238.0	320.0	49	49
600	Avg	282.0	318.0	257.0	321.0	275.0	310.0	271.0	316.0	270.0	336.0	49	49
		285.0	324.0	265.0	314.0	263.5	310.0	246.0	306.0	238.0	320.0	49	49
800	Avg	247.0	293.0	248.0	300.0	251.5	295.0	269.0	300.0	290.0	352.0	48	49
		269.5	292.0	254.5	296.0	251.0	295.0	235.0	278.0	266.0	336.0	49	49
1000	Avg	212.0	247.0	209.0	237.2	211.0	232.5	134.8	169.8	176.0	352.0	44	44
		203.0	241.0	195.5	233.0	211.0	228.5	134.8	172.6	172.8	352.0	43	44
Avg	Avg	207.5	242.0	203.5	237.6	210.0	229.3	134.4	172.8	172.8	352.0	44	44
		203.0	241.0	195.5	233.0	211.0	228.5	134.8	172.6	172.8	352.0	43	44

WADC TR 58-365

1. Bearing yield strength.
2. Ultimate bearing strength.
3. Hardness determinations made at room temperature after tests.
4. Edge-distance to hole-diameter ratio 1.5
5. Heat treatment—1850° F 15 min argon atmosphere, A. C, 1000° F 2 hr, 1000° F 2 hr, A. C.

Hold. Time hr	Temp ° F	1/2		10		100		1000	
		BYS ¹	UBS ²	BYS	UBS	BYS	UBS	BYS	UBS
1100	168.4	185.0	47	155.0	162.5	44	97.5	109.5	40
		169.0	47	—	—	—	88.0	94.0	40
Avg	165.0	185.0	47	—	—	—	88.3	96.0	40
		157.8	47	155.0	162.5	44	91.3	99.8	40
1000	61.3	65.2	21	61.3	65.2	21	57.6	63.0	21
		59.4	—	—	—	—	—	—	—
1000	64.1	64.1	21	64.1	64.1	21	—	—	—
		—	—	—	—	—	—	—	—

Bearing Properties of 0.062-In. Thermold J Alloy Steel Sheet at Different Temperatures and Holding Times

Table 20 (continued)

WADC TR 58-365 150

Bearing Properties* of 0.062-In. Thermoid J Alloy Steel Sheet at Different Temperatures and Holding Times

Hold. Time	Temp °F	1/2			10			100			1000		
		BYS ¹	UBS ²	Hard ³	BYS	UBS	Hard	BYS	UBS	Hard	BYS	UBS	Hard
RT	-												
49	492.0												
49	465.0												
49	492.0												
49	447.0												
49	474.0												
Avg													
600	358.0	428.0	429.0	45	323.0	429.0	53	430.0	430.0	49	305.0	426.0	52
	311.0	429.0	45	318.0	436.0	51	324.0	430.0	49	346.0	442.0	50	
	323.0	444.0	47	314.5	442.5	52	312.0	430.0	49	306.0	417.0	52	
Avg	330.3	433.7	46	318.5	435.8	52	322.0	430.0	49	319.0	428.3	51	
800	293.0	393.0	50	288.0	396.0	48	294.0	388.0	50	291.0	396.0	53	
	291.0	388.2	53	295.5	394.0	50	341.0	401.0	51	268.0	380.0	54	
	305.0	390.0	52	292.5	398.0	48	310.0	402.5	49	322.0	381.0	52	
Avg	296.3	390.4	52	292.0	396.0	49	315.0	397.2	50	293.7	385.7	53	
1000	240.0	317.5	52	247.0	312.0	49	206.0	290.0	51	147.0	217.5	43	
	211.0	312.0	51	241.0	312.0	51	213.5	282.0	51	133.5	212.0	43	
	243.0	314.0	52	228.0	301.0	50	209.0	288.0	50	153.0	212.0	43	
Avg	231.3	314.5	52	238.7	308.3	50	209.5	286.7	51	144.5	213.8	43	

WADC TR 58-365

151

Bearing Properties¹ of 0.062-In. Thermold J Alloy Steel² Sheet at Different Temperatures and Holding Times

Hold. Time	hr	Temp °F	1/2		10		100		1000				
			BYS ¹	UBS ²	Hard ³	R45N	BYS	UBS	Hard	R45N	BYS	UBS	Hard
1100			166.4	194.0	42	191.0	215.0	99.0	132.0	37	73.7	90.3	19
			174.0	202.5	41	169.0	212.0	104.3	130.5	39	75.5	92.6	20
			—	—	—	172.2	217.0	117.8	137.8	38	73.6	89.4	19
Avg			170.2	198.2	42	177.4	214.7	107.0	133.4	38	74.3	90.8	19

1. Bearing yield strength.
2. Ultimate bearing strength.
3. Hardness determinations made at room temperature after tests.
4. Edge-distance to hole-diameter ratio 2.0.
5. Heat treatment - 1850° F 15 min argon atmosphere, A. C., 1000° F 2 hr, 1000° F 2 hr, A. C.

WADC TR 58-365 152

10.4 Type 420 Stainless Steel Sheet, Quenched and Tempered

WADC TR 58-365

153

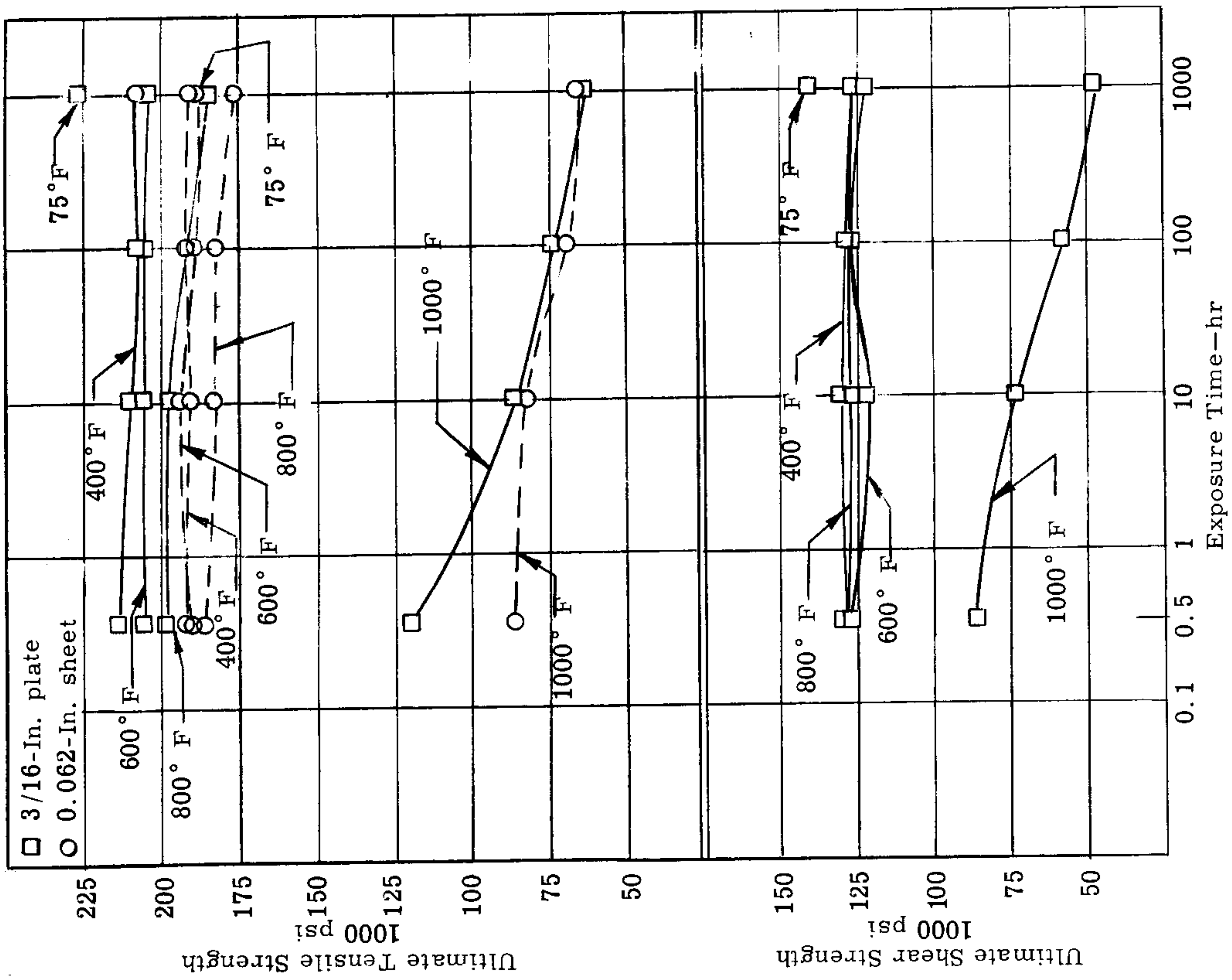

Fig. 79. Effect of exposure time on the ultimate tensile strength and ultimate shear strength of quenched and tempered Type 420 stainless steel at different temperatures.

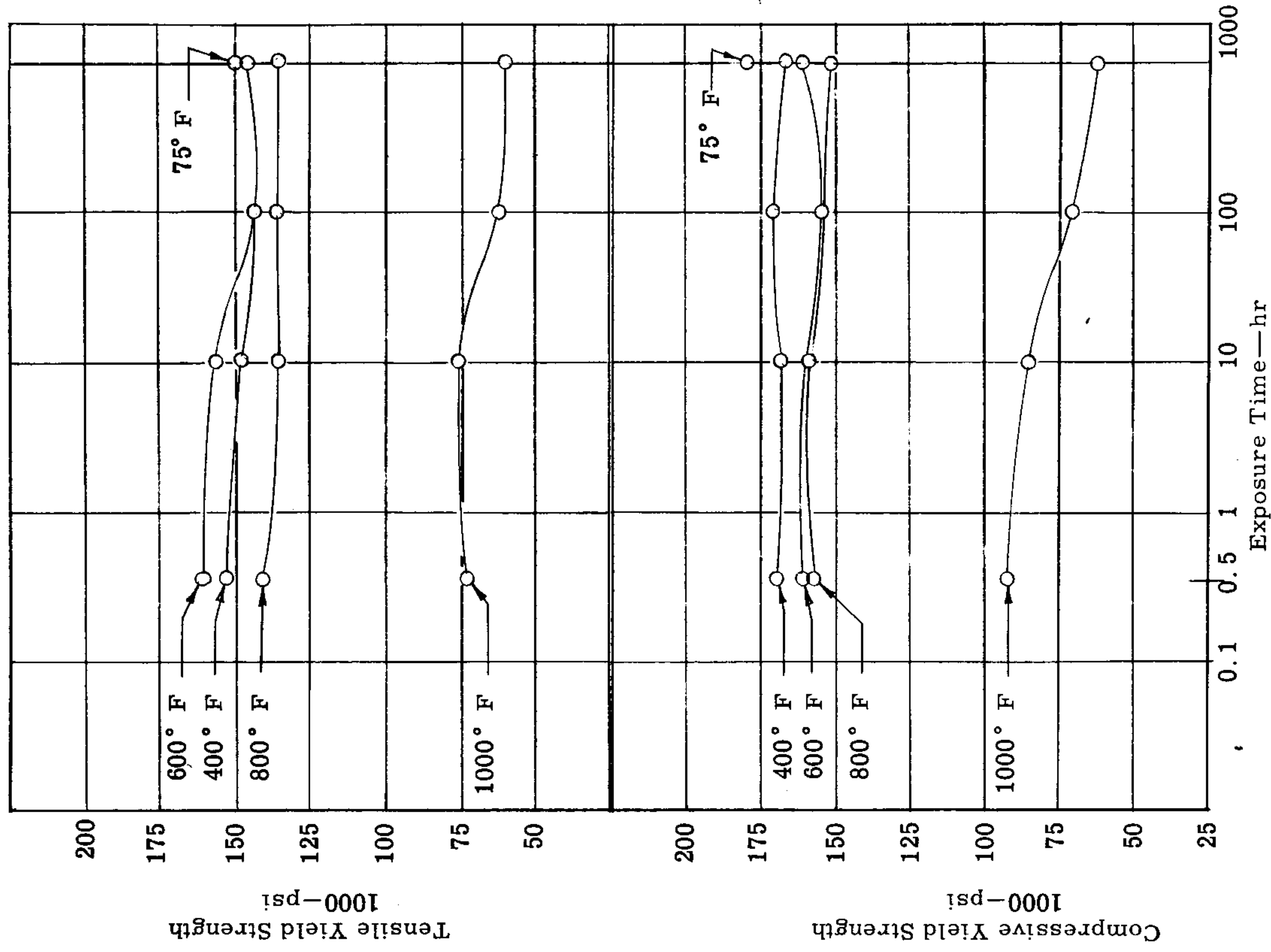

Fig. 80. Effect of exposure time on the tensile and compressive yield strength of quenched and tempered Type 420 stainless steel sheet at different temperatures

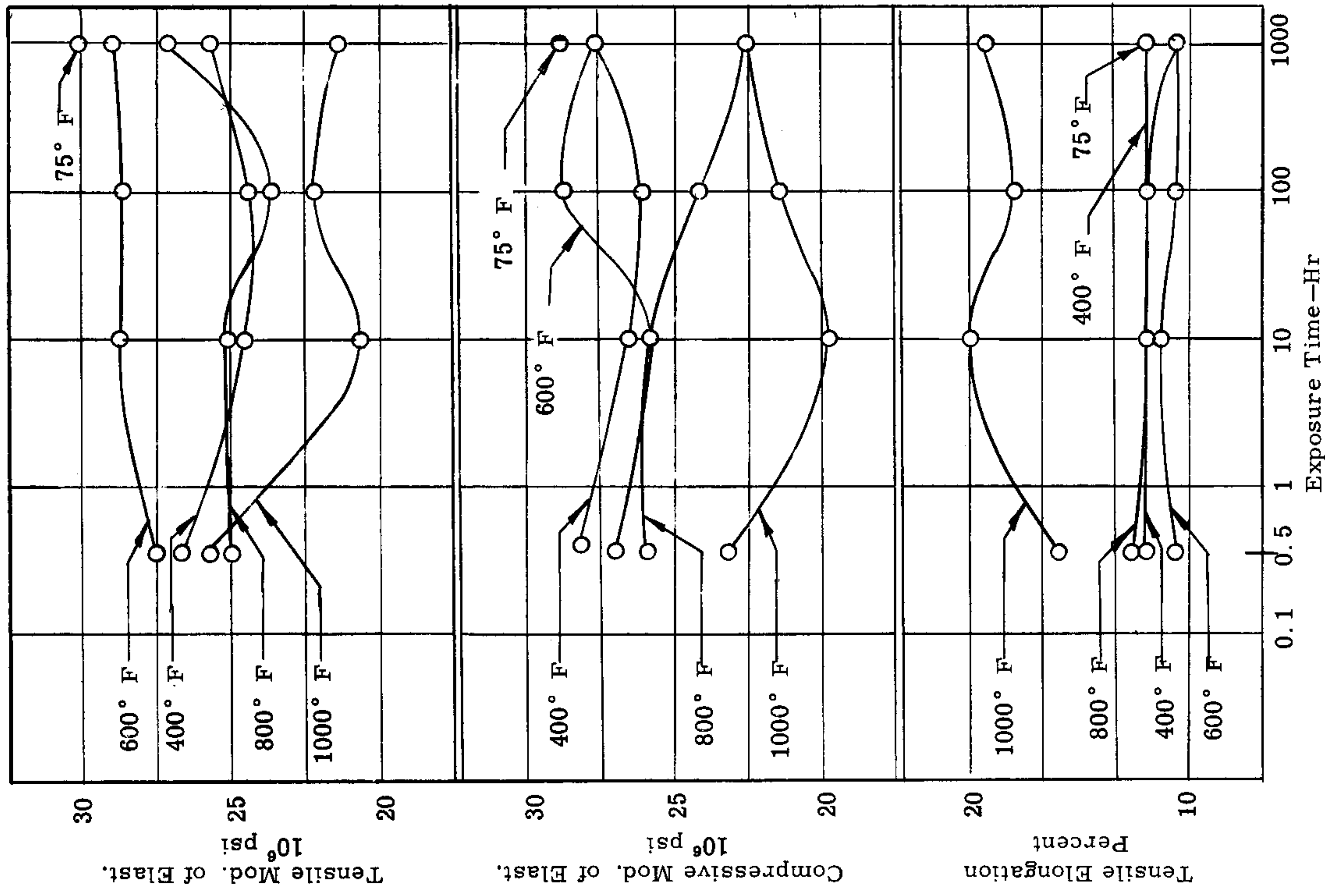

Fig. 81. Effect of exposure time on the tensile and compressive moduli of elasticity and percent elongation of quenched and tempered Type 420 stainless steel sheet at different temperatures.

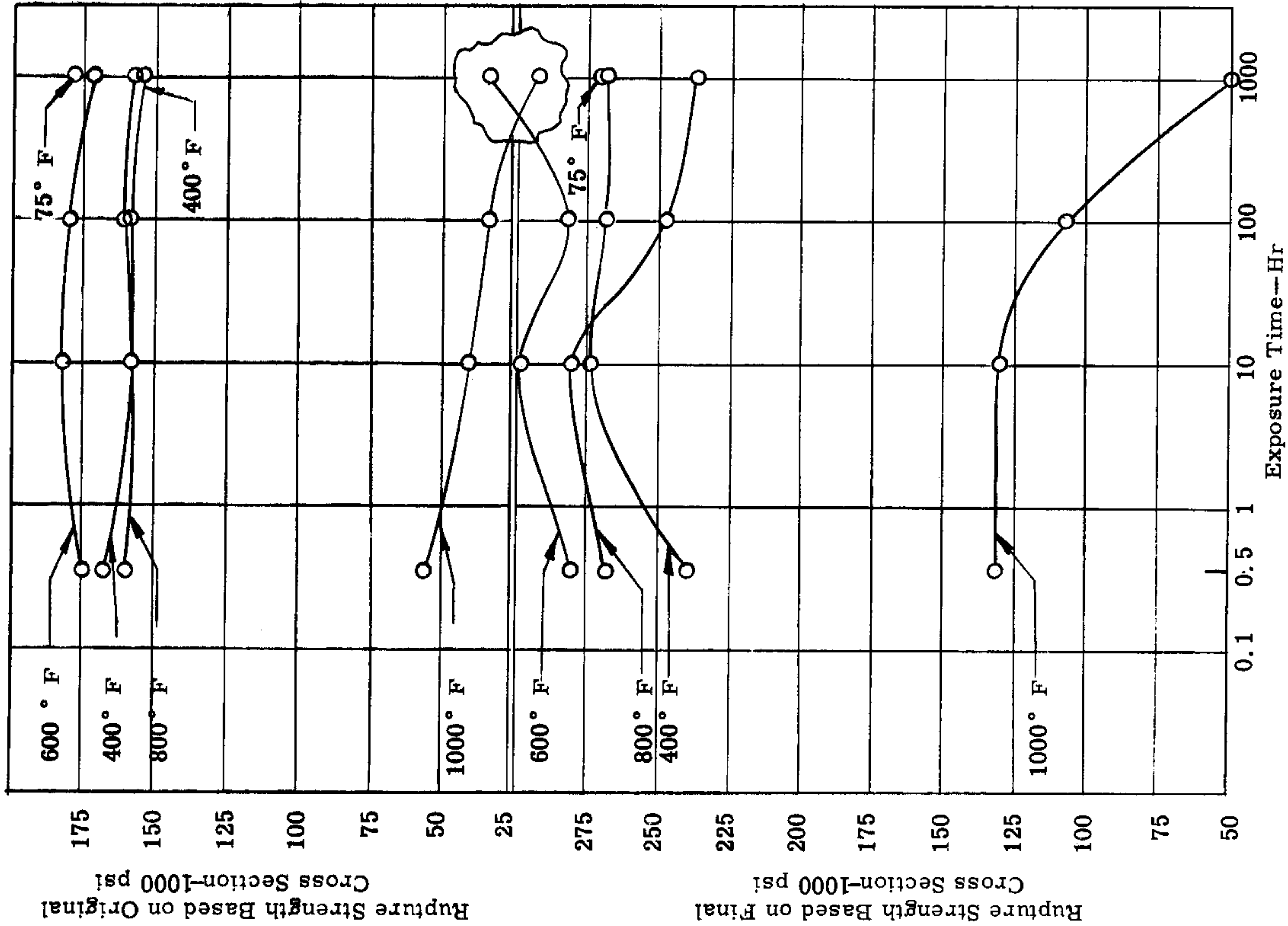

Fig. 82. Effect of exposure time on the tensile rupture strength of quenched and tempered Type 420 stainless steel sheet at different temperatures.

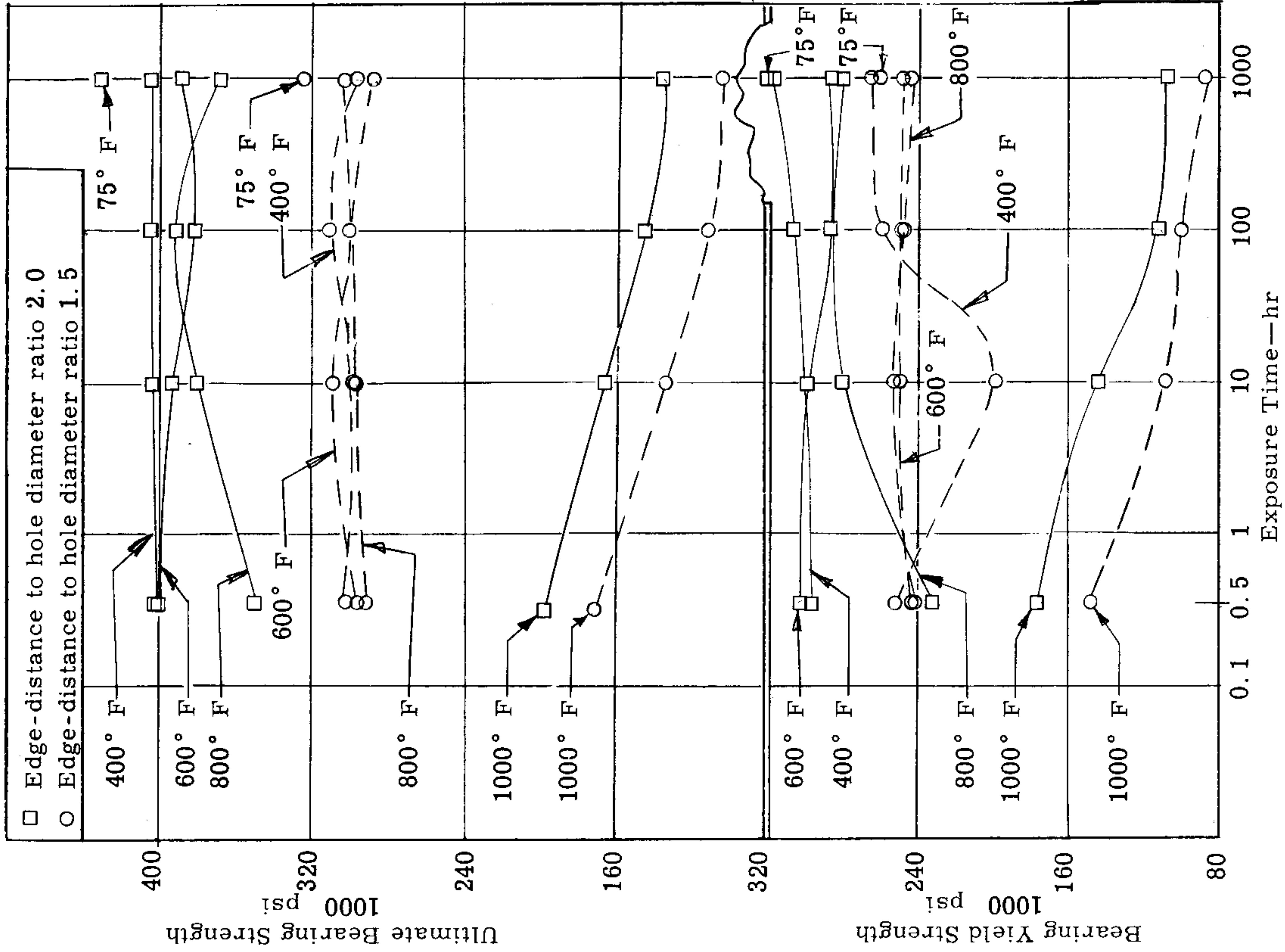

Fig. 83. Effect of exposure time on the bearing ultimate and yield strengths of quenched and tempered Type 420 stainless steel sheet at different temperatures

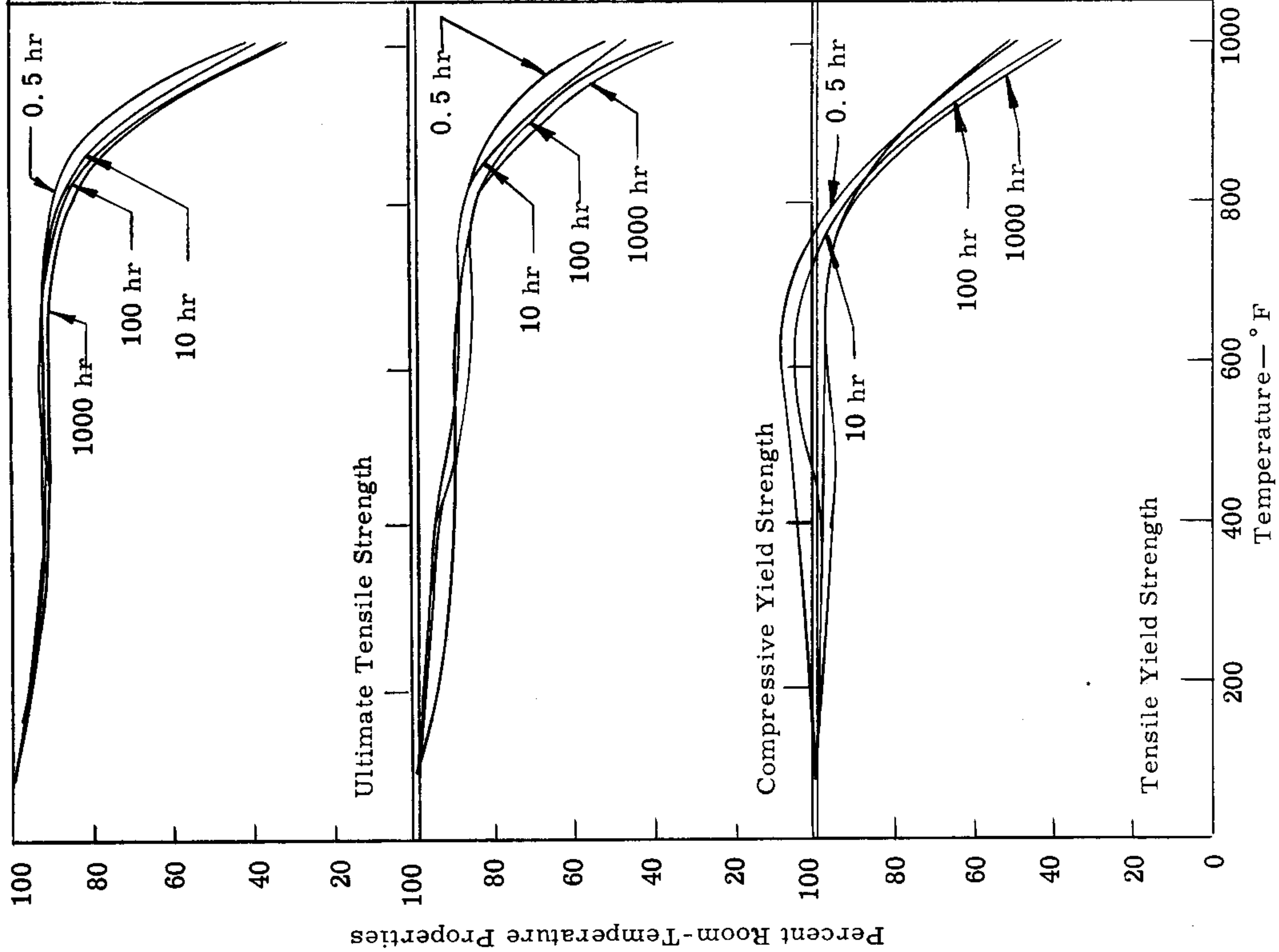

Fig. 84. Elevated-temperature strength properties as percent room-temperature properties for quenched and tempered Type 420 stainless steel sheet at different exposure times.

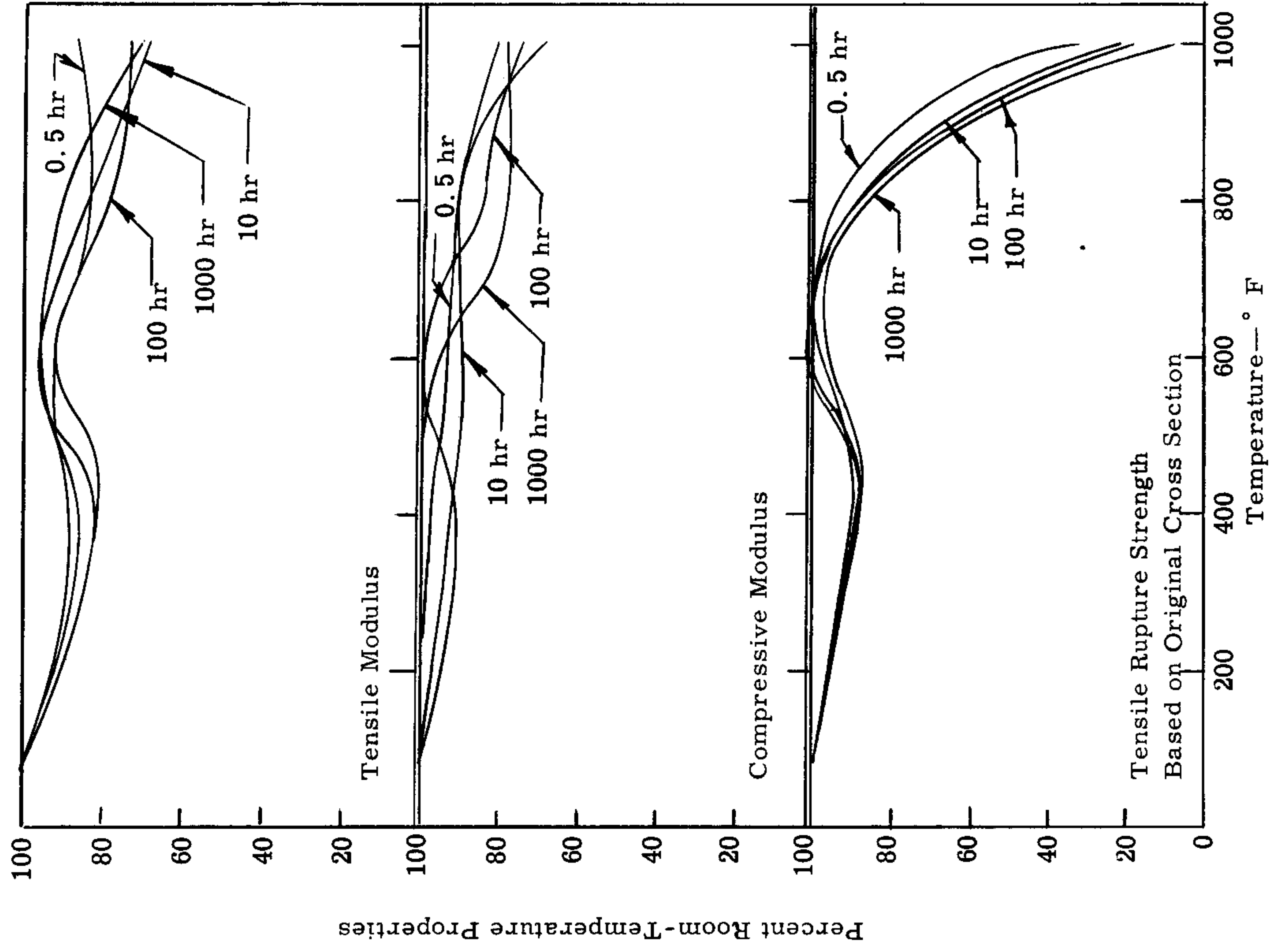

Fig. 85. Elevated-temperature properties as percent room-temperature properties for quenched and tempered Type 420 stainless steel sheet at different exposure times.

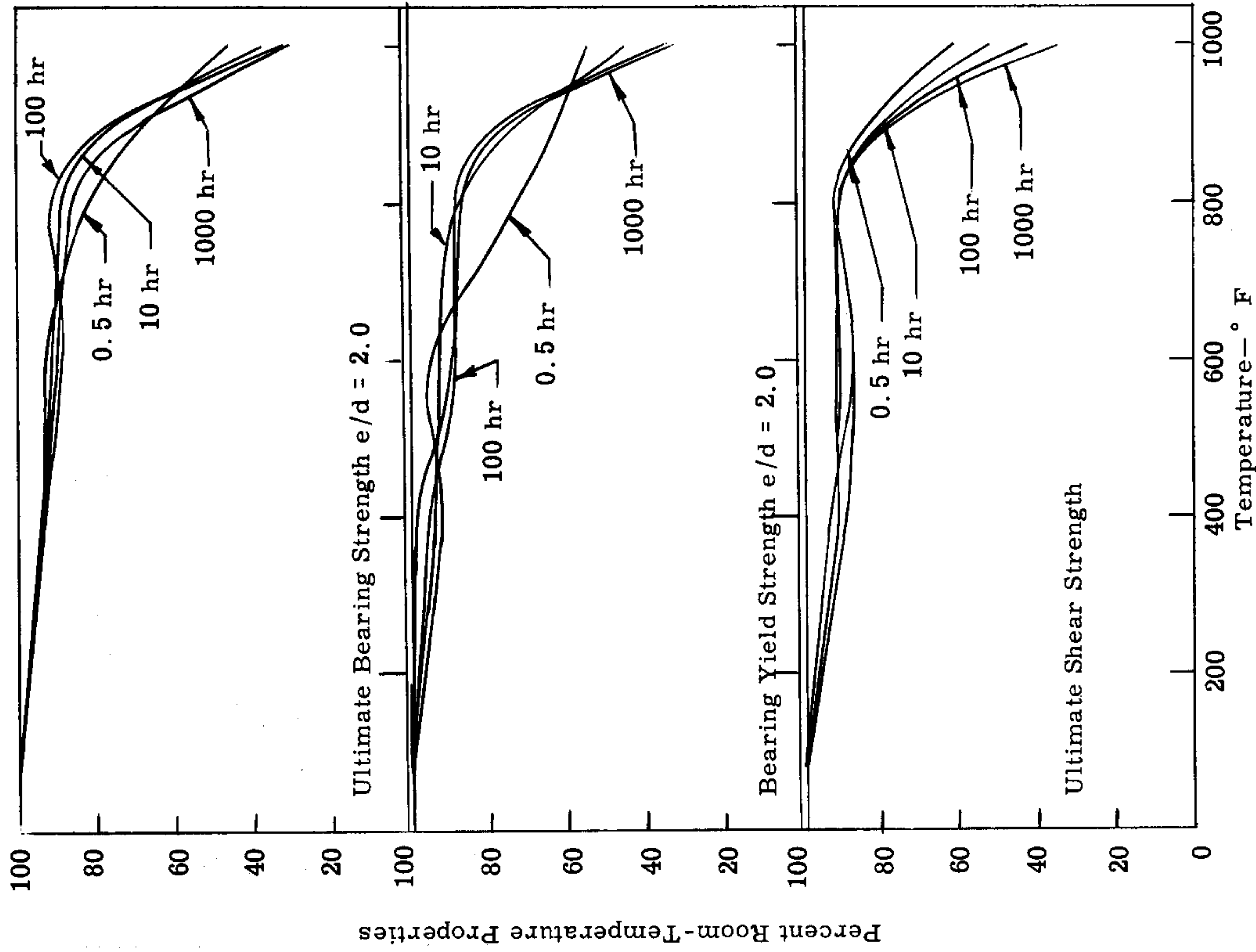

Fig. 86. Elevated-temperature strength properties as percent room-temperature properties for quenched and tempered Type 420 stainless steel sheet at different exposure times.

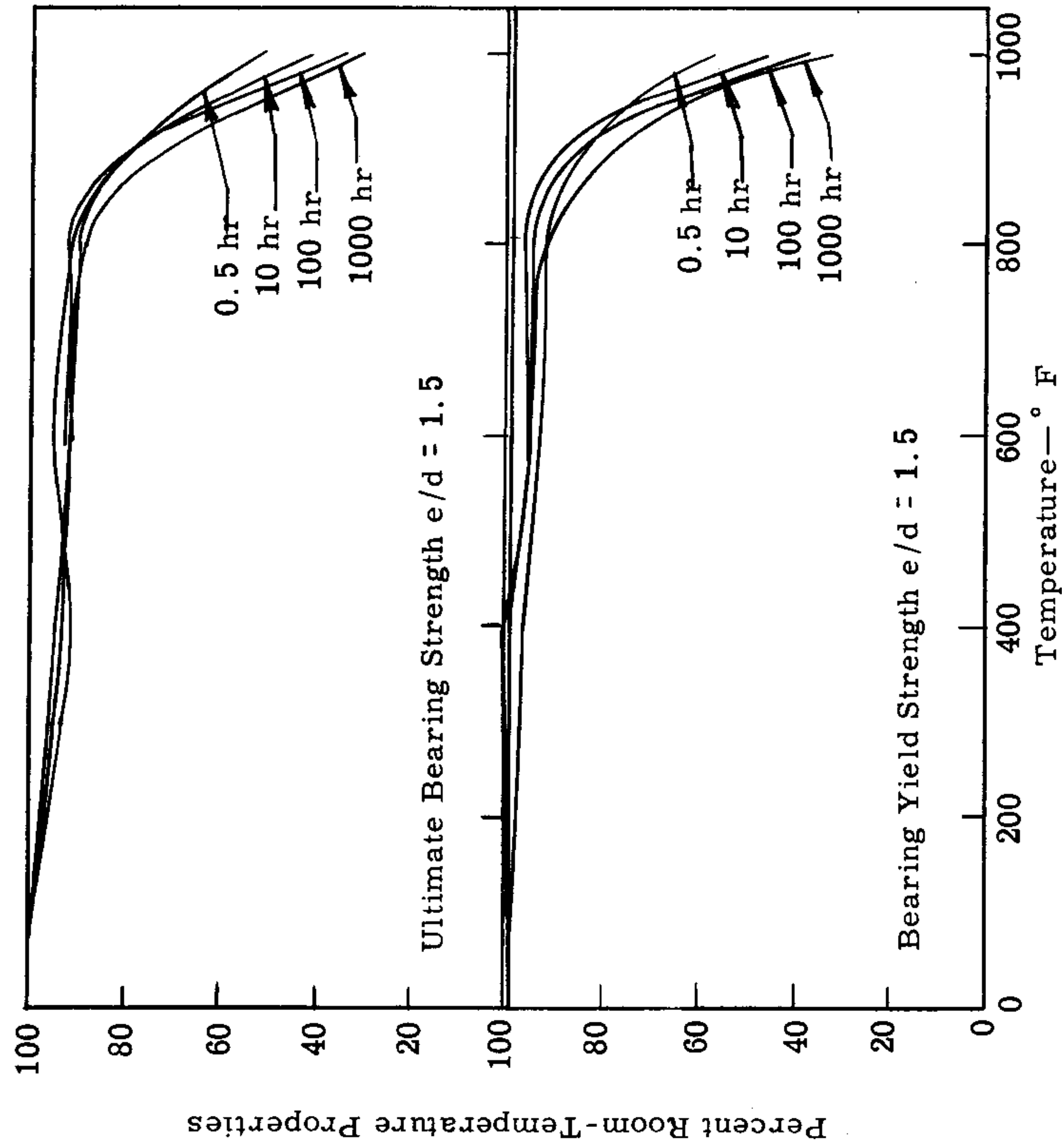

Fig. 87. Elevated-temperature strength properties as percent room-temperature properties for quenched and tempered Type 420 stainless steel sheet at different exposure times.

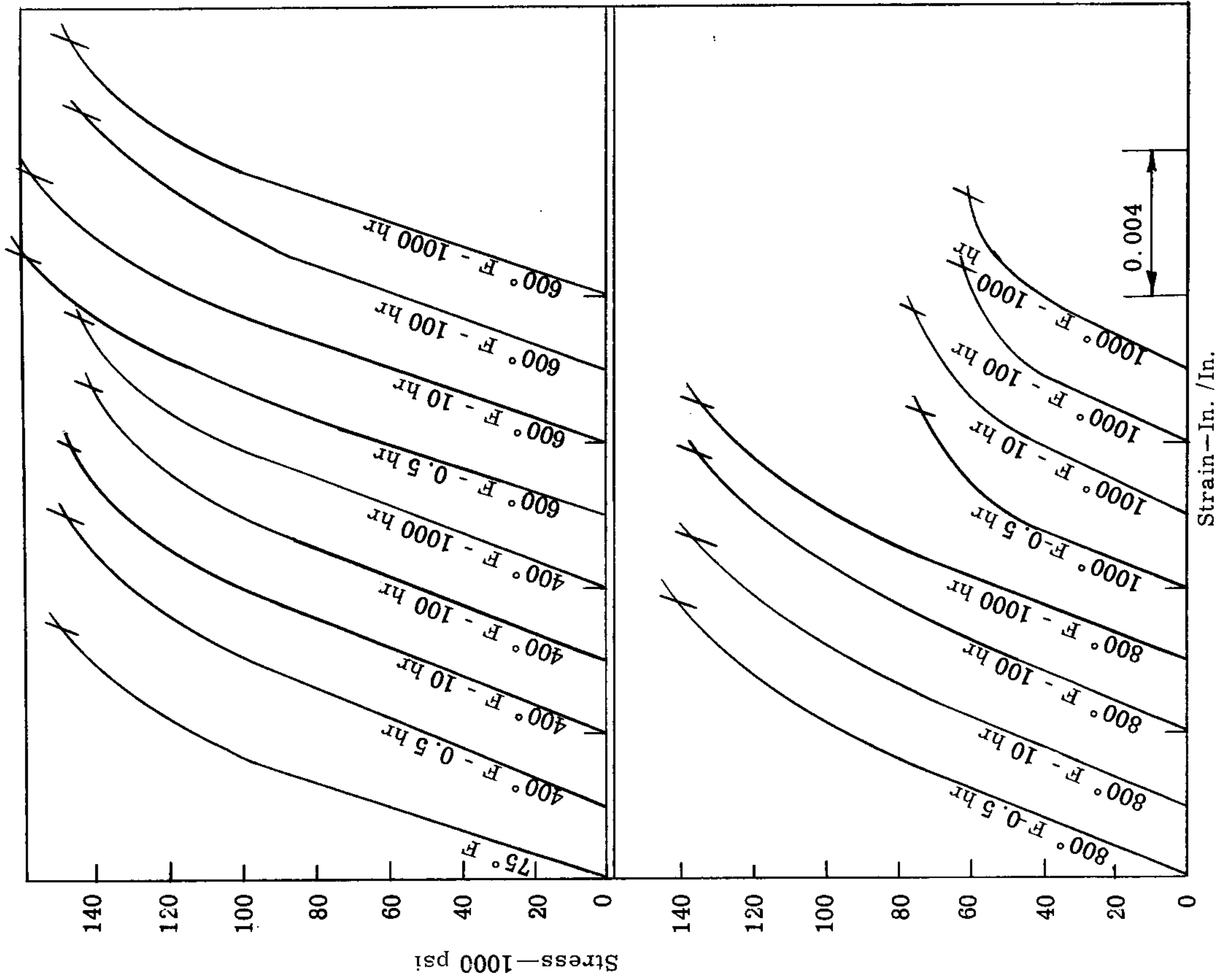

Fig. 88. Tensile stress-strain curves for quenched and tempered Type 420 stainless steel sheet at various temperatures and exposure times.

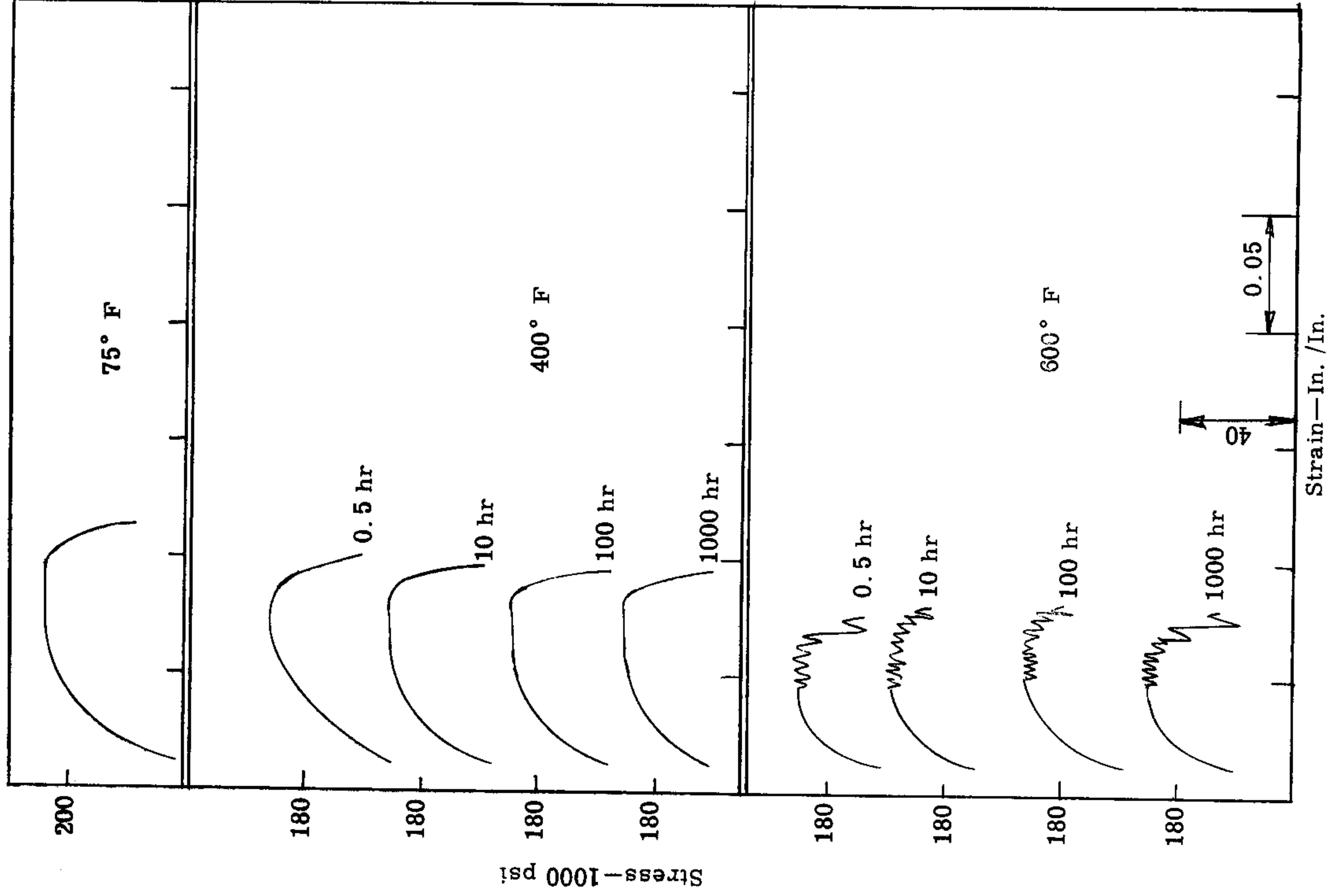

Fig. 89. Tensile postyield stress-strain curves for quenched and tempered Type 420 stainless steel sheet at various temperatures and exposure times

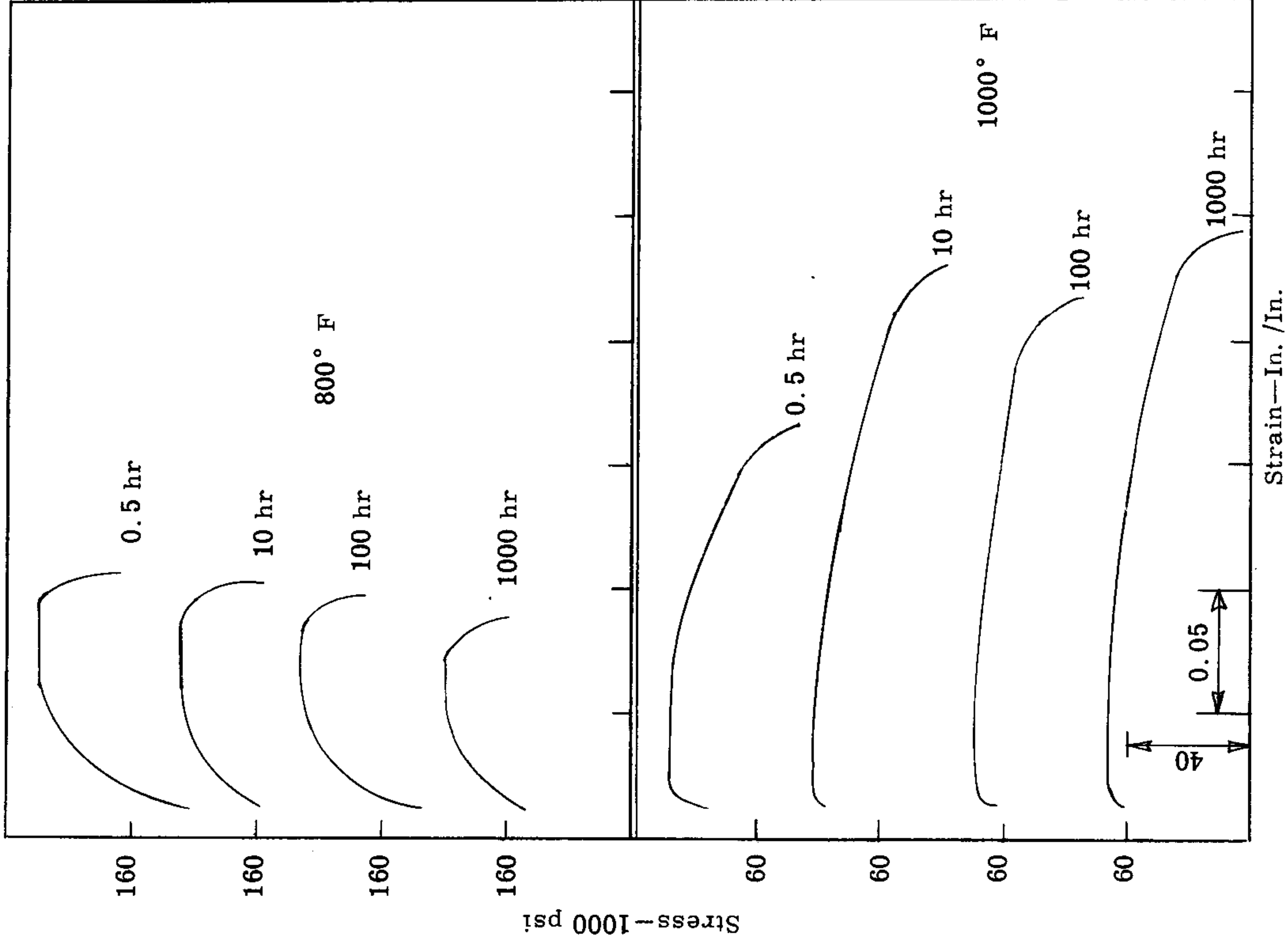

Fig. 90. Tensile postyield stress-strain curves for quenched and tempered Type 420 stainless-steel sheet at various temperatures and exposure times.

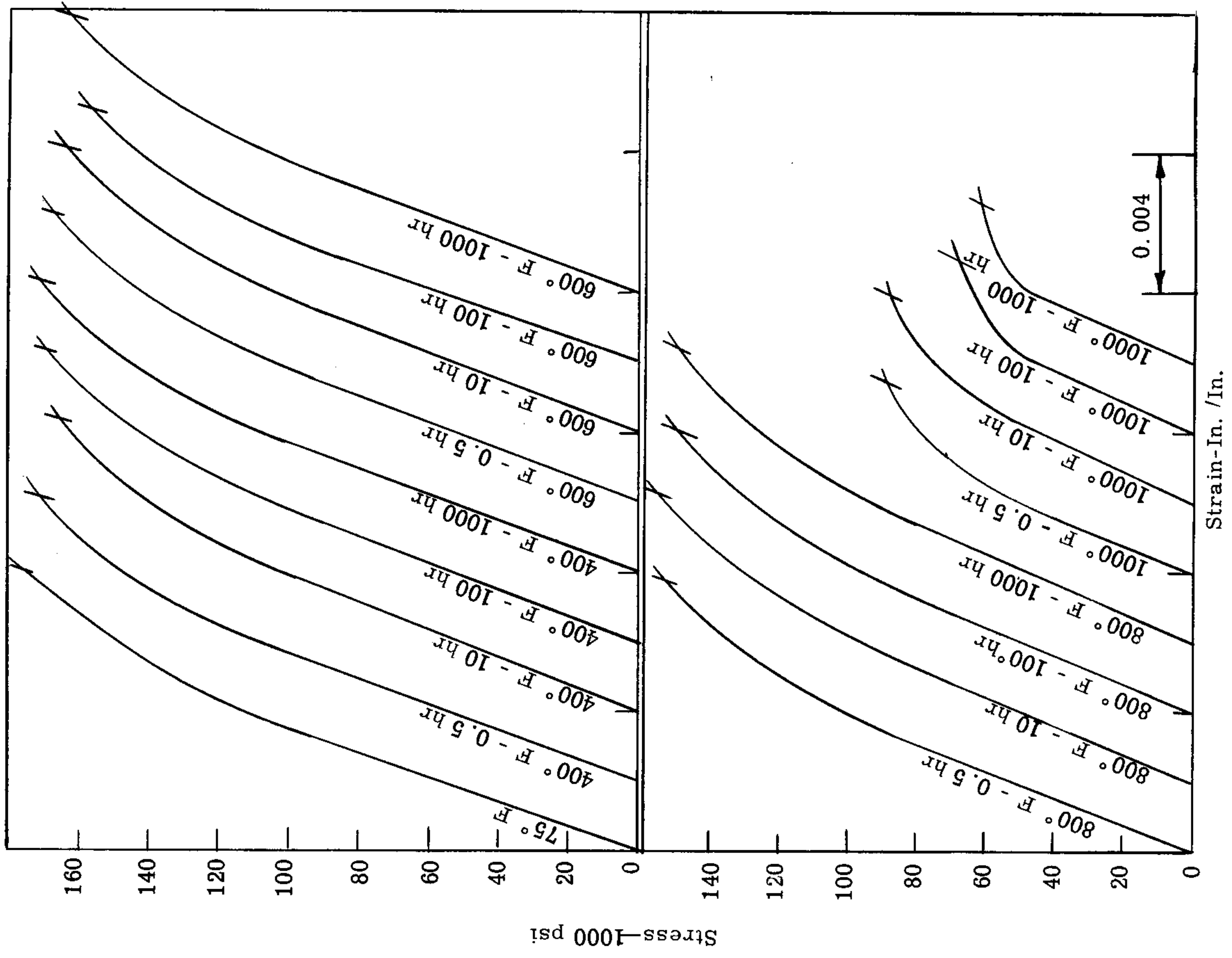

Fig. 91. Compressive stress-strain curves for quenched and tempered Type 420 stainless steel sheet at various temperatures and exposure times.

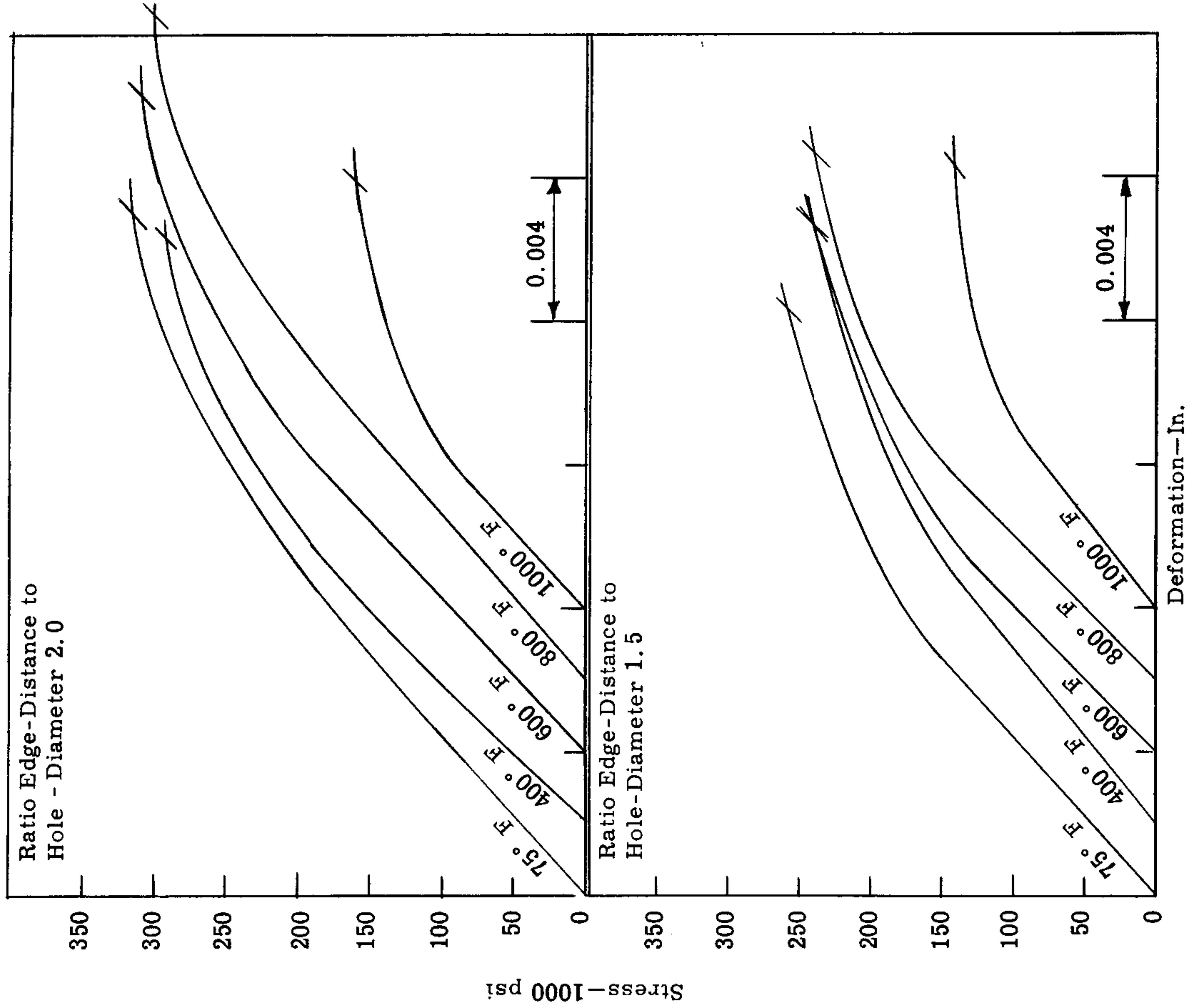

Fig. 92. Bearing stress-deformation curves for quenched and tempered Type 420 stainless steel sheet at various temperatures and one-half-hour exposure time.

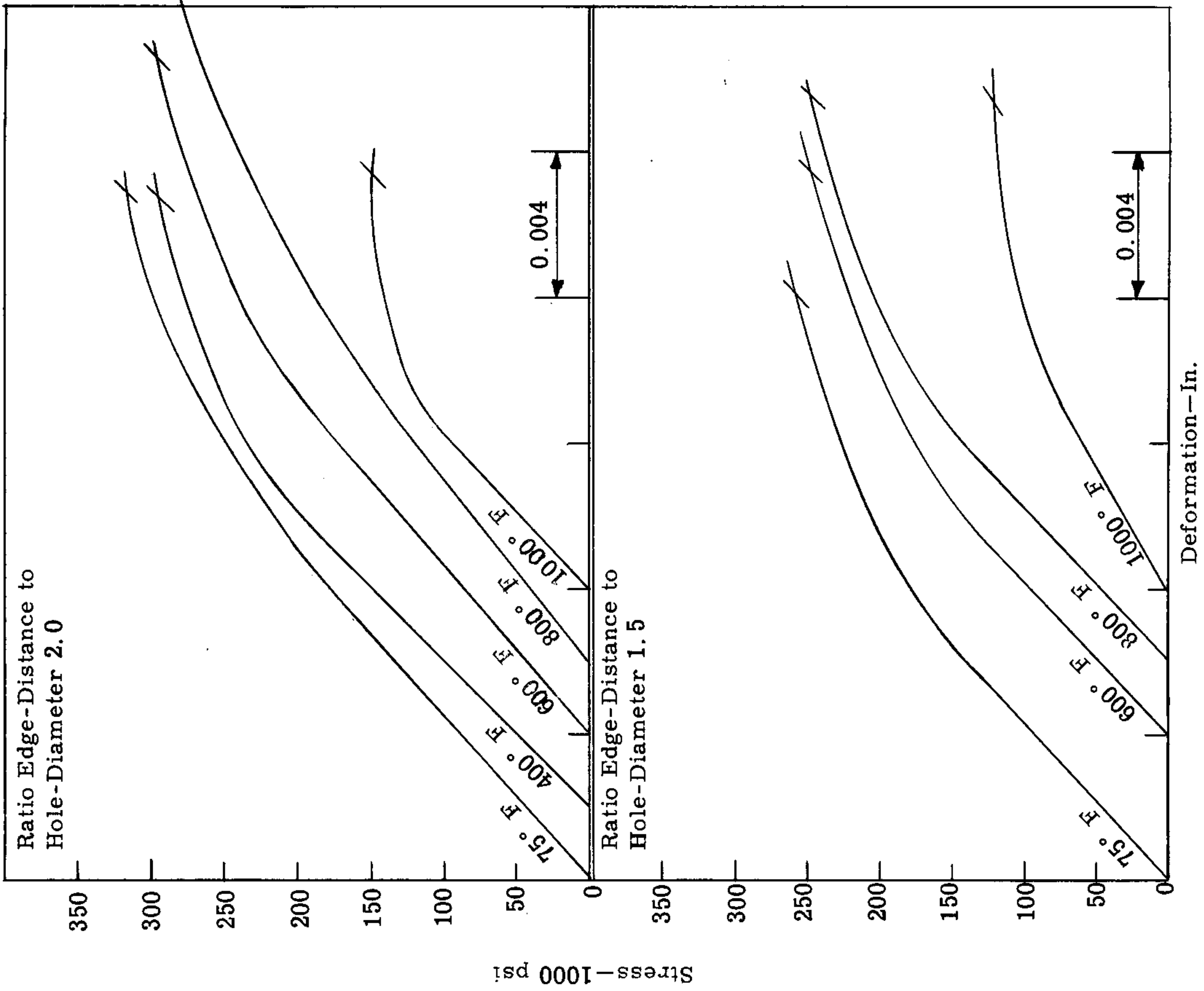

Fig. 93. Bearing stress-deformation curves for quenched and tempered Type 420 stainless steel sheet at various temperatures and ten-hour exposure time.

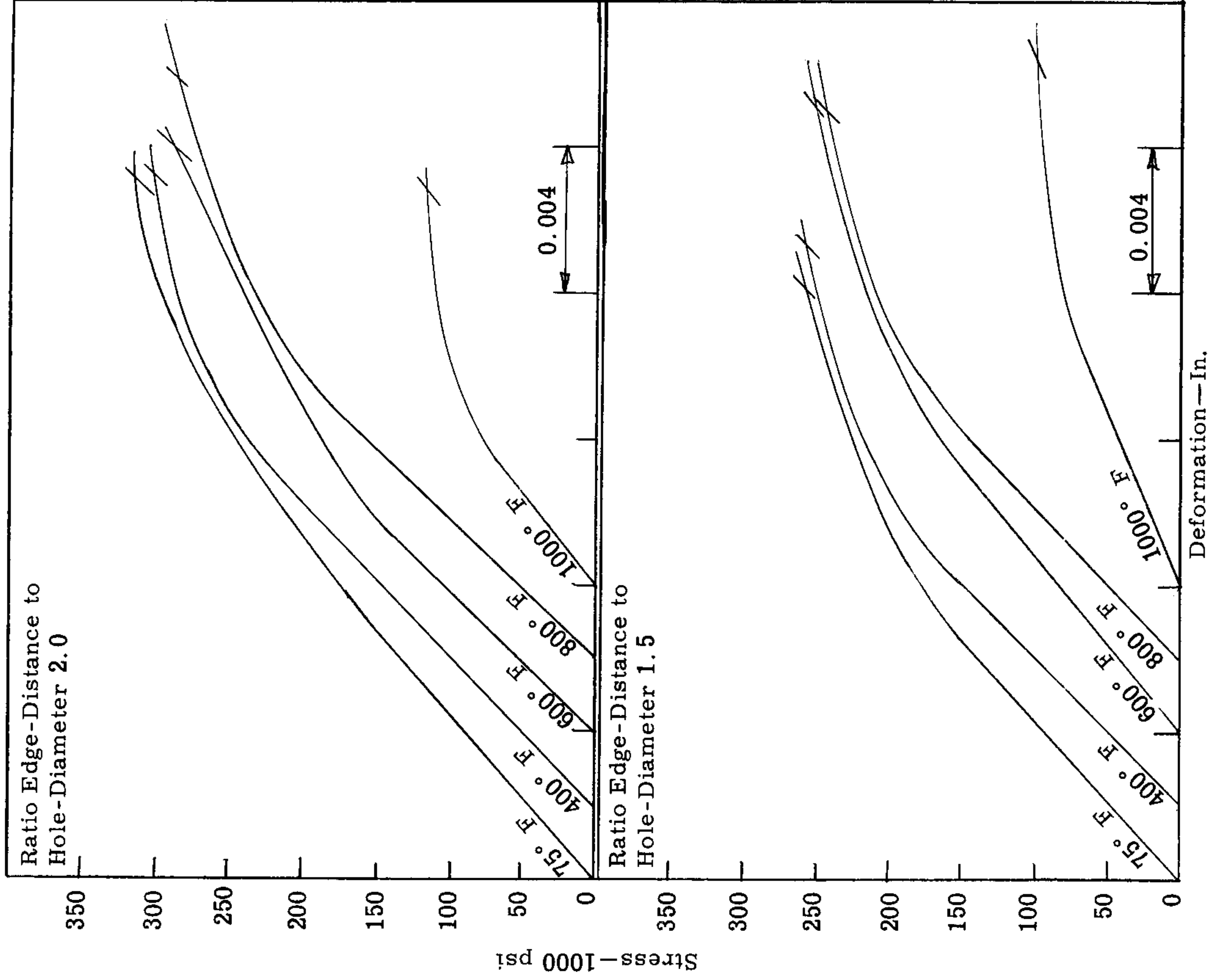

Fig. 94. Bearing stress-deformation curves for quenched and tempered Type 420 stainless steel sheet at various temperatures and one-hundred-hour exposure time.

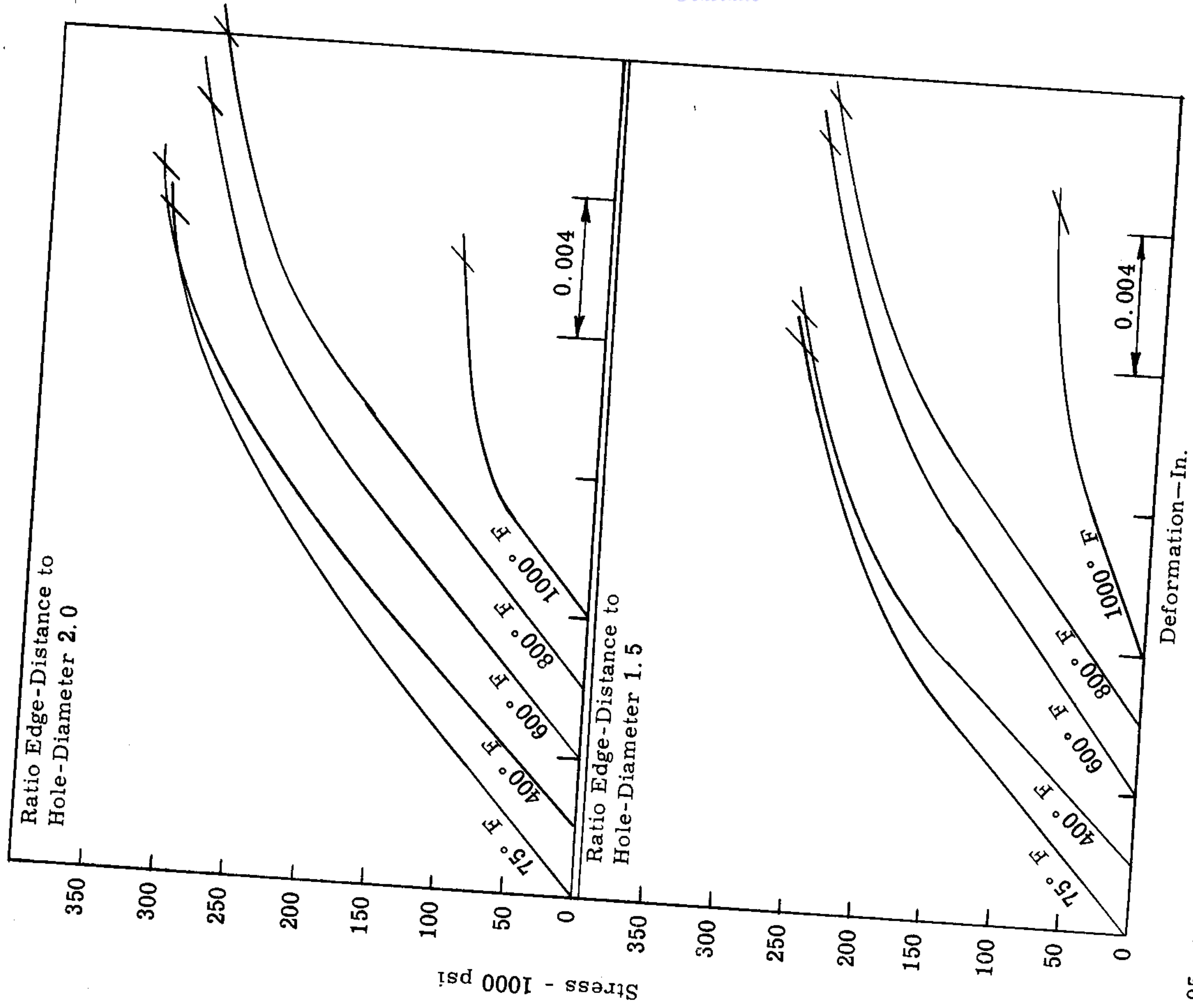

Fig. 95. Bearing stress-deformation curves for quenched and tempered Type 420 stainless steel sheet at various temperatures and one-thousand-hour exposure time.

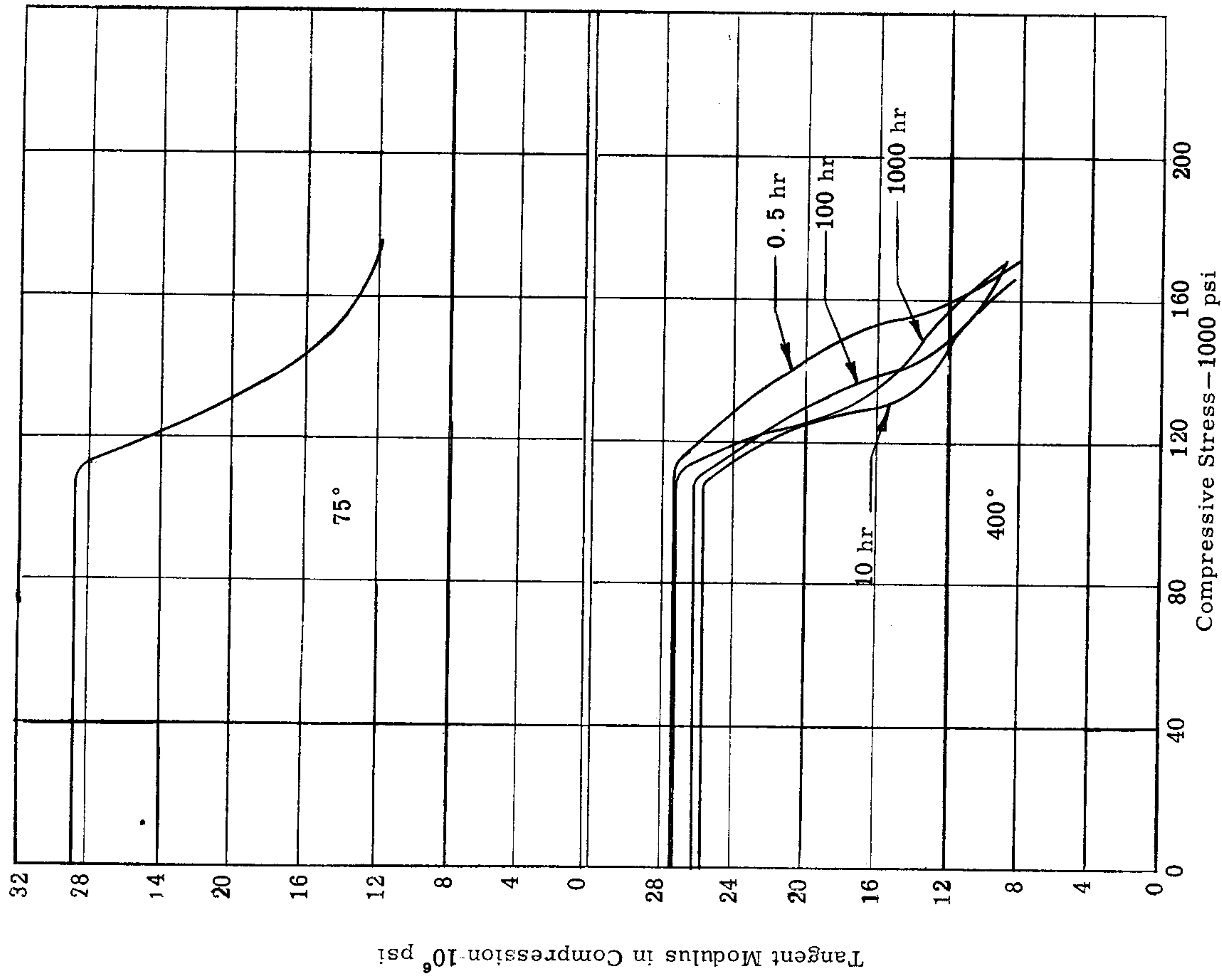

Fig. 96. Tangent-modulus vs. compressive-stress curves for quenched and tempered Type 420 stainless steel sheet at 75° F and 400° F and different exposure times.

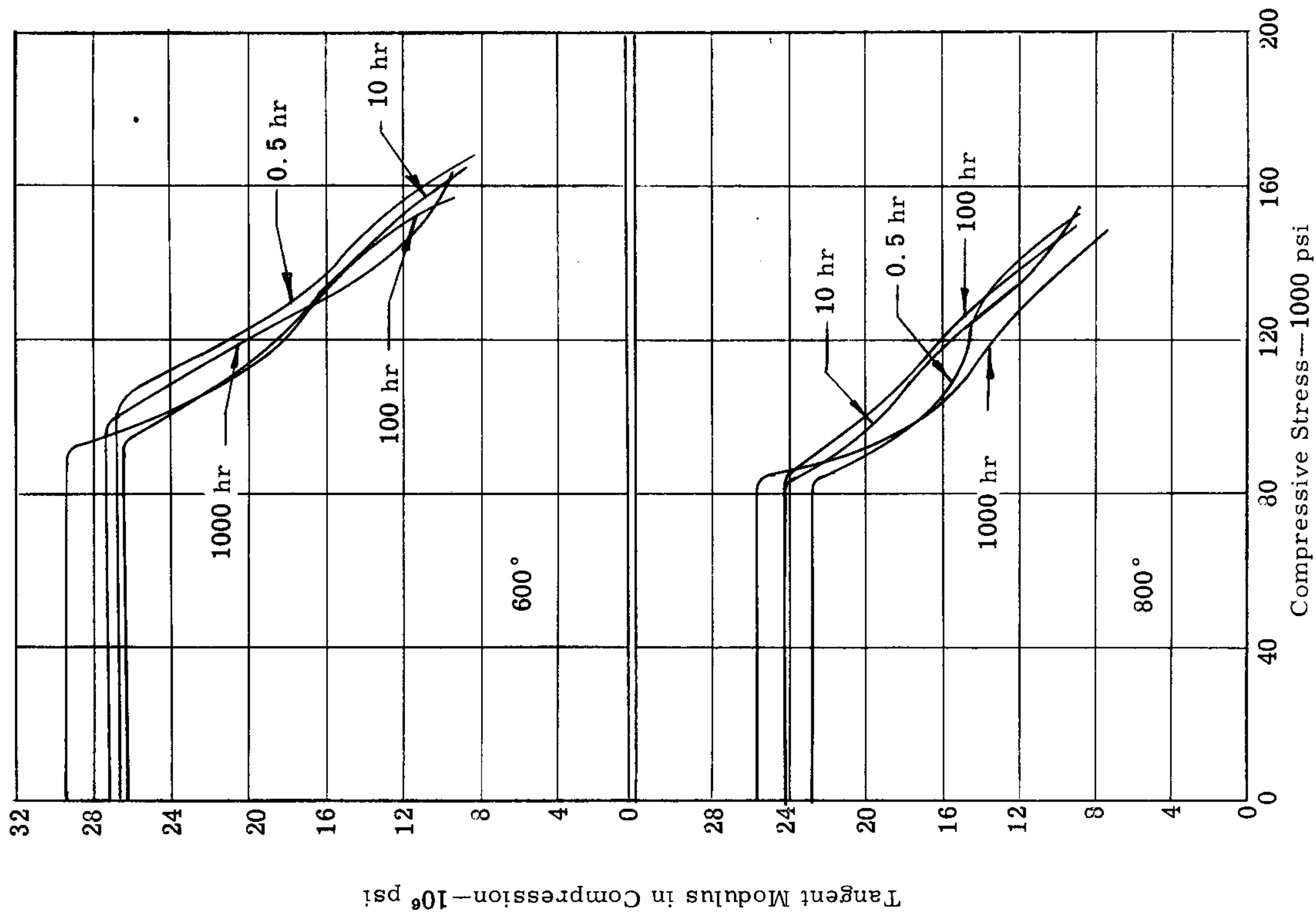

Fig. 97. Tangent-modulus vs. compressive-stress curves for quenched and tempered Type 420 stainless steel sheet at 600° F and 300° F and different exposure times.

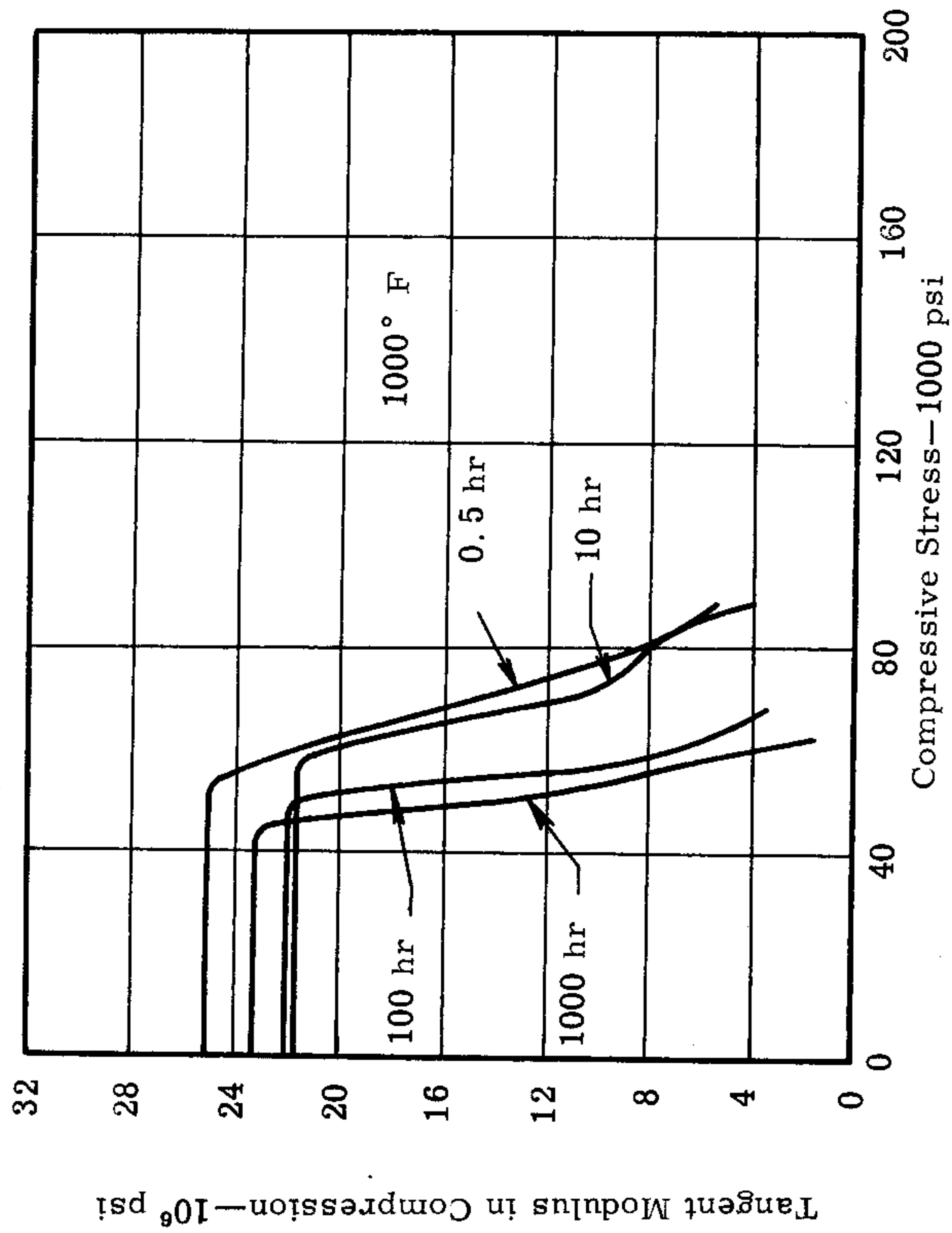

Fig. 98. Tangent-modulus vs. compressive-stress curves for quenched and tempered Type 420 stainless steel sheet at 1000° F and different exposure times.

Tensile Properties of 0.062-In. Type 420 Stainless Steel¹ Sheet at Different Temperatures and Holding Times

Temp °F	Holding Time, hr	YS 1000 psi	UTS 1000 psi	ME 10 ⁶ psi	Elong. %	Hard ¹ R45N	RS ² 1000 psi	RS ³ 1000 psi
RT		151.1	208.0	30.0	8	51	178.2	299.0
		147.0	208.0	30.3	8	51	174.2	274.0
		150.0	207.0	30.3	8	48	183.0	237.0
Avg		149.4	207.7	30.2	8	50	178.5	271.0
400	0.5	149.0	192.5	24.3	8	46	160.5	301.0
		155.0	192.5	27.4	8	46	160.0	209.0
		155.0	192.5	27.4	8	46	160.0	209.0
Avg		153.0	192.5	26.7	8	46	160.1	239.6
400	10	146.2	186.8	25.2	8	45	154.0	279.0
		147.2	192.0	24.4	8	47	158.6	284.0
		149.5	191.5	24.3	8	44	159.4	258.0
Avg		147.6	190.1	24.6	8	45	157.3	273.6
400	100	144.0	189.5	25.4	8	46	156.0	271.8
		144.5	192.5	23.4	8	47	158.5	264.5
		141.2	194.5	24.8	8	45	161.0	270.5
Avg		143.2	192.1	24.5	8	46	158.5	268.9
400	1000	143.5	189.5	25.7	7	46	155.0	273.0
		148.5	191.0	25.5	8	44	160.2	267.0
		147.5	190.0	26.2	8	46	157.5	267.0
Avg		146.5	190.1	25.8	8	45	157.5	269.0

174

WADC TR 58-365

Tensile Properties of 0.062-In. Type 420 Stainless Steel¹ Sheet at Different Temperatures and Holding Times

Temp ° F	Holding Time, hr	YS 1000 psi	UTS 1000 psi	ME 10 ⁶ psi	Elong. %	Hard ¹ R45N	RS ² 1000 psi	RS ³ 1000 psi
600	0.5	171.0	191.5	27.0	6	47	170.0	257.0
	Avg	153.0	189.0	30.4	6	49	176.0	328.0
600	10	143.8	192.0	30.6	7	50	176.5	293.0
	Avg	158.5	198.5	27.6	7	51	186.5	305.0
600	100	147.2	190.8	28.1	6	50	181.5	317.5
	Avg	142.5	193.2	27.8	7	48	180.2	263.5
600	1000	138.4	185.0	30.2	6	48	174.0	312.0
	Avg	156.8	190.5	29.5	6	50	166.8	286.0
800	0.5	148.0	185.5	26.3	9.0	48	172.0	243.0
	Avg	139.0	186.0	24.3	8.0	46	166.5	297.0
Avg		141.8	186.8	25.1	9.0	48	167.5	268.0

175

WADC TR 58-365

Table 22 (continued)

Table 22 (continued)
 Tensile Properties of 0.062-In. Type 420 Stainless Steel Sheet at
 Different Temperatures and Holding Times

Temp °F	Holding Time, hr	YS		UTS		ME		Elong. %		Hard ¹ R45N		RS ² 1000 psi		RS ³ 1000 psi	
		Avg	1000	Avg	1000	Avg	1000	Avg	1000	Avg	1000	Avg	1000	Avg	1000
800	10	143.8	136.8	184.5	181.0	26.7	22.8	8.0	8.5	47	47	158.2	150.5	289.0	228.5
800	100	130.6	136.8	180.5	181.0	25.1	22.8	8.0	8.5	47	47	158.2	150.5	282.0	228.5
800	1000	133.5	136.8	185.0	182.5	23.9	23.7	8.0	8.0	46	46	154.0	159.2	264.0	251.0
Avg	1000	136.0	133.5	183.3	180.6	25.2	24.1	8.0	8.0	47	47	162.6	158.6	271.0	247.8
800	1000	137.5	133.5	185.8	176.5	24.1	25.7	8.0	6.0	47	47	166.2	151.6	280.7	240.0
Avg	1000	134.5	132.3	180.6	174.0	24.3	27.3	8.0	6.0	47	47	166.2	151.6	289.0	233.0
800	0.5	136.3	133.5	182.5	176.9	23.7	27.2	8.0	6.0	45	46	159.2	147.8	239.5	237.5
Avg	0.5	137.5	141.0	185.8	180.2	24.1	28.7	8.0	6.0	47	48	162.6	147.8	239.5	237.5
1000	0.5	136.8	141.0	183.3	176.9	23.9	27.2	8.0	6.0	46	46	154.0	147.8	239.5	237.5
Avg	0.5	136.0	135.6	183.3	176.9	25.2	27.2	8.0	6.0	47	47	158.6	153.4	239.5	237.5
1000	10	73.8	77.2	80.8	80.8	21.6	21.6	19	13	33	47	39.5	65.0	138.0	138.0
Avg	10	77.4	77.2	80.9	80.8	21.5	25.8	20	14	31	47	39.5	57.0	139.0	139.0
1000	10	73.8	77.2	80.8	80.8	21.6	25.8	19	14	33	47	39.5	46.0	139.0	139.0
Avg	10	77.4	77.2	80.9	80.8	21.5	25.8	20	14	31	47	39.5	46.0	139.0	139.0
1000	10	76.1	77.2	82.4	82.4	20.7	20.7	20	13	32	47	41.4	56.0	136.0	136.0
Avg	10	77.4	77.2	82.4	82.4	20.7	20.7	20	13	32	47	41.4	56.0	136.0	136.0

WADC TR 58-365

Tensile Properties of 0.062-In. Type 420 Stainless Steel⁴ Sheet at Different Temperatures and Holding Times

Temp °F	Holding Time, hr	YS 1000 psi	UTS 1000 psi	ME 10 ⁶ psi	Elong. %	Hard ¹ R45N	RS ² 1000 psi	RS ³ 1000 psi
1000	100	62.9	70.0	17.8	17	32	34.6	114.2
	Avg	62.0	69.0	22.5	17	37	34.5	93.6
1000	1000	62.5	69.0	26.5	18	35	34.5	116.0
	Avg	62.5	69.3	22.3	17	35	34.5	107.9
1000	1000	61.0	65.7	20.6	22	33	6.4	17.6
	Avg	61.0	65.7	20.9	22	35	22.4	62.5
1000	1000	59.3	65.7	23.1	13	33	22.4	66.5
	Avg	60.4	65.7	21.5	19	34	17.1	48.9

1. Hardness determinations at room temperature after tests.
2. Rupture strength based on original cross section.
3. Rupture strength based on final cross section.
4. Heat treatment — 1800° F 15 min argon atmosphere, O. Q., 900° F 3 hr, A. C.

Tensile Strength of 3/16-In. Type 420 Stainless Steel³ Plate at Different Temperatures and Holding Times

Holding Time, hr	Temp ° F	1/2		10		100		1000	
		UTS ¹ 1000 psi	Hard ² RC	UTS 1000 psi	Hard RC	UTS 1000 psi	Hard RC	UTS 1000 psi	Hard RC
RT	Avg	213.0	47	208.0	47	207.0	46	228.0	45
		216.0	48	212.0	47	207.0	46	224.0	45
400	Avg	212.0	47	210.0	47	209.0	45	228.6	45
		213.7	47	210.0	47	207.7	46	226.8	45
600	Avg	207.0	46	208.0	47	205.5	46		
		203.0	46	207.0	47	205.0	45		
		207.0	46	201.0	47	205.2	45		
		205.7	46	205.3	47	205.2	45		
800	Avg	195.5	49	195.0	47	195.0	45		
		197.5	46	203.0	48	187.0	46		
		203.0	48	193.5	47	193.0	45		
		198.7	48	197.2	47	191.7	45		

178

WADC TR 58-365

Table 23 (continued)
 Tensile Strength of 3/16-In. Type 420 Stainless Steel³ Plate at
 Different Temperatures and Holding Times

Holding Time, hr	Temp ° F	1/2		10		100		1000	
		UTS ¹ 1000 psi	Hard ² RC	UTS 1000 psi	Hard RC	UTS 1000 psi	Hard RC	UTS 1000 psi	Hard RC
1000		118.5	44	84.5	35	76.2	29	64.6	29
		122.0	42	86.3	34	72.0	30	63.6	27
		120.0	44	87.5	34	73.0	30	63.0	-
Avg		120.2	43	86.1	34	73.7	30	63.7	28

1. Ultimate tensile strength.
2. Hardness determinations made at room temperature after tests.
3. Heat treatment — 1800° F 15 min argon atmosphere, O. Q., 900° F 3 hr, A. C.

Compressive Properties of 0.062-In. Type 420 Stainless Steel Sheet at Different Temperatures and Holding Times

Hold. Time hr	Temp °F	1/2		10		100		1000											
		CYS ¹	ME ²	Hard ²	R45N	psi	ME ¹	CYS ¹	Hard	R45N	psi	ME ¹	CYS ¹	Hard	R45N	psi			
RT	Avg	178.0	27.7	48	174.0	25.3	47	172.1	25.9	47	166.5	29.3	47	179.6	28.9	47	184.0	29.3	48
		171.5	27.4	48	166.0	28.6	45	172.5	26.3	48	170.5	27.3	47	176.0	28.7	48	176.0	28.7	48
400	Avg	160.5	29.6	49	165.5	25.8	45	169.0	26.3	47	164.0	26.5	44	179.0	28.6	46	179.0	28.6	46
		170.0	28.2	48	168.5	26.6	46	171.2	26.2	47	167.0	27.7	46	176.0	28.7	48	176.0	28.7	48
600	Avg	166.0	25.8	47	159.5	24.0	45	157.0	29.4	48	159.0	28.8	47	176.0	28.7	48	176.0	28.7	48
		167.5	26.6	50	163.8	26.4	45	154.0	29.4	48	163.0	27.1	47	179.0	28.6	46	179.0	28.6	46
800	Avg	152.0	25.7	48	156.7	28.8	49	161.0	24.9	51	154.0	23.9	46	179.0	28.6	46	179.0	28.6	46
		148.0	25.4	47	154.8	24.2	50	149.5	26.7	47	153.0	21.1	46	179.0	28.6	46	179.0	28.6	46
Avg	Avg	157.5	26.0	47	158.2	26.0	50	154.2	24.2	49	151.9	22.6	46	179.0	28.6	46	179.0	28.6	46
		152.0	25.7	48	156.7	28.8	49	161.0	24.9	51	154.0	23.9	46	179.0	28.6	46	179.0	28.6	46

WADC TR 58-365 180

Table 25
Shear Strength of 3/16-In. Type 420 Stainless Steel³ Plate at Different Temperatures and Holding Times

Holding Time, hr	Temp °F	1/2		10		100		1000	
		USS ¹	Hard ²	USS	Hard	USS	Hard	USS	Hard
RT	Avg	125.0	42	131.2	47	126.5	46	126.5	46
		128.2	43	129.2	46	125.2	47	128.2	45
400	Avg	128.2	42	128.2	47	128.5	46	121.0	46
		127.1	42	129.5	47	126.7	46	125.2	46
600	Avg	128.5	47	120.0	47	128.2	23	118.8	33
		126.5	43	123.0	45	125.0	24	124.0	24
800	Avg	131.8	43	126.2	41	128.0	42	122.0	40
		132.0	42	126.0	43	127.0	42	124.0	42
Avg		123.0	41	129.4	41	127.0	41	134.0	42
		128.9	42	127.2	42	127.3	42	126.7	41

182

WADC TR 58-365

Table 25 (continued)
 Shear Strength of 3/16-In. Type 420 Stainless Steel³ Plate at
 Different Temperatures and Holding Times

Holding Time, hr	Temp ° F	1/2		10		100		1000	
		Hard ²	USS ¹ 1000 psi	Hard	USS 1000 psi	Hard	USS 1000 psi	Hard	USS 1000 psi
		39	86.3	38	86.6	38	86.3	39	86.3
		44	86.1	31	78.5	28	54.2	28	45.8
		38	86.6	38	72.2	29	54.2	29	47.2
		40	86.3	36	73.2	29	58.2	29	47.7
	Avg								
	1000								
		22	50.0	25	45.8	24	47.7	22	50.0
		-	47.2	-	47.2	-	47.7	-	47.2
		24	47.7	24	47.7	24	47.7	24	47.7

1. Ultimate shear strength.
2. Hardness determinations made at room temperature after tests.
3. Heat treatment - 1800° F 15 min argon atmosphere, O. Q., 900° F 3 hr, A. C.

Bearing Properties⁴ of 0.062-In. Type 420 Stainless Steels Sheet at Different Temperatures and Holding Times

Table 26

Hold. Time hr	1/2		10		100		1000	
	BYS ¹ 1000 psi	UBS ² 1000 psi	BYS ¹ 1000 psi	UBS ² 1000 psi	BYS ¹ 1000 psi	UBS ² 1000 psi	BYS ¹ 1000 psi	UBS ² 1000 psi
Temp ° F	Hard ³ R45N	Hard ³ R45N	Hard ³ R45N	Hard ³ R45N	Hard ³ R45N	Hard ³ R45N	Hard ³ R45N	Hard ³ R45N
RT	304.0	304.0	203.0	305.0	261.0	317.0	262.0	292.0
Avg	272.5	304.0	-	299.0	269.5	315.0	261.0	296.0
400	243.0	304.0	195.5	294.0	250.0	303.0	272.0	305.0
Avg	243.0	304.0	199.2	299.3	260.2	311.7	265.0	297.7
600	248.5	297.0	251.0	314.0	262.0	313.0	250.0	301.5
Avg	240.0	299.0	252.0	311.0	235.5	296.0	260.0	304.0
800	242.5	291.0	248.0	302.0	246.0	296.0	244.0	289.0
Avg	261.0	291.0	256.0	307.0	251.0	304.0	244.0	285.5
Avg	241.8	293.0	249.7	298.3	248.3	300.7	243.7	288.3

184

WADC TR 58-365

Bearing Properties⁴ of 0.062-In. Type 420 Stainless Steel⁵ Sheet at Different Temperatures and Holding Times

Table 26 (continued)

Hold. Time hr	Temp ° F	1/2		10		100		1000		Avg
		BYS ¹ UBS ²	Hard ³ R45N	BYS UBS	Hard R45N	BYS UBS	Hard R45N	BYS UBS	Hard R45N	
		175.0	40	116.5	38	101.5	35	159.0	40	148.7
		169.2	38	123.0	38	100.0	36	143.0	38	144.0
		171.5	40	119.9	39	101.5	35	171.5	40	171.5
		171.9	39	135.8	38	112.2	35	171.9	39	171.9
				132.2	38	111.0	36			133.7
				134.0	39	111.2	35			134.0
				133.7	38	111.5	35			133.7
				101.5	38	101.0	35			101.0
				112.2	35	111.5	35			111.5
				82.8	35	88.0	36			86.8
				103.0	29	101.5	27			103.0
				106.5	29	106.5	29			106.5
				103.7	28	103.7	28			103.7

1. Bearing yield strength.
2. Ultimate bearing strength.
3. Hardness determinations made at room temperature after tests.
4. Edge-distance to hole-diameter ratio 1.5.
5. Heat treatment - 1800° F 15 min argon atmosphere, O. Q., 900° F 3 hr, A. C.

WADC TR 58-365 185

Bearing Properties⁴ of 0.062-In. Type 420 Stainless Steel⁵ Sheet at Different Temperatures and Holding Times

Table 27

Hold. Time hr	Temp °F	1/2		10		100		1000	
		BYS ¹ UBS ²	Hard ³ R45N	BYS UBS	Hard R45N	BYS UBS	Hard R45N	BYS UBS	Hard R45N
RT	49	435.0	428.0	431.0	431.3	334.0	325.0	303.0	320.7
	49	435.0	428.0	431.0	431.3	334.0	325.0	303.0	320.7
Avg	49	435.0	428.0	431.0	431.3	334.0	325.0	303.0	320.7
	49	435.0	428.0	431.0	431.3	334.0	325.0	303.0	320.7
400	48	408.0	394.0	400.0	404.0	-	405.0	405.0	405.0
	47	408.0	394.0	400.0	404.0	305.0	404.0	406.0	405.0
Avg	48	408.0	394.0	400.0	404.0	305.0	404.0	406.0	405.0
	48	408.0	394.0	400.0	404.0	305.0	404.0	406.0	405.0
600	50	401.0	401.0	386.0	383.0	283.0	383.0	290.0	378.5
	49	401.0	401.0	386.0	383.0	283.0	383.0	290.0	378.5
Avg	50	401.0	401.0	386.0	383.0	283.0	383.0	290.0	378.5
	49	401.0	401.0	386.0	383.0	283.0	383.0	290.0	378.5
800	44	400.0	394.0	374.0	392.0	293.5	392.0	294.0	392.0
	45	400.0	394.0	374.0	392.0	293.5	392.0	294.0	392.0
Avg	44	400.0	394.0	374.0	392.0	293.5	392.0	294.0	392.0
	45	400.0	394.0	374.0	392.0	293.5	392.0	294.0	392.0
800	44	400.0	394.0	374.0	392.0	293.5	392.0	294.0	392.0
	45	400.0	394.0	374.0	392.0	293.5	392.0	294.0	392.0
Avg	44	400.0	394.0	374.0	392.0	293.5	392.0	294.0	392.0
	45	400.0	394.0	374.0	392.0	293.5	392.0	294.0	392.0

186

WADC TR 58-365

Bearing Properties* of 0.062-In. Type 420 Stainless Steel⁵ Sheet at Different Temperatures and Holding Times

Hold. Time	Temp ° F	1/2		10		100		1000		Avg
		BYS ¹	UBS ²	BYS	UBS	BYS	UBS	BYS	UBS	
hr		1000 psi		1000 psi		1000 psi		1000 psi		
		R45N		R45N		R45N		R45N		
		Hard ³		Hard		Hard		Hard		
		160.0	193.5	147.8	166.0	113.7	145.7	109.0	138.0	171.8
		166.5	196.2	137.5	163.0	105.7	146.0	109.0	131.5	189.0
		189.0	206.0	147.8	169.0	117.0	144.5	107.0	135.8	198.6
		37	36	38	39	32	32	32	28	38
		147.8	147.8	144.4	144.4	112.1	145.4	108.1	135.1	144.4
		166.0	166.0	166.0	166.0	112.1	145.4	108.1	135.1	166.0
		38	38	38	38	32	32	32	28	38

1. Bearing yield strength.
2. Ultimate bearing strength.
3. Hardness determinations made at room temperature after tests.
4. Edge-distance to hole-diameter ratio 2.0
5. Heat treatment — 1800° F 15 min argon atmosphere, O. Q., 900° F 3 hr, A. C.

Table 27 (continued)

10.5 Type 422 Stainless Steel Sheet, Quenched and Tempered

Contrails

WADC TR 58-365

188

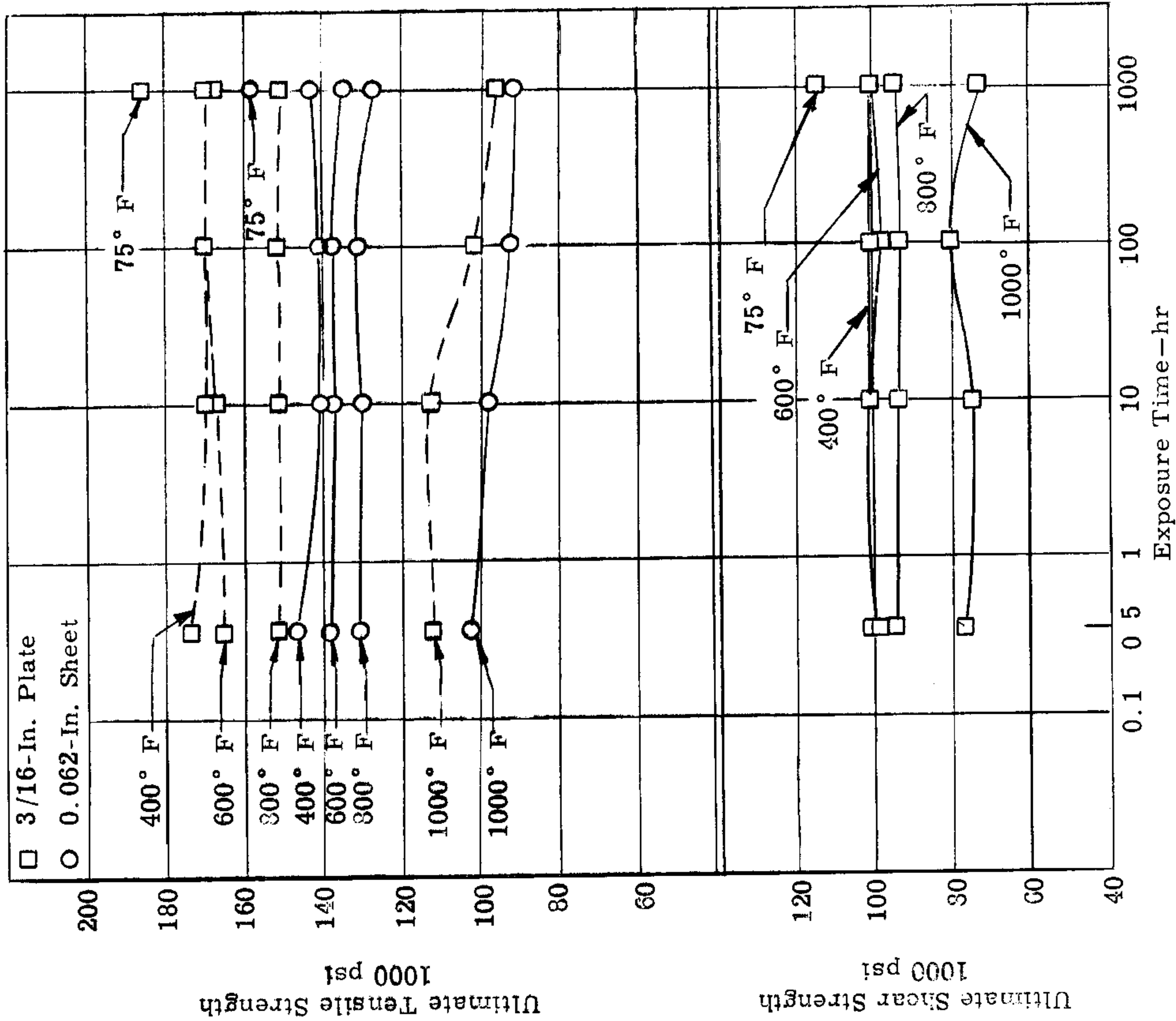

Fig. 99. Effect of exposure time on the ultimate tensile strength and ultimate shear strength of quenched and tempered Type 422 stainless steel at different temperatures.

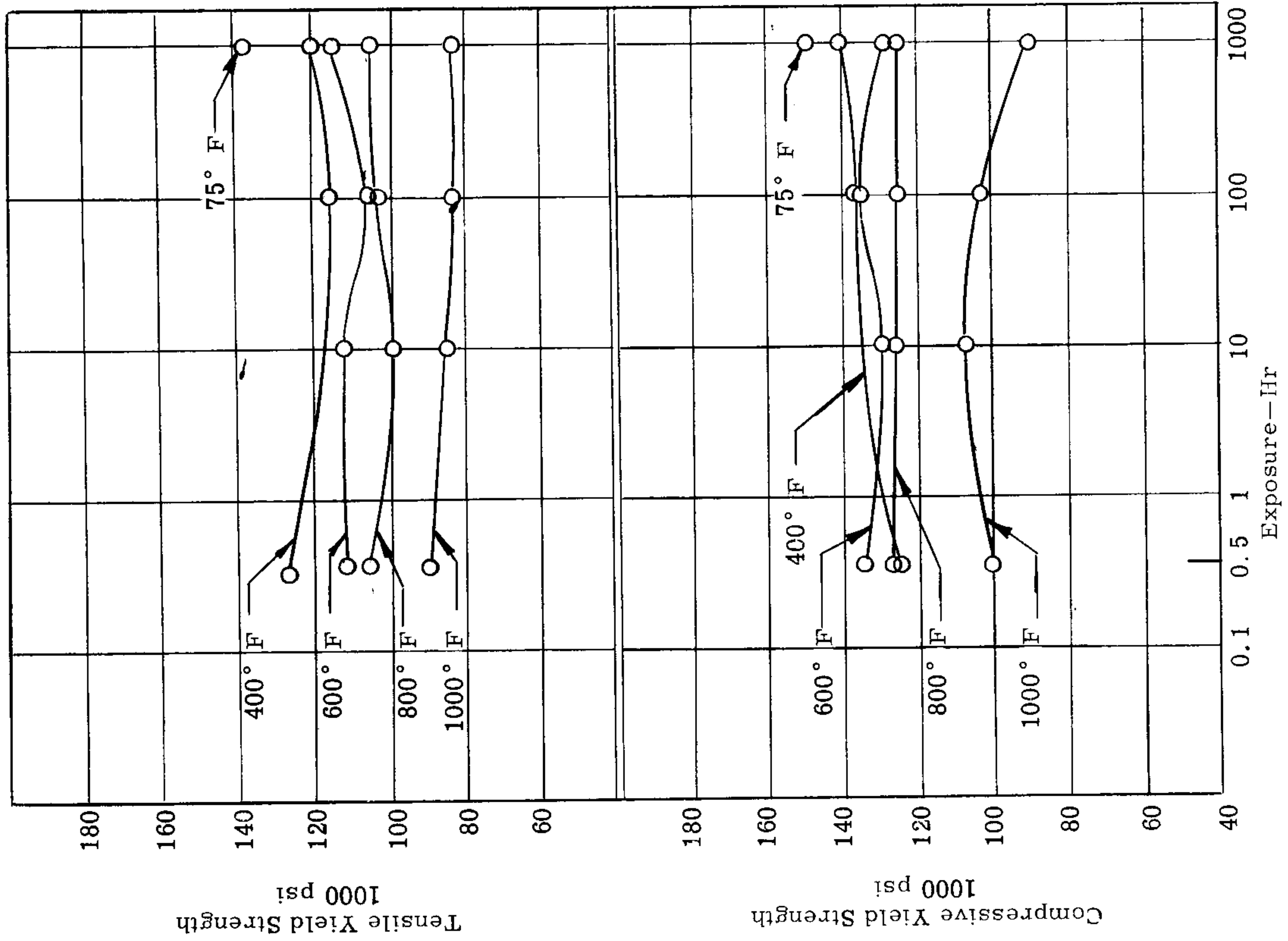

Fig. 100 Effect of exposure time on the tensile and compressive yield strength of quenched and tempered Type 422 stainless steel sheet at different temperatures.

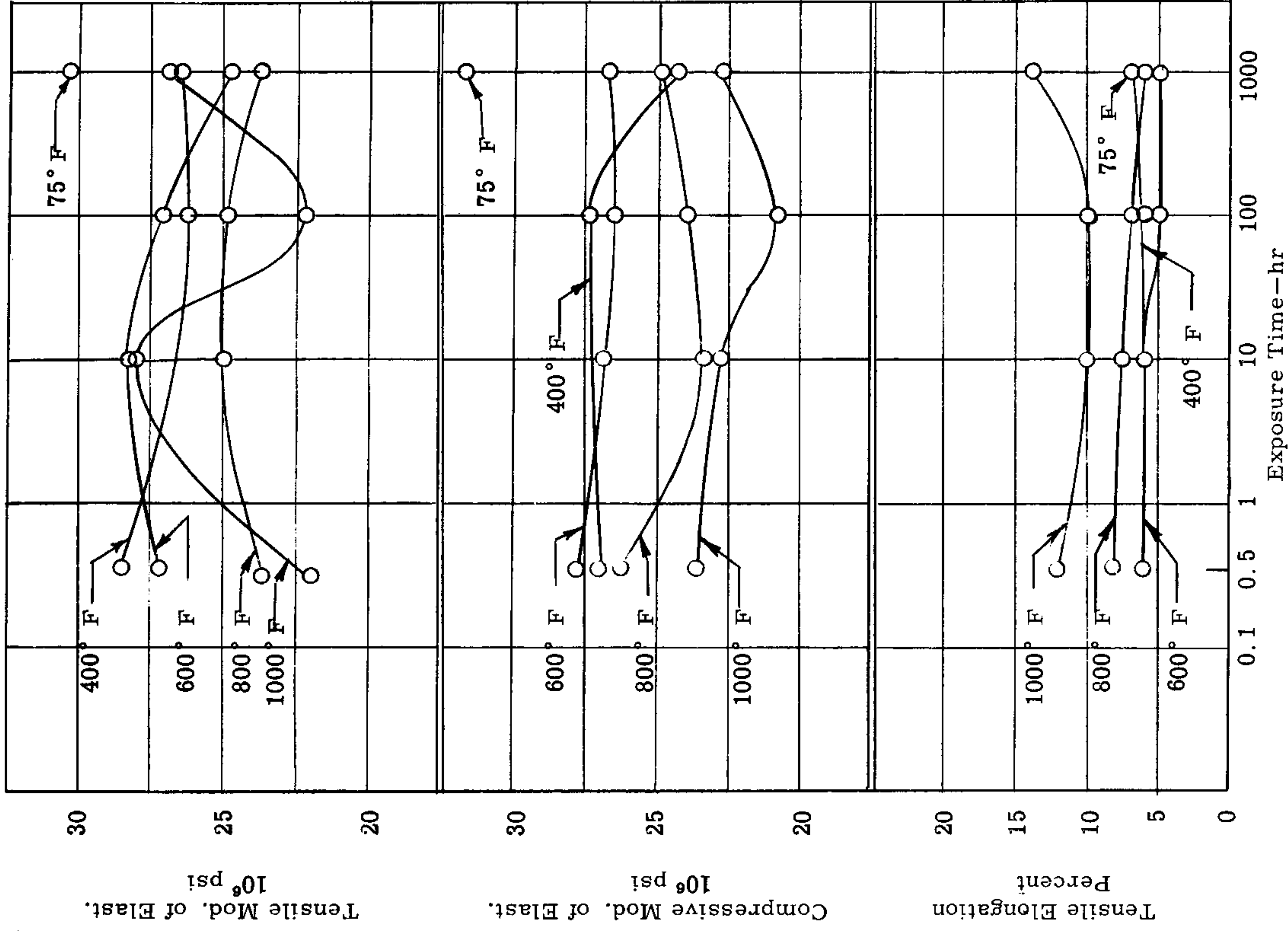

Fig. 101. Effect of exposure time on the tensile and compressive moduli of elasticity and percent elongation of quenched and tempered Type 422 stainless steel sheet at different temperatures.

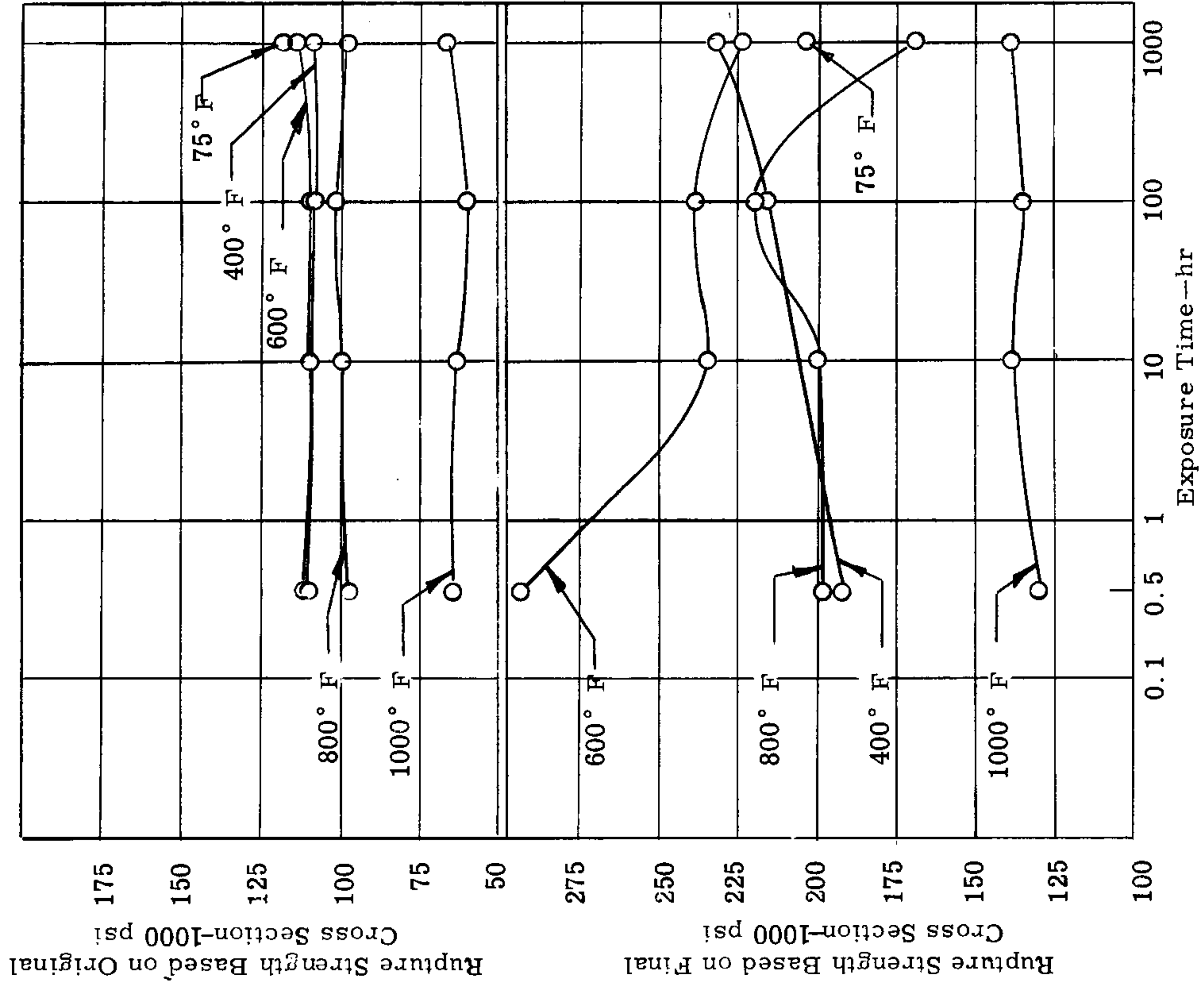

Fig. 102. Effect of exposure time on the tensile rupture strength of quenched and tempered Type 422 stainless steel sheet at different temperatures.

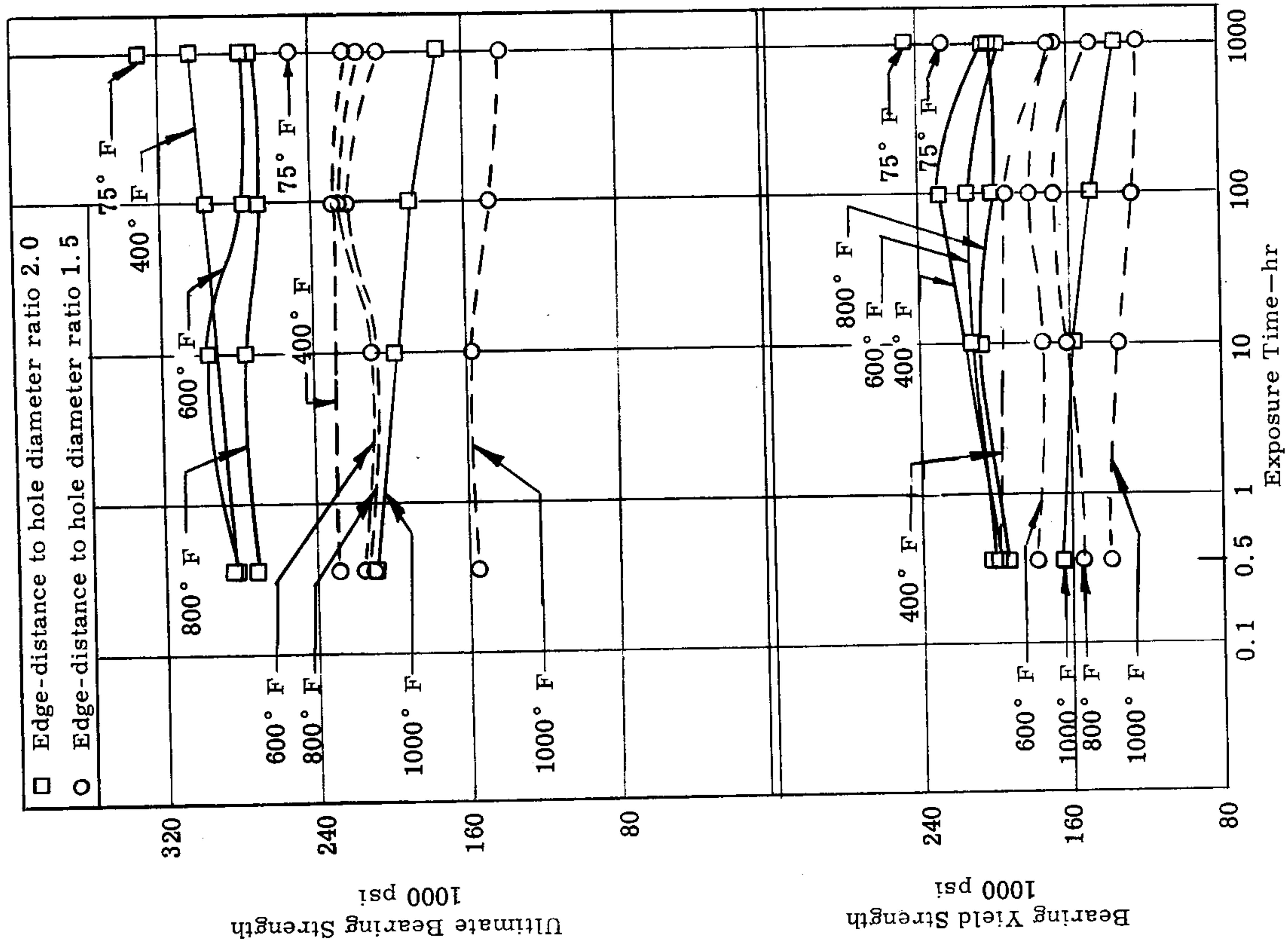

Fig. 103. Effect of exposure time on the bearing ultimate and yield strengths of quenched and tempered Type 422 stainless steel sheet at different temperatures.

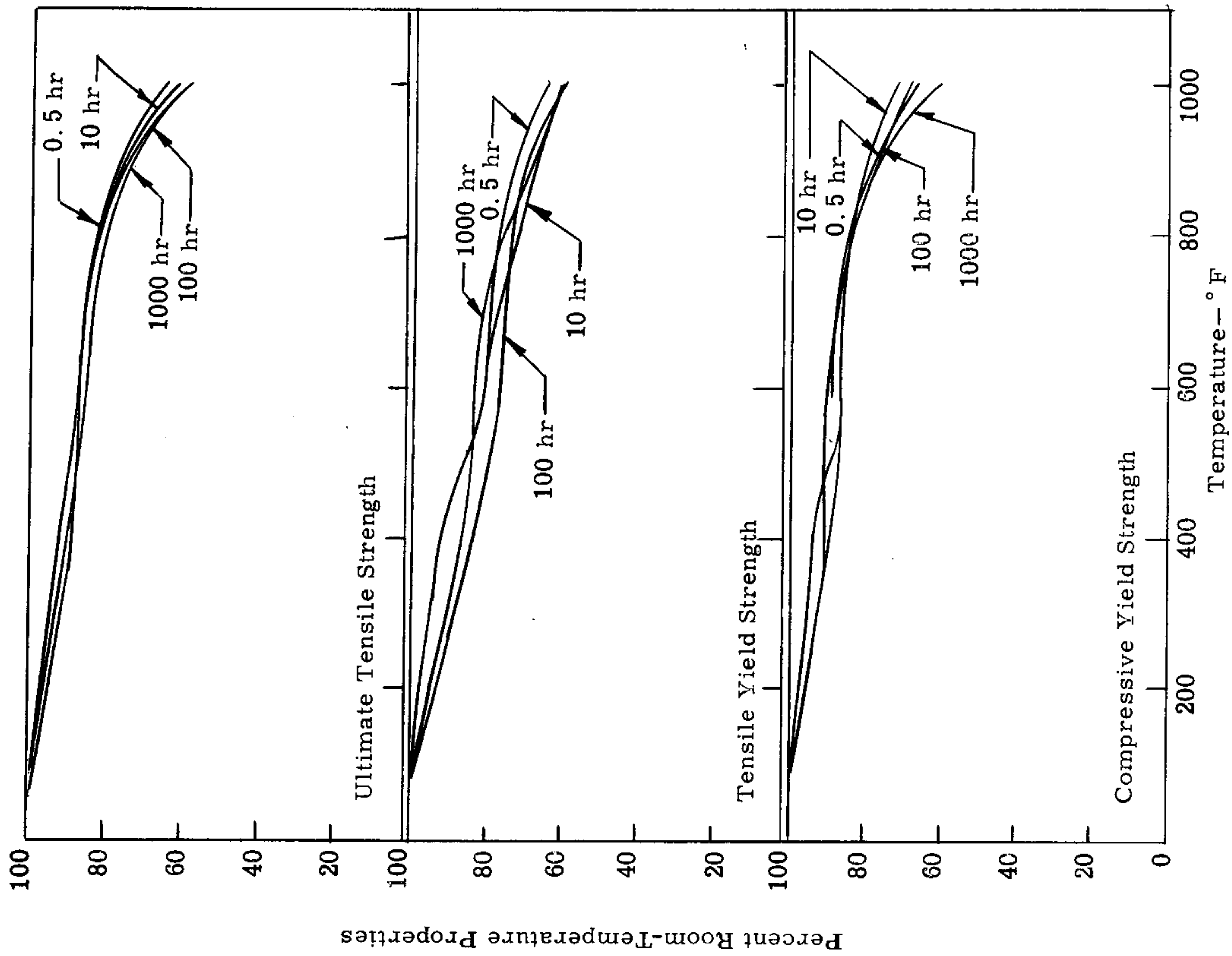

Fig. 104. Elevated-temperature strength properties as percent of room-temperature properties for quenched and tempered Type 422 stainless steel sheet at different exposure times.

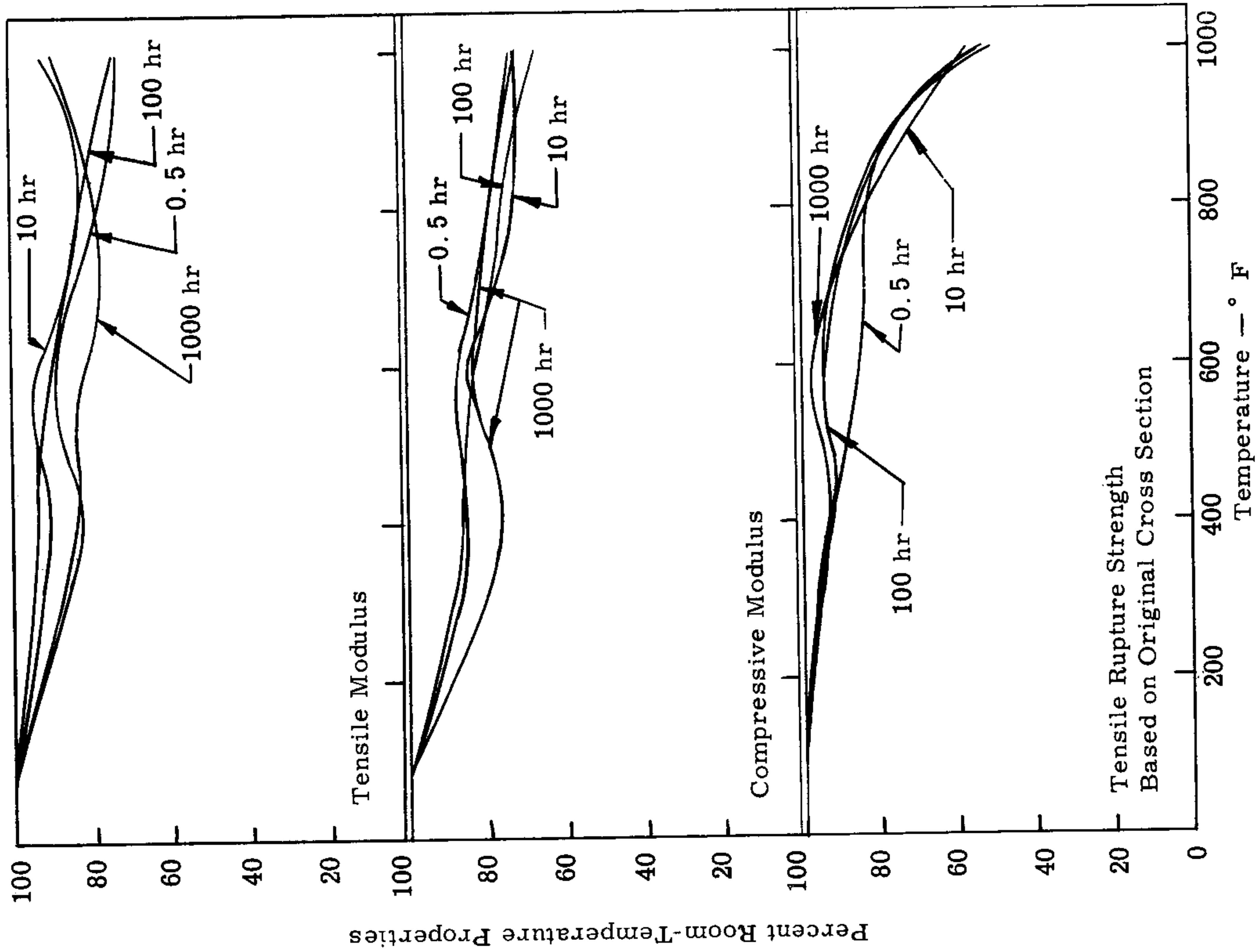

Fig. 105. Elevated-temperature properties as percent of room-temperature properties for quenched and tempered Type 422 stainless steel sheet at different exposure times.

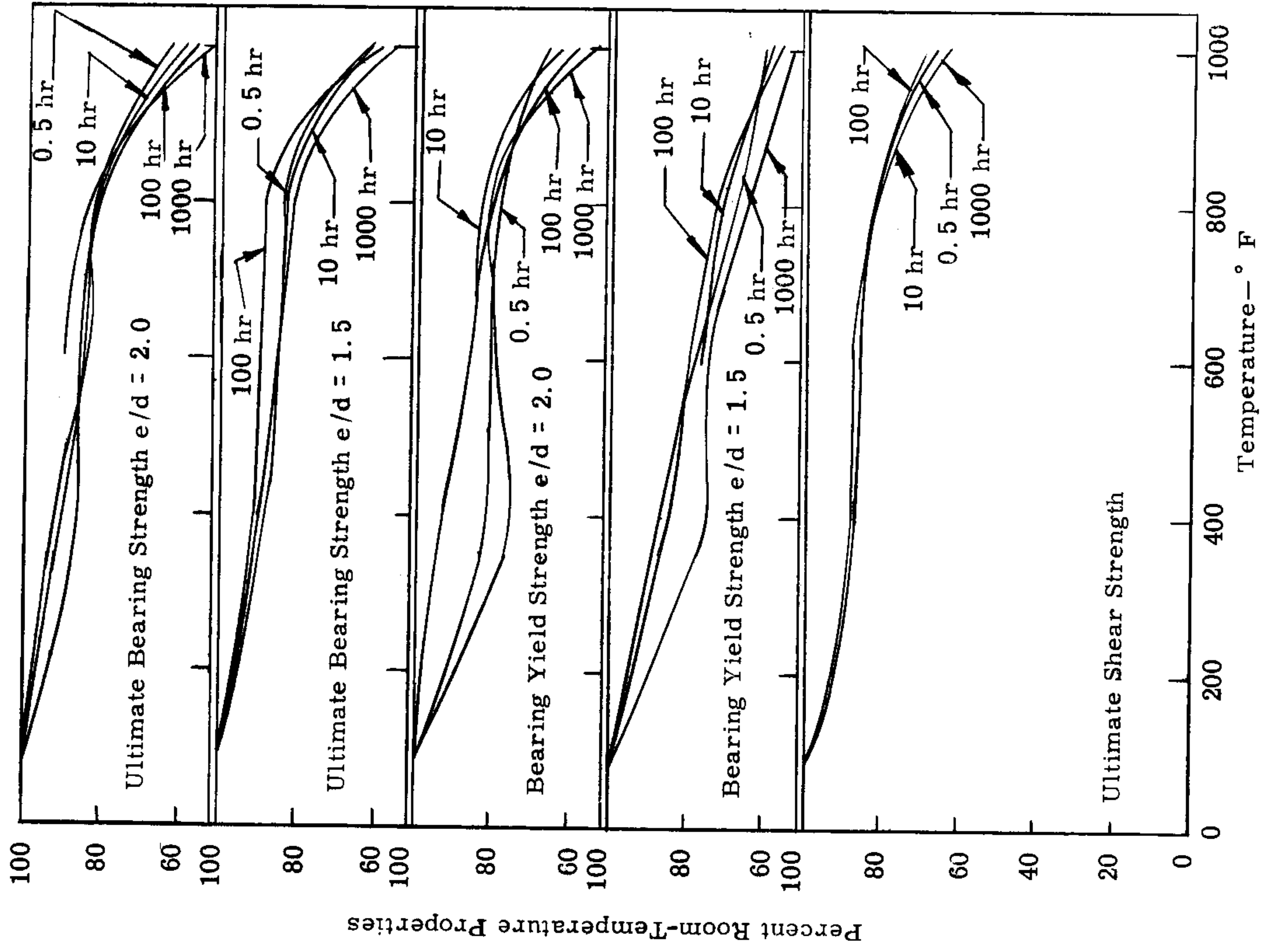

Fig. 106. Elevated-temperature strength properties as percent of room-temperature properties for quenched and tempered Type 422 stainless steel sheet at different exposure times.

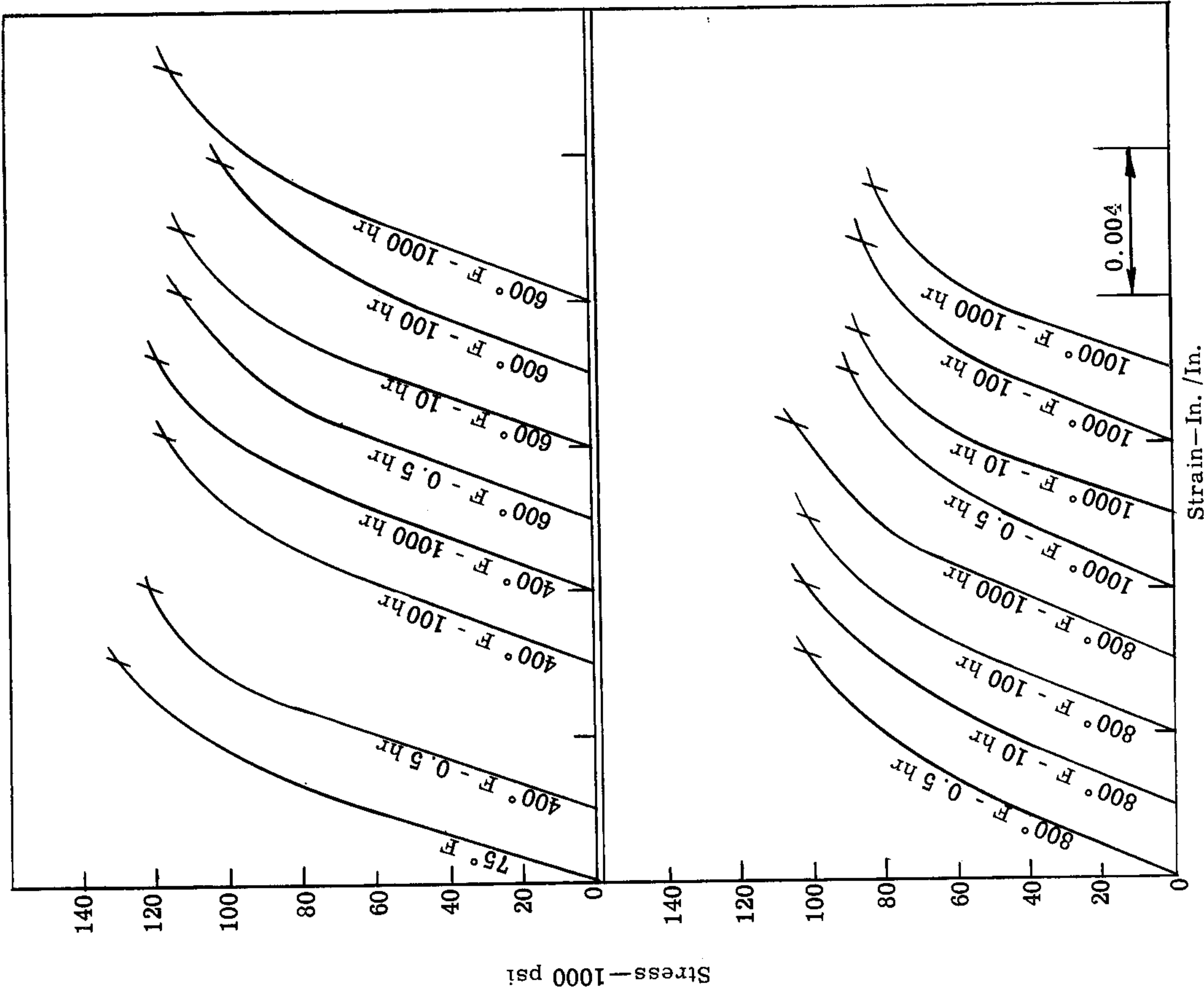

Fig. 107. Tensile stress-strain curves for quenched and tempered Type 422 stainless steel sheet at various temperatures and exposure times

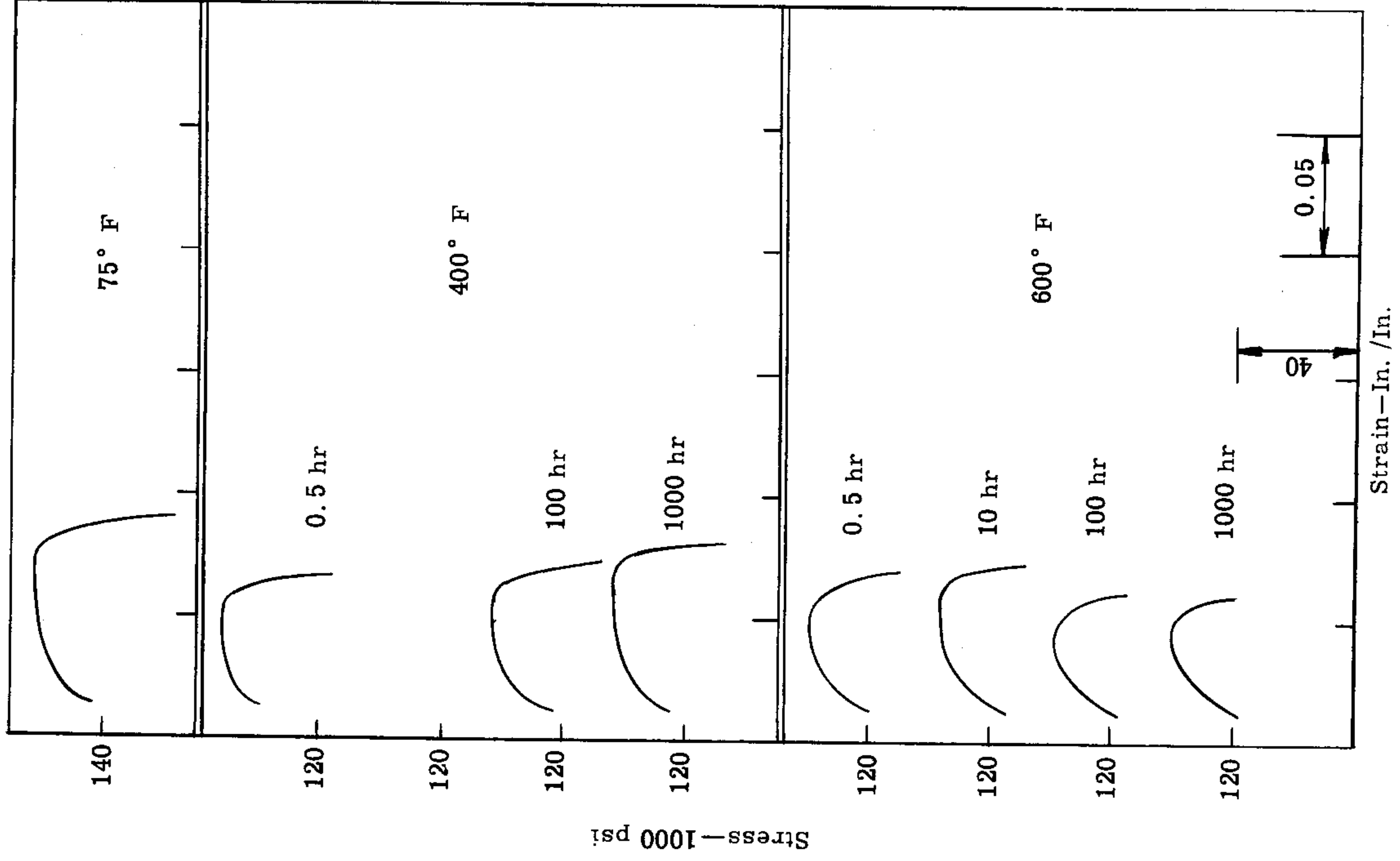

Fig. 108. Tensile Postyield stress-strain curves for quenched and tempered Type 422 stainless steel sheet at various temperatures and exposure times

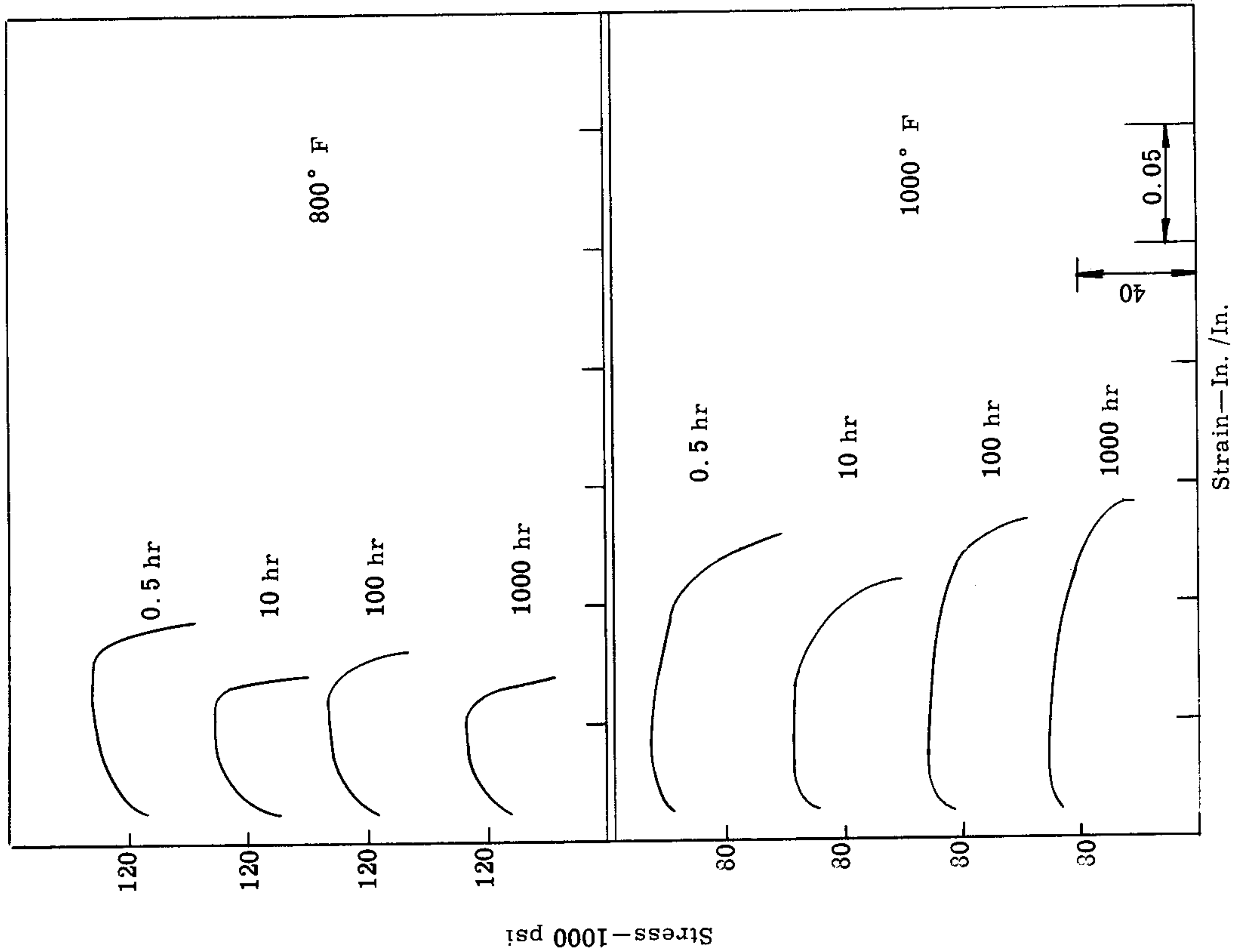

Fig. 109 Tensile postyield stress-strain curves for quenched and tempered Type 422 stainless steel sheet at various temperatures and exposure times.

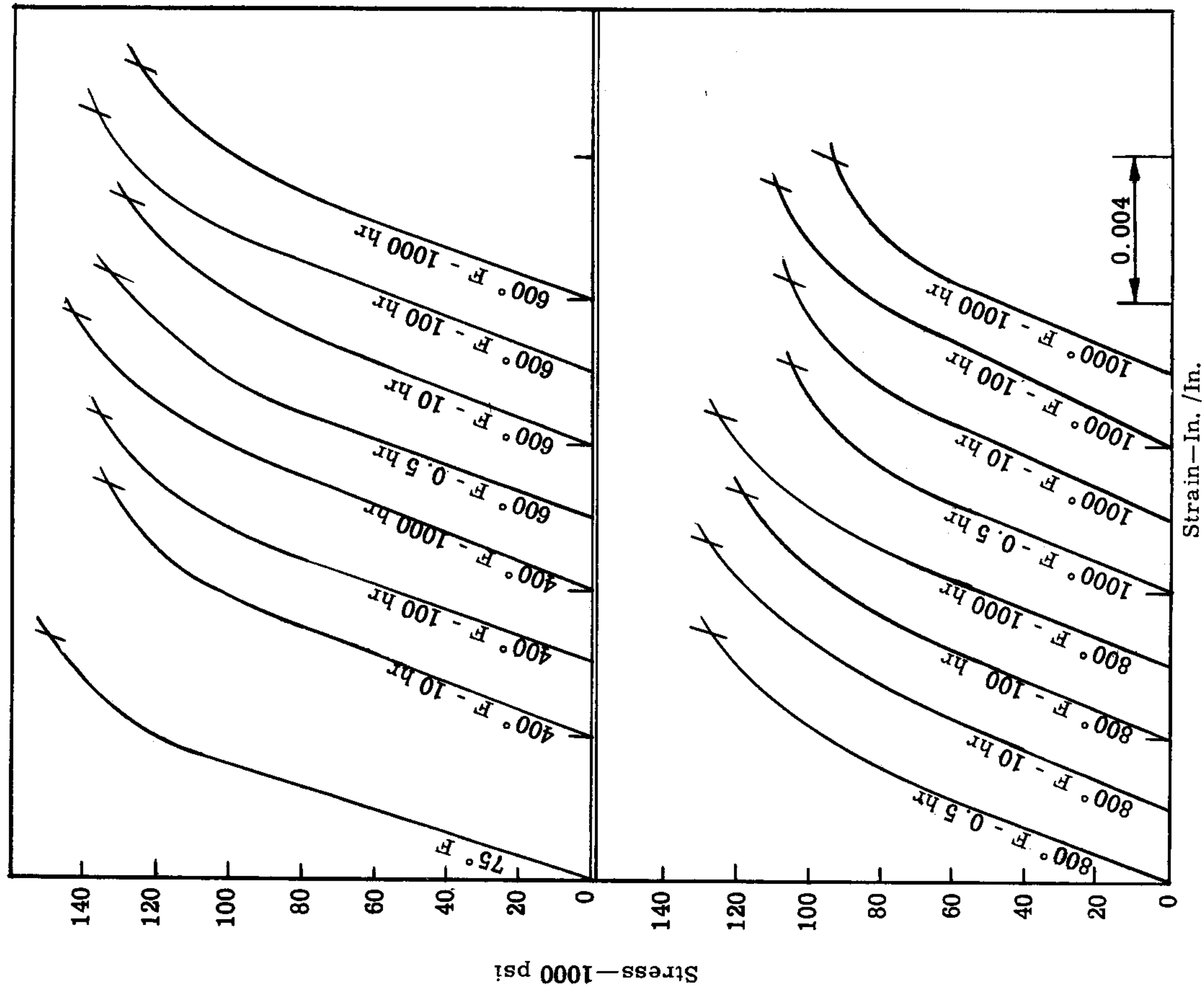

Fig. 110. Compressive-stress-strain curves for quenched and tempered Type 422 stainless steel sheet at various temperatures and exposure times.

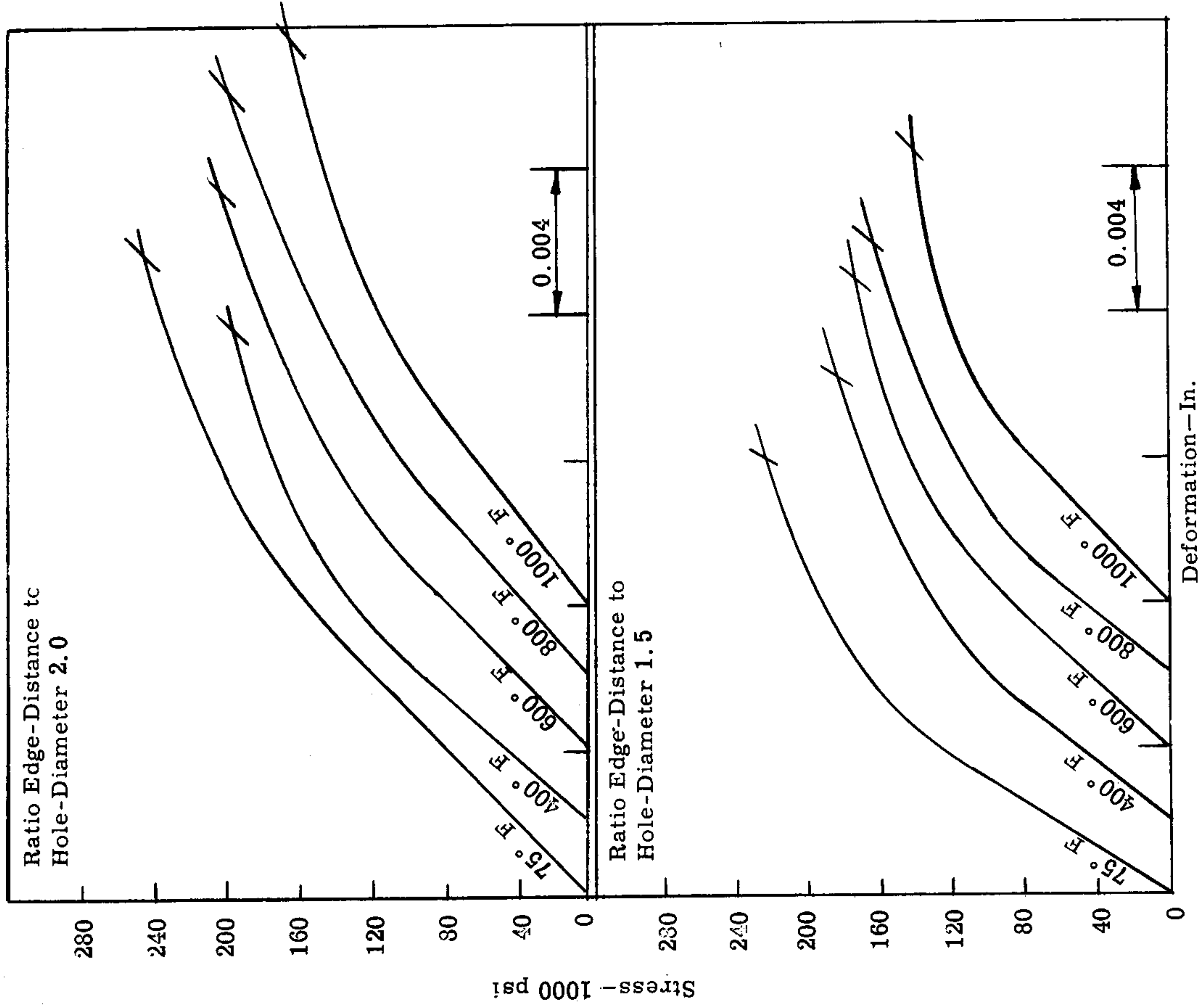

Fig. 111. Bearing stress-deformation curves for quenched and tempered Type 422 stainless steel sheet at various temperatures and one-half-hour exposure time.

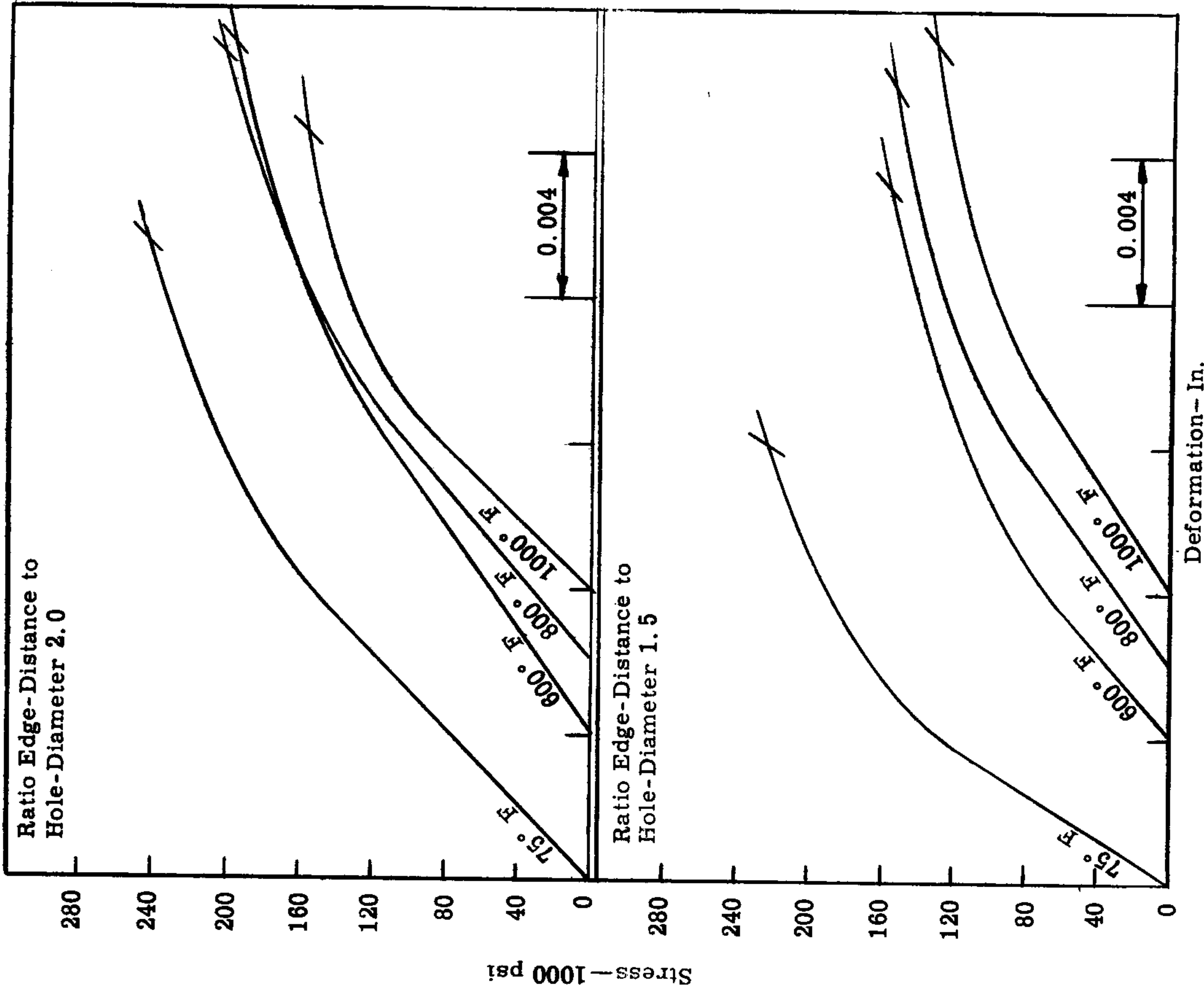

Fig. 112. Bearing stress-deformation curves for quenched and tempered Type 422 stainless steel sheet at various temperatures and ten-hour exposure time.

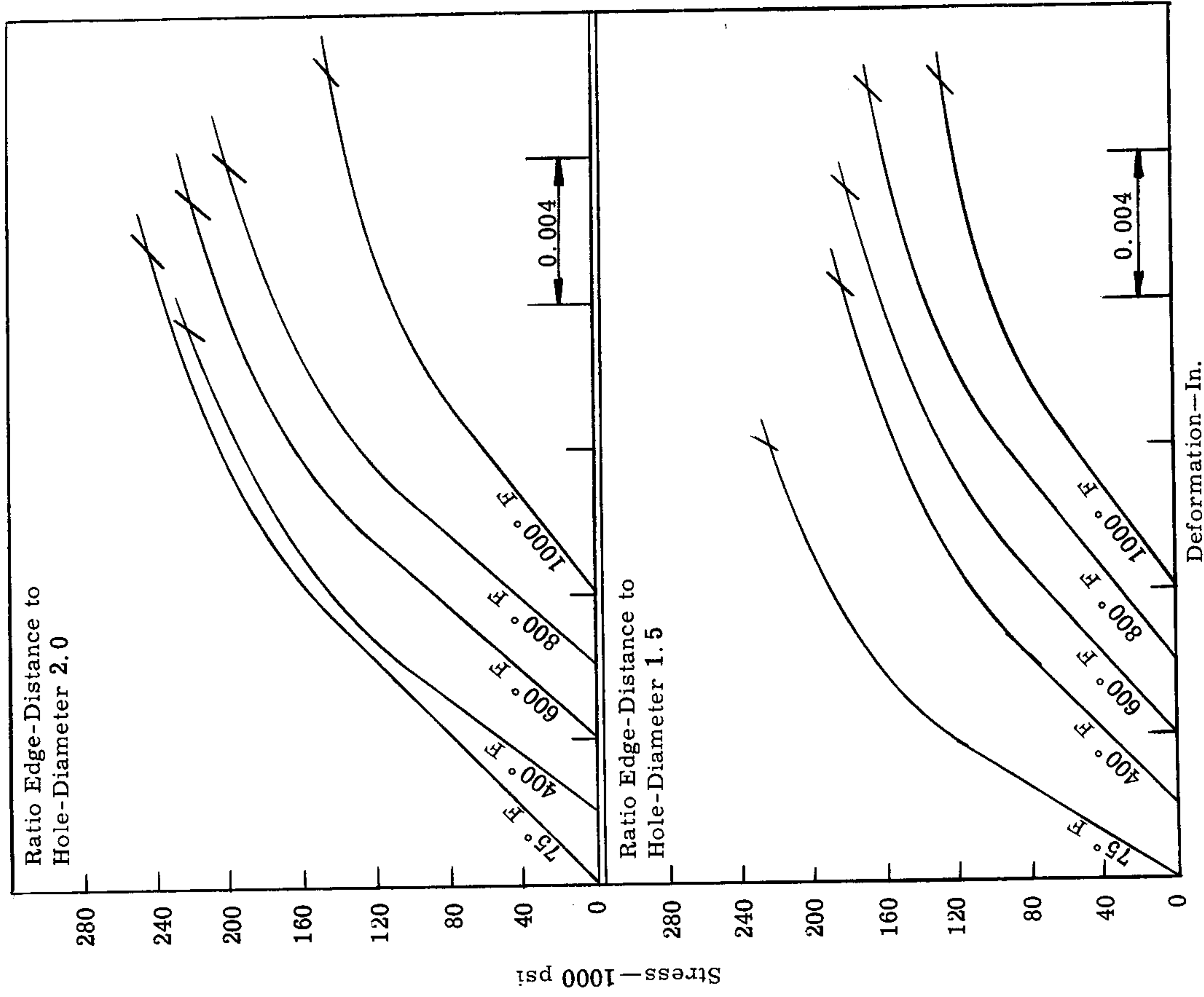

Fig. 113. Bearing stress-deformation curves for quenched and tempered Type 422 stainless steel sheet at various temperatures and one-hundred-hour exposure time.

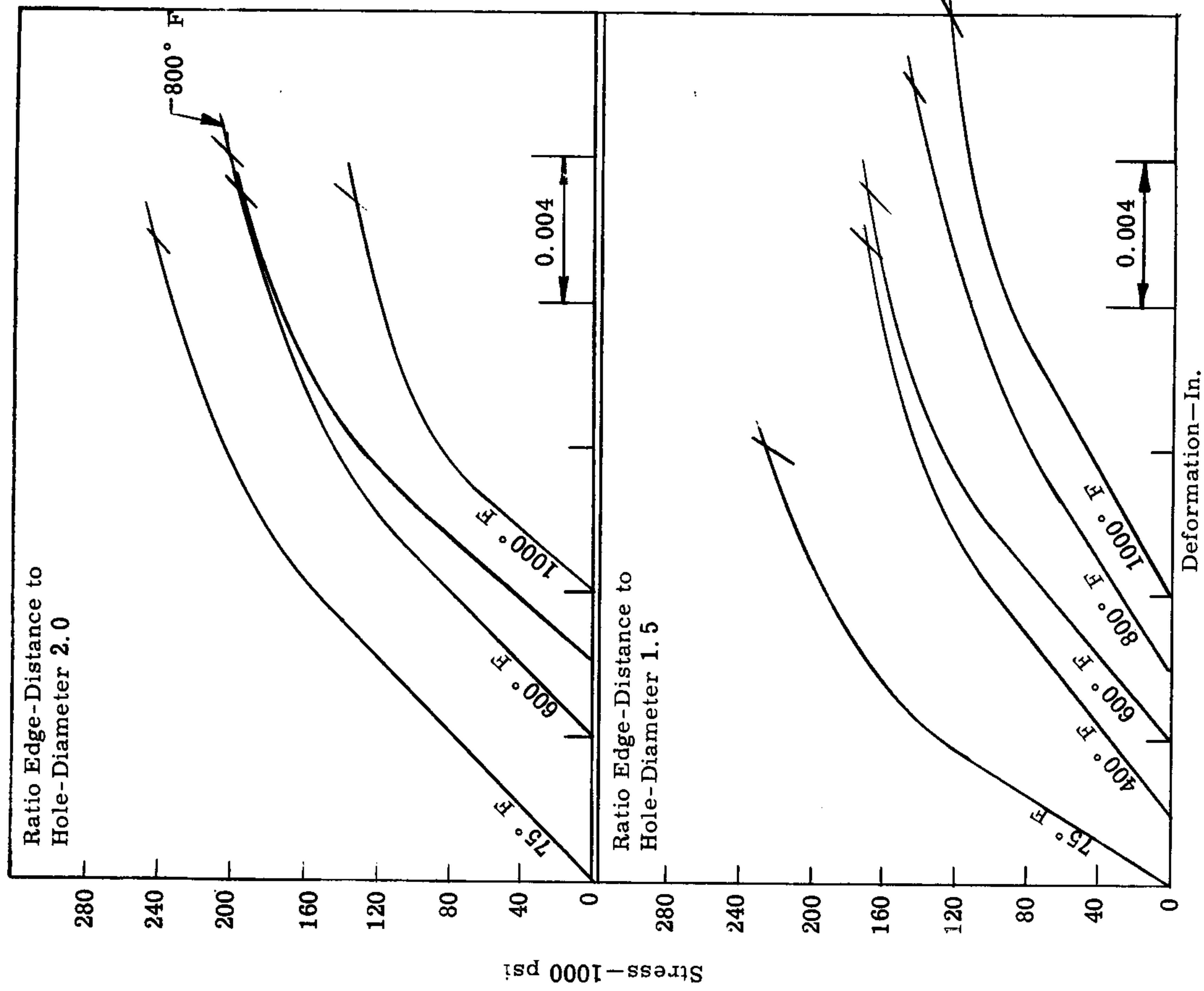

Fig. 114. Bearing stress-deformation curves for quenched and tempered Type 422 stainless steel sheet at various temperatures and one-thousand-hour exposure time.

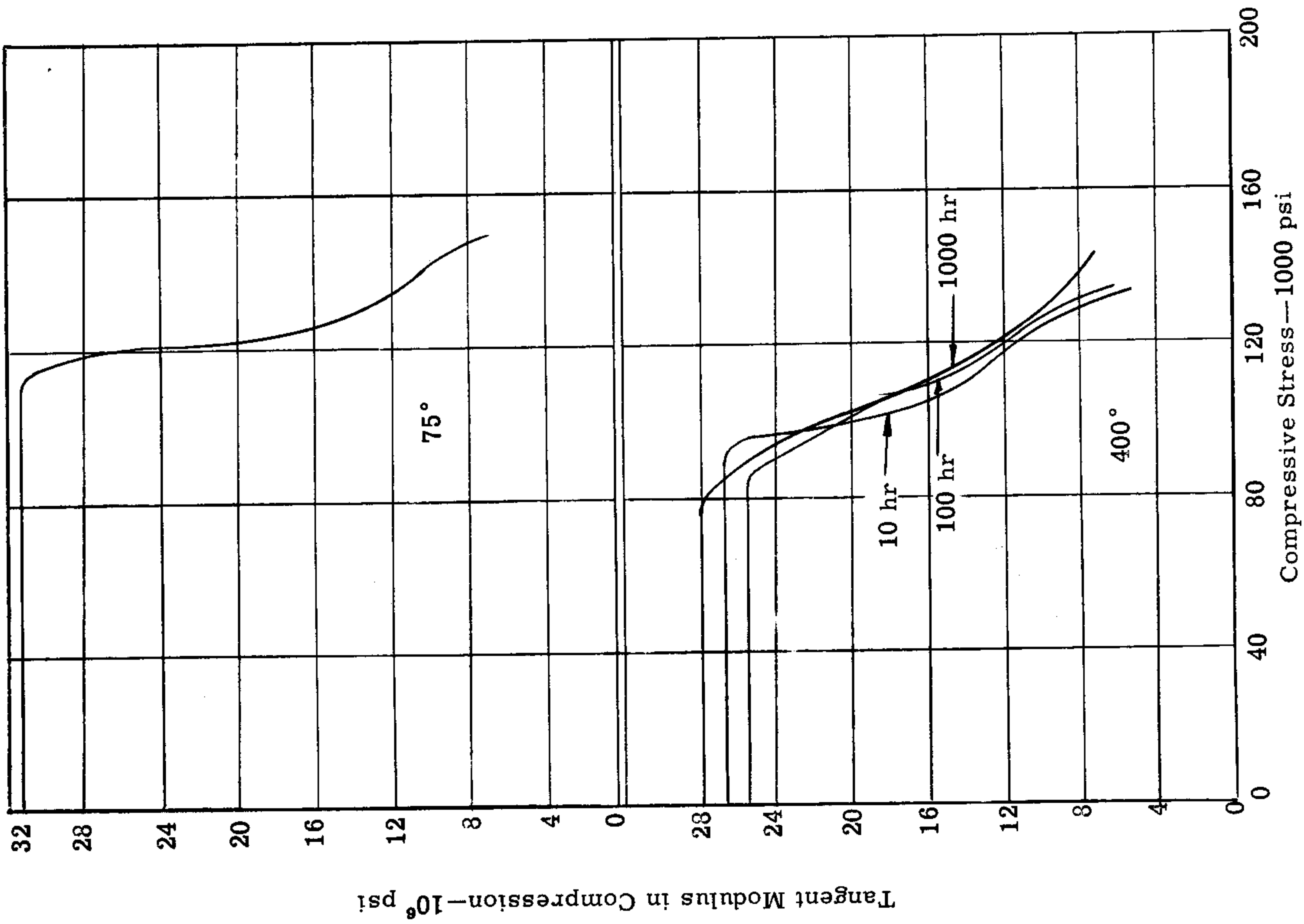

Fig. 115. Tangent-modulus vs. compressive-stress curves for quenched and tempered Type 422 stainless steel sheet at 75° F and 400° F and different exposure times.

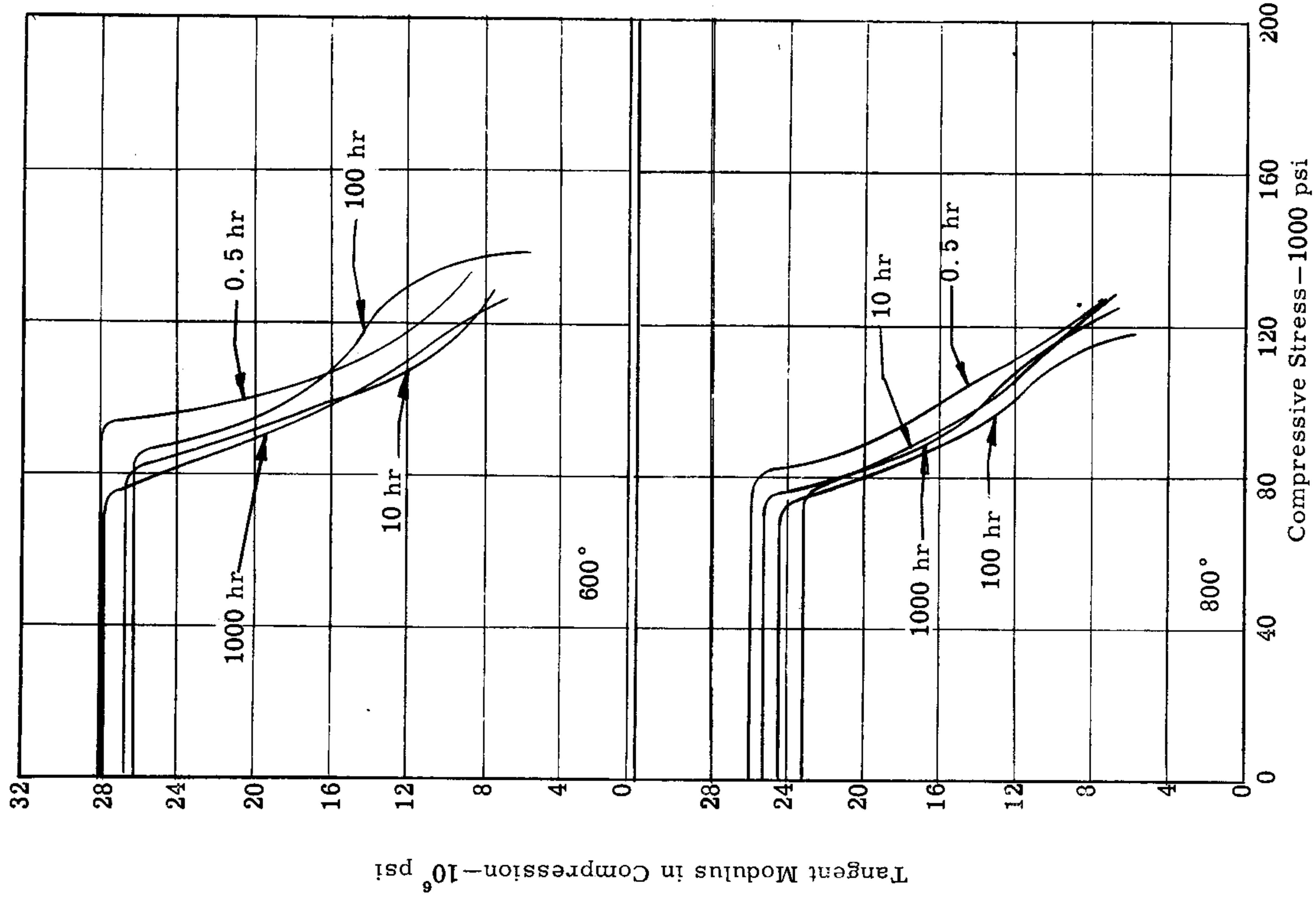

Fig. 116. Tangent-modulus vs. compressive-stress curves for quenched and tempered Type 422 stainless steel sheet at 600° F and 800° F and different exposure times.

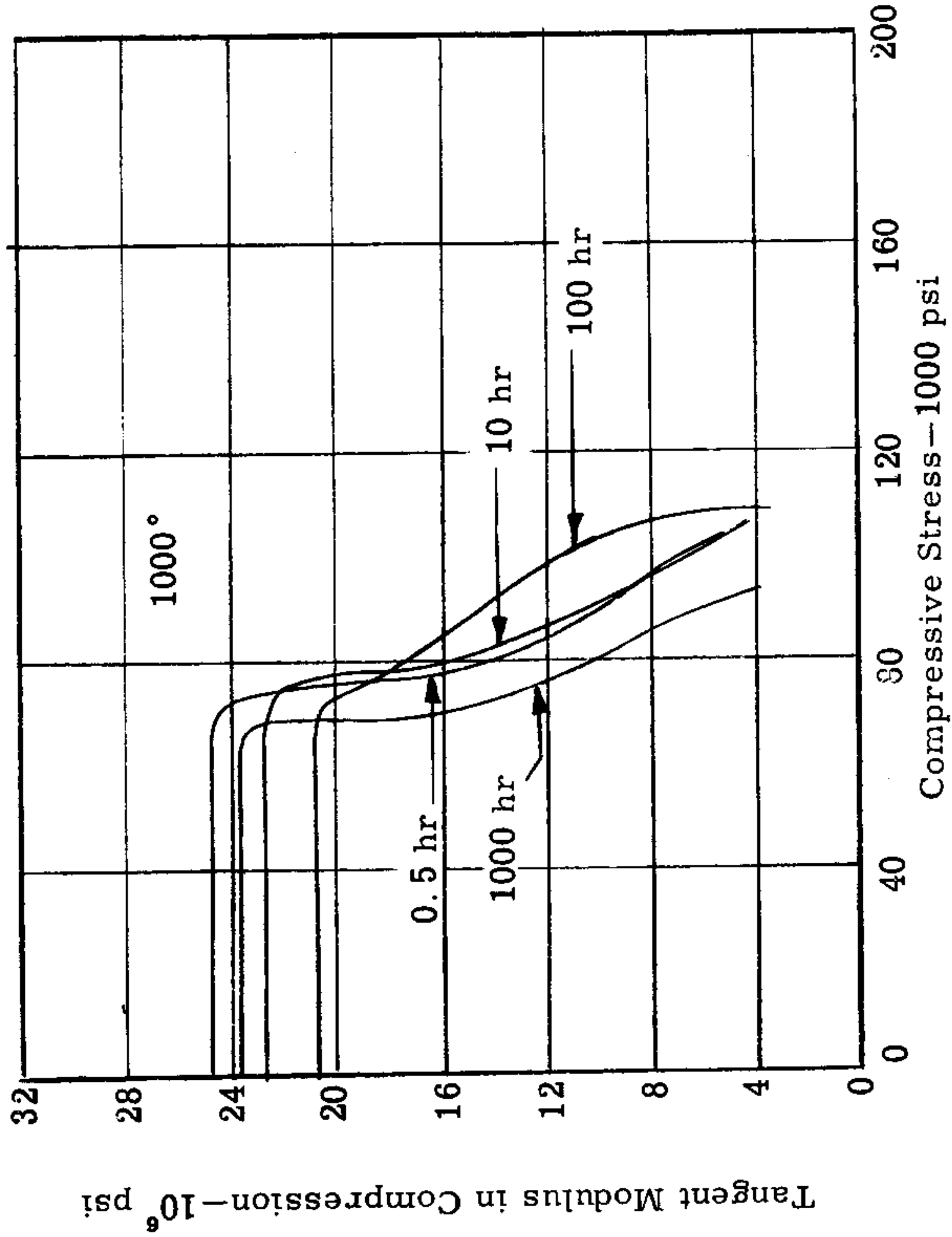

Fig. 117. Tangent-modulus vs. compressive-stress curves for quenched and tempered Type 422 stainless steel sheet at 1000° F and different exposure times.

Temp °F	Holding Time, hr	YS 1000 psi	UTS 1000 psi	ME 10 ⁶ psi	Elong. %	Hardi R45N	RS ² 1000 psi	RS ³ 1000 psi
RT		130.2	162.0	30.6	6	35	119.0	201.0
		139.5	160.0	30.0	5	35	118.5	206.0
		145.0	154.0	30.3	9	36	117.0	204.0
Avg		138.2	158.7	30.3	7	35	118.2	203.7
400	0.5	122.0	143.4	28.4	5	36	105.5	182.5
		128.0	147.0	27.7	6	37	110.0	195.5
		132.0	151.0	29.6	6	37	116.5	200.5
Avg		127.3	147.1	28.5	6	37	110.6	192.8
400	10	145.0	141.3					
		142.0	137.0					
Avg		141.3						
400	100	113.5	140.0	23.4	6	32	111.0	216.0
		116.4	141.0	25.7	6	33	107.0	201.0
		117.5	143.5	26.0	6	33	108.3	232.5
Avg		115.8	141.5	25.0	6	33	108.7	216.5
400	1000	111.6	138.6	24.3	7	35	104.4	215.0
		119.3	143.6	25.6	7	35	106.8	214.0
		129.5	147.5	25.8	7	35	117.0	269.0
Avg		120.1	143.2	25.2	7	35	109.4	232.6

Tensile Properties of 0.062-In. Type 422 Stainless Steel Sheet at Different Temperatures and Holding Times

Table 28

208

WADC TR 58-365

Tensile Properties of 0.062-In. Type 422 Stainless Steel¹ Sheet at Different Temperatures and Holding Times

Temp °F	Holding Time, hr	YS 1000 psi	UTS 1000 psi	ME 10 ³ psi	Elong. %	Hard ¹ R45N	RS ₂ 1000 psi	RS ₃ 1000 psi
600	0.5	113.5	138.0	30.3	6	40	110.5	309.0
		109.5	139.5	25.6	5	42	109.5	298.0
Avg		111.9	139.5	25.6	6	41	118.0	276.0
		111.6	139.0	27.2	6	41	112.7	294.3
600	10	105.0	137.0	29.0	5	35	112.0	197.5
		120.0	141.0	-	7	38	111.9	300.0
Avg		112.0	137.0	27.7	5	40	108.5	210.0
		112.3	138.3	28.3	6	38	110.8	235.8
600	100	111.2	138.0	24.5	5	35	104.5	228.0
		106.2	138.8	31.6	5	38	113.5	247.0
Avg		101.0	139.0	25.3	5	35	114.0	242.0
		106.3	138.6	27.1	5	36	110.7	239.0
600	1000	115.0	138.5	25.4	5	36	115.8	188.6
		118.2	144.0	24.5	6	35	111.2	254.5
Avg		111.5	140.0	24.3	4	38	117.0	229.0
		114.9	140.1	24.7	5	36	114.7	224.0
800	0.5	113.0	133.0	23.0	8	35	103.0	215.0
		102.5	130.0	23.4	8	36	94.6	189.5
Avg		102.0	132.0	24.5	8	36	97.6	192.0
		105.8	131.7	23.6	8	36	98.4	198.8

209

WADC TR 58-365

Temp ° F	Holding Time, hr	Different Temperatures of 0.062-In. Type 422 Stainless Steel Sheet at						
		YS 1000 psi	UTS 1000 psi	ME 10 ⁶ psi	Elong. %	Hard ¹ R45N	RS ² 1000 psi	RS ³ 1000 psi
800	10	101.0	131.0	25.6	7	36	101.0	244.0
		102.0	131.5	23.9	7	35	100.3	179.0
Avg	800	99.2	131.0	25.0	7	36	100.1	178.0
		94.5	130.5	25.4	8	36	99.0	200.3
800	100	102.5	130.5	26.8	7	38	102.5	228.0
		105.8	133.0	23.1	7	40	105.8	203.0
Avg	800	103.4	131.2	24.9	7	39	102.4	229.0
		102.0	130.0	24.7	7	40	99.0	220.0
800	1000	108.0	127.0	27.3	5	38	100.5	153.0
		102.0	127.5	21.7	6	37	97.5	177.0
Avg	1000	105.0	129.0	22.5	7	37	97.5	178.0
		105.0	127.8	23.8	6	37	98.5	169.3
1000	0.5	95.0	101.0	19.8	13	36	67.3	140.0
		88.5	105.0	22.2	12	37	64.0	135.0
Avg	1000	90.2	104.0	23.9	10	36	64.0	116.0
		86.2	98.2	27.5	11	39	69.6	130.3
1000	10	84.2	97.0	28.6	9	37	60.5	129.5
		84.7	100.0	-	10	37	61.8	135.0
Avg	1000	85.0	98.4	28.0	10	38	64.0	138.7

Table 28 (continued)
Tensile Properties of 0.062-In. Type 422 Stainless Steel Sheet at Different Temperatures and Holding Times

WADC TR 58-365

210

Table 28 (continued)
 Tensile Properties of 0.062-In. Type 422 Stainless Steel Sheet at Different Temperatures and Holding Times

Temp °F	Holding Time, hr	YS 1000 psi	UTS 1000 psi	ME 10 ⁶ psi	Elong. %	Hard ¹ R45N	RS ² 1000 psi	RS ³ 1000 psi
1000	100	81.4	91.8	18.5	11	34	57.5	142.5
		85.2	92.8	23.4	9	34	59.0	113.0
		82.8	94.2	24.6	10	36	66.7	152.0
Avg		83.1	92.9	22.2	10	35	61.1	135.8
1000	1000	79.8	85.5	26.3	14	34	62.9	136.0
		81.7	90.7	26.3	17	35	62.5	134.5
		87.5	100.5	28.1	12	35	77.7	147.5
Avg		83.0	92.2	26.9	14	35	67.7	139.3

1. Hardness determinations made at room temperature after tests.
2. Rupture strength based on original cross section.
3. Rupture strength based on final cross section.
4. Heat treatment - 1900° F 15 min argon atmosphere, O.Q., 1000° F 2 hr, A. C.

WADC TR 58-365 211

Tensile Strength of 3/16-In. Type 422 Stainless Steel Plate at Different Temperatures and Holding Times

Holding Time, hr	Temp ° F	1/2		10		100		1000	
		UTS ¹ 1000 psi	Hard ² RC	UTS 1000 psi	Hard RC	UTS 1000 psi	Hard RC	UTS 1000 psi	Hard RC
RT		174.5	37	166.0	39	172.0	39	170.0	38
		173.5	36	169.0	39	168.5	40	169.5	38
		173.6	37	173.0	39	169.0	39	170.5	38
	Avg	173.9	37	169.3	39	169.8	39	170.0	38
		164.0	36	167.5	37	170.0	37	167.0	40
400		167.0	36	167.0	37	170.0	36	169.0	38
		166.0	37	167.5	37	168.0	37	168.0	39
		166.0	37	167.5	37	173.0	37	168.0	39
	Avg	165.8	36	167.4	37	170.2	37	168.0	39
		145.0	37	151.0	37	151.0	37	150.2	38
600		154.0	38	153.0	37	152.5	37	153.0	37
		155.5	37	151.0	37	151.5	38	152.0	37
		153.8	37	151.5	37	153.0	38	152.0	38
	Avg	152.1	37	151.6	37	152.0	38	151.7	38
		152.1	37	151.6	37	152.0	38	151.7	38

Table 29

WADC TR 58-365

212

Table 29 (continued)
 Tensile Strength of 3/16-In. Type 422 Stainless Steel¹ Plate at
 Different Temperatures and Holding Times

Holding Time, hr	Temp °F	1/2		10		100		1000	
		UTS ¹ 1000 psi	Hard ² RC	UTS 1000 psi	Hard RC	UTS 1000 psi	Hard RC	UTS 1000 psi	Hard RC
1000		115.0	40	113.4	38	100.5	39	97.00	36
		111.2	36	112.3	37	104.0	38	94.00	37
		111.2	38	112.2	38	102.5	36	99.00	37
Avg		112.5	38	113.3	38	102.3	38	96.67	37

1. Ultimate tensile strength.
 2. Hardness determinations made at room temperature after tests.
 3. Heat treatment - 1900° F 15 min argon atmosphere, O. Q., 1000° F 2 hr, A. C.

1. Ultimate tensile strength:
2. Hardness determinations made
3. Heat treatment - 1900° F 15 min

AVG 213

Table 30 (continued)
 Compressive Properties of 0.062-In. Type 422 Stainless Steel Sheet at
 Different Temperatures and Holding Times

Hold. Time hr	1/2		10		100		1000	
	CYS ¹ ME 10 ⁶ psi	Hard ² R45N	CYS ME 10 ⁶ psi	Hard R45N	CYS ME 10 ⁶ psi	Hard R45N	CYS ME 10 ⁶ psi	Hard R45N
Avg	100.9	35	108.0	37	103.8	37	91.0	35
1000	96.2	34	107.0	37	109.0	37	88.2	36
	104.2	35	106.0	37	100.0	38	93.5	34
	102.2	37	111.0	37	101.5	37	91.3	36
	23.6	35	22.8	37	20.9	37	22.8	35

1. Compressive yield strength
2. Hardness determinations made at room temperature after tests.
3. Heat treatment — 1900° F 15 min argon atmosphere, O.Q., 1000° F 2 hr, A. C.

Table 31
 Shear Strength of 3/16-In. Type 422 Stainless Steel Plate at
 Different Temperatures and Holding Times

Holding Time, hr	Temp ° F	1/2		10		100		1000	
		USS ¹ 1000 psi	Hard ² RC	USS 1000 psi	Hard RC	USS 1000 psi	Hard RC	USS 1000 psi	Hard RC
RT		98.8	33	100.1	36	118.0	39	118.0	39
	Avg					115.0	37	115.0	37
						113.0	36	113.0	36
400		99.2	33	102.5	37	102.5	32	102.5	32
	Avg					99.5	33	99.5	33
						101.0	35	101.0	35
600		99.50	34	98.25	29	103.5	39	103.5	39
	Avg					98.8	33	98.8	33
						102.0	34	102.0	34
800		95.50	35	94.40	34	92.30	37	92.30	37
	Avg					95.40	31	95.40	31
						95.50	35	95.50	35

216

WADC TR 58-365

Table 31 (continued)
 Shear Strength of 3/16-In. Type 422 Stainless Steel³ Plate at
 Different Temperatures and Holding Times

Holding Time, hr	Temp ° F	1/2		10		100		1000	
		USS ¹ 1000 psi	Hard ² RC	USS 1000 psi	Hard RC	USS 1000 psi	Hard RC	USS 1000 psi	Hard RC
1000	Avg	77.70	35	75.70	37	82.20	34	75.00	31
		78.00	36	74.20	34	78.70	32	73.30	34
		77.30	36	76.80	37	81.40	35	73.50	33
		77.67	36	75.57	36	80.77	34	73.93	33

1. Ultimate shear strength.
2. Hardness determinations made at room temperature after tests.
3. Heat treatment - 1900° F 15 min argon atmosphere, O. Q., 1000° F, 2 hr, A. C.

Bearing Properties⁴ of 0.062-In. Type 422 Stainless Steel⁵ Sheet at Different Temperatures and Holding Times

Table 32

Hold. Time hr	Temp °F	1/2		10		100		1000	
		BYS ¹	UBS ²	BYS	UBS	BYS	UBS	BYS	UBS
		Hard ³	R45N	Hard	R45N	Hard	R45N	Hard	R45N
RT		254.0	37	223.0	37	223.0	37	254.0	37
	Avg	253.0	37	233.0	37	225.0	37	251.0	37
		251.0	37	227.0	37	227.0	37	252.7	37
		221.0	37	162.0	37	196.0	37	221.0	37
400		186.0	38	203.0	38	200.0	38	186.0	38
	Avg	209.0	37	229.0	37	183.0	39	221.0	37
		226.0	38	234.0	38	230.0	39	223.7	37
		232.0	38	227.0	39	193.0	39	229.0	37
600		174.0	39	174.0	38	171.0	38	170.0	39
	Avg	186.0	39	215.0	39	180.0	39	217.0	39
		218.0	40	209.0	39	180.0	39	219.0	40
		177.0	39	191.0	39	171.0	38	217.0	39
800		144.5	40	165.5	37	179.0	39	145.5	39
	Avg	179.0	39	174.5	39	181.7	38	169.0	39
		212.0	38	164.0	39	162.0	38	151.0	37
		165.0	38	209.0	39	223.0	38	207.0	39
Avg		154.7	39	161.8	38	167.2	38	148.2	38
		212.0	39	212.0	39	220.0	38	209.0	39
		212.0	39	212.0	39	223.0	38	207.0	37
		212.0	39	212.0	39	220.0	38	209.0	39

218

WADC TR 58-365

Bearing Properties⁴ of 0.062-In. Type 422 Stainless Steel⁵ Sheet at Different Temperatures and Holding Times

Table 32 (continued)

Hold. Time	Temp °F	1/2		10		100		1000		Avg
		BYS ¹	UBS ²	BYS	UBS	BYS	UBS	BYS	UBS	
hr	°F	1000 psi		1000 psi		1000 psi		1000 psi		
		Hard ³	R45N	Hard	R45N	Hard	R45N	Hard	R45N	
		141.0	156.0	134.0	159.0	126.0	150.0	124.0	142.8	35
		137.0	164.0	132.0	159.0	130.5	153.0	122.0	142.0	35
		141.0	153.0	138.0	158.5	123.3	152.5	123.0	140.0	36
		139.7	157.7	134.7	158.8	126.6	151.8	123.0	141.6	35

1. Bearing yield strength.
2. Ultimate bearing strength.
3. Hardness determinations made at room temperature after tests.
4. Edge-distance to hole-diameter ratio 1.5
5. Heat treatment - 1900° F 15 min argon atmosphere, O. Q., 1000° F 2 hr, A. C.

Bearing Properties* of 0.062-In. Type 422 Stainless Steel¹ Sheet at Different Temperatures and Holding Times

Hold. Time hr	Temp °F	1/2		10		100		1000	
		BYS ¹	UBS ²	BYS	UBS	BYS	UBS	BYS	UBS
		1000 psi		1000 psi		1000 psi		1000 psi	
		R45N		R45N		R45N		R45N	
		Hard ³		Hard		Hard		Hard	
RT	38	330.0	331.0	328.0	329.7	330.0	331.0	328.0	329.7
	36	256.0	256.0	242.0	246.3	184.0	181.5	180.5	185.3
400	39	197.0	194.0	181.5	184.0	303.0	303.0	310.0	303.0
	38	285.0	285.0	297.0	219.0	256.0	219.0	289.0	229.0
Avg		194.0	199.0	285.0	285.0	212.0	229.0	301.0	304.7
		206.0	285.0	289.0	296.3	180.5	185.3	301.0	304.7
600	39	203.0	285.0	191.0	297.0	220.5	279.0	194.0	284.0
	36	283.0	283.0	300.0	236.0	279.0	279.0	210.0	273.0
Avg		197.0	281.0	294.0	184.0	276.0	276.0	188.0	273.0
		200.0	283.0	297.0	213.5	278.0	278.0	197.3	276.7
800	41	197.0	273.0	188.0	267.0	194.0	266.0	197.0	273.0
	43	190.0	266.0	202.0	282.0	201.5	269.0	206.0	270.0
Avg		197.0	274.0	234.0	280.0	206.0	273.0	203.0	274.0
		194.7	271.0	208.0	276.3	200.5	269.3	202.0	272.3

220

WADC TR 58-365

Table 33

Table 33 (continued)
Bearing Properties¹ of 0.062-In. Type 422 Stainless Steel Sheet at
Different Temperatures and Holding Times

Hold. Time hr	Temp ° F	1/2		10		100		1000		Avg
		BYS ¹ 1000 psi	UBS ² R45N	BYS 1000 psi	UBS R45N	BYS 1000 psi	UBS R45N	BYS 1000 psi	UBS R45N	
		164.0	202.0	158.0	200.0	154.0	194.0	139.5	174.0	164.0
		171.5	213.0	164.0	202.0	142.0	185.0	133.0	173.0	157.0
		157.0	215.0	153.0	193.0	-	189.0	133.0	173.0	157.0
		164.0	210.0	158.3	198.3	148.0	189.3	135.0	173.3	164.0

1. Bearing yield strength.
2. Ultimate bearing strength.
3. Hardness determinations made at room temperature after tests.
4. Edge-distance to hole-diameter ratio 2.0.
5. Heat treatment - 1900° F 15 min argon atmosphere, O. Q., 1000° F 2 hr, A. C.

10.6 17-22 A (S) Alloy Steel Sheet, Quenched and Tempered

Contrails

WADC TR 58-365

222

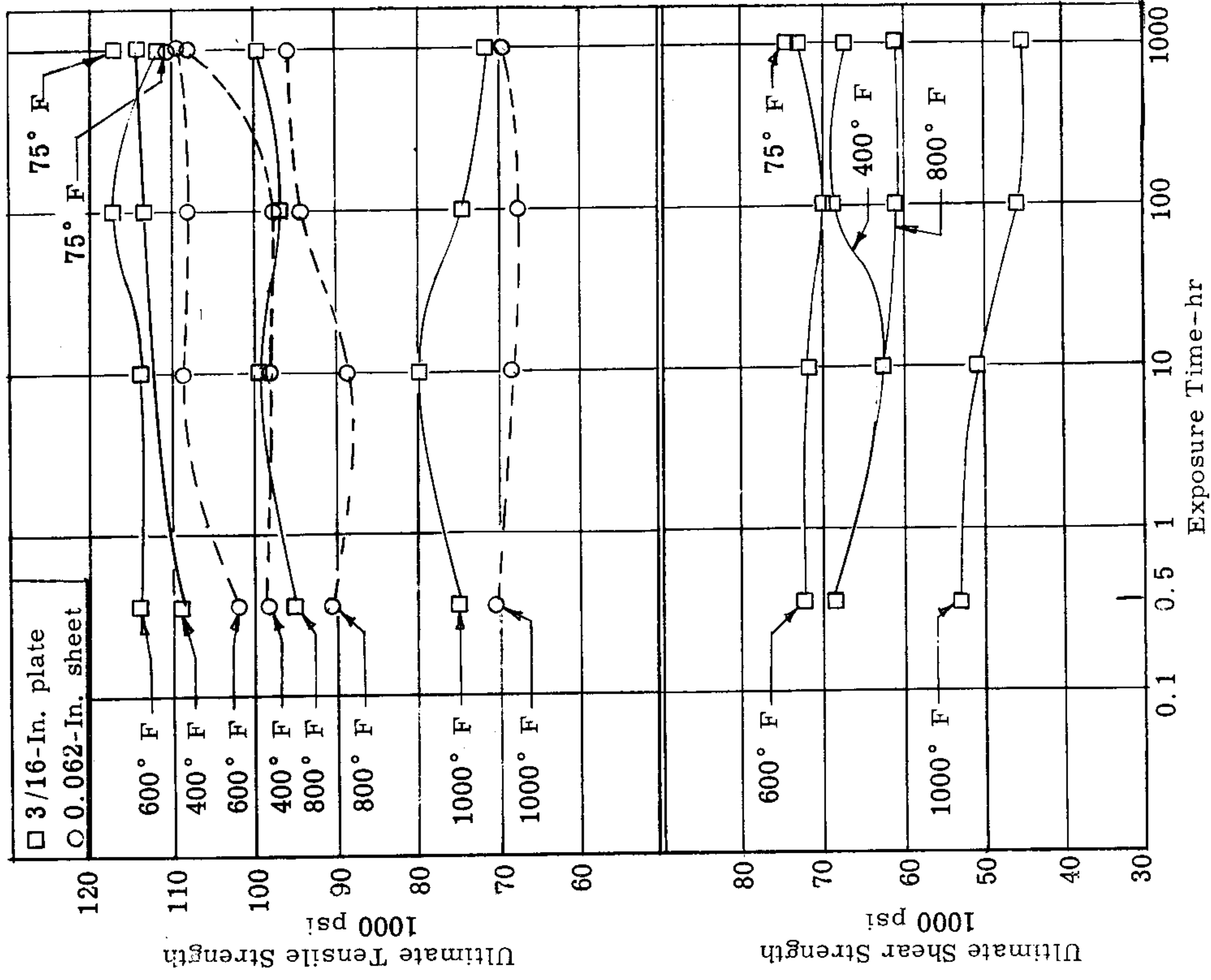

Fig. 118. Effect of exposure time on the ultimate tensile strength and ultimate shear strength of quenched and tempered 17-22 A (S) alloy steel at different temperatures.

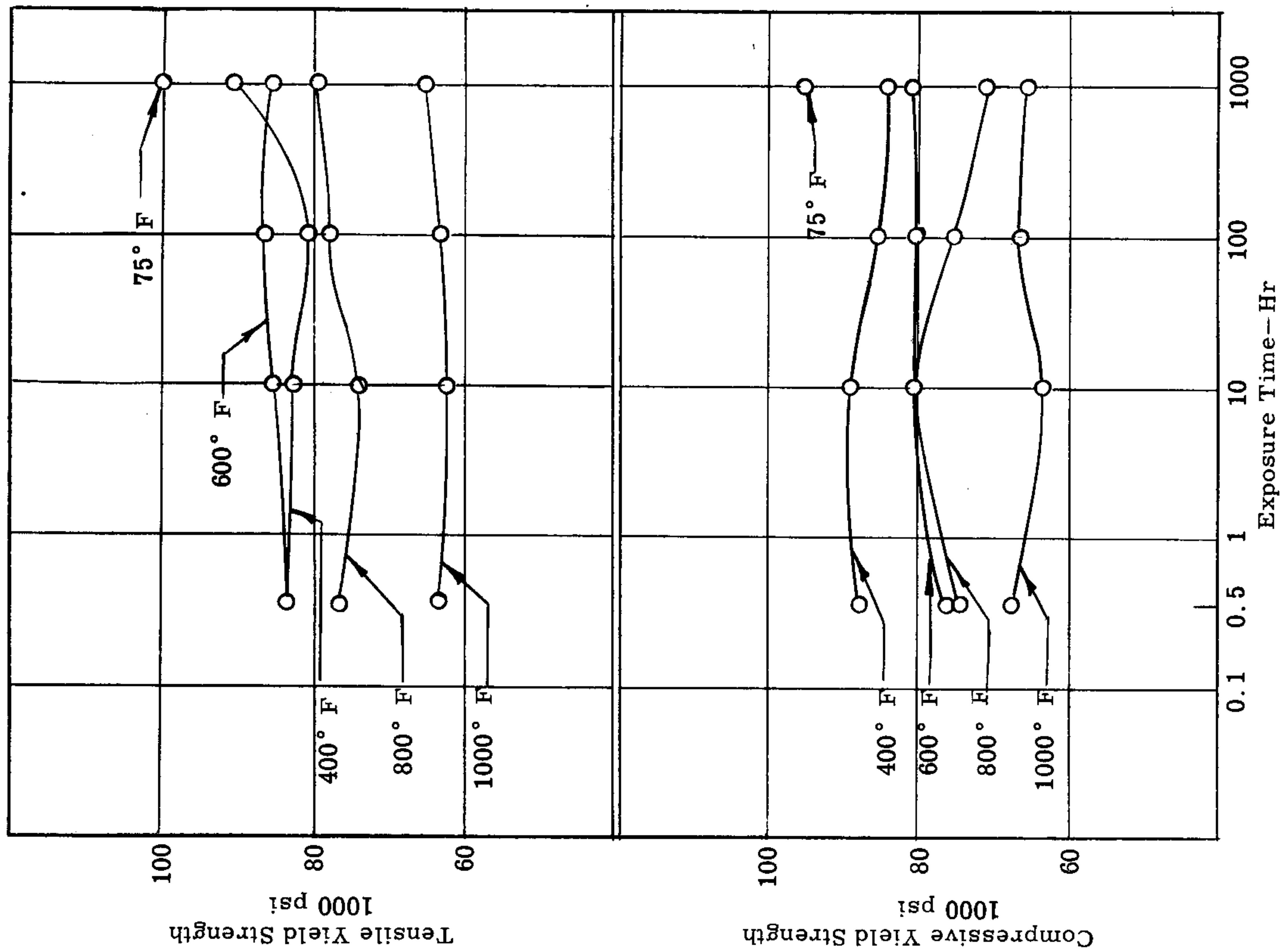

Fig. 119. Effect of exposure time on the tensile and compressive yield strength of quenched and tempered 17-22 A (S) alloy steel sheet at different temperatures.

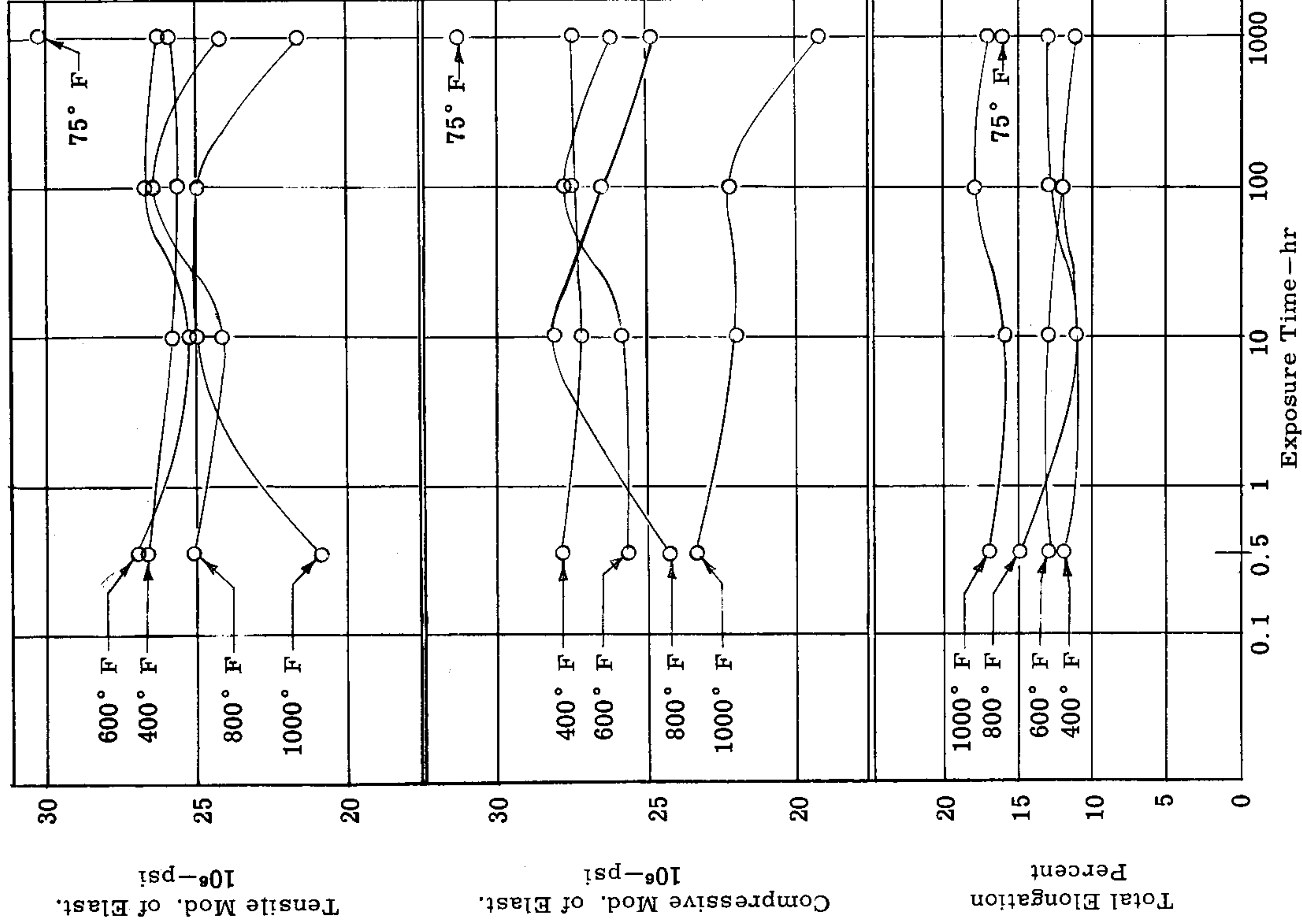

Fig. 120. Effect of exposure time on the tensile and compressive moduli of elasticity and percent elongation of quenched and tempered 17-22 A (S) alloy steel sheet at different temperatures.

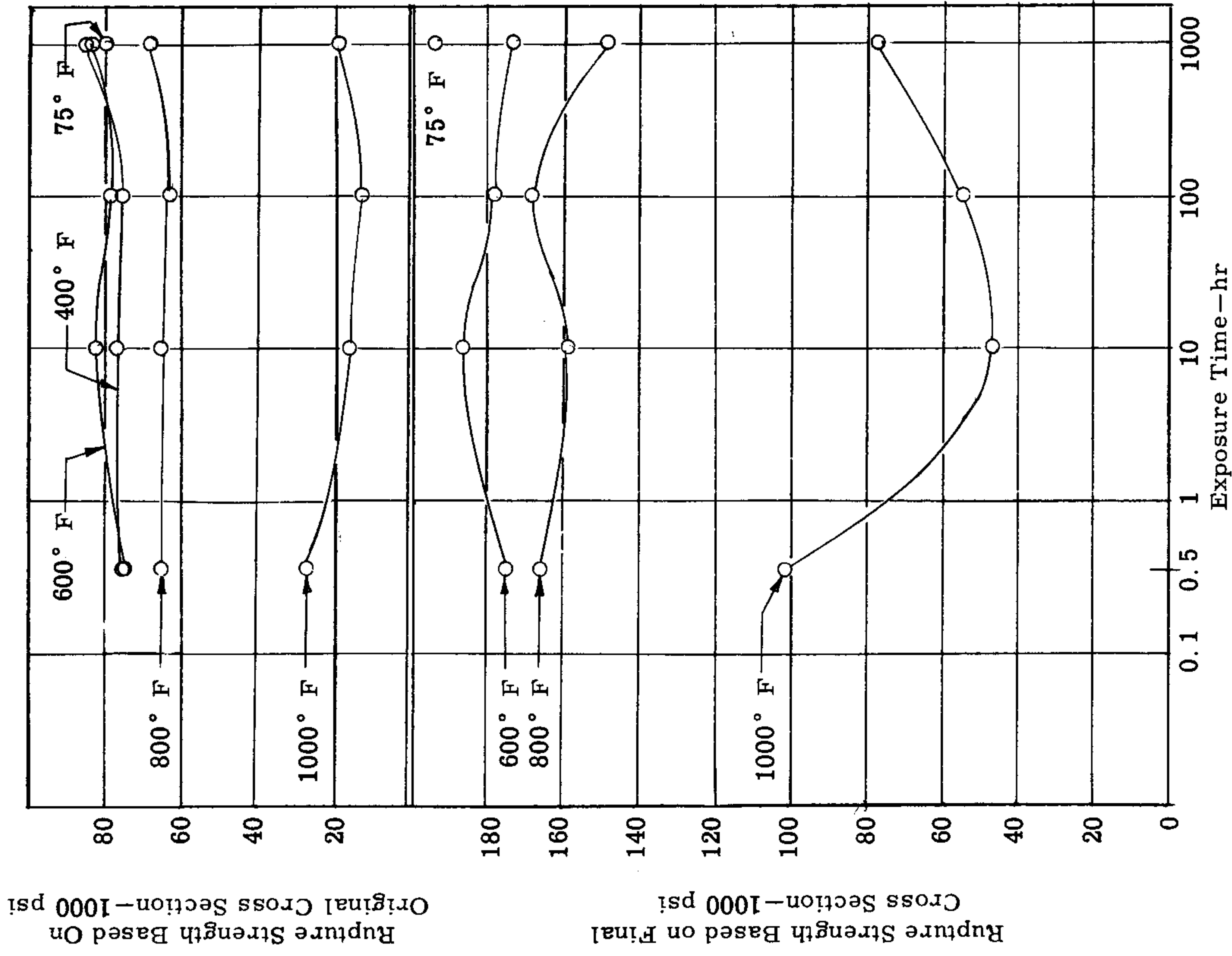

Fig. 121. Effect of exposure time on the tensile rupture strength of quenched and tempered 17-22 A (S) alloy steel sheet at different temperatures.

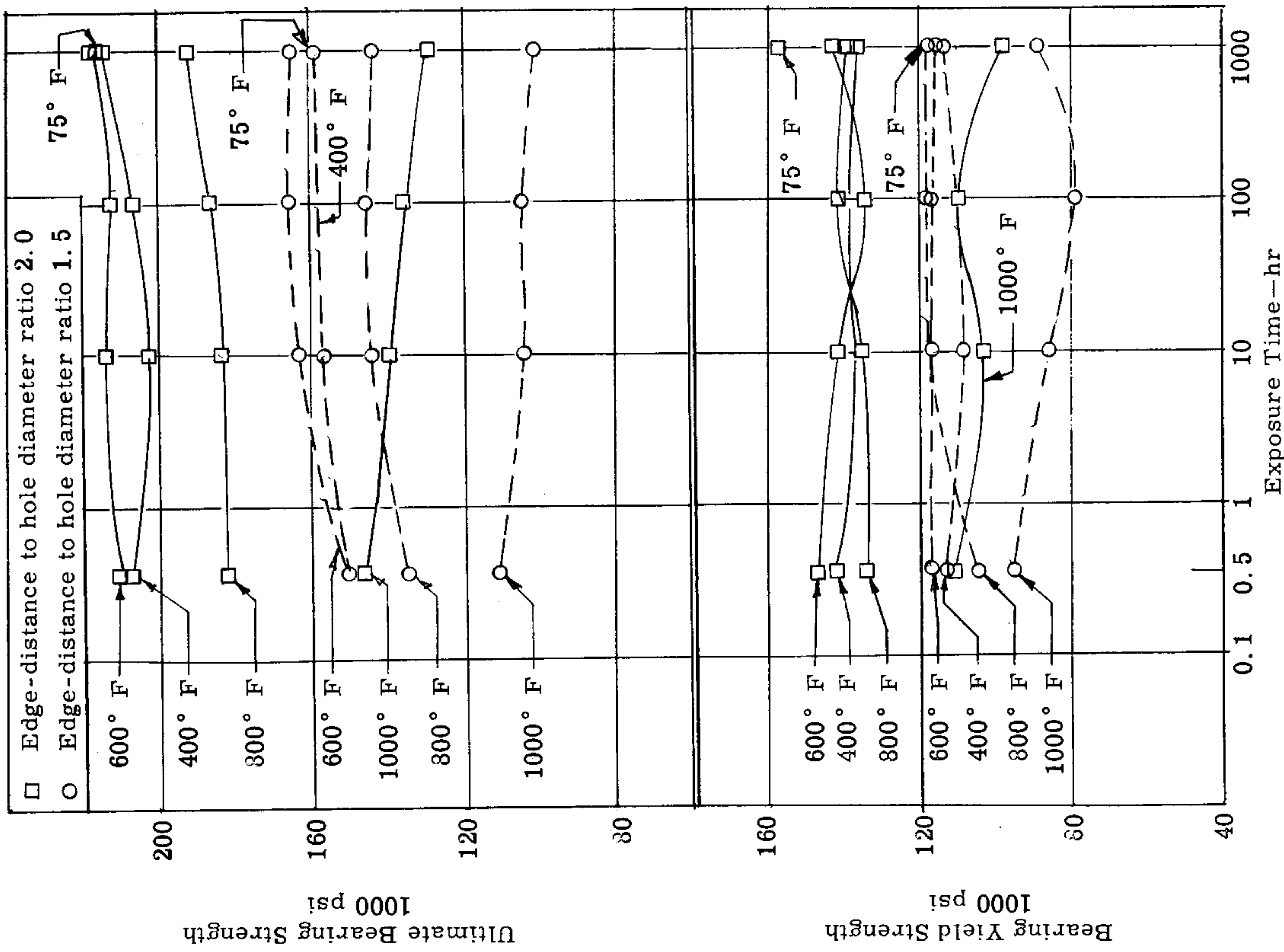

Fig. 122. Effect of exposure time on the bearing ultimate and yield strengths of quenched and tempered 17-22 A (S) alloy steel sheet at different temperatures.

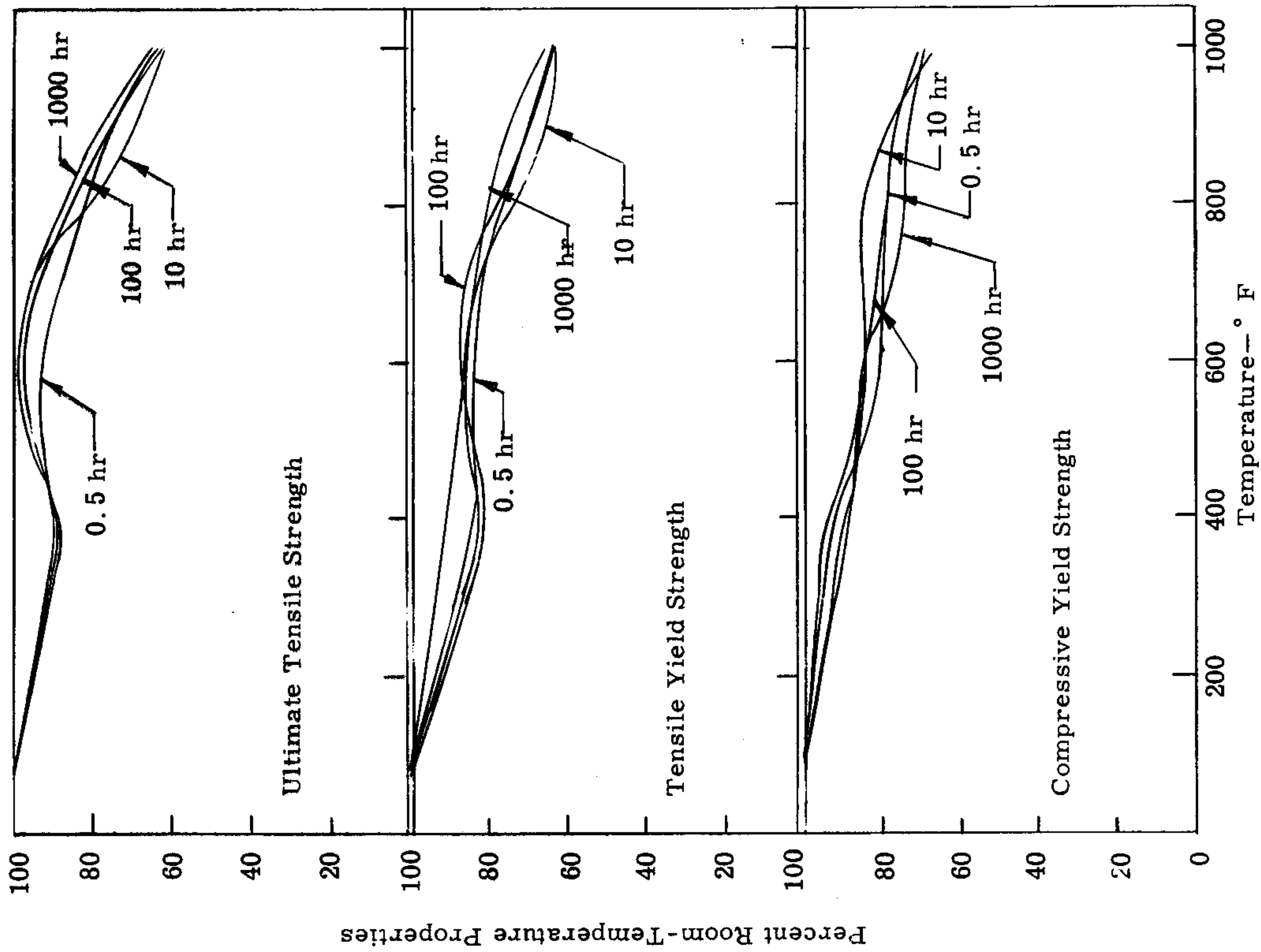

Fig. 123. Elevated-temperature strength properties as per cent of room-temperature properties for quenched and tempered 17-22 A (S) alloy steel sheet at different exposure times.

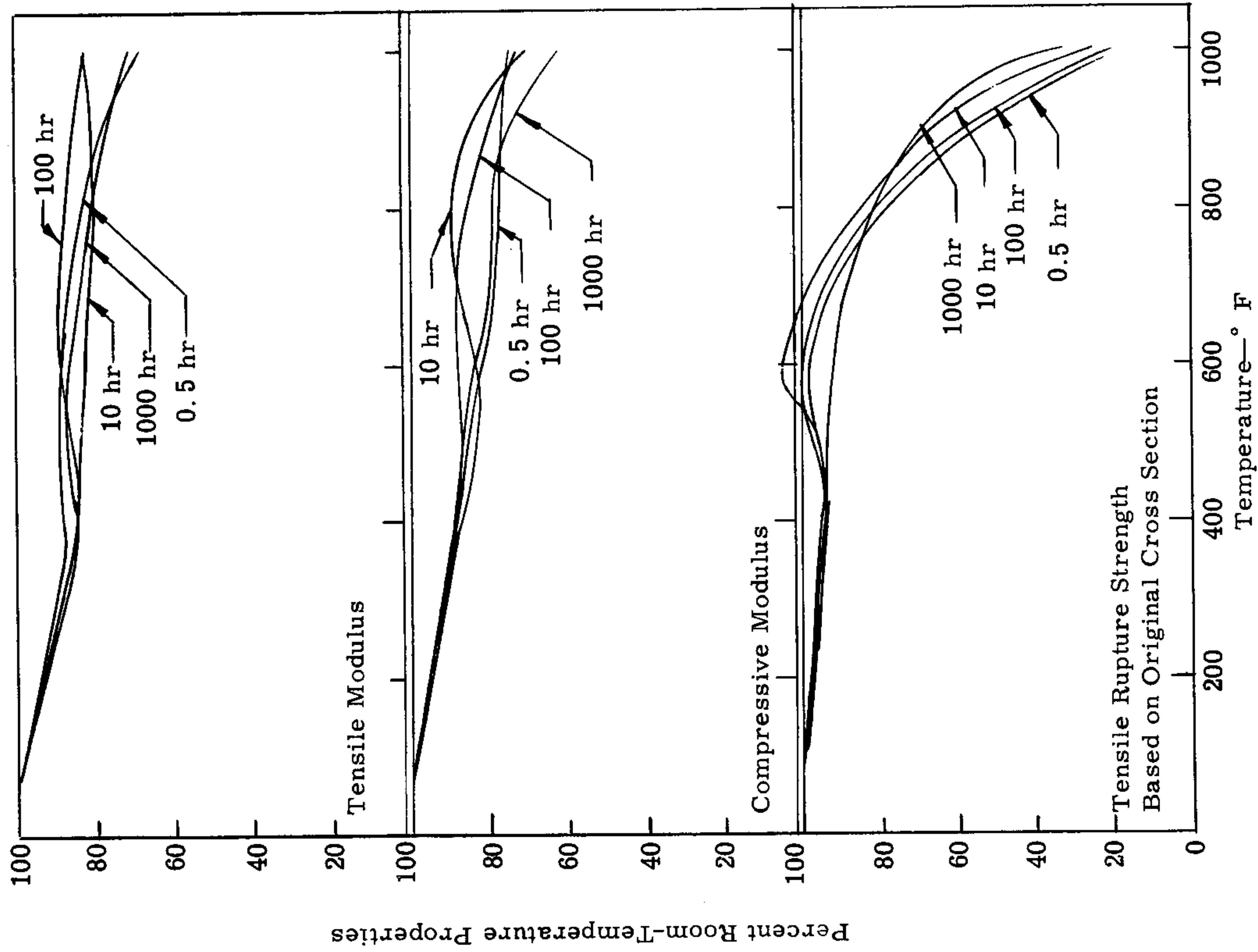

Fig. 124. Elevated-temperature properties as percent of room-temperature properties for quenched and tempered 17-22 A (S) alloy steel sheet at different exposure times.

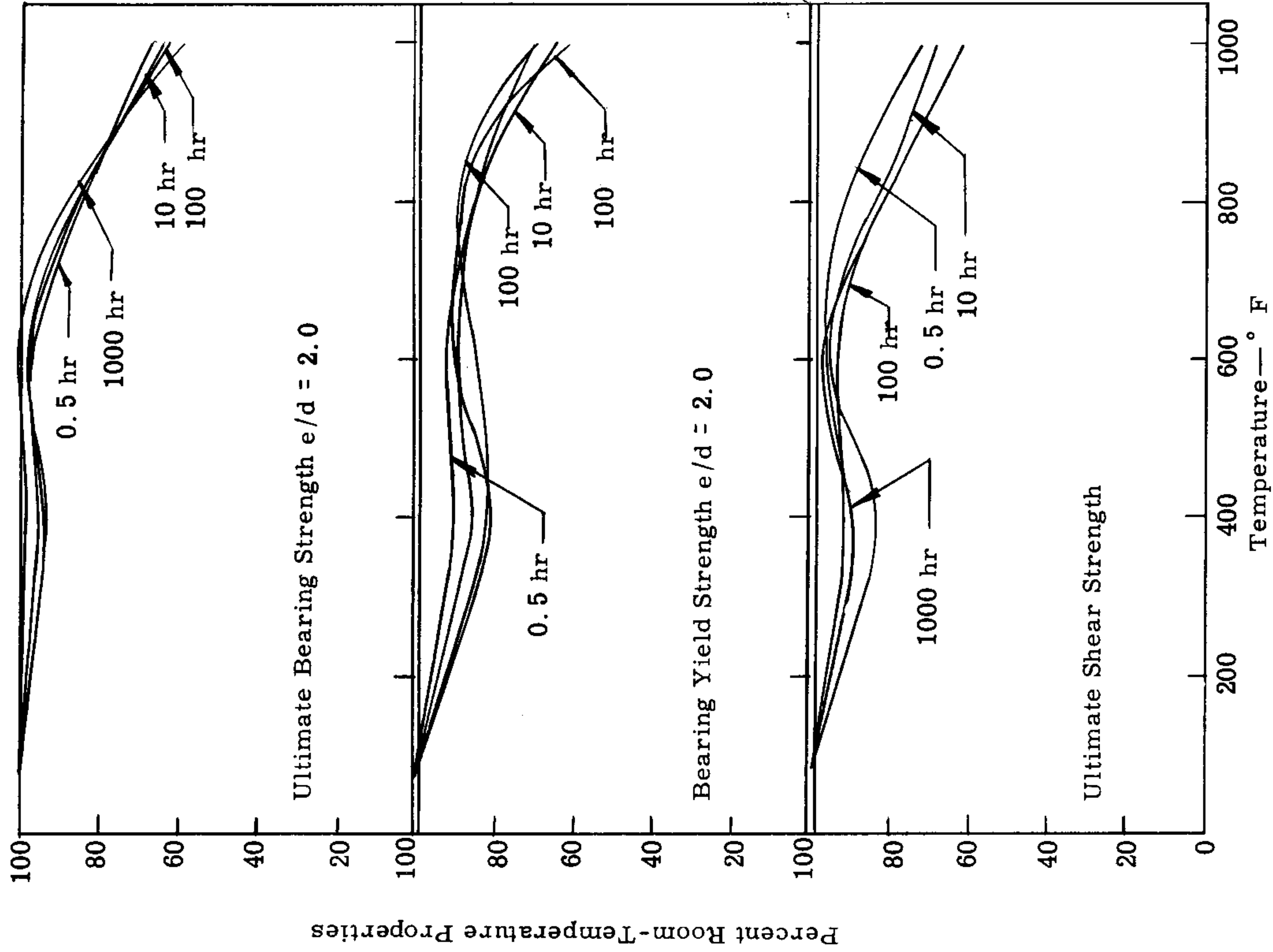

Fig. 125. Elevated-temperature strength properties as percent of room temperature properties for quenched and tempered 17-22 A (S) alloy steel sheet at different exposure times.

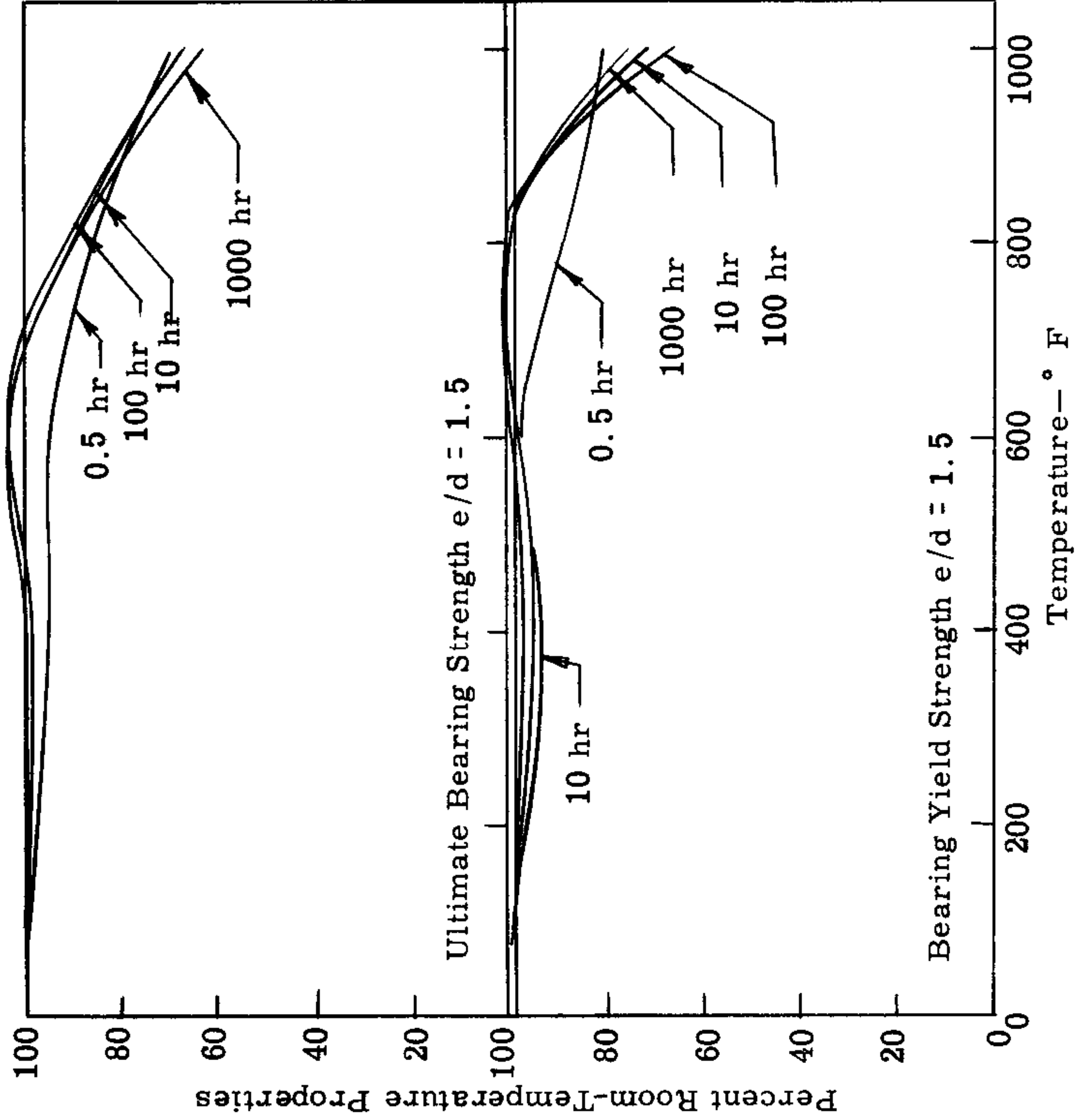

Fig. 126. Elevated-temperature strength properties as percent of room-temperature properties for quenched and tempered 17-22 A (S) alloy steel sheet at different exposure times.

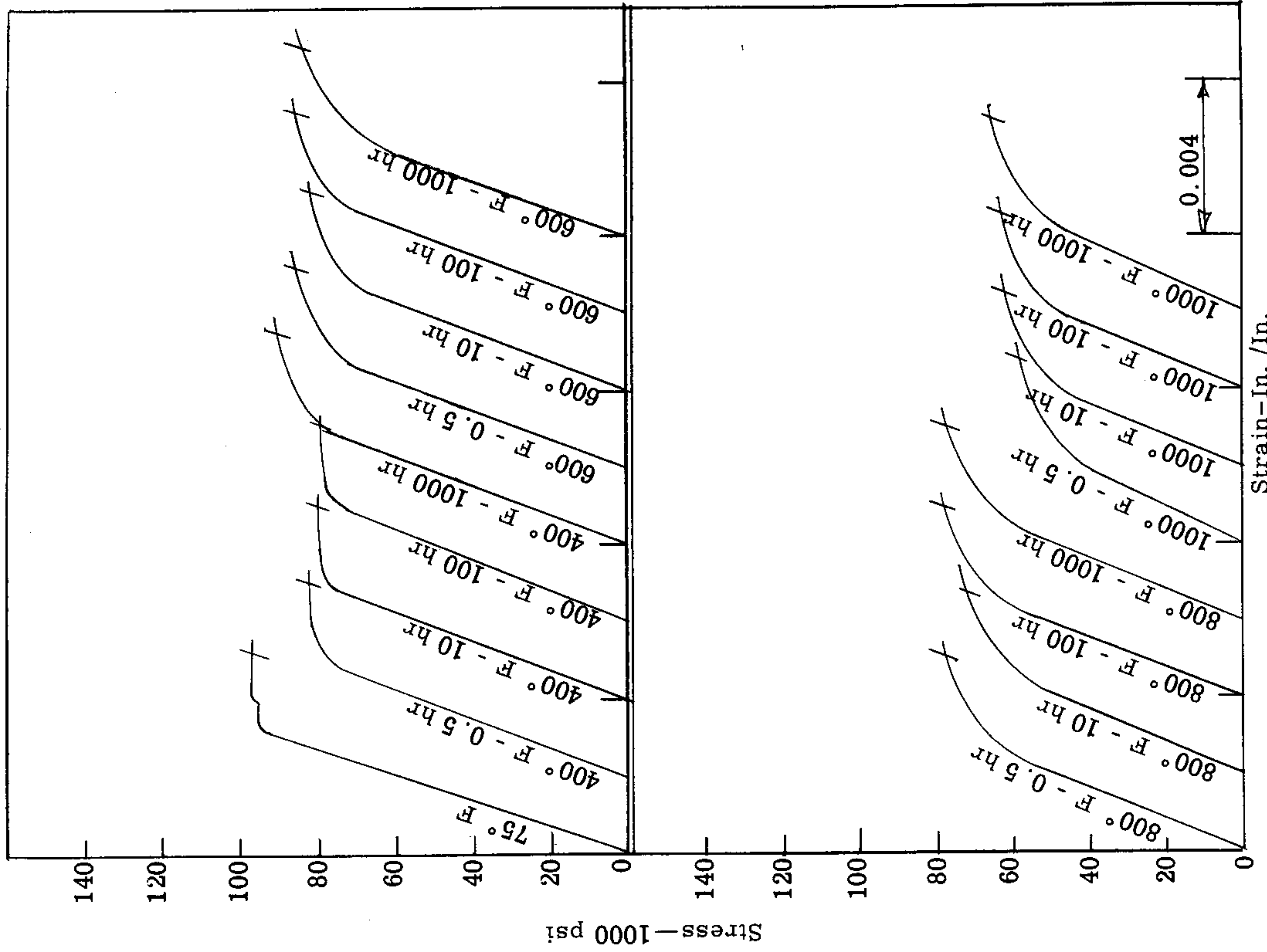

Fig. 127. Tensile stress-strain curves for quenched and tempered 17-22 A (S) alloy steel sheet at various temperatures and exposure times

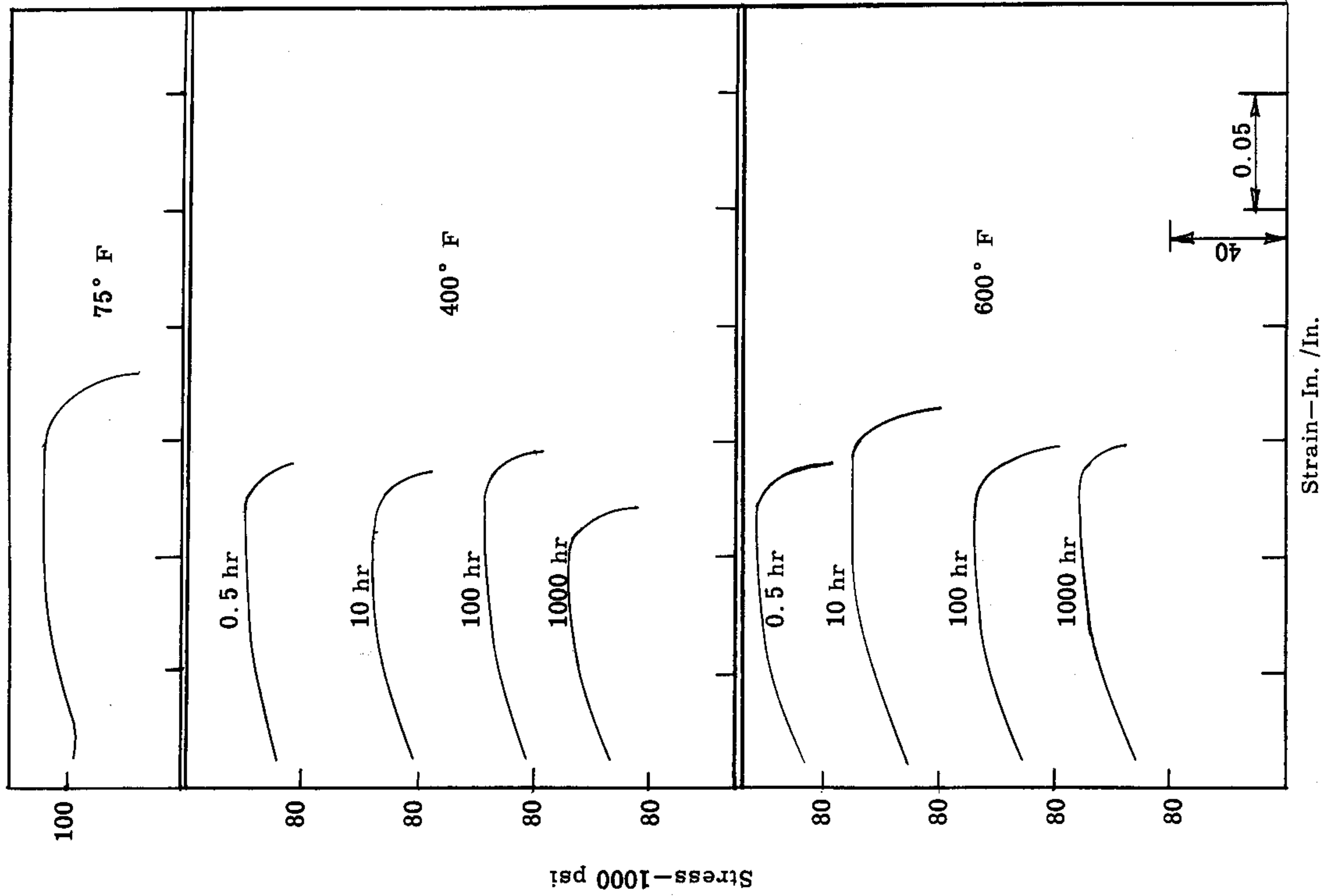

Fig. 128. Tensile postyield stress-strain curves for quenched and tempered 17-22 A (S) alloy steel sheet at various temperatures and exposure times.

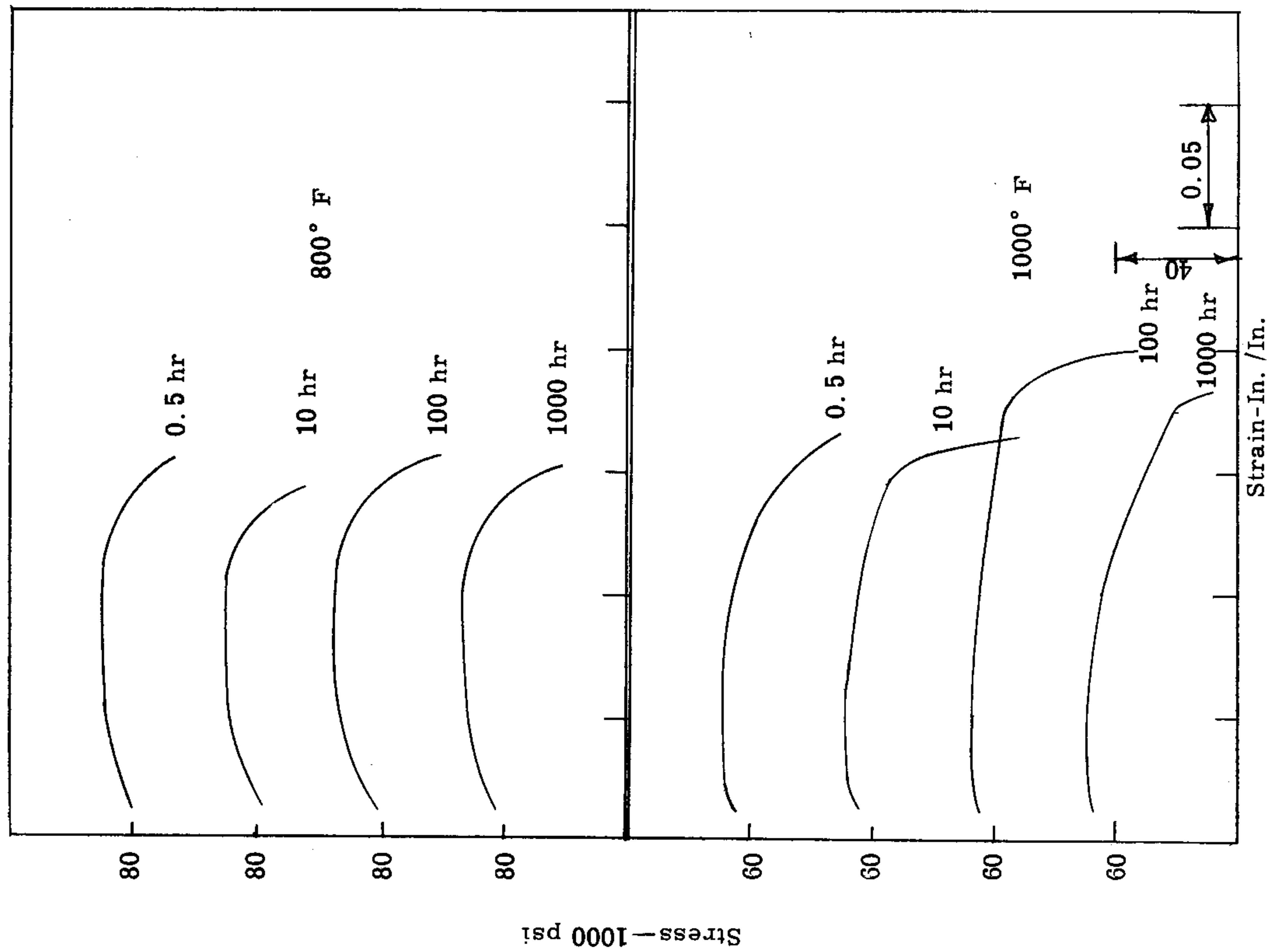

Fig. 129. Tensile postyield stress-strain curves for quenched and tempered 17-22 A (S) alloy steel sheet at various temperatures and exposure times.

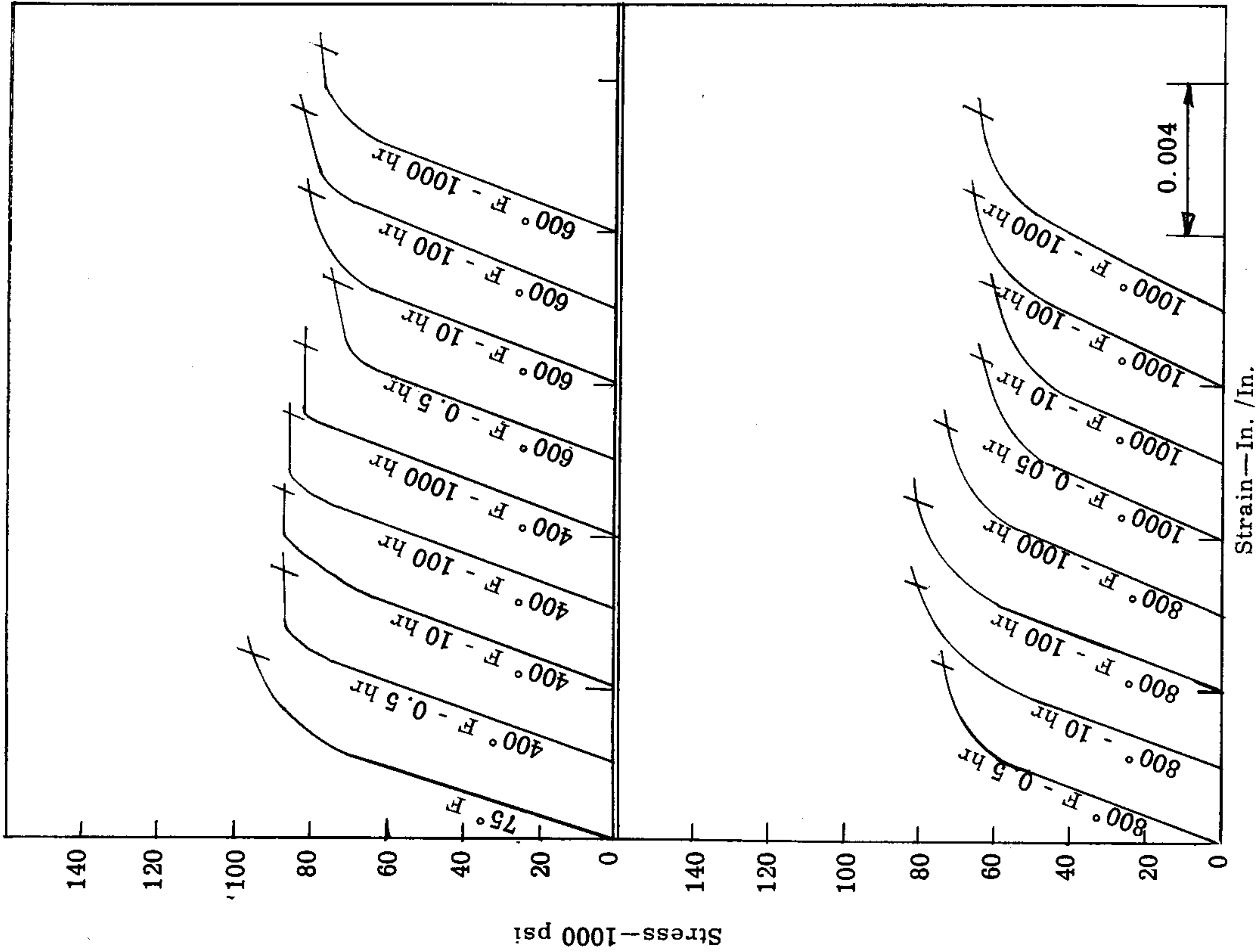

Fig. 130. Compressive stress-strain curves for quenched and tempered 17-22 A (S) alloy steel at various temperatures and exposure times.

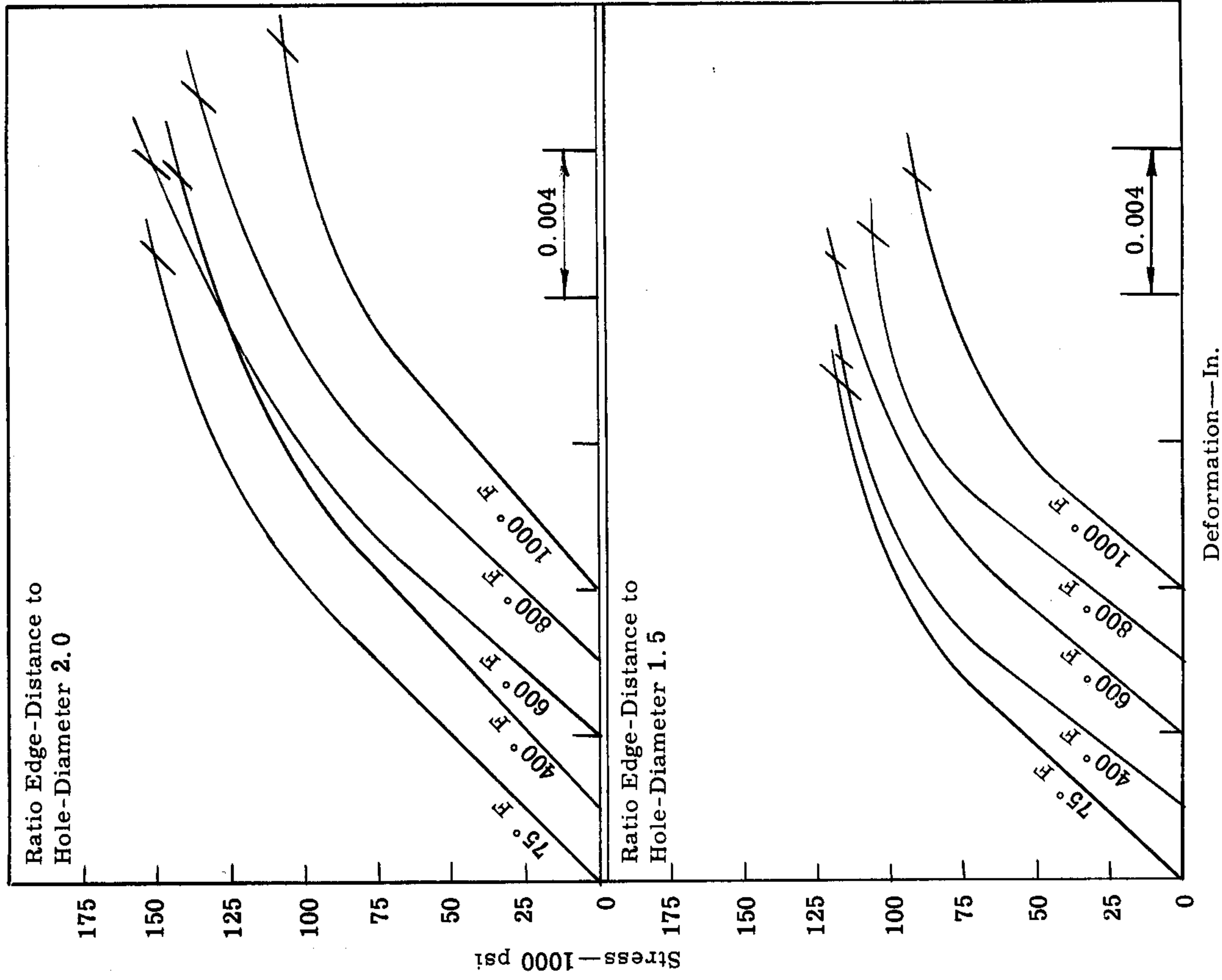

Fig. 131. Bearing stress-deformation curves for quenched and tempered 17-22 A (S) alloy steel sheet at various temperatures and one-half-hour exposure time.

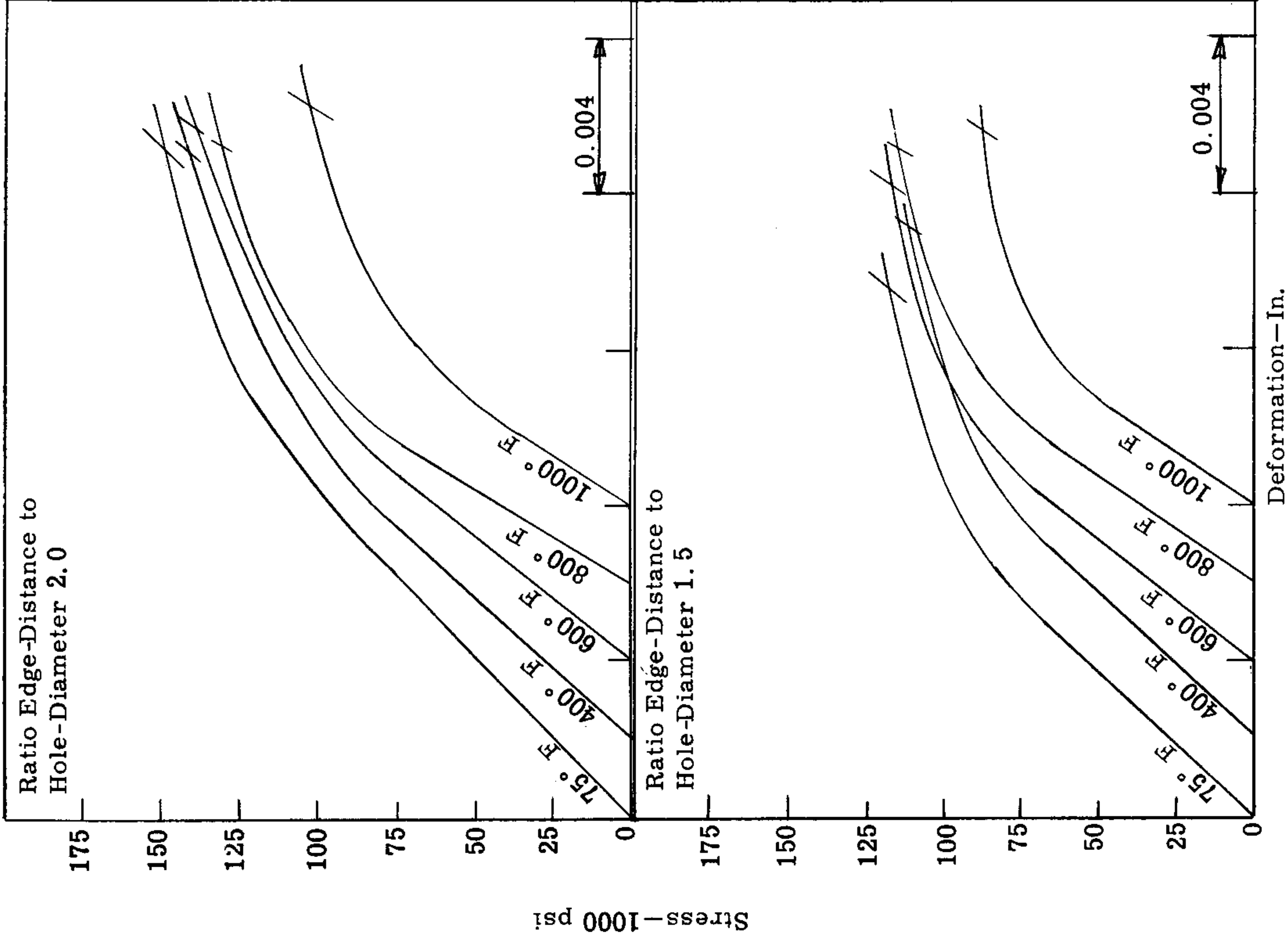

Fig. 132. Bearing stress-deformation curves for quenched and tempered 17-22 A (S) alloy steel sheet at various temperatures and ten-hour exposure time

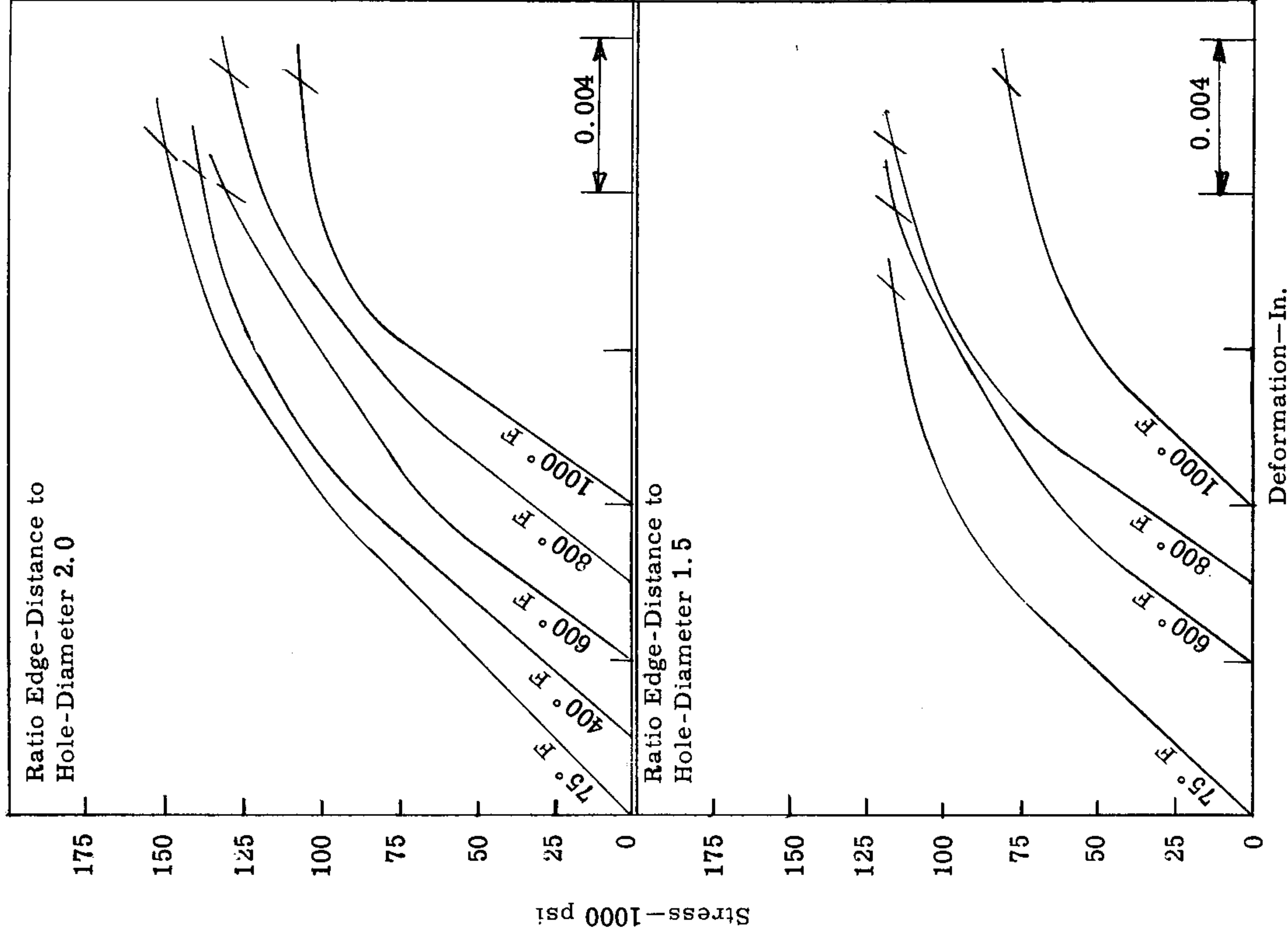

Fig. 133. Bearing stress-deformation curves for quenched and tempered 17-22 A (S) alloy steel sheet at various temperatures and one-hundred-hour exposure time

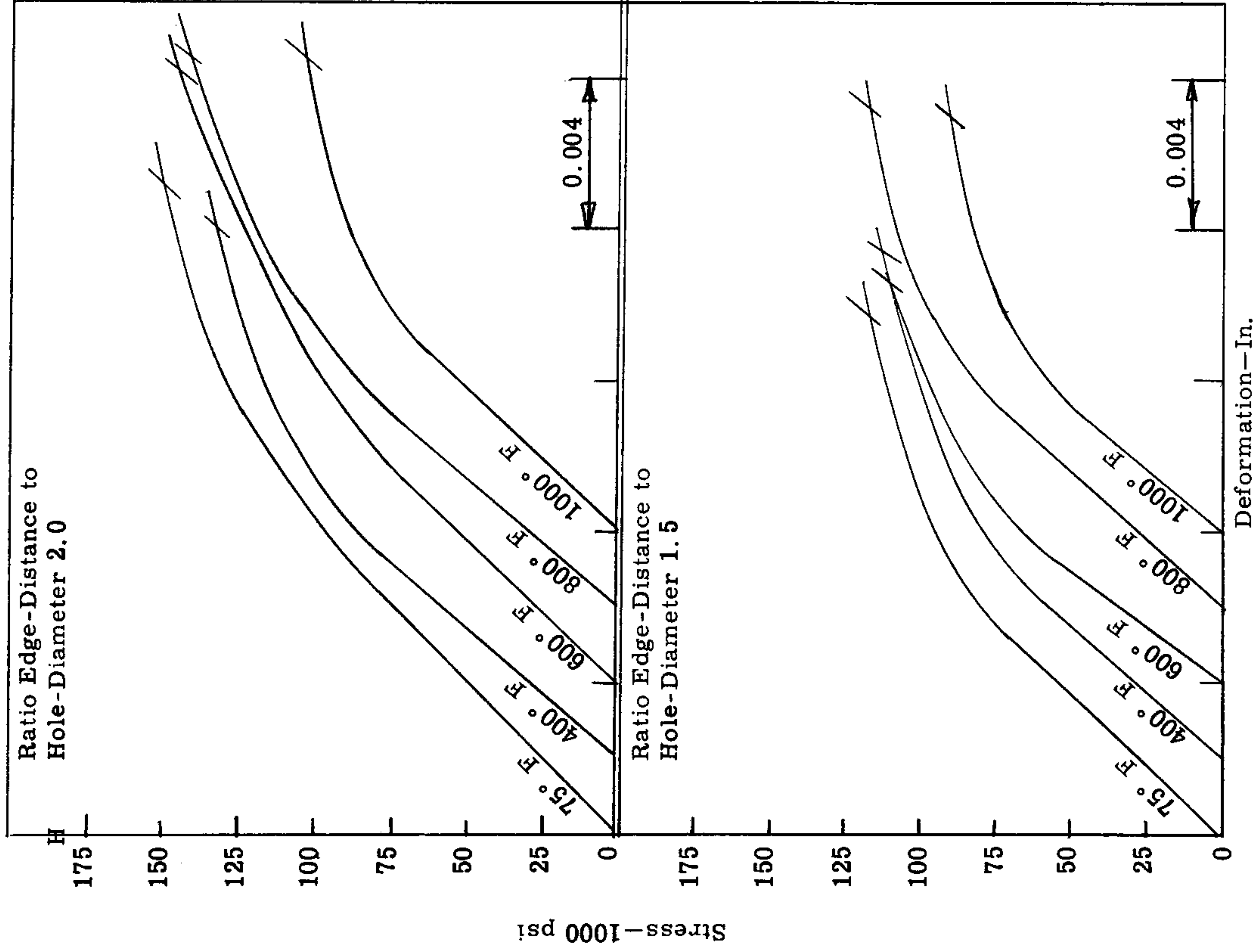

Fig. 134. Bearing stress-deformation curves for quenched and tempered 17-7 A (S) alloy steel sheet at various temperatures and one-thousand-hour exposure time.

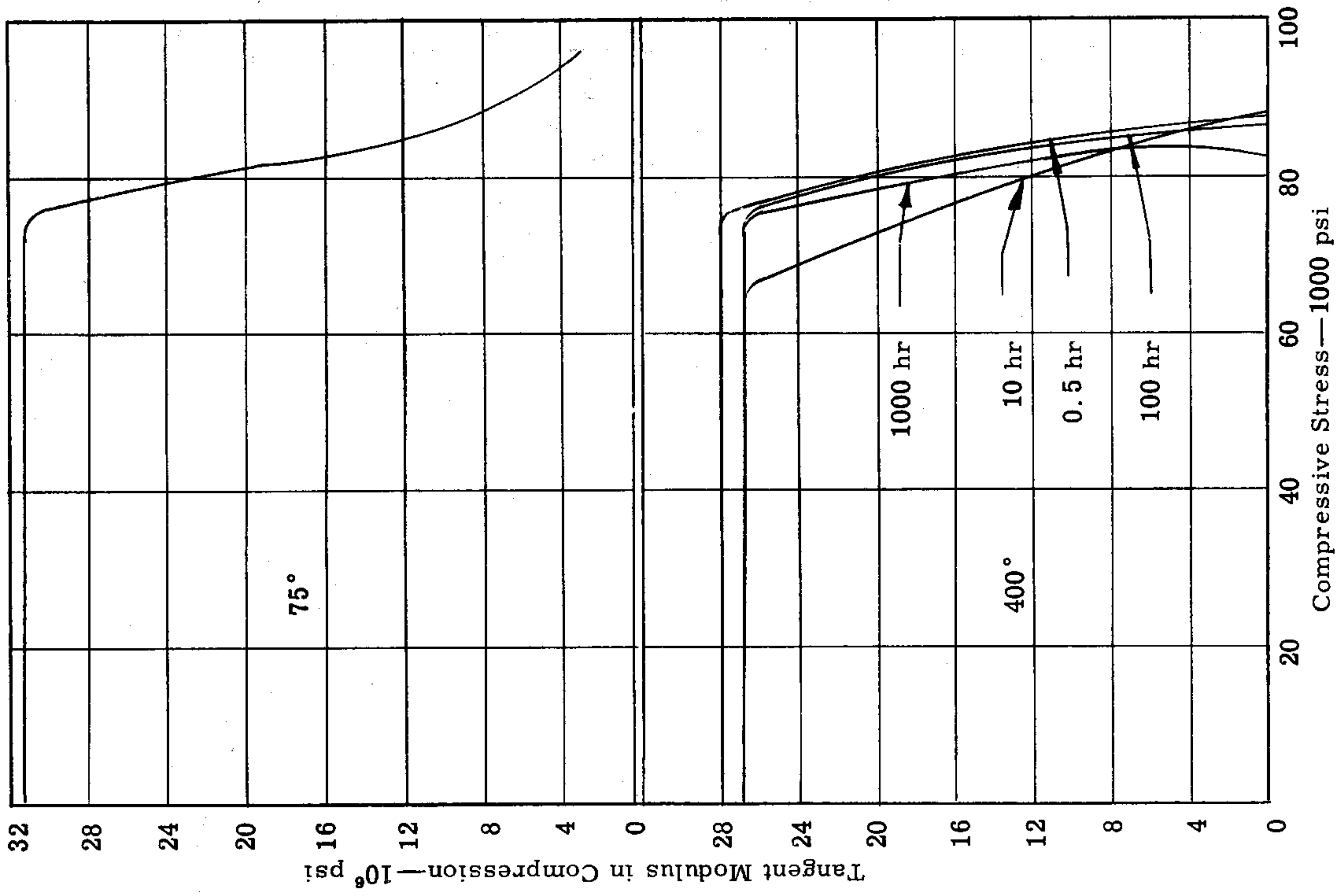

Fig. 135. Tangent-modulus vs. compressive-stress curves for quenched and tempered 17-22 A (S) alloy steel sheet at 75° F and 400° F and different exposure times.

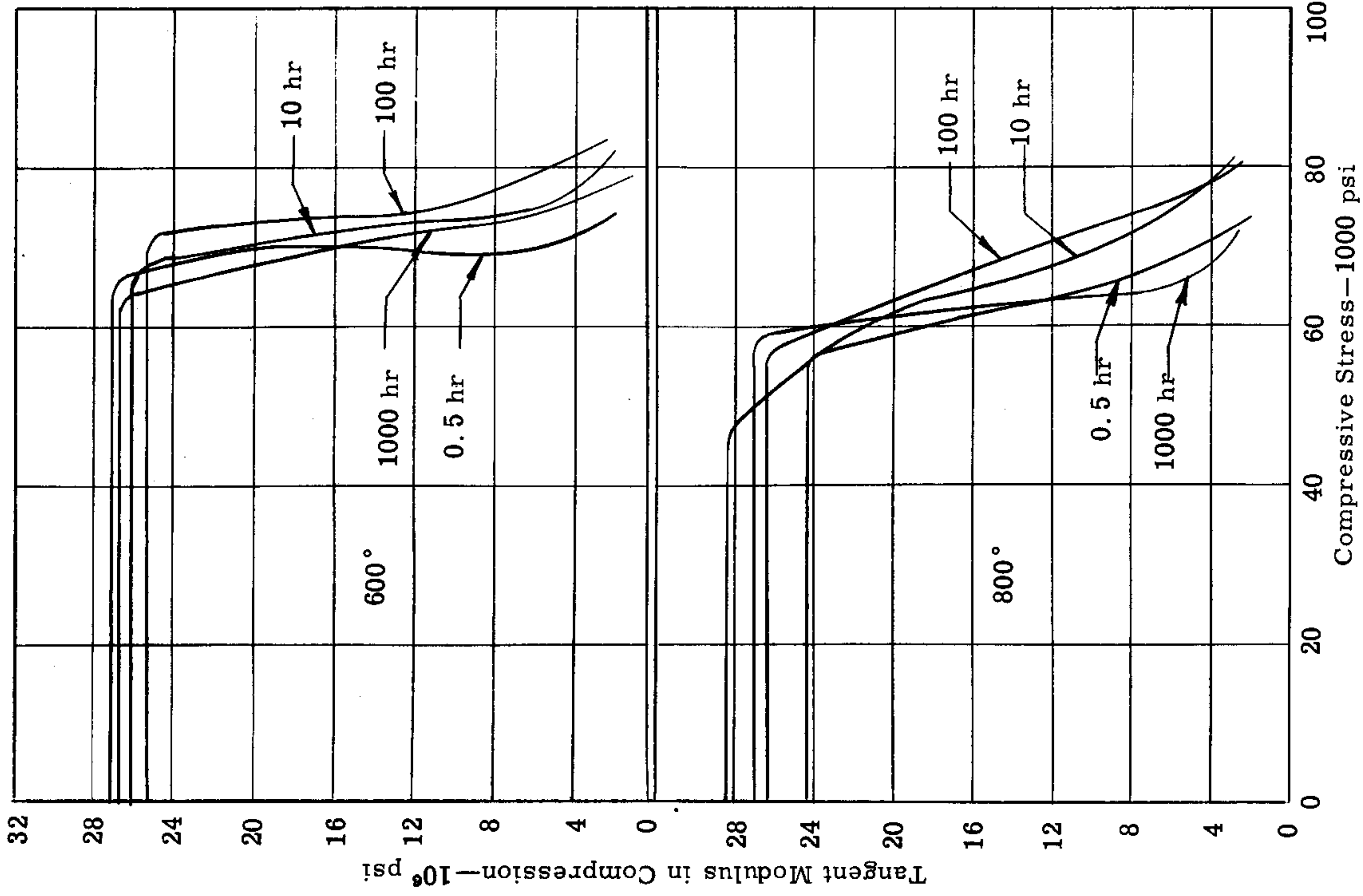

Fig. 136. Tangent-modulus vs. compressive-stress curves for quenched and tempered 17-22 A (S) alloy steel sheet at 600° F and 800° F and different exposure times.

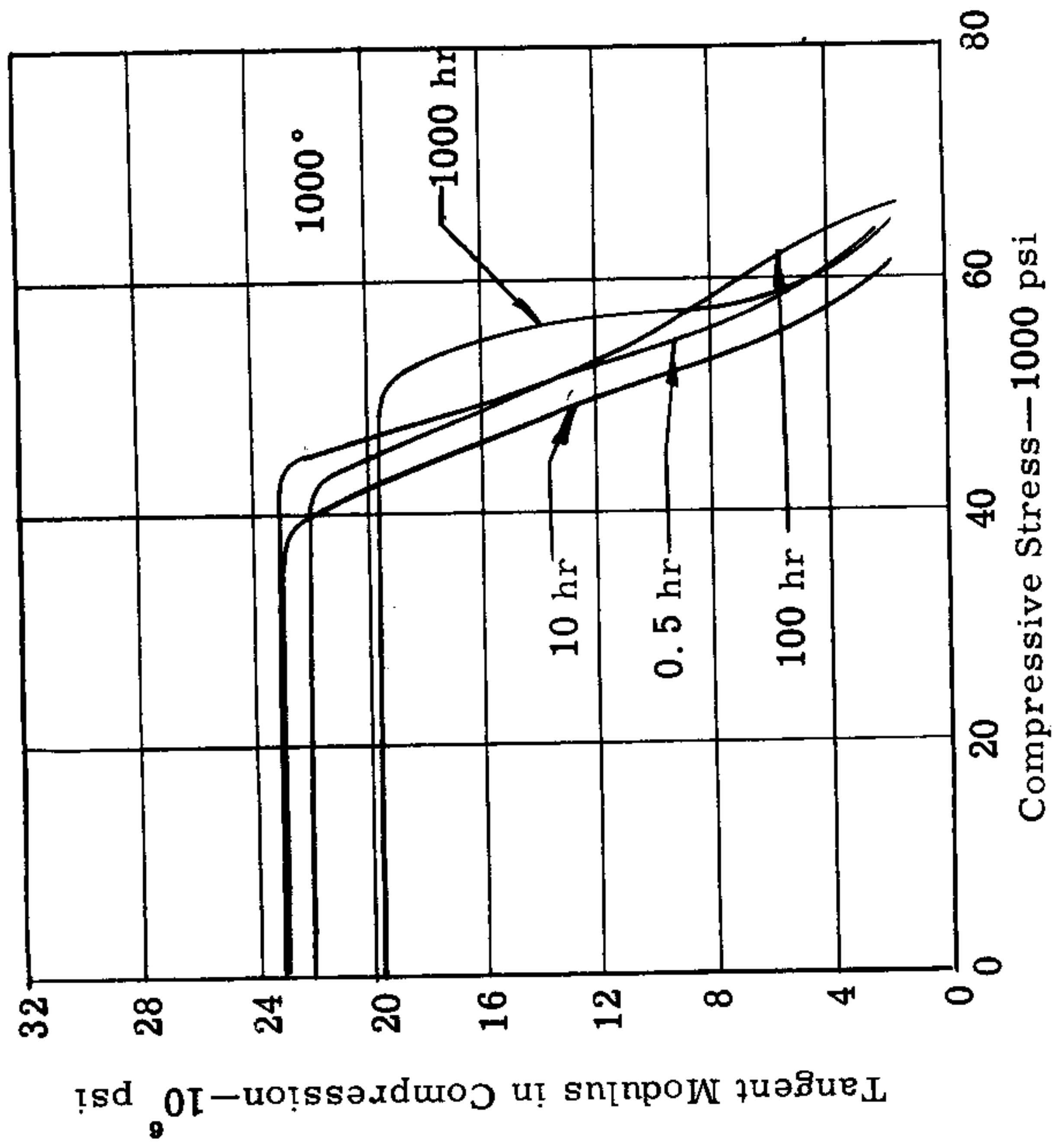

Fig. 137. Tangent-modulus vs. compressive-stress curves for quenched and tempered 17-22 A (s) alloy steel sheet at 1000° F and different exposure times.

Tensile Properties of 0.062-In. 17-22A (S) Alloy Steel Sheet at Different Temperatures and Holding Times

Temp °F	Holding Time, hr	YS 1000 psi	UTS 1000 psi	ME 10 ⁴ psi	Elong. %	Hard ¹ R45N	RS ² 1000 psi	RS ³ 1000 psi
RT		101.6	110.5	31.7	15	23	87.6	197.5
		100.5	112.0	29.1	16	22	77.0	216.0
		97.5	109.0	29.7	16	22	75.7	169.5
Avg		99.9	110.5	30.2	16	22	80.1	194.3
400	0.5	84.0	98.5	27.1	11	22	84.0	270.0
		82.6	98.0	26.8	12	23	71.0	231.0
		84.8	99.0	26.0	12	22	75.0	238.0
Avg		83.8	98.5	26.6	12	22	75.5	246.3
400	10	82.4	98.5	25.3	12	22	78.0	176.0
		85.8	100.0	26.2	10	22	78.5	256.0
		80.6	95.7	26.0	12	21	74.0	237.0
Avg		82.9	98.0	25.8	11	22	76.8	223.0
400	100	80.0	94.5	25.0	12	21	74.5	242.0
		79.5	97.2	24.5	12	21	78.0	206.0
		83.6	99.5	27.3	12	21	76.0	198.0
Avg		81.0	97.0	25.6	12	21	76.1	215.3
400	1000	91.1	107.6	27.6	10	22	80.8	170.8
		91.8	108.4	25.6	11	21	91.0	177.0
		89.2	108.0	24.5	11	21	84.3	194.0
Avg		90.7	108.0	25.9	11	21	85.3	180.6

243

WADC TR 58-365

Tensile Properties of 0.062-In. 17-22A (S) Alloy Steel Sheet at Different Temperatures and Holding Times

Table 34 (continued)

Temp ° F	Holding Time, hr	YS 1000 psi	UTS 1000 psi	ME 10 ⁶ psi	Elong. %	Hard ¹ R45N	RS ² 1000 psi	RS ³ 1000 psi
600	0.5	85.5	102.9	—	13	22	74.4	172.8
		79.8	100.0	27.7	14	23	71.0	158.9
600	10	86.5	103.0	26.4	13	25	77.6	192.5
		83.9	102.0	27.0	13	23	74.3	174.7
600	10	87.7	109.5	23.3	12	20	80.6	199.2
		82.2	107.0	25.9	13	20	87.2	188.0
600	100	86.2	109.5	27.5	12	22	82.8	165.2
		86.2	106.5	26.4	12	23	75.0	194.0
600	1000	86.0	110.8	22.7	11	20	95.8	181.5
		85.8	108.8	28.1	12	20	78.7	193.0
800	0.5	76.5	90.0	23.8	15	26	66.7	156.5
		76.2	90.5	26.3	14	27	63.8	168.5
Avg		85.8	107.8	28.2	11	19	77.5	145.5
		85.8	109.1	26.3	11	20	84.0	173.3
Avg		78.0	91.0	25.1	15	27	64.7	173.0
		76.9	90.5	25.1	15	27	65.1	166.0

244

WADC TR 58-365

Table 34 (continued)

Tensile Properties of 0.062-in. 17-22A (S) Alloy Steel Sheet at Different Temperatures and Holding Times

Temp °F	Holding Time, hr	YS 1000 psi	UTS 1000 psi	ME 10 ⁶ psi	Elong. %	Hard ¹ R45N	RS ² 1000 psi	RS ³ 1000 psi
800	10	74.8	89.2	22.8	12	22	71.8	165.4
		73.7	87.8	23.9	11	22	58.7	145.6
		74.6	89.7	25.5	11	22	65.2	165.8
Avg		74.4	88.9	24.1	11	22	65.2	158.9
800	100	77.4	93.7	27.0	13	21	71.5	200.0
		79.4	95.4	26.7	13	23	61.2	159.5
		78.2	93.7	25.9	12	22	57.5	145.0
Avg		78.3	94.3	26.5	13	22	63.4	168.2
800	1000	78.8	95.4	19.4	11	21	70.8	154.0
		77.8	93.2	25.0	14	22	61.0	132.0
		83.5	98.8	28.6	13	22	74.0	159.5
Avg		80.0	95.8	24.2	13	22	68.6	148.5
1000	0.5	71.0	72.6	21.9	18	22	16.0	75.0
		61.0	69.0	20.3	16	20	31.9	107.5
		58.6	69.6	20.7	16	21	34.5	122.2
Avg		63.5	70.4	20.9	17	21	27.4	101.5
1000	10	60.3	67.7	25.2	15	26	11.8	33.8
		62.0	68.5	24.7	20	25	25.8	75.0
		66.1	69.1	-	13	26	11.8	33.3
Avg		62.8	68.4	25.0	16	26	16.5	47.0

WADC TR 58-365

245

WADC TR 58-365 246

Table 34 (continued)

Tensile Properties of 0.062-In. 17-22A (S) Alloy Steel Sheet at Different Temperatures and Holding Times

Temp °F	Holding Time, hr	YS 1000 psi	UTS 1000 psi	ME 10 ⁶ psi	Elong. %	Hard ¹ R45N	RS ² 1000 psi	RS ³ 1000 psi
1000	100	62.8	68.4	28.3	14	24	15.3	55.4
		64.4	67.0	22.5	18	22	13.6	50.0
		63.2	67.7	24.3	22	21	12.3	59.2
		63.5	67.7	25.0	18	22	13.7	54.9
1000	1000	63.8	68.7	21.6	15	24	28.6	120.0
		64.7	68.8	21.7	17	23	—	—
		68.2	71.0	21.6	19	22	10.6	35.3
		65.6	69.5	21.6	17	23	19.6	77.6
Avg								

1. Hardness determinations made at room temperature after tests.
2. Rupture strength based on original cross section.
3. Rupture strength based on final cross section.
4. Heat treatment — 1750° F 15 min argon atmosphere, O. Q., 1300° F 1 hr, A. C.

Tensile Strength of 3/16-In. 17-22 A (S) Alloy Steel Plate at Different Temperatures and Holding Times

Table 35

Holding Time, hr	Temp ° F	1/2		10		100		1000	
		UTS ¹ 1000 psi	Hard _z RC	UTS 1000 psi	Hard RC	UTS 1000 psi	Hard RC	UTS 1000 psi	Hard RC
RT	Avg	106.5	22	111.2	23	110.2	26	114.0	23
		109.0	21	110.5	22	113.0	26	114.8	23
	Avg	111.0	24	114.5	23	117.0	26	114.0	23
		108.8	22	112.0	23	113.4	26	114.3	23
400	Avg	115.0	26	112.5	26	117.0	26	108.8	23
		113.0	26	112.3	26	117.7	26	117.2	27
600	Avg	113.0	26	116.2	26	117.0	27	109.2	23
		113.7	26	113.7	26	117.2	26	111.7	24
800	Avg	94.5	23	99.9	24	97.4	24	96.0	22
		95.2	21	100.5	24	96.2	25	100.4	22
	Avg	95.5	23	97.0	23	96.5	23	102.0	-
		95.1	22	99.1	24	96.7	24	99.5	22

WADC TR 58-365 247

1. Ultimate tensile strength.
2. Hardness determinations made at room temperature after tests.
3. Heat treatment - 1750° F 15 min argon atmosphere, O. Q., 1300° F, 1 hr, A. C.

Holding Time, hr	Temp ° F	1/2		10		100		1000	
		UTS ¹ 1000 psi	Hard ² RC	UTS 1000 psi	Hard RC	UTS 1000 psi	Hard RC	UTS 1000 psi	Hard RC
		74.0	24	82.0	28	74.2	23	71.3	24
		75.5	24	80.5	26	74.7	24	70.5	26
		74.7	24	77.2	28	74.7	24	72.2	23
		74.7	24	79.9	27	74.5	24	71.3	24

Tensile Strength of 3/16-In. 17-22 A (S) Alloy Steels Plate at Different Temperatures and Holding Times

Table 35(continued)

WADC TR 58-365 248

Table 36
Compressive Properties of 0.062-In. 17-22 A (S) Alloy Steel Sheet at Different Temperatures and Holding Times

Hold. Time hr	1/2		10		100		1000		
	CYS ¹ 1000 psi	ME 10 ⁶ psi	Hard ² R45N	CYS 1000 psi	ME 10 ⁶ psi	Hard R45N	CYS 1000 psi	ME 10 ⁶ psi	Hard R45N
RT	95.5	31.0	21	95.5	31.3	21	95.5	31.0	21
	96.0	32.6	21	94.5	30.2	21	95.3	31.3	21
Avg	87.5	27.9	18	87.5	27.8	18	87.5	27.8	18
	87.5	27.9	18	82.5	26.8	18	82.5	26.8	18
400	90.5	27.8	20	89.5	29.4	18	86.3	26.1	18
	87.0	27.9	20	83.5	29.9	21	86.3	26.6	19
Avg	88.3	27.9	19	88.3	27.5	19	83.5	29.9	21
	87.0	27.9	20	85.4	27.5	19	83.5	29.9	21
600	77.6	23.8	17	78.2	25.7	18	78.8	29.2	17
	76.5	26.4	17	81.8	26.0	18	79.0	28.8	17
Avg	74.8	27.0	18	81.7	—	19	83.5	25.3	18
	76.3	25.7	17	80.6	25.8	18	80.4	27.7	17
800	73.7	26.9	19	76.7	27.7	21	80.6	26.3	21
	72.0	22.1	19	81.0	28.5	21	72.5	28.7	21
Avg	78.0	24.0	21	84.7	28.2	23	73.6	24.6	20
	74.6	24.3	20	80.8	28.1	22	75.6	26.5	21

1. Compressive yield strength.
2. Hardness determinations made at room temperature after tests.
3. Heat treatment - 1750° F 15 min argon atmosphere, O. Q., 1300° F 1 hr, A. C.

Hold. Time	Temp °F	1000	Avg
1/2	CYS ¹ 1000 psi	73.0	67.4
	ME 10 ⁶ psi	21.7	23.4
	Hard ² R45N	23	22
10	CYS 1000 psi	60.8	63.4
	ME 10 ⁶ psi	-	22.0
	Hard R45N	19	19
100	CYS 1000 psi	61.3	66.7
	ME 10 ⁶ psi	22.2	22.2
	Hard R45N	19	20
1000	CYS 1000 psi	65.0	65.7
	ME 10 ⁶ psi	19.7	19.2
	Hard R45N	20	21

Compressive Properties of 0.062-In. 17-22 A (S) Alloy Steel³ Sheet at Different Temperatures and Holding Times

Table 36 (continued)

250

WADC TR 58-365

Table 37
 Shear Strength of 3/16-In. 17-22A (S) Alloy Steel's Plate at
 Different Temperatures and Holding Times

Holding Time, hr	Temp ° F	1/2		10		100		1000	
		USS ¹ 1000 psi	Hard ² RC	USS 1000 psi	Hard RC	USS 1000 psi	Hard RC	USS 1000 psi	Hard RC
RT	Avg	67.8	21	62.5	17	69.2	22	75.7	23
		69.8	21	63.0	19	69.8	19	74.8	22
400	Avg	69.2	21	62.5	18	67.2	22	73.5	23
		68.9	21	62.6	18	68.7	21	74.7	23
600	Avg	72.5	20	71.8	22	68.2	22	74.8	22
		71.5	21	71.5	23	70.2	22	74.8	22
800	Avg	74.0	19	62.5	16	63.5	19	75.7	23
		65.6	21	63.0	16	60.4	17	74.8	22
Avg		65.5	23	62.0	-	58.2	19	73.5	23
		68.4	21	62.5	16	60.7	18	74.7	23

WADC TR 58-365

251

1. Ultimate shear strength.
2. Hardness determinations made at room temperature after tests.
3. Heat treatment - 1750° F 15 min argon atmosphere, O. Q., 1300° F 1 hr, A. C.

Shear Strength of 3/16-in. 17-22A (S) Alloy Steel Plate at Different Temperatures and Holding Times	
Holding Time, hr	Temp °F
1000	50.0
1000	56.5
1000	53.0
Avg	53.2
1/2	50.5
1/2	49.7
1/2	52.5
1/2	50.9
10	46.2
10	46.7
10	45.0
10	46.0
1000	45.4
1000	44.4
1000	46.2
1000	45.3

Table 37 (continued)

WADC TR 58-365 252

Bearing Properties* of 0.062-In. 17-22 A (S) Alloy Steel Sheet at Different Temperatures and Holding Times

Table 38

Hold. Time hr	Temp ° F	1/2		10		100		1000	
		BYS ¹ UBS ²	Hard ³ R45N	BYS UBS	Hard R45N	BYS UBS	Hard R45N	BYS UBS	Hard R45N
RT	117.5	153.0	22	101.5	22	106.5	21	157.0	21
	107.5	147.0	23	112.0	21	122.0	22	156.0	22
Avg	117.5	153.0	22	108.7	22	113.0	22	164.0	22
	114.2	151.0	22	157.5	22	111.0	22	159.0	22
400	117.5	153.0	22	101.5	22	106.5	21	157.0	21
	107.5	147.0	23	112.0	21	122.0	22	156.0	22
Avg	117.5	153.0	22	108.7	22	113.0	22	164.0	22
	114.2	151.0	22	157.2	22	113.2	22	159.0	22
600	122.0	147.5	22	116.0	21	114.0	19	164.5	19
	118.0	156.0	24	118.5	21	117.0	20	166.5	19
Avg	118.0	156.0	24	116.7	21	119.0	20	163.5	20
	113.0	148.5	23	115.5	17	119.0	22	163.5	20
800	106.0	135.0	22	122.5	19	117.2	19	142.2	19
	113.0	135.0	24	121.8	21	117.5	18	144.5	20
Avg	106.0	135.0	23	117.5	19	121.2	19	143.5	22
	97.0	135.0	23	118.2	19	121.2	20	143.5	22

253

WADC TR 58-365

Bearing Properties⁴ of 0.062-In. 17-22 A (S) Alloy Steel Sheet at Different Temperatures and Holding Times

Table 38 (continued)

Hold Time hr	Temp ° F	1/2		10		100		1000														
		BYS ¹ 1000 psi	UBS ² 1000 psi	Hard ³ R45N	BYS 1000 psi	UBS 1000 psi	Hard R45N	BYS 1000 psi	UBS 1000 psi	Hard R45N												
		91.8	114.8	22	84.2	104.0	22	-	106.0	21	85.3	100.0	21	91.0	101.5	19	89.5	101.5	20	88.6	101.0	20
		99.0	109.0	21	84.8	103.0	21	71.2	103.8	21	91.0	101.5	19	89.5	101.5	20	88.6	101.0	20	88.6	101.0	20
		-	107.5	22	88.7	106.5	22	86.5	106.0	21	89.5	101.5	20	89.5	101.5	20	88.6	101.0	20	88.6	101.0	20
		95.4	111.1	22	85.9	104.5	22	78.8	105.3	21	88.6	101.0	20	88.6	101.0	20	88.6	101.0	20	88.6	101.0	20

1. Bearing yield strength.
2. Ultimate bearing strength.
3. Hardness determinations made at room temperature after tests;
4. Edge - Distance to hold-diameter ratio 1.5 in.
5. Heat treatment - 1750° F 15 min argon atmosphere, O. Q., 1300° F 1 hr, A. C.

Bearing Properties of 0.062-In. 17-22 A (S) Alloy Steel Sheet at Different Temperatures and Holding Times

Hold. Time	Temp °F	1/2		10		100		1000								
		BYS ¹	UBS ²	Hard ³	R45N	BYS	UBS	Hard	R45N	BYS	UBS	Hard	R45N			
RT	Avg	143.0	209.0	24	142.0	206.0	22	125.0	211.0	21	144.0	212.0	22	174.5	221.0	23
	400	142.5	206.0	24	130.0	194.5	22	149.0	211.5	21	133.0	215.0	21	150.0	213.0	22
	Avg	140.0	205.0	23	139.5	206.0	22	141.0	196.0	22	132.5	215.0	22	145.5	213.0	23
	24	141.8	206.7	24	137.2	202.2	22	138.3	206.2	21	136.5	214.0	22	156.7	215.7	23
600	Avg	150.0	212.0	23	139.2	207.0	23	131.2	212.0	21	134.0	221.0	20	174.5	221.0	23
	400	144.0	208.5	24	143.2	215.0	21	126.5	213.0	21	145.2	215.5	20	150.0	213.0	22
	Avg	145.5	208.5	23	-	215.0	22	144.2	211.0	22	148.5	215.0	21	145.5	213.0	22
	24	144.0	208.5	24	143.2	215.0	21	126.5	213.0	21	145.2	215.5	20	150.0	213.0	22
800	Avg	135.5	182.5	22	138.5	187.5	20	133.0	183.5	20	124.5	192.0	22	174.5	192.0	23
	400	134.0	180.0	22	135.2	178.0	22	161.5	187.5	21	144.2	189.8	24	150.0	189.8	22
	Avg	134.0	183.5	22	132.3	183.0	20	129.5	186.6	21	149.2	194.0	22	145.5	194.0	22
	24	134.0	180.0	22	135.2	178.0	22	161.5	187.5	21	144.2	189.8	24	150.0	189.8	22
Avg	134.5	182.0	22	135.0	182.8	21	141.3	185.9	21	139.6	191.9	23	174.5	191.9	23	

Table 39

WADC TR 58-365 255

1. Bearing yield strength.
2. Ultimate bearing strength.
3. Hardness determinations made at room temperature after tests.
4. Edge-distance to hole-diameter ratio 2.0.
5. Heat treatment - 1750° F 15 min argon atmosphere, O.Q., 1300° F 1 hr, A. C.

Hold. Time hr	Temp ° F	1/2		10		100		1000		Avg
		BYS	UBS	BYS	UBS	BYS	UBS	BYS	UBS	
		117.8	150.0	100.8	139.5	112.9	133.9	93.0	132.5	111.3
		110.0	143.2	103.0	140.0	-	136.5	-	125.0	146.2
		106.0	145.5	105.5	138.2	107.5	136.5	103.0	129.5	145.5
		21	21	21	21	23	22	23	20	21
		21	21	25	23	23	22	21	23	21
		103.1	139.2	103.1	139.2	110.2	135.6	98.0	129.0	103.1
		24	24	24	24	24	22	22	21	24

Bearing Properties⁴ of 0.062-In. 17-22 A (S) Alloy Steel⁵ Sheet at Different Temperatures and Holding Times

Table 39 (continued)

WADC TR 58-365

256

10.7 Comparative Figures and Tables

WADC TR 58-365

257

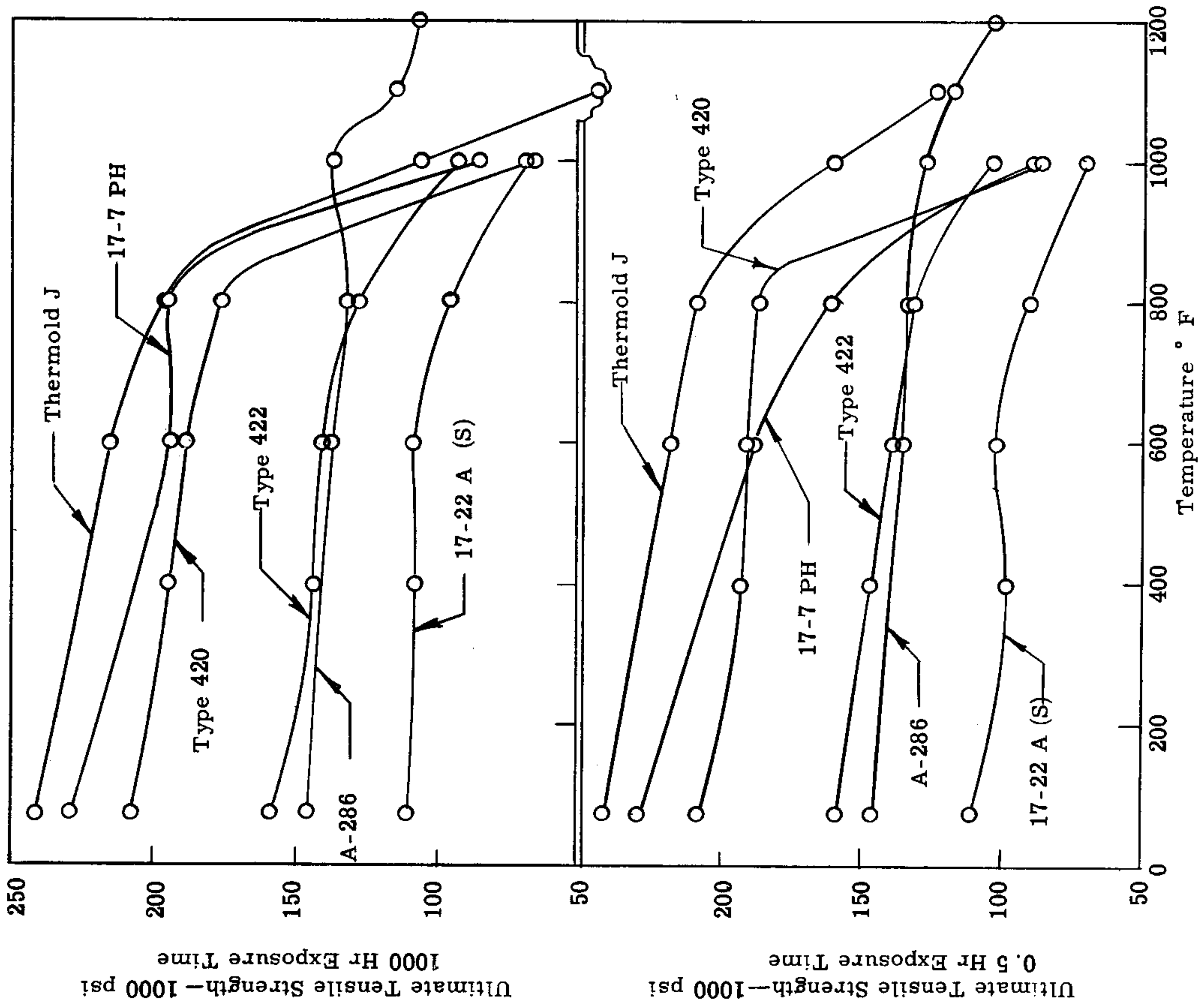

Fig. 138. Effect of temperature on the ultimate tensile strength of the test materials after exposures of 1000 hours and of 0.5 hour.

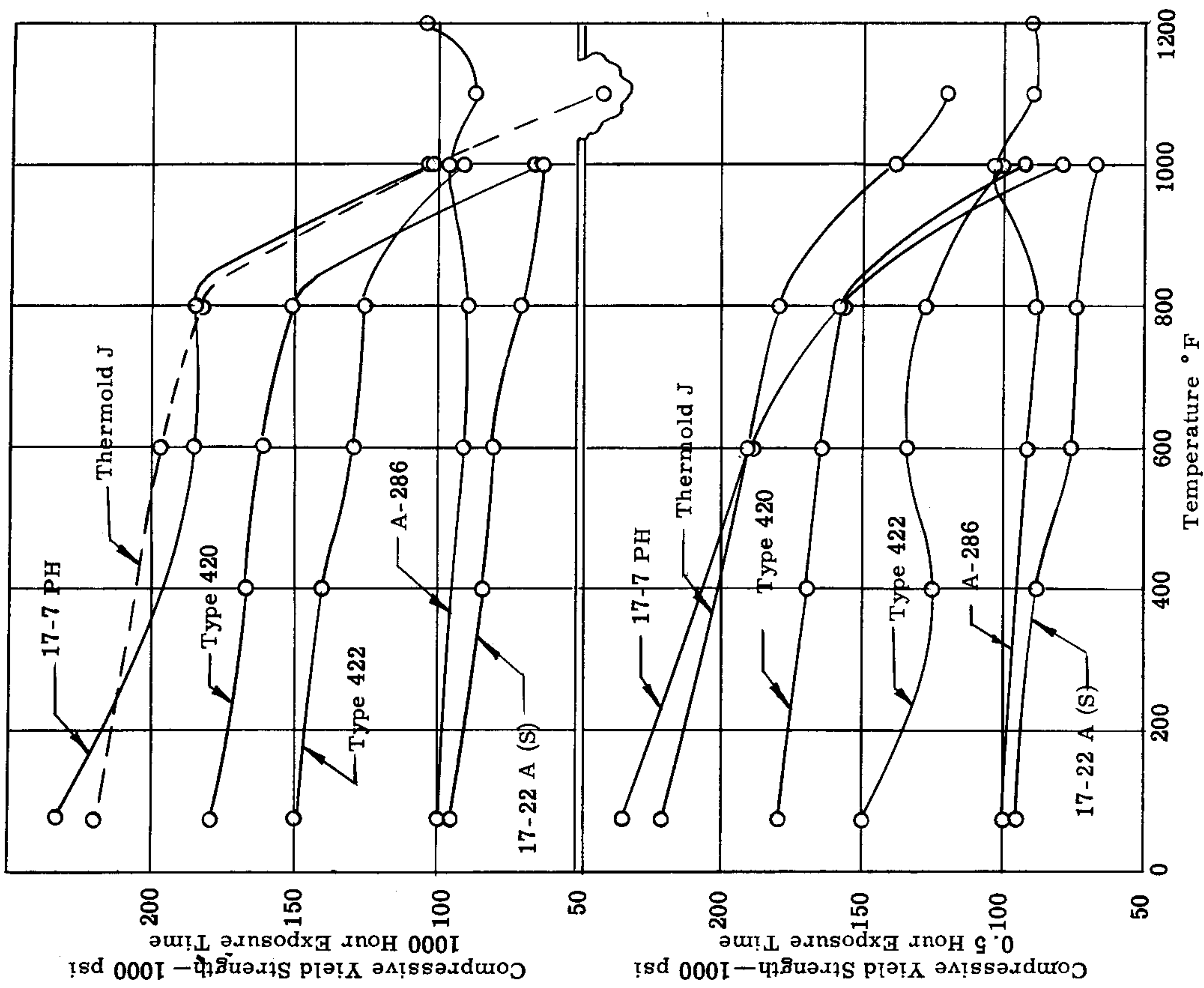

Fig. 139. Effect of temperature on the compressive yield strength of the test materials after exposures of 1000 hours and of 0.5 hour.

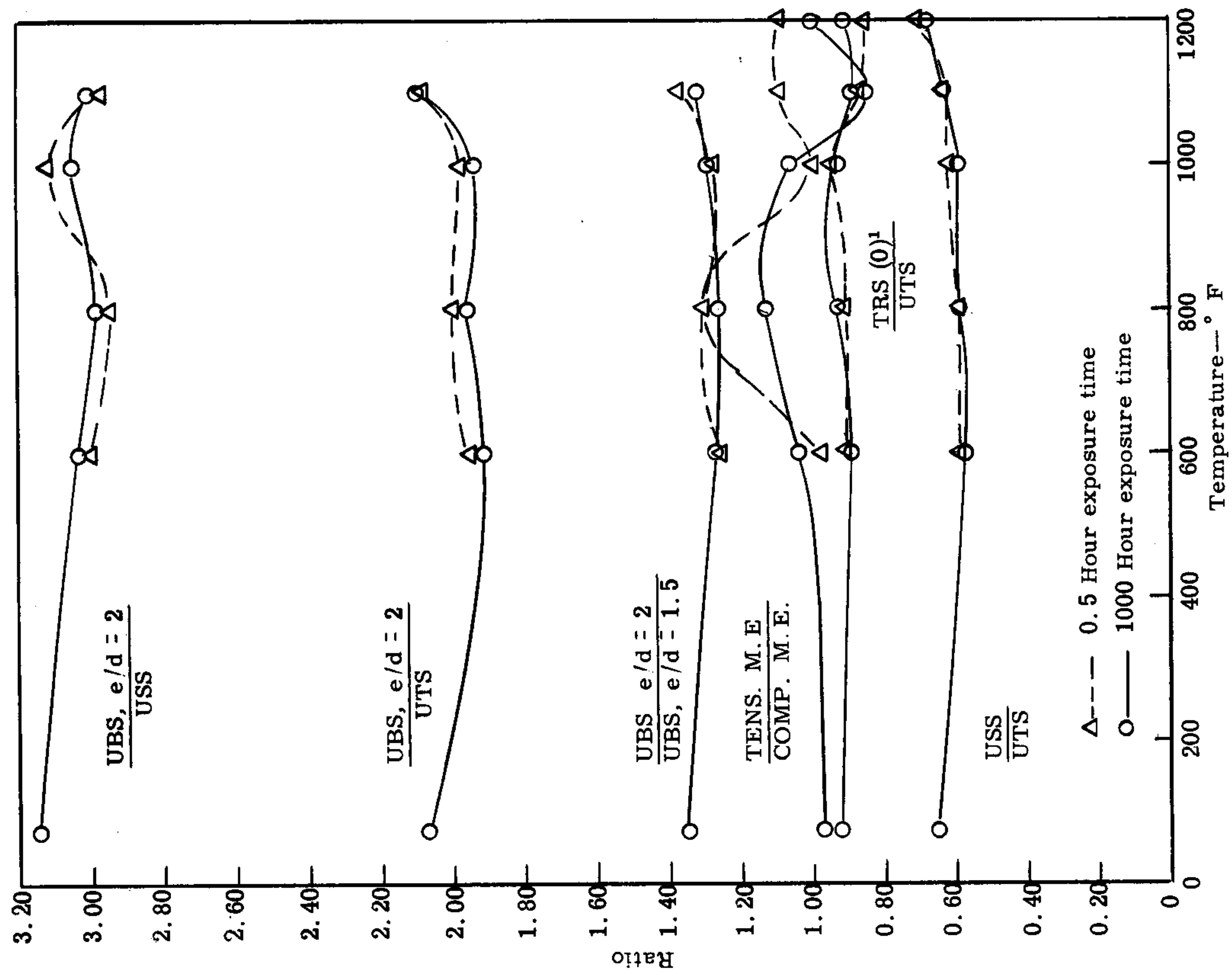

Fig. 140. Effect of temperature on six ratio relationships of properties of quenched and tempered A-286 austenitic alloy sheet.

1. TRS (0)¹-Tensile rupture strength based on the original cross section

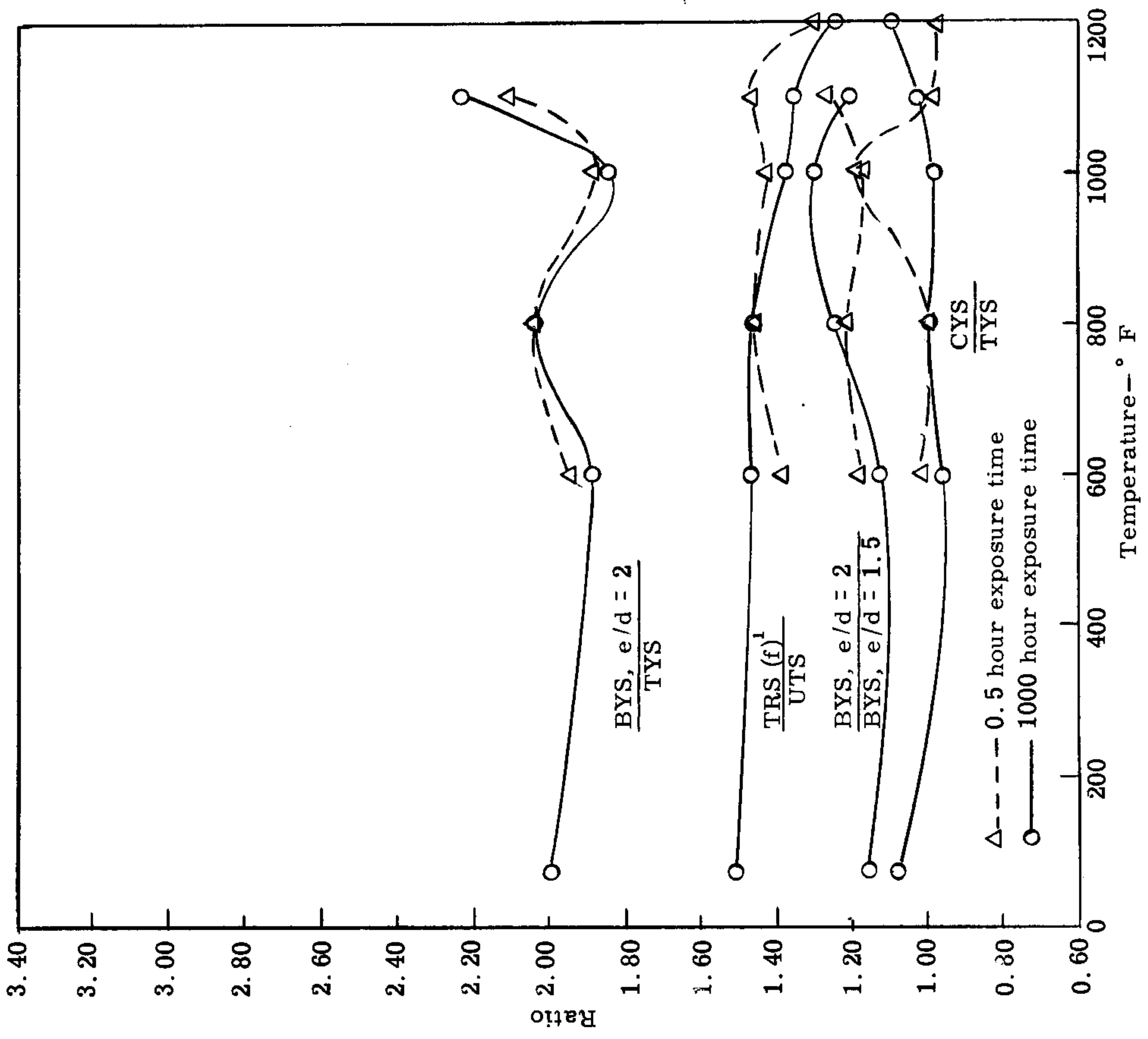

Fig. 141. Effect of temperature on four ratio relationships of properties of quenched and tempered A -286 austenitic alloy sheet.

1. TRS (f)-Tensile rupture strength based on the final cross section

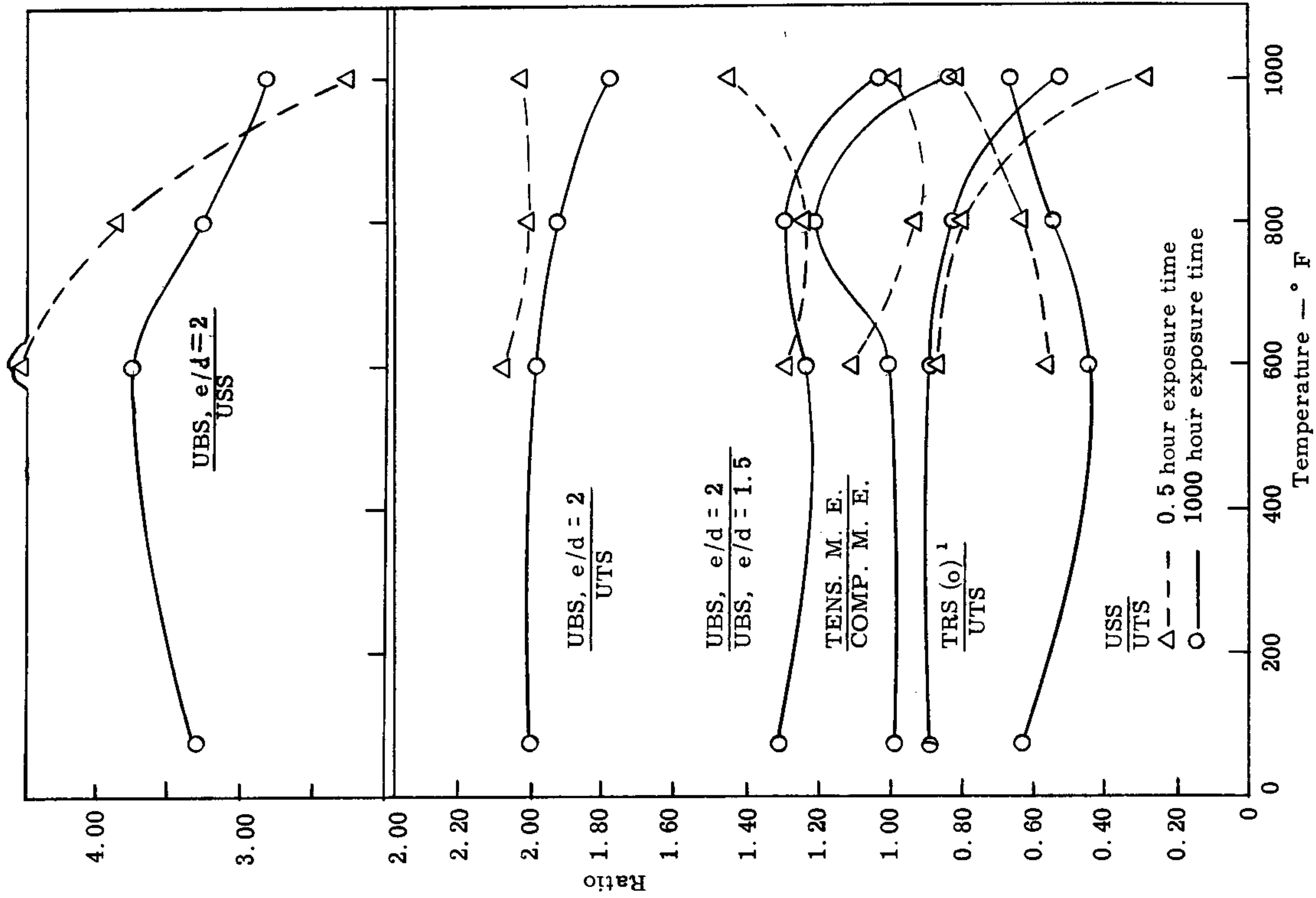

Fig. 142. Effect of temperature on six ratio relationships of properties of 17-7 PH (RH 950) stainless steel sheet.

1. $\frac{TRS (o)}{UTS}$ —Tensile rupture strength based on the original cross section

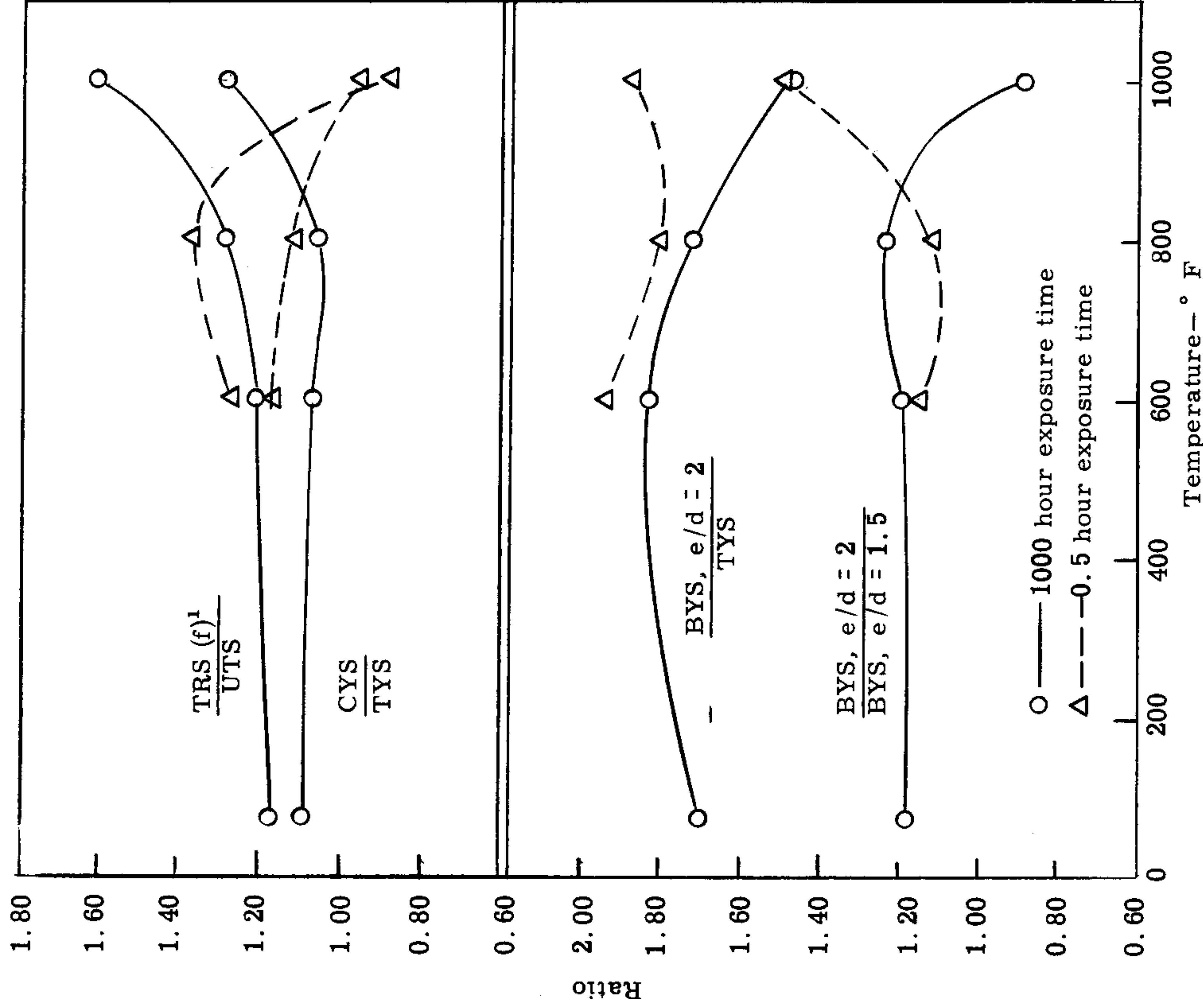

Fig. 143. Effect of temperature on four ratio relationships of properties of 17-7 PH (RH 950) stainless steel sheet.

1. TRS (f)-Tensile rupture strength based on the final cross section

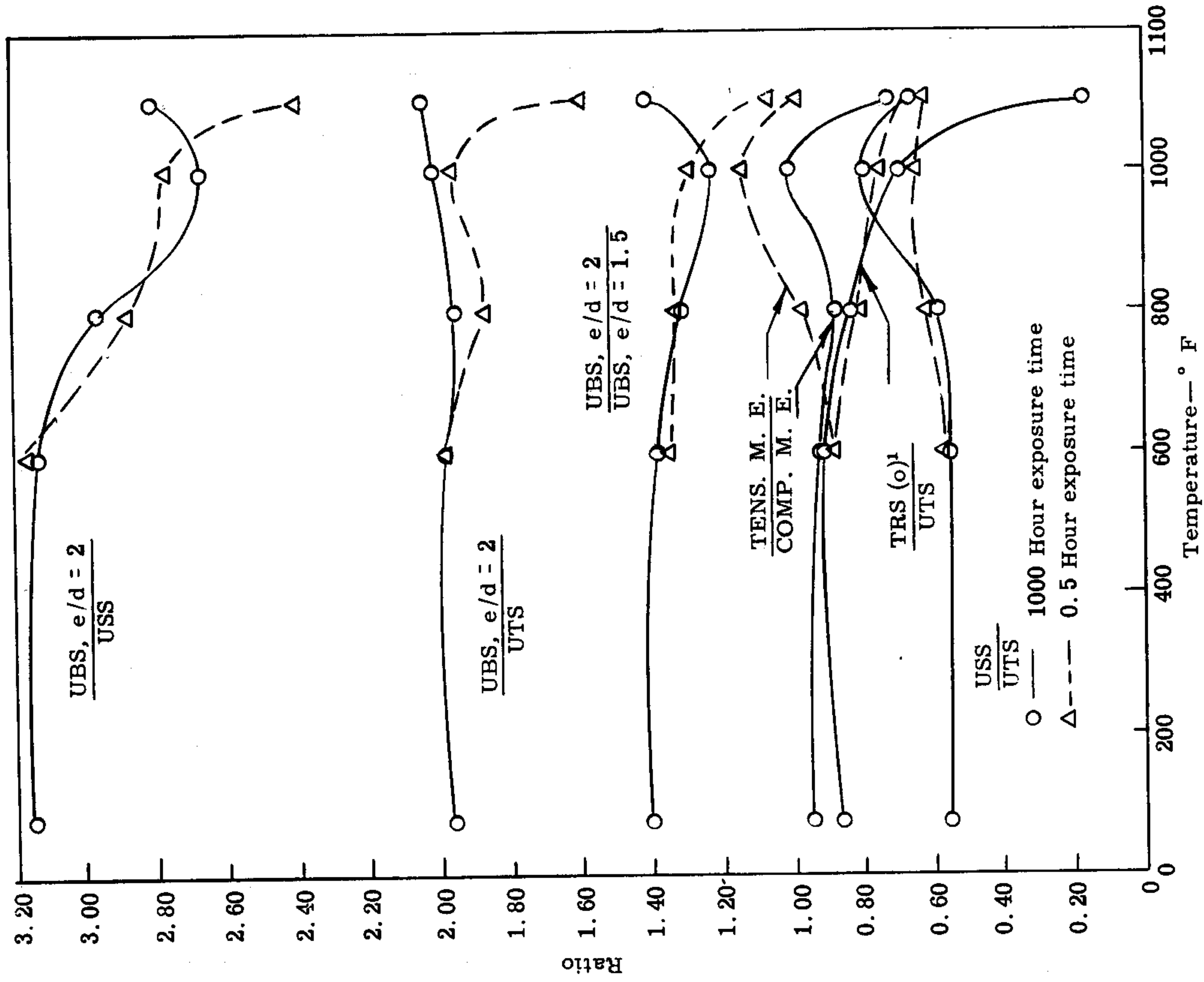

Fig. 144. Effect of temperature on six ratio relationships of properties of quenched and tempered Thermold J alloy steel sheet.

1. TRS (o)-Tensile rupture strength based on original cross section.

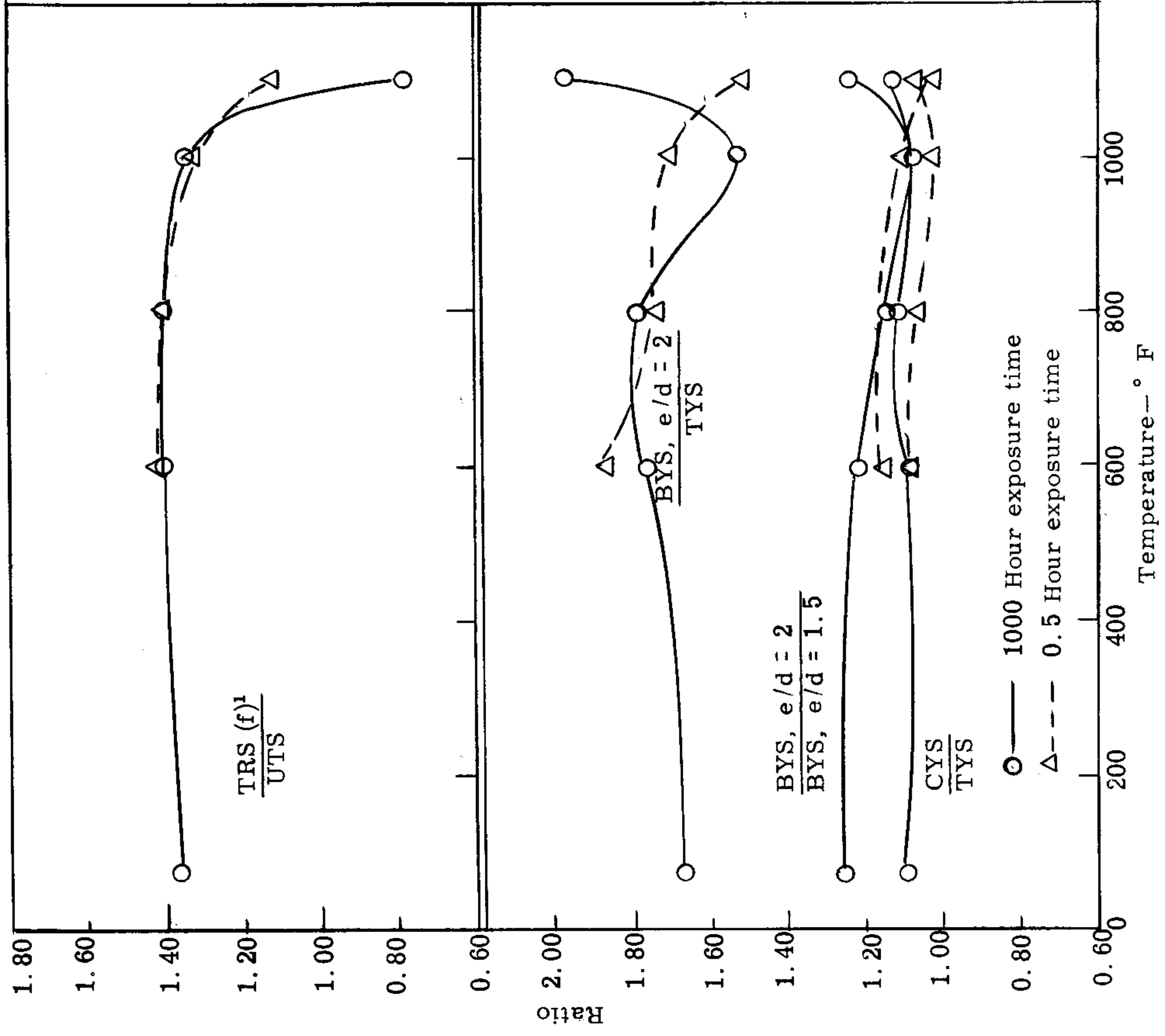

Fig. 145. Effect of temperature on four ratio relationships of properties of quenched and tempered Thermold J alloy steel sheet.

I. TRS (f)-Tensile rupture strength based on the final cross section

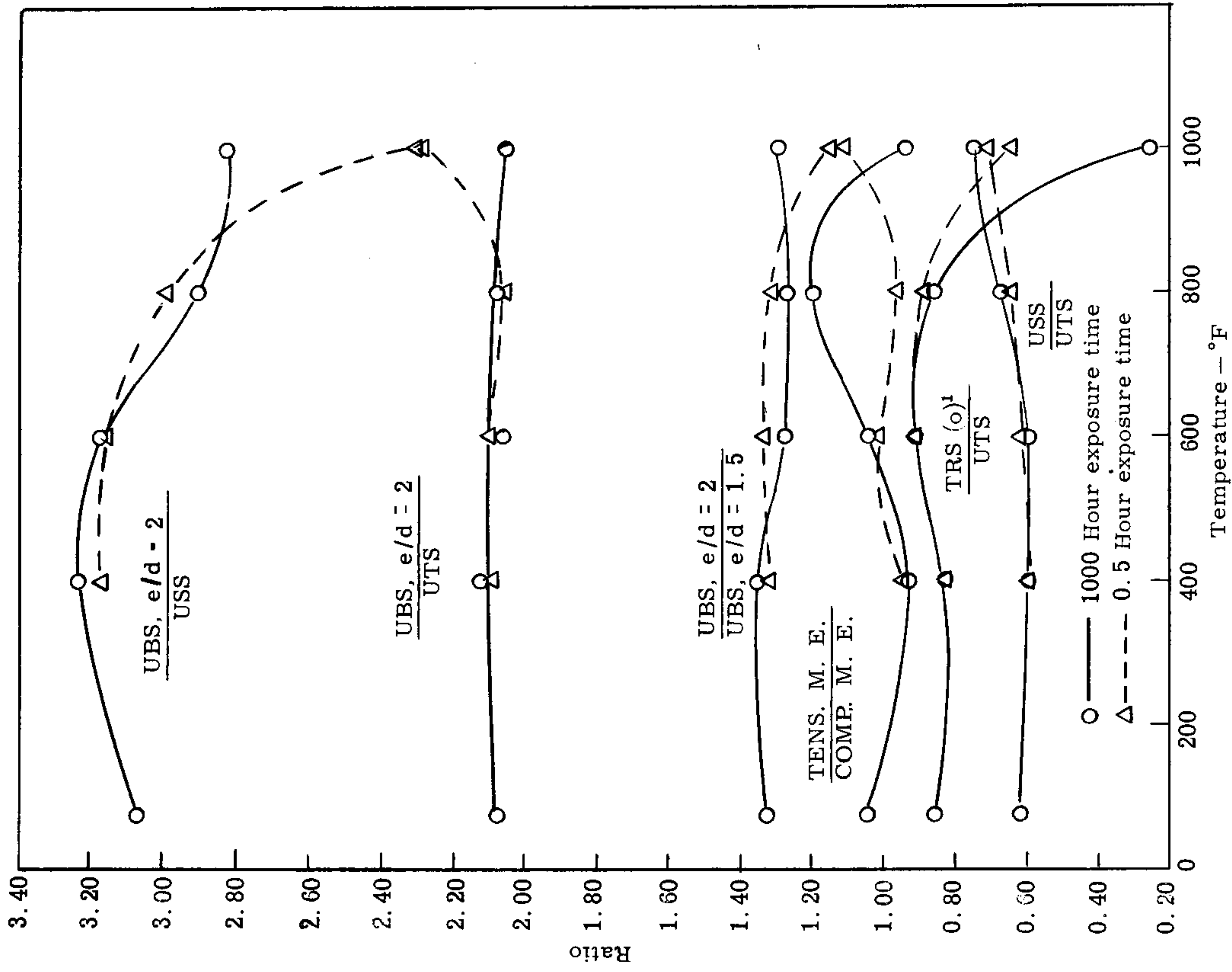

Fig. 146. Effect of temperature on six ratio relationships of properties of quenched and tempered Type 420 stainless steel sheet.

I. TRS (o) - Tensile rupture strength based on the original cross section

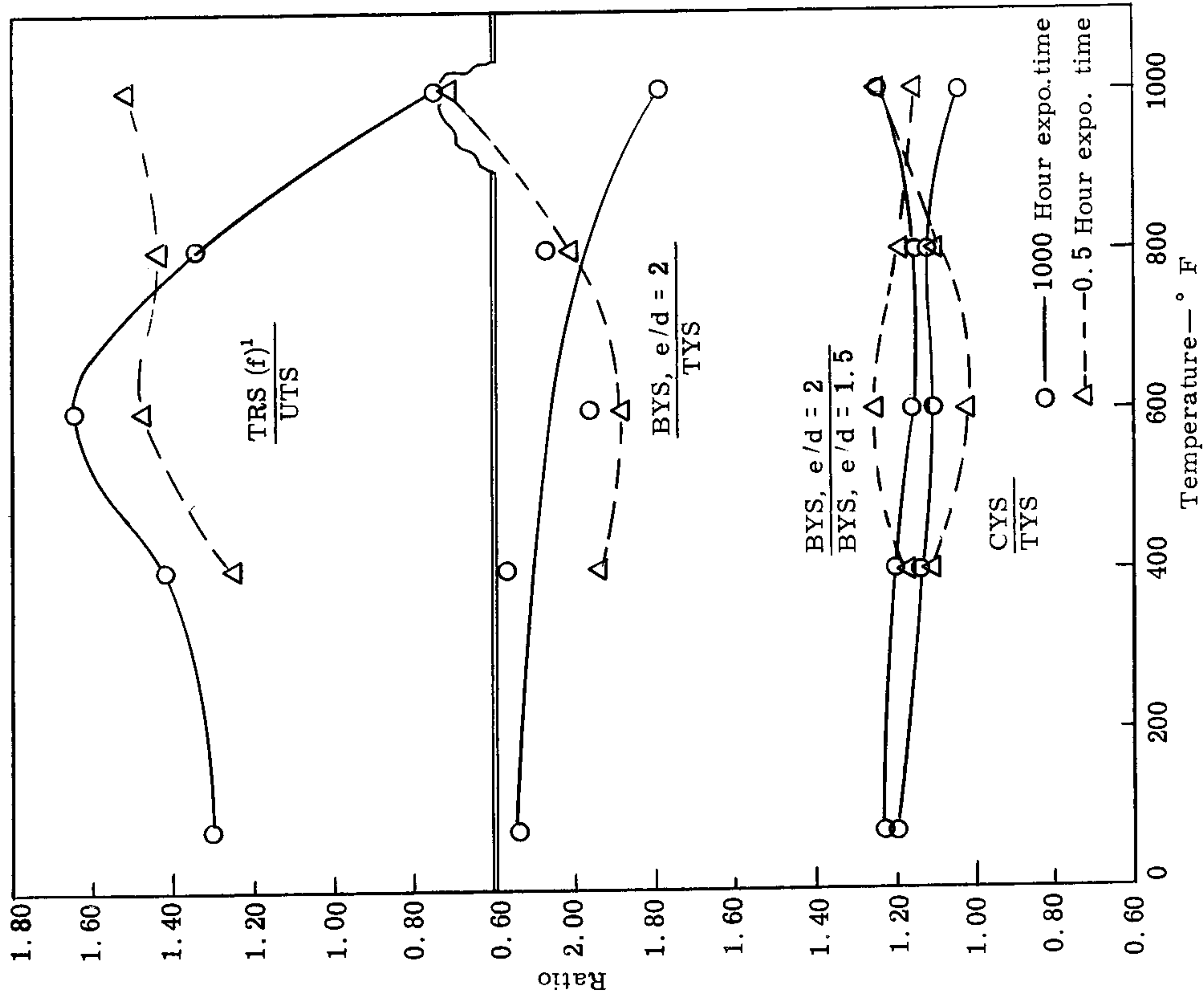

Fig. 147. Effect of temperature on four ratio relationships of properties of quenched and tempered Type 420 stainless steel sheet.

1. TRS (f) - Tensile rupture strength based on the final cross section

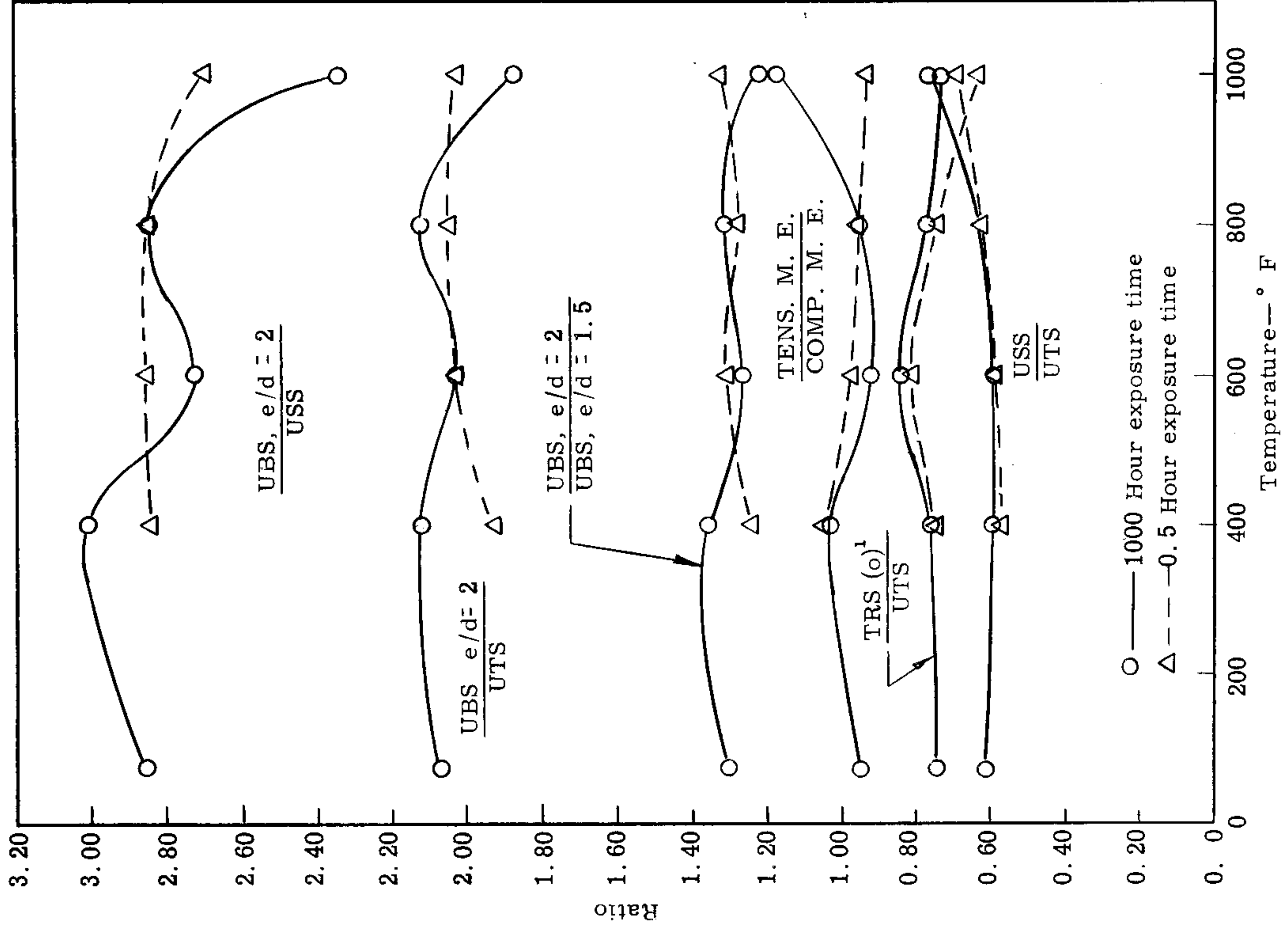

Fig. 148. Effect of temperature on six ratio relationships of properties of quenched and tempered Type 422 stainless steel sheet.

I. TRS (o)-Tensile rupture strength based on the original cross section

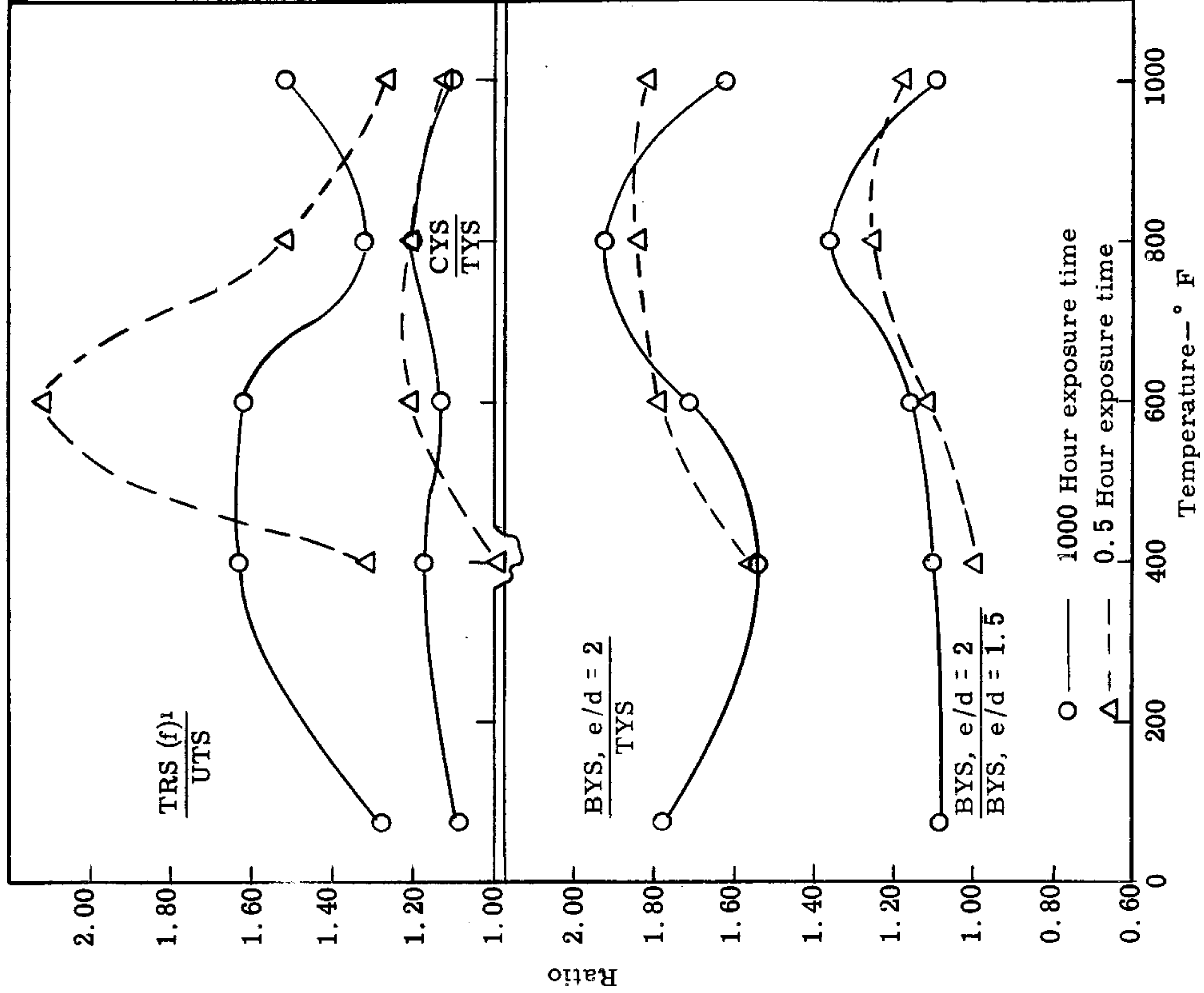

Fig. 149. Effect of temperature on four ratio relationships of properties of quenched and tempered Type 422 stainless steel sheet

1. TRS (f) Tensile rupture strength based on the final cross section

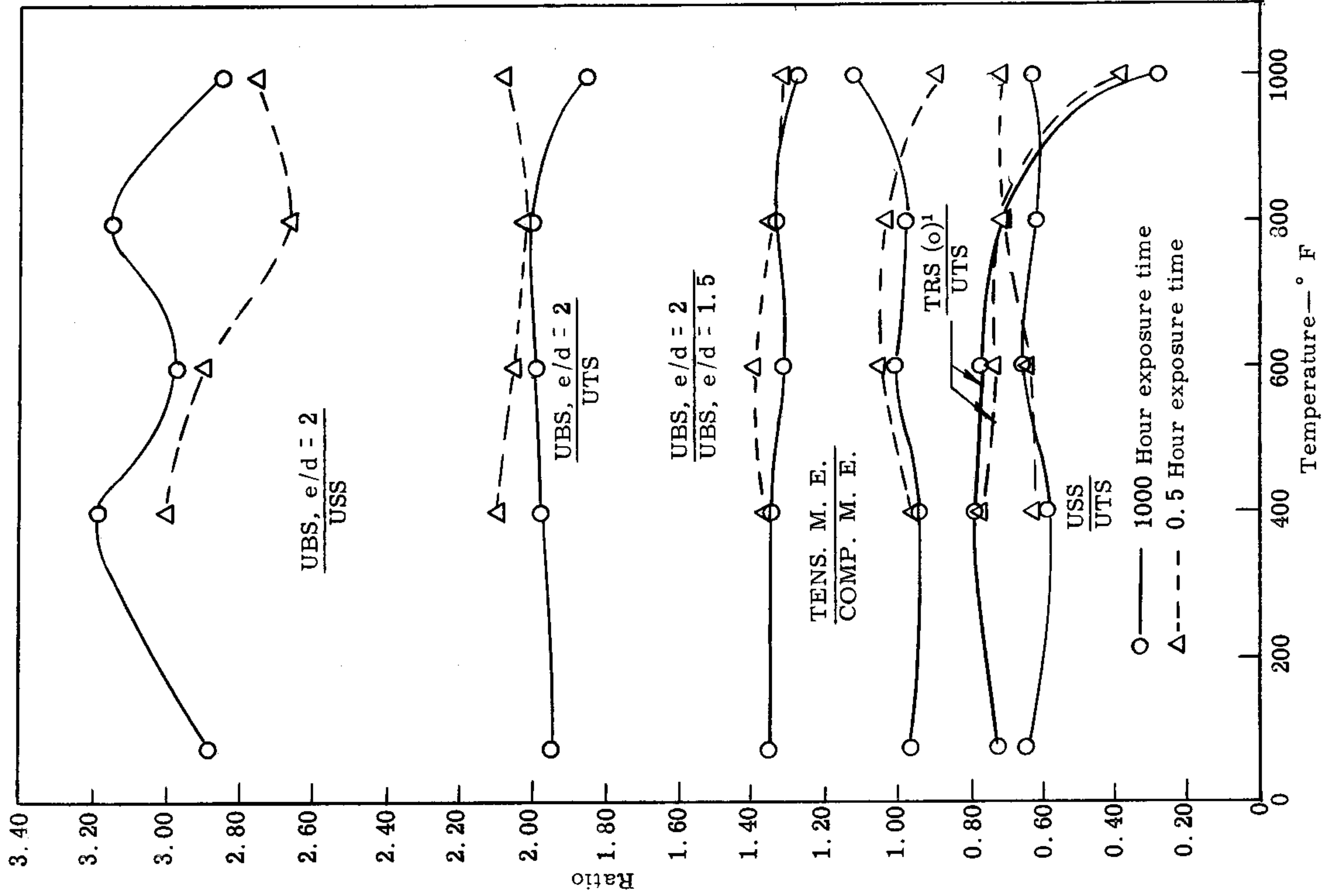

Fig. 150. Effect of temperature on six ratio relationships of properties of quenched and tempered 17-22 A (S) alloy steel sheet.

I. TRS (o) Tensile rupture strength based on the original cross section