

**MAGIC II: AN AUTOMATED GENERAL PURPOSE
SYSTEM FOR STRUCTURAL ANALYSIS**

VOLUME I: ENGINEER'S MANUAL (ADDENDUM)

STEPHEN JORDAN

FOREWORD

This report was prepared by Textron's Bell Aerospace Company (BAC), Buffalo, New York under USAF Contract No. F-33615-69-C-1241. This contract is an extension of previous work initiated under Project No. 1467, "Structural Analysis Methods", Task No. 146702, "Thermal Elastic Analysis Methods". The program was administered by the Air Force Flight Dynamics Laboratory (AFFDL), under the cognizance of Mr. G. E. Maddux, AFFDL Program Manager. The program was carried out by the Structural Systems Department, Bell Aerospace Company during the period 2 December 1968 to 2 December 1970 under the direction of Mr. Stephen Jordan, BAC Program Manager.

This report, "MAGIC II: An Automated General Purpose System for Structural Analysis", is published in three volumes, "Volume I: Engineer's Manual", "Volume II: User's Manual", and "Volume III: Programmer's Manual". The manuscript for Volume I was released by the author in January 1971 for publication as an AFFDL Technical Report.

The author wishes to express appreciation to colleagues in the Advanced Structural Design Technology Section of the Structural Systems Department for their individually significant, and collectively indispensable, contributions to this effort.

The author wishes to express appreciation also to Mr. A. M. Gallo, Miss Beverly J. Dale and Mr. Mark Morgante for the expert computer programming that transformed the analytical development into a practical working tool.

This technical report has been reviewed and is approved.

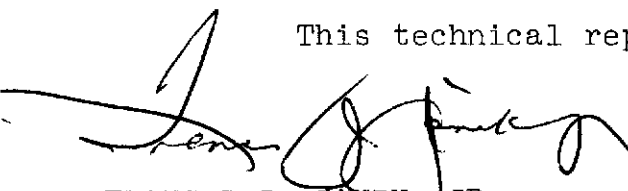

FRANCIS J. JANIK, JR.
Chief, Theoretical Mechanics Branch
Structures Division

ABSTRACT

An automated general purpose system for analysis is presented. This system, identified by the acronym "MAGIC II" for Matrix Analysis via Generative and Interpretive Computations, is an extension of structural analysis capability available in the initial MAGIC System. MAGIC provides a powerful framework for implementation of the finite element analysis technology and provides diversified capability for displacement, stress, vibration and stability analyses.

The matrix displacement method of analysis based upon finite element idealization is employed throughout. Ten versatile finite elements are incorporated in the finite element library. These are frame, shear panel, triangular cross-section ring, trapezoidal cross-section ring (and core), toroidal thin shell ring (and shell cap), quadrilateral thin shell and triangular thin shell elements. Additional elements include a frame element, quadrilateral plate and triangular plate elements which can be used for both stress and stability analysis. The finite elements listed include matrices for stiffness, mass, incremental stiffness, prestrain load, thermal load, distributed mechanical load and stress.

The MAGIC II System for structural analysis is presented as an integral part of the overall design cycle. Considerations in this regard include, among other things, preprinted input data forms, automated data generation, data confirmation features, restart options, automated output data reduction and readable output displays.

Documentation of the MAGIC II System is presented in three parts; namely, Volume I: Engineer's Manual, Volume II: User's Manual and Volume III: Programmer's Manual. The subject document, Volume I (Engineer's Manual - Addendum) is an extension of the primary technical document. Included are the theoretical developments for the additional finite elements included in the MAGIC II System as well as a discussion of newly added computational procedures.

Contrails

TABLE OF CONTENTS

Section		Page
I.	INTRODUCTION	1
II.	ADDITIONAL ANALYSIS AND PROGRAMMING TECHNOLOGY	4
	A. Analysis Technology	4
	B. Program Technology	7
III.	ADDITIONAL FINITE ELEMENT REPRESENTATIONS	13
	A. Introduction	13
	B. Trapezoidal Cross-Section Ring (Core)	14
	I. Introduction	14
	II. Assumed Displacement Functions	18
	III. Potential Energy	20
	IV. Element Static Matrices	21
	4.1 Introduction	21
	4.2 Stiffness Matrix	21
	4.3 Pressure Load Matrix	25
	4.4 Prestrain Load Vector	31
	4.5 Thermal Load Vector	34
	4.6 Gravity Load and Centrifugal Force Vectors	38
	4.7 Stress Matrix	43
	V. Kinetic Energy	45
	C. Quadrilateral Plate Element	50
	I. Introduction	50
	II. Development of Linear Elastic Membrane Stiffness Matrix	51
	III. Geometric Properties	58
	IV. Development of Initial Force Terms	60
	V. Stress Equations	62
	VI. Development of Linear Elastic Stiffness Matrix (Bending)	65
	VII. Development of the Incremental Stiffness Matrix	71
	VIII. Geometric Properties	78
	IX. Development of Corner Thermal Moments	80
	X. Criterion for the Singularity of the Matrix	88
	D. Triangular Plate Element	90
	I. Introduction	90
	II. Development of Linear Elastic Membrane Stiffness Matrix	91
	III. Development of Initial Force Terms	96
	IV. Stress Equations	99
	V. Development of Linear Elastic Stiffness Matrix (Bending)	102
	VI. Development of Incremental Stiffness Matrix	109
	VII. Geometric Properties	114
	VIII. Development of Corner Thermal Moments	116
	IX. Development of Stress Resultant Bending and Twisting Moments and Vertical Shear Forces	118

Section		Page
	E. Incremental Frame Element	126
	I. Introduction	126
	II. Additional Element Matrices	126
IV.	COMPUTATIONAL PROCEDURES	133
	A. Introduction	133
	B. Static Substructuring	133
	C. Dynamic Substructuring	146
V.	DISCUSSION AND CONCLUSIONS	166
	A. Discussion	166
	B. Conclusions	173
VI.	REFERENCES	175

Contrails

LIST OF FIGURES

FIGURE		PAGE
II.1	MAGIC I System Finite Elements	5
II.2	MAGIC II System Additional Finite Elements	6
II.3	MAGIC II - Digital Computer Program	8
III.1	Trapezoidal Cross-Section Ring Element	15
III.2	Core Element Specialization of Trapezoidal Cross-Section Ring Element	16
III.3	Geometry of Arbitrary Quadrilateral Plate Element	52
III.4	Equation III-8	55
III.5	Quadrilateral Plate Flexural Element	66
III.6	Quadrilateral Element, $[B]$ Matrix (Flexure)	68
III.7	Quadrilateral Element, $[C_f]$ Matrix (Flexure)	69
III.8	$[C_{n_x}]$ Matrix for Quadrilateral Flexural Element	76
III.9	$[C_{n_y}]$ Matrix for Quadrilateral Flexural Element	77
III.10	$[C_{n_{xy}}]$ Matrix for Quadrilateral Flexural Element	78
III.11	$[g]$ Matrix for Quadrilateral Plate Element	85
III.12	Triangular Plate Flexural Element	103
III.13	Definition of Integrals in $[C]$ Matrix, Triangular Plate Element	122
III.14	Additional Integral Definition, Triangular Plate Element	124
III.15	Incremental Frame Element Representation	126



SECTION I

INTRODUCTION

The MAGIC II Systems for Structural Analysis is a logical extension of the original MAGIC System reported in References 1, 2 and 3. All capabilities available from the original MAGIC System have been retained. Extension of the program capability is primarily in the following areas.

- (a) The implementation of four additional finite element representations and their associated element matrices.
- (b) The improvement of output displays to facilitate ease of interpretation by the User.
- (c) The provision of an "Agendum Library" to accommodate the following classes of analyses.
 - (1) Statics
 - (2) Statics with Condensation
 - (3) Statics with Prescribed Displacements
 - (4) Stability
 - (5) Dynamics (Modes and Frequencies)
 - (6) Dynamics (with Condensation)
- (d) The addition of an out-of-core eigenvalue routine for the nonsymmetric matrices based on the power method "on the order of" 3000 x 3000.
- (e) The addition of improved and expanded error diagnostics.
- (f) The addition of a prescribed displacement option to accommodate more than one load condition per execution.
- (g) The addition of the capability to accept either rectangular, cylindrical or spherical coordinates as input data.
- (h) The addition of miscellaneous arithmetic modules to the System to support the computational procedures.

Contrails

- (i) The addition of a new assembly module to increase the permissible assembled system matrix size.

Documentation of the MAGIC II System for structural analysis is presented in three volumes. The subject volume (Volume I) is an addendum to the primary technical report documented in Reference 1. Separate supplementary volumes are provided to facilitate utilization of the MAGIC II System. Volume II, the User's Manual⁽⁴⁾, includes detailed specifications for the preparation of input data, along with illustrative examples. Volume III, the Programmer's Manual⁽⁵⁾, presents information on the organization of the MAGIC II System as well as its operational characteristics.

It is to be noted that this addendum is to be used in conjunction with the original technical report (Reference 1) in order to utilize the MAGIC II System effectively.

Section II presents a discussion of additional analysis and programming technology which has been incorporated into the MAGIC II System. New computational procedures and expanded size characteristics are emphasized.

A general theoretical description of the additional finite element representations (and element matrices) included in the MAGIC II System is given in Section III. These elements are as follows:

- (a) Trapezoidal Cross-Section Ring (Core)
- (b) Quadrilateral Plate
- (c) Triangular Plate
- (d) Incremental Frame

Section IV presents a discussion of the computational procedures available in the MAGIC II System. Included are procedures for Statics, Statics with Condensation, Statics with Prescribed Displacements, Stability, Dynamics (Modes and Frequencies) and Dynamics with Condensation. Additional procedures are outlined for Static and Dynamic Substructuring.

Contrails

The body of this technical report is concluded with a general retrospective discussion in Section V. Limitations of the MAGIC II System are discussed and guidelines for utilization are presented.

SECTION II

ADDITIONAL ANALYSIS AND PROGRAMMING TECHNOLOGY

A. ANALYSIS TECHNOLOGY

The MAGIC II System incorporates the ten finite elements shown in Figures II.1 and II.2. The six finite elements shown in Figure II.1 were available in the original MAGIC System and are discussed in detail in Reference 1. The four additional finite elements shown in Figure II.2 are described in detail in Section IV.

The set of matrices embodied in each element representation determines the type of analyses which can be performed. In the MAGIC II System, a complete element representation is taken to include matrices for stiffness, incremental stiffness, pressure load, prestrain load, thermal load, stress, and mass. Moreover, provision has been made for additional element matrices such as consistent damping matrices.

The types of analyses available with the MAGIC II System are as follows:

- (a) Statics
- (b) Statics (With Condensation)
- (c) Statics With Prescribed Displacements
- (d) Stability
- (e) Dynamics (Modes and Frequencies)
- (f) Dynamics (With Condensation)

In addition many user variations of the above computational procedures are available with the System. This is possible due to the powerful matrix abstraction capability available from the MAGIC II System. A complete description of the computational procedures listed above along with example problems which demonstrate their use is provided in Volume II of this report (User's Manual).

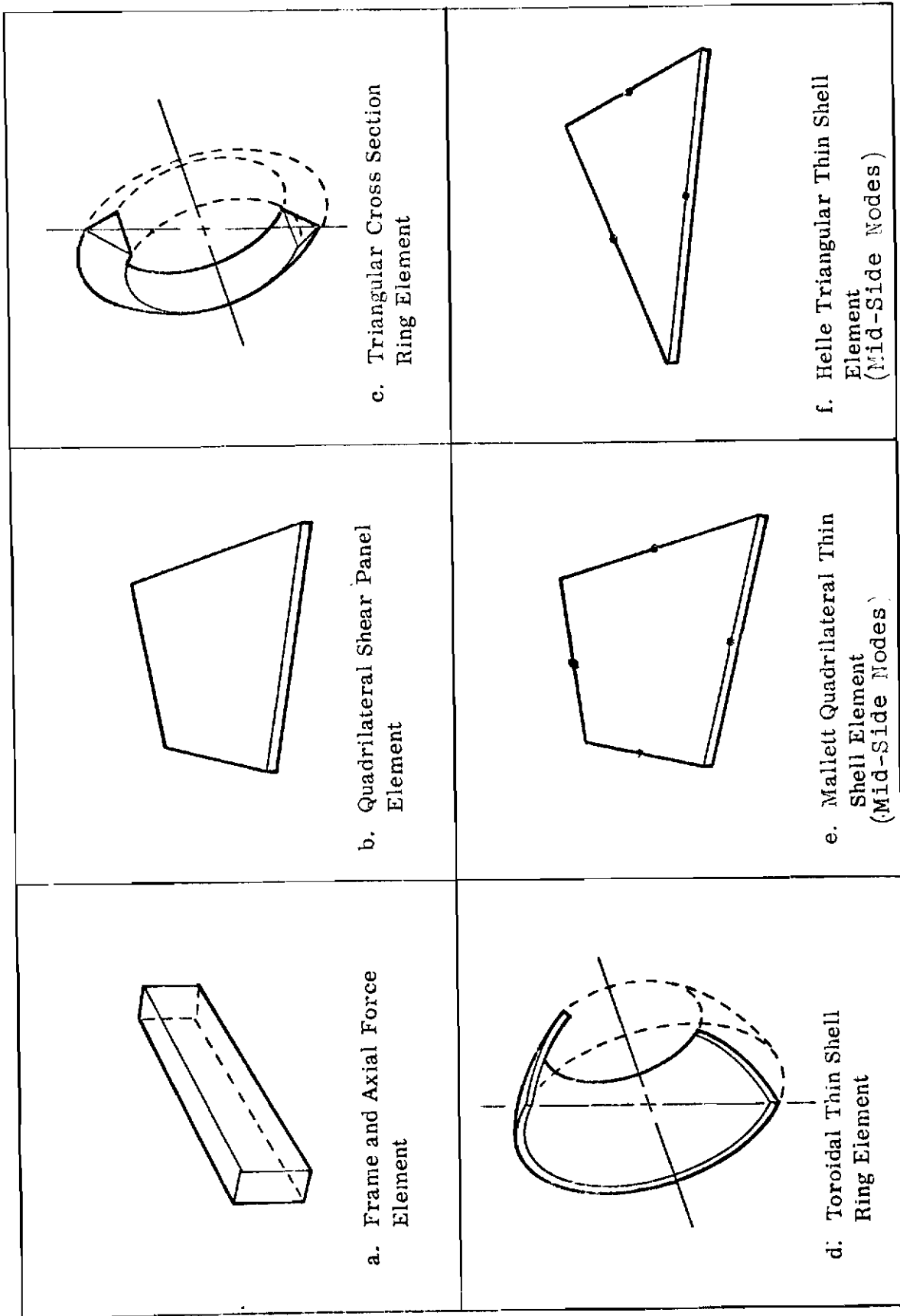

Figure II. JMAGIC System Finite Elements

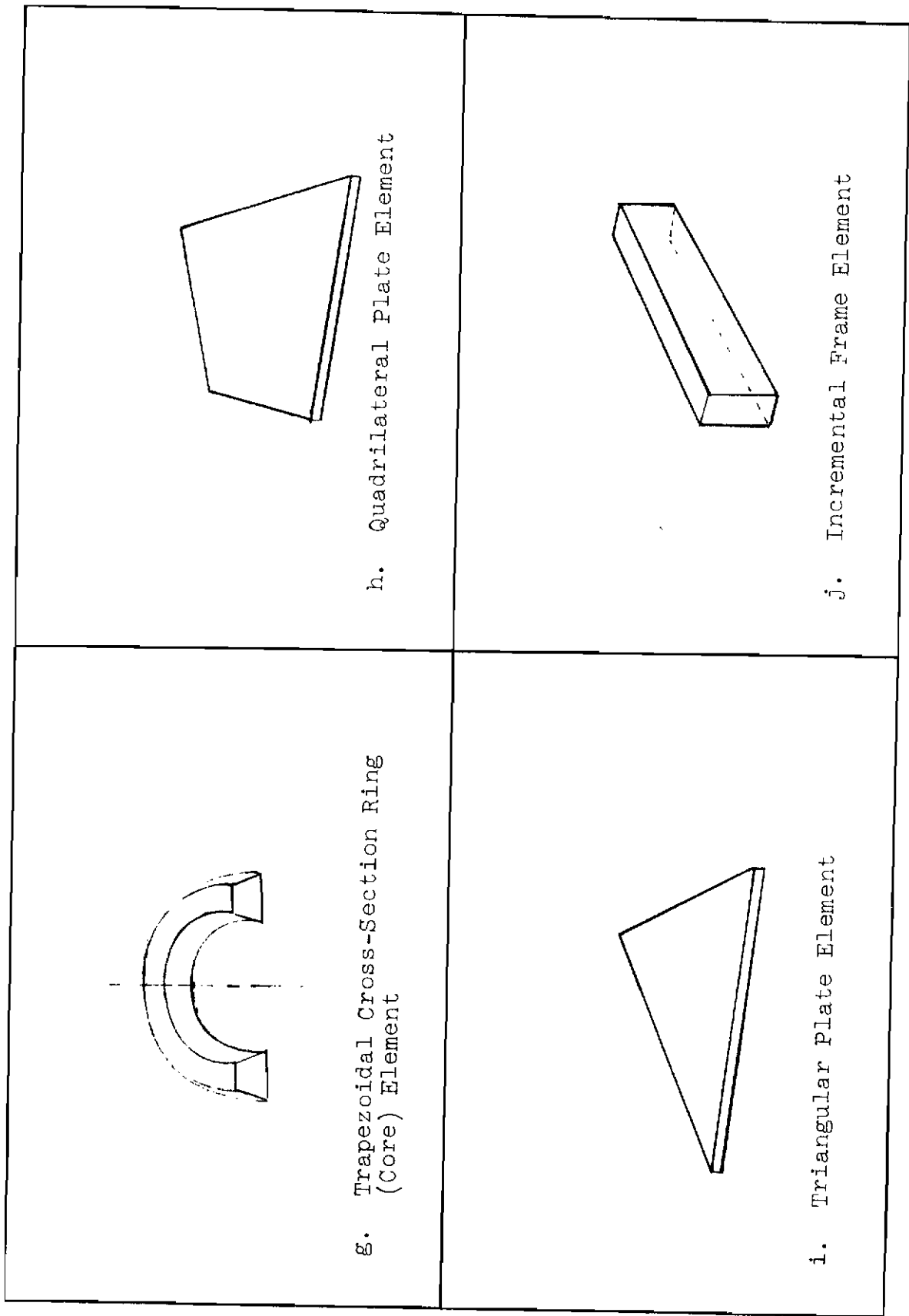

Figure II.2 MAGIC II System Additional Finite Elements

B. PROGRAMMING TECHNOLOGY

In this section additional programming technology available with the MAGIC II System is discussed. Volume III of this report (Programmer's Manual) is suggested for complete documentation on program technology.

I. General Description

The general arrangement of the MAGIC II digital computer program system is shown in Figure II.3. The supervisory program consists of the FORMAT control and two monitors; the Preprocessor Monitor, and the Execution Monitor. The main program controls the normal two phase operation by delegating control, in turn, to the two monitors.

The preprocessor Monitor directs the processing of card input data describing the machine configuration, the problem specification, the abstraction instruction sequence and the matrix data.

A standard, modified standard, or totally new machine configuration may be defined for each MAGIC II case.

General output format and labeling information, and identifying names of the master input and output data sets (tapes) constitute the problem specification data.

The matrix and pseudo-matrix operations are input in the required sequence of execution in the abstraction instruction sequence. Abstraction instructions are submitted in free form on standard Fortran coding sheets for punched card reproduction.

Card input matrix data are specified on a standard form. Matrices may be of order 3000x3000, and may contain up to 6000 randomly ordered, single precision real elements (with 32K core storage unit).

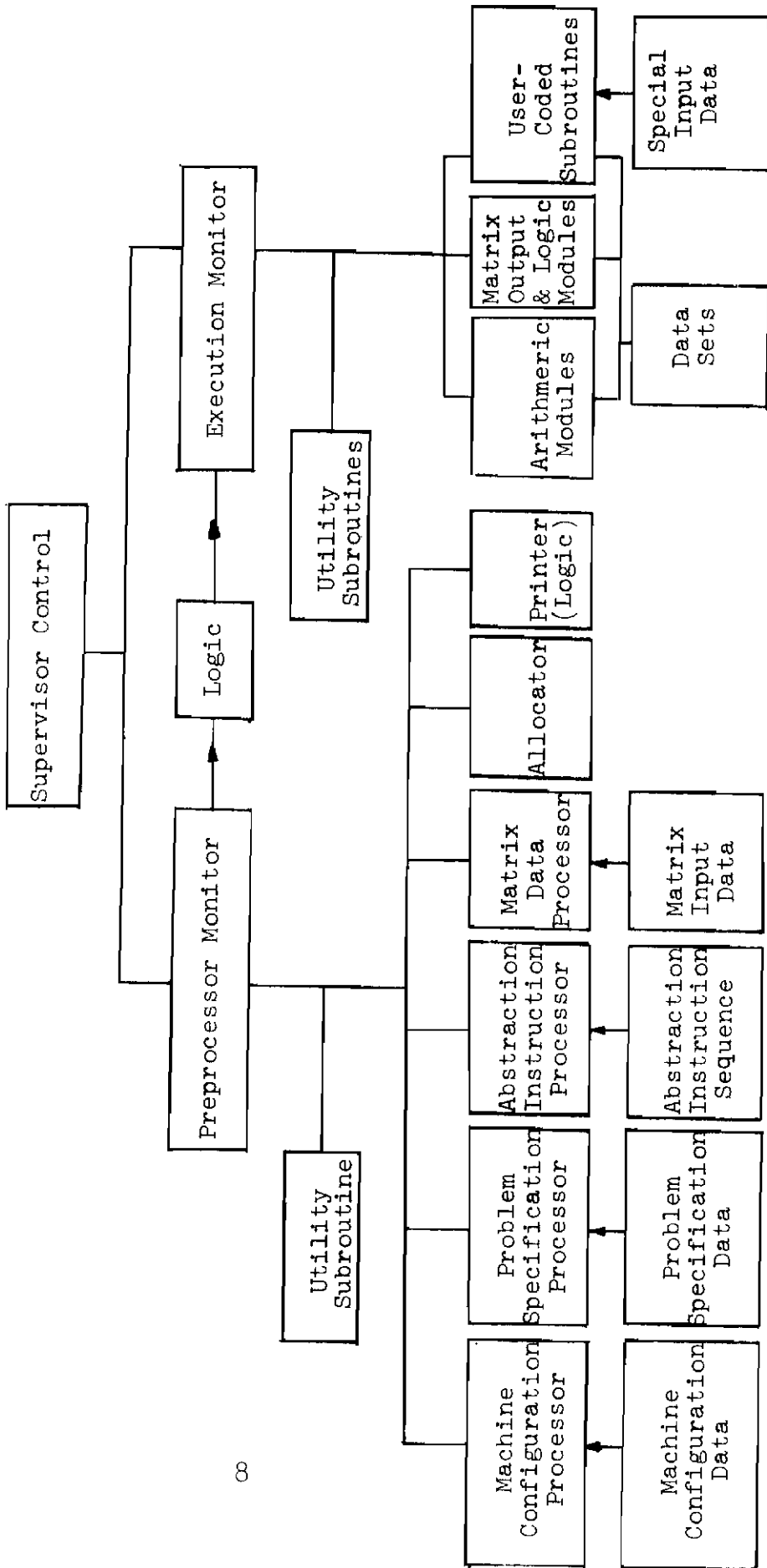

Figure II.3 MAGIC II - Digital Computer Program

Contrails

For the general case, preprocessing involves straightforward sequential processing of data by each of the modules under the Preprocessor Monitor. Special preprocessing can be specified by proper use of the control cards described in the User's Manual.

The final preprocessor operation is to pre-plan the data storage allocation through the problem and to record this program of the "complete problem solution logic" for use by the Execution Monitor.

The standard matrix operational modules provide for matrix addition, subtraction, multiplication, and transpose multiplication, with optional concurrent scaling, and for matrix scalar multiplication, transposition, adjoining, dejoining, and inversion. Modules for the solution of simultaneous equations by elimination and iterative techniques complete the basic standard matrix operation capability of the system.

The pseudo-matrix operational modules provide for the element by element multiplication of two matrices of identical order, the elements of a matrix to be raised to a scalar power, the extraction of the algebraic maximum and minimum elements of the rows or columns of a matrix (i.e., the envelope of a matrix), the diagonalization of a row or column matrix, the generating of null and identity matrices, and the renaming of a matrix. Included in the classification of pseudo-matrix operational modules is the "Structure Cutter" subroutine which generates a well conditioned solution of "n" linear simultaneous equations in "m" unknowns by Jordanian elimination (where $n \leq m$).

Matrices produced as the results of standard and pseudo-matrix operations may be as large as 3000x3000 with no restriction on population density. Storage of matrix data is by column sort, and when individual column population density is less than 50 percent, storage is in compressed format. In compressed format, each non-zero element and its corresponding row location are sequentially stored, and zero elements are omitted. Where feasible, the sub-routines operate directly on the compressed data.

Contrails

MAGIC II includes two subroutines for the calculation of eigenvalues. The first subroutine calculates the specified number of eigenvalues, beginning with the largest, and the corresponding eigenvalues of a matrix, whose maximum order is limited by the working core storage available to the subroutine. Typically, with a 32K storage unit, the matrix may be as large as 160 x 160. This subroutine is written for a real symmetric matrices only. The second subroutine also calculates the specified number of eigenvalues and eigenvectors beginning with the largest eigenvector. However, the real eigenmatrix can be symmetric or nonsymmetric and the only limit on its order is the amount of working storage available to the MAGIC System.

Up to nine special operational subroutines can be coded by the user and added to the system. The fourth user coded module is the structural generative system of MAGIC and is described in detail in the User's Manual.

The sequence of operation is controlled by simple abstraction instructions prepared by the User, keypunched, and read directly by the machine. Comments may be included in the abstraction instruction sequence for explanation of the results.

Limited logic is available in the form of a conditional transfer. A matrix may be tested for nullity and, if true, control will be transferred forward to a specified abstraction instruction in the sequence. Conditional transfer is limited to a "skip ahead" in the abstraction instruction sequence.

Matrices can be printed in a standard form, with small number suppression and row-column labeling. The matrix elements are printed as floating point numbers with optional exponent.

The normal printed output for a MAGIC II case includes a listing produced by the preprocessor. The listing unconditionally includes all control and specification data together with the complete abstraction instruction sequence. The listing will also include matrix input data, special input data, and the machine generated "complete problem solution logic" if the appropriate options are chosen in the control data.

Contrails

II. Structural Abstraction Instructions

In designing the MAGIC II System for Structural Analysis, provision was made for accommodating new abstraction instructions peculiar to the .USER04. module. In keeping with the philosophy of generating a highly flexible USER oriented system, specialized instructions were designed for items such as element stress and force determination, element assembly and print controls. These additional USER options provide output capabilities of the MAGIC II System, consistent with input requirements.

The following abstraction instructions, .STRESS., .FORCE., .ASSEM., .EPRINT., and .GPRINT. are to be used in conjunction with the .USER04. abstraction instruction.

To compute the net element stress matrix and generate optional engineering print of apparent element stresses, element applied stresses and net element stresses use the .STRESS. abstraction instruction.

To compute the net element force matrix and generate optional engineering print of apparent element forces, element applied forces and net element forces use the .FORCE. abstraction instruction.

To assemble the element stiffness matrices, element mass matrices, element incremental matrices and element thermal load matrices as output by the .USER04. instruction use the .ASSEM. abstraction instruction.

To generate engineering printout of the net element stresses or net element forces use the .EPRINT. abstraction instruction.

To generate engineering printout of reactions, displacements, eigenvalues and eigenvectors, and user matrices use the .GPRINT. abstraction instruction.

A complete discussion of the above listed instructions along with a detailed explanation of their proper usage is presented in Section II.B.f of the User's Manual.

III. Size Characteristics

The size characteristics of the MAGIC II System are twofold: first, there are the size characteristics of the program itself and second, those associated with the problem solving capability. Considering the former, the MAGIC II System contains 356 subroutines (approximately 38000 FORTRAN IV source cards) logically designed into 43 overlay links on an IBM 360/65 using 45600 words of storage. The overlay design reflects the optimum use of available storage, yet maintains respectable execution efficiency.

The MAGIC II System offers large scale capability with no penalties to small applications due to the fact that out of core operations are not utilized unless the magnitude of the application requires them.

The scale of the analysis capability provided via the MAGIC II System can be characterized as "on the order of" 3000 displacement degrees-of-freedom using 45600 words of storage on an IBM 360/65 digital computer. Other relevant maximum size characteristics are 3000 discrete elements and 1000 gridpoints. Matrices which are card input may be of order 3000 x 3000 and contain up to 6000 single-precision real non-zero elements.

The MAGIC II System needs a minimum of eight external storage units to operate, distributed into the following functions: one unit assigned as Instruction storage for the Execution Monitor, one unit assigned as a Master Input Unit, one unit assigned as a Master Output Unit, and five units assigned as Input/Output Utility Units. Every effort should be made to make the most external storage units possible available, since any increase in the available storage units increases execution efficiency.

SECTION III

ADDITIONAL FINITE ELEMENT REPRESENTATIONS

A. INTRODUCTION

The MAGIC II System incorporates ten finite element representations. Six of these elements, namely, frame, shear panel, triangular cross-section ring, toroidal thin shell ring, quadrilateral thin shell and triangular thin shell were available in the initial MAGIC System and are described in detail in Reference 1.

Four additional elements, namely, trapezoidal cross-section ring (core), quadrilateral plate, triangular plate and incremental frame have been incorporated into MAGIC II. A complete element representation is taken to include matrices for stiffness, stress, incremental stiffness, pressure load, prestrain load, thermal load and mass.

In the following sections, each of the element representations along with associated element matrices are discussed in detail.

B. TRAPEZOIDAL CROSS-SECTION RING (CORE)

I. Introduction

The formulation of the trapezoidal cross-section ring discrete element described herein, if derived from, and is mathematically consistent with, the formulation described in Reference 6.

The trapezoidal cross-section ring discrete element, shown in Fig. III.1, provides a powerful tool for the analysis of thick walled and solid axisymmetric structures of finite length. It may be used alone or if the problem dictates a highly irregular grid work, it may be combined with the well known triangular ring discrete element (7) to form the assembly of any axisymmetric structure taking into account:

1. arbitrary variations in geometry
2. axial variation in orientation of material axes of orthotropy
3. radial and axial variations in material properties
4. any axisymmetric loading system which can include pressure, and temperature, and degradation of material properties due to temperature.

For the analysis of solid structures, a core discrete element (8) has been developed to be used in conjunction with the trapezoidal or triangular cross-section discrete element. This core element (Fig. III.2) is a specialization of the trapezoidal cross-section ring element.

The discrete element technique was first applied to the analysis of axisymmetric solids by Clough and Rashid (9) and later the formulation of the triangular cross-section ring was extended by Wilson (10) to include non-axisymmetric loading. This development deals with the axisymmetric case but includes orthotropic material properties. The integration of the strain-energy over the volume of the ring is effected analytically, and finally pre-strain, and pressure load vectors as well as a consistent mass matrix are included. Thus the following element representation is

Contrails

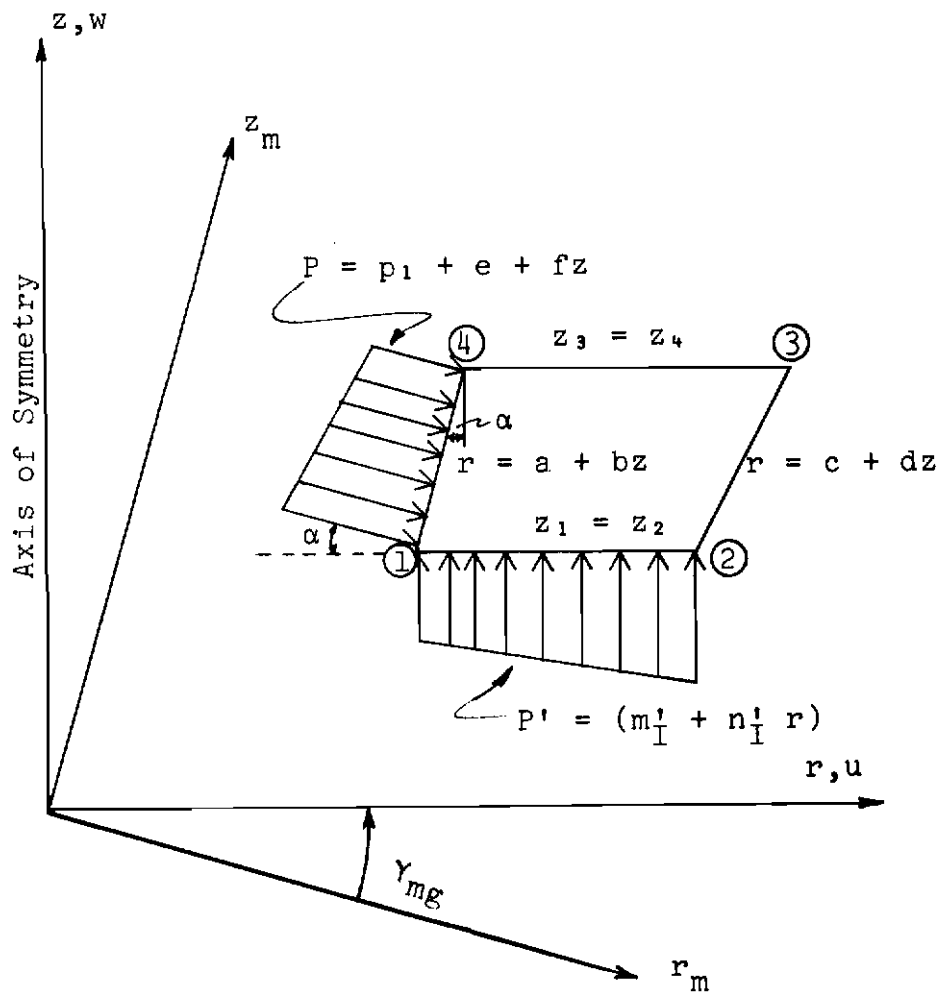

$$a = r_1 - \left(\frac{r_4 - r_1}{z_4 - z_1} \right) z_1$$

$$b = \frac{r_4 - r_1}{z_4 - z_1}$$

$$c = r_2 - \left(\frac{r_3 - r_2}{z_3 - z_2} \right) z_2$$

$$d = \frac{r_3 - r_2}{z_3 - z_2}$$

FIGURE III.1 TRAPEZOIDAL CROSS-SECTION RING DISCRETE ELEMENT

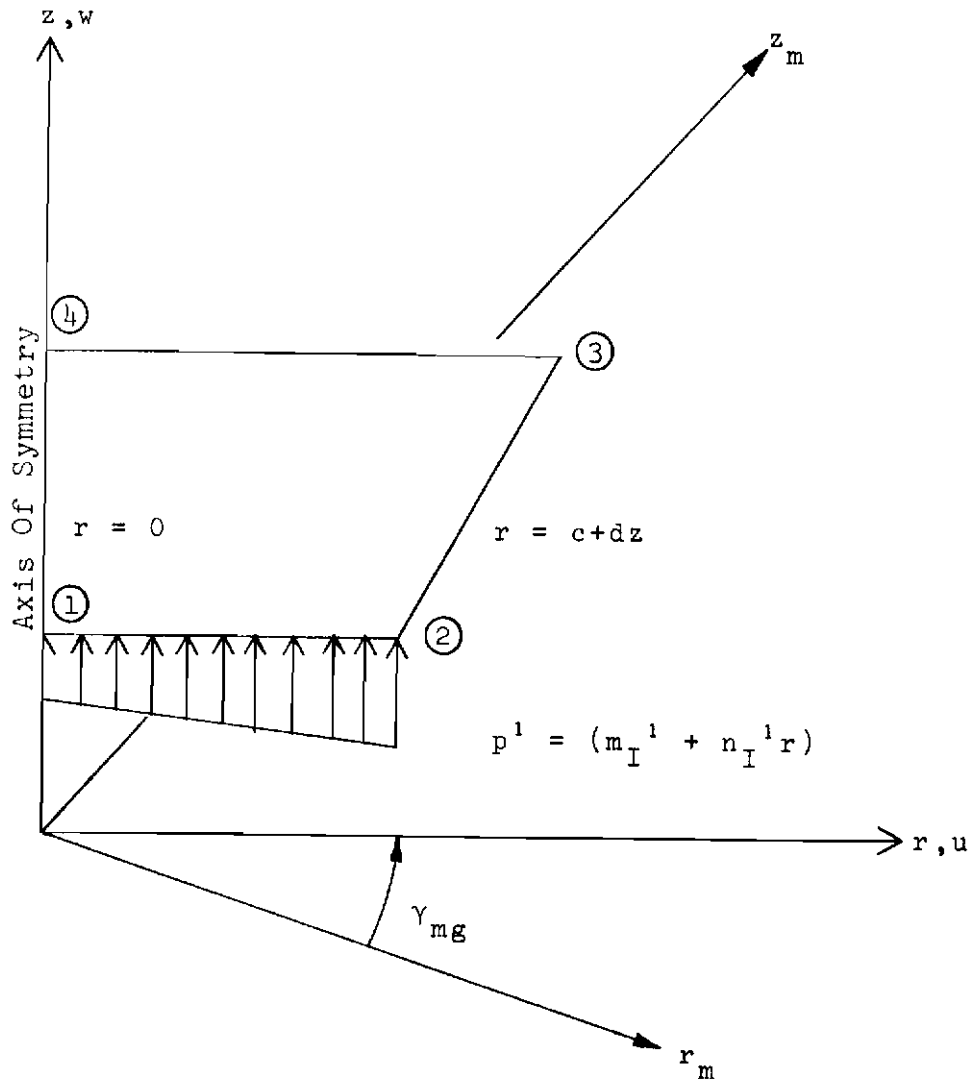

Special Conditions On Core Element

(a) $r_1 \equiv r_4 \equiv 0$

(b) $u_1 \equiv u_4 \equiv 0$

FIGURE III.2 CORE ELEMENT SPECIALIZATION OF TRAPEZOIDAL CROSS-SECTION RING DISCRETE ELEMENT

Contrails

formulated to include algebraic expressions for the following matrices (1);

1. Stiffness , [K]
2. Stress , [S]
3. Consistent Mass , [M]
4. Pressure Load , {F_P}
5. Thermal Load , {F_T}
6. Gravity Load , {F_G}
7. Centrifugal Force , {C_G}

The above matrices arise as coefficient matrices in the generalized form of the Lagrange Equations for the element. The generalized form of the Lagrange equation appropriate for the complete element representation listed above is given by,

$$\frac{\delta \Phi_1}{\delta q_r} + \frac{d}{dt} \left(\frac{\delta \Phi_2}{\delta \dot{q}_r} \right) = 0$$

q_r = generalized displacement

\dot{q}_r = generalized velocity

Φ_1 = total potential energy

Φ_2 = kinetic energy

II Assumed Displacement Functions

A structural element is mathematically discretized into a finite number of degrees of freedom by the assumption of displacement function mode shapes. The displacement modes employed for the trapezoidal ring may be written as:

$$u(r, \theta, z) = \alpha_1 + \alpha_2 r + \alpha_3 z + \alpha_4 r z \quad (2.1)$$

$$w(r, \theta, z) = \beta_1 + \beta_2 r + \beta_3 z + \beta_4 r z \quad (2.2)$$

It is to be noted that the assumed displacement functions are interelement continuous when the elements employed are rectangular. The coefficients α and β which appear in the assumed displacement functions will be referred to as field coordinate displacement degrees of freedom. The transformation from field coordinates to grid point displacement degrees of freedom (u_i) is effected by writing:

$$u_i(r_i, \theta_i, z_i) = \alpha_1 + \alpha_2 r_i + \alpha_3 z_i + \alpha_4 r_i z_i \quad (2.3)$$

Hence

$$\{\alpha\} = [h]\{u\} \quad (2.4)$$

also

$$w_i(r_i, \theta_i, z_i) = \beta_1 + \beta_2 r_i + \beta_3 z_i + \beta_4 r_i z_i \quad (2.5)$$

Then

$$\{\beta\} = [h]\{w\} \quad (2.6)$$

Upon combination of (2.4) and (2.6) we have

$$\{\gamma\} = [H]\{q\} \quad (2.7)$$

Contrails

where

$$\{\gamma\}^T = [\alpha_1, \alpha_2, \alpha_3, \alpha_4, \beta_1, \beta_2, \beta_3, \beta_4] \quad (2.8)$$

$$\{q\}^T = [u_1, w_1, u_2, w_2, u_3, w_3, u_4, w_4] \quad (2.9)$$

A special case arises when the trapezoidal ring is to be used as a core element. For this (see Figure III.2) $r_1 \equiv r_4 \equiv 0$ and $u_1 \equiv u_4 \equiv 0$. This causes the quantities α_1 and α_3 in the assumed displacement mode to be equal to zero, which causes the $[H]$ matrix to be modified. This modified matrix is designated $[\hat{H}]$ for the core element specialization.

III Potential Energy

The total potential energy is derived in this section as the sum of the strain energy and external work contributions.

The procedure followed is exactly the same as that detailed in Reference 1.

The desired form of the potential energy is as follows:

The desired

$$U = \frac{1}{2} \int_V [\{\epsilon\} [E] \{\epsilon\} - \{\epsilon\} [E] \{\epsilon_i\}] dV \quad (3.1)$$

IV Element Static Matrices

4.1 Introduction

In order to effect the discretization of the element, the assumed displacement modes must be introduced into the potential energy function. Substitution of the total potential energy function into the Lagrange equation yields the element matrices with respect to grid point displacement degrees of freedom. An exception is the element stress matrix which is derived from the strain-displacement and stress-strain relationships.

4.2 Stiffness Matrix

The energy contribution to the linear elastic stiffness is

$$\phi_k = \frac{1}{2} \int_V [\epsilon][E]\{\epsilon\}dV \quad (4.2.1)$$

The strains can be expressed in terms of the generalized coordinates using Equations (2.1), (2.2), and the fact that $\{\epsilon\}^T = [u_r, u/r, w_z, u_z+w_r]$

Then

$$\{\epsilon\} = [D]\{\gamma\} \quad (4.2.2)$$

where

$$[D] = \begin{bmatrix} 0 & 1 & 0 & z & 0 & 0 & 0 & 0 \\ 1/r & 1 & r/z & z & 0 & 0 & 0 & 0 \\ 0 & 0 & 0 & 0 & 0 & 0 & 1 & r \\ 0 & 0 & 1 & r & 0 & 1 & 0 & z \end{bmatrix} \quad (4.2.3)$$

Since

$$[\epsilon] = [\gamma][D]^T \quad (4.2.4)$$

Contrails

We have upon substitution into (4.2.1)

$$\phi_K = 1/2 \int_V \{ \gamma \}^T [D]^T [E] [D] \{ \gamma \} dV \quad (4.2.5)$$

For the elemental volume of the ring element in cylindrical coordinates we have:

$$dV = 2\pi r dr dz \quad (4.2.6)$$

Substituting back into the strain energy equation we can now write:

$$\phi_K = 1/2 \int_r \int_z 2\pi \{ \gamma \}^T r [D]^T [E] [D] r dr dz \{ \gamma \} \quad (4.2.7)$$

All of the integrals in Equations (4.2.7) are of the form

$$I_{pq} = \int_r \int_z r^p z^q dr dz \quad (4.2.8)$$

It is now desirable to see how the integration is carried out over the trapezoidal cross-section.

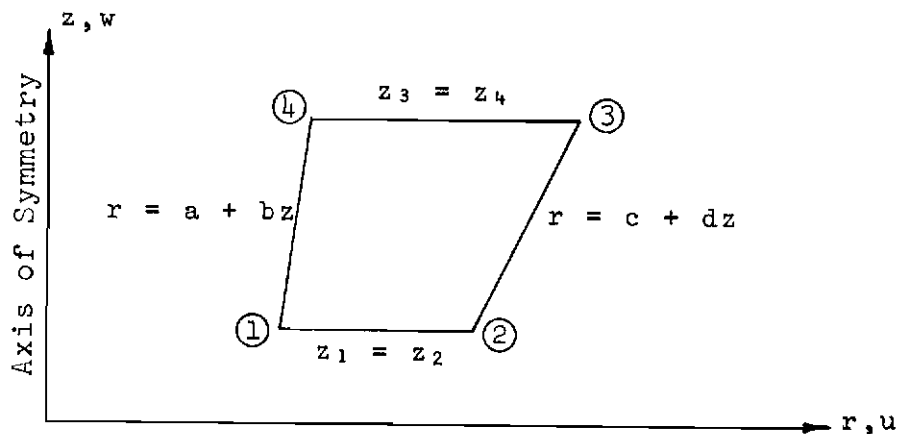

$$a = r_1 - \left(\frac{r_4 - r_1}{z_4 - z_1} \right) z_1 \quad ; \quad b = \frac{r_4 - r_1}{z_4 - z_1}$$

$$c = r_2 - \left(\frac{r_3 - r_2}{z_3 - z_2} \right) z_2 \quad ; \quad d = \frac{r_3 - r_2}{z_3 - z_2}$$

Contrails

For the trapezoid the integration takes the form:

$$I_{pq} = \int_{z_1}^{z_4} \int_a^{c+dz} r^p z^q dr dz \quad (4.2.9)$$

For the case with the side $r = c + dz$ parallel to the axis of symmetry (the Z axis) we have:

$$I_{pq} = \int_{z_1}^{z_4} \int_{a+bz}^c r^p z^q dr dz \quad (4.2.10)$$

For the case with the side $r = a + bz$ parallel to the axis of symmetry we have:

$$I_{pq} = \int_{z_1}^{z_4} \int_a^{c+dz} r^p z^q dr dz \quad (4.2.11)$$

And finally for the rectangle, the integration takes the form:

$$I_{pq} = \int_{z_1}^{z_4} \int_a^c r^p z^q dr dz \quad (4.2.12)$$

For the case where $r = c + dz \rightarrow c$ and

$$r = a + bz \rightarrow a$$

a test is made in the computer and we have the following

Let

$$d = \frac{r_1 + r_4}{2}$$

Contrails

If

$$\left| \frac{r_1 - r_4}{d} \right| < \epsilon \text{ (prescribed)}$$

Then

$$r_1 = d \text{ and } r_4 = d$$

By the same token

Let

$$d' = \frac{r_2 + r_3}{2}$$

If

$$\left| \frac{r_2 - r_3}{d'} \right| < \epsilon \text{ (prescribed)}$$

Then

$$r_2 = d' \text{ and } r_3 = d'$$

Equation (4.2.7) can now be rewritten as:

$$\phi_K = 1/2 [Y] [\tilde{K}] \{\gamma\} \quad (4.2.13)$$

where $[\tilde{K}]$ is shown on Page 10 of Reference 6.

Introducing the transformation to gridpoint displacement degrees of freedom we have:

$$\{\gamma\} = [H]\{q\} \quad (2.7)$$

$$[Y] = [q][H]^T \quad (4.2.14)$$

Then (4.2.13) becomes

$$\phi_K = 1/2 [q][H]^T [\tilde{K}] [H] \{q\} \quad (4.2.15)$$

Upon taking the first variation with respect to the displacements, we obtain the element stiffness matrix referenced to grid point displacement degrees of freedom

$$[K] = [H]^T [\tilde{K}] [H] \quad (4.2.16)$$

Contrails

For the special case of the core element, the element stiffness matrix referenced to grid point displacement degrees of freedom is obtained as follows:

$$[K]^* = [\hat{H}]^T [\tilde{K}] [\hat{H}] \quad (4.2.17)$$

4.3 Pressure Load Matrix

The pressure load matrix will be developed in the following manner: The pressure load due to pressure normal to the sides between node points (1) and (4), and (2) and (3) will be developed first and then the axial pressure load (the pressure normal to the sides connecting nodes (1) and (2) and (3) and (4)) will be developed next. These will then be combined so that radial and axial pressures may be input for each node point of the trapezoidal element (See Fig. III.1 for node point numbering).

4.3.1 Radial Pressure

Assume a linear normal pressure distribution on the boundary between node points (1) and (4). This assumption leads to the requirement of numbering the node points in counterclockwise order.

Let

$$p = p_1 + e + fz \quad (4.3.1.1)$$

where

$$e = \frac{-(p_4 - p_1)}{(z_4 - z_1)} z_1 \quad (4.3.1.2)$$
$$f = \frac{p_4 - p_1}{z_4 - z_1}$$

The external work done by the pressure on the displacements is

$$W = \int_A (p_r u + p_z w) dA \quad (4.3.1.3)$$

Contours

or

$$W = 2\pi r_1 \int_{z_1}^{z_4} (p_r u + p_z w) dz \quad (4.3.1.4)$$

$$p_r = p \cos \alpha \quad \text{and} \quad p_z = p \sin \alpha \quad (4.3.1.5)$$

$$W = 2\pi \int_{z_1}^{z_4} (p \cos \alpha (u) + p \sin \alpha (w)) dz \quad (4.3.1.6)$$

Let

$$\lambda_I = \cos \alpha = \frac{z_4 - z_1}{l_I}$$

$$L_I = \sin \alpha = \frac{r_1 - r_4}{l_I}$$

$$l_I = [(r_1 - r_4)^2 + (z_4 - z_1)^2]^{\frac{1}{2}} \quad (4.3.1.7)$$

$$m_I = p_1 - \frac{z_1}{(z_4 - z_1)} (p_4 - p_1)$$

$$n_I = \frac{(p_4 - p_1)}{(z_4 - z_1)}$$

Then

$$W = 2\pi \int_{z_1}^{z_4} \lambda_I u(a+bz, z) + L_I w(a+bz, z) [m_I + n_I z] dz \quad (4.3.1.8)$$

where

$$u(a+bz, z) = \alpha_1 + \alpha_2(a+bz) + \alpha_3 z + \alpha_4(a+bz)z \quad (4.3.1.9)$$

$$w(a+bz, z) = \beta_1 + \beta_2(a+bz) + \beta_3 z + \beta_4(a+bz)z \quad (4.3.1.10)$$

For the side of the trapezoid connecting node points (2) and (3) the same procedure is followed exactly. The total work can be written as:

$$W = \sum_j W_j; \quad (j = 1, 2, \dots, 8) \quad (4.3.1.11)$$

$$W = [Y][Q_p]\{M\} \quad (4.3.1.12)$$

Contrails

where

$$\begin{aligned} [Y] &= [\alpha_1, \alpha_2, \alpha_3, \alpha_4, \beta_1, \beta_2, \beta_3, \beta_4] \\ [M] &= [m_I \ m_{II} \ n_I \ n_{II}] \end{aligned} \quad (4.3.1.13)$$

Recalling that

$$\{\gamma\} = [H]\{q\} \quad (2.7)$$

then

$$[Y] = [q][H]^T \quad (4.2.14)$$

Then

$$W = [q][H]^T [Q_p] \{M\} \quad (4.3.1.14)$$

The vector $\{M\}$ can be written in the following manner:

$$\begin{pmatrix} m_I \\ m_{II} \\ n_I \\ n_{II} \end{pmatrix} = \begin{bmatrix} 1 + \frac{z_1}{z_4 - z_1} & 0 & 0 & -\left(\frac{z_1}{z_4 - z_1}\right) \\ 0 & 1 + \frac{z_1}{z_4 - z_1} & -\left(\frac{z_1}{z_4 - z_1}\right) & 0 \\ -\left(\frac{1}{z_4 - z_1}\right) & 0 & 0 & \left(\frac{1}{z_4 - z_1}\right) \\ 0 & -\left(\frac{1}{z_4 - z_1}\right) & \left(\frac{1}{z_4 - z_1}\right) & 0 \end{bmatrix} \begin{pmatrix} p_1 \\ p_2 \\ p_3 \\ p_4 \end{pmatrix} \quad (4.3.1.15)$$

or

$$\{M\} = [h_p] \{p\} \quad (4.3.1.16)$$

Equation (4.3.1.14) can now be written as

$$W = [q][H]^T [Q_p] [h_p] \{p\} \quad (4.3.1.17)$$

where the radial pressure load vector is $\{F_p\}$ and has the following form

$$\{F_p\} = [H]^T [Q_p] [h_p] \{p\} \quad (4.3.1.18)$$

Contrails

4.3.2 Axial Pressure

Assume a linear normal pressure distribution on the boundary between node points (1) and (2)

$$p' = p_1' - \left(\frac{p_2' - p_1'}{r_2 - r_1}\right)r_1 + \left(\frac{p_2' - p_1'}{r_2 - r_1}\right)r \quad (4.3.2.1)$$

Let

$$m_I' = p_1' - \left(\frac{r_1}{r_2 - r_1}\right)(p_2' - p_1') \quad (4.3.2.2)$$

$$n_I' = \frac{p_2' - p_1'}{r_2 - r_1}$$

Then

$$p' = (m_I' + n_I' r) \quad (4.3.2.3)$$

The external work done by the pressure on the displacement is:

$$W = \int_A (p_r u + p_z w) dA \quad (4.3.2.4)$$

For the case of axial pressure; $p_r \equiv 0$

Therefore

$$W = \int_A (p_z w) dA \quad (4.3.2.5)$$

$$A = \int_{r_1}^{r_j} \int_0^{2\pi} r d\theta dr \quad (4.3.2.6)$$

$$A = 2\pi \int_{r_1}^{r_j} r dr \quad (4.3.2.7)$$

Contrails

Substituting into Equation (4.3.2.5) the following result is obtained:

$$W = 2\pi \int_{r_1}^{r_2} r(p_z w) dr \quad (4.3.2.8)$$

For the side of the trapezoid connecting node points (3) and (4) the same procedure is followed as for node points (1) and (2). The total work can then be written as:

$$W = \sum_j W_j; \quad (j = 1, 2, 3, 4) \quad (4.3.2.9)$$

$$W = \beta [Q'_p] \{M'\} \quad (4.3.2.10)$$

$$[\beta] = [\beta_1, \beta_2, \beta_3, \beta_4] \quad (4.3.2.11)$$

$$[M'] = [m'_I, m'_{II}, n'_I, n'_{II}]$$

and

$$[Q'_p] = 2\pi \begin{bmatrix} 1/2(r_2^2 - r_1^2) & 1/2(r_4^2 - r_3^2) & 1/3(r_2^3 - r_1^3) & 1/3(r_4^3 - r_3^3) \\ 1/3(r_2^3 - r_1^3) & 1/3(r_4^3 - r_3^3) & 1/4(r_2^4 - r_1^4) & 1/4(r_4^4 - r_3^4) \\ z_1/2(r_2^2 - r_1^2) & z_4/2(r_4^2 - r_3^2) & z_4/3(r_2^3 - r_1^3) & z_4/3(r_4^3 - r_3^3) \\ z_1/3(r_2^3 - r_1^3) & z_4/3(r_4^3 - r_3^3) & z_1/4(r_2^4 - r_1^4) & z_4/4(r_4^4 - r_3^4) \end{bmatrix} \quad (4.3.2.12)$$

It is known that

$$\{\beta\} = [h]\{w\} \quad (2.6)$$

$$[\beta] = [w][h]^T$$

Substituting into Equation (4.3.2.10) we obtain

$$W = [w][h]^T [Q'_p] \{M'\} \quad (4.3.2.13)$$

Contrails

The vector $\{M'\}$ can be written in the following manner:

$$\begin{Bmatrix} m'_I \\ m'_{II} \\ n'_I \\ n'_{II} \end{Bmatrix} = \begin{bmatrix} 1 + \frac{r_1}{r_2 - r_1} & -\frac{r_1}{r_2 - r_1} & 0 & 0 \\ 0 & 0 & 1 + \frac{r_3}{r_4 - r_3} & -\frac{r_3}{r_4 - r_3} \\ -\frac{1}{r_2 - r_1} & \frac{1}{r_2 - r_1} & 0 & 0 \\ 0 & 0 & -\frac{1}{r_4 - r_3} & \frac{1}{r_4 - r_3} \end{bmatrix} \begin{Bmatrix} p'_1 \\ p'_2 \\ p'_3 \\ p'_4 \end{Bmatrix} \quad (4.3.2.14)$$

or

$$\{M'\} = [h'_p]\{p'\} \quad (4.3.2.15)$$

Equation (4.3.2.13) can now be written as

$$W = [Lw] [h]^T [Q'_p] [h'_p] \{p'\} \quad (4.3.2.16)$$

$$\{F'_p\} = [h]^T [Q'_p] [h'_p] \{p'\} \quad (4.3.2.17)$$

4.3.3 Combining Radial and Axial Pressure Loads

In this section we will combine the radial and axial pressure load vectors so that it is possible to input one radial and one axial pressure value for each node point of an element.

From Section 4.3.1 recall the following equation

$$\{M\} = [h_p]\{p\} \quad (4.3.1.16)$$

and from Section 4.3.2 we have

$$\{M'\} = [h'_p]\{p'\} \quad (4.3.2.14)$$

Contrails

Combining (4.3.1.16) and (4.3.2.14) the following is obtained, where $[H_p^*]$ is defined as [HP] on Page 15 of Reference 7.

$$\{M^*\} = [H_p^*]\{p^*\} \quad (4.3.3.1)$$

In the same manner from Equation (4.3.1.12)

$$W = [Y][Q_p]\{M\} \quad (4.3.1.12)$$

and from Equation (4.3.2.10) (the axial contribution)

$$W = [B][Q_p']\{M'\} \quad (4.3.2.10)$$

Combination of the $[Q_p]$ and $[Q_p']$ matrices yields the matrix $[Q_p^*]$ which is defined as [QP] on Page 12 of Reference 7.

The final pressure load vector can now be expressed by the following:

$$\{F_p^*\} = [H]^T [Q_p^*] [H_p^*] \{p^*\} \quad (4.3.3.2)$$

For the special case of the core element (Figure 2), the pressure load vector is of the following form:

$$\{F_p^*\} = [\hat{H}]^T [Q_p^*] [H_p^*] \{p^*\} \quad (4.3.3.3)$$

4.4 Prestrain Load Vector

The prestrain load vector is constructed assuming uniform distribution of prestrain across the element. The prestrain contribution to the total potential energy is:

$$\phi_\epsilon = \int_V L\epsilon_1 [E] \{\epsilon_1\} dV \quad (4.4.1)$$

Contrails

where

$$\{\epsilon\} = [D]\{\gamma\} \quad (4.4.2)$$

and $[D]$ is defined by Equation (4.2.3)

From Equation (2.7) we have,

$$\{\gamma\} = [H]\{q\} \quad (2.7)$$

Therefore Equation (4.4.1) becomes

$$\phi_{\epsilon} = \int_V [Y][D]^T [E]\{\epsilon_i\} dV \quad (4.4.3)$$

We also know that

$$dV = 2\pi r dr dz$$

$$\phi_{\epsilon} = [Y] 2\pi \int_r \int_z [D]^T r dr dz [E]\{\epsilon_i\} \quad (4.4.4)$$

Let

$$[\tilde{D}] = 2\pi \int_r \int_z [D] r dr dz \quad (4.4.5)$$

We know that,

$$r[D] = \begin{bmatrix} 0 & r & 0 & rz & 0 & 0 & 0 & 0 \\ 1 & r & z & rz & 0 & 0 & 0 & 0 \\ 0 & 0 & 0 & 0 & 0 & 0 & r & r^2 \\ 0 & 0 & r & r^2 & 0 & r & 0 & rz \end{bmatrix} \quad (4.4.6)$$

And from our previously defined notation:

$$\iint_{r,z} r^p z^q dr dz = I_{pq}$$

We have the following

$$[\tilde{D}] = 2\pi \begin{bmatrix} 0 & I_{10} & 0 & I_{11} & 0 & 0 & 0 & 0 \\ I_{00} & I_{10} & I_{01} & I_{11} & 0 & 0 & 0 & 0 \\ 0 & 0 & 0 & 0 & 0 & 0 & I_{10} & I_{20} \\ 0 & 0 & I_{10} & I_{20} & 0 & I_{10} & 0 & I_{11} \end{bmatrix} \quad (4.4.7)$$

Substituting back into Equation (4.4.4) we have:

$$\phi_\epsilon = [\gamma] [\tilde{D}]^T [E] \{\epsilon_1\} \quad (4.4.8)$$

Recalling that

$$\{\gamma\}^T = [q] [H]^T \quad (4.2.14)$$

and transforming to grid point displacement coordinate we have:

$$\phi_\epsilon = [q] [H]^T [\tilde{D}]^T [E] \{\epsilon_1\} \quad (4.4.9)$$

Substituting into the Lagrange Equation and taking the first variation with respect to the displacements, we obtain the

prestrain load vector:

$$\{F_{\epsilon}\} = [H]^T[\tilde{D}]^T[E]\{\epsilon_i\} \quad (4.4.10)$$

and for the special case of the core element, we obtain,

$$\{F_{\epsilon}\} = [\hat{H}]^T[\tilde{D}][E]\{\epsilon_i\} \quad (4.4.11)$$

where

$$\{F_{\epsilon}\}^T = [F_{\epsilon r_1}, F_{\epsilon z_1}, F_{\epsilon r_2}, F_{\epsilon z_2}, F_{\epsilon r_3}, F_{\epsilon z_3}, F_{\epsilon r_4}, F_{\epsilon z_4}] \quad (4.4.12)$$

and

$$\{\epsilon_i\}^T = [\epsilon_i r, \epsilon_i \theta, \epsilon_i z, 0] \quad (4.4.13)$$

4.5 Thermal Load Vector

The thermal load vector is a special case of the prestrain load vector. The temperature distribution function employed for the trapezoidal cross-section ring is assumed as follows:

$$T(r, \theta, z) = k_1 + k_2 r + k_3 z + k_4 r z \quad (4.5.1)$$

or

$$\{T\} = [g]\{k\} \quad (4.5.2)$$

Contrails

where $[g]$ has the following form

$$[g] = \begin{bmatrix} 1 & r & z & rz \\ 1 & r & z & rz \\ 1 & r & z & rz \\ 1 & r & z & rz \end{bmatrix} \quad (4.5.3)$$

The prestrain load vector contribution to the total potential energy may be written as follows:

$$\phi_{\epsilon} = \int_V [L\epsilon][E]\{\epsilon_i\}dV \quad (4.5.4)$$

From our previous notation we know the following:

$$\{\epsilon\}^T = [Y][D]^T \quad (4.2.4)$$

$$\{\gamma\} = [H]\{g\} \quad (2.7)$$

$$dV = 2\pi r dr dz$$

The initial strain vector can be written as,

$$\{\epsilon_i\}^T = T[\alpha_r, \alpha_\theta, \alpha_z, 0] = \{T\bar{\alpha}\} \quad (4.5.5)$$

Contrails

Upon substitution into Equation (4.5.4) obtain

$$\phi_{\epsilon} = 2\pi [q] [H]^T \int_r \int_z [D]^T [E] \{T\bar{\alpha}\} r dr dz \quad (4.5.6)$$

Rewrite $[E]\{T\bar{\alpha}\}$ as $[E^{\alpha}]\{T\}$

where the coefficients of thermal expansion have been multiplied into the $[E]$ matrix.

Equation (4.5.6) now becomes,

$$\phi_{\epsilon} = 2\pi [q] [H]^T \int_r \int_z r [D]^T [E^{\alpha}] \{T\} dr dz \quad (4.5.7)$$

From Equation (4.5.2) we know that

$$\{T\} = [g]\{k\} \quad (4.5.2)$$

$$\phi_{\epsilon} = 2\pi [q] [H]^T \int_r \int_z r [D]^T [E^{\alpha}] [g] dr dz \{k\} \quad (4.5.8)$$

Define $\int_r \int_z r [D]^T [E^{\alpha}] [g] dr dz$ as $[Q]$

Then Equation (4.5.8) becomes

$$\phi_{\epsilon} = 2\pi [q] [H]^T [Q] \{k\} \quad (4.5.9)$$

Contrails

The $\{k\}$ vector can be written in terms of the grid point temperatures in the following manner

$$\{k\} = [h]\{T'\} \quad (4.5.10)$$

where

$$\{k\}^T = [k_1, k_2, k_3, k_4] \quad (4.5.11)$$

$$\{T'\} = [(T_1 - T_0), (T_2 - T_0), (T_3 - T_0), (T_4 - T_0)] \quad (4.5.12)$$

T_0 = Equilibrium Temperature Of Structure

$$[h]^{-1} = \begin{bmatrix} 1 & r_1 & z_1 & r_1 z_1 \\ 1 & r_2 & z_2 & r_2 z_2 \\ 1 & r_3 & z_3 & r_3 z_3 \\ 1 & r_4 & z_4 & r_4 z_4 \end{bmatrix} \quad (4.5.13)$$

and $[h]$ has the following form:

$$[h] = \frac{1}{A} \begin{bmatrix} r_2 z_4 (r_3 - r_4) & -r_1 z_4 (r_3 - r_4) & r_4 z_1 (r_2 - r_1) & -r_3 z_1 (r_2 - r_1) \\ -z_4 (r_3 - r_4) & z_4 (r_3 - r_4) & -z_1 (r_2 - r_1) & z_1 (r_2 - r_1) \\ -r_2 (r_3 - r_4) & r_1 (r_3 - r_4) & -r_4 (r_2 - r_1) & r_3 (r_2 - r_1) \\ (r_3 - r_4) & -(r_3 - r_4) & (r_2 - r_1) & -(r_2 - r_1) \end{bmatrix} \quad (4.5.14)$$

where

$$A = (r_2 - r_1)(r_3 - r_4)(z_4 - z_1)$$

Substitution into Equation (4.5.9) yields,

$$\Phi_e = 2\pi [q] [H]^T [Q] [h] \{T'\} \quad (4.5.15)$$

Substituting into the Lagrange Equation and taking the first variation with respect to the displacements, the thermal load vector is obtained:

$$\{F_T\} = 2\pi [H]^T [Q] [h] \{T'\} \quad (4.5.16)$$

For the special case of the core element the thermal load vector is of the following form:

$$\{F_T\} = 2\pi [\hat{H}]^T [Q] [h] \{T'\} \quad (4.5.17)$$

4.6 Gravity Load And Centrifugal Force Vectors

The work done by the acceleration of gravity on the displacements can be written as:

$$\text{Work} = \int \rho G w dV \quad (4.6.1)$$

Contrails

where

$$dV = 2\pi r dz dr$$

G = Acceleration of gravity

ρ = Mass density of the material
in question

w = Assumed displacement mode
shape in the z direction.

$$\text{Work} = 2\pi\rho G \int_r \int_z (\beta_1 r + \beta_2 r^2 + \beta_3 r z + \beta_4 r^2 z) dr dz \quad (4.6.2)$$

As before denote

$$\int_r \int_z r^p z^q dr dz \text{ as } I_{pq} \quad (4.2.8)$$

$$\text{Work} = [\beta_1, \beta_2, \beta_3, \beta_4] 2\pi\rho G \begin{pmatrix} I_{10} \\ I_{20} \\ I_{11} \\ I_{21} \end{pmatrix} \quad (4.6.3)$$

Rewriting the work equation with respect to all the field coordinate degrees of freedom we obtain

Contrails

$$\text{Work} = [\alpha_1, \alpha_2, \alpha_3, \alpha_4, \beta_1, \beta_2, \beta_3, \beta_4] 2\pi\rho G \begin{pmatrix} 0 \\ 0 \\ 0 \\ 0 \\ I_{10} \\ I_{20} \\ I_{11} \\ I_{21} \end{pmatrix} \quad (4.6.4)$$

or

$$\text{Work} = [\gamma] \{\tilde{F}_G\} \quad (4.6.5)$$

$$[\gamma] = [\alpha_1, \alpha_2, \alpha_3, \alpha_4, \beta_1, \beta_2, \beta_3, \beta_4]$$

$$\{\tilde{F}_G\} = [0, 0, 0, 0, I_{10}, I_{20}, I_{11}, I_{21}] \quad (4.6.6)$$

Remembering that

$$\{\gamma\} = [H]\{q\} \quad (2.7)$$

$$\{\gamma\}^T = [q][H]^T \quad (4.2.14)$$

$$\text{Work} = [q][H]^T\{\tilde{F}_G\} \quad (4.6.7)$$

Upon taking the first variation of the Work Equation with respect to $\{q\}$, the Gravity Load Vector $\{F_G\}$ is obtained

$$\{F_G\} = [H]^T\{\tilde{F}_G\} \quad (4.6.8)$$

Contrails

The Centrifugal Force Vector is determined as follows:
The external work done by the centrifugal force on the displacement can be written as follows:

$$\text{Work} = \int_V \rho \omega^2 r u dV \quad (4.6.9)$$

where

$$dV = 2\pi r dz dr$$

$$\omega = \text{Natural frequency (rad/sec.)}$$

$$\rho = \text{Mass density}$$

$$u = \text{Assumed displacement mode shape in the } r \text{ direction.}$$

$$\text{Work} = 2\pi\rho\omega^2 \int_A (u)r^2 dz dr \quad (4.6.10)$$

$$\text{Work} = 2\pi\omega^2\rho \int_A (\alpha_1 r^2 + \alpha_2 r^3 + \alpha_3 r^2 z + \alpha_4 r^3 z) dz dr \quad (4.6.11)$$

Denote:

$$\int_r \int_z r^p z^q dz dr \quad \text{as} \quad I_{pq} \quad (4.2.8)$$

Contrails

$$W = 2\pi\rho\omega^2 \begin{bmatrix} \alpha_1 & \alpha_2 & \alpha_3 & \alpha_4 \end{bmatrix} \begin{Bmatrix} I_{2,0} \\ I_{3,0} \\ I_{2,1} \\ I_{3,1} \end{Bmatrix} \quad (4.6.12)$$

Rewrite the work equation with respect to the total set of field coordinate degrees of freedom

$$W = 2\pi\rho\omega^2 \begin{bmatrix} \alpha_1, & \alpha_2, & \alpha_3, & \alpha_4, & \beta_1, & \beta_2, & \beta_3, & \beta_4 \end{bmatrix} \begin{Bmatrix} I_{2,0} \\ I_{3,0} \\ I_{2,1} \\ I_{3,1} \\ 0 \\ 0 \\ 0 \\ 0 \end{Bmatrix} \quad (4.6.13)$$

$$W = \begin{bmatrix} \gamma \end{bmatrix} \{ \tilde{C}_G \} \quad (4.6.14)$$

where

$$\begin{aligned} \{\gamma\}^T &= \begin{bmatrix} \alpha_1, & \alpha_2, & \alpha_3, & \alpha_4, & \beta_1, & \beta_2, & \beta_3, & \beta_4 \end{bmatrix} \\ \{\tilde{C}_G\}^T &= 2\pi\rho\omega^2 \begin{bmatrix} I_{2,0}, & I_{3,0}, & I_{2,1}, & I_{3,1}, & 0, & 0, & 0, & 0, \end{bmatrix} \end{aligned} \quad (4.6.15)$$

Substituting the appropriate transformations into the work equation and taking the first variation with respect to $\{q\}$ we obtain the Centrifugal Force Vector $\{C_G\}$.

$$\{C_G\} = [H]^T \{\tilde{C}_G\} \quad (4.6.16)$$

4.7 Stress Matrix

The element stresses are given by the following:

$$\{\sigma\} = [E]\{\epsilon\} - [E]\{\bar{\alpha}\} \quad (4.7.1)$$

Recall that

$$\{\epsilon\} = [D]\{\gamma\} \quad (4.2.2)$$

$$\begin{Bmatrix} \epsilon_r \\ \epsilon_\theta \\ \epsilon_z \\ \epsilon_{rz} \end{Bmatrix} = \begin{bmatrix} 0 & 1 & 0 & z_i & 0 & 0 & 0 & 0 \\ 1/r_i & 1 & \frac{z_i}{r_i} & z_i & 0 & 0 & 0 & 0 \\ 0 & 0 & 0 & 0 & 0 & 0 & 1 & r_i \\ 0 & 0 & 1 & r_i & 0 & 1 & 0 & z_i \end{bmatrix} \{\gamma\} \quad (4.7.2)$$

From the $[D]$ matrix it is seen that the stress can be evaluated at Nodes (1) through (4) (i.e. $i = 1 - 4$)
We also know that

$$\{\gamma\} = [H]\{q\} \quad (2.7)$$

Equation (4.7.1) can be written in the following manner:

$$\{\sigma\} = [E][D][H]\{q\} - [E]\{\bar{\alpha}\} \quad (4.7.3)$$

And for the core element

$$\{\sigma\} = [E][D][\hat{H}]\{q\} - [E]\{\bar{\alpha}\} \quad (4.7.4)$$

Contrails

Denote

$$\begin{aligned} & [E][D][H] \\ \text{or} & \qquad \qquad \qquad \text{as } [S] \qquad \qquad \qquad (4.7.5) \\ & [E][D][\bar{H}] \end{aligned}$$

and the remaining stress contribution

$$[E]\{\bar{\alpha}\} \text{ as } \{\sigma\} \qquad \qquad \qquad (4.7.6)$$

Equation (4.7.3) now becomes

$$\{\sigma\} = [S]\{q\} - \{\sigma\} \qquad \qquad \qquad (4.7.7)$$

where

$$\{\sigma\}^T = \left[\sigma_{(1)}, \sigma_{(2)}, \sigma_{(3)}, \sigma_{(4)}, \sigma_{(avg)} \right] \qquad \qquad \qquad (4.7.8)$$

V Kinetic Energy

It is assumed in writing the element kinetic energy that the rotational energies are small compared with the translation energies. The kinetic energy function then takes the following form:

$$\Phi_2 = m/2 \int_V [L\dot{q}(m)] [I]\{\dot{q}(m)\}dV \quad (5.1)$$

The assumed displacement modes are of the form

$$[L\dot{q}] = [L\dot{u}, \dot{w}] \quad (5.2)$$

Therefore

$$\Phi_2 = m/2 \int_V [L\dot{u}, \dot{w}] [I] \begin{Bmatrix} \dot{u} \\ \dot{w} \end{Bmatrix} dV \quad (5.3)$$

or

$$\Phi_2 = 1/2 \int_V (\bar{m}_{11}\dot{u}^2 + \bar{m}_{22}\dot{w}^2)dV \quad (5.4)$$

It is now profitable to examine the form of the assumed displacement modes u and w

$$u(r, \theta, z) = \alpha_1 + \alpha_2 r + \alpha_3 z + \alpha_4 r z \quad (2.1)$$

$$w(r, \theta, z) = \beta_1 + \beta_2 + \beta_3 z + \beta_4 r z \quad (2.2)$$

Contrails

Upon examination of the Kinetic Energy Function (Equation 5.4) it is seen that all terms are of the form: $(a+br+cz+drz) (e+fr+gz+hrz)$ which may be written as

$$\begin{bmatrix} a & b & c & d \end{bmatrix} \begin{bmatrix} 1 & r & z & rz \\ r & r^2 & rz & r^2z \\ z & rz & z^2 & rz^2 \\ rz & r^2z & rz^2 & r^2z^2 \end{bmatrix} \begin{Bmatrix} e \\ f \\ g \\ h \end{Bmatrix} \quad (5.5)$$

For the element of volume we can write

$$dV = 2\pi r dr dz \quad (4.2.6)$$

Upon multiplying r into the above matrix we obtain the matrix which is to be integrated over the volume

$$\begin{bmatrix} r & r^2 & rz & r^2z \\ r^2 & r^3 & r^2z & r^3z \\ rz & r^2z & rz^2 & r^2z^2 \\ r^2z & r^3z & r^2z^2 & r^3z^2 \end{bmatrix} \quad (5.6)$$

Recalling from Equation (4.2.8) that

$$I_{pq} = \int_r \int_z r^p z^q dr dz \quad (4.2.8)$$

The kinetic energy function can now be assembled in matrix form as:

$$\Phi_2 = 1/2 \{ \gamma \} [\tilde{M}] \{ \gamma \} \quad (5.7)$$

Contrails

Recalling that

$$\{\gamma\} = [H]\{q\} \quad (2.7)$$

and

$$\{\dot{\gamma}\} = [H]\{\dot{q}\} \quad (5.8)$$

and

$$\{\dot{\gamma}\}^T = \dot{q} [H]^T \quad (5.9)$$

Then

$$\Phi_2 = 1/2[\dot{q}][H]^T[\tilde{M}][H]\{\dot{q}\} \quad (5.10)$$

Substitution into the Lagrange Equation and differentiating once with respect to time yields the consistent mass matrix.

$$[M] = [H]^T[\tilde{M}][H] \quad (5.11)$$

For the special case of the core element the consistent mass matrix is given as follows:

$$[M]^* = [\hat{H}]^T[\tilde{M}][\hat{H}] \quad (5.12)$$

Contrails

LIST OF SYMBOLS

$\{C_G\}$	Centrifugal Force Vector
[D]	Strain Displacement Coupling Matrix
[E]	Material Properties Matrix
$\{F_P\}$	Pressure Load Vector
$\{F_T\}$	Thermal Load Vector.
$\{F_G\}$	Gravity Load Vector
$\{F_\epsilon\}$	Prestrain Load Vector
[H]	Transformation Matrix
$[\hat{H}]$	Transformation Matrix
[I]	Identity Matrix
[K]	Stiffness Matrix
[M]	Mass Matrix
[S]	Stress Matrix
T	Temperature
U	Strain Energy Density
W	Work
[g]	Transformation Matrix
[h]	Transformation Matrix
m	Mass Coefficient
P	External Pressure
$\{q\}$	Displacement vector referenced to grid points
r	Radius, System Coordinates
$\{A\}$	Thermal Stress Vector

Contrails

LIST OF SYMBOLS (continued)

u	Element displacement, r direction
w	Element displacement, z direction
z	Axial Coordinate
α	Field Coordinate Displacement Degrees of Freedom Corresponding to displacement in u direction.
$\bar{\alpha}$	Coefficient of Thermal Expansion
β	Field Coordinate Displacement Degrees of Freedom Corresponding to displacement in w direction.
ϵ	Strain
$\{\gamma\}$	Vector of Combined α and β field coordinates
κ	Field coordinate Degrees of Freedom for temperature distribution function
ν	Possion's Ratio
σ	Stress Component
ω	Natural Circular Frequency (rad/sec.)
ρ	Mass Density
ϕ_{ρ}	Potential Energy Function
ϕ_{κ}	Kinetic Energy Function

C. QUADRILATERAL PLATE ELEMENT

I. Introduction

The formulation of the quadrilateral plate discrete element described is derived from and is mathematically consistent with, the formulation described in Reference 12. The addition of this particular element serves to add additional capability in the analysis of shell structures, particularly when instability analyses are to be performed.

A detailed derivation is presented for the force displacement properties of an orthotropic quadrilateral thin plate element exhibiting membrane and bending behavior. Included in these relationships are terms for stiffness, stress, thermal stress, and incremental stiffness.

For the quadrilateral plate element, orthotropic material mechanical properties are defined by four parameters: E_x , E_y , μ_{xy} and G_{xy} where μ_{xy} is the Poisson's ratio of the contraction in the y direction to extension in the x direction due to a tensile stress in the x direction. There is another Poisson's ratio μ_{yx} similarly defined, which is related to the other material properties through the identity $E_x \mu_{yx} = E_y \mu_{xy}$. Since, in general, none of the sides of an element will correspond to a principal axis of orthotropy, all relationships are derived for an arbitrary orientation of the element in an x-y plane in which the x and y axes are parallel to the principal orthogonal directions of the material.

Techniques for deriving the desired force-displacement relationships are described. The derivations make use of the matrix statement of Castigliano's Theorem. As shown in Reference 13, this leads to the stiffness matrix being defined as the product of three matrices, each containing simple terms.

II. Development of Linear Elastic Membrane Stiffness Matrix

For the quadrilateral plate element, shown in Figure III-3, the stresses are assumed to be given by

$$\begin{aligned}\sigma_x &= a_1 + a_2 y \\ \sigma_y &= a_3 + a_4 x \\ \tau_{xy} &= a_5\end{aligned}\tag{III-1}$$

This assumed stress pattern was adopted in Reference 13 by Turner, et al, in the derivation of the stiffness matrix for an isotropic rectangular plate. Equations (III-1) satisfy the equilibrium requirements of a differential element and can be operated upon to yield compatible displacements. The complete element, in attachment to other elements of the system, does not satisfy equilibrium and compatibility at all points along the juncture line however. Evidence (Reference 5) from plane stress analyses has shown that the consequence of these shortcomings is a stiffer idealization, but not as stiff as would be obtained with use of the linear edge displacement assumptions proposed in Reference 6.

The matrix statement of Castigliano's Theorem, applicable to the derivation of the quadrilateral element force-displacement properties is written as

$$[K] = [B^{-1}]^T [C] [B]^{-1}\tag{III-2}$$

where $[K]$ is the desired matrix of element stiffness coefficients.

Plate thickness, h , is constant

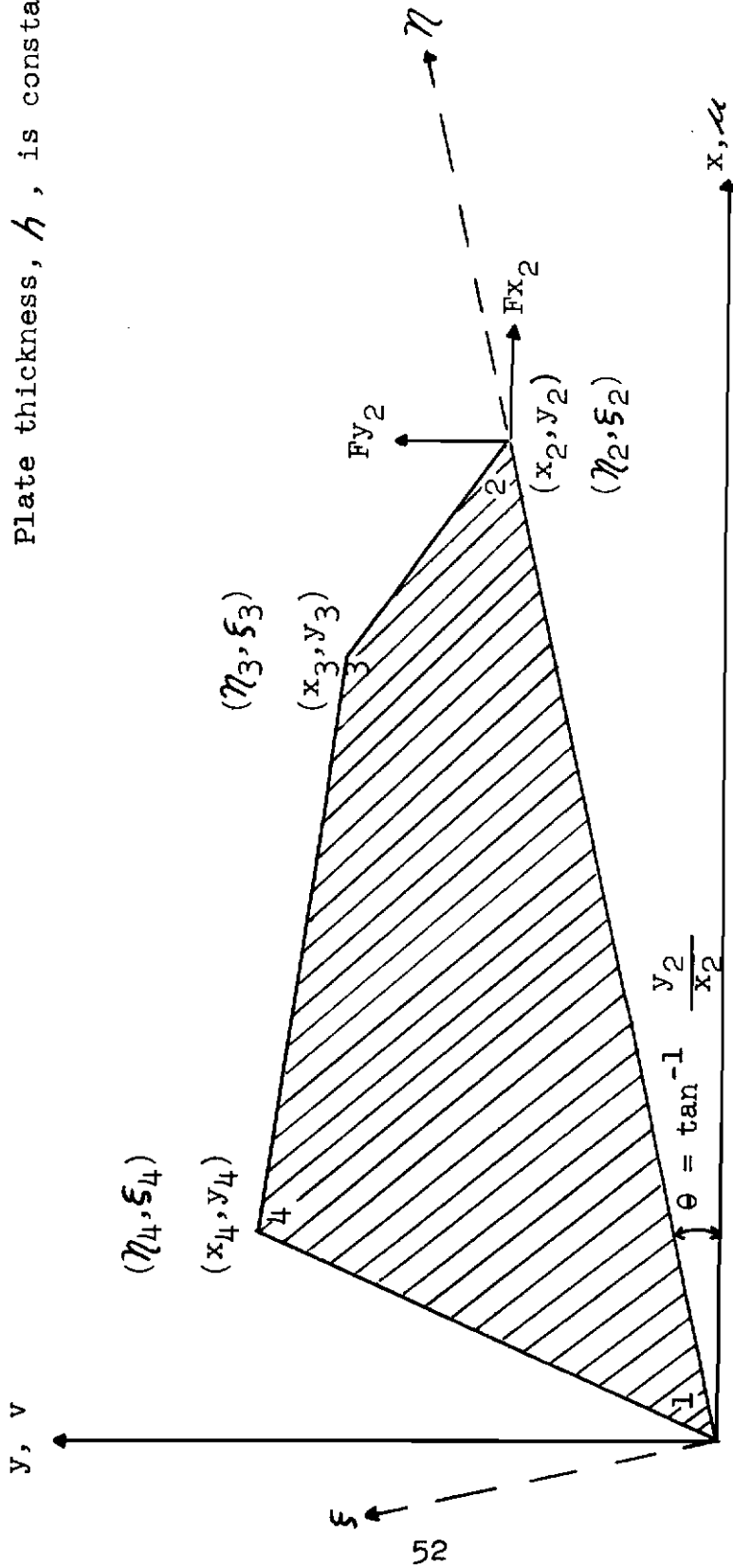

FIGURE III-3 GEOMETRY OF ARBITRARY QUADRILATERAL PLATE ELEMENT

Contrails

To obtain the matrix $[B]$, we first establish the strains for an orthotropic material in accordance with Hooke's Law and considering the possibility of initial strains as follows:

$$\begin{aligned}\epsilon_x &= \frac{1}{E_x} (\sigma_x - \mu_{xy} \sigma_y) + \epsilon_x^i \\ \epsilon_y &= \frac{1}{E_y} (\sigma_y - \mu_{yx} \sigma_x) + \epsilon_y^i \\ \gamma_{xy} &= \frac{\tau_{xy}}{G_{xy}} + \gamma_{xy}^i\end{aligned}\tag{III-3}$$

where ϵ_x^i , ϵ_y^i and γ_{xy}^i are the initial strains.

The constants, a , in the assumed stress pattern are introduced into the strain expressions by substituting Equations (III-1) into the above equations to yield

$$\begin{aligned}\epsilon_x &= \frac{1}{E_x} [(a_1 - \mu_{xy} a_3) - \mu_{xy} a_4^x + a_2^y] + \epsilon_x^i \\ \epsilon_y &= \frac{1}{E_y} [(a_3 - \mu_{yx} a_1) - \mu_{yx} a_2^y + a_4^x] + \epsilon_y^i \\ \gamma_{xy} &= \frac{a_5}{G_{xy}} + \gamma_{xy}^i\end{aligned}\tag{III-4}$$

Contrails

Utilizing the basic relationships that $\frac{\partial u}{\partial x} = \epsilon_x$ and $\frac{\partial v}{\partial y} = \epsilon_y$, it is possible to determine the linear displacements of the quadrilateral by integrating the strain expressions (Eq. III-4) with respect to the appropriate variable. Thus,

$$\begin{aligned}
 u &= \int \epsilon_x \, dx \\
 &= \frac{1}{E_x} \left[(a_1 - \mu_{xy} a_3) x - \frac{\mu_{xy} a_4 x^2}{2} + a_2 y x + f_1(y) \right] + \epsilon_x^i x
 \end{aligned}
 \tag{III-5}$$

$$\begin{aligned}
 v &= \int \epsilon_y \, dy \\
 &= \frac{1}{E_y} \left[(a_3 - \mu_{yx} a_1) y - \frac{\mu_{yx} a_2 y^2}{2} + a_4 x y + f_2(x) \right] + \epsilon_y^i y
 \end{aligned}$$

The functions of integration, $f_1(y)$ and $f_2(x)$, can be evaluated

from the shear strain definition $\gamma_{xy} = \frac{\partial u}{\partial y} + \frac{\partial v}{\partial x}$

Substituting Eqs. III-4 and -5 into this shear strain definition gives

$$\frac{a_5}{G_{xy}} + \gamma_{xy}^i = \frac{a_2 x}{E_x} + \frac{1}{E_x} \frac{d f_1(y)}{dy} + \frac{a_4 y}{E_y} + \frac{1}{E_y} \frac{d f_2(x)}{dx}
 \tag{III-6}$$

To separate the variables, Eq. III-6 is rearranged as follows

$$\frac{1}{E_x} \frac{d f_1(y)}{dy} + \frac{a_4 y}{E_y} = - \left[\frac{1}{E_y} \frac{d f_2(x)}{dx} + \frac{a_2 x}{E_x} - \frac{a_5}{G_{xy}} - \gamma_{xy}^i \right]
 \tag{III-6a}$$

The functions $f_1(y)$ and $f_2(x)$ can now be determined by letting each side of Eq. III-6a equal the constant $\frac{a_6}{E_x}$ and integrating to yield

$$f_1(y) = - \frac{E_x}{E_y} a_4 \frac{y^2}{2} + a_6 y + a_7
 \tag{III-7}$$

$$f_2(x) = - \frac{E_y}{E_x} a_2 \frac{x^2}{2} + \frac{E_x}{G_{xy}} a_5 x - \frac{E_y}{E_x} a_6 x + a_8 + E_y \gamma_{xy}^i x$$

Continuity

$$\begin{pmatrix} v_1 \\ v_2 \\ v_3 \\ v_4 \end{pmatrix} = \frac{1}{E_x} \begin{bmatrix} 0 & 0 & 0 & 0 \\ x_2 & x_2 y_2 & -x_2 y_2 & 0 \\ x_3 & x_3 y_3 & -x_3 y_3 & 0 \\ x_4 & x_4 y_4 & -x_4 y_4 & 0 \\ 0 & 0 & 0 & 0 \\ -x_2 y_2 & \frac{x_2 y_2^2 - x_2^2}{2} & \frac{E_x y_2}{E_y} & \frac{E_x x_2 y_2}{E_y} \\ -x_3 y_3 & \frac{x_3 y_3^2 - x_3^2}{2} & \frac{E_x y_3}{E_y} & \frac{E_x x_3 y_3}{E_y} \\ -x_4 y_4 & \frac{x_4 y_4^2 - x_4^2}{2} & \frac{E_x y_4}{E_y} & \frac{E_x x_4 y_4}{E_y} \end{bmatrix} + \begin{pmatrix} a_1 \\ a_2 \\ a_3 \\ a_4 \\ a_5 \\ a_6 \\ a_7 \\ a_8 \end{pmatrix} \begin{bmatrix} 0 & 1 & 0 & 0 & 0 & 0 & 0 & 0 \\ 0 & y_2 & 1 & 0 & 0 & 0 & 0 & 0 \\ 0 & y_3 & 1 & 0 & 0 & 0 & 0 & 0 \\ 0 & y_4 & 1 & 0 & 0 & 0 & 0 & 0 \\ \frac{E_x}{E_y} & 0 & 0 & 0 & 0 & 0 & 0 & 0 \\ \frac{E_x x_2}{E_y} & -x_2 & 0 & 0 & 0 & 0 & 0 & 0 \\ \frac{E_x x_3}{E_y} & -x_3 & 0 & 0 & 0 & 0 & 0 & 0 \\ \frac{E_x x_4}{E_y} & -x_4 & 0 & 0 & 0 & 0 & 0 & 0 \end{bmatrix} \begin{pmatrix} 0 \\ \epsilon_x^1 x_2 \\ \epsilon_x^1 x_3 \\ \epsilon_x^1 x_4 \\ 0 \\ \epsilon_y^1 y_2 + \gamma_{xy}^1 x_2 \\ \epsilon_y^1 y_3 + \gamma_{xy}^1 x_3 \\ \epsilon_y^1 y_4 + \gamma_{xy}^1 x_4 \end{pmatrix}$$

FIGURE III-4 EQUATION III-8

Contrails

Substituting Eqs. III-7 into Eqs. III-5 and evaluating the resulting expressions at the corner points 1, 2, 3 and 4 of Figure 1 produces the relationship for the corner displacements as shown as Eq. III-8 in Fig. III-4. The square matrix, including the coefficient $\frac{1}{E_x}$, on the right side of Eq. III-8 is the [B] matrix

To develop the [C] matrix we first need the expression for strain energy for orthotropic plane stress. In terms of stress, this can be written as

$$U = \frac{h}{2} \iint \left(\frac{\sigma_x^2}{E_x} + \frac{\sigma_y^2}{E_y} - \frac{2\mu_{yx}}{E_y} \sigma_x \sigma_y + \frac{\tau_{xy}^2}{G_{xy}} \right) dx dy \quad (\text{III-9})$$

Substituting the assumed stress functions, Eqs. III-1, into the energy equation and expanding produces

$$U = \frac{h}{2} \int_A \left[\frac{1}{E_x} (a_1^2 + 2a_1 a_2 y + a_2^2 y^2) + \frac{1}{E_y} (a_3^2 + 2a_3 a_4 x + a_4^2 x^2) - \frac{2\mu_{yx}}{E_y} (a_1 a_3 + a_1 a_4 x + a_2 a_3 y + a_2 a_4 xy) + \frac{a_5^2}{G_{xy}} \right] dA \quad (\text{III-10})$$

The derivatives of the strain energy with respect to the constants a_1, a_2, \dots, a_8 are:

$$\begin{aligned} \frac{\partial U}{\partial a_1} &= \frac{h}{E_x} \left[Aa_1 + I_y a_2 - \frac{E_x}{E_y} \mu_{yx} Aa_3 - \frac{E_x}{E_y} \mu_{xy} I_x a_4 \right] \\ \frac{\partial U}{\partial a_2} &= \frac{h}{E_x} \left[I_y a_1 + I_y^2 a_2 - \frac{E_x}{E_y} \mu_{yx} I_y a_3 - \frac{E_x}{E_y} \mu_{yx} I_{xy} a_4 \right] \\ \frac{\partial U}{\partial a_3} &= \frac{h}{E_x} \left[\frac{E_x}{E_y} (-\mu_{yx} Aa_1 - \mu_{yx} I_y a_2 + Aa_3 + I_x a_4) \right] \\ \frac{\partial U}{\partial a_4} &= \frac{h}{E_x} \left[\frac{E_x}{E_y} (-\mu_{yx} I_x a_1 - \mu_{yx} I_{xy} a_2 + I_x a_3 + I_x^2 a_4) \right] \end{aligned} \quad (\text{III-11})$$

Contrails

$$\frac{\partial U}{\partial a_5} = \frac{h}{E_x} \left[\begin{array}{c} \frac{E_x A}{G_{xy}} \\ a_5 \end{array} \right]$$

(III-11 Cont.)

$$\frac{\partial U}{\partial a_6} = \frac{\partial U}{\partial a_7} = \frac{\partial U}{\partial a_8} = 0$$

where $A = \int dA$

and $I_{xy} = \int_A x y \, dA$

From the above we have

$$\left[\begin{array}{c} \frac{\partial U}{\partial a_1} \\ \frac{\partial U}{\partial a_2} \\ \frac{\partial U}{\partial a_3} \\ \frac{\partial U}{\partial a_4} \\ \frac{\partial U}{\partial a_5} \\ \frac{\partial U}{\partial a_6} \\ \frac{\partial U}{\partial a_7} \\ \frac{\partial U}{\partial a_8} \end{array} \right] \frac{h}{E_x} \left[\begin{array}{cccccccc} A & I_y & -\mu_{xy} A & \mu_{xy} I_x & 0 & 0 & 0 & 0 \\ I_y & I_y^2 & \mu_{xy} I_y & \mu_{xy} I_{xy} & 0 & 0 & 0 & 0 \\ -\mu_{xy} A & -\mu_{xy} I_y & \frac{E_x}{E_y} A & \frac{E_x}{E_y} I_x & 0 & 0 & 0 & 0 \\ -\mu_{xy} I_x & \mu_{xy} I_{xy} & \frac{E_x}{E_y} I_x & \frac{E_x}{E_y} I_x^2 & 0 & 0 & 0 & 0 \\ 0 & 0 & 0 & 0 & \frac{E_x A}{G_{xy}} & 0 & 0 & 0 \\ 0 & 0 & 0 & 0 & 0 & 0 & 0 & 0 \\ 0 & 0 & 0 & 0 & 0 & 0 & 0 & 0 \\ 0 & 0 & 0 & 0 & 0 & 0 & 0 & 0 \end{array} \right] \left[\begin{array}{c} a_1 \\ a_2 \\ a_3 \\ a_4 \\ a_5 \\ a_6 \\ a_7 \\ a_8 \end{array} \right]$$

(III-12)

The square, symmetric matrix, including the coefficient $\frac{h}{E_x}$, on the right is the Matrix [C].

Utilizing Matrix [B] from Eq. III-8 and Matrix [C] from Eq. III-12, the element stiffness matrix, [K], is obtained from Eq. III-2.

Contrails

III. Geometric Properties

In the development of Matrix [C] in the previous section, a group of $I_{x y}^{i j}$ terms resulted from integrating the energy expression. These terms are of the form

$$I_{x y}^{i j} = \iint x^i y^j dy dx = \int_A x^i y^j dA \quad (\text{III-13})$$

and therefore are analogous to area moment relationships.

In explicitly formulating the $I_{x y}^{i j}$ terms it was convenient to use previously determined $I_{\eta \xi}^{i j}$ terms with reference to the η - ξ coordinates (see Fig. III-3) and transform these to the x-y coordinate system. The coordinate transformation from the x-y system into the η - ξ coordinates for any given point is expressed by:

$$\begin{Bmatrix} \eta \\ \xi \end{Bmatrix} = \begin{bmatrix} \cos \theta & \sin \theta \\ -\sin \theta & \cos \theta \end{bmatrix} \begin{Bmatrix} x \\ y \end{Bmatrix} \quad (\text{III-14})$$

where θ is the angle between the x and η axes and is defined by

$$\theta = \tan^{-1} \frac{x_2}{y_2}$$

Alternatively the coordinate transformation from the η - ξ system to x-y system is given by

$$\begin{Bmatrix} x \\ y \end{Bmatrix} = \begin{bmatrix} \cos \theta & -\sin \theta \\ \sin \theta & \cos \theta \end{bmatrix} \begin{Bmatrix} \eta \\ \xi \end{Bmatrix} \quad (\text{III-14a})$$

As an example of the determination of $I_{x y}^{i j}$'s in terms of $I_{\eta \xi}^{i j}$'s consider the first moment of the area about the y axis, I_x . For this moment

$$\begin{aligned} I_x &= \int_A x dA \\ &= \int (\eta \cos \theta - \xi \sin \theta) dA \\ &= \cos \theta \int \eta dA - \sin \theta \int \xi dA \\ &= I_{\eta} \cos \theta - I_{\xi} \sin \theta \end{aligned} \quad (\text{III-15})$$

Contrails

All the other $I_{x y}^{i j}$'s are determined by a similar procedure and are stated as follows:

$$\begin{aligned}
 I_x^2 &= I_\eta^2 \cos^2 \theta - 2I_{\eta\xi} \cos \theta \sin \theta + I_\xi^2 \sin^2 \theta \\
 I_y &= I_\eta \sin \theta + I_\xi \cos \theta \\
 I_y^2 &= I_\eta^2 \sin^2 \theta + 2I_{\eta\xi} \sin \theta \cos \theta + I_\xi^2 \cos^2 \theta \\
 I_{xy} &= (I_\eta^2 - I_\xi^2) \sin \theta \cos \theta + I_{\eta\xi} (\cos^2 \theta - \sin^2 \theta)
 \end{aligned}
 \tag{III-15a}$$

The area and moment properties about the η and ξ axes were determined by direct integration within the proper limits to yield the following expressions

$$\begin{aligned}
 A &= \int dA = \frac{1}{2} \left[\eta_4 \xi_4 + (\eta_3 - \eta_4) (\xi_3 + \xi_4) - (\eta_3 - \eta_2) \xi_3 \right] \\
 I_\eta &= \frac{1}{6} \left[(\xi_4 \eta_3 - \xi_3 \eta_4) (\eta_3 + \eta_4) + \xi_3 \eta_2 (\eta_3 + \eta_2) \right] \\
 I_\eta^2 &= \frac{1}{12} \left[(\xi_4 \eta_3 - \xi_3 \eta_4) (\eta_3^2 + \eta_3 \eta_4 + \eta_4^2) + \xi_3 \eta_2 (\eta_3^2 + \eta_3 \eta_2 + \eta_2^2) \right] \\
 I_\xi &= \frac{1}{6} \left[\xi_4^2 \eta_4 + (\eta_3 - \eta_4) (\xi_3^2 + \xi_3 \xi_4 + \xi_4^2) - (\eta_3 - \eta_2) \xi_3^2 \right] \tag{III-16} \\
 I_\xi^2 &= \frac{1}{12} \left[\xi_4^3 \eta_4 + (\eta_3 - \eta_4) (\xi_3^2 + \xi_4^2) (\xi_3 + \xi_4) - (\eta_3 - \eta_2) \xi_3^3 \right] \\
 I_{\eta\xi} &= \frac{1}{24} \left[3\xi_4^2 \eta_4^2 + \frac{3(\xi_3 - \xi_4)^2 (\eta_3^4 - \eta_4^4)}{(\eta_3 - \eta_4)^2} \right. \\
 &+ \frac{8(\xi_3 - \xi_4) (\eta_3^2 + \eta_3 \eta_4 + \eta_4^2) (\xi_4 \eta_3 - \xi_3 \eta_4)}{(\eta_3 - \eta_4)} \\
 &+ \left. \frac{6(\xi_4 \eta_3 - \xi_3 \eta_4)^2 (\eta_3 + \eta_4)}{(\eta_3 - \eta_4)} - (\eta_3 - \eta_2) \xi_3^2 (3\eta_3 + \eta_2) \right]
 \end{aligned}$$

IV. Development of Initial Force Terms

The initial force terms are derived from a consideration of the element corner forces. From Castigliano's Theorem, the corner forces are expressed by

$$\{F\} = \left[\frac{\partial a}{\partial \delta} \right] \left\{ \frac{\partial U}{\partial a} \right\} \quad (\text{III-17})$$

Noting that the matrix $\left[\frac{\partial a}{\partial \delta} \right]$ is the set of influence coefficients in the direct relationship between the constants a and the displacements δ ($= u, v$), it follows that

$$\left[\frac{\partial a}{\partial \delta} \right] = [B^{-1}]^T \quad (\text{III-18})$$

Also the vector $\left\{ \frac{\partial U}{\partial a} \right\}$ has already been determined in Equ. III-12, Sect. III-A, as $\left\{ \frac{\partial U}{\partial a} \right\} = [C] \{a\}$. Thus, we can rewrite Eq. III-17 as

$$\{F\} = [B^{-1}]^T [C] \{a\} \quad (\text{III-19})$$

The initial strains are introduced into the force expression by first solving Eq. III-8 for $\{a\}$ thusly

$$\{a\} = [B]^{-1} \begin{Bmatrix} u \\ v \end{Bmatrix} - [B]^{-1} \begin{Bmatrix} \epsilon_x^i x \\ \epsilon_y^i y + \sigma_{xy}^i x \end{Bmatrix} \quad (\text{III-8a})$$

and substituting this relationship into Eq. III-19 to give

$$\{F\} = [B^{-1}]^T [C] [B]^{-1} \begin{Bmatrix} u \\ v \end{Bmatrix} - [B^{-1}]^T [C] [B]^{-1} \begin{Bmatrix} \epsilon_x^i x \\ \epsilon_y^i y + \sigma_{xy}^i x \end{Bmatrix} \quad (\text{III-20})$$

The first term on the right hand side of Eq. III-20 represents the corner forces due to displacement, i.e., the forces required to induce the deformations u and v elastically. The second term

Contrails

yields the initial forces, $\{F^i\}$. Thus

$$\{F^i\} = [B^{-1}]^T [C] [B]^{-1} \left\{ \begin{array}{l} \epsilon_x^i x \\ \epsilon_y^i y + \gamma_{xy}^i x \end{array} \right\} \quad (\text{III-21})$$

Since from Eq. III-2 $[K] = [B^{-1}]^T [C] [B]^{-1}$, the initial forces are simply the product of the usual element stiffness matrix and the column of node point initial displacements. Hence

$$\left\{ \begin{array}{l} F_{x_1}^i \\ F_{x_2}^i \\ F_{x_3}^i \\ F_{x_4}^i \\ F_{y_1}^i \\ F_{y_2}^i \\ F_{y_3}^i \\ F_{y_4}^i \end{array} \right\} = [K] \left\{ \begin{array}{l} 0 \\ \epsilon_x^i x_2 \\ \epsilon_x^i x_3 \\ \epsilon_x^i x_4 \\ 0 \\ \epsilon_y^i y_2 + \gamma_{xy}^i x_2 \\ \epsilon_y^i y_3 + \gamma_{xy}^i x_3 \\ \epsilon_y^i y_4 + \gamma_{xy}^i x_4 \end{array} \right\} \quad (\text{III-22})$$

For the case of a change in the temperature of the quadrilateral element equal to T , the initial strains are given by

$$\begin{aligned} \epsilon_x^i &= \alpha_x T \\ \epsilon_y^i &= \alpha_y T \\ \gamma_{xy}^i &= 0 \end{aligned} \quad (\text{III-23})$$

where α_x and α_y are the coefficients of thermal expansion in the x and y directions respectively.

V. Stress Equations

The stress equations are derived by first evaluating the assumed stress functions, Eqs. III-1, at corners 1, 2, 3 and 4. This procedure yields the following relationship for the corner stresses:

$$\begin{Bmatrix} \sigma_{x_1} \\ \sigma_{x_2} \\ \sigma_{x_3} \\ \sigma_{x_4} \\ \tau_{xy_1} \\ \tau_{xy_2} \\ \tau_{xy_3} \\ \tau_{xy_4} \\ \sigma_{y_1} \\ \sigma_{y_2} \\ \sigma_{y_3} \\ \sigma_{y_4} \end{Bmatrix} = \begin{bmatrix} 1 & 0 & 0 & 0 & 0 & 0 & 0 & 0 \\ 1 & y_2 & 0 & 0 & 0 & 0 & 0 & 0 \\ 1 & y_3 & 0 & 0 & 0 & 0 & 0 & 0 \\ 1 & y_4 & 0 & 0 & 0 & 0 & 0 & 0 \\ 0 & 0 & 0 & 0 & 1 & 0 & 0 & 0 \\ 0 & 0 & 0 & 0 & 1 & 0 & 0 & 0 \\ 0 & 0 & 0 & 0 & 1 & 0 & 0 & 0 \\ 0 & 0 & 0 & 0 & 1 & 0 & 0 & 0 \\ 0 & 0 & 1 & 0 & 0 & 0 & 0 & 0 \\ 0 & 0 & 1 & x_2 & 0 & 0 & 0 & 0 \\ 0 & 0 & 1 & x_3 & 0 & 0 & 0 & 0 \\ 0 & 0 & 1 & x_4 & 0 & 0 & 0 & 0 \end{bmatrix} \begin{Bmatrix} a_1 \\ a_2 \\ a_3 \\ a_4 \\ a_5 \\ a_6 \\ a_7 \\ a_8 \end{Bmatrix} \quad (\text{III-24})$$

In a more concise manner Eq. III-24 may be written as

$$\begin{Bmatrix} \sigma_x \\ \tau_{xy} \\ \sigma_y \end{Bmatrix} = [D] \{a\} \quad (\text{III-24a})$$

By substituting Eq. III-8a from Sect. III-C into Eq. III-24a, the stresses may be written in terms of the displacements and initial strains. This substitution yields

$$\begin{Bmatrix} \sigma_x \\ \tau_{xy} \\ \sigma_y \end{Bmatrix} = [D] [B]^{-1} \begin{Bmatrix} u \\ v \end{Bmatrix} - [D] [B]^{-1} \left\{ \begin{matrix} \epsilon_x^i x \\ \epsilon_y^i y + \gamma_{xy}^i x \end{matrix} \right\} \quad (\text{III-25})$$

Contrails

The first term on the right hand side of Eq. III-25 corresponds to the displacement stresses $\{\sigma^1\}$, while the second term represents the initial stresses, $\{\sigma^i\}$.

Letting $[S_{xy}] = [D] [B]^{-1}$, the displacement stresses are given by

$$\begin{Bmatrix} \sigma_{x_1}^i \\ \sigma_{x_2}^i \\ \sigma_{x_3}^i \\ \sigma_{x_4}^i \\ \tilde{\tau}_{xy_1}^i \\ \tilde{\tau}_{xy_2}^i \\ \tilde{\tau}_{xy_3}^i \\ \tilde{\tau}_{xy_4}^i \\ \sigma_{y_1}^i \\ \sigma_{y_2}^i \\ \sigma_{y_3}^i \\ \sigma_{y_4}^i \end{Bmatrix} = [S_{xy}] \begin{Bmatrix} u_1 \\ u_2 \\ u_3 \\ u_4 \\ v_1 \\ v_2 \\ v_3 \\ v_4 \end{Bmatrix} \tag{III-26}$$

Contrails

Similarly the initial stresses are

$$\left\{ \begin{array}{l} \sigma_{x_1}^i \\ \sigma_{x_2}^i \\ \sigma_{x_3}^i \\ \sigma_{x_4}^i \\ \tilde{\tau}_{xy_1}^i \\ \tilde{\tau}_{xy_2}^i \\ \tilde{\tau}_{xy_3}^i \\ \tilde{\tau}_{xy_4}^i \\ \sigma_{y_1}^i \\ \sigma_{y_2}^i \\ \sigma_{y_3}^i \\ \sigma_{y_4}^i \end{array} \right\} = [S_{xy}] \left\{ \begin{array}{l} 0 \\ \epsilon_x^i x_2 \\ \epsilon_x^i x_3 \\ \epsilon_x^i x_4 \\ 0 \\ \epsilon_y^i y_2 + \gamma_{xy}^i x_2 \\ \epsilon_y^i y_3 + \gamma_{xy}^i x_3 \\ \epsilon_y^i y_4 + \gamma_{xy}^i x_4 \end{array} \right\} \quad (\text{III-27})$$

VI. Development of Linear Elastic Stiffness Matrix (Bending)

The orientation of this element in the X-Y plane and the corner forces and moments are shown in Fig. III-5. As before, the principal directions of orthotropy must be parallel to the X and Y axes

In deriving the linear elastic stiffness matrix the displacements in the direction normal to the plate midplane are assumed to be representable as

$$w = a_1x^3 + a_2x^2 + a_3x + a_4y^3 + a_5y^2 + a_6y + a_7x^3y + a_8x^2y + a_9xy + a_{10}xy^3 + a_{11}xy^2 + a_{12} \quad (V-1)$$

where a_1, \dots, a_{12} are constants. Since twelve force-displacement equations are to be derived (three degrees of freedom - θ_x , θ_y , w - at each corner point), twelve independent parameters appear in the assumed displacement function. Secondly, all possible single terms or products to the third degree are included; the resulting polynomial is "geometrically symmetric", e.g., corresponding to the a_8x^2y term there is the $a_{11}xy^2$ term. Finally, Equation (1) satisfies the differential equation of equilibrium.

To obtain the desired stiffness matrix, the following matrix product is effected:

$$\left([B]^{-1} \right)^T [C_f] [B]^{-1} = [K_f] \quad (V-2)$$

To formulate the matrix $[B]$, we first establish the slopes θ_x and θ_y from the deflection function (Equation V-1) by

$$\theta_x = \frac{\partial w}{\partial y} = 3y^2a_4 + 2ya_5 + a_6 + x^3a_7 + x^2a_8 + xa_9 + 3xy^2a_{10} + 2xya_{11} \quad (V-3)$$

$$\theta_y = \frac{\partial w}{\partial x} = -3x^2a_1 - 2xa_2 - a_3 - 3x^2ya_7 - 2xya_8 - ya_9 - y^3a_{10} - y^2a_{11} \quad (V-4)$$

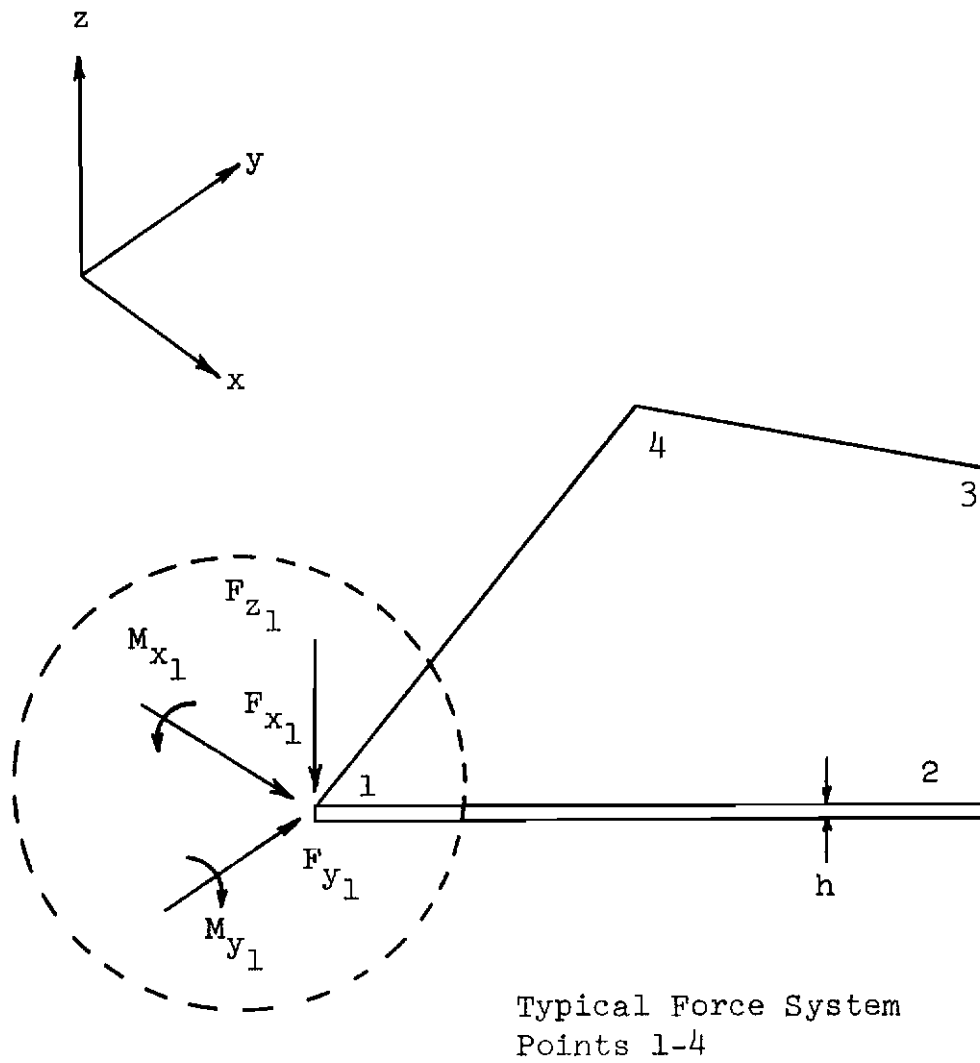

Figure III-5 Quadrilateral Plate Flexural Element

Contrails

The slopes and the deflection, w , at the four corners of the quadrilateral are evaluated to yield the relationships shown as Equation (V-5) in Figure (V-2). The square matrix on the right hand side of Equation V 5 is the $[B]$ matrix.

The $[C_f]$ matrix is determined by first considering the flexural strain energy. In terms of the out-of-plane deflection w , the strain energy is given by

$$U_f = \frac{1}{2} h^3 \iint \left[\frac{E_x}{12M} \left(\frac{\partial^2 w}{\partial x^2} \right)^2 + \frac{E_y}{12M} \left(\frac{\partial^2 w}{\partial y^2} \right)^2 + \frac{E_x \nu_{yx} + E_y \nu_{xy}}{12M} \left(\frac{\partial^2 w}{\partial x^2} \right) \left(\frac{\partial^2 w}{\partial y^2} \right) + \frac{G_{xy}}{3} \left(\frac{\partial^2 w}{\partial x \partial y} \right)^2 \right] dx dy \quad (V-6)$$

where:

$$M = 1 - \nu_{xy} \nu_{yx} \quad (V-7)$$

and $[C_f]$ is shown in Figure III-7.

Contrails

$$\begin{array}{c}
 \left. \begin{array}{l}
 \theta_{x_1} \\
 \theta_{x_2} \\
 \theta_{x_3} \\
 \theta_{x_4} \\
 \theta_{y_1} \\
 \theta_{y_2} \\
 \theta_{y_3} \\
 \theta_{y_4} \\
 w_1 \\
 w_2 \\
 w_3 \\
 w_4
 \end{array} \right\} \\
 \text{88} \\
 = \\
 \left[\begin{array}{cccccccccccc}
 0 & 0 & 0 & 0 & 0 & 0 & 0 & 0 & 0 & 0 & 0 & 0 \\
 0 & 0 & 0 & 0 & 0 & 0 & 0 & 0 & 0 & 0 & 0 & 0 \\
 0 & 0 & 0 & 0 & 0 & 0 & 0 & 0 & 0 & 0 & 0 & 0 \\
 0 & 0 & 0 & 0 & 0 & 0 & 0 & 0 & 0 & 0 & 0 & 0 \\
 0 & 0 & 0 & 0 & 0 & 0 & 0 & 0 & 0 & 0 & 0 & 0 \\
 -3x_2^2 & -2x_2 & -1 & 0 & 0 & 0 & 0 & 0 & 0 & 0 & 0 & 0 \\
 -3x_3^2 & -2x_3 & -1 & 0 & 0 & 0 & 0 & 0 & 0 & 0 & 0 & 0 \\
 -3x_4^2 & -2x_4 & -1 & 0 & 0 & 0 & 0 & 0 & 0 & 0 & 0 & 0 \\
 0 & 0 & 0 & 0 & 0 & 0 & 0 & 0 & 0 & 0 & 0 & 0 \\
 x_2^3 & x_2^2 & x_2 & x_2^3 & x_2^2 & x_2 & x_2^3 & x_2^2 & x_2 & x_2^3 & x_2^2 & x_2 \\
 x_3^3 & x_3^2 & x_3 & x_3^3 & x_3^2 & x_3 & x_3^3 & x_3^2 & x_3 & x_3^3 & x_3^2 & x_3 \\
 x_4^3 & x_4^2 & x_4 & x_4^3 & x_4^2 & x_4 & x_4^3 & x_4^2 & x_4 & x_4^3 & x_4^2 & x_4
 \end{array} \right] \begin{array}{l}
 a_1 \\
 a_2 \\
 a_3 \\
 a_4 \\
 a_5 \\
 a_6 \\
 a_7 \\
 a_8 \\
 a_9 \\
 a_{10} \\
 a_{11} \\
 \vdots \\
 a_{12}
 \end{array}
 \end{array}$$

FIGURE III-6 EQUATION V-5 ([B] MATRIX)

FIGURE III-7 $[c_f]$ MATRIX FOR QUADRILATERAL FLEXURAL ELEMENT

$36 I_x^2$																					
$12 I_x$	$4A$																				
0	0	0	0	0	0	0	0	0	0	0	0	0	0	0	0	0	0	0	0	0	0
$\frac{36 I_x I_{xy}}{\rho}$	$\frac{12 I_{xy} I_x}{\rho}$	$\frac{36 I_y^2}{\rho}$																			
$\frac{12 I_{xy} I_x}{\rho}$	$\frac{4 I_{xy} A}{\rho}$	$\frac{12 I_y}{\rho}$	$\frac{4A}{l}$																		
0	0	0	0	0	0	0	0	0	0	0	0	0	0	0	0	0	0	0	0	0	0
$\frac{36 I_x^2}{\rho}$	$\frac{12 I_{xy}}{\rho}$	$\frac{36 I_x I_{xy}}{\rho}$	$\frac{12 I_{xy} I_x}{\rho}$	$\frac{18(2I_{xy}^2 + \gamma I_x^4)}{\rho}$																	
$12 I_{xy}$	$4 I_y$	$\frac{12 I_{xy} I_y}{\rho}$	$\frac{4 I_{xy} I_y}{\rho}$	$\frac{12(I_{xy}^2 + \gamma I_x^3)}{\rho}$	$4 I_y^2$	$4 \gamma I_x^2$	$4 \gamma I_x$	$2 \gamma A$													
0	0	0	0	0	0	0	0	0	0	0	0	0	0	0	0	0	0	0	0	0	0
$\frac{36 I_x I_x^2}{\rho}$	$\frac{12 I_{xy} I_x}{\rho}$	$\frac{36 I_{xy}^2}{\rho}$	$\frac{12 I_{xy} I_x}{\rho}$	$\frac{18 I_x^2 (\gamma + 2 I_{xy} \rho^{-1})}{\rho}$	$6 \gamma I_x^2$	$6 \gamma I_y^2$	$6 \gamma I_y$	$2 \gamma A$													
$\frac{12 I_{xy} I_x^2}{\rho}$	$\frac{4 I_{xy} I_x}{\rho}$	$\frac{12 I_{xy} I_y}{\rho}$	$\frac{4 I_{xy} I_y}{\rho}$	$\frac{12 I_x^2 (\gamma + I_{xy} \rho^{-1})}{\rho}$	$4 I_x$	$4 I_y$	$4 \gamma I_y$	$4 \gamma I_y$													
0	0	0	0	0	0	0	0	0	0	0	0	0	0	0	0	0	0	0	0	0	0

$$[c_f] = \frac{E_x h^3}{12(1 - \nu_x \nu_y)}$$

Where:

$$\beta = \frac{E_x}{E_y} \rho^{-1} = \frac{1}{\rho}$$

$$\gamma = \frac{2G_{xy}(1 - \nu_x \nu_y)}{E_x}$$

Contracts

Contrails

By calculating the indicated partial derivatives of w from Equation V-1, and substituting into Eq. V-6, the following expression for the energy in terms of the constants, a , is obtained

$$\begin{aligned}
 U_f = \frac{E_x h^3}{24M} \iint & \left[(36x^2 a_1^2 + 24x a_1 a_2 + 72x^2 y a_1 a_7 + 24x y a_1 a_8 \right. \\
 & + 4a_2^2 + 24x y a_2 a_7 + 8y a_2 a_8 + 36x^2 y^2 a_7^2 \\
 & \left. + 24x y^2 a_8 a_8 + 4y^2 a_8^2) \right. \\
 & + \frac{E_y}{E_x} \left(36y^2 a_4^2 + 24y a_4 a_5 + 72x y^2 a_4 a_{10} \right. \\
 & + 24x y a_4 a_{11} + 4a_5^2 + 24x y a_5 a_{10} + 8x a_5 a_{11} \\
 & \left. + 36x^2 y^2 a_{10}^2 + 24x^2 y a_{10} a_{11} + 4x^2 a_{11}^2 \right) \\
 & + 2\mu_{xy} \frac{E_y}{E_x} \left(36x y a_1 a_4 + 12y a_2 a_4 + 36x y^2 a_4 a_7 \right. \\
 & + 12y^2 a_4 a_8 + 12x a_1 a_5 + 4a_2 a_5 + 12x y a_5 a_7 \\
 & + 4y a_5 a_8 + 36x^2 y a_1 a_{10} + 12x y a_2 a_{10} + 36x^2 y^2 a_7 a_{10} \\
 & + 12x y^2 a_8 a_{10} + 12x^2 a_1 a_{11} + 4x a_2 a_{11} + 12x^2 y a_7 a_{11} \\
 & \left. + 4x y a_8 a_{11} \right) \\
 & + \frac{4G_{xy} M}{E_x} \left(9x^4 a_7^2 + 12x^3 a_7 a_8 + 6x^2 a_7 a_9 \right. \\
 & + 18x^2 y^2 a_7 a_{10} + 12x^2 y a_7 a_{11} + 4x^2 a_8^2 + 4x a_8 a_9 \\
 & + 12x y^2 a_8 a_{10} + 8x y a_8 a_{11} + a_9^2 + 6y^2 a_9 a_{10} + 4y a_9 a_{11} \\
 & \left. + 9y^4 a_{10}^2 + 12y^3 a_{10} a_{11} + 4y^2 a_{11}^2 \right) \Big] dx dy \quad (V-8)
 \end{aligned}$$

Next, the strain energy is differentiated with respect to each of the constants, a_1, \dots, a_{12} . For example, the derivative with respect to a_1 is

$$\begin{aligned}
 \frac{\partial U_f}{\partial a_1} = \frac{E_x h^3}{12M} \iint & \left[(36x^2 a_1 + 12x a_2 + 36x^2 y a_7 + 12x y a_8) \right. \\
 & + 2\mu_{xy} \frac{E_y}{E_x} \left(18x y a_4 + 6x a_5 + 18x^2 y a_{10} \right. \\
 & \left. \left. + 6x^2 a_{11} \right) \right] dx dy \quad (V-9)
 \end{aligned}$$

Contrails

Letting $\iint x \, dx \, dy = I_x$, or, in the general form letting

$\iint x^i y^j \, dx \, dy = I_{x^i y^j}$, Eq. V-9 is rewritten as

$$\begin{aligned} \frac{\partial U_F}{\partial a_1} = & \frac{E_x h^3}{12M} \left[36 I_x^2 a_1 + 12 I_x a_2 + 36 I_x^2 y a_7 + 12 I_{xy} a_8 \right. \\ & + \mu_{xy} \frac{E_y}{E_x} (36 I_{xy} a_4 + 12 I_x a_5 + 36 I_x^2 y a_{10} \\ & \left. + 12 I_x^2 a_{11}) \right] \end{aligned} \quad (V-10)$$

The development of all $I_{x^i y^j}$ terms will be presented in detail in Section C.

Three of the derivatives are zero; namely,

$$\frac{\partial U_F}{\partial a_3} = \frac{\partial U_F}{\partial a_6} = \frac{\partial U_F}{\partial a_{12}} = 0$$

In matrix notation the twelve partial derivatives of the energy with respect to the constants may be expressed as

$$\begin{Bmatrix} \frac{U_F}{a_1} \\ \cdot \\ \cdot \\ \cdot \\ \cdot \\ \frac{U_F}{a_{12}} \end{Bmatrix} = [C_f] \begin{Bmatrix} a_1 \\ \cdot \\ \cdot \\ \cdot \\ \cdot \\ a_{12} \end{Bmatrix}$$

The square, symmetric matrix $[C_f]$ is given in Figure III-7.

The $[B]$ and $[C_f]$ matrices can now be used to determine the flexural stiffness matrix, $[K_f]$, for the quadrilateral plate element from Eq. V-2. Clearly, the operation $[B^{-1}]^T [C_f] [B]^{-1}$ is too complicated to allow for an explicit formulation of the $[K_f]$ matrix. It is intended that the formulations of the $[B]$ and $[C_f]$ matrices be stored in the computer for use each time a stiffness matrix is to be evaluated. Unfortunately, it has been found that for certain geometric proportions the $[B]$ matrix will be singular. A means for predicting this singularity and circumventing it is discussed in Section X.

VII. Development of the Incremental Stiffness Matrix

The incremental stiffness matrix $[n]$ is derived through application of the matrix triple product

$$\left([B]^{-1} \right)^T [C_n] [B]^{-1} = [n] \quad (V-12)$$

The $[B]$ matrix is the same as that which has been discussed above. The $[C_n]$ matrix is defined in a similar manner as before, but not the appropriate "energy" integral is

$$U_n = \frac{1}{2} \iint \left[N_x \left(\frac{\partial w}{\partial x} \right)^2 + N_y \left(\frac{\partial w}{\partial y} \right)^2 + 2N_{xy} \left(\frac{\partial w}{\partial x} \right) \left(\frac{\partial w}{\partial y} \right) \right] dx dy \quad (V-13)$$

In developing the (C_n) matrix, it is assumed that the inplane forces N_x , N_y and N_{xy} are constant throughout the element. Since the normal inplane stresses, σ_x and σ_y are actually not constant (see Chapter III), the inplane forces are taken as the average of the edge forces occurring at the four corner points of the quadrilateral plate element. Thus

$$N_x = \left(\frac{\sigma_{x1} + \sigma_{x2} + \sigma_{x3} + \sigma_{x4}}{4} \right) h$$

$$N_y = \left(\frac{\sigma_{y1} + \sigma_{y2} + \sigma_{y3} + \sigma_{y4}}{4} \right) h$$

The shear stress τ_{xy} is constant throughout the element so that $N_{xy} = \tau_{xy} h$

It is convenient to divide the energy expression, Equation V-13, into its three components as follows:

$$U_n = U_{n_x} + U_{n_y} + U_{n_{xy}}$$

$$= \frac{1}{2} N_x \iint \left(\frac{\partial w}{\partial x} \right)^2 dx dy + \frac{1}{2} N_y \iint \left(\frac{\partial w}{\partial y} \right)^2 dx dy + N_{xy} \iint \left(\frac{\partial w}{\partial x} \frac{\partial w}{\partial y} \right) dx dy \quad (V-13a)$$

Contrails

We now consider each energy component separately and obtain a $[C_{n_j}]$ matrix corresponding to each component ($j = x, y$ or xy).

By differentiating the assumed deflection function (Equation V-1) and substituting the derivatives into Eq. V-13a, we obtain an expression for each energy component as follows:

$$\begin{aligned}
 U_{n_x} = \frac{1}{2} N_x \iint & \left[9x^4 a_1^2 + 12x^3 a_1 a_2 + 6x^2 a_1 a_3 + 18x^4 y a_1 a_7 + 12x^3 y a_1 a_8 \right. \\
 & + 6x^2 y a_1 a_9 + 6x^2 y^3 a_1 a_{10} + 6x^2 y^2 a_1 a_{11} + 4x^2 a_2^2 + 4x a_2 a_3 \\
 & + 12x^3 y a_2 a_7 + 8x^2 y a_2 a_8 + 4x y a_2 a_9 + 4x y^3 a_2 a_{10} + 4x y^2 a_2 a_{11} \\
 & + a_3^2 + 6x^2 y a_3 a_7 + 4x y a_3 a_8 + 2y a_3 a_9 + 2y^3 a_3 a_{10} + 2y^2 a_3 a_{11} \\
 & + 9x^4 y^2 a_7^2 + 12x^3 y^2 a_7 a_8 + 6x^2 y^2 a_7 a_9 + 6x^2 y^4 a_7 a_{10} + 6x^2 y^3 a_7 a_{11} \\
 & + 4x^2 y^2 a_8^2 + 4x y^2 a_8 a_9 + 4x y^4 a_8 a_{10} + 4x y^3 a_8 a_{11} + y^2 a_9^2 \\
 & \left. + 2y^4 a_9 a_{10} + 2y^3 a_9 a_{11} + y^6 a_{10}^2 + 2y^5 a_{10} a_{11} + y^4 a_{11}^2 \right] dx dy
 \end{aligned}
 \tag{V-14}$$

$$\begin{aligned}
 U_{n_y} = \frac{1}{2} N_y \iint & \left[9y^4 a_4^2 + 12y^3 a_4 a_5 + 6y^2 a_4 a_6 + 6x^3 y^2 a_4 a_7 + 6x^2 y^2 a_4 a_8 \right. \\
 & + 6x y^2 a_4 a_9 + 18x y^4 a_4 a_{10} + 12x y^3 a_4 a_{11} + 4y^2 a_5^2 + 4y a_5 a_6 \\
 & + 4x^3 y a_5 a_7 + 4x^2 y a_5 a_8 + 4x y a_5 a_9 + 12x y^3 a_5 a_{10} + 8x y^2 a_5 a_{11} \\
 & + a_6^2 + 2x^3 a_6 a_7 + 2x^2 a_6 a_8 + 2x a_6 a_9 + 6x y^2 a_6 a_{10} + 4x y a_6 a_{11} \\
 & + x^6 a_7^2 + 2x^5 a_7 a_8 + 2x^4 a_7 a_9 + 6x^4 y^2 a_7 a_{10} + 4x^4 y a_7 a_{11} + x^4 a_8^2 \\
 & + 2x^3 a_8 a_9 + 6x^3 y^2 a_8 a_{10} + 4x^3 y a_8 a_{11} + x^2 a_9^2 + 6x^2 y^2 a_9 a_{10} \\
 & \left. + 4x^2 y a_9 a_{11} + 9x^2 y^4 a_{10}^2 + 12x^2 y^3 a_{10} a_{11} + 4x^2 y^2 a_{11}^2 \right] dx dy
 \end{aligned}
 \tag{V-15}$$

Contrails

$$\begin{aligned}
 U_{n_{xy}} = N_{xy} \iint & \left[9x^2y^2a_1a_4 + 6xy^2a_2a_4 + 3y^2a_3a_4 + 9x^2y^3a_4a_7 \right. \\
 & + 6xy^3a_4a_8 + 3y^3a_4a_9 + 3y^5a_4a_{10} + 3y^4a_4a_{11} + 6x^2ya_1a_5 \\
 & + 4xya_2a_5 + 2ya_3a_5 + 6x^2y^2a_5a_7 + 4xy^2a_5a_8 + 2y^2a_5a_9 \\
 & + 2y^4a_5a_{10} + 2y^3a_5a_{11} + 3x^2a_1a_6 + 2xa_2a_6 + a_3a_6 \\
 & + 3x^2ya_6a_7 + 2xya_6a_8 + ya_6a_9 + y^3a_6a_{10} + y^2a_6a_{11} \\
 & + 3x^5a_1a_7 + 2x^4a_2a_7 + x^3a_3a_7 + 3x^5ya_7^2 + 3x^4a_1a_8 \\
 & + 2x^3a_2a_8 + x^2a_3a_8 + 5x^4ya_7a_8 + 2x^3ya_8^2 + 3x^3a_1a_9 \\
 & + 2x^2a_2a_9 + xa_3a_9 + 4x^3ya_7a_9 + 3x^2ya_8a_9 + xya_9^2 \\
 & + 9x^3y^2a_1a_{10} + 6x^2y^2a_2a_{10} + 3xy^2a_3a_{10} + 10x^3y^3a_7a_{10} \\
 & + 7x^2y^3a_8a_{10} + 4xy^3a_9a_{10} + 3xy^5a_{10}^2 + 6x^3ya_1a_{11} \\
 & + 4x^2ya_2a_{11} + 2xya_3a_{11} + 7x^3y^2a_7a_{11} + 5x^2y^2a_8a_{11} \\
 & \left. + 3xy^2a_9a_{11} + 5xy^4a_{10}a_{11} + 2xy^3a_{11}^2 \right] dx \, dy \quad 9(V-16)
 \end{aligned}$$

Next the $[C_{n_j}]$ matrices are developed by taking the derivatives

of the respective energy component with respect to the constants,

a. For example in deriving the $[C_{n_x}]$ matrix, the differentiation

of U_{n_x} with respect to a_1 , is

$$\begin{aligned}
 \frac{\partial U_{n_x}}{\partial a_1} &= \frac{N_x}{2} \iint \left[18x^4a_1 + 12x^3a_2 + 6x^2a_3 + 18x^4ya_7 + 12x^3ya_8 \right. \\
 & \quad \left. + 6x^2ya_9 + 6x^2y^3a_{10} + 6x^2y^2a_{11} \right] dx \, dy \\
 &= N_x \left[9I_x^4a_1 + 6I_x^3a_2 + 3I_x^2a_3 + 9I_x^4y a_7 + 6I_x^3y a_8 \right. \\
 & \quad \left. + 3I_x^2y a_9 + 3I_x^2y^3a_{10} + 3I_x^2y^2a_{11} \right] \quad (V-17)
 \end{aligned}$$

Contrails

As noted previously, the $I_{x y}^{i j}$ terms are developed in Section C.

All the other derivatives are calculated similarly and lead to the following expressions

$$\begin{aligned} \left\{ \frac{\partial U_{n_x}}{\partial a_i} \right\} &= [C_{n_x}] \begin{Bmatrix} a_1 \\ \cdot \\ \cdot \\ a_{12} \end{Bmatrix} \\ \left\{ \frac{\partial U_{n_y}}{\partial a_i} \right\} &= [C_{n_y}] \begin{Bmatrix} a_1 \\ \cdot \\ \cdot \\ a_{12} \end{Bmatrix} \\ \left\{ \frac{\partial U_{n_{xy}}}{\partial a_i} \right\} &= [C_{n_{xy}}] \begin{Bmatrix} a_1 \\ \cdot \\ \cdot \\ a_{12} \end{Bmatrix} \end{aligned} \quad (V-18)$$

The matrices $[C_{n_x}]$, $[C_{n_y}]$, and $[C_{n_{xy}}]$ are shown in Figs. III-8, -9 and -10 respectively.

Since $[C_n] = [C_{n_x}] + [C_{n_y}] + [C_{n_{xy}}]$, the incremental stiffness matrix may be stated as

$$[n] = [B^{-1}]^T \left([C_{n_x}] + [C_{n_y}] + [C_{n_{xy}}] \right) [B]^{-1} \quad (V-12a)$$

$$\begin{bmatrix}
 9I_x^4 & 6I_x^3 & 3I_x^2 & 0 & 0 & 0 & 9I_x^4 & 6I_x^3 & 3I_x^2 & 3I_x^2 & 3I_x^2 & 3I_x^2 & 0 \\
 6I_x^3 & 4I_x^2 & 2I_x & 0 & 0 & 0 & 6I_x^3 & 4I_x^2 & 2I_x & 2I_{xy} & 2I_{xy} & 2I_{xy} & 0 \\
 3I_x^2 & 2I_x & A & 0 & 0 & 0 & 3I_x^2 & 2I_{xy} & I_y & I_y & I_y & I_y & 0 \\
 0 & 0 & 0 & 0 & 0 & 0 & 0 & 0 & 0 & 0 & 0 & 0 & 0 \\
 0 & 0 & 0 & 0 & 0 & 0 & 0 & 0 & 0 & 0 & 0 & 0 & 0 \\
 9I_x^4 & 6I_x^3 & 3I_x^2 & 0 & 0 & 0 & 9I_x^4 & 6I_x^3 & 3I_x^2 & 3I_x^2 & 3I_x^2 & 3I_x^2 & 0 \\
 6I_x^3 & 4I_x^2 & 2I_{xy} & 0 & 0 & 0 & 6I_x^3 & 4I_x^2 & 2I_{xy} & 2I_{xy} & 2I_{xy} & 2I_{xy} & 0 \\
 3I_x^2 & 2I_{xy} & I_y & 0 & 0 & 0 & 3I_x^2 & 2I_{xy} & I_y & I_y & I_y & I_y & 0 \\
 3I_x^2 & 2I_{xy} & I_y & 0 & 0 & 0 & 3I_x^2 & 2I_{xy} & I_y & I_y & I_y & I_y & 0 \\
 3I_x^2 & 2I_{xy} & I_y^2 & 0 & 0 & 0 & 3I_x^2 & 2I_{xy} & I_y^2 & I_y^2 & I_y^2 & I_y^2 & 0 \\
 0 & 0 & 0 & 0 & 0 & 0 & 0 & 0 & 0 & 0 & 0 & 0 & 0
 \end{bmatrix}$$

Where $N_x = \left(\frac{\sigma_{x_1} + \sigma_{x_2} + \sigma_{x_3} + \sigma_{x_4}}{4} \right) h$

FIGURE III-8 $\left[\begin{matrix} c \\ n_x \end{matrix} \right]$ MATRIX FOR QUADRILATERAL FLEXURAL ELEMENT

$$\left[\begin{matrix} c \\ n_x \end{matrix} \right] = \left[\begin{matrix} N_x \\ \end{matrix} \right]$$

$$\begin{bmatrix}
 0 & 0 & 0 & 0 & 0 & 9I_{x,y}^{2,2} & 6I_{x,y}^2 & 3I_x^2 & 3I_x^5 & 3I_x^4 & 3I_x^3 & 9I_{x,y}^{3,2} & 6I_{x,y}^3 & 0 \\
 0 & 0 & 0 & 0 & 6I_{xy}^2 & 4I_{xy} & 2I_x & 2I_x & 2I_x^4 & 2I_x^3 & 2I_x^2 & 6I_{x,y}^{2,2} & 4I_{x,y}^2 & 0 \\
 0 & 0 & 0 & 0 & 3I_y^2 & 2I_y & A & I_x^3 & I_x^3 & I_x^2 & I_x & 3I_{xy}^2 & 2I_{xy} & 0 \\
 9I_{x,y}^{2,2} & 6I_{xy}^2 & 3I_y^2 & 0 & 0 & 0 & 0 & 9I_{x,y}^{2,3} & 6I_{xy}^3 & 6I_{xy}^3 & 3I_y^3 & 3I_y^5 & 3I_y^4 & 0 \\
 6I_{xy}^2 & 4I_{xy} & 2I_y & 0 & 0 & 0 & 0 & 6I_{x,y}^{2,2} & 4I_{xy}^2 & 4I_{xy}^2 & 2I_y^2 & 2I_y^4 & 2I_y^3 & 0 \\
 3I_x^2 & 2I_x & A & 0 & 0 & 0 & 0 & 3I_{x,y}^2 & 2I_{xy} & 2I_{xy} & I_y & I_y^3 & I_y^2 & 0 \\
 3I_x^5 & 2I_x^4 & I_x^3 & 9I_{x,y}^{2,3} & 6I_{x,y}^2 & 3I_x^2 & 3I_x^2 & 6I_{x,y}^5 & 5I_{x,y}^4 & 5I_{x,y}^4 & 4I_{x,y}^3 & 10I_{x,y}^{3,3} & 7I_{x,y}^{3,2} & 0 \\
 3I_x^4 & 2I_x^3 & I_x^2 & 6I_{xy}^3 & 4I_{xy}^2 & 2I_{xy} & 2I_{xy} & 5I_{x,y}^4 & 4I_{x,y}^3 & 4I_{x,y}^3 & 3I_x^2 & 7I_{x,y}^{2,3} & 5I_{x,y}^{2,2} & 0 \\
 3I_x^3 & 2I_x^2 & I_x & 3I_y^3 & 2I_y^2 & I_y & I_y & 4I_{x,y}^3 & 3I_{x,y}^2 & 2I_{xy} & 2I_{xy} & 4I_{xy}^3 & 3I_{xy}^2 & 0 \\
 9I_{x,y}^{3,2} & 6I_{x,y}^{2,2} & 3I_{xy}^2 & 3I_y^5 & 2I_y^4 & I_y^3 & I_y^3 & 10I_{x,y}^{3,3} & 7I_{x,y}^{3,3} & 4I_{xy}^3 & 4I_{xy}^3 & 6I_{xy}^5 & 5I_{xy}^4 & 0 \\
 6I_{x,y}^3 & 4I_{x,y}^2 & 2I_{xy} & 3I_y^4 & 2I_y^3 & I_y^2 & I_y^2 & 7I_{x,y}^{3,2} & 5I_{x,y}^{2,2} & 3I_{xy}^2 & 3I_{xy}^2 & 5I_{xy}^4 & 4I_{xy}^3 & 0 \\
 0 & 0 & 0 & 0 & 0 & 0 & 0 & 0 & 0 & 0 & 0 & 0 & 0 & 0
 \end{bmatrix}
 = \begin{bmatrix}
 N_{xy} \\
 \vdots \\
 \vdots \\
 \vdots \\
 \vdots \\
 \vdots \\
 \vdots \\
 \vdots \\
 \vdots \\
 \vdots \\
 \vdots \\
 \vdots \\
 \vdots \\
 \vdots
 \end{bmatrix}$$

Where: $N_{xy} = \tau_{xy} \quad n$

FIGURE III-10 [$C_{n,xy}$] MATRIX FOR QUADRILATERAL FLEXURAL ELEMENT

Contrails

VIII. Geometric Properties

The derivation of the $I_{x y}^{i j}$ terms in the $[C_f]$ and $[C_{n_j}]$

matrices are presented in this section. These terms depend only on the geometry of the element and are defined as

$$I_{x y}^{i j} = \iint x^i y^j dx dy = \int x^i y^j dA$$

Since the terms $I_{\eta \xi}^{i j}$, where η is an axis coincident with one side of the quadrilateral (See Figure III-3) had previously been obtained by direct integration, it was convenient to express the moments, $I_{x y}^{i j}$, in terms of the already known $I_{\eta \xi}^{i j}$'s.

The transformation to the η - ξ coordinates from the x-y coordinates is:

$$\begin{Bmatrix} \eta \\ \xi \end{Bmatrix} = \begin{bmatrix} \cos \theta & \sin \theta \\ -\sin \theta & \cos \theta \end{bmatrix} \begin{Bmatrix} x \\ y \end{Bmatrix} \quad (V-19)$$

and alternately

$$\begin{Bmatrix} x \\ y \end{Bmatrix} = \begin{bmatrix} \cos \theta & -\sin \theta \\ \sin \theta & \cos \theta \end{bmatrix} \begin{Bmatrix} \eta \\ \xi \end{Bmatrix} \quad (V-20)$$

where:

$$\sin \theta = \frac{y_2}{\sqrt{x_2^2 + y_2^2}} \quad \cos \theta = \frac{x_2}{\sqrt{x_2^2 + y_2^2}}$$

To illustrate the derivation of the $I_{x y}^{i j}$'s consider the second moment of area about the y axis, I_x^2 . By definition

$$\begin{aligned} I_x^2 &= \int x^2 dA \\ &= \int (\eta \cos \theta - \xi \sin \theta)^2 dA \\ &= \int (\eta^2 \cos^2 \theta - 2 \eta \xi \sin \theta \cos \theta + \xi^2 \sin^2 \theta) dA \\ &= I_{\eta}^2 \cos^2 \theta - 2I_{\eta \xi} \sin \theta \cos \theta + I_{\xi}^2 \sin^2 \theta \end{aligned} \quad (V-21)$$

Contours

This procedure was used to determine all the $I_{x y}^{i j}$'s in terms of the $I_{\eta \xi}^{i j}$'s. The $I_{\eta \xi}^{i j}$ have been derived elsewhere.

The area, A, of the quadrilateral can be directly determined by adding and subtracting triangles and trapezoids. In both coordinate systems the area is given by

$$\begin{aligned} A &= \frac{1}{2} (x_2 y_3 + x_3 y_4 - x_4 y_3 - x_3 y_2) \\ A &= \frac{1}{2} (\eta_2 \xi_3 + \eta_3 \xi_4 - \eta_4 \xi_3) \end{aligned} \tag{V-22}$$

IX. Development of Corner Thermal Moments

Although the corner thermal moments can be formulated through the use of Castigliano's First Theorem (a procedure consistent with the derivation of the $[K_f]$ and $[n]$ matrices), it is considerably simpler, and probably sufficiently accurate, to obtain the thermal moments by pro-rating the distributed edge moments to the corners. This direct approach was used here and is described in the following.

For the case of a temperature variation through the thickness of the plate element, the thermal moments per unit length at any point i is given by

$$M_x^{\alpha'} = \frac{E_y (1 + \mu_{xy})}{(1 - \mu_{xy} \mu_{yx})} \int_{-\frac{h}{2}}^{\frac{h}{2}} \alpha T \xi d\xi \quad (V-23)$$

$$M_y^{\alpha'} = \frac{E_x (1 + \mu_{yx})}{(1 - \mu_{xy} \mu_{yx})} \int_{-\frac{h}{2}}^{\frac{h}{2}} \alpha T \xi d\xi$$

where ξ is a thickness coordinate measured positively in the positive z direction from the neutral axis of the cross-section.

In deriving the corner thermal moments, it is assumed that the distributed thermal moments are constant throughout the element and equal to the arithmetic average of the moments at the four corners of the quadrilateral. Thus

$$\begin{aligned} M_x^{\alpha'} &= \frac{1}{4} (M_{x_1}^{\alpha'} + M_{x_2}^{\alpha'} + M_{x_3}^{\alpha'} + M_{x_4}^{\alpha'}) \\ M_y^{\alpha'} &= \frac{1}{4} (M_{y_1}^{\alpha'} + M_{y_2}^{\alpha'} + M_{y_3}^{\alpha'} + M_{y_4}^{\alpha'}) \end{aligned} \quad (V-24)$$

Contrails

These average moments are distributed around the edges of the quadrilateral element as shown in the following sketch:

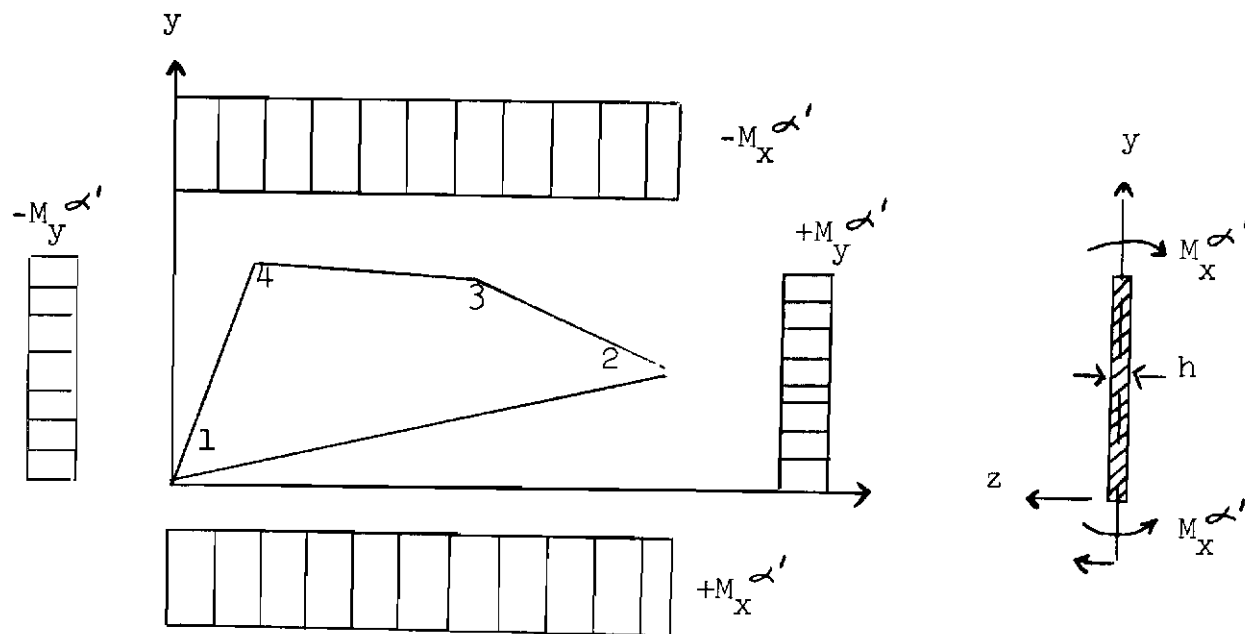

The distributed thermal moments are concentrated ("lumped") at the corners of the element by assigning one-half of the total moment along an edge to each corner bounding the edge. For example, the corner thermal moments at Corner 1 are obtained by

$$\begin{aligned} \bar{M}_{x_1} \alpha' &= M_x \alpha' \frac{x_2}{2} - M_x \alpha' \frac{x_4}{2} = \frac{1}{2} M_x \alpha' (x_2 - x_4) \\ \bar{M}_{y_1} \alpha' &= M_y \alpha' \frac{y_4}{2} + M_y \alpha' \frac{y_2}{2} = \frac{1}{2} M_y \alpha' (y_2 - y_4) \end{aligned} \quad (V-25)$$

Contrails

The corner thermal forces F_z^α are zero so that the thermal moments and forces are expressed in matrix notation as

$$\begin{Bmatrix} \bar{M}_{x_1}^\alpha \\ \bar{M}_{x_2}^\alpha \\ \bar{M}_{x_3}^\alpha \\ \bar{M}_{x_4}^\alpha \\ \bar{M}_{y_1}^\alpha \\ \bar{M}_{y_2}^\alpha \\ \bar{M}_{y_3}^\alpha \\ \bar{M}_{y_4}^\alpha \\ F_{z_1}^\alpha \\ F_{z_2}^\alpha \\ F_{z_3}^\alpha \\ F_{z_4}^\alpha \end{Bmatrix} = \frac{1}{2l} \begin{Bmatrix} M_x^{\alpha'} (x_2 - x_4) \\ M_x^{\alpha'} x_3 \\ M_x^{\alpha'} (x_4 - x_2) \\ -M_x^{\alpha'} x_3 \\ M_y^{\alpha'} (y_2 - y_4) \\ M_y^{\alpha'} y_3 \\ M_y^{\alpha'} (y_4 - y_2) \\ -M_y^{\alpha'} y_3 \\ 0 \\ 0 \\ 0 \\ 0 \end{Bmatrix} \quad (V-26)$$

Contrails

By differentiating the assumed displacement function (Eq. V-1), the following derivatives are obtained

$$\begin{aligned}
 \frac{\partial^2 w}{\partial x^2} &= 6a_1x + 2a_2 + 6a_7xy + 2a_8y \\
 \frac{\partial^2 w}{\partial y^2} &= 6a_4y + 2a_5 + 6a_{10}xy + 2a_{11}x \\
 \frac{\partial^2 w}{\partial x \partial y} &= 3a_7x^2 + 2a_8x + a_9 + 3a_{10}y^2 + 2a_{11}y
 \end{aligned}
 \tag{V-28}$$

Substituting Eqs. V-28 into Eq. V-27, and evaluating the expressions at the centroidal coordinates (x, y) yields the following matrix equation for the moments and forces:

$$\begin{Bmatrix} M_x^1 \\ M_y^1 \\ M_{xy}^1 \\ Q_x \\ Q_y \end{Bmatrix} = [g] \begin{Bmatrix} a_1 \\ a_2 \\ \cdot \\ \cdot \\ \cdot \\ a_{12} \end{Bmatrix}
 \tag{V-29}$$

The [g] matrix is shown in Fig. III-11.

The column of assumed constants, $\{a_i\}$ in Eq. V-29 is eliminated by solving for $\{a_i\}$ in Eq. V-5, giving

$$\begin{Bmatrix} a_1 \\ \cdot \\ \cdot \\ \cdot \\ a_{12} \end{Bmatrix} = [B]^{-1} \begin{Bmatrix} \theta_x \\ \theta_y \\ w \end{Bmatrix}
 \tag{V-5a}$$

$$\begin{aligned}
 [g] = & \begin{bmatrix}
 6D_{xy} \bar{x} \bar{y} & 2D_{xy} \bar{y} & 0 & 6D_y \bar{y} & 2D_y & 0 & 6D_x \bar{x} \bar{y} & 2D_{xy} \bar{y} & 0 & 6D_y \bar{x} \bar{y} & 2D_y \bar{x} & 0 \\
 6D_x \bar{x} & 2D_x & 0 & 6D_{yx} \bar{x} \bar{y} & 2D_{yx} \bar{x} & 0 & 6D_x \bar{x} \bar{y} & 2D_x \bar{y} & 0 & 6D_{yx} \bar{x} \bar{y} & 2D_{yx} \bar{x} & 0 \\
 0 & 0 & 0 & 0 & 0 & 0 & -3D_{xy} \bar{x}^2 & -2D_{xy} \bar{x} & -D_{xy} & -3D_{xy} \bar{y}^2 & -2D_{xy} \bar{y} & 0 \\
 6D_x & 0 & 0 & 0 & 0 & 0 & 6D_x \bar{y} & 0 & 0 & 6D_Q \bar{y} & 2D_Q & 0 \\
 0 & 0 & 0 & 6D_y & 0 & 0 & 6D_Q \bar{x} & 2D_Q & 0 & 6D_y \bar{x} & 0 & 0
 \end{bmatrix}
 \end{aligned}$$

where:

$$\begin{aligned}
 D_x &= \frac{E_x h^3}{12(1-\nu_{xy} \nu_{yx})} \\
 D_y &= \frac{E_y h^3}{12(1-\nu_{xy} \nu_{yx})} \\
 D_{xy} &= \frac{G_{xy} h^3}{6} \\
 D_Q &= D_x + D_{xy}
 \end{aligned}$$

$$\begin{aligned}
 \bar{x} &= \frac{I_x}{A} \\
 \bar{y} &= \frac{I_y}{A}
 \end{aligned}$$

FIGURE III-11 [g] MATRIX FOR QUADRILATERAL PLATE ELEMENT IN FLEXURE

And then substituting this expression into Eq. V-29 to yield

$$\begin{Bmatrix} M_x^1 \\ M_y^1 \\ M_{xy}^1 \\ Q_x \\ Q_y \end{Bmatrix} = [g][B]^{-1} \begin{Bmatrix} \theta_{x1} \\ \theta_{x2} \\ \theta_{x3} \\ \theta_{x4} \\ \theta_{y1} \\ \theta_{y2} \\ \theta_{y3} \\ \theta_{y4} \\ w_1 \\ w_2 \\ w_3 \\ w_4 \end{Bmatrix} \quad (V-30)$$

To account for the presence of thermal moments, Equation V-30 is modified as follows:

$$\begin{Bmatrix} M_x^1 \\ M_y^1 \\ M_{xy}^1 \\ Q_x \\ Q_y \end{Bmatrix} = [S] \begin{Bmatrix} \theta_{x1} \\ \cdot \\ \cdot \\ \theta_{x4} \\ \theta_{y1} \\ \cdot \\ \cdot \\ \theta_{y4} \\ w_1 \\ \cdot \\ \cdot \\ w_4 \end{Bmatrix} - \{S^\alpha\} \quad (V-31)$$

Where $[S] = [g][B]^{-1}$ and $\{S^\alpha\}$, the column of thermal moments and forces, is given by

$$\{S^\alpha\} = \begin{Bmatrix} M_x \\ M_y \\ 0 \\ 0 \\ 0 \end{Bmatrix} \quad 86$$

(V-32)

Contrails

In Eq. V-32, $M_x^{\alpha'}$ and $M_y^{\alpha'}$ are the average distributed thermal moments defined by Equation V-24.

X. Criterion for the Singularity of the [B] Matrix

Under certain geometric conditions the [B] matrix may be singular. When this is the case there is no alternative but to revise the analytical model so as to define an element of different geometric proportions. It is, of course, undesirable to permit a complete analysis before the singularity is recognized. Hence, the following criterion for assessing singularity or ill-conditioning has been developed; it can be applied by means of hand computation before the analysis is performed or incorporated as a check in the routine for the computation of the element force-displacement relationships.

The derived criterion is actually the result of an attempt to develop an explicit inverse of the [B] matrix. By appropriate rearrangement of rows and columns and through partitioning it can be demonstrated that the singularity of the complete matrix depends on the singularity of a certain 3 x 3 matrix. This 3 x 3 matrix is also too complicated to permit its explicit inversion. Its determinant can be formulated, however, and it may be recalled that a criterion for singularity is whether or not the determinant is zero. The algebraic statement of the determinant in question, D, is

$$D = \eta_3^3 \xi_4^3 (c_1 \beta^4 + c_2 \beta^3 + c_3 \beta^2 + c_4 \beta + c_5)$$

where:

$$c_1 = (\alpha - 1)^2 (\gamma - 1)$$

$$c_2 = 2\{\gamma(5\alpha - 2) + \gamma^2(\alpha\gamma - 1) + (1 - 2\alpha) + \alpha^2(1 + \gamma^2)(1 - \gamma)\}$$

$$c_3 = (\gamma - 1) [3\gamma - 2\alpha\gamma(\gamma + 1) - 6\alpha^2\gamma^2 + 4\alpha^2\gamma(\gamma^2 + \gamma + 1)] \\ + \gamma^3(1 - 2\alpha\gamma) + 2\alpha - 1$$

$$c_4 = 2\gamma(1 - \gamma)(1 - \alpha\gamma) [\gamma(1 - \alpha\gamma) + 1 - \alpha]$$

$$c_5 = \gamma^2(1 - \alpha\gamma)^2(\gamma - 1) \tag{V-33}$$

$$\alpha = \frac{\eta_3}{\eta_2} ; \beta = \frac{\xi_4}{\xi_3} ; \gamma = \frac{\eta_4}{\eta_3}$$

Contrails

Thus, if $D = 0$, the $[B]$ matrix will be singular. Equally important is the case where $[B]$ is nearly singular (i.e., the terms in the adjoint of the 3×3 matrix are very large in comparison to the determinant), since this will also produce a meaningless inverse for the $[B]$ matrix. A suggested criterion for this condition is the ratio of the first diagonal element of the adjoint to the determinant, D . Experience has indicated that if this ratio is less than about 100, then it is reasonable to expect a satisfactory inverse for the $[B]$ matrix. The first diagonal element, designated A_{11} , can be determined by

$$\begin{aligned} A_{11} = & (3\eta_2^3 \eta_3 \epsilon_3 \epsilon_4^5 - 2\eta_2^3 \eta_3 \epsilon_3^2 \epsilon_4^4)(\eta_3 - \eta_4)(3\eta_3 - 2\eta_2) \\ & + (3\eta_2^3 \eta_4 \epsilon_3^3 \epsilon_4^3 - 2\eta_2^3 \eta_4 \epsilon_3^4 \epsilon_4^2)(\eta_3 - \eta_4)(2\eta_2 - 3\eta_4) \\ & + 9\eta_2^4 \eta_3^2 \epsilon_3 \epsilon_4^5 - 12\eta_2^3 \eta_3^3 \epsilon_3 \epsilon_4^5 - 6\eta_2^4 \eta_3 \eta_4 \epsilon_3 \epsilon_4^5 \\ & + 9\eta_2^3 \eta_3^2 \eta_4 \epsilon_3 \epsilon_4^5 - 13\eta_2^4 \eta_3^2 \epsilon_3^2 \epsilon_4^4 + \eta_2^4 \epsilon_3^3 \epsilon_4^5 \\ & - \eta_2^3 \eta_4 \epsilon_3^3 \epsilon_4^5 + 16\eta_2^3 \eta_3^3 \epsilon_3^2 \epsilon_4^4 + 6\eta_2^4 \eta_3 \eta_4 \epsilon_3^2 \epsilon_4^4 \\ & - 9\eta_2^3 \eta_3^2 \eta_4 \epsilon_3^2 \epsilon_4^4 - 4\eta_2^3 \eta_3^3 \epsilon_3^3 \epsilon_4^3 \\ & + 4\eta_2^4 \eta_3^2 \epsilon_3^3 \epsilon_4^3 - \eta_2^4 \epsilon_3^4 \epsilon_4^4 + \eta_2^3 \eta_4 \epsilon_3^4 \epsilon_4^4 \quad (V-34) \end{aligned}$$

D. TRIANGULAR PLATE ELEMENT

I. Introduction

The formulation of the triangular plate discrete element described, is derived from and mathematically consistent with, the formulation described in Reference 12. The addition of this particular element, as a companion element to the quadrilateral plate described previously, serves to compliment the additional capability available for the analysis of shell structures particularly when instability analyses are to be performed.

A detailed derivation is presented for the force-displacement properties of an orthotropic triangular thin plate element exhibiting membrane and bending behavior. Included in these relationships are terms for stiffness, stress, thermal stress and incremental stiffness.

Contrails

II. Development of Linear Elastic Membrane Stiffness Matrix

A matrix statement of Castigliano's first theorem, Part I, applicable to the derivation of discrete element force-displacement properties may be written as follows:

$$[K] = [B^{-1}]^T [C] [B]^{-1} \quad (\text{II-1})$$

where $[K]$ is the desired matrix of element stiffness coefficients, $[B]$ is a matrix in which the rows are the coefficients of equations for the corner point displacements in terms of the constants of the assumed displacement pattern, and the rows of $[C]$ are the coefficients of these same constants in equations which represent the derivatives of the strain energy (expressed as functions of the constants of the assumed behavior function) with respect to the respective constants.

For the triangular plate element, we assume linear displacements, i.e.,

$$u = a_1 + a_2 x + a_3 y \quad (\text{II-2})$$

$$v = a_4 + a_5 x + a_6 y \quad (\text{II-3})$$

where a_1, \dots, a_6 are the constants in these assumed functions. Eqs. II-2 and II-3 can be evaluated at corner points 1, 2, and 3 (see sketch below) to yield the following relationships:

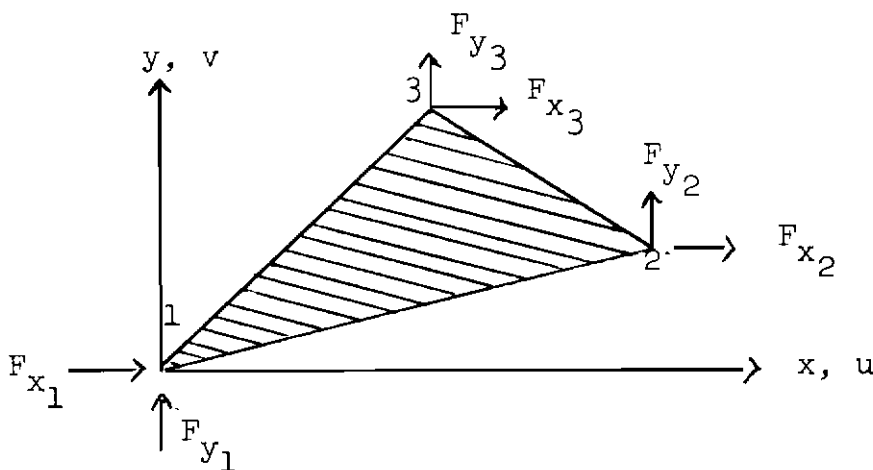

Contrails

$$\begin{Bmatrix} u_1 \\ u_2 \\ u_3 \\ v_1 \\ v_2 \\ v_3 \end{Bmatrix} = \begin{bmatrix} 1 & 0 & 0 & 0 & 0 & 0 \\ 1 & x_2 & y_2 & 0 & 0 & 0 \\ 1 & x_3 & y_3 & 0 & 0 & 0 \\ 0 & 0 & 0 & 1 & 0 & 0 \\ 0 & 0 & 0 & 1 & x_2 & y_2 \\ 0 & 0 & 0 & 1 & x_3 & y_3 \end{bmatrix} \begin{Bmatrix} a_1 \\ a_2 \\ a_3 \\ a_4 \\ a_5 \\ a_6 \end{Bmatrix} \quad (\text{II-4})$$

where the square matrix on the right side is the [B] matrix, whose inverse is:

$$[B]^{-1} = \frac{1}{x_2 y_3 - x_3 y_2} \begin{bmatrix} (x_2 y_3 - x_3 y_2) & 0 & 0 & 0 & 0 & 0 \\ -y_{3-2} & y_3 & -y_2 & 0 & 0 & 0 \\ x_{3-2} & -x_3 & x_2 & 0 & 0 & 0 \\ 0 & 0 & 0 & (x_2 y_3 - x_3 y_2) & 0 & 0 \\ 0 & 0 & 0 & -y_{3-2} & y_3 & -y_2 \\ 0 & 0 & 0 & x_{3-2} & -x_3 & x_2 \end{bmatrix} \quad (\text{II-5})$$

where $y_{3-2} = y_3 - y_2$ and $x_{3-2} = x_3 - x_2$.

To develop the [C] matrix we first need the expression for strain energy for orthotropic plane stress. This can be written, in terms of strain as:

$$U = \frac{h}{2} \int_A \left\{ (\epsilon_x - \epsilon_x^i) \left[\frac{E_x}{M} (\epsilon_x + \mu_{yx} \epsilon_y) - \frac{(1 + \mu_{yx})}{M} E_x \epsilon_x^i \right] + (\epsilon_y - \epsilon_y^i) \left[\frac{E_y}{M} (\epsilon_y + \mu_{xy} \epsilon_x) - \frac{(1 + \mu_{xy})}{M} E_y \epsilon_y^i \right] + G_{xy} (\gamma_{xy} - \gamma_{xy}^i)^2 \right\} dA \quad (\text{II-6})$$

where $M = 1 - \mu_{xy} \mu_{yx}$

and ϵ_x^i , ϵ_y^i and γ_{xy}^i are initial strains. The strains are obtained from the strain displacement expressions as:

Contrails

$$\epsilon_x = \frac{\partial u}{\partial x} = a_2 \quad (\text{II-7})$$

$$\epsilon_y = \frac{\partial u}{\partial y} = a_6 \quad (\text{II-8})$$

$$\gamma_{xy} = \frac{\partial u}{\partial x} + \frac{\partial v}{\partial y} = a_3 + a_5 \quad (\text{II-9})$$

so that, upon expansion and substitution of Eqs. II-7, -8 and -9
Eq. II-6 becomes

$$\begin{aligned} U = \frac{h}{2M} \int \left\{ E_x \left[a_2^2 + \mu_{yx} a_2 a_6 - \epsilon_x^i a_2 - \epsilon_x^i \mu_{yx} a_6 - (1 + \mu_{yx}) \right. \right. \\ \left. \left. \epsilon_x^i a_2 + (1 + \mu_{yx}) (\epsilon_x^i)^2 \right] + E_y \left[a_6^2 + \mu_{xy} a_2 a_6 \right. \right. \\ \left. \left. - \epsilon_y^i a_6 - \epsilon_y^i \mu_{xy} a_2 - (1 + \mu_{xy}) \epsilon_y^i a_6 + (1 + \mu_{xy}) (\epsilon_y^i)^2 \right] \right. \\ \left. + G_{xy} M \left[a_3^2 + 2a_3 a_5 + a_5^2 - 2(a_3 + a_5) \gamma_{xy}^i + \gamma_{xy}^{i^2} \right] \right\} dA \end{aligned} \quad (\text{II-6a})$$

The derivatives of which, with respect to the constants $a_1 \dots a_6$, are

$$\frac{\partial U}{\partial a_1} = 0 \quad (\text{II-10a})$$

$$\frac{\partial U}{\partial a_2} = \frac{h}{M} \left\{ E_x \left[a_2 + \mu_{yx} a_6 - \epsilon_x^i - \frac{\mu_{yx}}{2} (\epsilon_x^i + \epsilon_y^i) \right] \right\} A \quad (\text{II-10b})$$

$$\frac{\partial U}{\partial a_3} = \frac{h}{M} \left[G_{xy} M (a_3 + a_5 - \gamma_{xy}^i) \right] A \quad (\text{II-10c})$$

$$\frac{\partial U}{\partial a_4} = 0 \quad (\text{II-10d})$$

$$\frac{\partial U}{\partial a_5} = \frac{h}{M} \left[G_{xy} M (a_3 + a_5 - \gamma_{xy}^i) \right] A \quad (\text{II-10e})$$

$$\frac{\partial U}{\partial a_6} = \frac{h}{M} \left\{ E_y \left[a_6 + \mu_{xy} a_2 - \epsilon_y^i - \frac{\mu_{xy}}{2} (\epsilon_x^i + \epsilon_y^i) \right] \right\} A \quad (\text{II-10f})$$

Contrails

Setting aside all terms which involve initial strains
(these will be treated in Section II-B), we have

$$\left(\begin{array}{c} \frac{\partial U}{\partial a_1} \\ \frac{\partial U}{\partial a_2} \\ \frac{\partial U}{\partial a_3} \\ \frac{\partial U}{\partial a_4} \\ \frac{\partial U}{\partial a_5} \\ \frac{\partial U}{\partial a_6} \end{array} \right) = \frac{hA}{M} \begin{bmatrix} 0 & 0 & 0 & 0 & 0 & 0 \\ 0 & E_x & 0 & 0 & 0 & \mu_{yx} E_x \\ 0 & 0 & G_{xy} M & 0 & G_{xy} M & 0 \\ 0 & 0 & 0 & 0 & 0 & 0 \\ 0 & 0 & G_{xy} M & 0 & G_{xy} M & 0 \\ 0 & \mu_{yx} E_x & 0 & 0 & 0 & E_y \end{bmatrix} \left(\begin{array}{c} a_1 \\ a_2 \\ a_3 \\ a_4 \\ a_5 \\ a_6 \end{array} \right) \quad (\text{II-10})$$

The square matrix on the right is the matrix $[C]$. Utilizing $[B]^{-1}$ from Eq. II-5 and the definition of $[C]$ from Equation II-10 in Eq. II-1 and performing the indicated operations results in the element stiffness relationships shown on the next page.

Contrails

$$[K] = \frac{h A}{M (x_2^2 y_3 - x_3^2 y_2)^2}$$

(II-11)

(SYMMETRIC)

$E_x y_3^2 - 2 + G_{xy} M_x x_3 - 2$		
$-E_x y_3^2 y_3 - 2$	$E_x y_3^2$	
$-G_{xy} x_3^2 x_3 - 2$	$+G_{xy} M_x x_2$	
$E_x y_2^2 y_3 - 2$		
$+G_{xy} M_x^2 x_3 - 2$		
$-y_x x_3^2 x_3 - 2 y_3 - 2$	$-y_x x_3^2 x_3 - 2$	$E_y x_3^2$
$-G_{xy} M_x x_3 - 2 y_3 - 2$	$+G_{xy} M_x x_2 y_3 - 2$	$+G_{xy} M_y y_3 - 2$
$y_x x_3^2 y_3 - 2$	$y_x x_3^2 y_3$	$E_y x_3^2$
$+G_{xy} M_x y_3 x_3 - 2$	$+G_{xy} M_x x_2 y_3$	$+G_{xy} M_y y_3$
$-y_x x_2^2 y_3 - 2$	$-y_x x_2^2 y_3$	$-E_y x_2^2 x_3$
$-G_{xy} M_x y_2 x_3 - 2$	$+G_{xy} M_x x_2 y_2$	$-G_{xy} M_y y_2 y_3$
		$E_y x_2^2$
		$+G_{xy} M_y y_2$

Where: $M = (1 - \frac{h}{xy} \frac{h}{yx})$
 $x_3 - 2 = x_3 - x_2$
 $y_3 - 2 = y_3 - y_2$

Contrails

III. Development of Initial Force Terms

In the case of initial strains (e.g., thermal strains, previously accumulated in elastic strains, and large deflection strains) it is necessary to determine the forces corresponding to the initial strains.

With assumed displacement patterns (Eq. II-2 and -3) the strain energy is expressed in terms of the constants $\{a\}$ and the initial strains as shown in Eq. II-6a. The differentiation of Eq. II-6a with respect to the individual constants $\{a\}$, Eqs. II-10a - 10f, results in

$$\frac{\partial U}{\partial a} = [c] \{a\} - \left\{ \frac{\partial U^i}{\partial a} \right\} \quad (\text{II-12})$$

where $\left\{ \frac{\partial U^i}{\partial a} \right\}$ represents the initial strain terms which were set aside in forming Eq. II-10, and is given by

$$\begin{pmatrix} \frac{\partial U^i}{\partial a_1} \\ \frac{\partial U^i}{\partial a_2} \\ \frac{\partial U^i}{\partial a_3} \\ \frac{\partial U^i}{\partial a_4} \\ \frac{\partial U^i}{\partial a_5} \\ \frac{\partial U^i}{\partial a_6} \end{pmatrix} = \frac{hA}{M} \begin{bmatrix} 0 & 0 & 0 \\ 1 + \frac{\mu_{yx}}{2} E_x & \frac{\mu_{yx} E_x}{2} & 0 \\ 0 & 0 & G_{xy} M \\ 0 & 0 & 0 \\ 0 & 0 & G_{xy} M \\ \frac{\mu_{xy} E_y}{2} & (1 + \frac{\mu_{xy}}{2}) E_y & 0a \end{bmatrix} \begin{pmatrix} \epsilon_x^i \\ \epsilon_y^i \\ \delta_{xy}^i \end{pmatrix} \quad (\text{II-13})$$

Contrails

The corner forces on the element are obtained by multiplying Eq. II-13 by $\left[\frac{\partial \mathbf{a}}{\partial \delta} \right] = \left[\mathbf{B}^{-1} \right]^T$ which results in

$$\{ \mathbf{F} \} = \left[\mathbf{B}^{-1} \right]^T \left[\mathbf{C} \right] \{ \mathbf{a} \} - \left[\mathbf{B}^{-1} \right]^T \left\{ \frac{\partial U^i}{\partial \mathbf{a}} \right\} \quad (\text{II-14})$$

The first term on the right side of Eq. II-14 yields the corner forces due to displacement, i.e., the forces which would be required to induce the corner deformations, u and v , elastically. The second term represents the initial forces, $\{ \mathbf{F}^i \}$. Thus

$$\{ \mathbf{F}^i \} = \left[\mathbf{B}^{-1} \right]^T \left\{ -\frac{\partial U^i}{\partial \mathbf{a}} \right\} \quad (\text{II-15})$$

Utilizing $\left[\mathbf{B}^{-1} \right]^T$ from Eq. II-5, $\left\{ -\frac{\partial U^i}{\partial \mathbf{a}} \right\}$ from Equation II-13 and performing the product yields the following expression for the initial forces:

$$\begin{pmatrix} F_{x_1}^i \\ F_{x_2}^i \\ F_{x_3}^i \\ F_{y_1}^i \\ F_{y_2}^i \\ F_{y_3}^i \end{pmatrix} \frac{hA}{(x_2 y_3 - x_3 y_2) M} \begin{bmatrix} -E_x \left(1 + \frac{\mu_{yx}}{2}\right) y_{3-2} & \frac{-E_x \mu_{yx}}{2} y_{3-2} & G_{xy} M_{x_{3-2}} \\ E_x \left(1 + \frac{\mu_{yx}}{2}\right) y_3 & \frac{E_x \mu_{yx}}{2} y_3 & -G_{xy} M_{x_3} \\ -E_x \left(1 + \frac{\mu_{yx}}{2}\right) y_2 & \frac{-E_x \mu_{yx}}{2} y_2 & G_{xy} M_{x_2} \\ \frac{E_y \mu_{xy}}{2} x_{3-2} & E_y \left(1 + \frac{\mu_{xy}}{2}\right) x_{3-2} & -G_{xy} M_{y_{3-2}} \\ \frac{-E_y \mu_{xy}}{2} x_3 & -E_y \left(1 + \frac{\mu_{xy}}{2}\right) x_3 & G_{xy} M_{y_3} \\ \frac{E_y \mu_{xy}}{2} x_2 & E_y \left(1 + \frac{\mu_{xy}}{2}\right) x_2 & -G_{xy} M_{y_2} \end{bmatrix} \begin{pmatrix} \epsilon_x^i \\ \epsilon_y^i \\ \gamma_{xy}^i \end{pmatrix} \quad (\text{II-16})$$

Contrails

For thermal strain situations, letting T represent the average temperature change of the element, the initial strains are defined by

$$\begin{aligned} \epsilon_x^i &= \alpha_x T \\ \epsilon_y^i &= \alpha_y T \\ \gamma_{xy}^i &= 0 \end{aligned} \tag{II-17}$$

where α_x and α_y are the thermal coefficients of expansion in the x and y directions respectively. For the usual case of $\alpha_x = \alpha_y = \alpha$, the initial forces given by Eq. II-16 simplify to the following

$$\left\{ F^i \right\} = \frac{hAE_x(1 + \frac{\mu_{yx}}{y_x})\alpha T}{(x_2y_3 - x_3y_2) M} \left\{ \begin{array}{l} -y_{3-2} \\ y_3 \\ -y_2 \\ \frac{(1 + \frac{\mu_{xy}}{x_y})}{(1 + \frac{\mu_{yx}}{y_x})} \frac{E_y}{E_x} x_{3-2} \\ -\frac{(1 + \frac{\mu_{xy}}{x_y})}{(1 + \frac{\mu_{yx}}{y_x})} \frac{E_y}{E_x} x_3 \\ \frac{(1 + \frac{\mu_{xy}}{x_y})}{(1 + \frac{\mu_{yx}}{y_x})} \frac{E_y}{E_x} x_2 \end{array} \right\} \tag{II-16a}$$

IV. Stress Equations

The equations for the stresses in terms of the corner point displacements and initial strains will be derived in this section. In Section II-A, it was noted that the strains in the triangular plate element are constant (Eqs. II-7, -8 and -9). This results in constant stresses which can be expressed by the following:

$$\begin{Bmatrix} \sigma_x \\ \tau_{xy} \\ \sigma_y \end{Bmatrix} = [S_{xy}] \begin{Bmatrix} u_1 \\ u_2 \\ u_3 \\ v_1 \\ v_2 \\ v_3 \end{Bmatrix} - \begin{Bmatrix} \sigma_x^i \\ \tau_{xy}^i \\ \sigma_y^i \end{Bmatrix} \quad (\text{II-18})$$

The first term on the right side of Eq. II-18 represents the stresses corresponding to the corner displacements and the second term denotes the initial stresses.

To develop the $[S_{xy}]$ matrix and initial stresses, the relationships between stresses and strains will be formulated in accordance with Hooke's Law. For an orthotropic material the strains are expressed by

$$\begin{aligned} \epsilon_x &= \frac{1}{E_x} (\sigma_x - \mu_{xy} \sigma_y) + \epsilon_x^i \\ \epsilon_y &= \frac{1}{E_y} (\sigma_y - \mu_{yx} \sigma_x) + \epsilon_y^i \\ \gamma_{xy} &= \frac{\tau_{xy}}{G_{xy}} + \gamma_{xy}^i \end{aligned} \quad (\text{II-19})$$

Solving Eq. II-19 for the stresses give

$$\begin{aligned} \sigma_x &= \frac{E_x}{M} (\epsilon_x + \mu_{yx} \epsilon_y) - \frac{E_x}{M} (\epsilon_x^i + \mu_{yx} \epsilon_y^i) \\ \sigma_y &= \frac{E_y}{M} (\epsilon_y + \mu_{xy} \epsilon_x) - \frac{E_y}{M} (\epsilon_y^i + \mu_{xy} \epsilon_x^i) \\ \tau_{xy} &= G_{xy} \gamma_{xy} - G_{xy} \gamma_{xy}^i \end{aligned} \quad (\text{II-20})$$

Contrails

The first terms on the right hand side of Equations II-20 give the displacement stresses. By replacing the strains in these terms by Eq. II-7, -8 and -9, the displacement stresses can be expressed in terms of the constants in the assumed displacement functions by the following

$$\begin{Bmatrix} \sigma_x^i \\ \tau_{xy}^i \\ \sigma_y^i \end{Bmatrix} = \frac{E_x}{M} \begin{bmatrix} 0 & 1 & 0 & 0 & 0 & 0 \\ 0 & 0 & \frac{G_{xy} M}{E_x} & 0 & \frac{G_{xy} M}{E_x} & 0 \\ 0 & \mu_{yx} & 0 & 0 & 0 & 0 \end{bmatrix} \begin{Bmatrix} u_{yx} \\ 0 \\ \frac{E_y}{E_x} \end{Bmatrix} \begin{Bmatrix} a_1 \\ a_2 \\ a_3 \\ a_4 \\ a_5 \\ a_6 \end{Bmatrix} \quad (\text{II-21})$$

Next the corner point displacements, u and v , are introduced into Eq. II-21 by utilizing, from Sect. II-A, the relationship

$$\{a\} = [B]^{-1} \begin{Bmatrix} u \\ v \end{Bmatrix} \quad (\text{II-4a})$$

So that Eq. II-21 may be written as

$$\begin{Bmatrix} \sigma_x^i \\ \tau_{xy}^i \\ \sigma_y^i \end{Bmatrix} = \frac{E_x}{M} [D] [B]^{-1} \begin{Bmatrix} u_1 \\ u_2 \\ u_3 \\ v_1 \\ v_2 \\ v_3 \end{Bmatrix} \quad (\text{II-22})$$

where $[D]$ represents the rectangular matrix on the right hand side of Eq. II-21 and $[B]^{-1}$ is defined in Eq. II-5. By explicitly forming the product of these two matrices as indicated, Eq. II-22 can be written as

$$\{\sigma^i\} = [S_{xy}] \begin{Bmatrix} u \\ v \end{Bmatrix} \quad (\text{II-22a})$$

Contrails

where

$$\left[S_{xy} \right] = \frac{E_x}{(x_2 y_3 - x_3 y_2) M} \begin{bmatrix} -y_{3-2} & y_3 & -y_2 \\ \frac{G_{xy} M}{E_x} x_{3-2} & \frac{-GM}{E_x} x_3 & \frac{GM}{E_x} x_2 \\ -\mu_{yx} y_{3-2} & \mu_{yx} y_3 & -\mu_{yx} y_2 \\ \mu_{yx} x_{3-2} & -\mu_{yx} x_3 & \mu_{yx} x_2 \\ \frac{-GM}{E_x} y_{3-2} & \frac{GM}{E_x} y_3 & \frac{-GM}{E_x} y_2 \\ \frac{E_y}{E_x} x_{3-2} & \frac{E_y}{E_x} x_3 & \frac{E_y}{E_x} x_2 \end{bmatrix} \quad (II-23)$$

The initial stresses are now determined from the second terms on the right hand side of Eq. II-20. The consideration of these terms gives

$$\begin{Bmatrix} \sigma_x^i \\ \tau_{xy}^i \\ \sigma_y^i \end{Bmatrix} = \frac{E_x}{M} \begin{bmatrix} 1 & 0 & \mu_{yx} \\ 0 & \frac{G_{xy} M}{E_x} & 0 \\ \mu_{yx} & 0 & \frac{E_y}{E_x} \end{bmatrix} \begin{Bmatrix} \epsilon_x^i \\ \gamma_{xy}^i \\ \epsilon_y^i \end{Bmatrix} \quad (II-24)$$

(The minus sign is not included in the terms of Eq. II-24 since it already has been incorporated in the stress formulation of Eq. II-18.)

As noted in Section II-B, for thermal conditions $\epsilon_x^i = \alpha_x T$; $\epsilon_y^i = \alpha_y T$ and $\gamma_{xy}^i = 0$. Then, for the case where $\alpha_x = \alpha_y = \alpha$, the thermal stresses are given by

$$\begin{Bmatrix} \sigma_x^\alpha \\ \tau_{xy}^\alpha \\ \sigma_y^\alpha \end{Bmatrix} = \frac{E_x (1 + \mu_{yx}) \alpha T}{M} \begin{Bmatrix} 1 \\ 0 \\ \frac{(1 + \mu_{xy}) E_y}{(1 + \mu_{yx}) E_x} \end{Bmatrix} \quad (II-25)$$

V. Development of Linear Elastic Stiffness Matrix (Bending)

The force-displacement properties of an orthotropic triangular plate element in bending, subjected to known midplane forces, are derived in this section. The element is pictured in Figure III-12. As in previous chapters, the stiffness matrix is derived by application of Castigliano's Theorem. In the case of plates in flexure subjected to midplane forces, however, the stiffness matrix $[K_z]$ is composed of two parts, i.e.;

$$[K_z] = [K_f] + [n] \quad (IV-1)$$

where

$[K_f]$ is the stiffness matrix for flexure alone.

$[n]$ is the stiffness matrix associated with the influence on flexure of known midplane forces.

The present section is concerned with the derivation of the $[K_f]$ matrix; the $[n]$ matrix is developed in the next section.

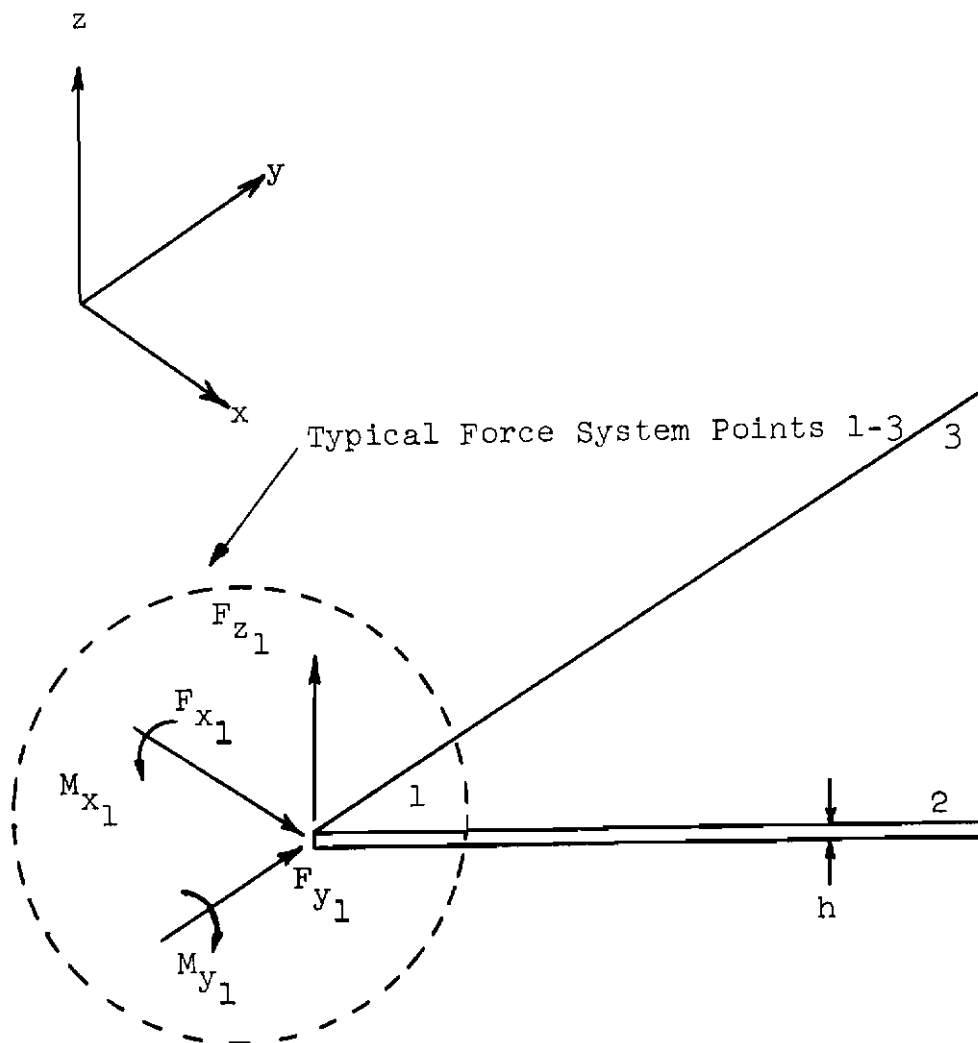

Figure III-12 Triangular Plate Flexural Element

Contrails

As shown in Section III-A.3 of Reference 12 the $[K_f]$ matrix can be defined as:

$$[K_f] = [B^{-1}]^T [C_f] [B]^{-1} \quad (IV-2)$$

where, as in previous sections $[B]$ is a matrix in which the rows are the coefficients of equations for the corner point displacements in terms of the constants of the assumed displacement pattern, and the rows of $[C_f]$ are the coefficients of these same constants in equations which represent the derivatives of the strain energy (expressed as functions of the constants of the assumed behavior function) with respect to the respective constants.

The following assumed displacement function will be utilized as the basis for this derivation.

$$w = a_1 + a_2x + a_3y^2 + a_4y + a_5x^2 + a_6x^3 + a_7y^3 + a_8xy + a_9xy^2 \quad (IV-3)$$

where a_1, \dots, a_9 are constants.

The angular displacements (slopes) of the plate are given by:

$$\theta_x = \frac{\partial w}{\partial y} = 2a_3y + a_4 + 3a_7y^2 + a_8x + 2a_9xy \quad (IV-4)$$

$$\theta_y = \frac{\partial w}{\partial x} = -a_2 - 2a_5x - 3a_6x^2 - a_8y - a_9y^2 \quad (IV-5)$$

Confidential

Evaluation of Eqs. IV-3, 4 and 5 at the corner points yields:

$$\begin{pmatrix} a_1 \\ a_2 \\ a_3 \\ a_4 \\ a_5 \\ a_6 \\ a_7 \\ a_8 \\ a_9 \end{pmatrix} = \begin{bmatrix} 0 & 0 & 0 & 1 & 0 & 0 & 0 & 0 & 0 \\ 0 & 0 & 2y_2 & 1 & 0 & 0 & 2y_2 & 0 & 0 \\ 0 & 0 & 2y_3 & 1 & 0 & 0 & 2y_3 & 0 & 0 \\ 0 & -1 & 0 & 0 & 0 & 0 & -1 & 0 & 0 \\ 0 & -1 & 0 & 0 & -2x_2 & -3x_2^2 & -1 & -2x_2 & -y_2^2 \\ 0 & -1 & 0 & 0 & -2x_3 & -3x_3^2 & -1 & -2x_3 & -y_3^2 \\ 1 & 0 & 0 & 0 & 0 & 0 & 0 & 0 & 0 \\ 1 & x_2 & y_2^2 & y_2 & x_2^2 & x_2^3 & x_2 & x_2^2 & x_2 y_2^2 \\ 1 & x_3 & y_3^2 & y_3 & x_3^2 & x_3^3 & x_3 & x_3^2 & x_3 y_3^2 \end{bmatrix}$$

(IV-6)

Contrails

The square matrix on the right hand side of Eq. IV-6 is, by definition, the [B] matrix.

To develop the [C_f] matrix, it is first necessary to express the flexural strain energy (U_f) for orthotropic plates, in terms of the displacements: (See Ref.12)

$$U_f = \frac{1}{2} \iint \left[D_x \left(\frac{\partial^2 w}{\partial x^2} \right)^2 + D_y \left(\frac{\partial^2 w}{\partial y^2} \right)^2 + (D_x \nu_{yx} + D_y \nu_{xy}) \left(\frac{\partial^2 w}{\partial x^2} \right) \left(\frac{\partial^2 w}{\partial y^2} \right) + 2D_{xy} \left(\frac{\partial^2 w}{\partial x \partial y} \right)^2 \right] dx dy \quad (IV-7)$$

where

$$D_x = \frac{E_x h^3}{12(1 - \nu_{xy} \nu_{yx})} \quad ; \quad D_y = \frac{E_y h^3}{12(1 - \nu_{xy} \nu_{yx})} \quad ;$$

$$D_{xy} = \frac{G_{xy} h^3}{6}$$

By the differentiation of Eq. IV-3 and the substitution of the partial derivatives into Eq. IV-7, the following expression for the strain energy in terms of the constants of the displacement function is obtained:

$$U_f = \frac{1}{2} \int_A \left[D_x (4a_5^2 + 24 a_5 a_6 x + 36 a_6^2 x^2) + D_y (4a_3^2 + 36 a_7^2 y^2 + 4a_7^2 x^2 + 24a_3 a_7 y + 24a_7 a_9 + 8a_3 a_9 x) + 2\nu_{yx} D_x (4a_3 a_5 + 12a_5 a_7 y + 4a_5 a_9 x + 12a_3 a_6 x + 36a_6 a_7 xy + 12a_6 a_9 x^2) + 2D_{xy} (a_8^2 + 4a_8 a_9 y + 4a_9^2 y^2) \right] dA \quad (IV-8)$$

Contrails

Next, the strain energy, Eq. IV-8, is differentiated with respect to each of the constants, a_1, \dots, a_9 . For example:

$$\frac{\partial U_f}{\partial a_1} = \frac{\partial U_f}{\partial a_2} = \frac{\partial U_f}{\partial a_4} = 0$$

while

$$\begin{aligned} \frac{\partial U_f}{\partial a_3} &= \frac{1}{2} D_y \int_A (8a_3 + 24a_7y + 8a_9x) dA \\ &\quad + \mu_{yx} D_x \int_A (4a_5 + 12a_6x) dA \\ &= 4D_y A a_3 + 12 D_y I_y a_7 + 4D_y I_x a_9 + 4 \mu_{yx} D_x A a_5 \\ &\quad + 12 \mu_{yx} D_x I_x a_6 \end{aligned} \tag{IV-9}$$

where $A = \int_A dA$; $I_y = \int_A y dA$; $I_x = \int_A x dA$

In matrix form, these partial derivatives can be stated as:

$$\begin{pmatrix} \frac{\partial U_f}{\partial a_1} \\ \cdot \\ \cdot \\ \cdot \\ \frac{\partial U_f}{\partial a_9} \end{pmatrix} = [C_f] \begin{pmatrix} a_1 \\ \cdot \\ \cdot \\ \cdot \\ a_9 \end{pmatrix} \tag{IV-10}$$

The $[C_f]$ matrix is shown on the following page.

The area, A , and the I_{xy}^{ij} terms in the $[C_f]$ matrix are discussed and defined in Section C - Geometric Properties.

$$[c_2] = \frac{E_x h^3}{12(1 - \nu_{xy} \nu_{yx})}$$

0										
0										
0	$4 \beta^{-1} A$									
0	0	0								
0	$4 \nu_{yx} A$	0	$4A$							
0	$12 \nu_{yx} I_x$	0	$12 I_x$	$36 I_x^2$						
0	$12 \beta^{-1} I_y$	0	$12 \nu_{yx} I_y$	$36 \nu_{yx} I_{xy}$	$36 \beta^{-1} I_y^2$					
0	0	0	0	0	0	$2 \gamma A$				
0	$4 \beta^{-1} I_x$	0	$4 \nu_{yx} I_x$	$12 \nu_{yx} I_x^2$	$12 \beta^{-1} I_{xy}$	$4 \gamma I_y$	$4 \beta^{-1} I_x^2$	$+ 8 \gamma I_y$		

(Symmetric)

Where: $\beta^{-1} = \frac{E_y}{E_x}$ $A = \iint dx \, dy$

$\gamma = \frac{2G_{xy}(1 - \nu_{xy} \nu_{yx})}{E_x}$ $I_{x^i y^j} = \iint x^i y^j \, dx \, dy$

VI. Development of Incremental Stiffness Matrix

The $[n]$ matrix can also be derived through application of Castigliano's First Theorem, Part I (See Reference 12). The procedure is represented by the relationship

$$[n] = [B^{-1}]^T [C_n] [B]^{-1} \quad (IV-11)$$

The strain energy expression to be employed in the formulation of the $[C_n]$ matrix is:

$$U_n = \frac{1}{2} \int_A \left[N_x \left(\frac{\partial w}{\partial x} \right)^2 + N_y \left(\frac{\partial w}{\partial y} \right)^2 + 2N_{xy} \frac{\partial w}{\partial x} \frac{\partial w}{\partial y} \right] dA \quad (IV-12)$$

Where N_x , N_y and N_{xy} are the known midplane forces, these forces will have been evaluated by performance of an independent midplane displacement analysis, wherein the element is assumed to sustain constant midplane stresses ($\sigma_x = a_1$, $\sigma_y = a_2$, $\tau_{xy} = a_3$). Since $N_x = h\sigma_x$, $N_y = h\sigma_y$ and $N_{xy} = h\tau_{xy}$, the midplane forces are also constant by taking note of this consideration, utilizing the displacement function of Eq. IV-2, and performing the operations indicated by Eq. IV-12, one obtained:

$$U_n = U_{n_x} + U_{n_y} + U_{n_{xy}}$$

$$U_{n_x} = \frac{1}{2} \int_A N_x \left(\frac{\partial w}{\partial x} \right)^2 dA = \frac{N_x}{2} \left[Aa_2^2 + 4I_x a_2 a_5 + 6I_x^2 a_2 a_6 \right. \\ + 2I_y a_2 a_8 + 2I_y^2 a_2 a_9 + 4I_x^2 a_5^2 + 12I_x^3 a_5 a_6 + 4I_{xy} a_5 a_8 \\ + 4I_{xy}^2 a_5 a_9 + 9I_x^4 a_6^2 + 6I_x^2 a_6 a_8 + 6I_x^2 a_6 a_9 + I_y^2 a_8^2 \\ \left. + 2I_y^3 a_8 a_9 + I_y^4 a_9^2 \right] \quad (IV-13a)$$

Contrails

$$\begin{aligned}
 U_{n_y} = \frac{1}{2} \int_A N_y \left(\frac{\partial w}{\partial y} \right)^2 dA = \frac{N_y}{2} & \left[4I_y^2 a_3^2 + 4I_y a_3 a_4 + 12I_y^3 a_3 a_7 \right. \\
 & + 4I_{xy} a_3 a_8 + 8I_{xy}^2 a_3 a_9 + Aa_4^2 - 6I_y^2 a_4 a_7 + 2I_x a_4 a_8 \\
 & + 4I_{xy} a_4 a_9 + 9I_{y4} a_7^2 + 6I_{xy}^2 a_7 a_8 + 12I_{xy}^3 a_7 a_9 + I_x^2 a_8^2 \\
 & \left. + 4I_x^2 a_8 a_9 + 4I_x^2 a_9^2 \right] \quad (IV-13b)
 \end{aligned}$$

$$\begin{aligned}
 U_{n_{xy}} = \int N_{xy} \frac{\partial w}{\partial x} \frac{\partial w}{\partial y} dA = N_{xy} & \left[2I_y a_2 a_3 + 4I_{xy} a_3 a_5 + 6I_x^2 a_3 a_6 \right. \\
 & + 2I_y^2 a_3 a_8 + 2I_y^3 a_3 a_9 + Aa_2 a_4 + 2I_x a_4 a_5 + 3I_x^2 a_4 a_6 \\
 & + I_y a_4 a_8 + I_y^2 a_4 a_9 + 3I_y^2 a_2 a_7 + 6I_{xy}^2 a_5 a_7 + 9I_x^2 a_6 a_7 \\
 & + 3I_y^3 a_7 a_8 + 3I_y^4 a_7 a_9 + I_x a_2 a_8 + 2I_x^2 a_5 a_8 + 3I_x^3 a_6 a_8 \\
 & + I_{xy} a_8^2 + 2I_{xy} a_2 a_9 + 4I_x^2 a_5 a_9 + 6I_x^3 a_6 a_9 + 3I_{xy}^2 a_8 a_9 \\
 & \left. + 2I_{xy}^3 a_9^2 \right] \quad (IV-13c)
 \end{aligned}$$

Considering each of the energy components separately, the partial derivatives of the energy with respect to the constants may be stated as follows:

$$\left\{ \begin{array}{c} \frac{\partial U_{n_x}}{\partial a_1} \\ \vdots \\ \frac{\partial U_{n_x}}{\partial a_9} \end{array} \right\} = [C_{n_x}] \left\{ \begin{array}{c} a_1 \\ \vdots \\ a_9 \end{array} \right\} \quad (IV-14a)$$

$$\left\{ \begin{array}{c} \frac{\partial U_{n_y}}{\partial a_1} \\ \vdots \\ \frac{\partial U_{n_y}}{\partial a_9} \end{array} \right\} = [C_{n_y}] \left\{ \begin{array}{c} a_1 \\ \vdots \\ a_9 \end{array} \right\} \quad (IV-14b)$$

Contrails

$$\left\{ \begin{array}{c} \frac{\partial U_{n_{xy}}}{\partial a_1} \\ \cdot \\ \cdot \\ \cdot \\ \frac{\partial U_{n_{xy}}}{\partial a_9} \end{array} \right\} = [C_{n_{xy}}] \left\{ \begin{array}{c} a_1 \\ \cdot \\ \cdot \\ \cdot \\ a_9 \end{array} \right\} \quad (\text{IV-14c})$$

The three $[C_n]$ matrices are shown on the following pages. The $I_{x y}^{i j}$ terms appearing in these matrices are defined in the following section - Geometric Properties.

The $[C_n]$ matrix in Eq. IV-16 equals the sum of the three $[C_n]$ matrices of Eqs. IV-14a, 14b and 14c. Hence, the incremental stiffness matrix $[n]$ is expressed as:

$$[n] = [B^{-1}]^T \left([C_{n_x}] + [C_{n_y}] + [C_{n_{xy}}] \right) [B]^{-1} \quad (\text{IV-11a})$$

VII. Geometric Properties

The $[C_f]$ and $[C_n]$ matrices contain a group of $I_{x^i y^j}$ terms resulting from integration of the energy expressions. These terms are defined as:

$$I_{x^i y^j} = \iint x^i y^j \, dx \, dy = \int_A x^i y^j \, dA \quad (\text{IV-15})$$

Thus, they are simply geometric properties of the element. Many of them are well known section properties.

In explicitly formulating the $I_{x^i y^j}$ terms it was convenient to use previously determined $I_{\eta^i \xi^j}$ terms with reference to the η - ξ coordinates, as shown in the following sketch, and transform these to the x-y system.

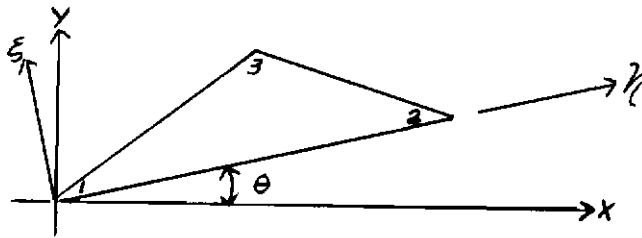

The coordinate transformation from the x-y system into the η - ξ coordinates for any given point is

$$\begin{Bmatrix} \eta \\ \xi \end{Bmatrix} = \begin{bmatrix} \cos \theta & \sin \theta \\ -\sin \theta & \cos \theta \end{bmatrix} \begin{Bmatrix} x \\ y \end{Bmatrix} \quad (\text{IV-16})$$

where $\sin \theta = \frac{y_2}{\sqrt{x_2^2 + y_2^2}}$; $\cos \theta = \frac{x_2}{\sqrt{x_2^2 + y_2^2}}$

Alternatively the coordinate transformation from the η - ξ system to the x-y system is given by

$$\begin{Bmatrix} x \\ y \end{Bmatrix} = \begin{bmatrix} \cos \theta & -\sin \theta \\ \sin \theta & \cos \theta \end{bmatrix} \begin{Bmatrix} \eta \\ \xi \end{Bmatrix} \quad (\text{IV-16a})$$

Contrails

As an example of the determination of the $I_{x y}^{i j}$'s in terms of the $I_{\eta \xi}^{i j}$'s consider the first moment of the area about the y axis, I_x . For this moment

$$\begin{aligned} I_x &= \int_A x \, dA \\ &= \int (\eta \cos \theta - \xi \sin \theta) \, dA \\ &= \cos \theta \int \eta \, dA - \sin \theta \int \xi \, dA \\ &= I_{\eta} \cos \theta - I_{\xi} \sin \theta \end{aligned} \tag{IV-17}$$

All the remaining $I_{x y}^{i j}$'s are determined by a similar procedure. A listing of the necessary $I_{x y}^{i j}$'s is given on Fig. III-13.

The area, A , and moment properties about the η and ξ axes were determined by direct integration within the proper limits to yield the expressions shown on Fig. III-14.

VIII. Development of Corner Thermal Moments

Reference 14 has established a procedure for the derivation of thermal forces that is consistent with the procedures employed in deriving the $[K_f]$ and $[n]$ matrices, i.e., a procedure based on Castigliano's First Theorem. It is simpler and appears equally accurate, however, to derive the thermal forces by means of the scheme to be described in the following.

In developing the corner thermal moments, the average distributed thermal moments $M_x^{\alpha'}$ (about the x axis) and $M_y^{\alpha'}$ (about the y axis) are taken as constant throughout the element. The "lumped" corner thermal moments are based upon these average moments. The average moments are defined as the arithmetic average of the distributed moments at the three corners of the triangular element. Thus

$$M_x^{\alpha'} = \frac{M_{x1}^{\alpha'} + M_{x2}^{\alpha'} + M_{x3}^{\alpha'}}{3} \quad (IV-18)$$

and

$$M_y^{\alpha'} = \frac{M_{y1}^{\alpha'} + M_{y2}^{\alpha'} + M_{y3}^{\alpha'}}{3}$$

where $M_{x1}^{\alpha'}$ and $M_{y1}^{\alpha'}$ are the distributed moments at the corners due to the temperature gradient, through the thickness of the plate. These distributed corner moments are defined as:

$$M_{x1}^{\alpha'} = \frac{E_y (1 + \mu_{xy})}{(1 - \mu_{xy} \mu_{yx})} \int_{-\frac{h}{2}}^{\frac{h}{2}} \alpha T \xi d \xi$$

$$M_{y1}^{\alpha'} = \frac{E_x (1 + \mu_{yx})}{(1 - \mu_{xy} \mu_{yx})} \int_{-\frac{h}{2}}^{\frac{h}{2}} \alpha T \xi d \xi \quad (IV-19)$$

ξ is a thickness coordinate measured positively in the positive z direction from the neutral axis of the plate.

It is assumed that the average thermal moments are distributed around the edges of an arbitrary triangle as shown below:

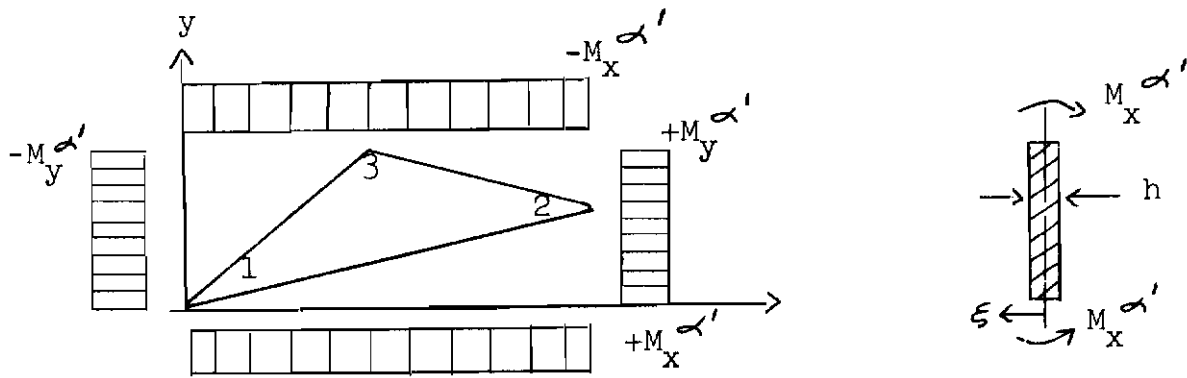

The distributed thermal moments are concentrated at the corners of the triangle by assigning one half of the total moment along a side to each of the corners bounding the side. For example:

$$\bar{M}_{x_1}^{\alpha'} = M_x^{\alpha'} \frac{x_2}{2} - M_x^{\alpha'} \frac{x_3}{2} = \frac{1}{2} M_x^{\alpha'} (x_2 - x_3) \quad (\text{IV-20})$$

$$\text{and } \bar{M}_{y_1}^{\alpha'} = M_y^{\alpha'} \frac{y_3}{2} + M_y^{\alpha'} \frac{y_2}{2} = \frac{1}{2} M_y^{\alpha'} (y_2 - y_3)$$

The thermal corner forces F_z^{α} are zero so that the thermal moments and forces are expressed in matrix notation by

$$\begin{Bmatrix} \bar{M}_{x_1}^{\alpha'} \\ \bar{M}_{x_2}^{\alpha'} \\ \bar{M}_{x_3}^{\alpha'} \\ \bar{M}_{y_1}^{\alpha'} \\ \bar{M}_{y_2}^{\alpha'} \\ \bar{M}_{y_3}^{\alpha'} \\ F_{z_1}^{\alpha'} \\ F_{z_2}^{\alpha'} \\ F_{z_3}^{\alpha'} \end{Bmatrix} = \frac{1}{2} \begin{Bmatrix} M_x^{\alpha'} (x_2 - x_3) \\ M_x^{\alpha'} x_3 \\ -M_x^{\alpha'} x_2 \\ M_y^{\alpha'} (y_2 - y_3) \\ M_y^{\alpha'} y_3 \\ -M_y^{\alpha'} y_2 \\ 0 \\ 0 \\ 0 \end{Bmatrix} \quad (\text{IV-21})$$

Contrails

IX. Development of Stress Resultant Bending and Twisting Moments and Vertical Shear Forces

It appears most efficient, from the standpoint of practical interpretation, to express the "stresses" as moments and shears per unit length. Hence, the bending moments, M_x and M_y , the twisting moment M_{xy} , and the shear forces, Q_x and Q_y , shown in the sketch can each be calculated during an analysis. They are to be computed at the centroid of the element. The stresses, which are dependent upon the construction details of the cross-section, can then be hand calculated from the moments and shear forces.

The moments and forces may be expressed in terms of the deflected surface, as:

$$\begin{aligned}
 M_x' &= -D_y \left(\frac{\partial^2 w}{\partial y^2} + \mu_{xy} \frac{\partial^2 w}{\partial x^2} \right) \\
 M_y' &= -D_x \left(\frac{\partial^2 w}{\partial x^2} + \mu_{yx} \frac{\partial^2 w}{\partial y^2} \right) \\
 M_{xy}' &= D_{xy} \frac{\partial^2 w}{\partial x \partial y} = -M_{yx}' \quad (IV-22) \\
 Q_x &= -\frac{\partial}{\partial x} \left(D_x \frac{\partial^2 w}{\partial x^2} + D_Q \frac{\partial^2 w}{\partial y^2} \right) \\
 Q_y &= -\frac{\partial}{\partial y} \left(D_Q \frac{\partial^2 w}{\partial x^2} + D_y \frac{\partial^2 w}{\partial y^2} \right)
 \end{aligned}$$

where D_x , D_y and D_{xy} are defined below Eq. IV-7 and

$$D_Q = D_x \mu_{yx} + D_{xy}$$

By differentiating the assumed displacement function (Eq. IV-3), the following derivatives are obtained

$$\begin{aligned}
 \frac{\partial^2 w}{\partial x^2} &= 2a_5 + 6a_6 x \\
 \frac{\partial^2 w}{\partial y^2} &= 2a_3 + 6a_7 y + 2a_9 x \\
 \frac{\partial^2 w}{\partial x \partial y} &= a_8 + 2a_9 y
 \end{aligned} \quad (IV-23)$$

Contrails

Substituting Eqs. IV-23 into Eqs. IV-22 and evaluating the expressions at the centroidal coordinates (\bar{x}, \bar{y}) , yields the following matrix equation for the moments and forces:

$$\begin{Bmatrix} M'_x \\ M'_y \\ M'_{xy} \\ Q_x \\ Q_y \end{Bmatrix} = [g_z] \begin{Bmatrix} a_1 \\ a_2 \\ \cdot \\ \cdot \\ a_9 \end{Bmatrix} \quad (\text{IV-24})$$

where:

$$[g_z] = - \begin{bmatrix} 0 & 0 & 2D_y & 0 & 2\mu_{xy}D_y & 6\mu_{xy}D_y\bar{x} & 6D_y\bar{y} & 0 & 2D_y\bar{x} \\ 0 & 0 & 2\mu_{yx}D_x & 0 & 2D_x & 6D_x\bar{x} & 6\mu_{yx}D_x\bar{y} & 0 & 2\mu_{yx}D_x\bar{x} \\ 0 & 0 & 0 & 0 & 0 & 0 & 0 & -D_{xy} & -2D_{xy}\bar{y} \\ 0 & 0 & 0 & 0 & 0 & 6D_x & 0 & 0 & 2D_Q \\ 0 & 0 & 0 & 0 & 0 & 0 & 6D_y & 0 & 0 \end{bmatrix}$$

and

$$\bar{x} = \frac{1}{3} (x_2 + x_3)$$

$$\bar{y} = \frac{1}{3} (y_2 + y_3)$$

From Eq. IV-6 it is noted that:

$$\begin{Bmatrix} a_1 \\ \cdot \\ \cdot \\ \cdot \\ \cdot \\ \cdot \\ a_9 \end{Bmatrix} = [B]^{-1} \begin{Bmatrix} \theta_{x1} \\ \theta_{x2} \\ \theta_{x3} \\ \theta_{y1} \\ \theta_{y2} \\ \theta_{y3} \\ w_1 \\ w_2 \\ w_3 \end{Bmatrix} \quad (\text{IV-6a})$$

so that Eq. IV-24 may be written as

$$\begin{Bmatrix} M'_x \\ M'_y \\ M'_{xy} \\ Q_x \\ Q_y \end{Bmatrix} = [g_z] [B]^{-1} \begin{Bmatrix} \theta_{x_1} \\ \theta_{x_2} \\ \theta_{x_3} \\ \theta_{y_1} \\ \theta_{y_2} \\ \theta_{y_3} \\ w_1 \\ w_2 \\ w_3 \end{Bmatrix} \tag{IV-24a}$$

which permits the moments and forces to be calculated from the previously computed displacements. To account for the presence of thermal moments, Eq. IV-24a is modified as follows:

$$\begin{Bmatrix} M'_x \\ M'_y \\ M'_{xy} \\ Q_x \\ Q_y \end{Bmatrix} = [S_z] \begin{Bmatrix} \theta_{x_1} \\ \theta_{x_2} \\ \theta_{x_3} \\ \theta_{y_1} \\ \theta_{y_2} \\ \theta_{y_3} \\ w_1 \\ w_2 \\ w_3 \end{Bmatrix} - \{S_z^\alpha\} \tag{IV-25}$$

Contrails

Where $[S_z] = [g_z] [B]^{-1}$ and $\{S_z^\alpha\}$ the column of thermal moments and forces, is given by:

$$\{S_z^\alpha\} = \begin{Bmatrix} M_x^{\alpha'} \\ M_y^{\alpha'} \\ 0 \\ 0 \\ 0 \end{Bmatrix} \quad (\text{IV-26})$$

In Eq. IV-26, $M_x^{\alpha'}$ and $M_y^{\alpha'}$ are the average distributed thermal moments defined by Equation IV-18.

Contrails

$$\begin{aligned}
 I_x &= I_\eta \cos \theta - I_\xi \sin \theta \\
 I_x^2 &= I_{\eta^2} \cos^2 \theta - 2 I_{\eta\xi} \cos \theta \sin \theta + I_{\xi^2} \sin^2 \theta \\
 I_x^3 &= I_{\eta^3} \cos^3 \theta - 3 I_{\eta^2\xi} \sin \theta \cos^2 \theta + 3 I_{\eta\xi^2} \sin^2 \theta \cos \theta \\
 &\quad - I_{\xi^3} \sin^3 \theta \\
 I_x^4 &= I_{\eta^4} \cos^4 \theta - 4 I_{\eta^3\xi} \sin \theta \cos^3 \theta + 6 I_{\eta^2\xi^2} \sin^2 \theta \cos^2 \theta \\
 &\quad - 4 I_{\eta\xi^3} \sin^3 \theta \cos \theta + I_{\xi^4} \sin^4 \theta \\
 I_y &= I_\eta \sin \theta + I_\xi \cos \theta \\
 I_y^2 &= I_{\eta^2} \sin^2 \theta + 2 I_{\eta\xi} \sin \theta \cos \theta + I_{\xi^2} \cos^2 \theta \\
 I_y^3 &= I_{\eta^3} \sin^3 \theta + 3 I_{\eta^2\xi} \sin^2 \theta \cos \theta + 3 I_{\eta\xi^2} \sin \theta \cos^2 \theta \\
 &\quad + I_{\xi^3} \cos^3 \theta \\
 I_y^4 &= I_{\eta^4} \sin^4 \theta + 4 I_{\eta^3\xi} \sin^3 \theta \cos \theta + 6 I_{\eta^2\xi^2} \sin^2 \theta \cos^2 \theta \\
 &\quad + 4 I_{\eta\xi^3} \sin \theta \cos^3 \theta + I_{\xi^4} \cos^4 \theta \\
 I_{xy} &= (I_{\eta^2} - I_{\xi^2}) \sin \theta \cos \theta + I_{\eta\xi} (\cos^2 \theta - \sin^2 \theta) \\
 I_{x^2y} &= I_{\eta^3} \sin \theta \cos^2 \theta + I_{\eta^2\xi} (\cos^3 \theta - 2 \sin^2 \theta \cos \theta) \\
 &\quad - I_{\eta\xi^2} (2 \sin \theta \cos^2 \theta - \sin^3 \theta) + I_{\xi^3} \sin^2 \theta \cos \theta \\
 I_{xy^2} &= I_{\eta^3} \sin^2 \theta \cos \theta + I_{\eta^2\xi} (2 \sin \theta \cos^2 \theta - \sin^3 \theta) \\
 &\quad + I_{\eta\xi^2} (\cos^3 \theta - 2 \sin^2 \theta \cos \theta) - I_{\xi^3} \sin \theta \cos^2 \theta
 \end{aligned}$$

FIGURE III-13 DEFINITION OF $I_{x^i y^j}$'s IN [C] MATRICES

Contrails

$$I_{x y}^2 = (I_{\eta 4} + I_{\xi 4}) \sin^2 \theta \cos^2 \theta + 2 (I_{\eta 3 \xi} - I_{\eta \xi 3}) (\sin \theta \cos^3 \theta - \sin^3 \theta \cos \theta) + I_{\eta^2 \xi^2} (\cos^4 \theta - 4 \sin^2 \theta \cos^2 \theta + \sin^4 \theta)$$

$$I_{x y}^3 = (I_{\eta 4} - 3I_{\eta^2 \xi^2}) \sin \theta \cos^3 \theta + 3 (I_{\eta \xi 3} - I_{\eta 3 \xi}) \sin^2 \theta \cos^2 \theta + (3 I_{\eta^2 \xi^2} - I_{\xi 4}) \sin^3 \theta \cos \theta - I_{\eta \xi 3} \sin^4 \theta + I_{\eta 3 \xi} \cos^4 \theta$$

$$I_{xy}^3 = (I_{\eta 4} - 3I_{\eta^2 \xi^2}) \sin^3 \theta \cos \theta + 3 (I_{\eta 3 \xi} - I_{\eta \xi 3}) \sin^2 \theta \cos^2 \theta + (3I_{\eta^2 \xi^2} - I_{\xi 4}) \sin \theta \cos^3 \theta - I_{\eta 3 \xi} \sin^4 \theta + I_{\eta \xi 3} \cos^4 \theta$$

FIGURE III-13 (CONTINUED)

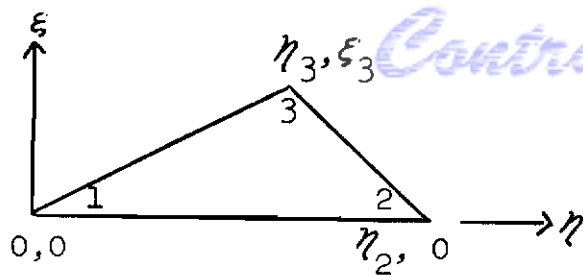

Contrails

$$I_{\eta^i \xi^j} = \iint \eta^i \xi^j \, d\eta \, d\xi$$

- $I_{\eta^0 \xi^0} = A = \frac{1}{2} \eta_2 \xi_3$
- $I_{\eta} = \frac{1}{6} \xi_3 \eta_2 (\eta_3 + \eta_2)$
- $I_{\eta^2} = \frac{1}{12} \xi_3 \eta_2 (\eta_3^2 + \eta_3 \eta_2 + \eta_2^2)$
- $I_{\eta^3} = \frac{1}{20} \xi_3 \eta_2 (\eta_3^3 + \eta_3^2 \eta_2 + \eta_3 \eta_2^2 + \eta_2^3)$
- $I_{\eta^4} = \frac{1}{30} \xi_3 \eta_2 (\eta_3^4 + \eta_3^3 \eta_2 + \eta_3^2 \eta_2^2 + \eta_3 \eta_2^3 + \eta_2^4)$
- $I_{\xi} = \frac{1}{6} \eta_2 \xi_3^2$
- $I_{\xi^2} = \frac{1}{12} \eta_2 \xi_3^3$
- $I_{\xi^3} = \frac{1}{20} \eta_2 \xi_3^4$
- $I_{\xi^4} = \frac{1}{30} \eta_2 \xi_3^5$
- $I_{\eta \xi} = \frac{\xi_3^2 \eta_2}{24} (2\eta_3 + \eta_2)$
- $I_{\eta^2 \xi} = \frac{\xi_3^2 \eta_2}{60} (3\eta_3^2 + 2\eta_3 \eta_2 + \eta_2^2)$
- $I_{\eta^3 \xi} = \frac{\xi_3^2 \eta_2}{120} (4\eta_3^3 + 3\eta_3^2 \eta_2 + 2\eta_3 \eta_2^2 + \eta_2^3)$
- $I_{\eta \xi^2} = \frac{\xi_3^3 \eta_2}{60} (3\eta_3 + \eta_2)$
- $I_{\eta^2 \xi^2} = \frac{\xi_3^3 \eta_2}{180} (6\eta_3^2 + 3\eta_3 \eta_2 + \eta_2^2)$
- $I_{\eta \xi^3} = \frac{\xi_3^4 \eta_2}{120} (4\eta_3 + \eta_2)$

FIGURE III-14 DEFINITION OF $I_{\eta^i \xi^j}$'s FOR TRIANGULAR ELEMENT

E. FRAME ELEMENT

I. Introduction

The formulation of the additional frame discrete element which has been incorporated into the MAGIC II System is essentially identical to that described in the original MAGIC Engineer's Manual (Reference 1). All element matrices available to the original frame element are available to this frame as well, i.e., Stiffness, Distributed Pressure, Thermal Load, and Consistent Mass.

The addition of this element is primarily intended to serve the purpose of providing a companion frame element to the quadrilateral and triangular plate elements which have been added to MAGIC II. The use of this element in conjunction with the newly added quadrilateral and triangular plate elements will provide a powerful capability for linear eigenvalue stability analyses of stiffened shell structures.

II. Additional Element Matrices

As pointed out previously, all element matrices available to the frame are described in detail in Reference 1. An additional incremental stiffness matrix has been provided and is presented here (References 14 and 15).

For the frame element (Fig. III-15) linear polynomial axial and torsional displacement mode shapes are constructed while a cubic polynomial displacement mode shape is constructed for flexure in each of the two principal planes of bending. The above mentioned mode shapes are assumed to take the following form:

Contrails

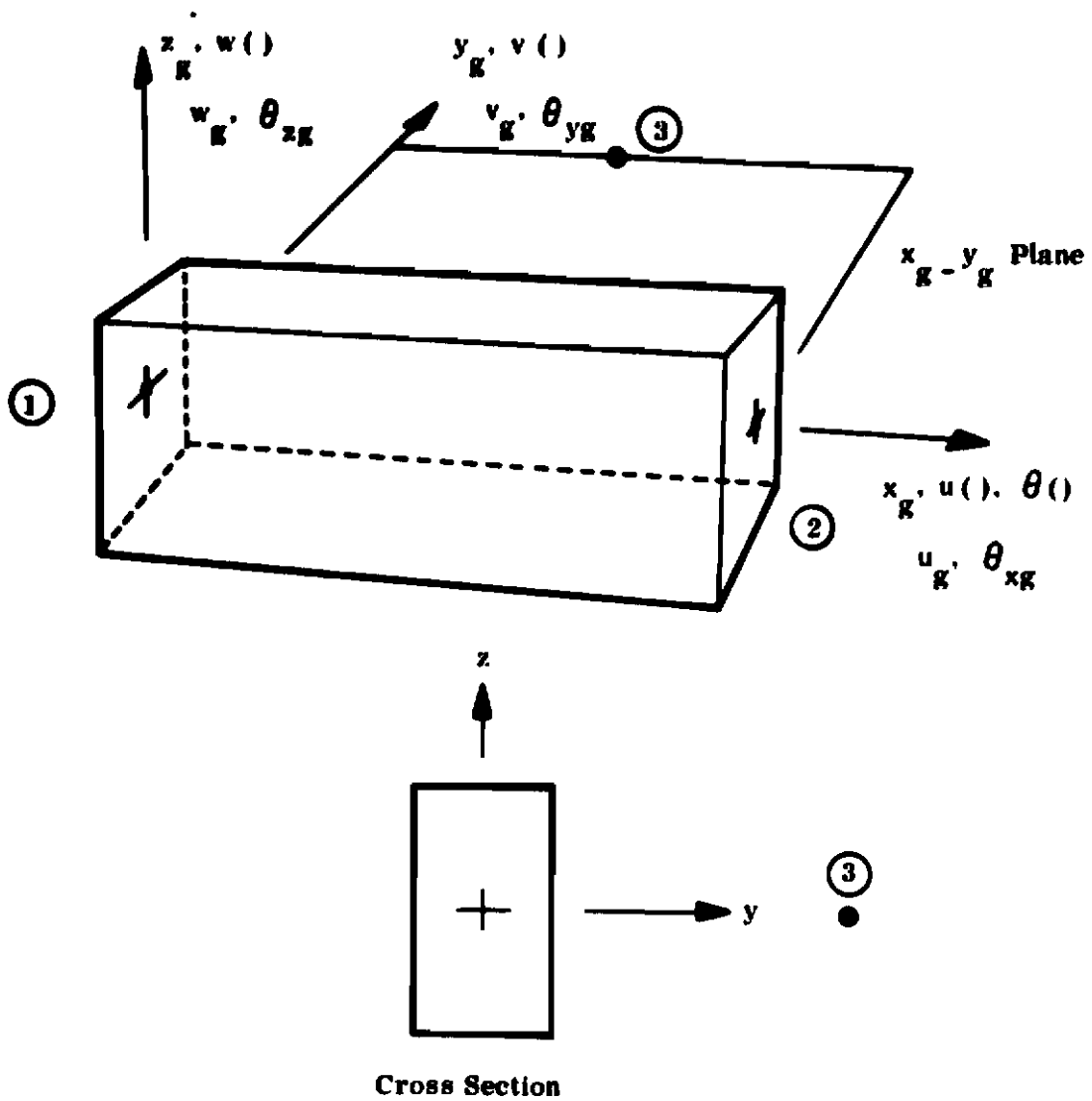

FIGURE III-15 FRAME ELEMENT REPRESENTATION

Contrails

$$u = a_0 + a_1 x \quad (2.1)$$

$$v = b_0 + b_1 x + b_2 x^2 + b_3 x^3 \quad (2.2)$$

$$w = c_0 + c_1 x + c_2 x^2 + c_3 x^3 \quad (2.3)$$

$$\theta = d_0 + d_1 x \quad (2.4)$$

The above mode shapes lead to a total of 12 undetermined coefficients for the element which are chosen to correspond to three translational and three rotational displacement degrees of freedom at each end of the element. A transformation from generalized coordinates to grid point displacement degrees of freedom is effected by writing (at $X = 0$)

$$\begin{aligned} u_1 &= a_0 \\ v_1 &= b_0 \\ w_1 &= c_0 \\ \theta_{x(1)} &= d_0 \\ \theta_{y(1)} &= -w_x \Big|_{x=0} = -c_1 \\ \theta_{z(1)} &= v_x \Big|_{x=0} = b_1 \end{aligned} \quad (2.5)$$

Contrails

and at $X = L$

$$\begin{aligned}u_2 &= a_0 + a_1 L \\v_2 &= b_0 + b_1 L + b_2 L^2 + b_3 L^3 \\w_2 &= c_0 + c_1 L + c_2 L^2 + c_3 L^3\end{aligned}\tag{2.6}$$

$$\theta_{x(2)} = d_0 + d_1 L$$

$$\theta_{y(2)} = w_x \Big|_{x=L} = -(c_1 + 2c_2 L + 3c_3 L^2)$$

$$\theta_{z(2)} = v_x \Big|_{x=L} = (b_1 + 2b_2 L + 3b_3 L^2)$$

or

$$\{\delta\} = [\Gamma_{\delta B}] \{B\}\tag{2.7}$$

where

$$\{\delta\}^T = [u_1, v_1, w_1, \theta_{x1}, \theta_{y1}, \theta_{z1}, u_2, v_2, w_2, \theta_{x2}, \theta_{y2}, \theta_{z2}]\tag{2.8}$$

and

$$\{B\}^T = [a_0, a_1, b_0, b_1, b_2, b_3, c_0, c_1, c_2, c_3, d_0, d_1]\tag{2.9}$$

It is to be noted that the $\{B\}$ are referred to as field coordinate displacement degrees of freedom.

Upon analytical inversion of equation (2.7) we have the desired relationship between the $\{B\}$ and $\{\delta\}$ displacement vectors.

$$\{B\} = [\Gamma_{B\delta}] \{\delta\}\tag{2.10}$$

Contrails

The strain-displacement relationships for the frame element can be written in the following form:

$$\epsilon = (u_x + 1/2 v_x^2 - yv_{xx} + 1/2 w_x^2 - zw_{xx}) \quad (2.11)$$

The total potential energy functional, \mathbb{I} , which arises in consequence of the strain relations of equation (2.11) is

$$\mathbb{I} = \int_0^L \left(\frac{EA}{2} u_x^2 + \frac{EI_z}{2} v_{xx}^2 + \frac{EI_y}{2} w_{xx}^2 \right) dx \quad (2.12)$$
$$+ \int_0^L \left[\frac{EA}{2} u_x (v_x^2 + w_x^2) + \frac{EA}{4} v_x^2 w_x^2 + \frac{EA}{8} (v_x^4 + w_x^4) \right] dx$$

The first integral in Equation (2.12) consists of the well known linear membrane and flexure terms respectively while the second integral arises from the retention of the quadratic terms in the strain-displacement relation.

In consideration of the non-linear portion of Equation (2.12) it is noted that the first term is the non-linear membrane-flexure coupling term. This contribution gives rise to terms which adversely affect the element linear membrane and flexure stiffness and is the term which will be considered.

If consideration is given to work done by midplane loads during the displacement of the structure during lateral loads, the following may be written for the first non-linear contribution of Equation (2.12)

$$\mathbb{I}' = - \frac{P_x}{2} \int_0^L (v_x^2 + w_x^2) dx \quad (2.13)$$

where P_x is the axial stress resultant which is a known quantity.

Contrails

From the assumed displacement functions (Equations 2.2 and 2.3) differentiate and obtain:

$$\left. \begin{aligned} v_x &= b_1 + 2b_2x + 3b_3x^2 \\ w_x &= c_1 + 2c_2x + 3c_3x^2 \end{aligned} \right\} \quad (2.14)$$

substitution into Equation (2.13) and integrating obtain:

$$\bar{I}' = -\frac{P_x}{2} \left\{ \begin{aligned} &b_1^2 L + 2b_1 b_2 L^2 + 2b_1 b_3 L^3 + 4/3 b_2^2 L^3 \\ &+ 3b_2 b_3 L^4 + 9/5 b_3^2 L^5 + c_1^2 L + 2c_1 c_2 L^2 \\ &+ 2c_1 c_3 L^3 + 4/3 c_2^2 L^3 + 3c_2 c_3 L^4 + \\ &9/5 c_3^2 L^5 \end{aligned} \right\} \quad (2.15)$$

Upon taking the partial derivatives of \bar{I}' with respect to the coefficients b_1 thru b_3 and c_1 thru c_3 , the incremental stiffness matrix $[\tilde{N}]$ is obtained referenced to field coordinate displacement degrees of freedom and is shown in Equation (2.16).

Contrails

Noting from Equation (2.10) that $\{B\} = [V_{\beta\delta}] \{\delta\}$

$[N1]$ is obtained as follows:

$$[N1] = [V_{\beta\delta}]^T [\tilde{N}^{(1)}] [V_{\beta\delta}] \quad (2.17)$$

when $[N1]$ is referenced to grid point displacement degrees of freedom.

SECTION IV COMPUTATIONAL PROCEDURES

A. Introduction

The MAGIC II System for Structural Analysis offers a variety of computational procedures to the User. Among these are the capability to perform static analyses, statics with condensation, statics with prescribed displacements, stability, dynamics (modes and frequencies) and dynamics with condensation. The proper usage of these procedures in the context of performing actual structural analyses is described in detail in Volume II of this document (The User's Manual).

In addition, the powerful matrix abstraction capability built into the MAGIC II System allows analyses to be performed which require the use of Static and Dynamic Substructuring. In order to clarify the operations involved utilizing these approaches, a detailed presentation follows.

B. Static Substructuring

A primary attraction of the matrix methods of structural analysis is that many significant problems can be solved with very modest computer programs. In the simplest case, a capability to generate and assemble a certain type of element stiffness matrix and solve the resulting system stiffness equation is sufficient. On the other hand, the automated analysis systems required to cope with the large classes of structures in a practical design situation bear little relation to the type of finite element computer program mentioned above. Practical analysis tools must be implemented as an integral part of the overall structural analysis and design cycle.

Contrails

It is apparent from the size and complexity of many structures that a great deal of data is involved. The detailed design specification of the structure is spread over numerous drawings and through many documents. A realistic physical model necessitates thousands of gridpoints and finite elements. Translated into computer program input, related data items include coordinates of all gridpoints, degree-of-freedom specifications of all gridpoints, connection specifications for all finite elements, etc. This volume of input data implies a need for many hours of computer time for numerical solution. Finally, extensive output inevitably results from such an analysis.

Effective management of the voluminous data associated with structures of this type is usually the decisive consideration in establishing the basic analysis process. For these reasons an analysis can be undertaken by substructuring (References 16, 17). In general, the substructuring process proceeds in four major phases as outlined below.

Phase I is concerned with the individual substructures of the total Structure. In the Phase I analysis, each substructure is considered individually. Input data is prepared and calculation is carried forward to determine matrix representations referenced to the substructure interfaces.

Phase II considers the structure as a whole. The interface stiffness matrices for the individual substructures are assembled and the complete set of interface displacements is determined.

Based upon interface displacements obtained from Phase II and auxiliary information from the individual Phase I analysis, Phase III completes the conventional finite element analysis. Each substructure is considered in turn. Prediction of the primary displacement variables is completed and secondary variables such as forces and stresses are calculated.

Contrails

Phase IV is a nonintegral step designed to translate the conventional Phase III results into a form desired by the stress analyst for the determination of margins of safety.

1. Phase I

The matrix algebra of the Phase I analysis is deceptively straight forward when reduced to the essential calculations relevant to the primary displacement variables and stripped of the problematical data storage and retrieval steps inherent in the computer program. The simplified symbolic statement of the process is considered appropriate in the present context. Accepting this viewpoint, the first step of the Phase I analysis process yields potential energy expressions for the individual finite elements given by,

$$\phi_{pe} = \frac{1}{2} [\delta_e] [K_e] \{\delta_e\} - [\delta_e] \{F_e\} \quad (2-1)$$

where

$[K_e]$ is the element stiffness matrix,
 $\{\delta_e\}$ is the relevant gridpoint displacement vector, and
 $\{F_e\}$ is the element total applied load vector.

These individual element potential energies are then assembled to form a potential energy expression for the substructure under consideration.

$$\phi_p = \frac{1}{2} [L\delta] [K] \{\delta\} - [L\delta] \{F\} \quad (2-2)$$

where

$[K]$ is the substructure stiffness matrix,
 $\{\delta\}$ is the substructure displacement vector, and
 $\{F\}$ is the total substructure applied load.

Contrails

The Phase I analysis is carried forward by rewriting the substructure potential energy in partitioned form to reflect the division between interior gridpoint degrees-of-freedom $\{\delta_i\}$ and interface (boundary) gridpoint degrees-of-freedom $\{\delta_b\}$ i.e.,

$$\phi_p = \frac{1}{2} \begin{bmatrix} \delta_i & \delta_b \end{bmatrix} \begin{bmatrix} K_{ii} & K_{ib} \\ K_{ib}^T & K_{bb} \end{bmatrix} \begin{Bmatrix} \delta_i \\ \delta_b \end{Bmatrix} - \begin{bmatrix} \delta_i & \delta_b \end{bmatrix} \begin{Bmatrix} F_i \\ F_b \end{Bmatrix} \quad (2-3)$$

Contributions to the potential energy which stem from the interior gridpoints are complete while additional contributions will be added in at the interface gridpoints upon assembly of the substructures. Advantage is taken of the completeness at the interior points by solving for these displacements degrees-of-freedom in terms of the interface degrees-of-freedom. The result is given by,

$$\{\delta_i\} = [K_{ii}]^{-1} \{F_i\} - [K_{ii}]^{-1} [K_{ib}] \{\delta_b\} \quad (2-4)$$

Backsubstitution of this relation into Equation 2-3 yields the objective substructure potential energy expression referenced in interface degrees-of-freedom, i.e.

$$\phi_{pb} = \frac{1}{2} [\delta_b] [K_b] \{\delta_b\} - [\delta_b] \{P_b\} \quad (2-5)$$

where

$$[K_b] = [K_{bb} - K_{ib}^T K_{ii}^{-1} K_{ib}] \quad (2-6)$$

$$\{P_b\} = \{F_b\} - \{K_{ib}^T K_{ii}^{-1} F_i\} \quad (2-7)$$

$[K_b]$ is the substructure interface stiffness matrix,
 $\{\delta_b\}$ is the substructure interface displacement vector, and
 $\{P_b\}$ is the substructure interface load vector.

Contrails

The individual substructure potential energy expressions of the form defined in Equation 2-5 are the basic Phase I analysis results required to construct the governing stiffness equation for the entire structure in the Phase II analysis process.

The foregoing statement of the Phase I analysis process actually implies a complete general purpose computer program for stress analysis plus the capability to form and store such items as interface stiffness matrices on magnetic tape for subsequent access. It is instructive to take the viewpoint of the structural analyst and re-examine the Phase I analysis process as an application of the MAGIC II Structural Analysis System.

By definition, Phase I proceeds against a number of substructures of the total structure although inclusion of the complete structure within a single substructure would yield a conventional one-pass linear stress analysis. The reasons for division of a structure into multiple substructures are many and varied. Unnecessary breakdown into substructures is, of course, inefficient.

A primary reason for substructuring stems from the fact that it is efficient to confirm a large quantity of input data via subsets. With substructuring, an analyst can focus his attention upon a limited region or component in specifying input data. This subset of data can then be processed through data checking executions. Such executions involve only the relatively small quantities of data of current interest with the result that turn-around is rapid and inexpensive.

Substructuring can also shorten the calendar time required to confirm the input data for a large structure. The reason for this is that substructuring facilitates distribution of the input data specification effort to a number of analysts for nearly independent simultaneous preparation. It is worth mentioning that the automatic generation of structural plots from the input data is an important aid to the confirmation of input. Plots of the structural components taken individually are desirable.

Contrails

The benefits of substructuring large scale structures extend beyond the input data confirmation stage through execution. The effective matrix banding may be improved by substructuring. Long continuous executions are avoided. Numerous restart points are automatically provided. Most important, the Phase I executions are spread over the period of time required to complete the specification of data for all the component substructures. Executions in the succeeding phases may be similarly spread to generate results paced by progress in evaluation.

Substructuring is particularly advantageous when localized modifications in structure or applied loading arise subsequent to the analysis. Such modifications can often be accommodated by re-analysis of only those substructures affected.

Having discussed the motivation for and the scope of the Phase I analysis, the following paragraphs focus upon the several steps involved. Preprinted input forms are employed to simplify the specification of input data. These forms are designed to provide automatic internal generation of data whenever possible. For example, repetitious data need only to be specified initially followed by any exceptions. (See Volume II - User's Manual).

The first executions of the MAGIC II Analysis System are undertaken to confirm the input data deck as discussed earlier. The deck is read and the implied data is generated explicitly. Consistency of the data is checked and all data items are stored for execution restart and printed for further checking by the analyst. In addition, a magnetic tape is generated for automatic plotting of the finite element model.

Upon acceptance of the input data specification by the analyst, the actual Phase I analysis is undertaken for the substructure under consideration. This analysis is a complete linear stress analysis of the substructure under the assumption that the interface displacements are completely fixed. The output obtained from this analysis provides further important confirmation of the finite element model. Moreover, these results often provide useful preliminary information about substructure behavior.

Contrails

In addition to the preliminary stress analysis results, the Phase I analysis generates and stores the interface referenced stiffness and applied load matrices as well as the other information required in subsequent analysis phases.

2. Phase II

The Phase II analysis begins with the substructure interface matrices from Phase I and carries the analysis process through prediction of the interface displacement variables. Phase II is the only part of the analysis process which deals with more than one substructure at a time.

The substructure potential energy expressions (Equation 2-5) are the point of departure. Such an expression is known for each substructure, e.g.

$$\phi_{pb}^{(j)} = \frac{1}{2} [\delta^{(j)}] [K_b^{(j)}] \{\delta_b^{(j)}\} - [\delta_b^{(j)}] \{P_b^{(j)}\} \quad j=1,2, \dots, n \quad (2-8)$$

The interface displacements pertinent to each substructure $\{\delta_b^{(j)}\}$ are known as elements of the total list of interface displacements $\{\Delta\}$ for the assembled structure. This relationship is expressible mathematically by a Boolean transformation.

Symbolically,

$$\{\delta_b^{(j)}\} = [\Gamma_a^{(j)}] \{\Delta\} \quad (2-9)$$

Introduction of this transformation into the set of independent interface displacement degrees-of-freedom for the total structure yields

$$\phi_{pb}^{(j)} = \frac{1}{2} [\Delta] [K^{(j)}] \{\Delta\} - [\Delta] \{P^{(j)}\}, \quad j=1,2, \dots, n \quad (2-10)$$

where

$$[K^{(j)}] = [\Gamma_a^{(j)}]^T [K_b^{(j)}] [\Gamma_a^{(j)}] \quad (2-11)$$

$$\{P^{(j)}\} = [\Gamma_a^{(j)}]^T \{P_b^{(j)}\} \quad (2-12)$$

Contrails

The substructure interface potential energy expressions of the form of Equation 2-10 are added to obtain the complete potential energy for the structure, i.e.,

$$\phi_p = \frac{1}{2} [\Delta] [K] \{\Delta\} - [\Delta] \{P\} \quad (2-13)$$

where

$$[K] = \sum_j [K^{(j)}] \quad (2-14)$$

$$\{P\} = \sum_j \{P^{(j)}\} \quad (2-15)$$

The formality of transforming to conformable substructure matrices before assembly of the total structure matrices is avoided in actual practice. Instead, a nonconformable sum is effected to obtain Equation 2-13 directly from Equation 2-8.

The objective equation governing displacement of the interface points follows immediately by executing the variation of the potential energy expression of Equation 2-13. The result, retaining the symbolism of a single load condition, is given by,

$$[K] \{\Delta\} = \{P\} \quad (2-16)$$

The total interface matrix $[K]$ is a symmetric matrix which is stored in banded form. Solution is effected by triangularization of the matrix and back substitution for the set of interface displacement variables appropriate to each load condition.

3. Phase III

Phase III picks up the matrix descriptions of the individual substructures generated in Phase I and the solution for the interface displacements from Phase II and carries the analysis process forward. Firstly, the relevant interface displacements are extracted from the complete set (Equation 2-9). Then, the interior displacements are calculated using Equation 2-4, i.e.,

$$\{\delta_i\} = [K_{ii}]^{-1}\{F_i\} - [K_{ii}]^{-1}[K_{ib}]\{\delta_b\} \quad (2-17)$$

With this result all the primary variables for a given substructure are known and various secondary items are computed. For example, stresses are available for each finite element in the substructure via a relation of the form

$$\{\sigma\} = [S]\{\delta\} - \{\omega\} \quad (2-18)$$

where

- $\{\sigma\}$ is the element stress vector,
- $[S]$ is the element stress matrix, and
- $\{\omega\}$ is the thermal stress correction vector.

Many useful additional items are calculated in Phase III in the MAGIC II System. Included are: element forces, reactions and force balance. Even so, this information falls short of that desired for the margin of safety determinations. This gap between the conventional finite element stress analysis results and the information desired by the stress analyst necessitated the extension of the automated analysis process to include a Phase IV.

4. Phase IV

Phase III was set up to compute the normal finite element results for substructures specified by the stress analyst. These results are stored on magnetic tape as well as printed. This magnetic tape furnishes the primary input data for the Phase IV analysis. Phase IV is initiated either following Phase III or after examination of the printed results from Phase III at the discretion of the stress analyst.

The computations of Phase IV are designed to automatically reduce the predicted behavior data for evaluation by the stress analyst in terms of margins of safety. A typical computation of this automatic reduction process is the consideration of tensile yielding. This involves the interpolation of the allowable stress from the appropriate temperature referenced table on a magnetic tape file. Then, the equivalent stress is calculated from the actual multi-axial stress state. This equivalent stress state is interpreted via Von Mises yield criterion for comparison with the allowable stress. Comparison is made quantitatively in terms of a margin of safety. The results of this comparison are printed with explicit labelling and an asterisk (*) is employed to identify all negative margins of safety. At the present time, Phase IV is a non-integral part of the MAGIC II System.

This page *is* blank in printed copy

This page *is* blank in printed copy

This page *is* blank in printed copy

C. Dynamic Substructuring

The development of the concept of dynamic substructuring⁽¹⁸⁾, which includes means for reducing the number of degrees of freedom in a structural dynamics system, is presented in this section. Nine distinct phases ranging from discussion of finite element building blocks in Phase 1 to computation of system modes and frequencies in Phase 9 are defined.

The powerful matrix abstraction capability built into the MAGIC II System makes possible the employment of the computational procedure which is outlined below.

PHASE 1 - ENERGY FUNCTIONALS

The basic building blocks of the mathematical model for a complete structural system are taken to be the finite element energy functions. The potential energy functional for the continuum of an individual finite element is discretized by the construction of assumed modes in accord with the Ritz procedure⁽¹⁹⁾. Presuming an admissible assumed mode discretization of the k^{th} finite element of the form

$$\left\{ U_e^{(k)}(\cdot) \right\} = \left[B_e^{(k)}(\cdot) \right] \left\{ \delta_e^{(k)} \right\} \quad (1)$$

The resulting algebraic expressions for the element energy functions based on the concept of consistent matrices for stiffness $[K_e]$, applied loading $\{F_e\}$, damping $[D_e]$ and mass $[M_e]$ may be cast into matrix notation as follows:

a. Strain Energy

$$\Phi_U = \frac{1}{2} \left[\delta_e^{(k)} \right] \left[K_e^{(k)} \right] \left\{ \delta_e^{(k)} \right\} \quad (2)$$

b. External Work

$$\Phi_W^{(k)} = \left[\dot{\delta}_e^{(k)} \right] \left\{ F_e^{(k)} \right\} \quad (3)$$

c. Dissipation Energy

$$\Phi_V^{(k)} = \frac{1}{2} \left[\dot{\delta}_e^{(k)} \right] \left[D_{ve}^{(k)} \right] \left\{ \dot{\delta}_e^{(k)} \right\} \text{ (viscous damping)} \quad (4)$$

or

$$\Phi_S^{(k)} = \frac{i}{2} \left[\delta_e^{(k)} \right] \left[D_{se}^{(k)} \right] \left\{ \delta_e^{(k)} \right\} \text{ (structural damping)} \quad (5)$$

d. Kinetic Energy

$$\Phi_M^{(k)} = \frac{1}{2} \left[\dot{\delta}_e^{(k)} \right] \left[M_e^{(k)} \right] \left\{ \dot{\delta}_e^{(k)} \right\} \quad (6)$$

The equations governing dynamic response of a structural system are derivable from such energy functions via a generalized Lagrange equation⁽²⁰⁾. Total energy functions for the complete structural system are required in this formulative process. Given these, the objective matrix equation is readily obtained as

$$\left[M \right] \left\{ \ddot{\delta} \right\} + \left[D_v \right] \left\{ \dot{\delta} \right\} + \left[\left[K \right] + i \left[D_s \right] \right] \left\{ \delta \right\} = \left\{ F \right\} \quad (7)$$

Nine analysis phases trace the dynamic substructuring process from the basic finite element energy functions, through the construction of total energy functions for the complete structural system, to a governing matrix equation of the form of Equation 7, which is particularly well suited to dynamic response analyses.

Development toward the objective expressions of the several total energy functions for the complete structural system is carried forward in each of the subsequent analysis phases by the construction of a displacement coordinate transformation of the form

$$\left\{ \delta_l \right\} = \left\{ \tau_{l+1} \right\} + \left[\Gamma_{l+1} \right] \left\{ \delta_{l+1} \right\} \quad (8)$$

This transformation relation is employed to change the energy functions from expression in terms of the generalized coordinates $\{\delta_\ell\}$ to expression in terms of a new set of generalized coordinates $\{\delta_{\ell+1}\}$.

It is useful to illustrate the impact of such a transformation on a representative energy form before proceeding. Beginning from an energy expression given by

$$\Phi^{(\ell)} = \frac{1}{2} [\delta_\ell] [A_\ell] \{\delta_\ell\} \tag{9}$$

Introduction of a transformation of the form of Equation 8 yields

$$\left. \begin{aligned} \Phi^{(2)} &= \frac{1}{2} [\tau_{\ell+1}] [A_{\ell+1}] \{\tau_{\ell+1}\} && \text{(a)} \\ &+ \frac{1}{2} [\delta_{\ell+1}] [\Gamma_{\ell+1}]^T [A_\ell] [\Gamma_{\ell+1}] \{\delta_{\ell+1}\} && \text{(b)} \\ &+ [\delta_{\ell+1}] [\Gamma_{\ell+1}]^T [A_\ell] \{\tau_{\ell+1}\} && \text{(c)} \end{aligned} \right\} \tag{10}$$

The first term (a) in this result can be associated with the reference level of the energy and discarded. The second term (b) defines the modified nucleus matrix occasioned by the coordinate transformation. Finally, the third term (c) defines a generalized work contribution that arises out of the coordinate transformation. Only the second term is written explicitly in denoting such transformations in the text of subsequent analysis phases, i.e.

$$\Phi_{\ell+1} = \frac{1}{2} [\delta_{\ell+1}] [A_{\ell+1}] \{\delta_{\ell+1}\} \tag{11}$$

where

$$[A_{\ell+1}] = [\Gamma_{\ell+1}]^T [A_\ell] [\Gamma_{\ell+1}] \tag{12}$$

The change in reference level and the contribution to the work energy are assumed. The above explanation permits conciseness in subsequent steps without ambiguity.

PHASE 2 - FINITE ELEMENT ASSEMBLY SUBSTRUCTURE LEVEL

This portion of the analysis concerns the assembly of the individual finite element energy functions that comprise a typical substructure. The element gridpoint displacement degrees of freedom $\{\delta_e\}$ are assumed to be referenced to compatible reference axes. Under this assumption the displacement set for the j^{th} substructure $\{\delta_1^{(j)}\}$ is related to that of its k^{th} element $\{\delta_e^{(k)}\}$ through a Boolean transformation of the form

$$\{\delta_e^{(k)}\} = [\Gamma_1^{(k)}] \{\delta_1^{(j)}\}. \quad (13)$$

Introduction of this coordinate transformation into Equation 2 yields the k^{th} element strain energy with reference to the complete set of gridpoint displacement degrees of freedom for the j^{th} substructure, i.e.

$$\Phi_U = \frac{1}{2} [\delta_1^{(j)}] [\Gamma_1^{(k)}]^T [K_e^{(k)}] [\Gamma_1^{(k)}] \{\delta_1^{(j)}\}. \quad (14)$$

Summation over all of the finite elements yields the strain energy expression for the assembled substructure as

$$\Phi_U^{(j)} = \frac{1}{2} [\delta_1^{(j)}] [K^{(j)}] \{\delta_1^{(j)}\} \quad (15)$$

where

$$[K_1^{(j)}] = \sum_k [\Gamma_1^{(k)}]^T [K_e^{(k)}] [\Gamma_1^{(k)}]. \quad (16)$$

All of the substructure energy forms are derived similarly by introduction of the coordinate transformation of Equation 8. Explicit statement of the matrix algebra for each of the energy functions is omitted to avoid needless repetition.

The consistent structural mass matrix of the finite element model usually requires modification to incorporate nonstructural masses attached to the structure. Accordingly, provision is made in this Phase 2 analysis to check and augment the substructure consistent structural mass matrix.

Displacements that are prescribed as functions of time can be eliminated as degrees of freedom at this point and carried forward as generalized applied loads. The preparation for this elimination is to rearrange the set of gridpoint displacements to exclude displacements that are prescribed zero (fixed displacements) by setting corresponding matrix rows and columns to zero and position those prescribed nonzero $\{\delta_{1b}\}$ below the retained degrees of freedom $\{\delta_{1a}\}$. The conformably partitioned strain energy is given by

$$\Phi_U = \frac{1}{2} \begin{bmatrix} \{\delta_{1a}\} \\ \{\delta_{1b}\} \end{bmatrix} \begin{bmatrix} [K_{1aa}] & [K_{1ab}] \\ [K_{1ab}]^T & [K_{1bb}] \end{bmatrix} \begin{Bmatrix} \{\delta_{1a}\} \\ \{\delta_{1b}\} \end{Bmatrix} \quad (17)$$

The reduction occasioned by prescribed displacements is approached via the general transformation of Equation 8. In the interest of uniformity, we write

$$\{\delta_1\} = \{\gamma_2\} + [\Gamma_2] \{\delta_2\} \quad (18)$$

where

$$\{\delta_2\} = \{\delta_{1a}\} \quad (19)$$

$$[\Gamma_2] = \begin{bmatrix} [I] \\ [O] \end{bmatrix} \quad (20)$$

$$\{\gamma_2\} = \begin{Bmatrix} \{O\} \\ \{\delta_{1b}\} \end{Bmatrix}. \quad (21)$$

Substitution of this prescribed displacement transformation into the energy form of Equation 17 yields a modified quadratic form given by

$$\Phi_U = \frac{1}{2} \{\delta_2\} [K_2] \{\delta_2\} \quad (22)$$

where

$$[K_2] = [\Gamma_2]^T [K_1] [\Gamma_2] \equiv [K_{1aa}]. \quad (23)$$

The associated contribution to the work arises as

$$\Phi_W = [\delta_2] \{P_2\} \quad (24)$$

where

$$\{P_2\} = [\Gamma_2]^T [K_1] \{\gamma_2\} = [K_{1ab}] \{\delta_{1b}\}. \quad (25)$$

It should be noted that generality may be lost unnecessarily by invoking the prescribed displacement reduction at this point. Generally, only relatively small reduction in the order of the matrices of the problem is realized. It is best to defer such specializations of the model as long as possible to preserve its generality. The procedure outlined here to effect the prescribed displacement reduction is applicable at whatever stage the reduction is carried out.

PHASE 3 - CONDENSATION (SUBSTRUCTURE LEVEL)

This phase of the analysis process derives from the likelihood that the complete set of gridpoint displacement degrees of freedom $\{\delta_2\}$ are not essential to the objective structural dynamics analyses. For example, the gridpoints in the finite element model may have been dictated by the natural breakdown of the structure into components, or the intended use of the model for stress analyses.

The complete set of substructure gridpoint displacement degrees of freedom is partitioned to reflect the division into essential $\{\delta_{2a}\}$ and superfluous $\{\delta_{2b}\}$ subsets. All degrees of freedom that reside on interfaces with adjacent substructures must be regarded as essential to the proper interconnection of substructures. Partitioning of the displacement set implies a corresponding partitioning of the total potential energy from Phase 2 as

$$\Phi_P = \frac{1}{2} \left[\begin{array}{c} [\delta_{2a}] \\ [\delta_{2b}] \end{array} \right] \left[\begin{array}{c|c} [K_{2aa}] & [K_{2ab}] \\ \hline [K_{2ab}]^T & [K_{2bb}] \end{array} \right] \left\{ \begin{array}{c} \delta_{2a} \\ \delta_{2b} \end{array} \right\} \quad (26)$$

$$- \left[\begin{array}{c} [\delta_{2a}] \\ [\delta_{2b}] \end{array} \right] \left\{ \begin{array}{c} \{P_{2a}\} \\ \{P_{2b}\} \end{array} \right\}$$

By definition, the $\{\delta_{2b}\}$ are superfluous to the objective structural dynamics analyses. This being the case, they are condensed from the model via the static principle of potential energy⁽²¹⁾. This principle yields a matrix equation governing static behavior, i.e.

$$\begin{bmatrix} [K_{2aa}] & [K_{2ab}] \\ [K_{2ab}]^T & [K_{2bb}] \end{bmatrix} \begin{Bmatrix} \{\delta_{2a}\} \\ \{\delta_{2b}\} \end{Bmatrix} = \begin{Bmatrix} \{P_{2a}\} \\ \{P_{2b}\} \end{Bmatrix}. \quad (27)$$

Solution of this relation for the superfluous degrees of freedom in terms of the essential degrees of freedom produces a condensing transformation relation of the form

$$\{\delta_2\} = \{\gamma_3\} + [\Gamma_3] \{\delta_3\} \quad (28)$$

where

$$\{\delta_3\} = \{\delta_{2a}\} \quad (29)$$

and

$$[\Gamma_3] = \begin{bmatrix} [I] \\ -[K_{2bb}]^{-1} [K_{2ab}] \end{bmatrix} \quad (30)$$

$$\{\gamma_3\} = \begin{Bmatrix} \{O\} \\ [K_{2bb}]^{-1} \{P_{2b}\} \end{Bmatrix}. \quad (31)$$

Introducing the condensation transformation of Equation 28 into the energy functions furnished from the Phase 2 analysis references these functions to essential degrees of freedom. For example, application to the strain energy of Equation 22 yields

$$\Phi_U = \frac{1}{2} [\delta_3]^T [K_3] \{\delta_3\} \quad (32)$$

where

$$[K_3] = [\Gamma_3]^T [K_2] [\Gamma_3]. \quad (33)$$

The other energy functions are similarly transformed to complete the Phase 3 analysis. Generally, the order of the matrices can be substantially reduced by the introduction of this condensation transformation.

PHASE 4 - MODE SYNTHESIS

At the outset of this Phase 4 analysis the displacement at any point in the substructure is known in terms of the gridpoint displacement degrees of freedom $\{\delta_3\}$. These gridpoint displacement degrees-of-freedom arise naturally out of the finite element idealization technique rather than by choice as those most appropriate to structural dynamics analyses. Intuitively, the best substructure degrees-of-freedom for the objective analyses are those associated with the natural vibration mode shapes of the substructures. Transformation to such degrees-of-freedom is adopted as the immediate objective of this phase.

The transformation to substructure mode shape degrees-of-freedom is initiated by partitioning the gridpoint displacement degrees-of-freedom into a subset associated with the interface gridpoints $\{\delta_{3a}\}$ and a subset associated with the interior gridpoints $\{\delta_{3b}\}$ where the former are necessarily retained to effect the interconnection of adjacent substructures. This division into subsets yields a corresponding partitioning of the total potential energy, i.e.,

$$\Phi_U = \frac{1}{2} \left[\begin{array}{c} \delta_{3a} \\ \delta_{3b} \end{array} \right] \left[\begin{array}{c|c} [K_{3aa}] & [K_{3ab}] \\ \hline [K_{3ab}]^T & [K_{3bb}] \end{array} \right] \left\{ \begin{array}{c} \delta_{3a} \\ \delta_{3b} \end{array} \right\} - \left[\begin{array}{c} \delta_{3a} \\ \delta_{3b} \end{array} \right] \left\{ \begin{array}{c} P_{3a} \\ P_{3b} \end{array} \right\} \quad (34)$$

The subset of displacements at the interior gridpoints $\{\delta_{3b}\}$ is taken to be made up of a contribution due to interface displacements $\{\delta_f\}$ and a contribution due to displacement relative to the interface $\{\delta_i\}$, i.e.,

$$\{\delta_{3b}\} = \{\delta_f\} + \{\delta_i\} \quad (35)$$

A dependence of interior displacement upon interface displacement is readily derived from static considerations. The expression of this dependence follows by taking the variation of the potential energy (Equation 34) and solving the resulting relation to obtain

$$\{\delta_i\} = \{\gamma_{4b}\} + [\gamma_i] \{\delta_{3a}\} \quad (36)$$

where

$$[\gamma_i] = \left[-[K_{3bb}]^{-1} [K_{3ab}]^T \right] \quad (37)$$

and

$$\{\gamma_{4b}\} = \left\{ [K_{3bb}]^{-1} \{P_{3b}\} \right\}. \quad (38)$$

Definition of displacement relative to the interface, completes the expression of contributions to the total displacement at a point in the interior of a substructure. These displacement contributions $\{\delta_f\}$ are constructed of substructure vibration mode shapes. The relation governing vibration of the substructure is drawn from the partitioned strain energy of Equation 34 and the associated kinetic energy to obtain

$$[K_{3bb}] \{\delta_{3b}\} = \omega^2 [M_{3bb}] \{\delta_{3b}\}. \quad (39)$$

The suppression of the interface displacements $\{\delta_{3a}\}$ was tacitly assumed in the statement of Equation 39. Therefore, the $\{\delta_{3b}\}$ may be interpreted as the $\{\delta_f\}$ of Equation 35 in this relation. Explicit expression is given to $\{\delta_f\}$ in terms of participation factors $\{\delta_g\}$ on vibration mode shapes by extracting eigenvectors from Equation 39 and writing

$$\{\delta_f\} = [\gamma_f] \{\delta_g\}. \quad (40)$$

This result completes the development required to construct a transformation to the final substructure degrees-of-freedom. The result is,

$$\begin{Bmatrix} \{\delta_{3a}\} \\ \{\delta_{3b}\} \end{Bmatrix} = \begin{Bmatrix} \{0\} \\ \{\tau_{4b}\} \end{Bmatrix} + \begin{bmatrix} [I] & [O] \\ [\gamma_i] & [\gamma_f] \end{bmatrix} \begin{Bmatrix} \{\delta_{3a}\} \\ \{\delta_g\} \end{Bmatrix} \quad (41)$$

or symbolically,

$$\{\delta_3\} = \{\tau_4\} + [\Gamma_4] \{\delta_4\}. \quad (42)$$

Introduction of this transformation into the strain energy form of Equation 21 yields

$$\Phi_U = \frac{1}{2} [\delta_4] [K_4] \{\delta_4\}. \quad (43)$$

where

$$[K_4] = [\Gamma_4]^T [K_3] [\Gamma_4]. \quad (44)$$

The other energy forms are correspondingly transformed. The results of this transformation yield the component parts of a mathematical model for the substructure that is ideally suited to combination with other substructures for structural dynamics analyses of large scale systems.

PHASE 5 - SYSTEM ASSEMBLY

Mathematical models are prepared for all of the substructures by utilizing the procedures described in Phases 1 through 4. Assembly of these substructure models to form a model for the complete structure is effected in this fifth phase.

The assembly of substructures into a complete structure proceeds in the same manner as the assembly of finite elements into a substructure that was described in the Phase 2 analysis. The degrees-of-freedom associated with gridpoints common to more than one substructure are assumed to be referenced to compatible coordinate axis directions. This being the case, the displacement set for the complete structure is related to that of its j^{th} substructure through a Boolean transformation of the form

$$\{\delta_4^{(j)}\} = [\Gamma_5^{(j)}] \{\delta_5\}. \quad (45)$$

Contrails

Introduction of this displacement coordinate transformation into the strain energy function of the j^{th} substructure as stated in Equation 43 yields this energy with reference to the $\{\delta_5\}$, i.e.,

$$\Phi_U = \frac{1}{2} \left[\delta_5 \right] \left[\Gamma_5^{(j)} \right]^T \left[K_4^{(j)} \right] \left[\Gamma_5^{(j)} \right] \left\{ \delta_5 \right\}. \quad (46)$$

Summation of these individual substructure strain energies yields a strain energy function for the complete system as

$$\Phi_U = \frac{1}{2} \left[\delta_5 \right] \left[K_5 \right] \left\{ \delta_5 \right\} \quad (47)$$

where

$$\left[K_5 \right] = \sum_j \left[\Gamma_5^{(j)} \right] \left[K_4^{(j)} \right] \left[\Gamma_5^{(j)} \right]. \quad (48)$$

The other system level energy functions are similarly constructed by application of the transformations of Equation 45.

PHASE 6 - CONDENSATION (SYSTEM LEVEL)

The energy functions made available from Phase 5 are expressed in terms of the selected substructure vibration mode shape degrees-of-freedom and degrees-of-freedom common to substructure boundaries or interface. These latter degrees-of-freedom were retained as essential through the preceding analysis phases in order to permit the proper interconnection of the substructures. The interconnection has been accomplished at this point and the appropriateness of these degrees-of-freedom bears examination.

As in the case of the degrees-of-freedom associated with gridpoints interior to a substructure, many interface degrees-of-freedom will exist in consequence of the natural breakdown of the structure into finite elements. In fact, the degrees-of-freedom associated with these interface gridpoints can comprise the major portion of the complete set. This being the case, it is worthwhile to condense out those regarded as superfluous.

Proceeding as in the substructure related Phase 3 condensation, the complete set of degrees-of-freedom is partitioned into essential $\{\delta_{5a}\}$ and superfluous $\{\delta_{5b}\}$ subsets.

Projecting this partitioning forward into the strain energy of Equation 47 and including the corresponding external work function yields the total potential energy as

$$\Phi_P = \frac{1}{2} \left[\begin{array}{c} \{\delta_{5a}\} \\ \{\delta_{5b}\} \end{array} \right] \left[\begin{array}{c|c} [K_{5aa}] & [K_{5ab}] \\ \hline [K_{5ab}]^T & [K_{5bb}] \end{array} \right] \left\{ \begin{array}{c} \{\delta_{5a}\} \\ \{\delta_{5b}\} \end{array} \right\} - \left[\begin{array}{c} \{\delta_{5a}\} \\ \{\delta_{5b}\} \end{array} \right] \left\{ \begin{array}{c} \{P_{5a}\} \\ \{P_{5b}\} \end{array} \right\}. \quad (49)$$

Given that the $\{\delta_{5b}\}$ are superfluous to structural dynamics analyses, the stationary principle of potential energy is invoked as a rational means of establishing a functional dependence of these degrees-of-freedom upon the essential degrees-of-freedom. The stationary conditions of the potential energy follow from Equation 49, i.e.,

$$\left[\begin{array}{c|c} [K_{5aa}] & [K_{5ab}] \\ \hline [K_{5ab}]^T & [K_{5bb}] \end{array} \right] \left\{ \begin{array}{c} \{\delta_{5a}\} \\ \{\delta_{5b}\} \end{array} \right\} = \left\{ \begin{array}{c} \{P_{5a}\} \\ \{P_{5b}\} \end{array} \right\}. \quad (50)$$

Solution of this relation for the superfluous degrees-of-freedom permits construction of the desired condensation transformation in the form

$$\{\delta_{5a}\} = \{\bar{\gamma}_6\} + [\Gamma_6] \{\delta_6\} \quad (51)$$

where

$$\{\delta_6\} = \{\delta_{5a}\} \quad (52)$$

$$[\Gamma_6] = \left[\begin{array}{c|c} [I] & \\ \hline -[K_{5bb}]^{-1} & [K_{5ab}]^T \end{array} \right] \quad (53)$$

$$\{\bar{\gamma}_6\} = \left\{ \begin{array}{c|c} \{O\} & \\ \hline [K_{5bb}]^{-1} & \{P_{5b}\} \end{array} \right\} \quad (54)$$

Introducing the transform relation of Equation 51 into the energy functions furnished from Phase 5 references these functions to the essential degrees-of-freedom $\{\delta_6\}$. For example, the strain energy of Equation 47 is transformed to

$$\Phi_U = \frac{1}{2} [\delta_6] [K_6] \{\delta_6\} \quad (55)$$

where

$$[K_6] = [\Gamma_6]^T [K_5] [\Gamma_6]. \quad (56)$$

The analysis phases up to this point have taken a set of substructures based on finite element models and has evolved these models into a system model expressed in terms of relatively few highly specialized degrees-of-freedom considered essential for vibration and dynamic response analyses.

PHASE 7 - APPLICATION OF BOUNDARY CONDITIONS

Singularities may exist in the stiffness matrix associated with the set of energy functions derived in Phase 6. These singularities may stem from having deferred the application of certain boundary conditions in order to broaden the generality of the model. Note that in Phase 2 provision was made to apply physical boundary conditions by striking out rows and columns associated with displacements prescribed as zero. If, however, the application of boundary conditions was deferred, their introduction can be accomplished by a transformation relation that simply suppresses the associated gridpoint displacement degrees-of-freedom. Symbolically,

$$\{\delta_6\} = [\Gamma_7] \{\delta_7\}. \quad (57)$$

Introduction of this transformation into the energy functions furnished from Phase 6, yields the following

$$\Phi_U = \frac{1}{2} [\delta_7] [K_7] \{\delta_7\} \quad (58)$$

where

$$[K_7] = [\Gamma_7]^T [K_6] [\Gamma_7] \quad (59)$$

and $\{\delta_7\}$ is the vector $\{\delta_6\}$ with the bounded degrees-of-freedom excluded.

PHASE 8 - RIGID BODY MODE SWEEP

The singularities that are more difficult to deal with are those associated with unrestrained response of the structure. These are accounted for in the following paragraphs. First, a set of rigid body modes is constructed. Subsequent simplification is realized if these are referenced to the center of gravity of the structure but this is not essential. The statement of a set of rigid body modes is particularly simple for the type of model developed because none of the degrees-of-freedom which are amplitude coefficients of substructure vibration mode shapes participate in a rigid body motion. Only the relatively few gridpoint displacement degrees-of-freedom that have been retained at the substructure interfaces need be considered. The desired rigid body modes are easily formed and are indicated symbolically herein as $[R]$.

Excluding damping and excitation forces leaves only strain and kinetic energies from which the matrix equation of motion can be readily extracted, i.e.,

$$[M_7] \{\ddot{\delta}_7\} + [K_7] \{\delta_7\} = \{0\}. \quad (60)$$

Premultiplication of this result by the transpose of the rigid body mode matrix $[R]$ yields

$$[R]^T [M_7] \{\ddot{\delta}_7\} + [R]^T [K_7] \{\delta_7\} = \{0\}. \quad (61)$$

This multiplication negates the second term and permits direct integration to obtain a relation governing rigid body motion as

$$[R]^T [M_7] \{\delta_7\} = \{\alpha\} + \{\beta\} t. \quad (62)$$

The rigid body motion of Equation 62 may be neglected ($\{\mathbf{a}\} = \{\mathbf{\beta}\} = \{\mathbf{0}\}$) for present purposes and the coefficient matrix written in partitioned form using a new symbol for convenience, i.e.,

$$\left[\begin{array}{c} [\gamma_a] \\ [\gamma_b] \end{array} \right] \left\{ \begin{array}{c} \{\delta_{7a}\} \\ \{\delta_{7b}\} \end{array} \right\} = \{\mathbf{0}\}. \quad (63)$$

The selection of the degrees-of-freedom for inclusion into $\{\delta_{7b}\}$ is largely a matter of convenience within the constraint that the $[\gamma_b]$ be square and nonsingular. The order of $[\gamma_b]$ is equal to the number of rigid body modes. Solution of Equation 63 for the $\{\delta_{7b}\}$ in terms of the $\{\delta_{7a}\}$ permits construction of the transformation sought to extract the rigid body modes from the model furnished from Phase 7, i.e.,

$$\{\delta_7\} = [\Gamma_8] \{\delta_8\} \quad (64)$$

where

$$\begin{aligned} \{\delta_8\} &= \{\delta_{7a}\} \\ [\Gamma_8] &= \left[\begin{array}{c} [0] \\ \hline -[\gamma_b]^{-1}[\gamma_a] \end{array} \right] \end{aligned} \quad (65)$$

This Phase 8 of the analysis process is completed by the introduction of the transformation $[\Gamma_8]$ as defined in Equation 65.

The result for the strain energy function is

$$\Phi_U = \frac{1}{2} [\delta_8] [K_8] \{\delta_8\} \quad (66)$$

where

$$[K_8] = [\Gamma_8]^T [K_7] [\Gamma_8]. \quad (67)$$

All other energy functions transform correspondingly. Note that this phase can be neglected if the physical boundary conditions in Phase 7 are such as to prevent rigid body motion.

PHASE 9 - SYSTEM VIBRATION MODES AND FREQUENCIES

The mathematical model has been brought to the point where undamped vibration modes and frequencies can be determined. The order of this eigenvalue problem is presumed to have been reduced to well within program capacity. The relevant governing relation, derivable from the strain energy and kinetic energy, is given by

$$\omega^2 [M_8] \{ \delta_8 \} = [K_8] \{ \delta_8 \}. \quad (68)$$

This relation is rewritten in the form

$$[D] \{ \delta_8 \} = \frac{1}{\omega^2} \{ \delta_8 \} \quad (69)$$

where

$$[D] = \left[[K_8]^{-1} [M_8] \right]. \quad (70)$$

to facilitate extraction of the mode shapes corresponding to the lowest natural frequencies. These natural frequencies and mode shapes of vibration complete the characterization required by some design specifications.

This phase of the analysis is extended here to carry the computations forward to provide a basis for prediction of time dependent response. The eigenvectors of Phase 8 are collected together to form the columns of a modal matrix designated $[\Gamma_9]$. Following the normal mode approach to dynamics analysis, () this matrix is employed to effect a transformation to degrees-of-freedom $\{ \delta_9 \}$ which are participation coefficients of the natural mode shapes of the complete structure, i.e.,

$$\{ \delta_8 \} = [\Gamma_9] \{ \delta_9 \}. \quad (71)$$

This transformation completes the development of an optimum set of degrees-of-freedom for use in the prediction of dynamic response. The associated final form of the strain energy is derived by substitution into Equation 66 to obtain

$$\Phi_U = \frac{1}{2} [\delta_9] [K_9] \{ \delta_9 \} \quad (72)$$

where

$$[K_9] = [\Gamma_9]^T [K_8] [\Gamma_9]. \quad (73)$$

At this point it is instructive to reconstruct the complete sequence of transformations that are applied to a typical finite element function to arrive at this final form.

Working backwards, the final system level quadratic forms stem from a three stage transformation beyond the point of assembly of the substructures. In order, these are condensation $[\Gamma_6]$ (Equation 53), singularity sweep $[\Gamma_8]$ (Equation 65) and normal mode $[\Gamma_9]$ (Equation 71) transformations. These yield a collective modification of the system level stiffness matrix in going from the $\{\delta_5\}$ to the $\{\delta_9\}$ that is given by

$$[K_9] = [\Gamma_9]^T [\Gamma_8]^T [\Gamma_7]^T [\Gamma_6]^T [K_5] [\Gamma_6] [\Gamma_7] [\Gamma_8] [\Gamma_9] \quad (74)$$

The contribution of each substructure to the initial system level stiffness matrix $[K_5^{(j)}]$ was, in turn, derived from transformations beyond the point of assembly of its component finite elements. In order, these are prescribed displacement $[\Gamma_2]$ (Equation 20), condensation $[\Gamma_3]$ (Equation 30), component modes $[\Gamma_4]$ (Equation 42) and assembly $[\Gamma_5]$ (Equation 45) transformations. These transformations yield a collective modification of the substructure level stiffness matrix in going from the $\{\delta_1\}$ to the $\{\delta_5\}$ that is given by

$$[K_5] = \sum_j [\Gamma_5]^T [\Gamma_4]^T [\Gamma_3]^T [\Gamma_2]^T [K_1] [\Gamma_2] [\Gamma_3] [\Gamma_4] [\Gamma_5]. \quad (75)$$

Tracing the sequence of transformations to the fundamental finite element blocks is completed by statement of the element assembly transformation $[\Gamma_1]$ of Equation 13, i.e.

$$[K_1^{(j)}] = \sum_k [\Gamma_1^{(k)}]^T [K_e^{(k)}] [\Gamma_1^{(h)}] \quad (76)$$

This recap of the dynamic substructuring procedure makes clear the considerable computation involved. It also exhibits the highly systematic nature of the process.

NOTATION

$\left[\right]$	Rectangular matrix (Eq 1)
$\left\{ \right\}$	Column matrix (Eq 1)
$\left[\right]$	Row matrix (Eq 2)
\sum	Summation operator (Eq 16)
$\left\{ \mu_e () \right\}$	Finite element displacement functions (Eq 1)
$\left[B_e () \right]$	Finite element assumed displacement mode shapes (Eq 1)
$\left\{ \delta_e \right\}$	Gridpoint displacement coefficients of finite element assumed displacement mode shapes (Eq 1)
Φ_U	Strain energy function (Eq 2)
Φ_W	External work function (Eq 3)
Φ_P	Total potential energy function
$\left[K_e \right]$	Finite element stiffness matrix (Eq 2)
$\left\{ F_e \right\}$	Finite element applied load vector (Eq 3)
Φ_V	Pseudo potential for viscous damping (Eq 4)
Φ_S	Pseudo potential for structural damping (Eq 5)
i	Unit imaginary number (Eq 7)
$\left[D_{ve} \right]$	Finite element viscous damping matrix (Eq 4)
$\left[D_{se} \right]$	Finite element structural damping matrix (Eq 5)
Φ_M	Finite element kinetic energy function (Eq 6)
$\dot{}$	Differentiation with respect to time (Eq 6)
$\left[M \right]$	Mass matrix (Eq 6)
$\left\{ \delta_{\mathcal{L}} \right\}$	Gridpoint displacement coefficients referenced to a coordinate system defined by the subscript \mathcal{L} (Eq 8)
$\left\{ \delta_{\mathcal{L}+1} \right\}$	Gridpoint displacement coefficients referenced to a coordinate system defined by the subscript $\mathcal{L}+1$ (Eq 8)
$\left\{ \tau_{\mathcal{L}+1} \right\}$	Translational transformation which relates gridpoint displacement coefficients referenced to a coordinate system defined by the subscript \mathcal{L} to one defined by $\mathcal{L}+1$

$[\Gamma_{\ell+1}]$	Rotational transformation which relates gridpoint displacement coefficients referenced to a coordinate system defined by the subscript ℓ to one defined by $\ell + 1$
j	Substructure identification number (Eq 13)
k	Finite element identification number within a substructure (Eq 1, 13)
T	Matrix transpose operator (Eq 10)
$\{\delta_1^{(j)}\}$	The complete set of gridpoint displacements of the j^{th} substructure (Eq 13)
$[\Gamma_1^{(k)}]$	Transformation relating the $\{\delta_1\}$ to the displacement set of the k^{th} finite element (Eq 13)
$\{\delta_{1b}\}$	The subset of substructure displacements that are prescribed (Eq 17)
$\{\delta_{1a}\}$	The subset of substructure displacements that are essential degrees of freedom (Eq 17)
Φ'_W	A contribution to the external work which arises from the prescribed displacements (Eq 24)
$\{\delta_{2a}\}$	The subset of substructure gridpoint displacement degrees of freedom that is regarded as essential to structural dynamic analyses (Eq 26)
$\{\delta_{2b}\}$	The subset of substructure gridpoint displacement degrees of freedom that is regarded as superfluous to structural dynamics analysis (Eq 26)
$\{P_{2a}\}$	Generalized loads corresponding to the $\{\delta_{2a}\}$ (Eq 26)
$\{P_{2b}\}$	Generalized loads corresponding to the $\{\delta_{2b}\}$ (Eq 26)
$[\Gamma_3]$	Rotational transformation relating the complete set of substructure gridpoint displacement degrees of freedom to the subset essential to structural dynamics analyses (Eq 28)
$\{\tau_3\}$	Translational transformation relating the complete set of substructure gridpoint displacement degrees of freedom to the subset essential to dynamics analyses (Eq 28)
$[K_3]$	Substructure stiffness matrix referenced to the gridpoint displacement degrees of freedom essential to the structural dynamics analyses (Eq 33)
$\{\delta_{3b}\}$	$\{\delta_3\}$ subset of displacements associated with gridpoints interior to a substructure (Eq 34)
$\{\delta_{3a}\}$	$\{\delta_3\}$ subset of displacements associated with gridpoints on the interface of a substructure (Eq 34)

Contrails

$\{\delta_i\}$	Contribution to $\{\delta_{3b}\}$ arising from displacements of the interface gridpoints of a substructure (Eq 35)
$\{\delta_f\}$	Contribution to $\{\delta_{3b}\}$ arising from displacements relative to interface gridpoints of a substructure (Eq 35)
$[\gamma_i]$	Transformation relating interface displacements to the displacements which these induce at (Eq 37) interior points.
$\{\tau_{4b}\}$	Displacement contribution at interior points due to applied loads at interior points (Eq 38)
$[\gamma_f]$	Modal matrix of substructure taken as constrained at the substructure interfaces (Eq 40)
$\{\delta_g\}$	Participation factors on substructure mode shapes
$\{\Gamma_4\}$	Rotational transformation from essential gridpoint degrees of freedom to the final set of substructure degrees of freedom (Eq 42)
$\{\tau_4\}$	Translational transformation from essential gridpoint degrees of freedom to the final set of substructure degrees of freedom (Eq 42)
$\{\delta_4\}$	Final set of substructure degrees of freedom (Eq 42)
$[K_4]$	Final form of substructure stiffness matrix for assembly into complete structure (Eq 44)
$\{\delta_5\}$	Complete set of degrees of freedom after assembly of the substructures (Eq 45)
$[\Gamma_5]$	Transformation between final substructure degrees of freedom and the initial set of degrees of freedom for the assembled structure (Eq 45)
$[K_5]$	Stiffness matrix of complete structure referenced to the $\{\delta_5\}$ (Eq 48)
$\{\delta_{5a}\}$	The subset of degrees of freedom in $\{\delta_5\}$ that is regarded as essential (Eq 49)
$\{\delta_{5b}\}$	The subset of degrees of freedom in $\{\delta_5\}$ that is regarded as superfluous (Eq 49)
$\{P_{5a}\}$	The applied load vector corresponding to the degrees of freedom $\{\delta_{5a}\}$ (Eq 49)
$\{P_{5b}\}$	The applied load vector corresponding to the degrees of freedom $\{\delta_{5b}\}$ (Eq 49)
$[\Gamma_6]$	Condensation transformation from the $\{\delta_5\}$ degrees of freedom for the total structure to the subset chosen as essential (Eq 53)
$\{\tau_6\}$	Contributions to superfluous degrees of freedom from the corresponding applied loads (Eq 54)

DISCUSSION AND CONCLUSIONS

A. DISCUSSION

Integrated general purpose analysis capabilities of the MAGIC II System class signal a major advance in the state-of-the-art of automated tools for analysis. The superior cost effectiveness of such systems over conventional multiple special purpose program capabilities is compelling.

This assertion of superior performance from large scale program systems may well contradict conclusions drawn from experience. Complexity and inefficiency have long been concomitant with large size and versatility in computer programs. Indeed, the elimination of these depreciating effects was prerequisite to realization of the favorable cost effectiveness of the MAGIC II System.

Large size and versatility, without excessive complexity, are assumed intrinsic to the MAGIC II System in subsequent paragraphs, as attention is focused upon the relative efficiencies of integrated general purpose analysis capabilities and multiple special purpose computer program analysis capabilities. This is to presume the pre-requisite elimination of the greater hindrance; namely, the excessive complexity which choked off many early general purpose program developments. This problematical complexity was encountered when programs of simple organization grew to press upon the limits of computer software and hardware capabilities. Extensions beyond this point were accomplished by intricately coordinated multiple usage of valuable names and locations, special program versions with omitted features and other actions which accumulated to entangle the logic and data storage until further modification became impractical.

In the face of this situation increasingly powerful analytical models and solution methods were formulated and numerical implementation demanded. And, as is often the case, sufficient pressure was built up to bring about the technological advances needed in the computer technologies.

Contrails

Advances were forthcoming in programming technology which established the technical feasibility of a truly general purpose computer program system. Advances in computer hardware insured the economic feasibility as the technical feasibility was established through a number of contributing developments. The collective result of these latter developments is, in a word, "organization". Among those organizational characteristics or features considered essential are, the breakdown into single function modules, the program library concept, the matrix interpretive system, machine independency, etc.

It is appropriate to emphasize at this point, that the MAGIC II System for structural analysis is more than a discrete element computer program. It is, in one sense, a Problem Oriented Language (POL) which enables various Analyst specified computational procedures. And, at the same time, it is designed with attendant structural analysis practices evolved from applications experience. These practices are discussed in detail in subsequent paragraphs. The point of interest here is that the efficiency of the MAGIC II System is an overall efficiency governed more by men than machines.

The more comprehensive the comparison, the greater the advantage shown by the integrated general purpose analysis capabilities over multiple special purpose program capabilities. In nearly all cases an equitable comparison must include consideration of program development efforts since relevant technologies are continuously advanced. On this basis the integrated approach enjoys the greatest relative advantage. The integrated approach is also superior to the multiple program approach when considering only factors involved in utilization of operational capability. On the other hand, shorter execution times are conceded to special purpose programs without dispute, since execution efficiency is not essential to the case for the greater overall efficiency of integrated analysis capabilities.

Contrails

Attention is focused now on the impact of the integrated general purpose computer program approach on the efficiency of the many processes involved in maintenance and application of responsive analysis tools in support of a broad structural design activity. Program maintenance efforts benefit from the highly modularized organizational structure to an even greater extent than the initial development effort.

In the initial development, functional modules are established against the requirements of the alternative analysis procedures taken collectively. And, since an extensive commonality exists, multiple repetitious coding is avoided. This same payoff is derived again as existing modules are retired in favor of new modules which offer improved performance. The introduction of a single improved module is reflected to advantage throughout all pertinent analysis procedures of the computer program system. The option exists to retain alternative modules for the same function without sacrifice. This provides useful operational flexibility and a convenient testbed for various candidate procedures. Alternative procedures can be evaluated within the system without disrupting its operational status.

The foregoing has dealt with maintenance of existing analysis capability. Maintenance is also interpretable as generalization of, and addition to, the overall analysis capability. Completely new analyses can be implemented with the addition of only those functional modules absent in the existing capability. For example, finite element heat conduction analyses and the more efficient optimality criteria based optimization methods are possible with relatively minor modifications to the MAGIC II System.

The benefits derived from the organization of a general purpose computer program system in development, maintenance, generalization and extension are simultaneously important disadvantages associated with multiple computer program analysis capabilities. The extensive

Contrails

commonality among analyses leads in this latter case to the repeated development of coding to perform a given function. The preparation of special versions of new modules and the introduction of these into a multiplicity of computer programs is often not justified and the overall capability is depreciated.

Another particularly important handicap borne by the separate programs of a multiprogram capability is that these programs cannot command, individually, the provision of many useful special features. For example, useful options and diagnostics are usually omitted from these special purpose program routines. Also, such programs frequently encounter obstacles such as machine storage capacity which must be avoided rather than surmounted in view of the limited applicability of the program. Advancements in computer software and hardware are further considerations of importance in the maintenance of an analysis capability. These advancements place multiple program capabilities in special peril. Those programs not being actively utilized at the time of transition in software or hardware are easily overlooked and in this way are lost from the overall analysis capability.

No single factor is more important in the provision of a responsive analysis capability than documentation. Engineering documentation must delineate analysis procedure, input data and output data. Programming documentation must provide for operation and modification of the program.

Consolidation of the analysis capability into a general purpose program results in a corresponding favorable consolidation of documentation. Not only is volume reduced but the total capability is described uniformly as a whole. Small programs tend to be the personal tool of the initiator. As a consequence, the documentation prepared is generally inadequate to enable general usage. This situation leads to extensive tutorial instruction to realize the benefits of the program development. At the very least, multiple program capabilities place the burden of assimilating the overall analysis capability from the individual manuals upon the user.

Contrails

The foregoing has pointed out decisive advantages of general purpose program systems in the context of development and maintenance of analysis capability. The most compelling advantages, however, are found in operation. The greater efficiency of the MAGIC II System relative to multiprogram capabilities for analysis stems in large measure from the extent of the analysis process which is covered. Time consuming, error prone, manual transfers of data between special purpose or single step computer programs are avoided. The integration of heat conduction and thermal stress analysis within a single system can circumvent the laborious preparation of temperature data. The integration of stiffness and vibration analyses can similarly circumvent the manual transfer of stiffness and mass data. These eliminations of manual effort yield reductions in calendar time which is often the paramount consideration for contribution of analysis to design. This is not to say that long continuous executions are desirable. Execution interruptions enter importantly into proper utilization of the MAGIC II System.

The MAGIC II System is designed to facilitate good structural analysis practices in support of the overall structural design process. Individual design organizations are best served by structural analysis practices and program versions which are, to some degree, distinct. On the other hand, the extensive commonality which does exist among design organizations provides strong motivation for reviewing the effective structural analysis practices and supplemented program version which have evolved at Bell Aerospace Company.

The structural analysis process begins with the idealization of the structure into an assemblage of finite elements. This is a multistep operation if the structure is first separated into substructures. Generally, the separation into substructures is governed by the physical interconnections of the major structural components. The idealization into finite elements is governed by variations in geometry, dimensions, material, applied loading and boundary conditions.

Contrails

Preprinted input data forms are employed to simplify and thereby improve the reliability of the input data specification. These preprinted input forms associated with the MAGIC II System are an important improvement over card image forms for frequent as well as infrequent users since they incorporate automatic data generation features. These built-in data generation features are supplemented at Bell by auxiliary (not integrated into the MAGIC II System) data generation programs. Some of these are employed routinely. Others are extremely simple programs written for a single, problem related calculation. Such auxiliary programs are frequently employed to advantage in the generation of gridpoint coordinates with reference to the global rectangular coordinate axes, since expression of these can require extensive tedious calculation. This gridpoint coordinate data set should be interpreted here to include points for specification of gridpoint axes transformations and stress and material angles as well as points associated with degrees-of-freedom.

The first MAGIC II System execution undertaken is to confirm the assembled input data deck. This deck is read and the implied data is given explicit definition. For example, material properties are extracted from the Material Library and gridpoint axes transformations are generated from the coordinate table. The completed data set is examined in this preprocessing execution. All data items are stored for execution restart and printed for further checking by the analyst.

The preprocessing execution is supplemented at Bell to include the generation of a magnetic tape which, in turn, generates a plot of the structural model automatically. This plot enables efficient and reliable confirmation of the two most problematical data items; namely, the gridpoint positions and the finite element connection arrangement. Beyond this point the structure plot is a useful identifying title sheet for the printed problem output.

Contrails

The next phase of the analysis process proceeds via a restart through the generation of the structural matrices for stiffness, stress, loads, assembly, boundary conditions, etc. Built-in features control this matrix generation to selectively form only those matrices required for the current analysis. Completion of the matrix generation phase signals exit from the Structural System Monitor. This is an interface point between matrix abstraction instruction statement, and, therefore, a point for optional interruption of the execution to examine the system level matrices. This interruption is used only infrequently at Bell.

Calculation proceeds to the governing matrix equation and thence to the solution for the displacement vectors for all load conditions. For some problems execution may be terminated at this point. For many other problems the validity of the analysis can be assessed against these displacement results and an execution interruption is justified by the computational investment required for the secondary results. Ideally, the deformed structure should be plotted to facilitate interpretation of the predicted displacement behavior.

The analysis proceeds from the displacement solution, with or without interruption, to calculation and print of the remainder of the output data items; namely, reactions, forces, stresses, etc. This is the conventional point of termination of finite element analyses. However, a number of relatively simple auxiliary programs are used to advantage at Bell to relieve the burden this output places on the stress engineers. As in the case of the input data generation auxiliary programs, some of the auxiliary output data reduction programs are employed repeatedly and others are special to a single problem. The functions of these programs include such things as principal stress calculations and margin of safety determinations. Auxiliary programs which do nothing but selectively print and label output data items are also helpful for large problems.

Several comments on the evaluation of output data are warranted in concluding discussion of good structural analysis practices. The examination of output by the Analyst should be initiated under the presumption that an error exists with confidence in the validity of the analysis accumulating as the examination proceeds. Given a complete set of output, attention should first be given to the gridpoint force balances and reactions. Assured that no unintended reactions exist and that residuals are negligibly small, the displacement states should be examined. If the general deformed configuration does not expose any inconsistencies, confirmation is completed by examination of the more extensive presentation of force and stress data.

The foregoing discussion has focused upon development, maintenance and utilization considerations important to the favorable cost effectiveness of the present MAGIC II System for structural analysis. Further evolution of this system can be expected which will continue to improve its relative advantage. Updated versions of the MAGIC II System will be compatible with all features developed in connection with prior versions.

B. CONCLUSIONS

It is concluded that the MAGIC II System is a logical and consistent extension of the original MAGIC System and that additional capabilities realized with the System have met or exceeded the requirements of Contract F 33615-69-C-1241. The satisfactory achievement of the overall objectives is given substantiation by a number of subsidiary conclusions. Specifically, it is concluded that:

- (1) The versatile finite element library enables effective idealization of most linear structures.
- (2) Computational procedures attendant to the MAGIC II System enable the conduct of linear displacement and stress analyses in the presence of general prestrain and thermal loading as well as distributed and concentrated mechanical loading. Additionally, vibration analyses can be employed with or without the use of condensation techniques.

Contrails

- (3) The stability analysis procedure provided in the MAGIC II System enables the prediction of critical load levels for general built-up shell structures.
- (4) The preprinted input data forms facilitate the rapid and reliable specification of problem data as evidenced by their wide acceptance with the original MAGIC System.
- (5) The output provided by the MAGIC II System is oriented to the engineering user and facilitates clear and concise interpretation of output parameters.
- (6) The computer program organization of the MAGIC II System is logical in design and is well suited to generalization.

REFERENCES

1. Mallett, R.H., and Jordan, S., "MAGIC: An Automated General Purpose System for Structural Analysis; Volume I. Engineer's Manual", AFFDL-TR-68-56, Volume I, Air Force Flight Dynamics Laboratory, Wright-Patterson AFB, Ohio, January 1969.
2. Jordan, S., Mallett, R.H., and Maddux, G.E., "MAGIC: An Automated General Purpose System for Structural Analysis; Volume II. User's Manual", AFFDL-TR-68-56, Volume II, Air Force Dynamics Laboratory, Wright-Patterson AFB, Ohio, July 1969.
3. DeSantis, D., "MAGIC: An Automated General Purpose System For Structural Analysis; Volume III. Programmer's Manual", AFFDL-TR-68-56, Volume III, Air Force Flight Dynamics Laboratory, Wright-Patterson AFB, Ohio, January 1969. Gallo, A.M.
4. Jordan, S., "MAGIC II: An Automated General Purpose System For Structural Analysis; Volume II User's Manual AFFDL-TR-71-1 Volume II, Air Force Dynamics Laboratory, Wright-Patterson AFB, Ohio, January, 1971.
5. Gallo, A.M., "MAGIC II: An Automated General Purpose System For Structural Analysis; Volume III. Programmer's Manual", AFFDL-TR-71-1, Volume III, Air Force Flight Dynamics Laboratory, Wright-Patterson AFB, Ohio, January, 1971.
6. Mallett, R.H. and Jordan, S., "Formulation And Evaluation Of A Trapezoidal Cross-Section Ring Discrete Element," BAC Technical Report No. 9500-941-004, September 1966.
7. Helle, E., "Formulation And Evaluation of A Triangular Cross-Section Ring Discrete Element," BAC Technical Report No. 9500-941-003, June 1966.
8. Jordan, S. and Helle, E., "Formulation And Evaluation Of A Two-Dimensional Core Discrete Element," BAC Technical Report No. 9500-941-006, February 1967.
9. Clough, R.W., and Rashid, Y., "Finite Element Analysis of Axisymmetric Solids," J. Eng. Mech. Div. 91, pp. 71-85 (1965).
10. Wilson, E.L., "Structural Analysis of Axisymmetric Solids", AIAA Journal 3,12, pp. 2267-2274 December 1965.
11. Mallett, R.H., "Mathematical Models For Structural Discrete Elements," Bell Aerosystems Company, Technical Note, June 1966.

Contrails

REFERENCES (CONT).

12. Gallagher, R.H. and Huff, R.D., "Derivation of the Force-Displacement Properties of Triangular and Quadrilateral Orthotropic Plates In Plane Stress and Bending, Bell Aerosystems Company Report No. DZ114-950005, November 1963.
13. Turner, M.J. Clough, R.C., Martin, H.C. and Topp, L.J., "Stiffness And Deflection Analysis Of Complex Structures," Journal Of The Aeronautical Sciences, September 1956.
14. Gallagher, R.H., Padlog, J., and Huff, R.D., "Thermal Stress Determination Techniques for Supersonic Transport Aircraft Structures Part III - Computer Programs For Beam, Plate and Cylindrical Shell Analysis", ASD-TDR-63-783, Part III, July 1963.
15. Gallagher, R.H., Padlog, J., " A Discrete Element Approach To Structural Instability Analysis, " AIAA Journal, Vol. I, June 1963.
16. Przemieniecki, J.S., "Theory of Matrix Structural Analysis," McGraw-Hill Book Company, New York, 1968.
17. Mallett, R.H., Braun, F.W., "Thermal Stress Analysis Of The Apollo Block II Spacecraft Lunar Module Adapter And Service Module," Volume I: Finite Element Analysis, Bell Aerosystems Company Technical Report No. 2373-941001, June 1968.
18. Mallett, R.H., Jordan, S., and Batt, J.R., "Manageable Finite Element Models For Large Scale Structural Dynamics Analysis," BAC Technical Report No. 2500-941020, September 1967.
19. Hildebrand, F.B., "Methods of Applied Mathematics," Prentice-Hall, Inc. Englewood Cliffs, New Jersey, 1952.
20. Dettman, J.W., "Mathematical Methods in Physics and Engineering," McGraw-Hill Book Company, New York, 1962.
21. Hurty, W.C., "Dynamic Analysis of Structural Systems by Component Mode Synthesis," Technical Report No. 32-530, Jet Propulsion Laboratory, January 15, 1964.

DOCUMENT CONTROL DATA - R&D

(Security classification of title, body of abstract and indexing annotation must be entered when the overall report is classified)

1. ORIGINATING ACTIVITY (Corporate author) Bell Aerosystems a Textron Company Buffalo, New York		2a. REPORT SECURITY CLASSIFICATION UNCLASSIFIED	
		2b. GROUP N/A	
3. REPORT TITLE MAGIC II - An Automated General Purpose System for Structural Analysis Volume I - Engineer's Manual			
4. DESCRIPTIVE NOTES (Type of report and inclusive dates) Final Report			
5. AUTHOR(S) (Last name, first name, initial) Stephen Jordan			
6. REPORT DATE May 1971		7a. TOTAL NO. OF PAGES 176	7b. NO. OF REFS 21
8a. CONTRACT OR GRANT NO. AF33615-69-C-1241		9a. ORIGINATOR'S REPORT NUMBER(S) AFFDL-TR-71-1, Vol. I	
b. PROJECT NO. 1467		9b. OTHER REPORT NO(S) (Any other numbers that may be assigned this report)	
c. TASK NO. 146702		None	
d.			
10. AVAILABILITY/LIMITATION NOTICES This document has been approved for public release and sale; Its distribution is unlimited.			
11. SUPPLEMENTARY NOTES None		12. SPONSORING MILITARY ACTIVITY Air Force Flight Dynamics Laboratory Research & Technology Division Wright-Patterson AFB, OH 45433	
13. ABSTRACT <p>An automated general purpose system for analysis is presented. This system, identified by the acronym "MAGIC II" for Matrix Analysis via Generative and Interpretive Computations, is an extension of structural analysis capability available in the initial MAGIC System. MAGIC provides a powerful framework for implementation of the finite element analysis technology and provides diversified capability for displacement, stress, vibration and stability analyses.</p> <p>The matrix displacement method of analysis based upon finite element idealization is employed throughout. Ten versatile finite elements are incorporated in the finite element library. These are frame, shear panel, triangular cross-section ring, trapezoidal cross-section ring (and core), toroidal thin shell ring (and shell cap), quadrilateral thin shell and triangular thin shell elements. Additional elements include a frame element, quadrilateral plate and triangular plate elements which can be used for both stress and stability analysis. The finite elements listed include matrices for stiffness, mass, incremental stiffness prestrain load, thermal load, distributed mechanical load and stress.</p> <p>Documentation of the MAGIC System is presented in three parts; namely, Volume I: Engineer's Manual, Volume II: User's Manual and Volume III: Programmers Manual. The subject Volume, Volume III is designed to facilitate implementation, operation, modification and extension of the MAGIC System.</p>			

Security Classification

14. KEY WORDS	LINK A		LINK B		LINK C	
	ROLE	WT	ROLE	WT	ROLE	WT
1. Structural analysis 2. Matrix methods 3. Matrix abstraction 4. Digital computer methods						

INSTRUCTIONS

1. **ORIGINATING ACTIVITY:** Enter the name and address of the contractor, subcontractor, grantee, Department of Defense activity or other organization (*corporate author*) issuing the report.
- 2a. **REPORT SECURITY CLASSIFICATION:** Enter the overall security classification of the report. Indicate whether "Restricted Data" is included. Marking is to be in accordance with appropriate security regulations.
- 2b. **GROUP:** Automatic downgrading is specified in DoD Directive 5200.10 and Armed Forces Industrial Manual. Enter the group number. Also, when applicable, show that optional markings have been used for Group 3 and Group 4 as authorized.
3. **REPORT TITLE:** Enter the complete report title in all capital letters. Titles in all cases should be unclassified. If a meaningful title cannot be selected without classification, show title classification in all capitals in parenthesis immediately following the title.
4. **DESCRIPTIVE NOTES:** If appropriate, enter the type of report, e.g., interim, progress, summary, annual, or final. Give the inclusive dates when a specific reporting period is covered.
5. **AUTHOR(S):** Enter the name(s) of author(s) as shown on or in the report. Enter last name, first name, middle initial. If military, show rank and branch of service. The name of the principal author is an absolute minimum requirement.
6. **REPORT DATE:** Enter the date of the report as day, month, year, or month, year. If more than one date appears on the report, use date of publication.
- 7a. **TOTAL NUMBER OF PAGES:** The total page count should follow normal pagination procedures, i.e., enter the number of pages containing information.
- 7b. **NUMBER OF REFERENCES:** Enter the total number of references cited in the report.
- 8a. **CONTRACT OR GRANT NUMBER:** If appropriate, enter the applicable number of the contract or grant under which the report was written.
- 8b, 8c, & 8d. **PROJECT NUMBER:** Enter the appropriate military department identification, such as project number, subproject number, system numbers, task number, etc.
- 9a. **ORIGINATOR'S REPORT NUMBER(S):** Enter the official report number by which the document will be identified and controlled by the originating activity. This number must be unique to this report.
- 9b. **OTHER REPORT NUMBER(S):** If the report has been assigned any other report numbers (*either by the originator or by the sponsor*), also enter this number(s).
10. **AVAILABILITY/LIMITATION NOTICES:** Enter any limitations on further dissemination of the report, other than those

imposed by security classification, using standard statements such as:

- (1) "Qualified requesters may obtain copies of this report from DDC."
- (2) "Foreign announcement and dissemination of this report by DDC is not authorized."
- (3) "U. S. Government agencies may obtain copies of this report directly from DDC. Other qualified DDC users shall request through _____."
- (4) "U. S. military agencies may obtain copies of this report directly from DDC. Other qualified users shall request through _____."
- (5) "All distribution of this report is controlled. Qualified DDC users shall request through _____."

If the report has been furnished to the Office of Technical Services, Department of Commerce, for sale to the public, indicate this fact and enter the price, if known.

11. **SUPPLEMENTARY NOTES:** Use for additional explanatory notes.
12. **SPONSORING MILITARY ACTIVITY:** Enter the name of the departmental project office or laboratory sponsoring (*paying for*) the research and development. Include address.
13. **ABSTRACT:** Enter an abstract giving a brief and factual summary of the document indicative of the report, even though it may also appear elsewhere in the body of the technical report. If additional space is required, a continuation sheet shall be attached.

It is highly desirable that the abstract of classified reports be unclassified. Each paragraph of the abstract shall end with an indication of the military security classification of the information in the paragraph, represented as (TS), (S), (C), or (U).

There is no limitation on the length of the abstract. However, the suggested length is from 150 to 225 words.

14. **KEY WORDS:** Key words are technically meaningful terms or short phrases that characterize a report and may be used as index entries for cataloging the report. Key words must be selected so that no security classification is required. Identifiers, such as equipment model designation, trade name, military project code name, geographic location, may be used as key words but will be followed by an indication of technical context. The assignment of links, rules, and weights is optional.