

AFFDL-TR-69-25

SCRATCH STRAIN GAGE EVALUATION

T. L. HAGLAGE

H. A. WOOD

**This document has been approved for public
release and sale; its distribution is unlimited.**

FOREWORD

This report is the result of an in-house effort under Project 1467, "Structural Analysis Methods," Task 146704, "Structural Fatigue Analysis."

The item compared in this report is a commercial item that was not developed or manufactured to meet Government specifications, to withstand the tests to which it was subjected, or to operate as applied during this study. Any failure to meet the objectives of this study is no reflection on the commercial item discussed herein or on the manufacturer.

The evaluation program and this report were written by Mr. T. L. Haglage and Mr. H. A. Wood, both of whom are Aerospace Engineers in the Structural Analysis Group, Theoretical Mechanics Branch, Structures Division, Air Force Flight Dynamics Laboratory, with Mr. R. M. Bader as Project Engineer.

The work was conducted from October 1968 to January 1969. Mr. H. E. Andrews, test technician, in conjunction with Mr. F. Hussong, Mr. R. Schneider, and Mr. J. Osborne, prepared the specimens, conducted the tests, and recorded the data.

The manuscript was released by the authors in March 1969 for publication as a technical report.

This technical report has been reviewed and is approved.

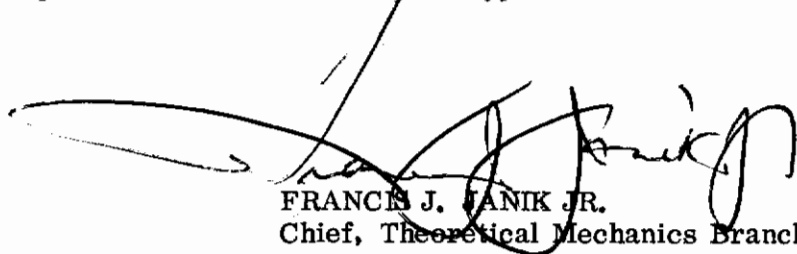

FRANCIS J. JANIK JR.
Chief, Theoretical Mechanics Branch
Structures Division
Air Force Flight Dynamics Laboratory

ABSTRACT

The test results on the evaluation of the Prewitt Scratch Strain Gage are presented in this report. The test program was twofold: (1) observation of the gage operation under various strain applications and (2) investigation of strain recording sensitivity and measurement.

The scratch strain gage, as tests indicated, is a feasible and accurate means of recording strains of a character and magnitude expected to be found in a typical aircraft structure. The recording sensitivity is controlled by proper installation techniques and gage length. For the laboratory conditions reported, the measured strains were equivalent to the electrical resistance gages within $100 \mu\epsilon$.

Contrails

TABLE OF CONTENTS

SECTION		PAGE
I	INTRODUCTION	1
II	GAGE DESCRIPTION	2
III	SCRATCH DESCRIPTION	5
IV	GAGE INSTALLATION	7
V	TEST PROGRAM	11
VI	TEST RESULTS	17
VII	STRAIN MEASUREMENTS	23
VIII	FINDINGS	27
IX	CONCLUSIONS	31
	REFERENCES	33

ILLUSTRATIONS

FIGURE		PAGE
1.	Three-Inch Prewitt Scratch Gage	3
2.	Actual Scratch on the Brass Disc	4
3.	Typical Scratch Representation	6
4.	Gage Being Pressed in Place	8
5.	Aluminum Foil Barrier Taped in Place	8
6.	Taped on Aluminum Foil Buckling Restraints on the Twelve-Inch Gage	8
7.	Scratch Gage with Dimensioned Gage Gap	9
8.	Scratch Gages (Three, Six, and Twelve-Inch) Mounted on the Test Specimen	10
9.	7075-T6 Aluminum Test Specimen	12
10.	Condition # 1 Loading Profile	12
11.	Condition # 2 Stress Profile	13
12.	Condition # 3 Loading Profile	14
13.	Gage Gap Illustration	18
14.	Brass Disc Containing the Strain Recording of Loading Condition No. 2 and 1.5 Times Loading Condition No. 2 Application	19
15.	Gage Gap Installation Curve	22
16.	Photomicrograph of Six-Inch Gage Disc	25
17.	Typical Dimensioned Scratch	26

LIST OF TABLES

TABLE		PAGE
I	Constant Amplitude Test; Loading Condition No. 1	14
II	Tactical Fighter Profile; Loading Condition No. 2	15
III	Constant Mean Strain; Loading Condition No. 3	16
IV	Gage Gap Installation Comparison	18
V	Comparison of Scratch Gage Strain Readings to Electric Gage Strain Readings (Photograph Comparator Method)	24
VI	Comparison of Scratch Gage Strain Readings to Electric Gage Strain Readings (Calibrated Microscope Method)	24

SYMBOLS

SYMBOL

E	Young's Modulus of Elasticity
GG	Installation gage gap
K	Constant for determining the gage gap
L	Spanning length of the gage
ΔP	Maximum load - minimum load in a load cycle
ϵ	Material strain measured in inches / inch
$\mu\epsilon$	Micro-strain -- $\epsilon \times 10^{-6}$
$\Delta\epsilon$	Strain range $\epsilon_{\max} - \epsilon_{\min}$
σ	Applied stress on the material

SECTION I
INTRODUCTION

In an effort to examine potential fatigue damage monitoring devices for use on USAF operational aircraft, a program was formulated to evaluate the Prewitt Scratch Gage as a feasible means of recording strains of a character and magnitude representative of typical aircraft primary structure. This report includes the results of that investigation.

The following significant parameters were evaluated through a series of axial load cyclic tests.

- (a) Recording sensitivity - maximum and minimum
- (b) Sensitivity to strain range - including compression
- (c) Sensitivity to mean strain level
- (d) Target (disc) capacity
- (e) Trace repeatability

Due to the wide variation in strain magnitude, it was decided to test the three commercially available sizes of gages, three, six, and 12 inches, simultaneously. Initial system checkout and gage sensitivity was accomplished primarily with a series of varying constant amplitude block loadings. A tactical fighter mission stress profile provided a means to further investigate recording capability and was utilized to estimate target capacity.

The gage was found to be capable of recording strain comparable to an electric resistance strain gage, and its sensitivity is directly dependent on its length.

SECTION II

GAGE DESCRIPTION

The Prewitt Scratch Strain Gage is a self-contained mechanical extensometer capable of measuring and recording total deformation (and thus average strain) over the effective installed gage length of the member to which it is attached.

As is indicated in Figure 1, the gage consists of two steel base plates (1) and (2), with (1) containing a recording stylus, and (2) the brass recording disc. Physical attachment of the gage assembly to the structure is achieved by either bonding, clamping, or screwing the ends of each base plate.

The outer periphery of the disc is grooved so as to accommodate two rollers (A and B, Figure 1) and encased steel wire brushes (C and D, Figure 1) used to hold the disc in place.

As the structure is strained, the two base plates move relative to each other causing the stylus to scratch the disc and record the total movement. Automatic rotation of the disc occurs under cyclic straining allowing separation of each strain excursion. This counterclockwise rotation is accomplished during gage contraction by the tangential force of the longer brush, D on the circumference of the disc. The shorter brush, C, is used merely to prevent reverse rotation. A typical recorded trace can be seen in Figure 2. Trace characteristics are explained in greater detail in the following section.

To obtain a reference scratch on the recording brass disc, the disc should be rotated manually a small amount in a counterclockwise direction, (about 5 degrees or an arc of 1/16 inch), while it is seated in its position in the gage and at a time when the structure is being strained at a known value. This method is used to zero-in the gage after installation.

Three standard lengths, three-, six-, and 12-inch, are available. However, longer gages can be obtained.

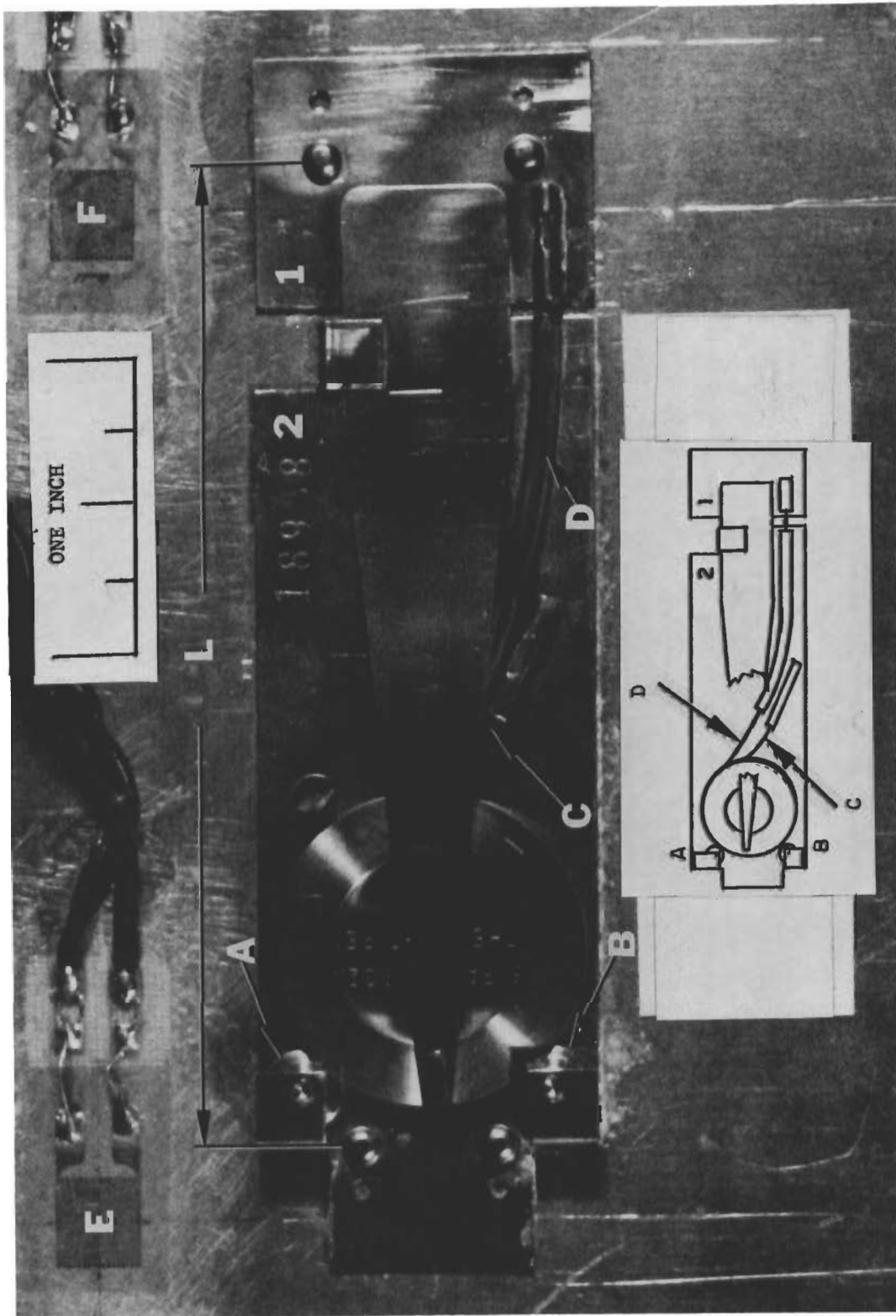

Figure 1. Three-Inch Prewitt Scratch Gage

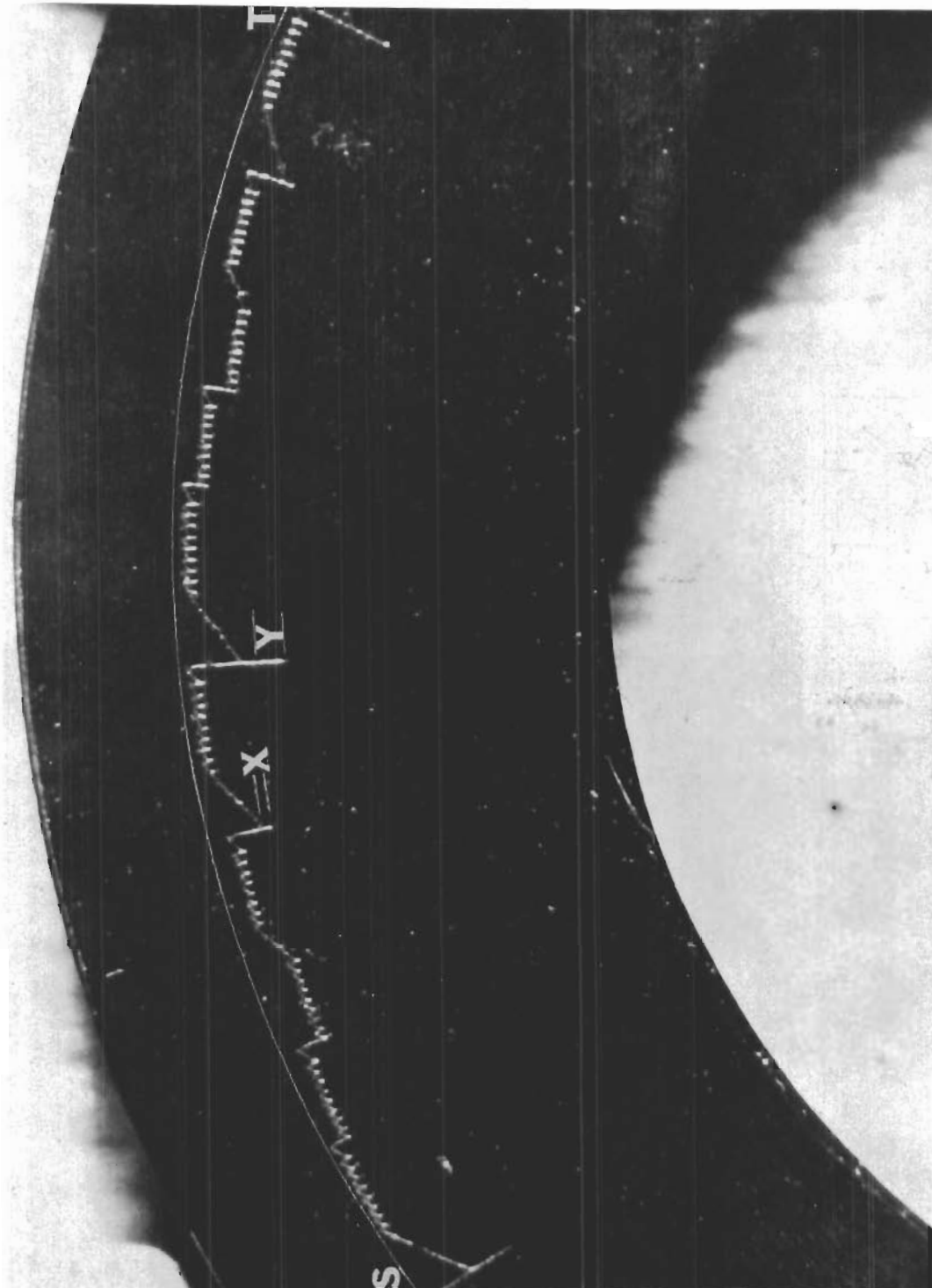

Figure 2. Actual Scratch on the Brass Discs

SECTION III
SCRATCH DESCRIPTION

The scratch on the disc, as shown on Figure 2 and the sketch, Figure 3, follows a specific pattern. The vertical part, A-B, (solid line in sketch) or that portion which is perpendicular to the disc tangent, is made by an elongation or a tensile strain. The slanted part, B-C, (dotted line in sketch) is made by a contraction or a compressive strain. The arc S-T is used as a reference line to separate and directly measure tensile and compressive strains. The actual edge of the disc can also be used as this reference.

Special note should be taken of the overlapped portion of the scratch. (X, Figure 3) This is apparently due to a built-in tolerance within the gage assembly. A small amount of the gage contraction is needed for the wires (D, Figure 1) to become seated in the disc groove before producing rotation. This amount of contraction is estimated to be approximately 0.002 inch.

Any additional overlapping of the scratch (Y, Figure 2 and Figure 3) is a consequence of the gage gap being set too great. In other words, the elongations experienced are so large that the wire tension in the disc groove is reduced to such an extent that the wires are unable to rotate the disc during the initial contraction.

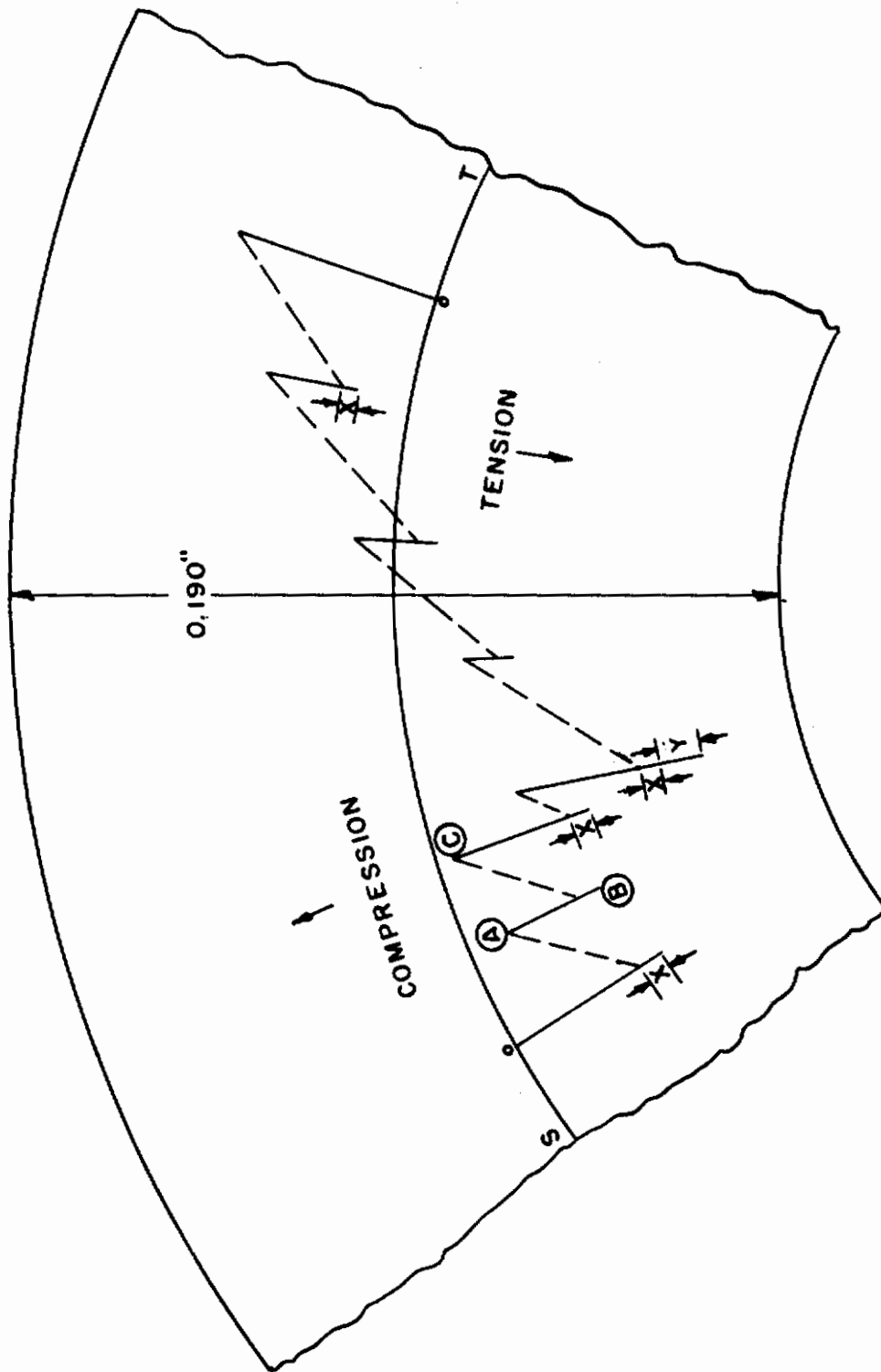

Figure 3. Typical Scratch Representation

SECTION IV

GAGE INSTALLATION

The basic installation and operation of the gage is quite simple. However, certain precautions, must be taken when installing the gages. (1) The direction of principal strain to be measured should coincide with the longitudinal axis of the gage (Figure 4). (2) The free or spanning length of the gage (L, Figure 1) must be accurately known. When mechanical fasteners are used for installation, there is no problem. However, when an adhesive bonding is utilized, a barrier or dam should be used to restrict the area which is being bonded thus having an accurate dimension for the spanning length. In this program the six- and 12-inch gages were bonded and a piece of aluminum foil taped in place as shown in Figure 5 accomplished the desired effect. The two taped-on aluminum foil patches (A & B, Figure 6) were used as frictionless buckling restraints for the longer 12-inch gage, since the longer unsupported length has a tendency to bow away from the structure.

After the gage is fastened to the structure to be tested, the brass disc is placed in position under the stylus making certain that each of the rotating wires is guided into the groove of the disc. The stylus is then allowed to rest on the brass disc. Slight mention will be made at this point of the gage installation gap, dimensions X and Y (Figure 7). These dimensions are critical because they control the rotation capabilities of the gage at various strain levels. This will be explained in greater detail in a following section.

For the purpose of an expedient evaluation, all three gages, three-, six- and 12-inch, were mounted on the same specimen, as shown in Figure 8. Since these mountings were to be somewhat permanent, epoxy glue was used to install the 12-inch and the six-inch gages. The three-inch gage was installed with self-tapping screws.

Electrical resistance strain gages were also mounted to monitor the strain application (E & F, Figure 1). A permanent oscillograph record of each test was used for direct correlation with the disc traces.

AFFDL-TR-69-25

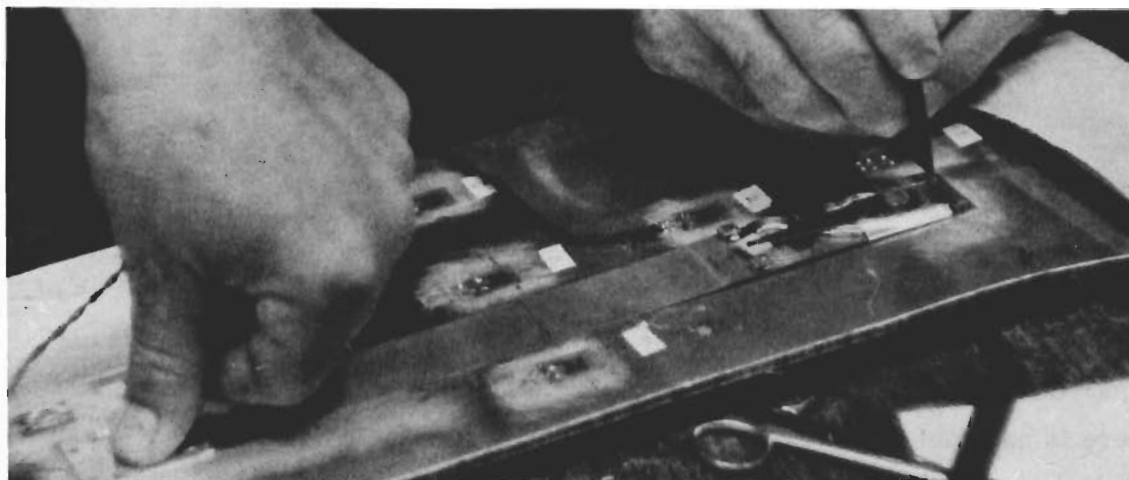

Figure 4. Gage Being Pressed in Place

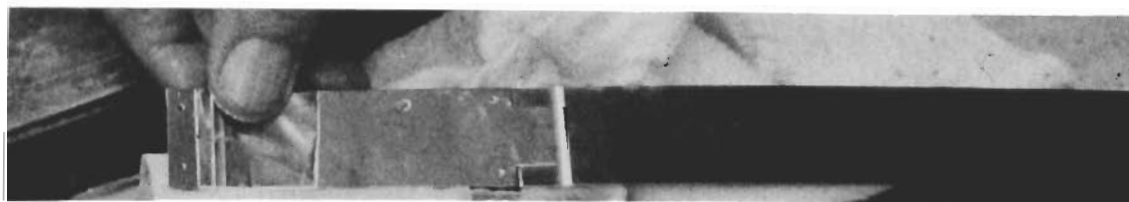

Figure 5. Aluminum Foil Barrier Taped in Place



Figure 6. Taped on Aluminum Foil Buckling Restraints on the Twelve-Inch Gage

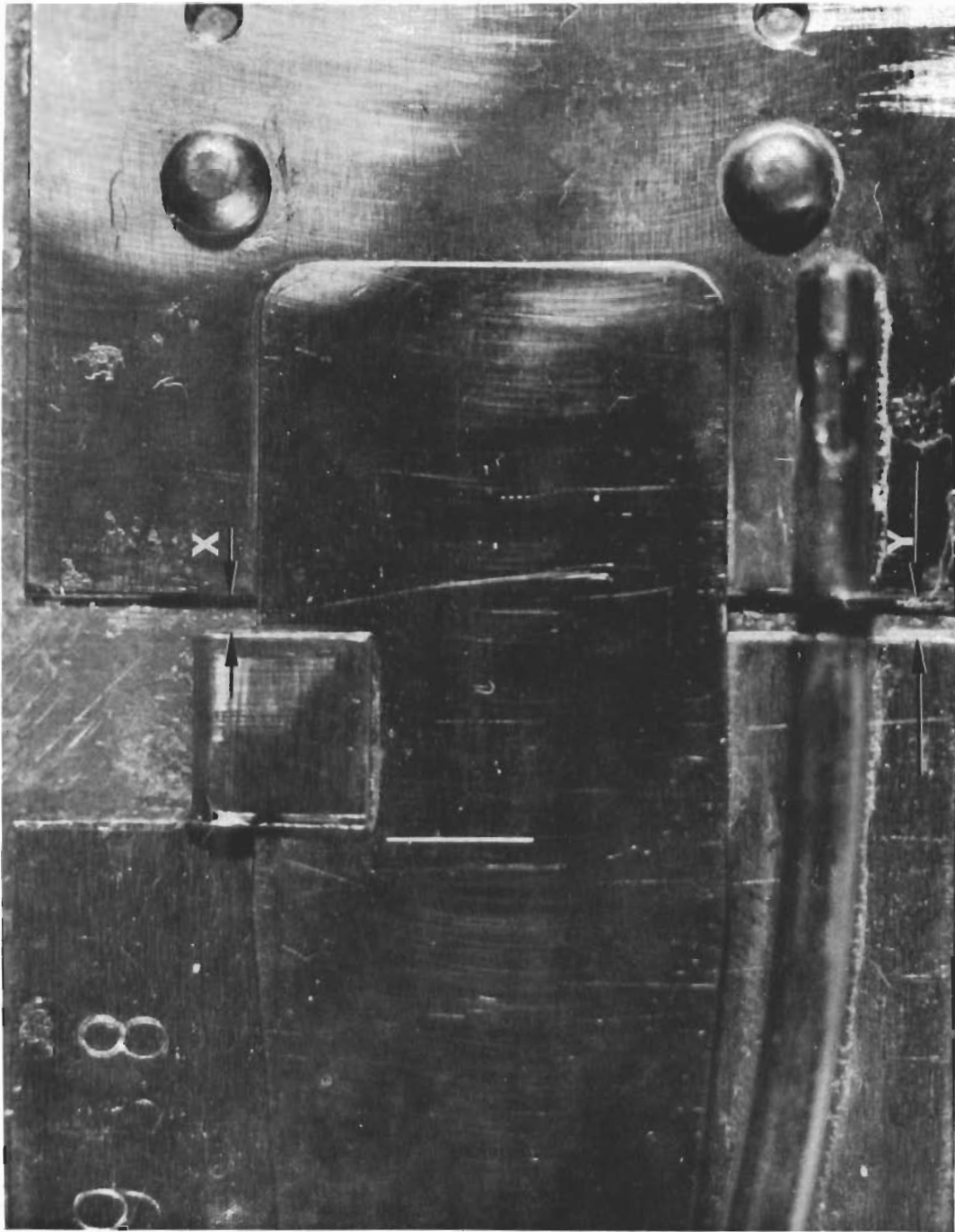

Figure 7. Scratch Gage with Dimensioned Gage Gap

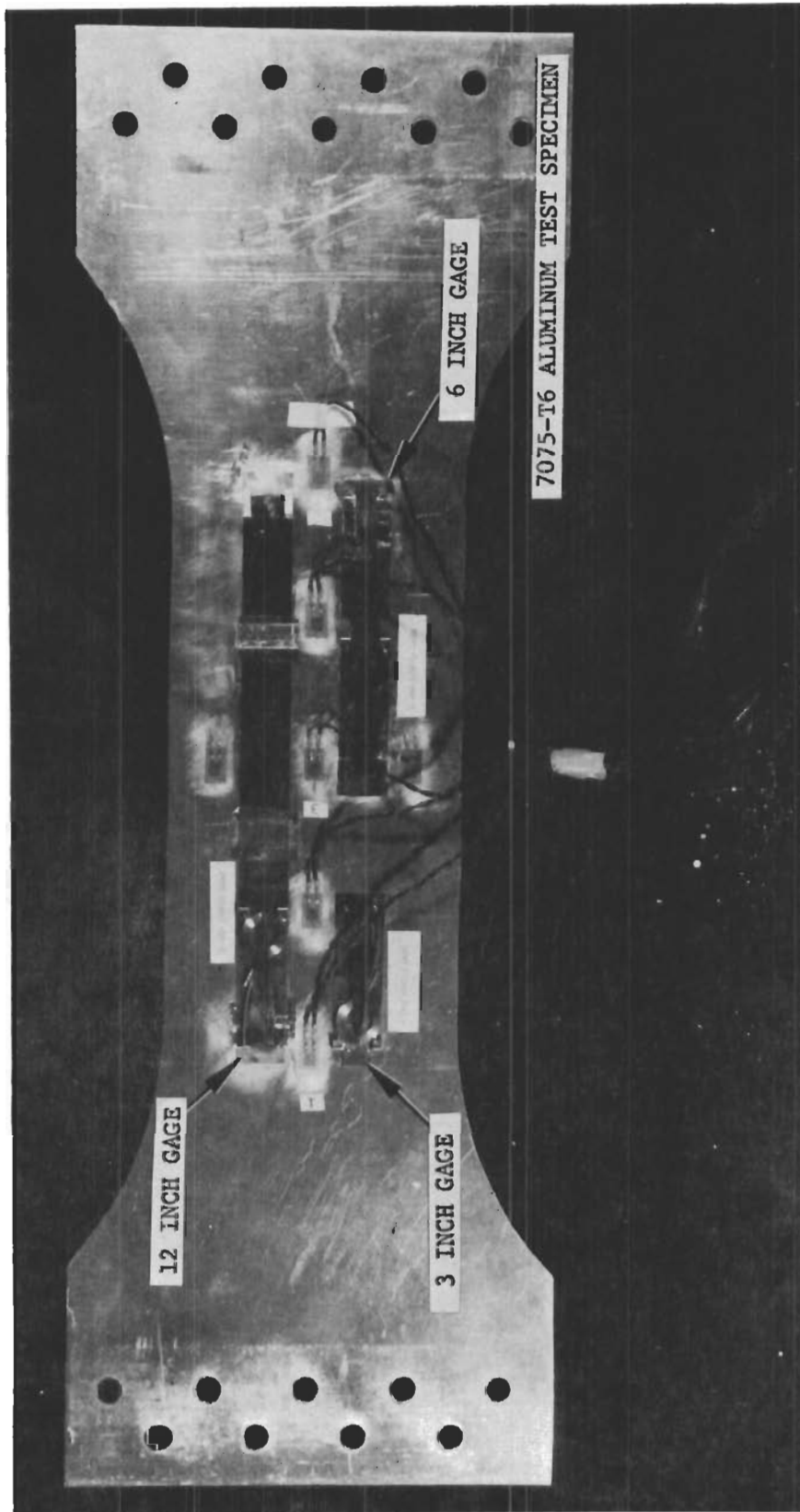

Figure 8. Scratch Gages (Three, Six, and Twelve-Inch) Mounted on the Test Specimen

SECTION V
TEST PROGRAM

All tests were conducted with a 7075-T6 ($E = 10.3 \times 10^6$ PSI) aluminum alloy sheet specimen with dimensions as indicated in Figure 9.

With the gages (scratch and electric) installed as indicated in Figure 8, the specimen was mounted in a 50,000-lb. capacity hydraulic test fixture. Cyclic loading was controlled either manually or with magnetic tape. A nominal loading rate of 0.5 CPS was maintained throughout the test.

Three separate types of loading conditions were applied throughout this program as summarized in Tables I, II, and III. Condition No. 1 (Figure 10) was a series of constant amplitude load applications and was used for initial system checkout. Condition No. 2 (Figure 11) was a taped stress profile for a typical tactical fighter training mission which included three low level runs, three bombing runs, three strafing runs, and the return flight. Condition No. 3 (Figure 12) was a series of constant amplitude cyclic loads with constant stress range and decreasing mean stress level.

Specimen geometry precluded the possibility of applying axial compressive loads during this investigation. In order to record and observe compressive strains the beam was manually deflected in bending. Trace characteristics in compression are similar to those in tensile elongation and have been further described in Section III. No quantitative measurements of compressive strains have been included in this summary.

AFFDL-TR-69-25

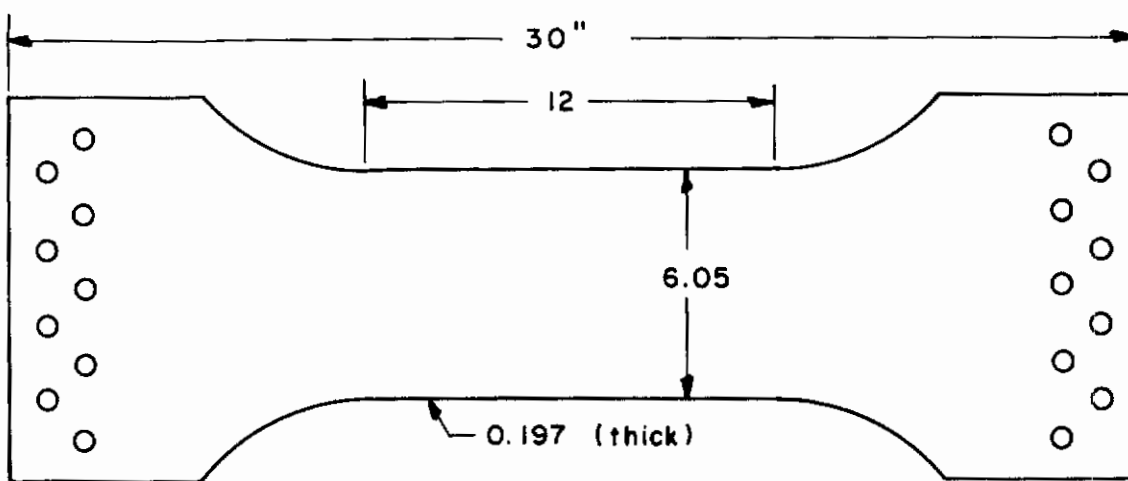

Cross Sectional Area = 1.192 sq in

Figure 9. 7075-T6 Aluminum Test Specimen

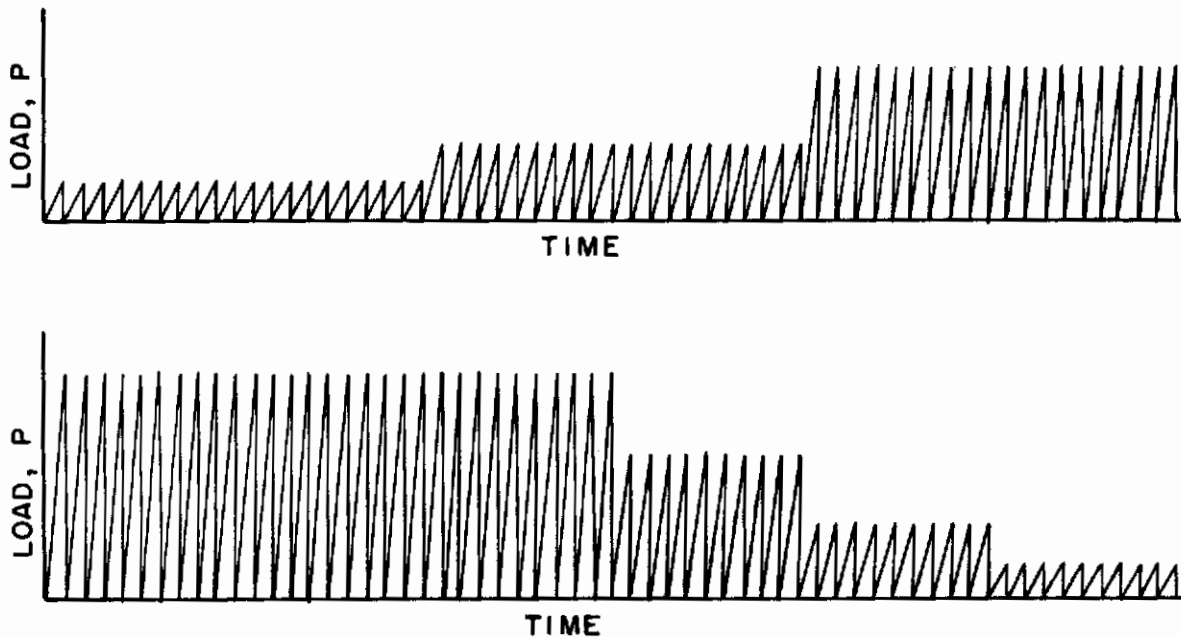

Figure 10. Condition #1 Loading Profile

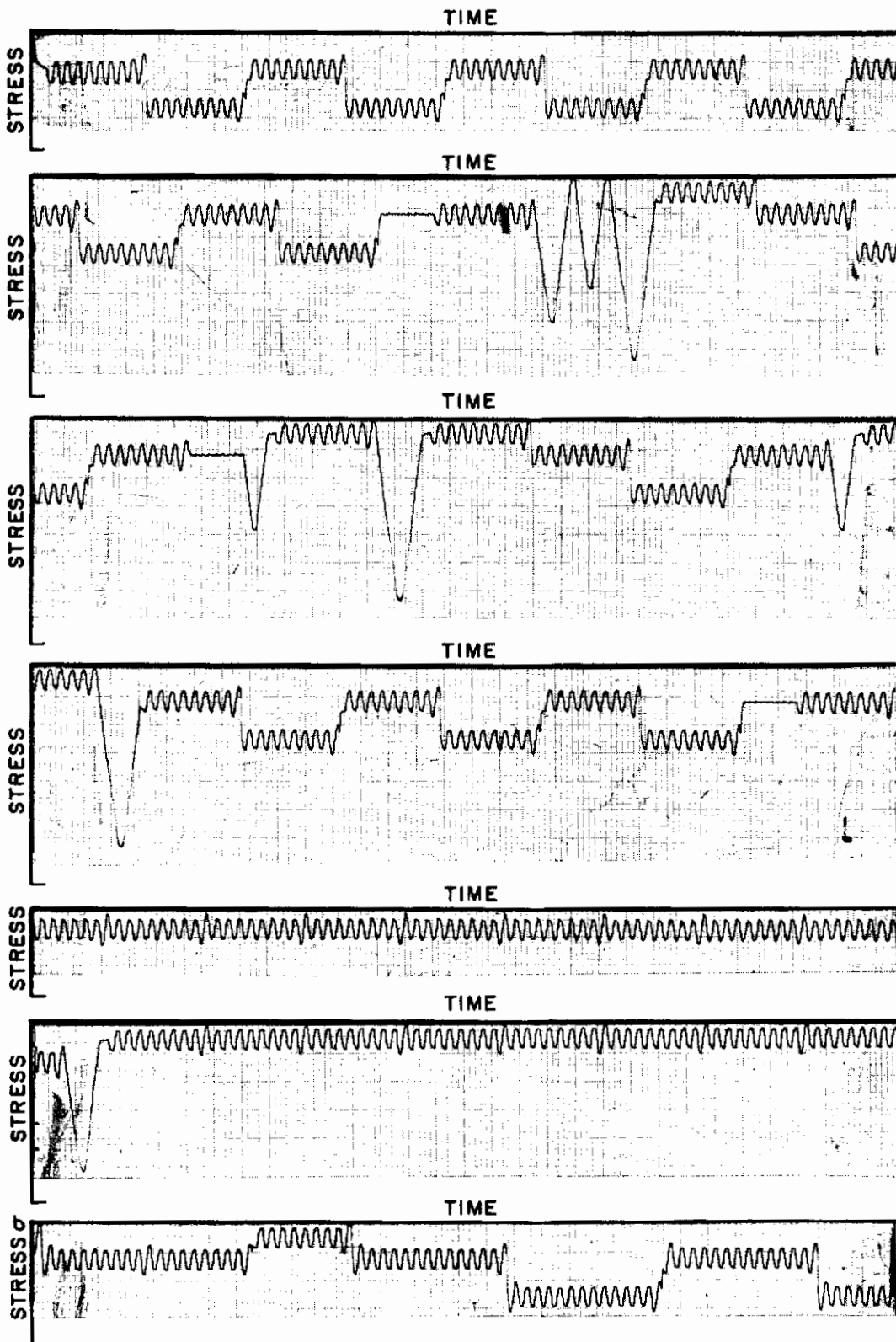

Figure 11. Condition #2 Stress Profile

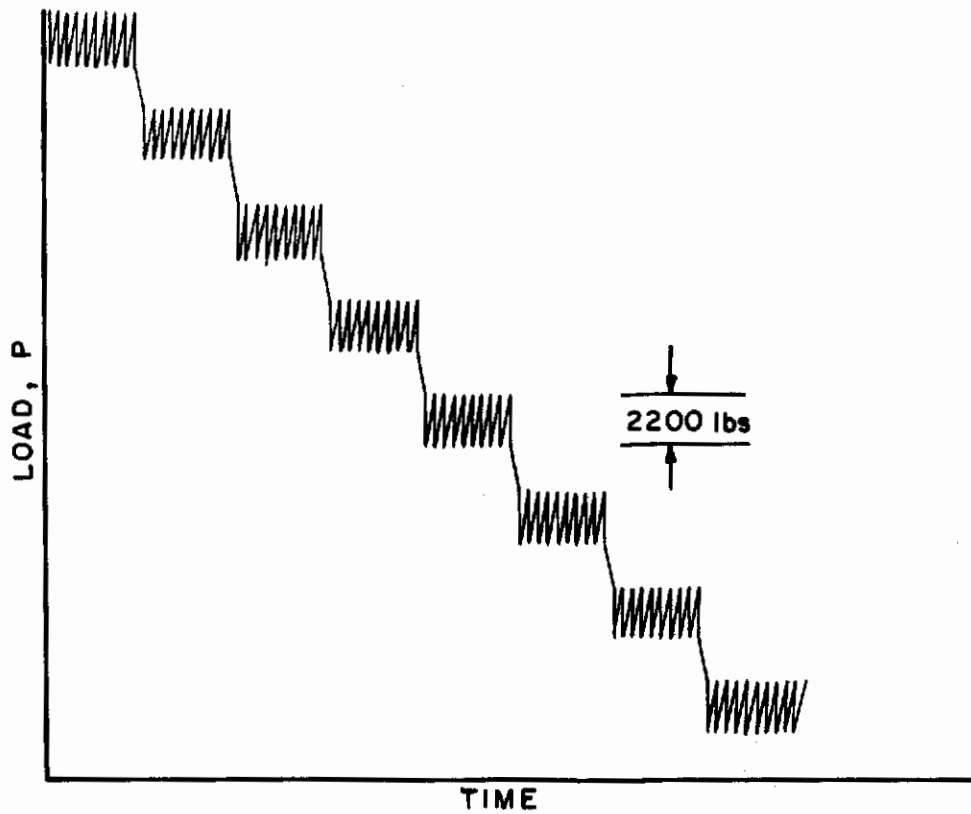

Figure 12. Condition #3 Loading Profile

TABLE I
CONSTANT AMPLITUDE TEST
LOADING CONDITION NO. 1

CYCLES	P _{MAX}	P _{MIN}
NUMBER	KIPS	KIPS
20	4.0	0.0
20	8.0	0.0
20	16.0	0.0
20	24.0	0.0
10	24.0	0.0
10	16.0	0.0
10	8.0	0.0
10	4.0	0.0

TABLE II
TACTICAL FIGHTER STRESS PROFILE
LOADING CONDITION NO. 2

CYCLES NUMBER	P _{MAX} KIPS	P _{MIN} KIPS	CYCLES NUMBER	P _{MAX} KIPS	P _{MIN} KIPS	CYCLES NUMBER	P _{MAX} KIPS	P _{MIN} KIPS
1	5.53	0	8	2.83	0.55	7	9.91	7.63
7	5.53	3.25	1	3.81	0.12	1	10.61	6.92
1	6.24	2.54	1	5.64	0.11	80	5.53	3.25
1	9.91	2.54	7	5.53	3.25	10	6.24	2.54
7	9.91	7.63	1	6.24	2.54	1	17.56	2.54
1	10.61	6.92	1	9.91	2.54	64	2.83	0.55
8	5.53	3.25	7	9.91	7.63	108	3.81	0.12
1	6.24	2.54	1	10.61	6.92	1	6.24	0.12
1	9.91	2.54	8	5.53	3.25	8	5.53	3.25
7	9.91	7.63	1	6.24	2.54	1	6.24	2.54
1	10.61	6.92	1	13.16	2.54	8	5.53	3.25
8	5.53	3.25	8	2.83	5.49	1	6.24	2.54
1	6.24	2.54	1	3.81	0.12	8	2.83	0.55
1	9.91	2.54	1	21.94	0.11	1	3.81	0.12
8	10.61	6.92	8	5.53	3.25	1	6.24	0.12
8	5.53	3.25	1	6.24	2.54	8	5.53	3.25
1	6.24	2.54	1	9.91	2.54	1	6.24	2.54
1	9.91	2.54	7	9.91	7.63	1	10.64	2.55
7	9.91	7.63	1	10.61	6.92	12	9.91	7.63
1	10.61	6.92	8	5.53	3.25	1	10.61	6.92
8	5.53	3.25	2	9.91	2.54	12	5.53	3.25
1	6.24	2.54	7	9.91	7.63	2	6.24	2.54
1	13.16	2.54	1	10.61	6.92	1	10.64	2.55
8	2.83	0.55	8	5.53	3.25	12	9.91	7.63
1	3.81	0.12	1	6.24	2.54	1	10.61	6.92
1	21.94	0.11	1	9.91	2.54			

TABLE III
CONSTANT MEAN STRAIN
LOADING CONDITION NO.3

CYCLES	P_{MAX}	P_{MIN}
NUMBER	KIPS	KIPS
10	45.50	43.30
10	39.80	37.60
10	34.20	32.00
10	28.50	26.30
10	22.80	20.60
10	17.10	14.90
10	11.40	9.20
10	5.70	3.50

SECTION VI

TEST RESULTS

To initiate the testing program, loading conditions numbers 1 and 2, (Tables I and II) were applied to the specimen with all three gages actively recording. Upon completing one set of loads, the discs were removed, examined, and the traces photographed through a 50X microscope. Correlation with the output of the two electrical resistance strain gages were made.

Under normal operation, strain sensitivity and total disc rotation would be expected to increase with increased gage length. However, during the initial test phase the following observations were made:

1. The three- and six-inch gages operated well and recorded strains lower than anticipated or advertised by the manufacturer. (0.004 inch/gage length, Reference 1).
2. The six-inch gage disc rotated more than either the three- or 12-inch for the same strain levels and number of cycles.
3. Under improper installation, certain malfunctions would occur.
4. The 12-inch gage disc rotated only at strain levels greater than 160 micro-strain and less than 400 micro-strain.
5. At strain levels outside the range of $160 \mu\epsilon$ - $400 \mu\epsilon$ the stylus of the 12-inch gage remained in the same vertical groove and required either a much greater or a much smaller strain to allow the stylus to escape and the disc to rotate.

The last observation was caused by improper installation. Examination of the gage installation gap (Figures 7 and 13) revealed that the 12-inch gage had been installed in a "cocked" position as indicated in Table IV.

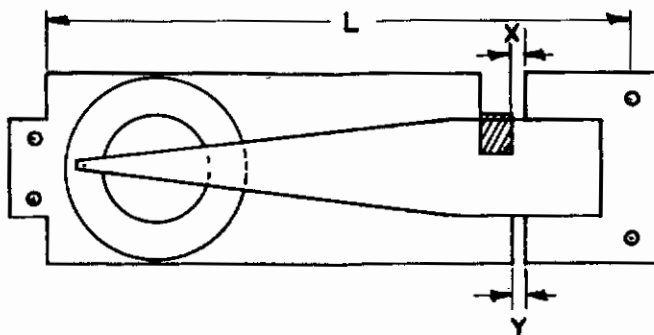

Figure 13. Gage Gap Illustration

TABLE IV
GAUGE GAP INSTALLATION COMPARISON

L	X	Y
IN.	IN.	IN.
3	0.043	0.043
6	0.032	0.031
12	0.071	0.048

The 12-inch gage was removed and reinstalled, setting both X and Y equal to 0.040 inch. Again, the variable stress profile, loading condition number 2 was applied; once as per Table II and then repeated with all loads increased by 50%. The results were more favorable since an improved sensitivity to individual strains was noted (the lowest being 190 micro-strain), as well as an increased revolution of the disc. The disc capacity was exceeded with less than two complete condition number 2 programs applied. This is indicated in Figure 14 which is a photograph of the recording disc utilized in this sequence. The portion of the trace which overlapped is discernible and can easily be read with the microscope.

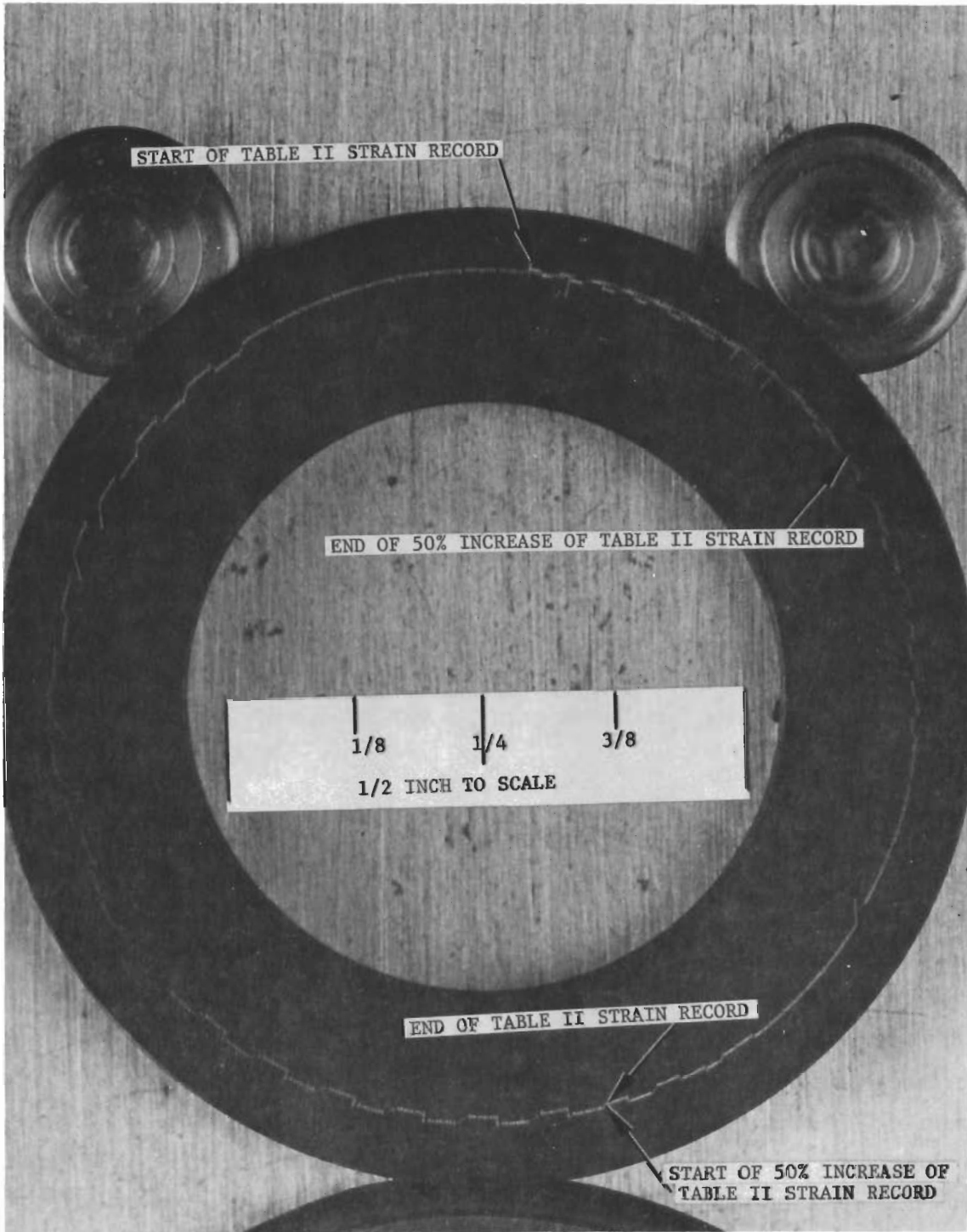

Figure 14. Brass Disc Containing the Strain Recording of Loading Condition No. 2 and 1.5 Times Loading Condition No. 2 Application

To examine the effect of mean strain on gage sensitivity, the third loading program was applied with all three gages in operation. The sequence of loads as indicated in Table III produced eight sets of constant strain range with seven reductions in the mean strain level.

The three- and six-inch gages recorded the variation in mean strain levels but failed to record the ten cycles of superimposed ΔP (2200 lbs) alternating about the mean. The 12-inch gages, failed to separate the first four mean strain reductions, but did separate the last three. It also recorded each individual cycle of ΔP during the last three variations in mean load.

To examine these observations, the 12-inch was reinstalled with a reduced gage gap of 0.020 inch (dimensions X and Y, Figure 7). Loading condition number 3 was reapplied and the gage recorded and separated all strain values less than 3000 micro-strain. However, above this limit the disc would not rotate because the wire brush tension was reduced to a small portion of that required for effective rotation. The increase in tensile mean strain thus effectively increases the installation gage gap and reduces the gage rotation sensitivity.

Upon comparing the results for two separate installation gaps, a pattern is seen to evolve. With an installation gap of 0.040 inch, the maximum rotating tensile strain is 1750 micro-strain. With a gap of 0.020 inch, this maximum increases to 3000 micro-strain or within 500 micro-strain of being twice that of the first installation. At 3000 micro-strain, an increase in elongation of 0.036 inch on the 12-inch gage is experienced which at this maximum point increases the total gage gap from 0.020 inch to 0.056 inch. The maximum strain of 1750 micro-strain recorded with the first installation is produced by an elongation of 0.021 inch which increases the gap from 0.040 inch to 0.061 inch. Thus it is apparent that the 12-inch gage disc fails to rotate when the total gap becomes greater than ≈ 0.056 inch. Therefore, if an estimate is made of the maximum value of strain to be recorded, the proper installation gap can be estimated by multiplying the maximum strain by the gage length (12-inch in this case) and subtract the constant, 0.056 inch.

AFFDL-TR-69-25

Although the preceding values were derived for the 12-inch gage which was examined, the same relationship should hold for any gage length so long as loading is always tension-tension. A typical gage gap installation curve might be constructed as shown on Figure 15.

If compressive strain is to be measured, gage installation techniques should account for the possibility of completely closing the gap. Observance of the compressive recording region of Figure 15 will preclude this possibility.

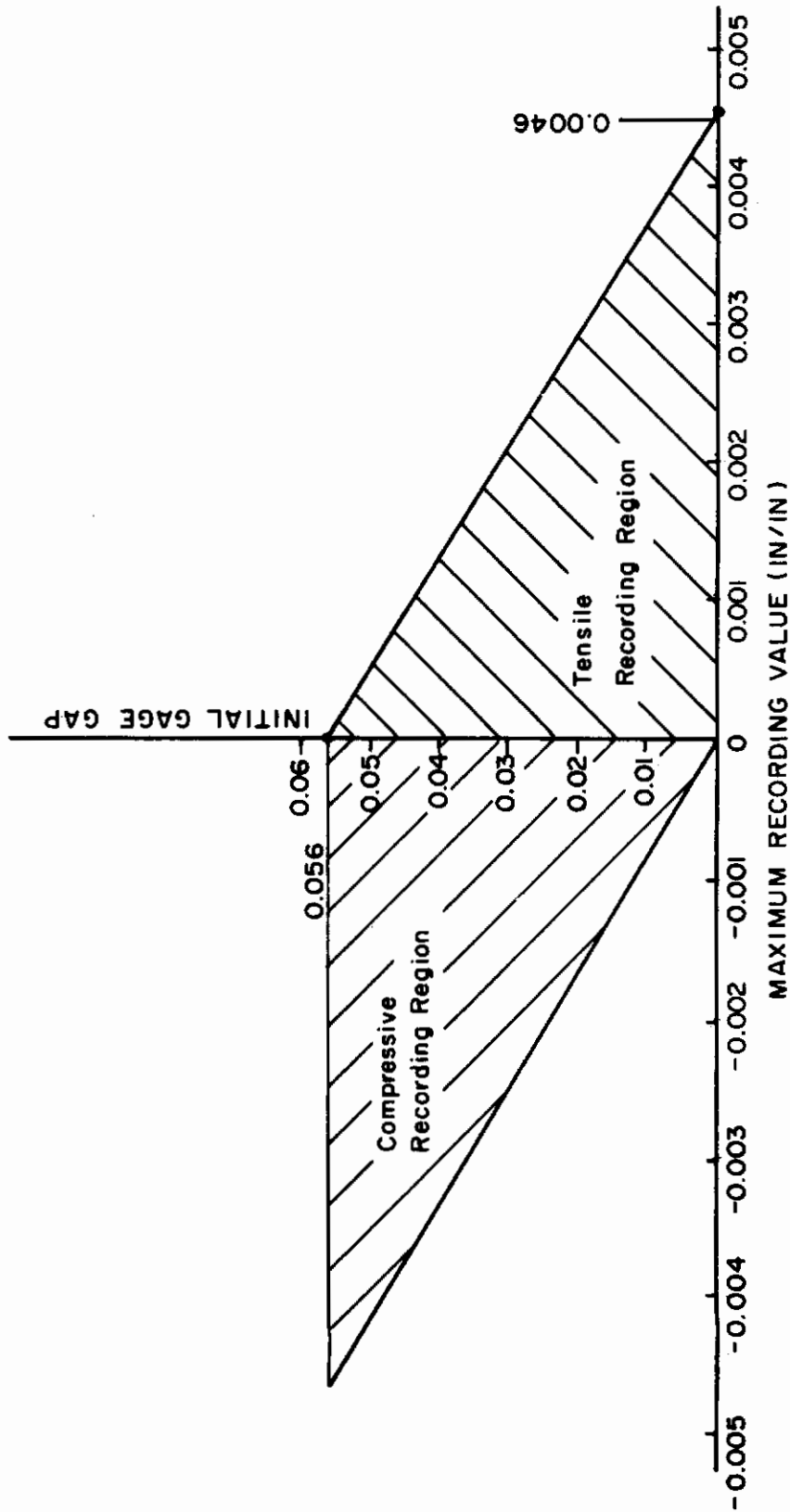

Figure 15. Gage Gap Installation Curve

SECTION VII

STRAIN MEASUREMENT

The stylus makes a permanent record of total axial deflection over the gage length. Conversion to strain requires accurate measurement of the effective gage length and scribed trace amplitude. Effective gage length is dependent upon the method of installation, and this item was discussed in Section IV.

For this investigation, two methods of measuring trace amplitude were attempted.

1. Measurement from a photomicrograph of the disc.
2. Direct measurement of the trace with a calibrated microscope.

Measurements obtained by each method were divided by effective gage length to obtain average strain and the results compared with electrical resistance strain gage readings. Tables V and VI include comparative values obtained by each method encompassing nearly the entire range of strain values employed in this study.

Figure 16 includes a portion of the disc obtained from the six-inch gage with magnification of 25X. The magnification value was obtained by measuring a portion of the arc and chord length from the photograph and comparing this measurement with the known true dimension of the disc. Even with this relatively simple and crude method, accuracy is noted to be quite good.

The variation in readings between the photographs and the strain gage was usually less than 100 micro-strain (Table V).

The second method of measuring the trace amplitudes requires a great amount of care, especially at the lower strain levels due to errors which may occur in the determination of the actual path of the trace and the center of the scratch. The scratch itself is 0.0007 inch wide, and the vertex or peak dimension, 0.0009 inch. (Figure 17).

TABLE V
COMPARISON OF
SCRATCH GAGE STRAIN READINGS
TO ELECTRIC GAGE STRAIN READINGS
PHOTOGRAPH COMPARATOR METHOD

3 Inch Scratch $\mu\epsilon$	Electric $\mu\epsilon$	6 Inch Scratch $\mu\epsilon$	Electric $\mu\epsilon$	12 Inch Scratch $\mu\epsilon$	Electric $\mu\epsilon$
667.	680	236	280	355	320
1000.	1080	675	600	710	680
1450.	1400	1015	1000	1340	1400
2000.	1880	1350	1320	1770	1800
2140.	2040	2840	2780	1940	2040

TABLE VI
COMPARISON OF
SCRATCH GAGE STRAIN READINGS
TO ELECTRIC GAGE STRAIN READINGS
CALIBRATED MICROSCOPE METHOD

3 Inch Scratch $\mu\epsilon$	Electric $\mu\epsilon$	6 Inch Scratch $\mu\epsilon$	Electric $\mu\epsilon$	12 Inch Scratch $\mu\epsilon$	Electric $\mu\epsilon$
430	350	250	300	166	217
1000	920	930	920	242	289
1100	1120	1133	1120	1075	1120
1300	1360	1310	1360	1766	1850
1830	1860	2700	2780	1850	1920

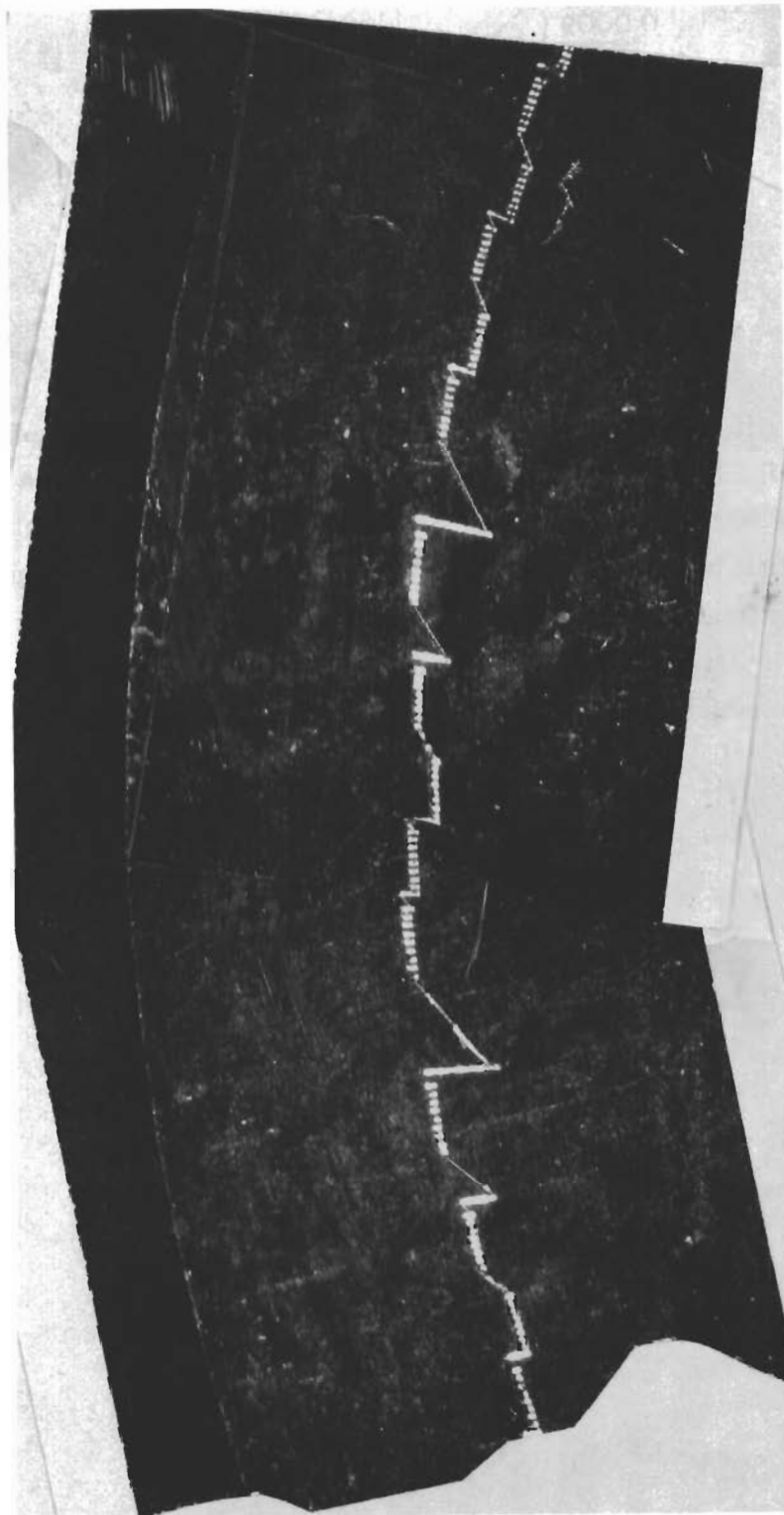

Figure 16. Photomicrograph of Six-Inch Gage Disc

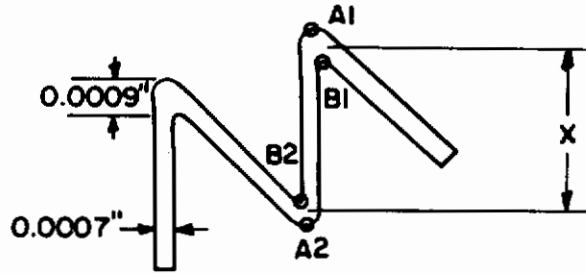

Figure 17. Typical Dimensioned Scratch

Consequently, if distances $A1 - A2$ or $B1 - B2$ are read instead of the true value, X , a significant error will be introduced. Readings for this investigation were obtained with a 100X microscope with a traveling table capable of reading 0.0001-inch increments. Measurements were made from a reference zero point to the estimated center of the scratch. The comparative results are summarized in Table VI. The precision of this method is on the same order as method one which is usually less than 100 micro-strain.

**SECTION VIII
FINDINGS**

The major results and other observations of the program can be summarized as follows.

(1) The recording disc capacity depends upon the magnitude of the strains, the frequency of their application, and the length of the gage. Under normal operation, the six-inch gage disc rotated approximately one-half revolution for the mission profile application which simulates a flight of one hour and a half duration.

(2) Either side of the brass disc may be used for recording.

(3) The gage records all strain values (tension and compression).

(4) Strain cycles are distinguished when rotation of the disc is present.

(5) Rotation is produced by the contraction portion of the strain cycle.

(6) A threshold or minimum amount of contraction is needed to produce rotation. This amount has been suggested as 0.004 inch by the manufacturer. Test results from this program indicate that 0.002 inch is sufficient.

(7) Thus, for a properly installed gage, minimum threshold strain range of 0.002 inch/L inch may be recorded and distinguished.

(8) Gage sensitivity is the minimum strain range capacity of the gage. (the minimum value which will produce rotation).

(9) Gage sensitivity is dependent upon the gage length.

(10) Proper gage installation requires the installed gap to be less than some prescribed value in order that rotation capabilities of the gage remain constant. For the conditions of this investigation, this value has been determined to be 0.056 inch and should be the same for any gage length.

(11) Thus, the installation is sensitive to mean strain since this effectively changes the initial gap.

(12) The maximum strain value, ϵ_{\max} , below which a properly installed gage is sensitive, may be determined with the aid of the following empirical formula

$$\epsilon_{\max} = (K - GG) / L$$

where $K = 0.056$ inch

$GG =$ gage gap (inch)

$L =$ spanning length of the gage (inch)

This can best be illustrated with the following examples. Three examples were used to show the variation in gage length with a change in $\Delta\epsilon$ and the variation in the gage gap with a change in ϵ_{\max} .

Example Number 1

$$\begin{aligned} E &= 10.0 \times 10^8 \text{ PSI} & \sigma_{\max} &= 35,000 \text{ PSI} & \epsilon_{\max} &= 3500 \mu\epsilon \\ & & \sigma_{\min} &= 25,000 \text{ PSI} & \epsilon_{\min} &= 2500 \mu\epsilon \\ & & \Delta\epsilon &= 1000 \mu\epsilon \end{aligned}$$

Determine gage spanning length (L)

As stated in statement number 7:

$$\begin{aligned} L &\geq 0.002 / \Delta\epsilon = 0.002 / 0.001 \\ &\geq & &= 2 \end{aligned}$$

Use: L = 3 inches

Determine installation gage gap (G.G.)

As stated in statement number 12:

$$G.G. \leq K - \epsilon_{\max}(L)$$

where $K = 0.056$ inch

$\epsilon_{\max} = 0.0035$ in/in

$L = 3.0$ inches

G.G. = Gage Gap

$$\begin{aligned} \therefore \text{G.G.} &\leq 0.056 - 0.0035 (3) \\ &\leq 0.0455 \text{ inch} \end{aligned}$$

Use: G.G. = 0.040 inch

Example Number 2

$$\begin{aligned} E = 10.0 \times 10^6 \text{ PSI} \quad \sigma_{\max} &= 10,000 \text{ PSI} \quad \epsilon_{\max} = 1000 \mu\epsilon \\ \sigma_{\min} &= 0 \text{ PSI} \quad \epsilon_{\min} = 0 \mu\epsilon \\ \Delta\epsilon &= 1000 \mu\epsilon \end{aligned}$$

Determine gage spanning length (L)

As stated in statement number 7:

$$\begin{aligned} L &\geq 0.002 / \Delta\epsilon = 0.002 / 0.001 \\ &\geq \quad \quad \quad = 2 \end{aligned}$$

Use : L = 3 inches

Determine installation gage gap (G. G.)

As stated in statement number 12:

$$\text{G.G.} \leq K - \epsilon_{\max}(L)$$

where K = 0.056 inch

ϵ_{\max} = 0.0010 in/in

L = 3.0 inches

G. G. = Gage Gap

$$\begin{aligned} \therefore \text{G.G.} &\leq 0.056 - 0.0010 (3.0) \\ &\leq 0.053 \end{aligned}$$

Use: G.G. = 0.050 inch

AFFDL-TR-69-25

Example Number 3

$$\begin{aligned} E &= 10.0 \times 10^6 \text{ PSI} & \sigma_{\max} &= 35,000 \text{ PSI} & \epsilon_{\max} &= 3500 \mu\epsilon \\ & & \sigma_{\min} &= 30,000 \text{ PSI} & \epsilon_{\min} &= 3000 \mu\epsilon \\ & & \Delta\epsilon &= 500 \mu\epsilon \end{aligned}$$

Determine gage spanning length (L)

As stated in statement number 7:

$$\begin{aligned} L &\geq 0.002 / \Delta\epsilon = 0.002 / 0.0005 \\ &\geq & &= 4 \end{aligned}$$

Use: L = 6 inches

Determine installation gage gap (G. G.)

As stated in statement number 12:

$$\text{G.G.} \leq K - \epsilon_{\max}(L)$$

where K = 0.056 inch
 $\epsilon_{\max} = 0.0035 \text{ in/in}$
 L = 6 inches

$$\begin{aligned} \therefore \text{G.G.} &\leq 0.056 - (0.0035)6 \\ &\leq 0.035 \end{aligned}$$

Use: G.G. = 0.030 inch

Thus, the spanning gage length is directly dependent on the strain range, $\Delta\epsilon$, and the installation gage gap is directly dependent on the maximum tensile strain to be experienced, ϵ_{\max} . Consequently, a longer gage would be employed for a desired increase in sensitivity.

SECTION IX CONCLUSIONS

The program of individual aircraft tail number fatigue damage monitoring for fighter aircraft is considered as an illustration of potential system application of the Prewitt Scratch Gage.

An optimum system to accomplish fleet damage monitoring would rely on direct measurement of the complete cyclic strain history at the critical location. An alternate approach would be to sense strains at remote locations and to convert these into critical values with appropriate transfer functions. Each of these schemes requires a maximum of instrumentation, costly maintenance, and data reduction.

Current practice provides the capability of calculating damage through a parametric fatigue analysis. Such an analysis depicts damage accumulation rates in terms of basic environmental mission parameters (gross weight, velocity, stores configuration, load level, etc) for various mission segments (taxi, take-off, cruise, etc).

The results of Reference 2 suggest that for fighter aircraft it is necessary to monitor only the normal load factor during the combat phase of the mission. Knowledge of this single parameter in combination with store, gross weight, and appropriate flight log data would lead to an accurate assessment of the major portion of the damage accumulated during the total mission. This implies, also, that a simple sensing device such as an accelerometer, or strain gage could, economically, be utilized in an individual aircraft life monitoring program.

The mechanical device summarized in this report could be utilized effectively in this respect either as a direct strain sensor mounted in the general vicinity of a fatigue critical location or as a load factor or event monitor attached to a remote but sensitive member (i. e. landing gear, stores pylon, etc)

Because threshold sensitivity (rotation) can be controlled during installation, the device could be used to record strain excursions above some preassigned level. The target could be left in place indefinitely with only periodic inspection required for overload. The disc may be retraced for many revolutions with no detrimental effect.

For fatigue life monitoring, automatic data reduction is envisioned, and it is suggested that the trace not be allowed to overlap. Target capacity is a direct function of the total strain excursions experienced and with careful consideration the amount of target utilized over a specific period might be the initial indication of the aircraft usage. Although not currently available, automatic disc interrogation equipment utilizing optical scanning principles could produce exceedance data for specified levels of strain. These results, when input into a fatigue damage computer program, could provide damage values for the period of life recorded on the disc.

The Prewitt Scratch Gage has been installed on an AF fighter aircraft to evaluate its recording capabilities under conditions of actual flight. Preliminary results indicate that the gage can be expected to operate satisfactorily.

REFERENCES

1. Specifications For The Scratch Gage, Prewitt Associates, Lexington, Ky.
2. G. J. Roth, Parametric Fatigue Analysis of USAF Aircraft, AFFDL-TR-67-89, 1967.

Contrails

UNCLASSIFIED

Security Classification

DOCUMENT CONTROL DATA - R & D

(Security classification of title, body of abstract and indexing annotation must be entered when the overall report is classified)

1. ORIGINATING ACTIVITY (Corporate author) Air Force Flight Dynamics Laboratory (FDTR) Wright-Patterson Air Force Base, Ohio 45433		2a. REPORT SECURITY CLASSIFICATION UNCLASSIFIED	
		2b. GROUP N/A	
3. REPORT TITLE SCRATCH STRAIN GAGE EVALUATION			
4. DESCRIPTIVE NOTES (Type of report and inclusive dates) Summary report covering work effort conducted from October 1968 to January 1969			
5. AUTHOR(S) (First name, middle initial, last name) Haglage, Theodore L. Wood, Howard A.			
6. REPORT DATE June 1969	7a. TOTAL NO. OF PAGES 44	7b. NO. OF REFS 2	
8a. CONTRACT OR GRANT NO.	9a. ORIGINATOR'S REPORT NUMBER(S) AFFDL-TR-69-25		
b. PROJECT NO. 1467			
c. Task No. 146704	9b. OTHER REPORT NO(S) (Any other numbers that may be assigned this report)		
d. Work Unit No. 146704 006			
10. DISTRIBUTION STATEMENT This document has been approved for public release and sale; its distribution is unlimited.			
11. SUPPLEMENTARY NOTES		12. SPONSORING MILITARY ACTIVITY Air Force Flight Dynamics Laboratory Air Force Systems Command Wright-Patterson Air Force Base, Ohio 45433	
13. ABSTRACT <p>The test results on the evaluation of the Prewitt Scratch Strain Gage are presented in this report. The test program was twofold: (1) observation of the gage operation under various strain applications and (2) investigation of strain recording sensitivity and measurement.</p> <p>The scratch strain gage as tests indicated is a feasible and accurate means of recording strains of a character and magnitude expected to be found in a typical aircraft structure. The recording sensitivity is controlled by proper installation techniques and gage length. For the laboratory conditions reported, the measured strains were equivalent to the electrical resistance gages within 100 $\mu\epsilon$.</p>			

Contrails

UNCLASSIFIED

Security Classification

14. KEY WORDS	LINK A		LINK B		LINK C	
	ROLE	WT	ROLE	WT	ROLE	WT
Strain Gage						
Strain Recorder						
Fatigue						
Optical Strain Gage						

UNCLASSIFIED

Security Classification