

**EFFECT OF FLASHES OF LIGHT ON NIGHT VISUAL ACUITY**

**GLENN A. FRY  
MERRILL J. ALLEN**

**THE OHIO STATE UNIVERSITY RESEARCH FOUNDATION**

**NOVEMBER 1951**

**WRIGHT AIR DEVELOPMENT CENTER**

FOREWORD

This report was prepared by the Ohio State University Research Foundation, Columbus 10, Ohio, under United States Air Force Contract No. AF 33 (038) 15630, E. O. No. 696-67, Aircraft Visual Requirements. The work was sponsored by the Aero Medical Laboratory, Wright Air Development Center, with Lt Colonel Elwin Marg acting as project engineer. This report is the final report of this contract.

WADC TR 52-10, Part 2

# Contrails

## ABSTRACT

The investigators have attempted to work out a method and to acquire the necessary data for predicting the course of constriction of the pupil of the dark adapted eye produced by a flash of any duration or a series of flashes involving a complex changing distribution of brightness in the field of view. To do this one must know the distribution of luminance in the field of view and figure out how the impulses initiated in rods and cones in different parts of the retina summate both with respect to space and time to determine the pupil response.

Records have been obtained of pupil responses to bright circular patches varying in diameter from 0 to 8°, representing levels of retinal illuminance ranging from 0 to 147,000 trolands and varying in duration from 0 to 3 seconds. Pupil responses have also been recorded for stimuli located at various distances from the point of fixation. The responses to two alternating stimuli have also been studied as well as the effect of exposing the bright patch so that its image falls on the optic nerve head. Care has been taken to see that these responses represent the response of the dark adapted eye.

In the case of the dark adapted eye, stimuli applied to the central portion of the retina or at points away from the center varying up to about 35° are about equally effective in producing the pupil response. By varying either area or intensity of stimulation it is possible to reach a limit beyond which the pupil cannot be made to constrict further. At intermediate levels, the pupil response is a function of the product of intensity and time within an interval of 0.2 second. For areas up to 8° the pupil response is a function of the product of area and intensity.

Further experimentation will be necessary to determine the precise role played by the regions of the retina directly stimulated and the elements in the remainder of the retina which are stimulated with stray light. Until this aspect of the problem is straightened out it will not be possible to formulate an adequate account of what happens when the duration is varied beyond a tenth of a second. Up to this duration the pupil response is a product of the intensity and time.

## PUBLICATION REVIEW

Manuscript copy of this report has been reviewed and found satisfactory for publication.

FOR THE COMMANDING GENERAL:



ROBERT H. BLOUNT  
Colonel, USAF (MC)  
Chief, Aero Medical Laboratory  
Research Division

# Contrails

## TABLE OF CONTENTS

	Page
Section I	Introduction ..... 1
Section II	Apparatus ..... 7
Section III	Procedure in Obtaining a Record ..... 13
Section IV	Analysis of the Film Record ..... 13
Section V	Limitations of the Methods used for Recording Changes in Pupil Size ..... 14
Section VI	Subjects ..... 15
Section VII	Absence of Response to the Infrared Light Illuminating the Iris ..... 15
Section VIII	Results ..... 16
	A. Pupil Constrictions to Flashes of Various Areas and Brightnesses ..... 16
	B. Effects of Stimulating Different Areas of the Retina ..... 21
	C. The Role Played by Stray Light in Producing Pupil Responses ..... 21
	D. Effects of Varying Duration of the Flash upon the Response of the Pupil .. 24
	E. Recovery from a Flash ..... 29
Section IX	Summary and Conclusions ..... 32
	Bibliographical References ..... 34

# Contrails

## LIST OF ILLUSTRATIONS

Figure		Page
1.	Method of Integrating the Stray Light Produced by the Different Zones of a Bright Patch.....	3
2.	The Effect of Increasing the Size of a Circular Patch Upon the Distribution of Retinal Illuminance Outside the Retinal Image of the Patch Produced by Stray Light. ....	4
3.	Reeves' Data for Pupil Size as a Function of the Retinal Illuminance Produced by a Surface Subtending Nearly the Whole Field of View. ....	5
4.	Apparatus .....	8
5.	A Vertical Section Showing Part of the Apparatus in Fig. 4. ....	10
6.	The Part of the Apparatus Used for Recording Pupil Size. ....	12
7.	A Reproduction of a Strip of Film Showing a Record of Changes in Pupil Size. ....	14
8.	Pupil Responses to 3-sec Exposures of the Right Eye to an 8-degree Circular Patch Centrally Fixated and Producing Various Amounts of Retinal Illumination	17
9.	Pupil Responses to 3-sec Exposures of the Right Eye to Circular Patches of Brightness Centrally Fixated and Having Various Sizes and Producing Various Amounts of Retinal Illumination.....	18
10.	Analysis of the Data in Fig. 8 showing the Minimum Pupil Diameters Attained in Response to the Flashes.	19
11.	Analysis of the Data in Fig. 9 showing the Minimum Pupil Diameters Attained in Response to the Flashes.	19
12.	Pupil Responses to 3-sec Exposures of the Right Eye to a 1.12° Bright Circular Patch (147,000 trolands) Placed at Various Distances From the Fixation Point.	22
13.	Location of the 1.12° Patch Within the Blind Spot of Each Subject When Placed 16° to the Right of the Fixation Point. ....	23

# Contrails

## LIST OF ILLUSTRATIONS (Cont.)

Figure		Page
14.	The Effect of Suddenly Switching from One Patch to Another. Each Patch Produces a Retinal Illumination of 147,000 trolands. ....	25
15.	The Effect of Alternation From One Patch to Another. The Patches are the Same as the Ones Referred to in Fig. 14. The Beginning of this Record Occurs at the Middle of a Series of Alternations, and at the Middle of the Record the Stimulus Pattern was Switched from an Alternation of two Patches to an Intermittent Exposure of One Patch. ....	26
16.	Pupil Responses to Exposures of the Right Eye to an 8° Bright Circular Patch (1,470 trolands) Centrally Fixated for Various Durations. ....	27
17.	Analysis of the Data in Fig. 16 Showing the Minimum Diameters Attained in Response to the Flashes. ....	28
18.	The Recovery of the Pupil from Responses to 3-sec Exposures of the Right Eye to an 8° Centrally Fixated Patch at Various Brightness Levels. ....	30

# Contrails

## SECTION I

### INTRODUCTION

The ultimate objective of this study is to discover a satisfactory method of predicting the course of constriction of the pupil of a dark adapted eye when exposed to a flash of any duration or a series of flashes involving a complex and changing distribution of brightness in the visual field. This problem is quite complicated for several reasons. It involves the differential distribution of rods and cones over the retina with their independently varying states of adaptation and speeds of reaction. It involves the distribution of ganglion cells and their connections through the bipolars with the rods and cones. It involves the mechanism in the midbrain for summing the impulses received simultaneously from various areas of the retina and also the mechanism for summing impulses spread out in time; and it also involves the response of the sphincter muscle of the iris to the pattern of impulses relayed to it by the ciliary ganglion from the Edinger-Westphal nucleus.

Finally, the role played by stray light has to be taken into consideration and this is particularly important in the case of a bright patch subtending a small solid angle, and having a dark background. The small number of photoreceptors stimulated directly by the bright patch might well have a negligible effect upon pupil constriction in comparison with the effect produced by the thousands of photoreceptors which are stimulated only by the stray light in the eye.

One can analyze this aspect of the problem further by assuming that the effect of stray light in the eye can be computed from the Stiles-Holladay formula,<sup>1, 2, 3, 4</sup> according to which the retinal illuminance  $dI_v$  at a given point  $P'$  on the retina, produced by a bright patch subtending a small solid angle  $d\omega$  and displaced at an angle  $\theta$  from the line of sight  $OP$  which corresponds to the point  $P'$  on the retina, is given by the following equation:

$$dI_v = \frac{10 BA}{(57.3)^2} \left[ \frac{2 \mu \sin \theta \cos \theta}{\theta^2} \right] d\omega \quad (1)$$

provided  $\theta$  is expressed in radians and is larger than 0.035.  $A$  is the area of the artificial pupil in  $\text{mm}^2$ .  $B$  is the brightness of the patch in  $\text{c/m}^2$ .  $\psi$  is the angular displacement of the patch from the pupillary axis.  $I_v$  is measured in trolands and  $\omega$  in steradians.

In the experiments described in this report the beams of light entering the eye are restricted by artificial pupils normal to the axes of the beams, and since the circular patches exposed to the eye did not exceed  $8^\circ$  in diameter, it is satisfactory to assume that  $\cos \psi = 1$ .

# Contrails

From Eq. (1) it is possible to derive an equation for computing the illuminance  $I_V$  at  $P'$  on the retina produced by a circular patch, the center of which is at an angle  $\bar{\theta}$  from the line of sight OP. The circular patch is divided into zones concentric with P as shown in Fig. 1.

$$I_V = \frac{20 BA}{57.3^2} \int_{\bar{\theta}-\rho}^{\bar{\theta}+\rho} \frac{\mu \sin \theta}{\theta^2} d\theta \quad (2)$$

where

$$\cos \mu = \frac{\cos \rho - \cos \theta \cos \bar{\theta}}{\sin \theta \sin \bar{\theta}} \quad (3)$$

Values of  $I_V$  have been computed as a function of  $\bar{\theta}$  for circular patches subtending  $0.8^\circ$ ,  $2.64^\circ$  and  $8^\circ$ . These patches subtend solid angles equal to 0.000154, 0.00154 and 0.0154 steradians respectively.

Since Eq. (1) does not hold for values of  $\theta$  less than  $2^\circ$  (0.035 radian), values of  $I_V$  have not been calculated for values of  $\bar{\theta}$  less than  $(\rho + 2^\circ)$ . The distributions are shown in Fig. 2 along with the distributions of retinal illuminance ( $I$ ) in the images of the patches focused on the retina, calculated in accordance with the equation,

$$I = BA \quad (4)$$

where B is the brightness of the patch in  $c/m^2$  and A is the area of the pupil in  $mm^2$ .

Hess<sup>5</sup> has called attention to the role played by stray light by demonstrating that a pupil response is still obtained when the patch of brightness producing the response is placed in the blind spot.

Reeves<sup>6</sup> used a uniform distribution of brightness covering the entire visual field and measured the pupil size after the eye had become adapted to various brightness levels and after the pupil had reached a reasonably steady state. His averaged data for 6 subjects have been replotted in Fig. 3, which shows pupil size as a function of retinal illuminance. Equation (4) has been used in computing retinal illuminance. No allowance has been made for the Stiles-Crawford effect or the obliquity of the plane of the pupil. The pupil evidently responds to levels of retinal illuminance lower than the threshold for the cones<sup>7</sup>, but the measurements were limited to too few brightness steps to determine whether there is a break or modulation in the curve to indicate when the cones come into play.

Various investigators have found a Purkinje shift<sup>8</sup> in the pupilomotor response, which is another way of demonstrating the transition from rod to cone vision.



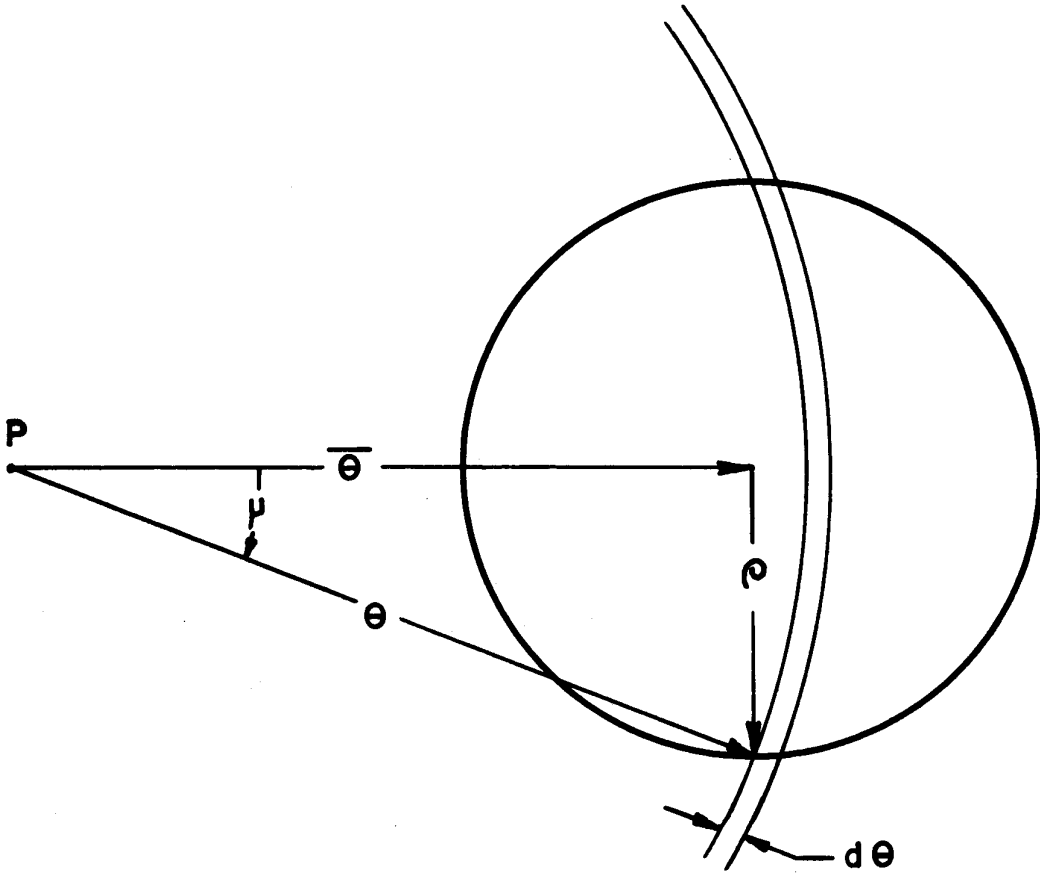

FIG. 1

Method of Integrating the Stray Light Produced by  
the Different Zones of a Bright Patch

WADC TR 52-10, Part 2 3

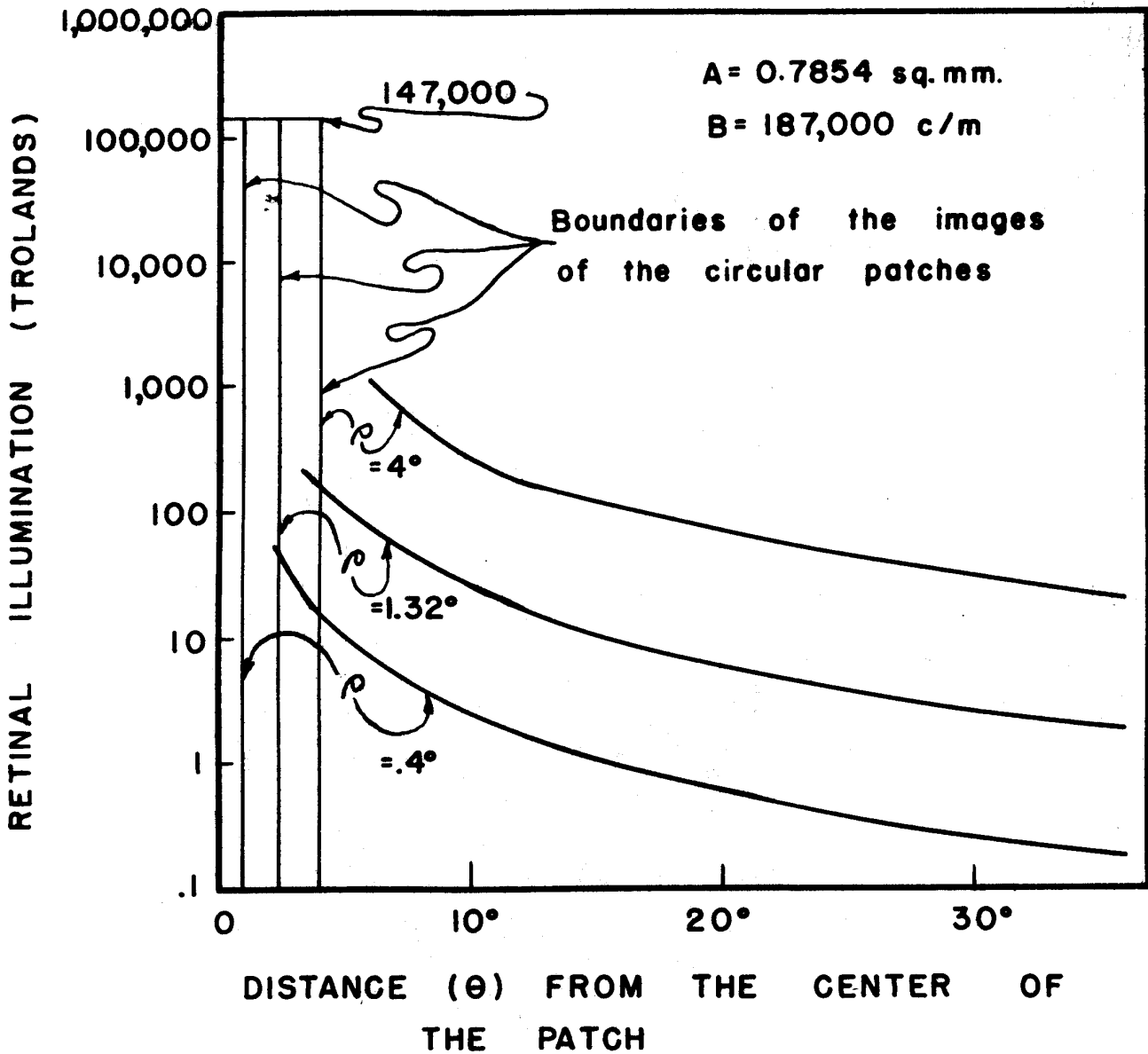

FIG. 2

The Effect of Increasing the Size of a Circular Patch Upon the Distribution of Retinal Illuminance Outside the Retinal Image of the Patch Produced by Stray Light.

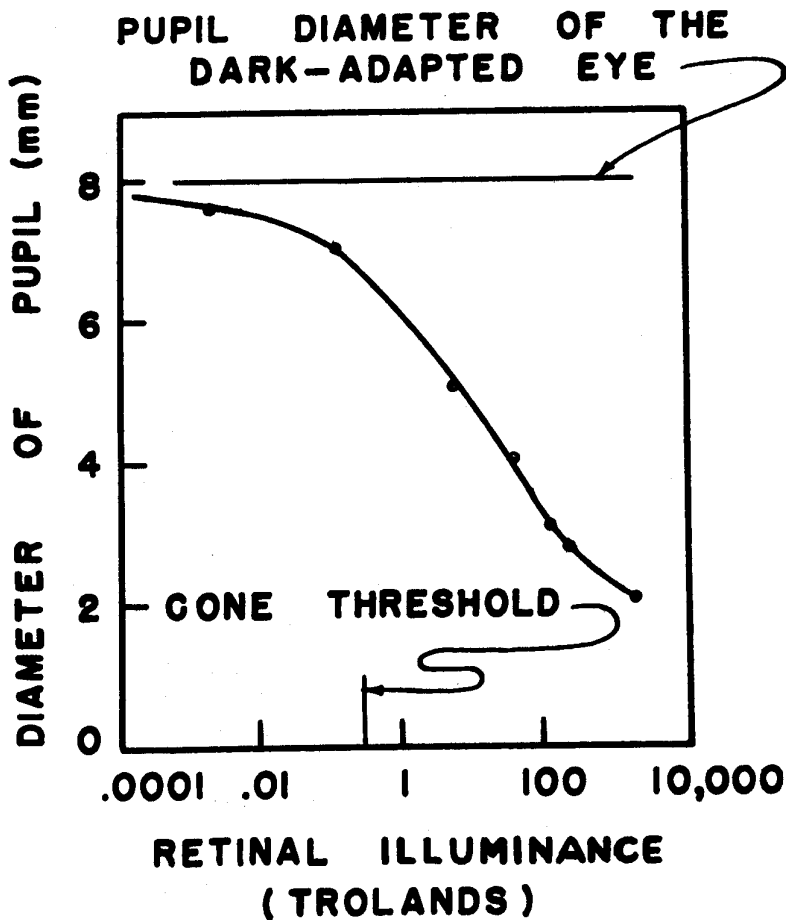

FIG. 3

Reeves Data for Pupil Size as a Function of the Retinal Illuminance Produced by a Surface Subtending Nearly the Whole Field of View.

# Contrails

Effects depending on the state of adaptation<sup>8</sup> have also been investigated.

Furthermore, a pupil response to rods can be demonstrated in the case of persons with total color blindness who have a scotopic luminosity curve.<sup>8</sup>

De Launey has used a spot 2° in diameter located at the center of the fovea and a similar spot located in the periphery to determine the extent of pupil constriction produced by various brightnesses. De Launey claimed that since no pupil response was obtained in either case until after the threshold level of the cones was reached, the pupil responses obtained depended entirely upon the stimulation of the cones.

As will be shown in this report, the response which he found must have been a response to stray light outside the image of the spot. That the threshold of the pupil response coincided with the threshold of cone vision must be a coincidence because the threshold of the pupil response can be varied by changing the area of the patch of brightness. What probably determines the threshold in this case is the threshold of the rods in the periphery of the retina which are stimulated by stray light.

# Contrails

## SECTION II

### APPARATUS

Fig. 4 represents a horizontal section through the center of the entrance pupil of the eye E. The right eye of the subject is controlled by means of a biting board and forehead rest so that the center of the pupil falls at the point E, while the eye fixates the small aperture  $A_1$  or  $A_7$ . Fixation point  $A_1$  is a small aperture backed up by a piece of milk glass and a red filter, and is illuminated by the source  $S_1$ . Through the lens  $L_1$  the eye sees the image of  $A_1$  formed by the mirror  $M_1$  in the plane of the diaphragm  $A_2$ . It is seen displaced  $5^\circ$  to the left of the center of the lens  $L_1$ .

The eye may also fixate the image of the small aperture  $A_7$  formed by the lenses  $L_7$  and  $L_3$  in the plane of the diaphragm  $A_2$ . The small aperture  $A_7$  is backed up by a piece of milk glass and red filter, and is illuminated by the source  $S_4$ . The light passes through the lens  $L_7$ , the small aperture  $A_6$ , the beam splitter  $P_2$  the lens  $L_3$ , and forms an image of  $A_7$  at the center of the aperture in diaphragm  $A_2$ . Diaphragm  $A_6$  constitutes the aperture stop for this system. An image of this aperture is formed by the lenses  $L_3$  and  $L_1$  in the plane of the entrance pupil which is the same size as the 1 mm aperture.

The apparatus provides two means of exposing bright patches to the eye. One makes use of source  $S_3$  and the other of  $S'_3$ . The light from source  $S_3$  passes through the lenses  $L_5$  and  $L_6$  and  $L_4$  and focuses at the small aperture in the diaphragm  $A_4$ . This small aperture is 1 mm in diameter and constitutes the aperture stop of the system. A 1 mm image of this aperture stop is formed by lens  $L_3$  and lens  $L_1$  in the plane of the entrance pupil.

When the diaphragm  $A_5$  is removed, the entire field of the circular aperture in diaphragm  $A_2$  appears uniformly bright to the eye and subtends a visual angle of  $8^\circ$ . The diaphragm at  $A_5$  can be used to restrict the size of the patch. An image of the aperture  $A_5$  is formed in the plane of the diaphragm  $A_2$ , and this image can be centered in the aperture in the diaphragm  $A_2$  or displaced to the right or to the left of the center by any amount desired.

Several diaphragms are used at  $A_5$  representing apertures of different sizes, and one of these diaphragms contains a pair of apertures one above the other. Each subtends  $0.8^\circ$  visual angle, and they are separated by  $1.6^\circ$  from center to center. These two patches can be exposed alternately by manually moving a shutter blade, located just in front of the diaphragm, which occludes first one and then the other of the two apertures. This shutter blade can also be used to produce intermittent exposure or a prolonged exposure of one of the patches.



# Contrails

When this manual shutter is being used to expose the patches in this particular diaphragm, the rotating sector disk  $B_2$  is lifted out of the path of the beam from  $S_3$  and the electromagnetic shutter  $B_1$  is kept open.

While using the electromagnetic shutter  $B_1$  by itself to control exposures, the rotating disk shutter  $B_2$  is lifted out of the path of the beam. The electromagnetic shutter  $B_1$  when acting alone can be made to provide exposures of 100, 300, 1000 and 3000 milliseconds by throwing the appropriate selector switch. The shutter  $B_1$  and the rotating disk  $B_2$  are synchronized so that the two in combination can be made to provide exposures of 1, 3, 10 and 30 milliseconds. When the two are used together, the onset of the exposure occurs 50 milliseconds after the electromagnetic shutter opens.

The diaphragm at  $A_2$  can be positioned so that the center of the image of its aperture coincides with the image of  $A_6$ , which is the fixation point, or as in one experiment it can be displaced so that the center of the image of the aperture in  $A_2$  will fall  $3^\circ$  to the right of the image of  $A_6$  or again at  $6^\circ$  to the right of the image of the fixation point  $A_1$ .

The neutral filters  $F_1$  and  $F_2$  control the amount of light reaching the eye from  $S_3$ .

For peripheral stimuli at greater angular distances from the principal line of sight than  $6^\circ$ , a special device was used which involved the fixed mirror  $M_3$  and an optical system swinging about a vertical axis through the point  $E'$ , which is the mirror image of the point  $E$ . A vertical section of this system along the axis  $XX$  is shown in Fig. 5. Light from the source  $S'_3$  is focused by a lens  $L'_5$  at the 1-mm aperture in the diaphragm at  $A'_4$ . This aperture constitutes the aperture stop of the system. An image of this aperture stop is formed by the lenses  $L'_3$  and  $L'_4$  and the mirror  $M_3$  at the center of the entrance pupil of the eye,  $E$ . The Porro prism  $P_3$  reflects the light back toward  $E'$ . An image of the aperture stop at  $A'_4$  would focus at  $E'$  were it not for the fixed mirror  $M_3$  which causes the image of the aperture  $A'_4$  to be formed at the center of the entrance pupil. It has the same size as the aperture  $A'_4$ .

The advantage of this mirror arrangement is that as the optical system swings around  $E'$  it gives peripheral stimuli at various angular distances from the point of fixation, and the beam directed toward the eye always passes exactly through the center of the entrance pupil. The aperture  $A'_2$  limits the diameter of this peripheral patch to 1 degree, 7 minutes. A filter  $F_4$  with a transmission of 0.07 was used to give the brightness of the peripheral patch the same value as the maximum value of the patch of brightness provided by  $S_3$ , namely 147,000 trolands. The electromagnetic shutter  $B'_1$  can be controlled by the same timing mechanism as the shutter  $B_1$ .

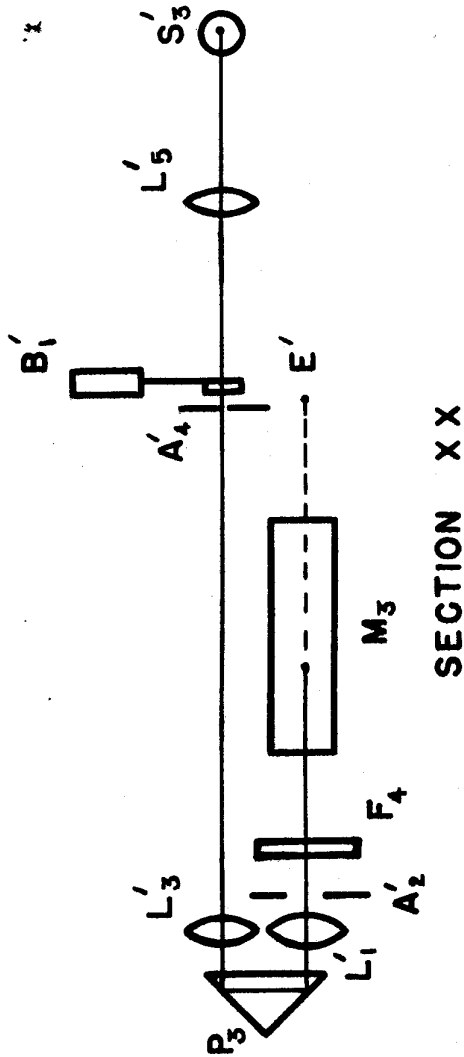

FIG. 5

A Vertical Section Showing Part of the Apparatus in Fig. 4.



# Contrails

The system used for recording the changes in pupil size is illustrated in Fig. 6. This system is incorporated as part of the instrument described above. The aperture  $A_2$ , the lens  $L_1$ , and the point  $E$  which represents the center of the entrance pupil, are identical with the elements indicated by the same symbols in Fig. 4. The ribbon filament  $S_5$  is mounted in a light-tight lamp house from which the light emerges through the infrared filter  $F_3$  and the lens  $L_8$ . This filter consists of two layers of film produced by the Polaroid Corporation and is designated XR7X25; its properties have been described elsewhere.<sup>10</sup> The light emerging from the lens  $L_8$  is reflected at the mirror  $M_4$  which is below and in front of the eye, and a horizontal image of the ribbon filament is formed in the plane of the entrance pupil of the eye which illuminates the opposite margins of the iris. The lens  $L_9$ , located in front of the eye and below the line of sight, collects the light from the iris and collimates it. This light is reflected by  $M_5$  to the objective  $L_{10}$  which focuses an image of the pupil in the plane of the slit in the diaphragm  $A_7$ , with the slit dividing the image of the pupil into upper and lower halves. The image is 1.06 times as large as the entrance pupil of the eye. The slit is parallel to and lies in the plane containing  $L_{10}$ ,  $M_5$  and  $E$ , and the film moves perpendicularly to the direction of this slit. As the film moves behind the slit the horizontal diameter of the pupil registers as a dark band on the film (See Fig. 7), varying in width depending upon the diameter of the pupil. The neon source which has the form of a small rod is focused by the glass rod as a narrow line on the edge of the film. The neon source is synchronized with the shutters so that one can tell on the film where the onset of the exposure occurred.

In the experiments involving exposures of long duration, intermittent exposure and alternating exposure of two bright patches, one hand was used to manipulate the shutter controlling the bright patch, and the other hand manipulated a switch controlling the neon source. In this way the beginning and end of an exposure or the alternation from one patch to another could be roughly indicated on the film.

The film used was Eastman Infrared Film 104, the characteristics of which have been described elsewhere.<sup>11</sup>

An electronic circuit was devised whereby the mechanism controlling the electromagnetic shutters  $B_1$  and  $B'_1$  also controls the starting and stopping of the camera motor.

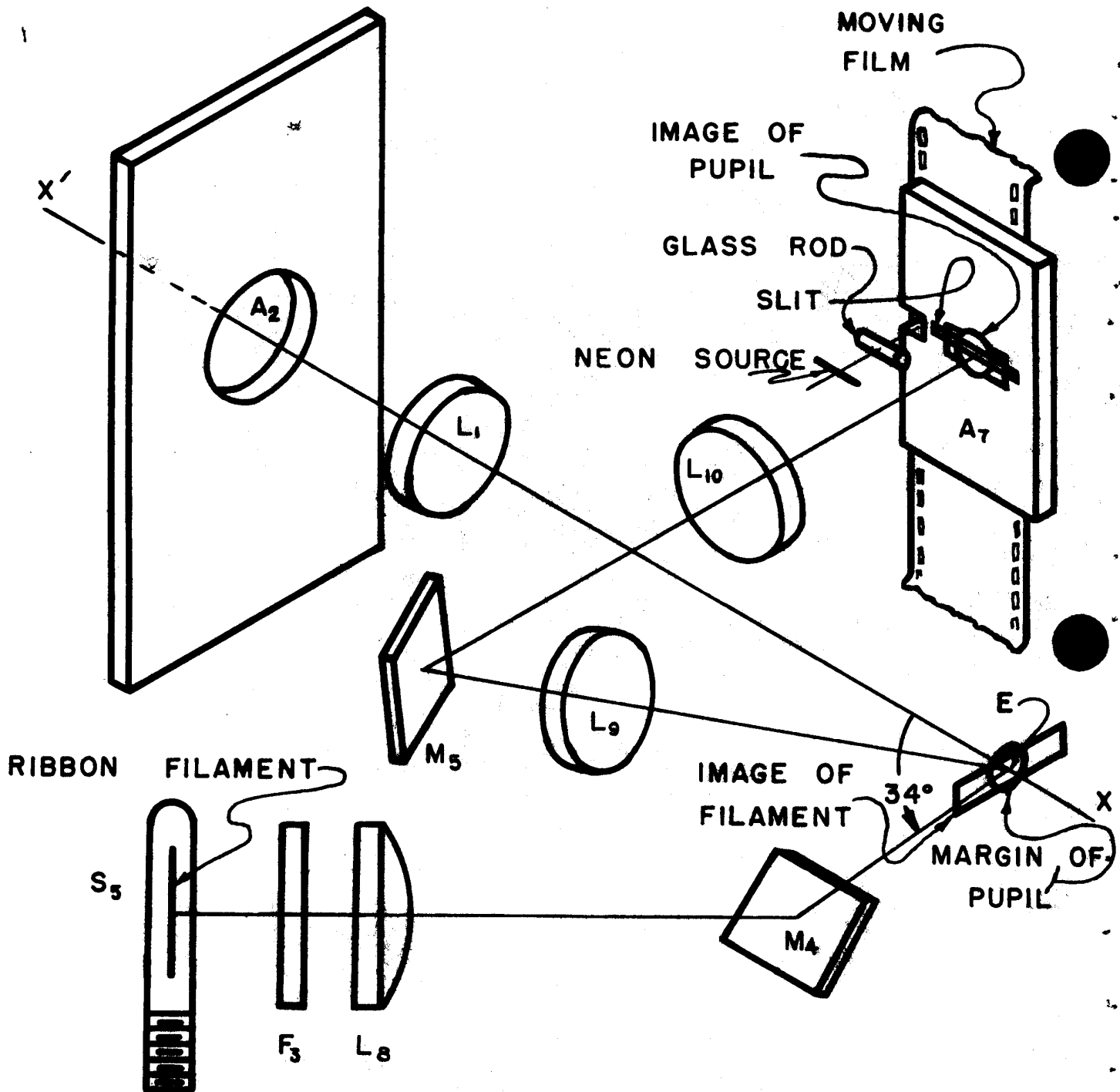

FIG. 6

The Part of the Apparatus Used for Recording Pupil Size.

# Contrails

## SECTION III

### PROCEDURE IN OBTAINING A RECORD

During a recording of pupil size the subject sits with his head in position and his eyes open and fixating the image of A<sub>1</sub> or A<sub>7</sub>.

The first step in making a record is to push a switch which turns on the infrared source. Then a pair of switches are thrown, one turning on the source S<sub>3</sub> or S'<sub>3</sub> and the other turning on the motor which operates the driving and timing mechanism. Then two more switches are thrown at the same time, one of which starts the camera motor while the other operates the electromagnetic shutter B<sub>1</sub> or B'<sub>1</sub> which gives an exposure of a predetermined length. The camera motor starts prior to the exposure and is operating at full speed when the flash comes. The camera motor normally operates for four seconds following the onset of the flash in order to record in full the first four seconds of the response; thereafter the camera operates for a short run at the end of each four seconds, so that at four second intervals following the flash the size of the pupil is recorded. In this way the decay of the constriction can be traced back to normal over a considerable period of time without using a great deal of film. However, by simply holding a pushbutton switch closed it is possible to prolong the initial continuous run of the motor from 4 seconds to 8 or 12, or 16 seconds, etc.

## SECTION IV

### ANALYSIS OF THE FILM RECORD

The record on the film (Fig. 7) consists of a variable band down the center of the film which indicates the width of the pupil as a function of time. The onset of the flash is indicated by a short line at the edge of the film produced by the time marker. In the case of an exposure of long duration, or intermittent exposure, or alternating exposures of two patches, time marks are made on the film to indicate both the beginning and the end of the exposures or the alternations from one patch to the other.

For analyzing the data, use was made of a device constructed in this laboratory for analyzing binocular eye movement records to determine the changes in convergence. Essentially what this device does with a film record of changes in pupil size is to transcribe the data to the form of a single curve on a sheet of paper which indicates the changes in pupil size as a function of time. The curves presented in this report are direct traces of the transcribed data. Two different scales for pupil diameter have been used in transcribing the data. The use of two scales serves no useful purpose and was not intended at the outset.

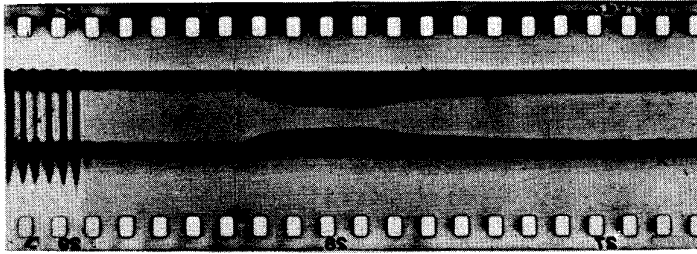

Fig. 7. A Reproduction of a Strip of Film Showing a Record of Changes in Pupil Size

## SECTION V

### LIMITATIONS OF THE METHODS USED FOR RECORDING CHANGES IN PUPIL SIZE

In order to get a record with enough contrast to be of any use it was necessary to increase the width of the slit to 0.75 mm and to slow down the rate of movement of the film to 11.5 mm per second. Hence, each element of length of the film was given an exposure of 0.065 seconds. The width of the band at any point on the film therefore is an integration of changes occurring within this period of time. In order to measure precisely the beginning of a constriction, the duration of exposure for each element of length of the film should be of the order of a hundredth to a thousandth of a second. Consequently the method as it stands does not represent all that might be desired; it would help to have a more intense source, a more suitable filter or a higher speed film.

Another limitation is the occurrence of blinks just as the pupil constriction gets under way; when such a blink occurs, it interferes with the record. For most purposes, however, records can be used in spite of the occurrence of the blink, particularly if attention is to be concentrated on the minimum size that the pupil attains as a result of the exposure.

# Contrails

## SECTION VI

### SUBJECTS

Two subjects were used in this experiment. One is a graduate student of Physiological Optics and the other is a senior student in the School of Optometry. P. H. is 23 of age and L. Z. is 39 years of age. L. Z. wore a correcting lens (+.25-.50 x 10) in front of his right eye during the experiment for the correction of his ametropia. P. H. requires a -.50 sph. but wore no prescription. The correction does not interfere either with the presentation of the flash sources or the recording of the pupil size.

## SECTION VII

### ABSENCE OF RESPONSE TO THE INFRARED LIGHT ILLUMINATING THE IRIS

The ribbon filament  $S_5$ , the infrared filter  $F_3$ , the lens  $L_8$  and the mirror  $M_4$ , (See Fig. 6) present to the eye a patch of infrared light ( $9^\circ$  in diameter) which is bounded by the edge of lens  $L_8$ . The image of this patch formed by the mirror  $M_4$  is seen in a direction below the center of the aperture  $A_2$ . The visual angle separating the centers of  $L_8$  and  $L_1$  is  $34^\circ$ .

The filter  $F_3$  used to screen out visible light from the infrared transmits light at the extreme red end of the visible spectrum so that the subject in this experiment is aware of a faint red patch in the lower part of the field. In order to test whether this red light can produce a pupil constriction, the film in the camera was set in motion and the source  $S_5$  was turned on for a short period. In neither of the subjects was there any significant change in pupil size following the onset of the infrared source.

# Contrails

## SECTION VIII

### RESULTS

#### A. Pupil Constrictions to Flashes of Various Areas and Brightnesses.

The results considered in this section pertain to patches of brightness  $0.8^\circ$ ,  $2.64^\circ$ , and  $8^\circ$  in diameter, centrally fixated, and exposed for 3 seconds. The solid angles subtended are 0.000154, 0.00154 and 0.0154 steradians, respectively.

The series of records for subject P. H. for flashes of various brightnesses shown in Fig. 8B were all made at one sitting, one after the other in the order from low to high brightnesses, with enough time allowed between exposures to permit the return of the pupil to normal and also to permit the retina to return back to its state of dark adaptation. The subject was placed in darkness for a period of 30 minutes prior to the experiment.

The records in Fig. 9I and 9J for P. H. for 3-second exposures of patches of different size and at two different brightness levels were all made at one sitting. The first record made was for the lowest brightness and smallest area. This was followed by records at the same brightness level but for the medium and large areas. The same procedure was repeated at the next brightness level.

The records in Figs. 9A to Figs. 9H for L. Z. were all obtained in one sitting using exactly the same procedure. The records for L. Z. in Fig. 8A are the same as the records for L. Z. for the  $8^\circ$  patch presented in Fig. 9.

Fig. 10, which is based upon the data in Fig. 8A and 8B, shows the relationship between the brightness of the patch and the minimum size that the pupil attains in response to it. The unusually large response for P. H. at 1.47 trolands is not consistent with the rest of the responses. The experimenter could have used the wrong filter, but there was no way of checking up on this possibility. This is the only point at which this sort of deviation occurs.

Fig. 11, which is based on the data for L.Z. in Fig. 9, shows the relationship between the brightness of the flash and the minimum size that the pupil attains in response to it for three different patch sizes.

The data in both Figs. 10 and Fig. 11 suggest that as the area and brightness are increased, an upper limit of pupil constriction is approached. The experiment should be extended to include at least one more log unit at the upper end of the brightness scale, as well as larger areas, in order to permit more definite conclusions to be drawn. If there

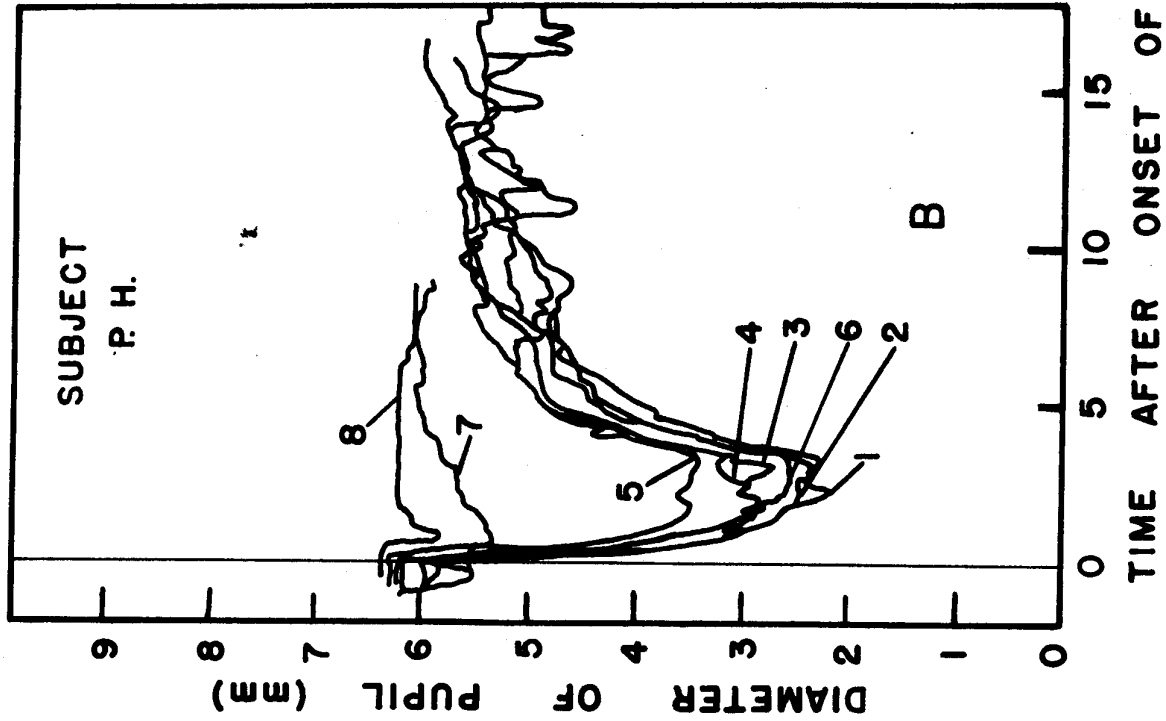
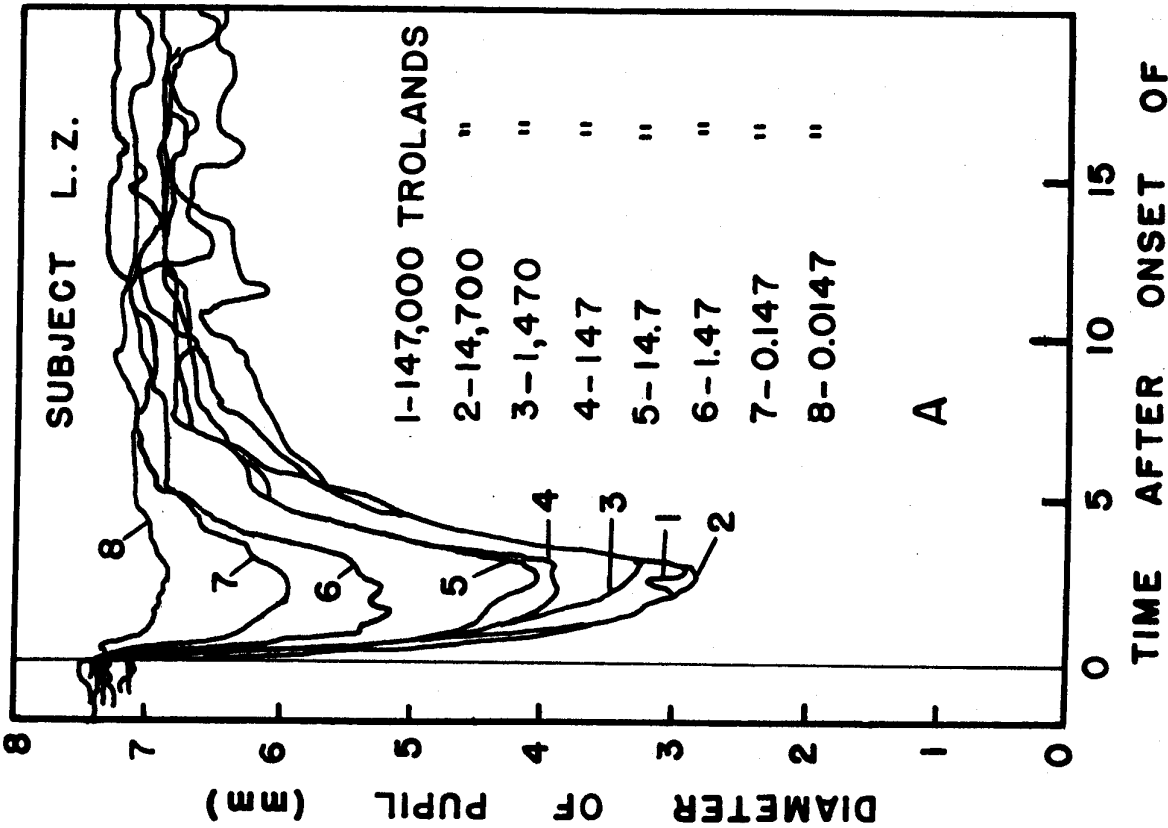

**FIG. 8**  
 Pupil Responses to 3-sec Exposures of the Right Eye to an 8-degree Circular Patch Centrally Fixated and Producing Various Amounts of Retinal Illumination.

*Contrails*

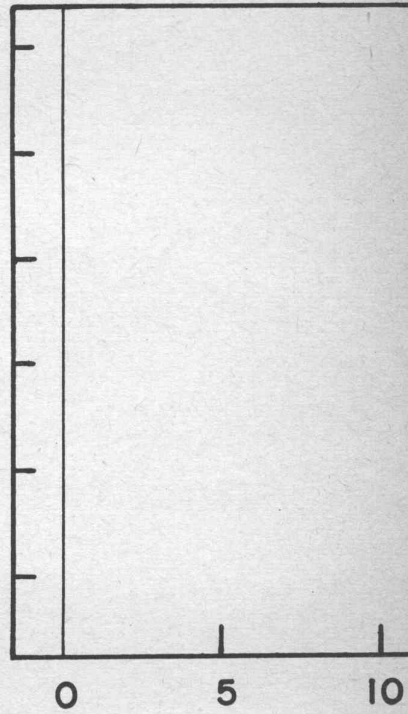
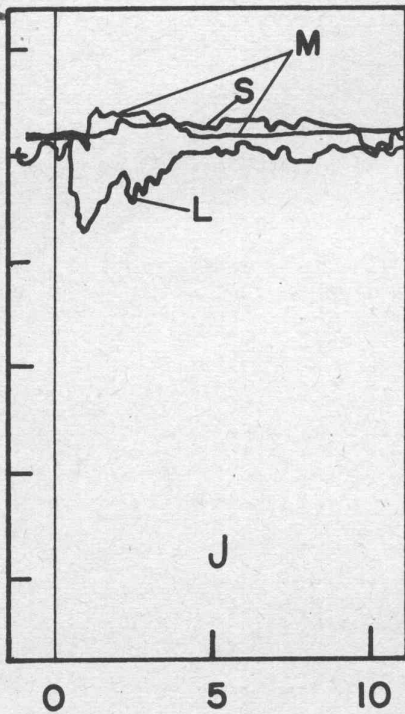
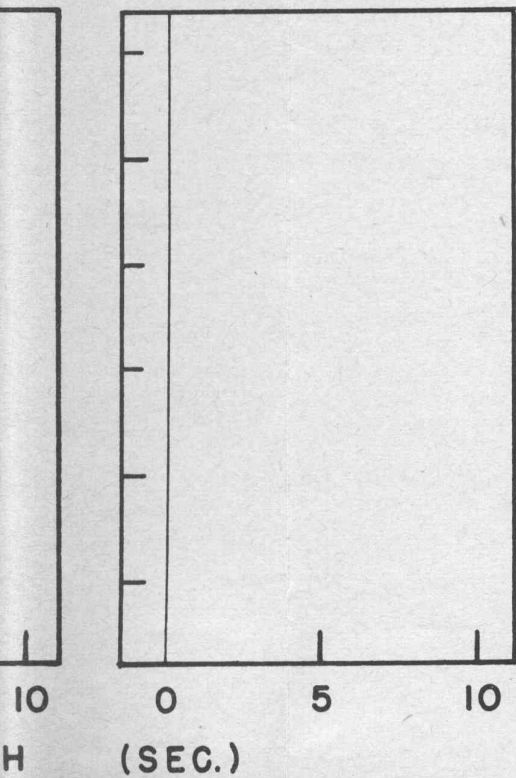
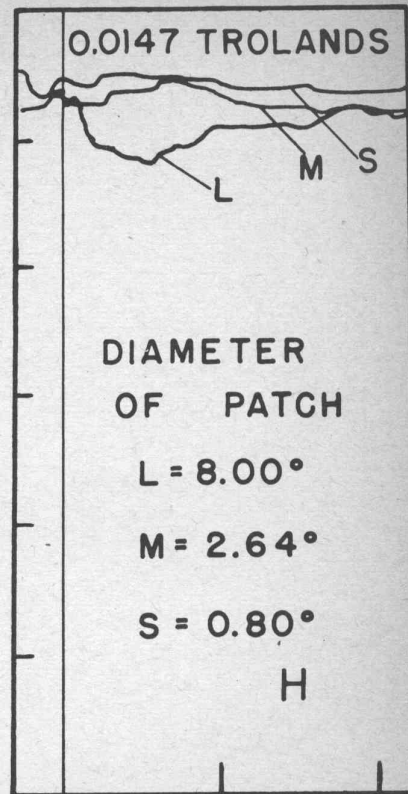
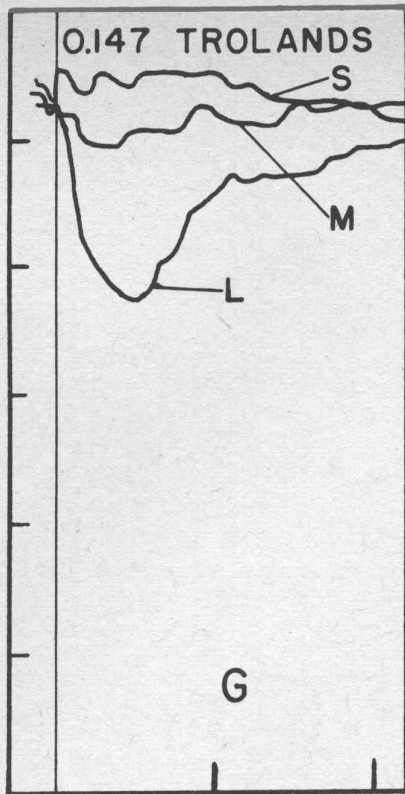
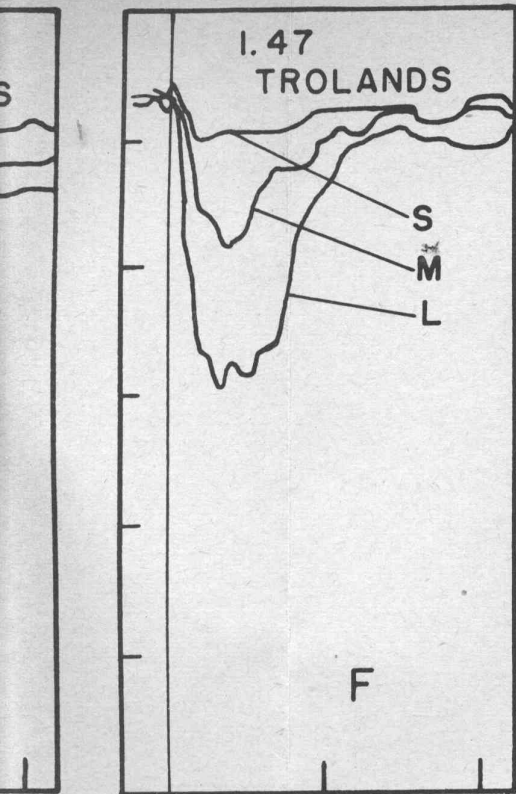

BRIGHTNESS PROFILES OF CONTRAILS CENTRALLY FIXATED AND



SUBJECT L.Z.

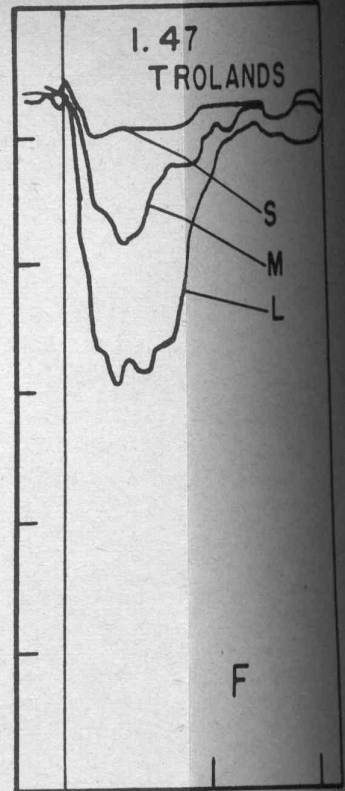
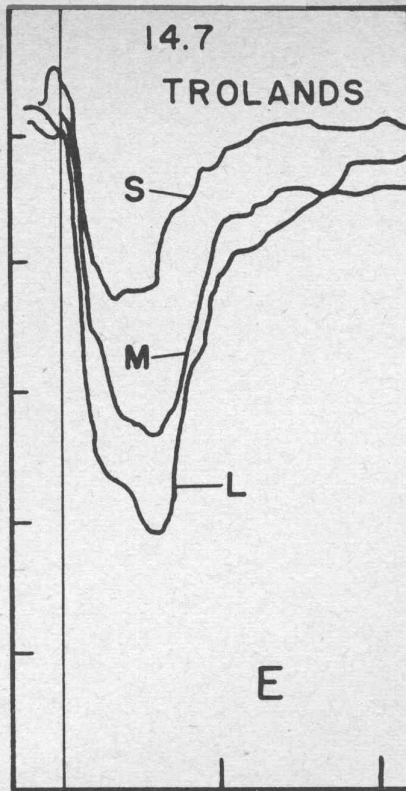
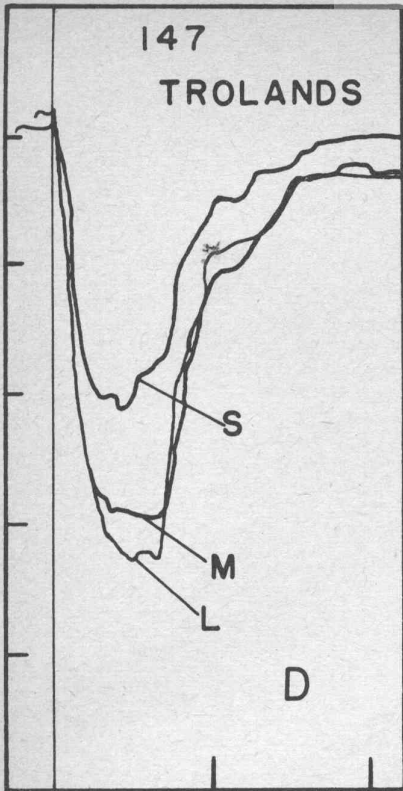
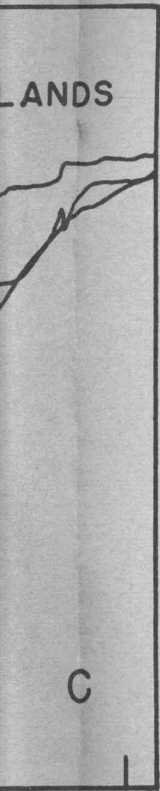

SUBJECT P.H.

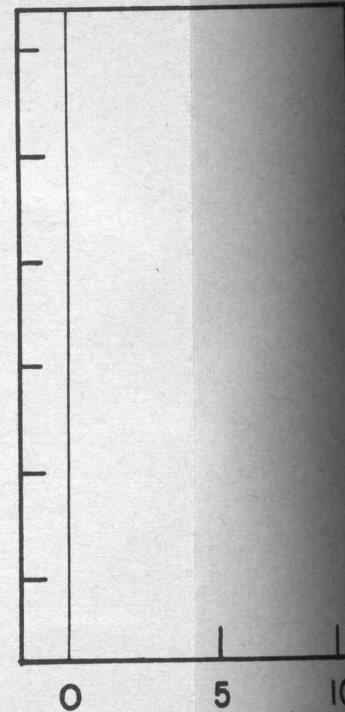
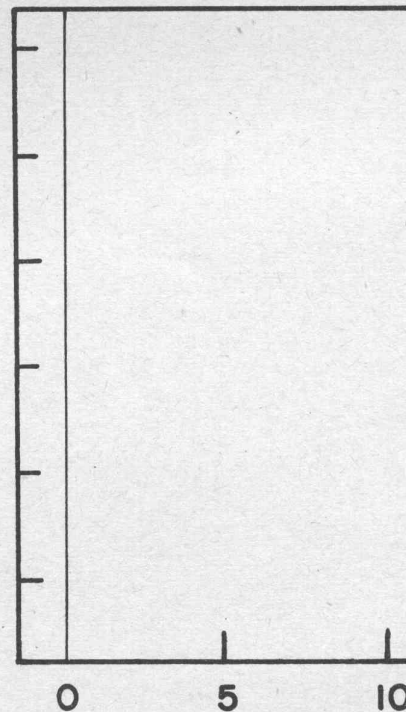
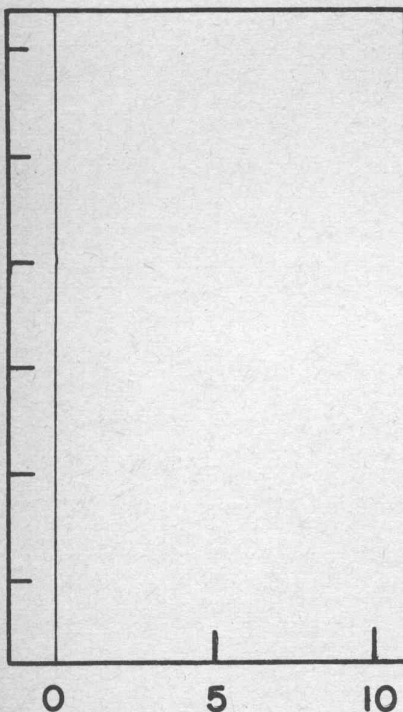
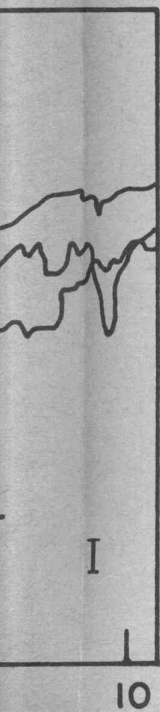

TIME AFTER ONSET OF FLASH (SEC.)

FIG. 9

OF THE RIGHT EYE TO CIRCULAR PATCHES OF BRIGHTNESS  
IOUS AMOUNTS OF RETINAL ILLUMINATION.

*Contrails*

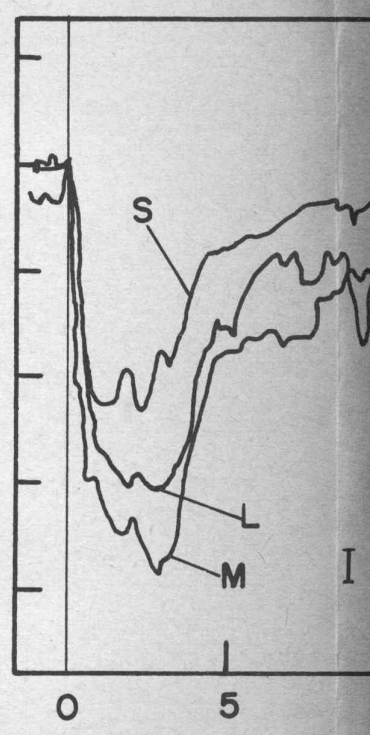
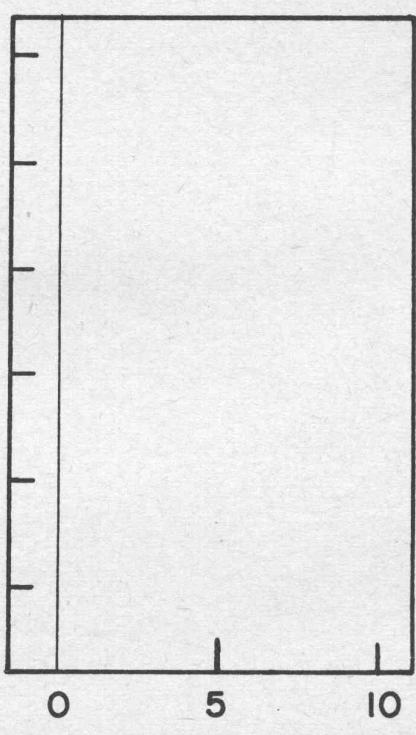
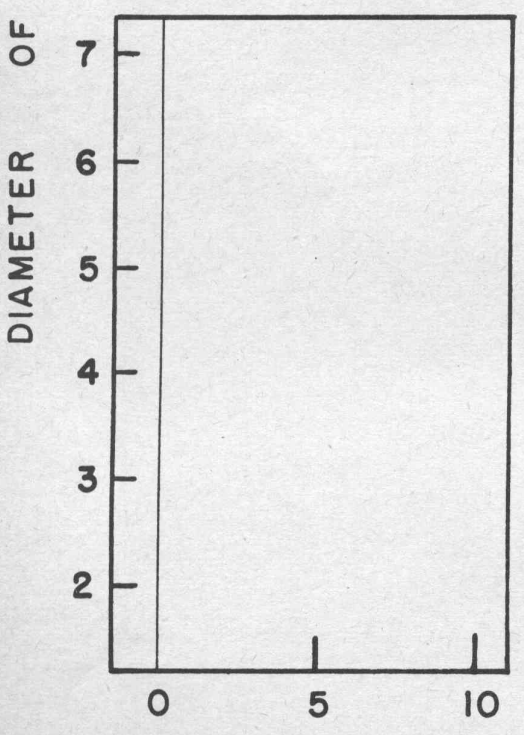
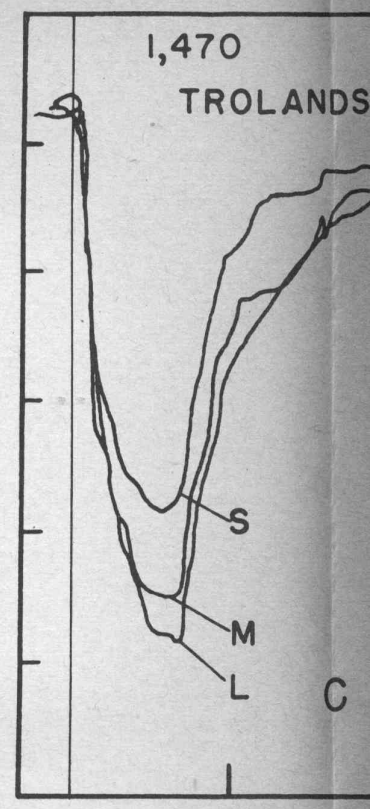
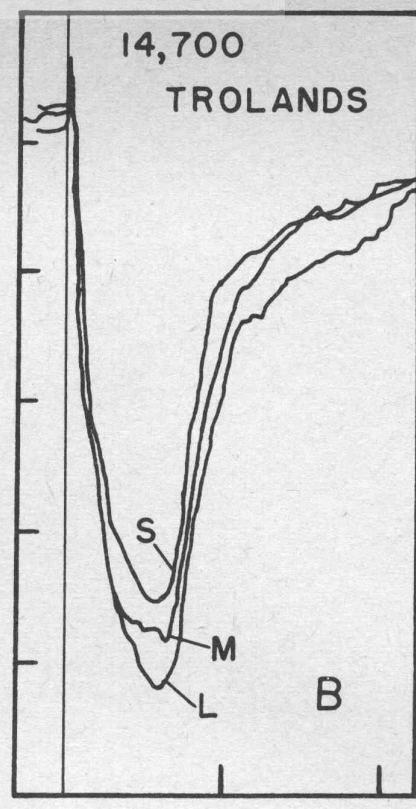
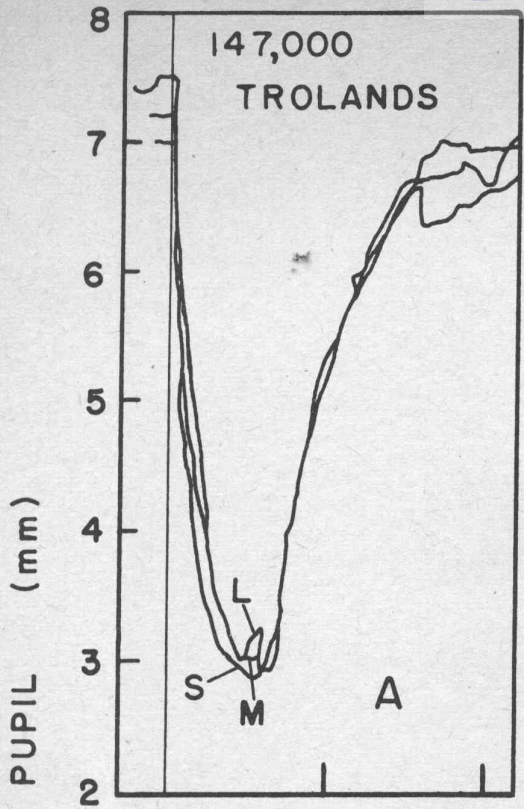

PUPIL RESPONSES TO 3 SEC. EXPOSURES OF HAVING VARIOUS SIZES AND PRODUCING VARIOUS

*Contrails*

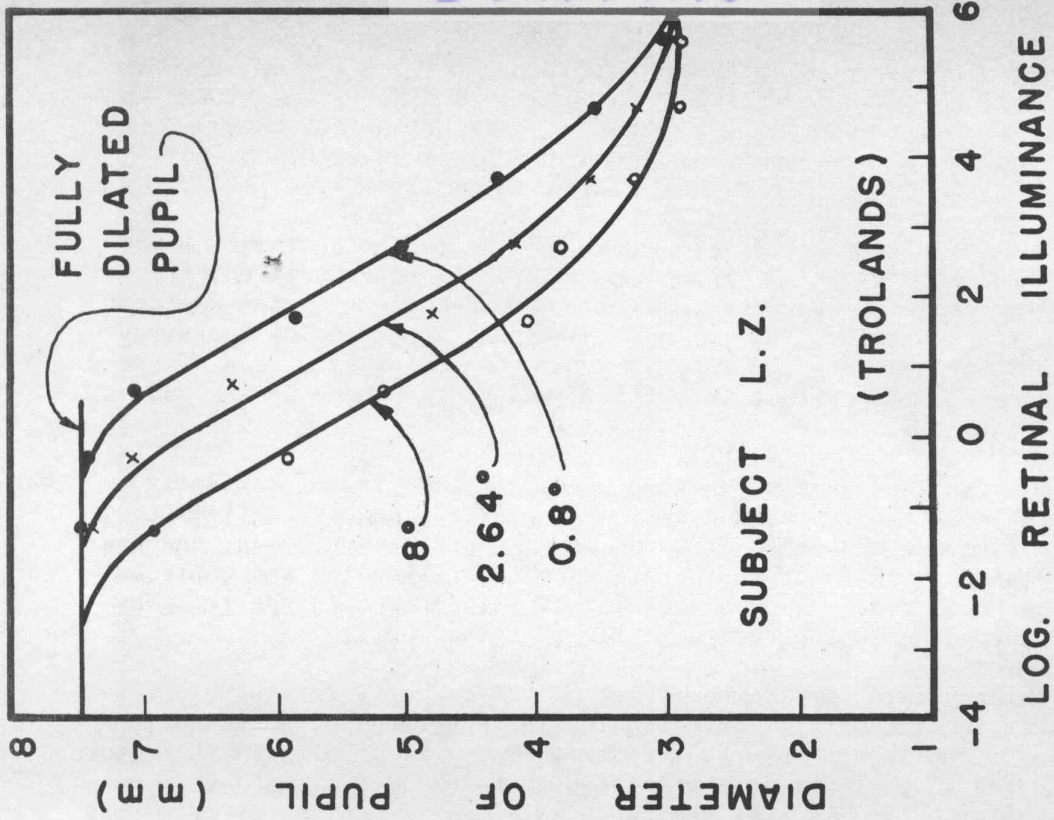

FIG. 11

Analysis of the Data in Fig. 9 showing the Minimum Pupil Diameters Attained in Response to the Flashes.

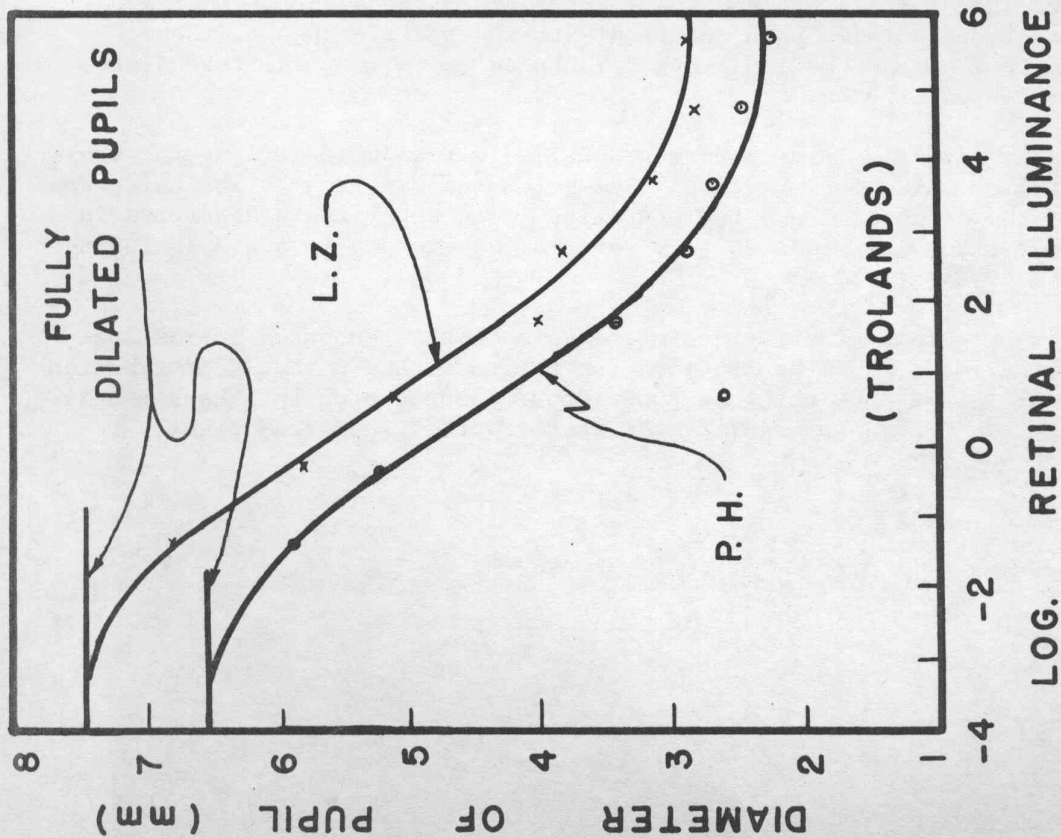

FIG. 10

Analysis of the Data in Fig. 8 showing the Minimum Pupil Diameters Attained in Response to the Flashes.

# Contrails

is a limit to pupil constriction it is probably in the muscle or in the motor centers rather than on the sensory side of the reflex. The maximum response is reached with an  $0.8^\circ$  patch producing a retinal illuminance of 147,000 trolands while, as indicated in Fig. 2, the stray light is only 10 trolands at a point  $5^\circ$  from the edge of the patch and drops to 1 troland at  $15^\circ$  from the edge of the patch. The maximum output of the retina is far from being reached under these conditions.

At the lower levels the responses from the medium and small areas disappear suddenly while the large area continues to produce an effect. This finding tends to support the idea that stray light is the dominant factor in the sense that the retinal illuminance produced by the stray light simply drops below the threshold for the rods in the case of the small and medium targets but is still above the threshold in the case of the large target.

It must be kept in mind, however, that an  $0.8^\circ$  target centrally fixated falls in the fovea, and a  $2.64^\circ$  target is largely confined to the fovea, whereas the image of an  $8^\circ$  patch contains many rods, and one must assume that the rods within this area are responding and contributing to the pupil response when the retinal illuminance in the image of the patch drops below the threshold level of the cones.

At intermediate levels the effect of varying area is equivalent to that of varying intensity. This finding is consistent with the notion that stray light is the important factor. There is nothing in the nature of the curves to indicate at any level a transfer of dominance from elements outside the image of the patch to elements inside, or from rods to cones.

If the high-frequency, low-latent-period response of the photoreceptors inside the image and the low-frequency, high-latent-period response of those outside both contribute to the pupil response, there should be some way of manipulating brightness and area to differentiate between the two effects.

If the size of the area were gradually increased to include the whole visual field, there must be a point at which the ganglion cells inside the image of the patch dominate the situation. The experiments described in this paper involving areas up to  $8^\circ$  should be extended to areas including the whole visual field.

Another method of differentiating between the responses inside and outside the image would be to flood the retina with a uniform distribution of retinal illuminance and then superimpose flashes upon this background. The background could be made to mask the effect of the stray light.

## B. Effects of Stimulating Different Areas of the Retina.

The records shown in Fig. 12 are those obtained using  $1.12^\circ$  patches of brightness at various degrees of eccentricity from the fixation point. All of the records in each graph were made at one sitting with the records being made in the order from the largest degree of eccentricity to zero eccentricity. Subjects were kept dark adapted 30 minutes before taking any record. Enough time was allowed between records to permit the retina to return to its original state of dark adaptation and to permit the pupil to return to its normal size under dark adaptation. In the case of L.Z. little or no effect was obtained from changing the eccentricity of the patch of brightness. In the case of P.H. the pupil responses at  $32^\circ$  and  $25^\circ$  of eccentricity are somewhat smaller than the rest, but the rest all approximate the same size.

It is probable that the state of dark adaptation makes the response uniform across the retina. Other investigators have found that the fovea is more effective in producing a pupillary response than the parafoves. This is what one would predict would happen in the bright adapted eye.

It is probably true that the small image focused on the retina is contributing very little to the pupil response. The facts should probably be described by saying that distributions of stray light centered at points at different distances from the fovea produce essentially the same response. Each of these distributions of stray light is itself a gradient and if, for example, the fovea were the only part of the retina producing the pupil response, as was claimed by Hess<sup>5</sup>, then the further the center of the distribution from the fovea the less would be the pupil response.

The fact that, in the dark adapted eye, the periphery of the retina is just as effective in producing a pupil response as the central portion, simplifies the procedure in computing the effects of a complex distribution on the retina because it means that no allowance need be made for the location of a patch on the central region of the retina. All patches, regardless of where they fall within the central region of the retina, would be equally effective.

## C. The Role Played by Stray Light in Producing Pupil Responses.

When the patch  $1.12^\circ$  in diameter falls  $16^\circ$  to the right of the fixation point, it falls within the blind spot of each subject as shown in Fig. 13. The pupil response, however, is just as great as the response obtained from areas to the left and right of the blind spot (see Fig. 12). This is in accordance with the finding of Hess<sup>5</sup> and it can probably be concluded from this that the stray light produced by a small bright patch is the important thing rather than the light which is focused directly on the retina.

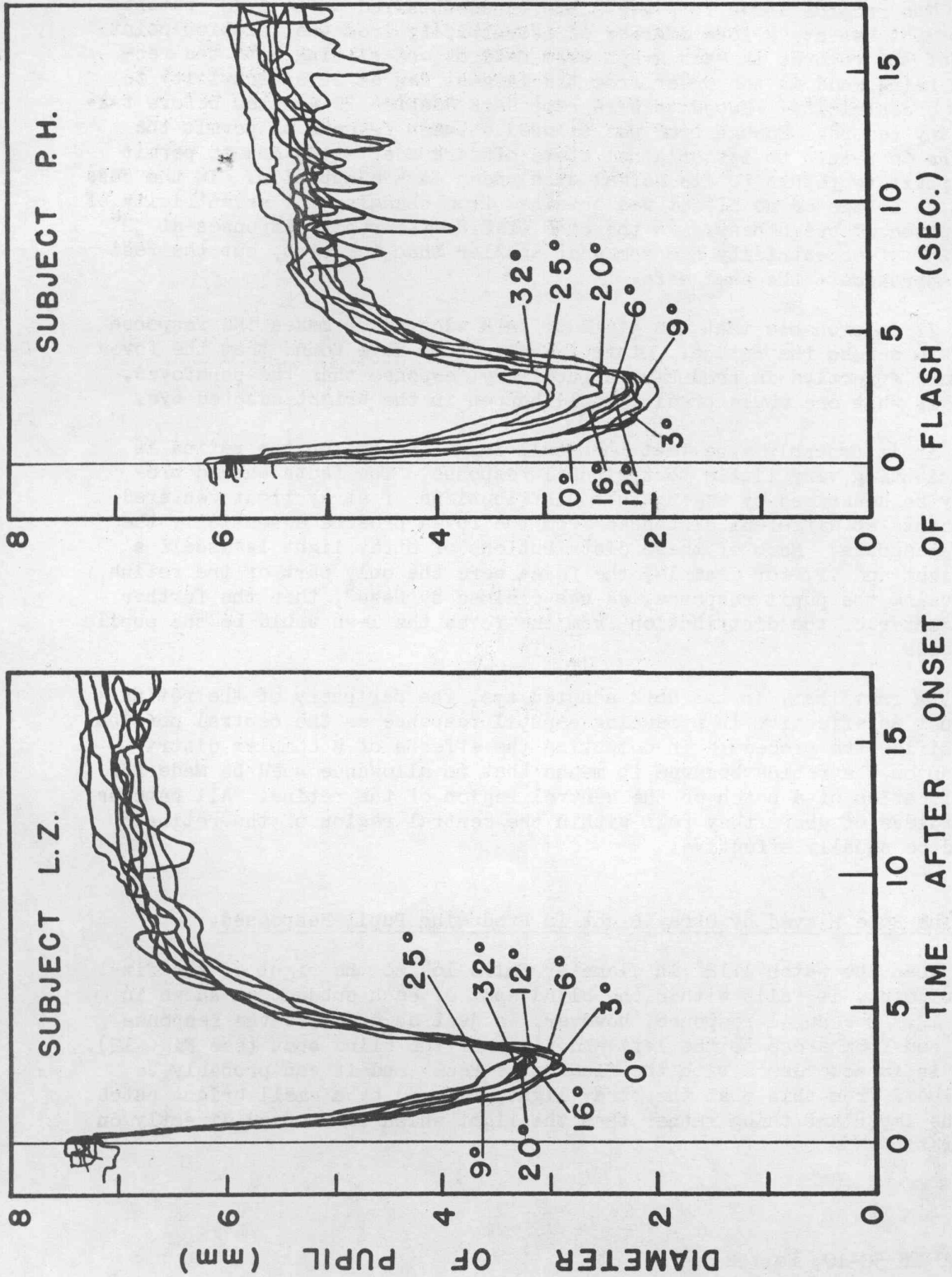

FIG. 12

Pupil Responses to 3-sec Exposures of the Right Eye to a 1.128 Bright Circular Patch (147,000 trolands) at Various Distances From the Fixation Point.

# Contrails

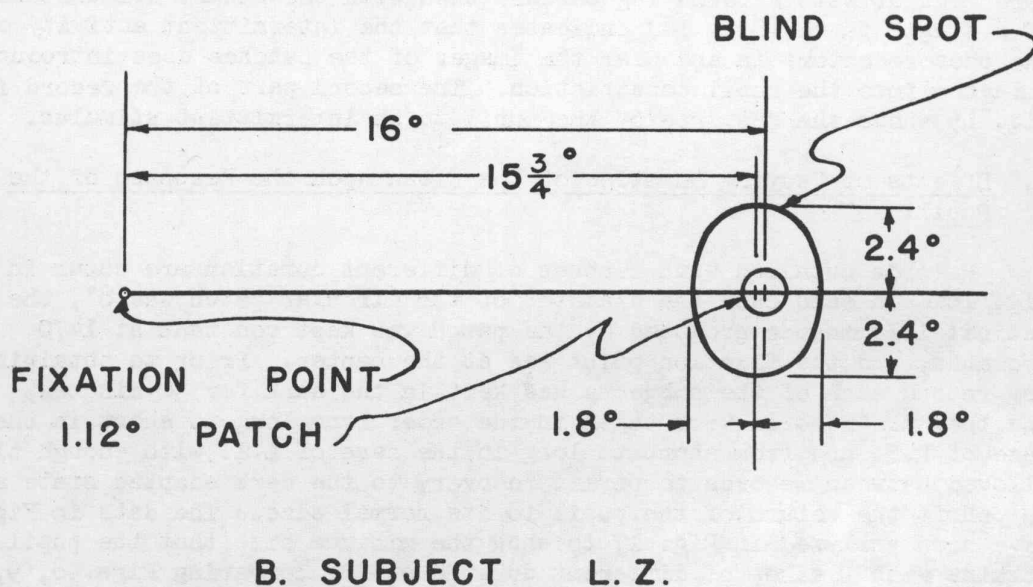
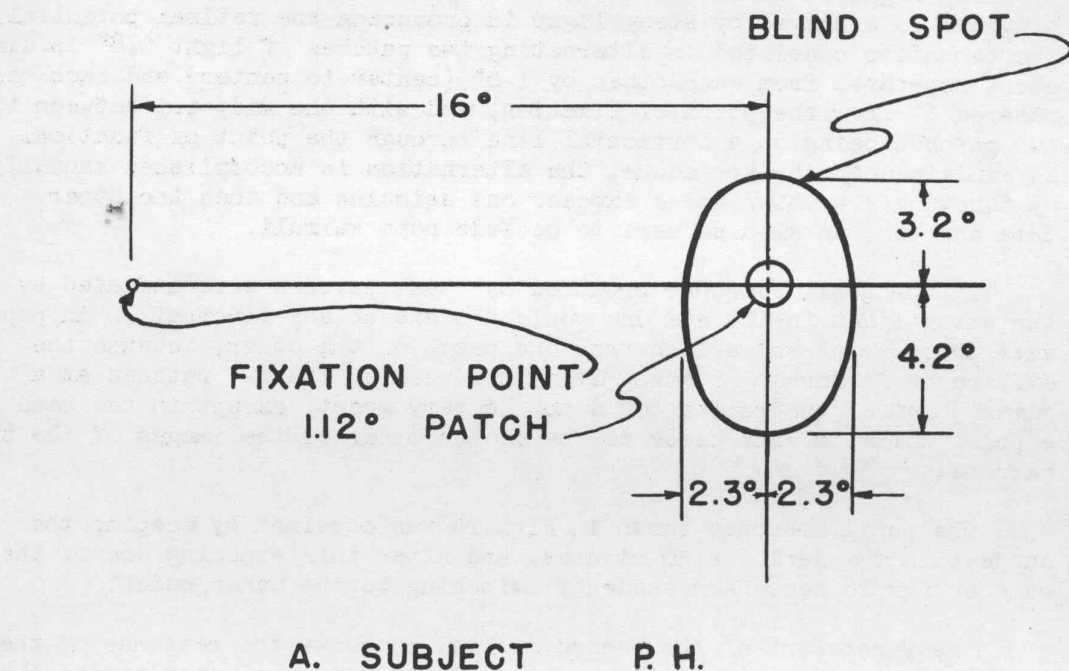

FIG. 13

Location of the 1.12° Patch Within the Blind Spot of Each Subject When Placed 16° to the Right of the Fixation Point.

One method employed in this study for demonstrating the role played by stray light is similar to that used by Bartley and Fry<sup>12</sup> in demonstrating the role played by stray light in producing the retinal potential. The technique consisted in alternating two patches of light  $0.8^\circ$  in diameter, separated from each other by  $1.6^\circ$  (center to center) and each separated  $5^\circ$  from the point of fixation, and with the midpoint between the two patches being on a horizontal line through the point of fixation. As explained in the procedure, the alternation is accomplished manually by throwing a shutter which exposes one stimulus and then the other. This shutter can also be used to occlude both stimuli.

If the pupil response produced by these patches were mediated by the stray light in the eye one would not expect any fluctuation in pupil size to occur at the switch from one patch to the other, because the difference in amount of stray light produced by the two patches at a given point of the retina could not be very great, except in the case of a point which is very close to one or the other of the images of the two patches.

The pupil response shown in Fig. 14 was obtained by keeping the subject in the dark for 30 minutes, and after this exposing one of the patches for 16 sec, then suddenly switching to the other patch.

The first part of the record in Fig. 15 shows the response of the pupil to rhythmic alternation back and forth from one patch to the other. The fact that the fluctuations in pupil size are more pronounced and more regular with alternating patches than with the steady stimulation of a single patch (Fig. 14) indicates that the intermittent activity of the photoreceptors in and near the images of the patches does introduce a rhythm into the pupil constriction. The second part of the record in Fig. 15 shows the response of the pupil to an intermittent stimulus.

D. Effects of Varying Duration of the Flash upon the Response of the Pupil.

Records obtained with flashes of different duration are shown in Fig. 16. In each case the diameter of the circular patch was  $8^\circ$ , the retinal illuminance produced by the patch was kept constant at 1470 trolands, and the fixation point was at the center. Prior to obtaining any record each of the subjects was kept in the dark for 30 minutes, and then the records were taken in the order from long to short in the case of P.H. and from short to long in the case of L.Z. with enough time allowed between records to permit recovery to the dark adapted state and to permit the return of the pupil to its normal size. The data in Fig. 16 have been analyzed in Fig. 17 to show the minimum size that the pupil attains with flashes of different durations. By comparing Figs. 8, 9, 10, 16 and 17 it is easy to observe that the effect of varying brightness is not at all equivalent to varying duration. The recovery from short



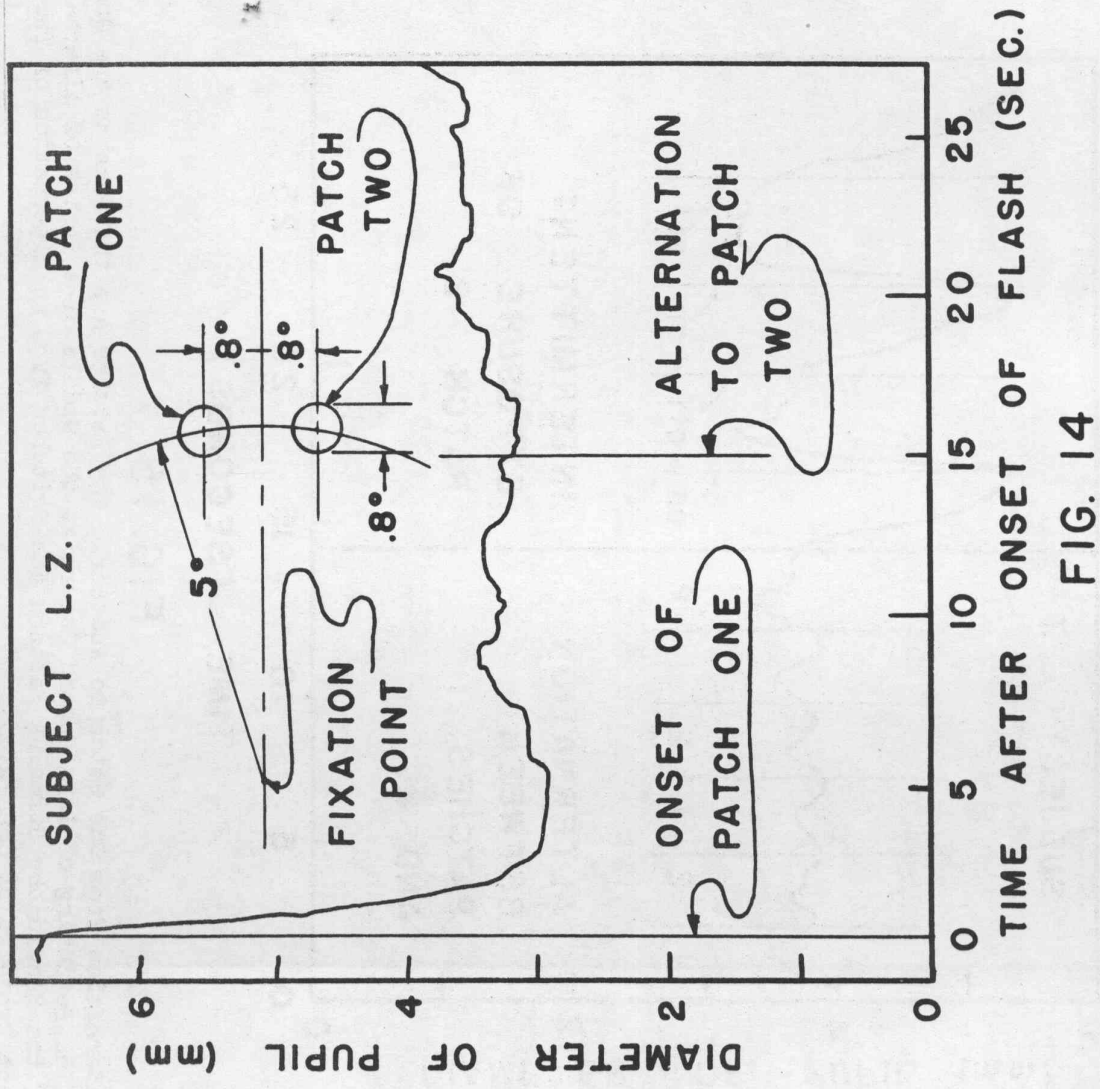

The Effect of Suddenly Switching from One Patch to Another. Each Patch Produces a Retinal Illumination of 147,000 trolands.

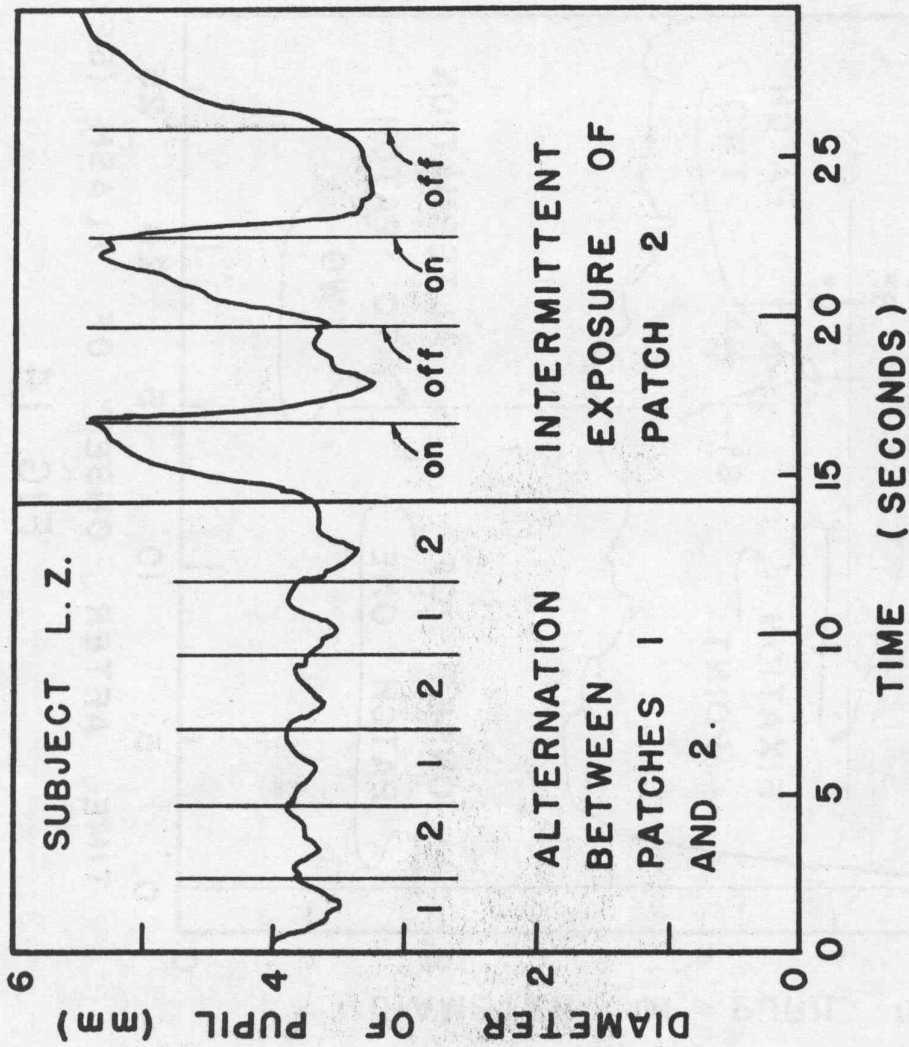

FIG. 15

The Effect of Alternation From One Patch to Another. The Patches Are the Same as the Ones Referred to in Fig. 14. The Beginning of This Record Occurs at the Middle of a Series of Alternations, and at the Middle of the Record the Stimulus Pattern Was Switched from an Alternation of Two Patches to an Intermittent Exposure of One Patch.

*Contrails*

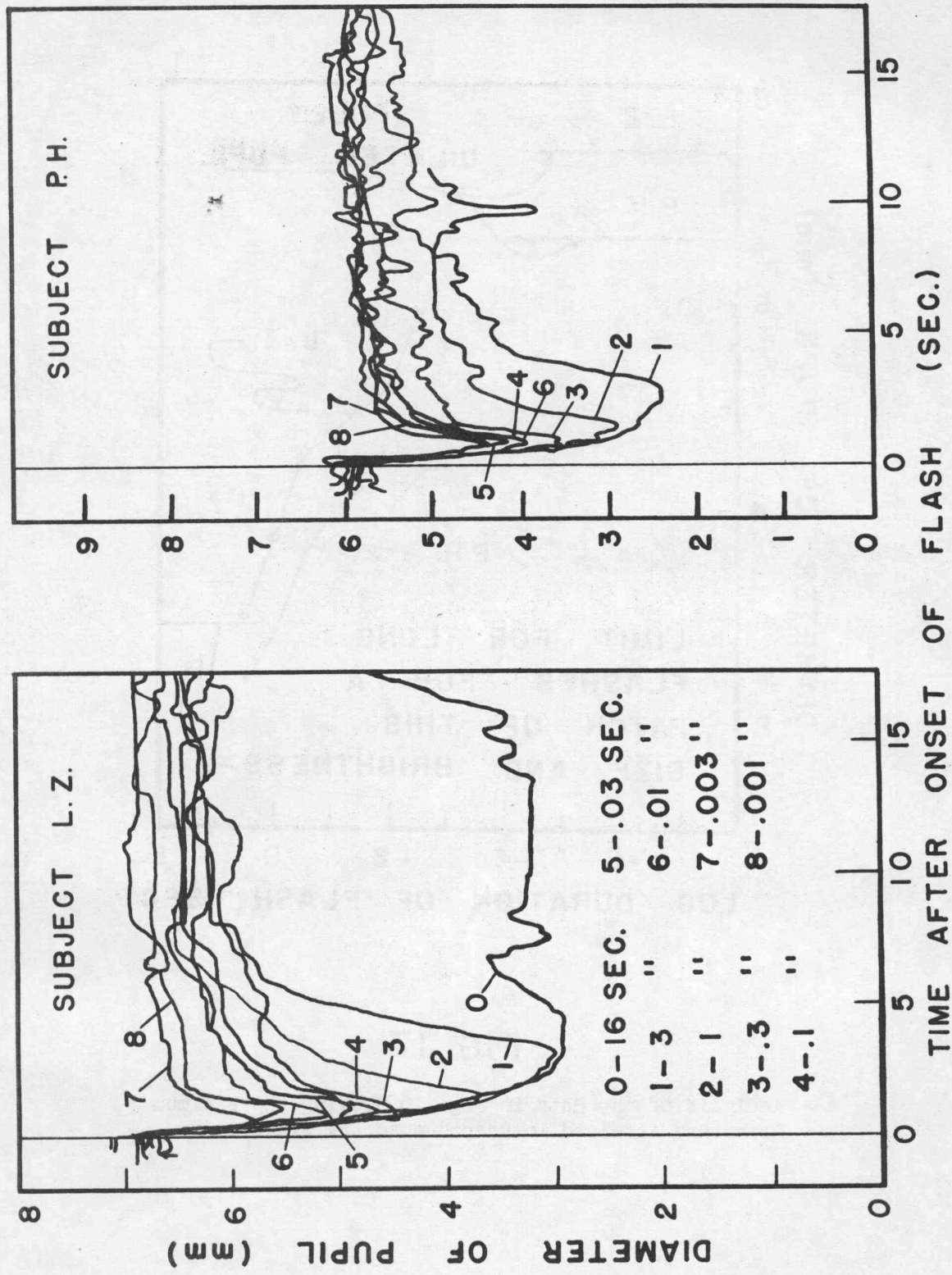

FIG. 16

Pupil Responses to Exposures of the Right Eye to an 8° Bright Circular Patch (1,470 trolands) Centrally Fixated for Various Durations.

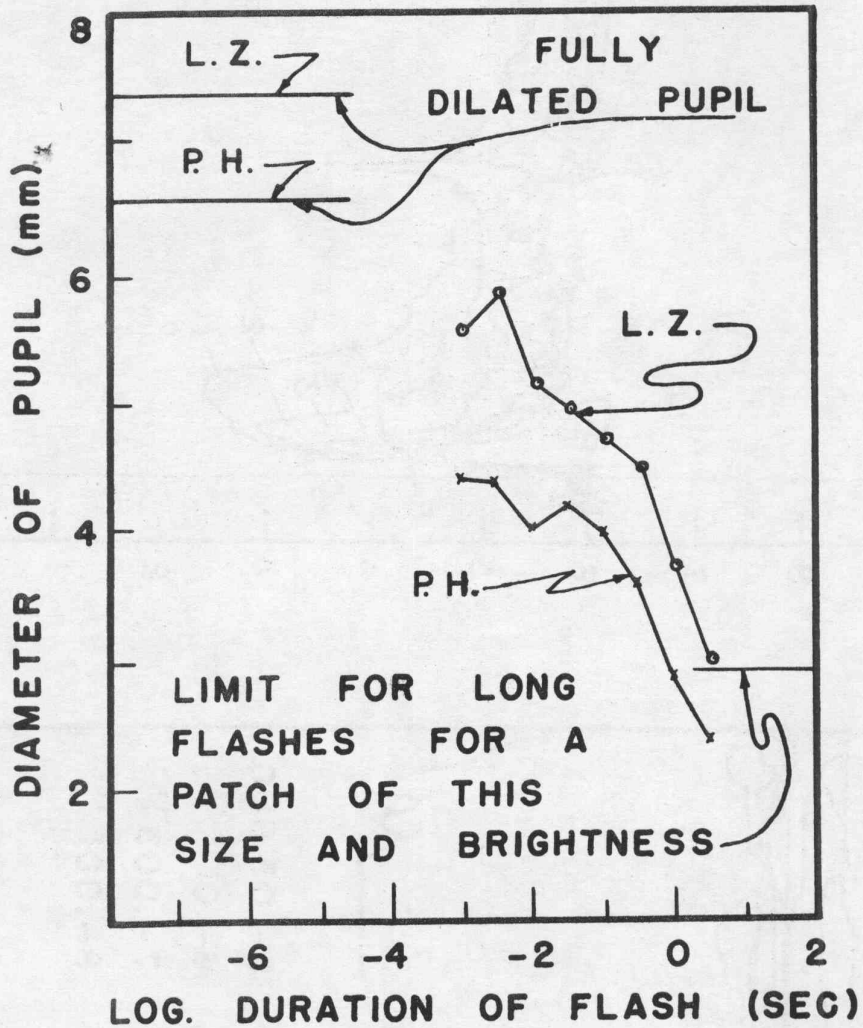

FIG. 17

Analysis of the Data in Fig. 16 Showing the Minimum Diameters Attained in Response to the Flashes.

# Contrails

flashes of high brightness is much faster than from weak flashes of long duration. The extent of pupil constriction finally reaches a limit as the duration of the stimulus is increased to one of indefinite duration, and this limit bears no relation to the limit reached by varying brightness and area.

The photoreceptor response to a flash of light is a burst of impulses which builds up to a maximum frequency and then subsides. For short flashes, the height of this peak is assumed to be affected just as much by varying intensity as by varying duration, but there is a critical duration (ranging from about 0.03 sec for cones at high brightness levels to 0.20 sec for rods at low brightness levels) beyond which further increase in duration will not increase the size of the peak. Further prolongation of the stimulus keeps the wave of activity from subsiding to zero; a low level of activity is maintained as long as the stimulus lasts. In contrast to this pattern of activity of the photoreceptors, the pupil continues with its wave of constriction long after the wave of activity of the photoreceptor has passed its peak and subsided to a reasonably steady level. It does not reach its peak until after about three seconds. After passing by the peak of constriction the pupil dilates a little, and after this it maintains a fairly constant level. The pattern of impulses transmitted by the photoreceptors to the ganglion cell layer and the pretectal region is probably retransmitted with high fidelity to the Edinger-Westphal nuclei, the ciliary ganglions and the sphincter muscles of the irides. It would appear, therefore, that the volley of impulses associated with the onset of the flash is expended in getting the sphincter response under way, but the sphincter response continues to build up after the volley of impulses has subsided to a lower level and continues to build up until it reaches its maximum several seconds later. The slight dilation of the pupil to its final steady size, which follows this peak of activity, probably depends upon a gradual decay of activity at the photoreceptor level. When the pupil finally reaches its steady state, it takes a relatively low frequency of impulses from the retina to maintain the pupil in its constricted state.

On the other hand, if we keep the duration of the flash constant and vary the brightness, we might expect the peak of the volley of impulses initiated in the retina to shift forward in time and the frequency of impulses at the peak to increase; and also if the duration is long enough for the frequency of impulses to settle down to a reasonably steady level before the flash ends, the level of retinal activity following the peak will be affected.

## E. Recovery from a Flash.

In Fig. 18 the recovery from 3 sec, 8°, centrally fixated flashes at various brightness levels have been traced for several minutes following the flash. A continuous record has been made of pupil size during

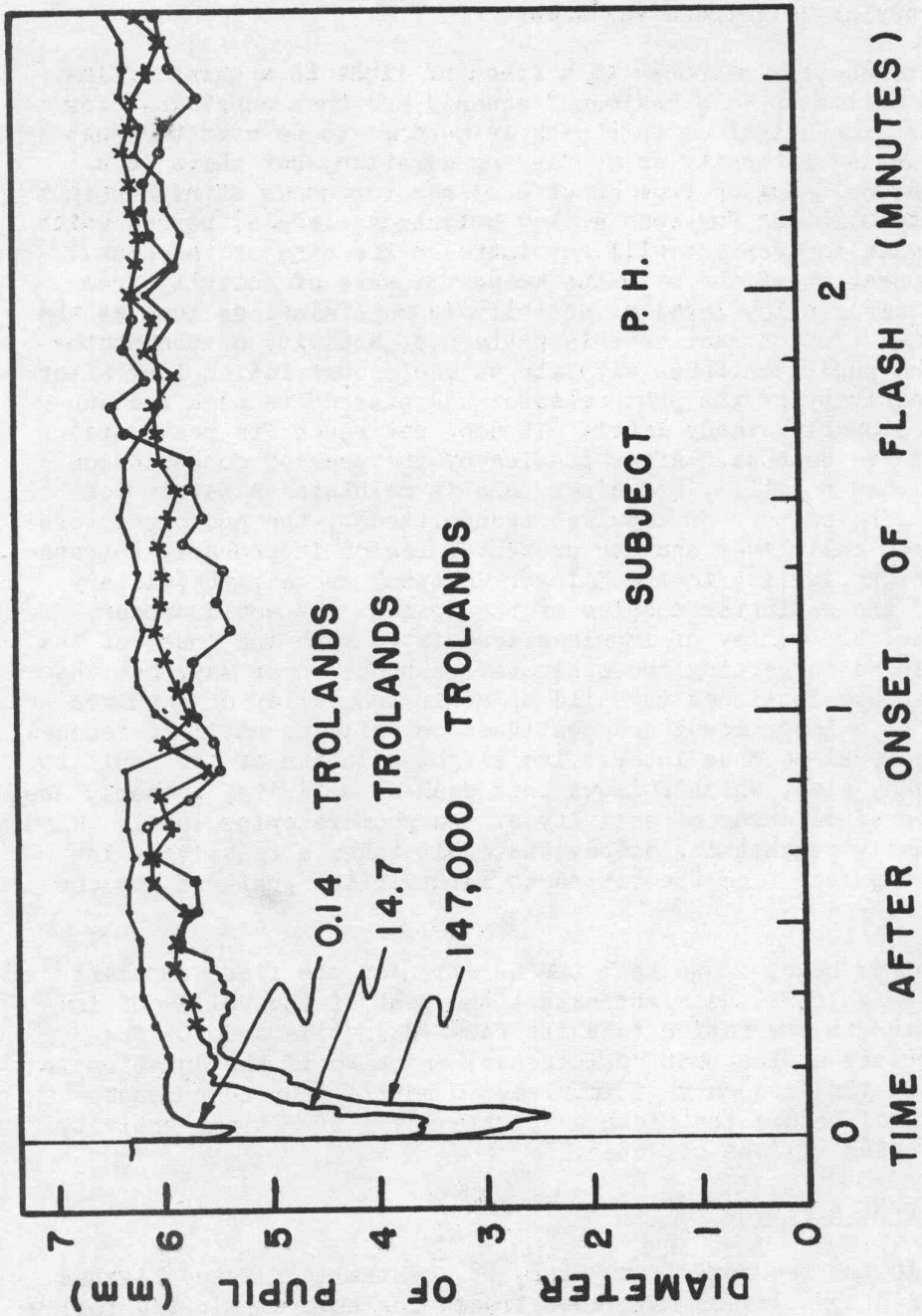

FIG. 18

The Recovery of the Pupil from Responses to 3-sec Exposures of the Right Eye to an 80 Centrally Fixated Patch at Various Brightness Levels.

# Contrails

the first 8 sec (low brightness) or 12 sec (medium brightness) or 28 sec (high brightness), and thereafter at the end of every four-second interval a short record of pupil size was made.

Our records indicate that if the pupil of an eye kept in darkness is made to constrict by a flash of light, it will return back to its original size within the first minute following the cessation of the flash.

It is not known whether the course of this recovery is determined wholly by the mechanics of the muscle or whether prolonged activity of the sensory mechanism is a factor. For example, there must be some kind of after discharge in the sensory mechanism associated with positive after images.

# Contrails

## SECTION IX

### SUMMARY AND CONCLUSIONS

Insofar as a flash of light in the visual field which one might encounter in a practical situation is similar to any of the stimuli which have been employed in this situation, the results of this investigation can be used directly to predict the effect of the flash upon pupil size during the flash and upon the ability to see immediately following the flash.

There are two aspects to the problem. If the flash lasts longer than the latent period for pupil constriction, the pupil constriction will affect the amount of light reaching the retina during the later portion of the flash. The second aspect of the problem relates to what happens subsequent to the flash. The pupil does not return back to its normal size until after a considerable period of time, and consequently this constricted state of the pupil must be taken into account in evaluating the return of an observer's ability to see a dark object against the sky background.

It was hoped that this study would lead to an adequate method of predicting the course of the pupil response produced by a flash having a complex temporal pattern as well as a complex, changing distribution of brightness in the visual field. In attempting to do this the obvious procedure is to determine the changes in the total retinal illuminance at various points on the retina during the period of the flash. This includes stray light as well as the light directly focused on the retina. Having done this one must predict the frequency of impulses discharged by the ganglion cells at the different parts of the retina at the different times, and then he must figure out how the impulses from the different parts of the retina summate with respect to both space and time to determine the pupil response.

As pointed out previously there are many problems which need further study before one can hope to predict the course of the change in pupil size resulting from a complex temporal pattern and also a complex, changing distribution of brightness in the field of view.

Until the mechanisms of temporal and spatial summation are better understood, it will probably suffice to use some crude approximations for predicting pupil responses. In the case of the dark adapted eye one can assume that the response is proportional to the total amount of light involved (brightness x area x time). This will hold roughly for the central region of the field of view up to 35° out from the



# Contrails

primary line of sight and for flashes up to 0.2 sec. For longer flashes than 0.2 sec the effect of varying duration is not the same as that of varying brightness, and allowance must be made also for the effect of the pupil constriction itself.

# Contrails

## BIBLIOGRAPHICAL REFERENCES

1. Moon, P. and Spencer, D. E., J. Opt. Soc. Am. 35, 233-248 (1945)
2. Moon, P. and Spencer, D. E., J. Opt. Soc. Am. 33, 444-456 (1943)
3. Holladay, L. L., J. Opt. Soc. Am. 12, 271-319 (1926)
4. Stiles, W. S. and Dunbar, C., Illum. Res. Com. (Great Britain) Tech. Paper No. 16 (1935)
5. Hess, C., Arch. Ophth. 38, 131 (1909)
6. Reeves, P., J. Opt. Soc. Am. 4, 35 (1920)
7. Steinhardt, J., Gen. Physiol. 20, 185-209 (1936-37)
8. Duke-Elder, W. S., Text-book of Ophthalmology, 1, 544-549 (1934)
9. De Launey, J., J. Opt. Soc. Am., 39, 364-367 (1949)
10. Blout, E. R. et al, J. Opt. Soc. Am. 36, 460-464 (1946)
11. Kodak Reference Handbook, Eastman Kodak Co., Film section, p. 37 (1945)
12. Fry, G. A. and Bartley, S. H., Am. J. of Physiol. 3, 335-340 (1935)