

WADC TECHNICAL REPORT 56-172
ASTIA DOCUMENT No. AD 118023

DESIGN OF CONTROLS

JEROME H. ELY
ROBERT M. THOMSON
JESSE ORLANSKY

DUNLAP AND ASSOCIATES, INC.
ASSISTED BY THE STAFF OF THE AERO MEDICAL LABORATORY,
WRIGHT AIR DEVELOPMENT CENTER

NOVEMBER 1956

AERO MEDICAL LABORATORY
CONTRACT No. AF 33(616)-419
PROJECT No. 7180
TASK No. 71501

WRIGHT AIR DEVELOPMENT CENTER
AIR RESEARCH AND DEVELOPMENT COMMAND
UNITED STATES AIR FORCE
WRIGHT-PATTERSON AIR FORCE BASE, OHIO

Contrails
FOREWORD

This report was prepared under Research and Development Project Number 7180, Human Engineering Applications to Equipment Design, of the Psychology Branch, Aero Medical Laboratory, Directorate of Research, Wright Air Development Center, with Dr. Walter F. Grether as Project Scientist.

This report is being issued as a preliminary draft of a part of the Human Engineering Guide to Equipment Design being prepared under the direction of the Joint Services Steering Committee for this guide. After further review and revision it is planned that this material will become a part of that guide. The purpose of the Human Engineering Guide to Equipment Design is to provide designers of military equipment with human engineering data and general design recommendations for maximizing efficiency of human operation and use.

Users of this report are invited to submit comments which would be useful in revising or adding to this material prior to its publication in the Joint Services Human Engineering Guide to Equipment Design. Comments should be sent to: Chief, Psychology Branch, Aero Medical Laboratory, Directorate of Research, Wright Air Development Center, Wright-Patterson Air Force Base, Ohio.

This report has been released to the Armed Services Technical Information Agency, Knott Building, Dayton 2, Ohio. This report has further been released to the Office of Technical Services, Department of Commerce, Washington 25, D. C. for sale to the general public.

Throughout the preparation of this report the authors received considerable assistance and guidance from Dr. Walter F. Grether, Mr. John Senders, Mr. C. A. Baker, Mr. M. J. Warrick, and Mr. J. Bradley of the Psychology Branch, and Mr. H. T. E. Hertzberg of the Biophysics Branch, Aero Medical Laboratory. A preliminary report was distributed in November 1954. This report was reviewed by approximately twenty experts in the field, representing the following organizations: Psychology Branch and Anthropology Section, Biophysics Branch of the Aero Medical Laboratory, Human Engineering Branch of Aeronautical Medical Equipment Laboratory, Human Engineering Branch of Navy Electronics Laboratory, Engineering Psychology Division of Frankford Arsenal, Human Engineering Laboratory of Aberdeen Proving Ground.

Mr. James T. Ray contributed significantly toward developing the content of the report. The art work was provided by Mr. Sidney Winter and Mr. Harold Montaine. Preparation of the final manuscript was aided considerably by the editorial assistance of Miss Ida Moore and the typing of Miss Raffaella Tarzia.

WADC TR 56-172

Proper design of controls is an important factor affecting operator performance in most man-machine systems. This report provides a compilation of human engineering recommendations concerning various aspects of control selection and design. Whenever these recommendations are the direct outgrowth of research in this field, the appropriate research studies are cited. Other recommendations, particularly those in Part 3, have been developed by the authors from their own experiences.

The report is divided into three main parts: Selection of Proper Control, General Control Design Considerations, and Detailed Design Recommendations for Specific Controls. Tables and figures are used frequently as means of presenting recommendations. A table of contents and a subject index are also provided as aids to the user.

PUBLICATION REVIEW

This report has been reviewed and is approved.

FOR THE COMMANDER:

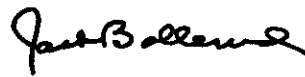

JACK BOLLERUD
Colonel, USAF (MC)
Chief, Aero Medical Laboratory
Directorate of Research

Contrails
TABLE OF CONTENTS

	<u>Page</u>
PART 1	
SELECTION OF PROPER CONTROL	1
1.1 GENERAL RULES FOR CONTROL SELECTION	2
1.1.1 Select controls which permit each limb to be used effectively.	2
1.1.2 Select controls whose movements conform with those of the controlled display, equipment component of vehicle.	3
1.1.3 Use multirotation controls when high precision is required over a wide range of adjustments.	3
1.1.4 Use discrete adjustment (detent) controls rather than continuous adjustment (non-detent) controls when performance requirements are such that the controlled object can be adjusted in a limited number of discrete steps.	3
1.1.5 When force and range of settings are the primary considerations in control selection, use the control recommended below.	5
1.1.6 Use combined controls rather than individual ones when they serve certain purposes.	6
1.1.7 Select controls which are easily identified.	7
1.2 CONTROL CHARACTERISTICS	7
1.2.1 Hand push button	7
1.2.2 Foot push button	8
1.2.3 Toggle switch	9
1.2.4 Rotary selector switch	10
1.2.5 Knob	11
1.2.6 Crank	13
1.2.7 Handwheel	14

Continued
TABLE OF CONTENTS (Continued)

	<u>Page</u>
1.2.8 Lever	16
1.2.9 Pedal	17
 PART 2 	
GENERAL CONTROL DESIGN CONSIDERATIONS	20
2.1 CONTROL-DISPLAY (C/D) RATIO	21
2.1.1 Definitions	21
2.1.2 Optimizing C/D Ratio	22
2.1.3 Primary Factors Affecting the C/D Ratio	23
2.1.4 Recommendation	23
2.2 CONTROL RESISTANCE	24
2.2.1 Spring Loading (Elastic Resistance)	25
2.2.2 Static and Sliding Friction (Dry Frictional Resistance)	26
2.2.3 Viscous Damping (Fluid Frictional Resistance)	27
2.2.4 Inertia (Inertial Resistance)	28
2.3 CONTROL CODING	29
2.3.1 Location Coding	31
2.3.2 Shape Coding	34
2.3.3 Size Coding	34
2.3.4 Mode-of-Operation Coding	36
2.3.5 Labeling	37
2.3.6 Color Coding	38

Controls
TABLE OF CONTENTS (Continued)

	<u>Page</u>
2.4 METHODS OF PREVENTING ACCIDENTAL ACTIVATION	40
2.4.1 Recessing	40
2.4.2 Location	41
2.4.3 Orientation	42
2.4.4 Covering	42
2.4.5 Locking	43
2.4.6 Operation Sequencing	43
2.4.7 Resistance	44
 PART 3 	
DETAILED DESIGN RECOMMENDATIONS FOR SPECIFIC CONTROLS	45
3.1 HAND PUSH BUTTON	47
3.1.1 Size	47
3.1.2 Displacement	47
3.1.3 Resistance	48
3.1.4 General	48
3.2 FOOT PUSH BUTTON	49
3.2.1 Size	49
3.2.2 Displacement	49
3.2.3 Resistance	50
3.2.4 General	51
3.3 TOGGLE SWITCH	51

Controls
TABLE OF CONTENTS (Continued)

	<u>Page</u>
3.3.1 Size	51
3.3.2 Displacement	52
3.3.3 Resistance	52
3.3.4 General	52
3.4 ROTARY SELECTOR SWITCH	54
3.4.1 Size	54
3.4.2 Displacement	55
3.4.3 Resistance	56
3.4.4 General	56
3.5 KNOB	59
3.5.1 Size	59
3.5.2 Displacement	61
3.5.3 Resistance	61
3.5.4 General	62
3.6 CRANK	64
3.6.1 Size	64
3.6.2 Displacement	65
3.6.3 Resistance	66
3.6.4 General	67
3.7 HANDWHEEL	68
3.7.1 Size	68
3.7.2 Displacement	69
3.7.3 Resistance	71
3.7.4 General	71

Contents
TABLE OF CONTENTS (Continued)

	<u>Page</u>
3.8 LEVER	72
3.8.1 Size	72
3.8.2 Displacement	73
3.8.3 Resistance	73
3.8.4 General	75
3.9 PEDAL	77
3.9.1 Size	77
3.9.2 Displacement	78
3.9.3 Resistance	78
BIBLIOGRAPHY	80
INDEX	90

LIST OF TABLES

<u>Table</u>		<u>Page</u>
I	Acceptable controls for various types of system responses	4
II	Nine common controls	18
III	Advantages and disadvantages of various types of coding	32
IV	General standards for color coding	39

Contrails

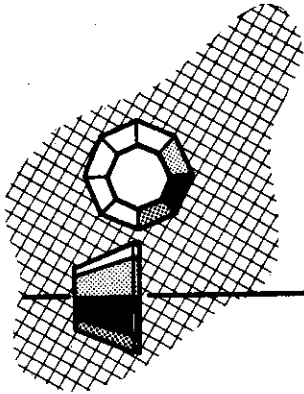

PART 1

SELECTION OF PROPER CONTROL

There are no "good" or "poor" controls as such; the goodness of any control depends upon its appropriateness to the task for which it is assigned. A control which is satisfactory for one task may be inadequate for another. The purpose of this part is to aid the designer in selecting the proper control for any given task. 19, 20, 27, 30, 33, 83

The first step in selecting the proper control is to determine the following:

- a. Function of the control: Its purpose and importance to the system. The nature of the controlled object, the type of change to be accomplished, the extent and direction of change.
- b. Task requirements: The precision, speed, range and force requirements in using the control, the effect of reducing one of these requirements in order to improve another.
- c. Informational needs of the operator: The operator's requirements for locating and identifying the control, determining the control position (setting), sensing any change in control position.
- d. Workplace requirements: The amount and location of available space in which to place the control, the importance of locating the control in a certain position in order to assure proper grouping and/or association with other equipment, controls and displays.

SELECTION OF CONTROL General Rules

This part consists of two sections:

- 1.1 General rules for control selection: Rules for selecting the proper control.
- 1.2 Control characteristics: The most important characteristics of commonly used controls.

1.1 GENERAL RULES FOR CONTROL SELECTION

1.1.1. Select controls which permit each limb to be used effectively. ^{7, 21, 22, 41, 43}

When an operator is involved in a complex task, the controls should be distributed so that no one limb will be overburdened.

Controls requiring rapid, precise setting should be assigned to the hands.

Controls requiring large or continuous forward applications of force should generally be assigned to the feet.

Many controls of various types may be assigned to the hands. However, whenever possible, not more than two controls of even the simplest type should be assigned to each foot. Limiting the number of foot controls aids in identifying each control, thereby tending to reduce training time.

1.1.2 Select controls whose movements conform with those of the controlled display, equipment component or vehicle. ^{1, 5, 27}

The direction of movement of the control should be consistent with that of the controlled object or display. The general situations in which linear (or near-linear) controls and rotary controls should be used are shown in Table I.

1.1.3 Use multirotation controls when high precision is required over a wide range of adjustments.

Linear movements can be made as precisely as rotary ones. Hence, for small adjustments of the controlled object, either a linear or a rotary control is satisfactory. However, since the range of movement of a linear control is generally limited, this type of control does not permit high precision over a wide range of adjustments. With a multirotation control, any desired precision can be obtained by appropriate gearing (although this may affect operating time).







1.1.4 Use discrete adjustment (detent) controls rather than continuous adjustment (non-detent) controls when performance requirements are such that the controlled object can be adjusted in a limited number of discrete steps. ⁵¹

Discrete adjustment controls (i. e., controls which snap into place for a limited number of positions), when properly designed, can be positioned

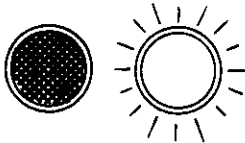
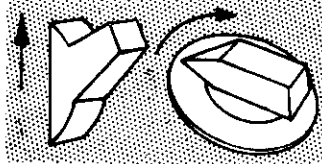
SELECTION OF CONTROL General Rules

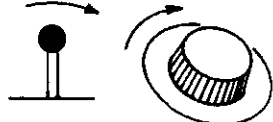
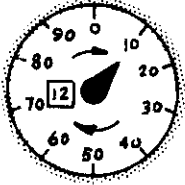
TABLE I

Acceptable controls for various types of system responses

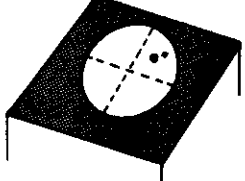
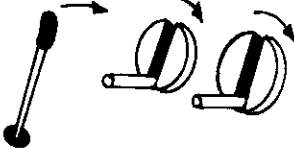
SYSTEM RESPONSE		ACCEPTABLE CONTROLS	
Type	Example	Type *	Examples
NON-MOVING (stationary)		LINEAR or ROTARY	
ROTARY: through an arc less than 180°		LINEAR or ROTARY	
ROTARY: through an arc more than 180°		ROTARY	
LINEAR: in one dimension		LINEAR or ROTARY	
LINEAR: in two dimensions		LINEAR or two ROTARY controls	

*Linear controls include push buttons, toggle switches, levers, reciprocating and translatory pedals.

Rotary controls include rotary selector switches, knobs, cranks, handwheels and rotary pedals.

with one gross adjusting movement. Continuous adjustment controls are generally positioned in two steps (a slewing movement and a fine adjustment). Continuous adjustment controls must be used when precise adjustments are needed along a continuum or when a large number of settings (usually more than 24) is required. However, when a limited number of settings is required or when precision requirements are so gross that a limited number of settings can represent an entire continuum within the required accuracy, discrete adjustment controls are preferred.

1.1.5 When force and range of settings are the primary considerations in control selection, use the control recommended below.

For small forces:

For 2 discrete settings:	Use hand push button, foot push button or toggle switch.
For 3 discrete settings:	Use toggle switch or rotary selector switch.
For 4-24 discrete settings:	Use rotary selector switch.
For small range of continuous settings:	Use knob or lever.
For large range of continuous settings:	Use crank.

For large forces:

For 2 discrete settings:	Use detent lever, large hand push button or foot push button.
--------------------------	---

SELECTION OF CONTROL General Rules

For 3-24 discrete settings:	Use detent lever.
For small range of continuous settings:	Use handwheel, rotary pedal or lever.
For large range of continuous settings:	Use large crank.

1.1.6 Use combined controls rather than individual ones when they serve certain purposes.

Several functionally related controls can be combined for purposes such as: a) reducing reaching movements, b) aiding in sequential or simultaneous operation of controls, c) economizing on use of panel space for control mounting.

Caution: In combining controls, care must be taken not to violate other human engineering principles. The hazard of accidental activation should be especially considered.¹¹

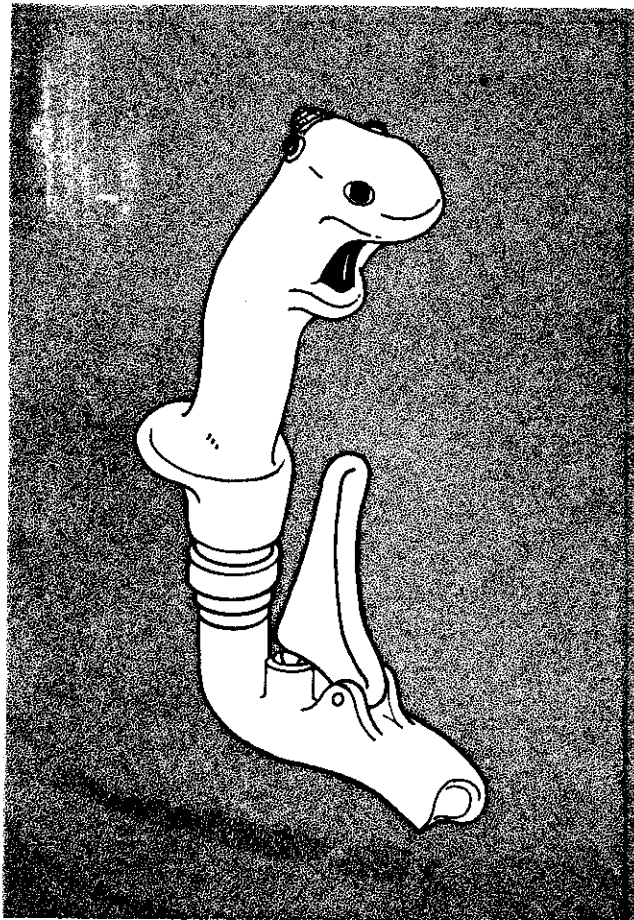

1.1.7 Select controls which are easily identified.^{49, 82}

All controls should be identifiable, primarily by standardizing their locations but also by other means when appropriate. Primary and emergency controls should be identifiable both visually and non-visually. Identification (coding) should not hinder the operator in manipulating his controls or increase the likelihood of accidental activation. (See Section 2.3 for complete coverage of coding.)

1.2 CONTROL CHARACTERISTICS

The most commonly used controls (four discrete adjustment and five continuous adjustment controls) and the most important characteristics of each are listed in this section. All nine controls are compared in Table II (end of section) for use in selecting the proper control for various tasks. (For detailed design recommendations for each control, see Part 3.)

1.2.1 Hand Push Button

- a. Consists of three major types: 1) push-on and release-off, 2) push-on and push-off, 3) push-on and lock-on.
- b. Requires little space for location and operation.

SELECTION OF CONTROL Control Characteristics

- c. Can be operated quickly and simultaneously with other push buttons in an array. Easily identified by its position within an array or by its associated display signals.⁶³

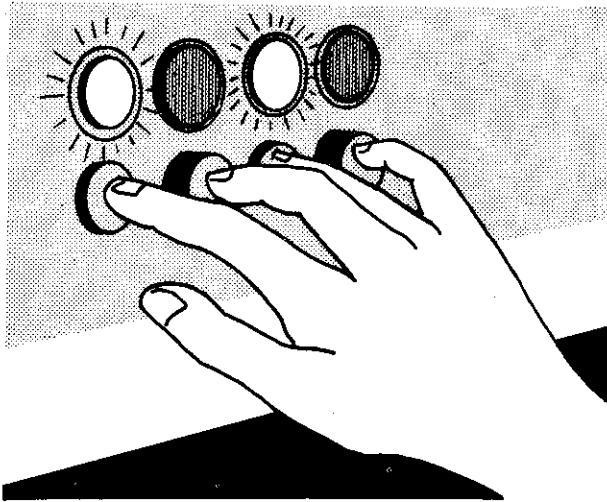

- d. Easily coded by color or size. However, control setting (whether on or off) is not easily identified either visually or non-visually.⁴⁹
- e. Very quickly actuated. Operating time increases with excessive displacement and/or force.⁶²
- f. Direction-of-movement relationships are usually not a consideration; therefore, may usually be placed anywhere around the operator and move in any direction.

1.2.2 Foot Push Button

- a. Consists of two major types: 1) push-on and release-off, 2) push-on and push-off.
- b. Leaves hands free for other operations.
- c. Requires large space for operation because of the swept volume of the foot.

- d. Because it usually cannot be seen or felt (without danger of activating it), neither the control nor its setting (whether on or off) is easily identified.⁴⁹
- e. Quickly actuated when foot is on control. Operating time increases with increase in required displacement and/or force. Toe-operated controls are actuated slightly faster than heel-operated ones.⁸

1.2.3 Toggle Switch

- a. Usually has two positions. May have more but speed and ease of operation are sacrificed.
- b. Requires little space for location and operation.

- c. Can be operated quickly and simultaneously with other toggle switches in a row. Identified easily by its proximity to its display or by its location within an array.

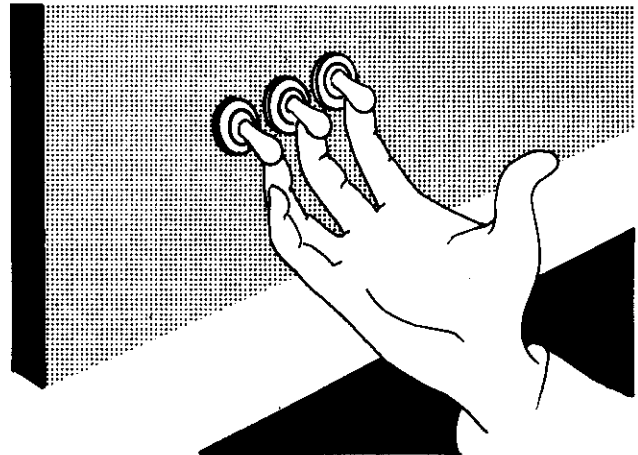

- d. Control setting (position) is identifiable both visually and non-visually provided there is a small number of positions (preferably two, but three are acceptable).
- e. Very quickly actuated.⁷⁶

SELECTION OF CONTROL Control Characteristics

1.2.4 Rotary Selector Switch

- a. Usually has between 3 and 24 settings (positions). May have more, but speed and accuracy of setting and checking are sacrificed. ^{17,18}

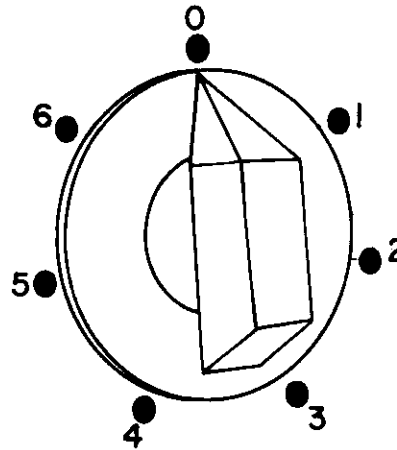

- b. Requires more space for location than do push buttons or toggle switches, plus some additional space for operation because of the swept volume of the hand. However, when a large number of discrete settings are required, one rotary selector switch requires less space than an array of push buttons or toggle switches.

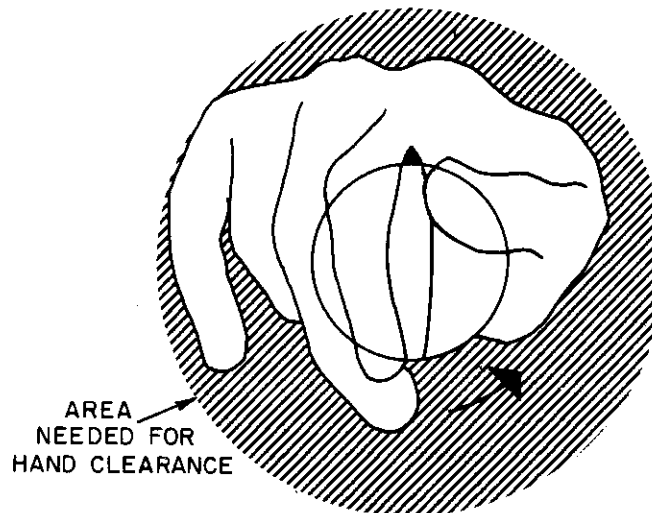

- c. Easily identified by color or shape. Control setting (position) is visually identifiable; can be identified non-visually with proper design. ⁴⁹
- d. Quickly actuated.

- e. Can be used with either a rotatable indicator (pointer) and stationary numbers or a stationary indicator and numbers on a rotatable skirt.^{5, 27} (For comparison see Section 3.4.4.)

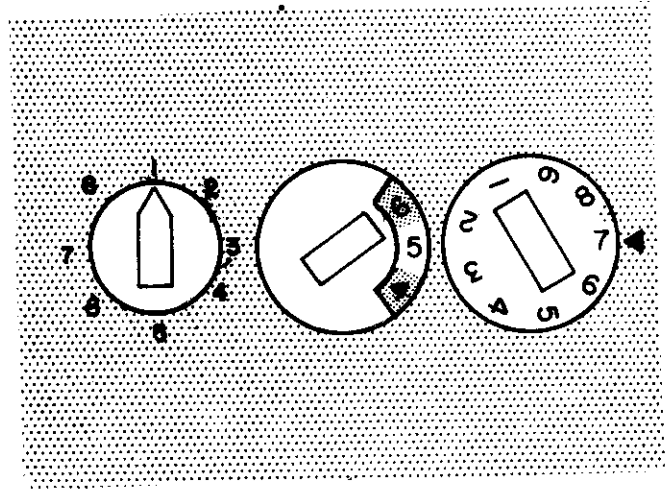

1.2.5 Knob

- a. Effective for making small turning operations which do not require the application of large forces.
- b. Requires more space for operation than do push buttons and toggle switches because of the swept volume of the hand.

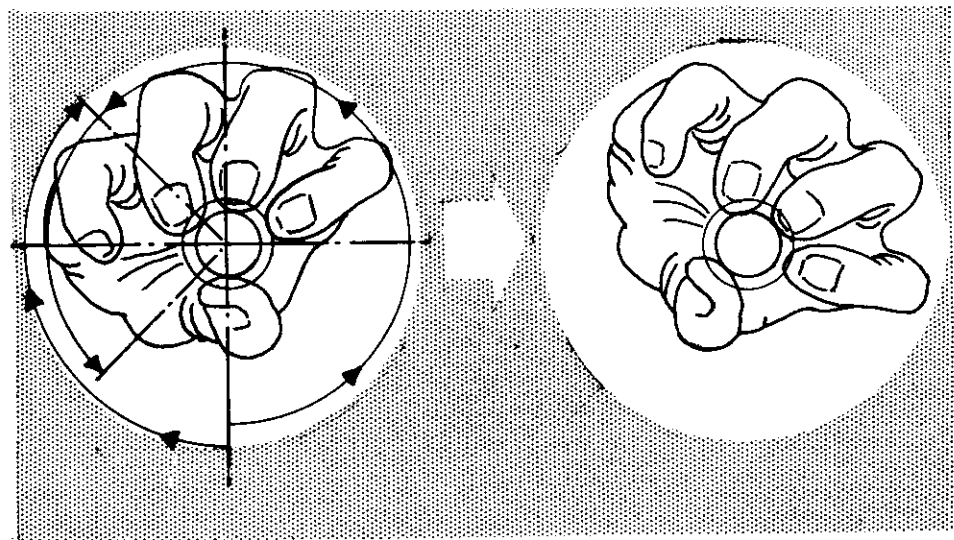

**SELECTION OF CONTROL
Control Characteristics**

Controls

- c. Easily coded by color, size or shape. Control setting (position) is visually identifiable provided the control makes less than one rotation and has a pointer or marker attached.⁴⁹
- d. Can have an unlimited range of control movement; with proper gearing can be used for either gross or fine positioning over a wide range of adjustments.

- e. Can be "ganged" with other knobs by mounting knobs on concentric shafts. Mounting more than two knobs on concentric shafts is likely to be wasteful of panel space, but may be desirable for other reasons such as facilitating sequence of operations.^{10, 11}

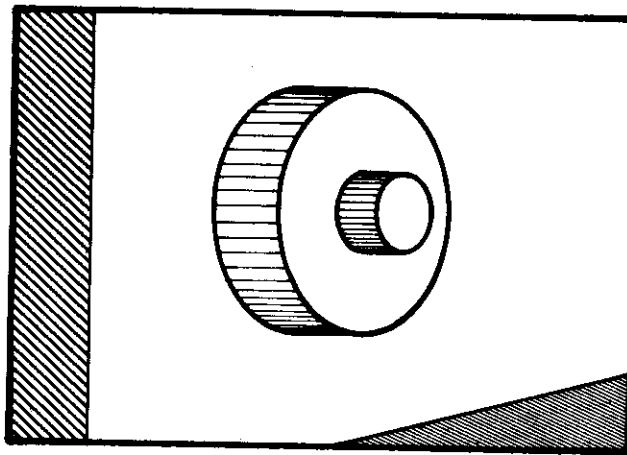

- f. Folding crank handle can be attached to aid in rapid slewing.

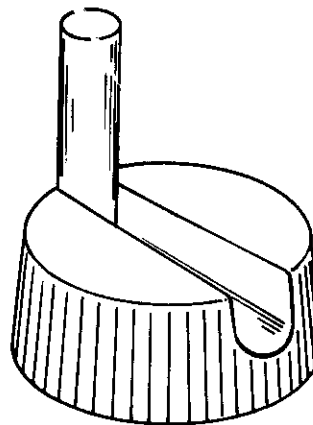

- g. Can be used with either a rotatable indicator (pointer) and stationary numbers or a stationary indicator and numbers on a rotatable skirt.^{5, 27}
(For comparison see Section 3.4.4.)

1.2.6 Crank

- a. Effective in making adjustments on a continuum when large distances must be covered and high rates of turning are required. (For slower rates a knob or handwheel is more effective.) ^{4, 42, 68}

- b. Requires more space for location than do small controls (push buttons and toggle switches), plus some additional space for operation (turning) because of the swept volume of the hand.

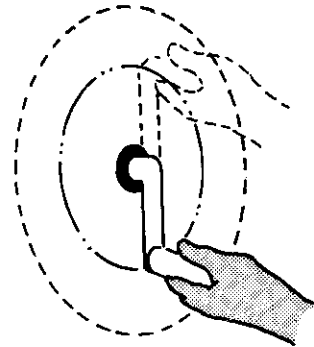

- c. Because it is usually multirotational, the position of the handle generally does not indicate the control setting (position). ⁴⁹
- d. Can have an unlimited range of control movement; with proper gearing can be used for either gross or fine positioning over a wide range of adjustments.

- e. Can be attached to a knob or handwheel for increased versatility.

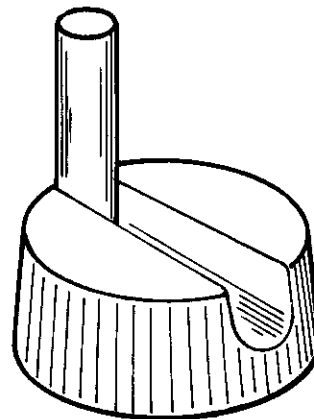

1.2.7 Handwheel

- a. Usually operated by both hands but operable with one.^{21, 22}

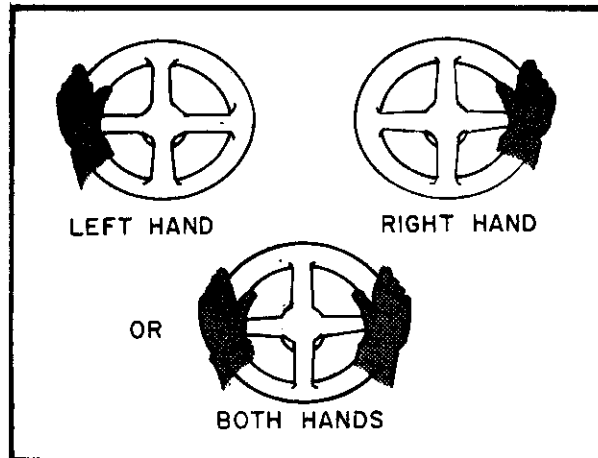

- b. Useful for exerting greater rotary forces than are possible with knobs and cranks.⁶⁵
- c. Requires large amount of space for location and operation.
- d. Can be coded by color effectively. Identification of control setting (position) is poor, and impossible if multiple rotations are permitted.⁴⁹
- e. Useful as part of a combined control. Smaller controls (push buttons, knobs, etc.) can usually be attached easily. However, their position may vary with the position of the handwheel, thus potentially interfering with their operation.

- f. For most effective use, the usual arc of rotation should not exceed $\pm 60^\circ$ from the normal (null) position. Larger arcs require the hands to shift position on the control.

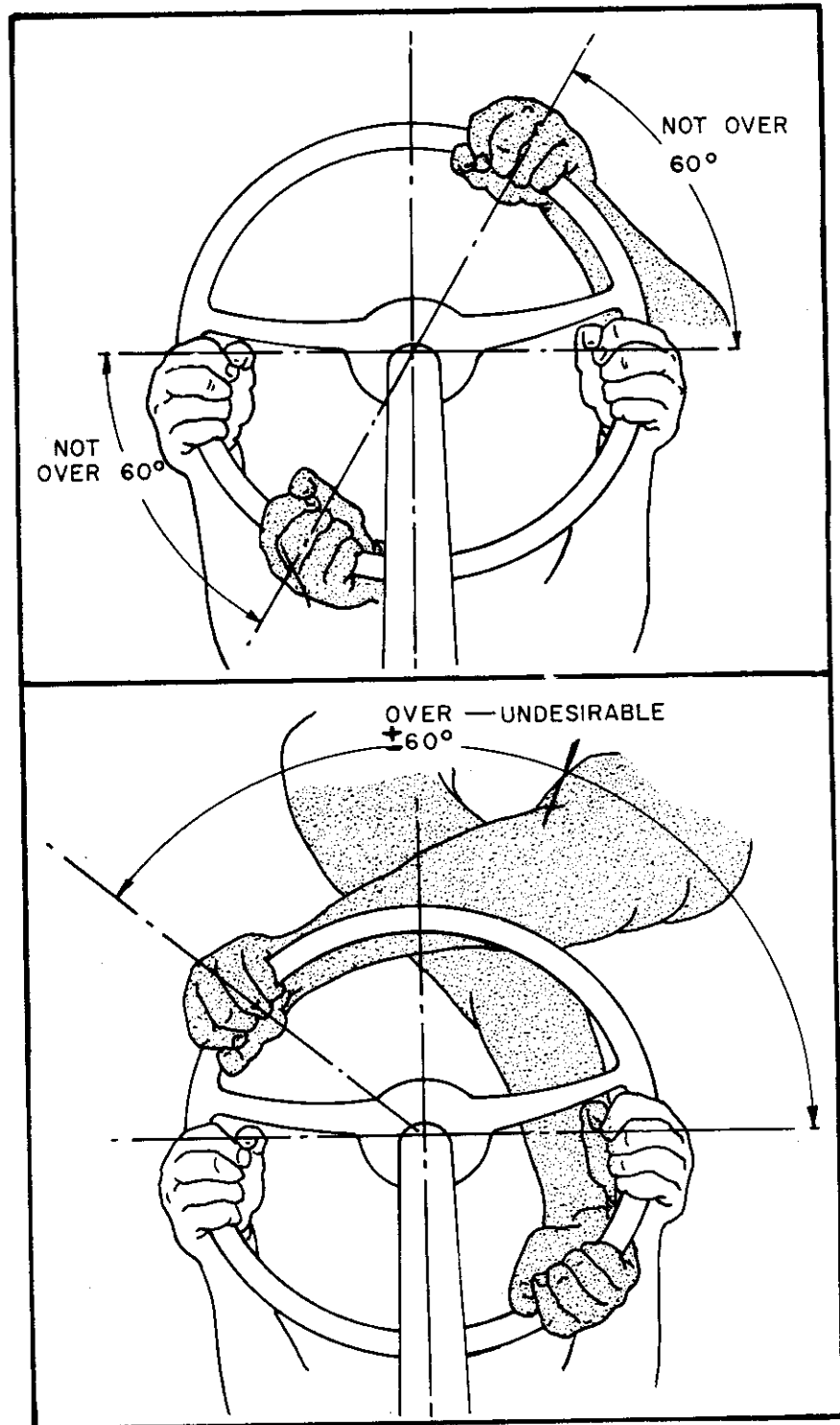

1.2.8 Lever

a. Includes joystick, gear shift, controls such as aircraft throttles, etc.

b. Most effective when it moves through an arc of not more than 90° . Should never exceed the convenient reach of the arm.

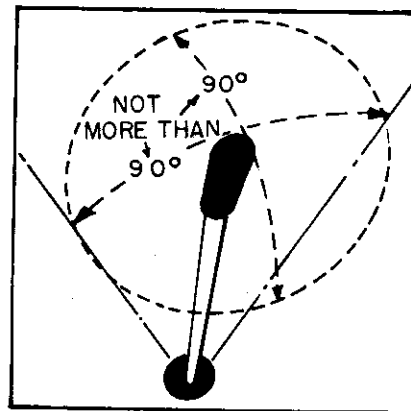

- c. Requires more space than do small controls (push buttons, toggle switches).
- d. Easily coded by color, size or shape. Identification of control setting (position) is fair both visually and non-visually.⁴⁹
- e. Has a limited range of movement; therefore, is generally unsatisfactory for precise positioning over a wide range of adjustments.^{53, 56}
- f. Can be operated quickly and simultaneously with other levers in a row.
- g. Smaller controls (push buttons, toggle switches, triggers, etc.) can be attached easily, making one combined control.
- h. Enables a seated operator to exert large forces against the control in a fore-aft direction.^{40, 63}

1.2.9 Pedal

- a. Consists of three major types:
 1) rotary,
 2) reciprocating,
 3) translatory.

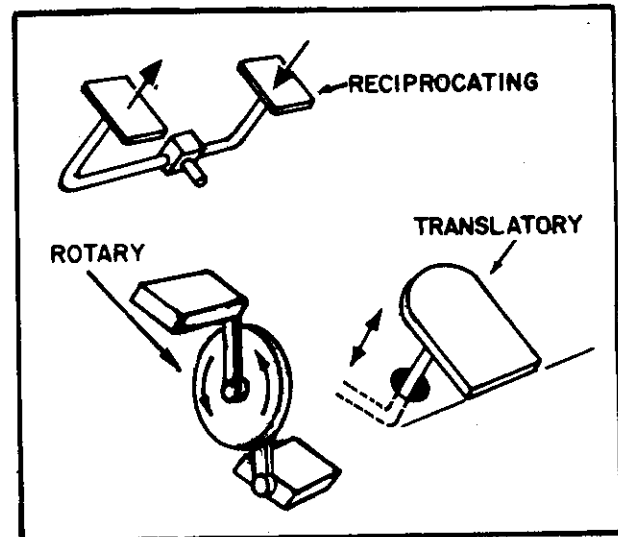

- b. Requires more space for location than do small controls, plus some additional space for operation.
- c. Because it usually cannot be seen or felt (without danger of activating it), neither the control nor its setting (position) is easily identified.
- d. Permits more force but less precision and speed than do hand controls. ^{7, 8, 40, 44}
- e. Rotary pedals have unlimited range of control movements; therefore, with proper gearing can be used for either gross or precise positioning over a wide range of adjustments. Reciprocating and translatory pedals have limited ranges of control movement; therefore, are unsatisfactory for precise positioning over a wide range of adjustments.

SELECTION OF CONTROL
Control Characteristics

TABLE II
Nine common controls

CHARACTERISTICS	TYPE OF CONTROL									
	DISCRETE ADJUSTMENT					CONTINUOUS ADJUSTMENT				
	Hand push button	Foot push button	Toggle switch	Rotary selector switch		Knob	Crank	Hand-wheel	Lever	Pedal
Large forces can be developed	--	--	--	--	No	Yes	Yes	Yes	Yes	Yes
Time required to make control setting	Very quick	Quick	Very quick	Medium to quick	--	--	--	--	--	--
Recommended number of control positions (settings)	2	2	2-3	3-24	--	--	--	--	--	--
Space requirements for location and operation of control	Small	Large	Small	Medium	Small to medium	Medium to large	Large	Medium to large	Medium to large	Large
May require special design consideration to reduce likelihood of accidental activation	Yes	Yes	Yes	Yes	Yes	Yes	Yes	Yes	Yes	Yes
Desirable limits to control movement	--	--	--	--	Unlimited	Unlimited	±60°	±90°	±90°	Small ¹
Effectiveness of coding	Fair to good	Poor	Fair	Good	Good	Fair	Fair	Good	Good	Poor
Effectiveness of visually identifying control position	Poor ²	Poor	Fair to good	Fair to good	Fair ³ to good	Poor ⁴	Poor to fair	Fair to good	Fair to good	Poor
Effectiveness of non-visually identifying control position	--	--	Good	Fair to good	Poor to good	Poor ⁴	Poor to fair	Poor to fair	Poor to fair	Poor to fair

TABLE II (Continued)

CHARACTERISTICS	TYPE OF CONTROL						
	DISCRETE ADJUSTMENT			CONTINUOUS ADJUSTMENT			
	Hand push button	Foot push button	Rotary selector switch	Knob	Crank	Hand-wheel	Lever Pedal
Effectiveness of check-reading to determine control position when part of a group of like controls	Poor ^②	Poor	Good	Good ^③	Poor ^④	Poor	Good
	Good	Poor	Good	Poor	Poor	Poor	Good
Effectiveness of operating control simultaneously with like controls in an array	Good	Poor	Good	Good ^⑤	Poor	Good	Good
Effectiveness as part of a combined control	Good	Poor	Fair	Good	Poor	Good	Poor

- ① Except for rotary pedals which have unlimited range.
- ② Exception: when control is back-lighted and light comes on when control is activated.
- ③ Applicable only when control makes less than one rotation. Round knobs must also have a pointer attached.
- ④ Assumes control makes more than one rotation.
- ⑤ Effective primarily when mounted concentrically on one axis with other knobs.

PART 2

GENERAL CONTROL DESIGN CONSIDERATIONS

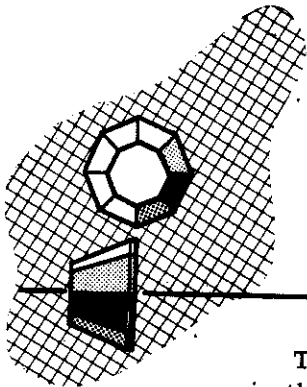

This part describes four important factors which should be considered in the design of controls:^{1, 51}

- 2.1 Control-display (C/D) ratio
- 2.2 Control resistance
- 2.3 Control coding
- 2.4 Methods of preventing accidental activation

General recommendations are made which are applicable to most types of controls. Detailed recommendations for specific controls are presented in Part 3.

2.1 CONTROL-DISPLAY (C/D) RATIO

2.1.1 Definitions

Control-display (C/D) ratio is the ratio of distance of movement of the control to that of the moving element of the display (pointer, cursor, "hook," etc.). For position-control (zero-order control), the C/D ratio is the reciprocal of the "gain" or "sensitivity" of the system. The C/D ratio is a critical design factor affecting operator performance; a good C/D ratio has been shown to save from 1/2 to 5 seconds in positioning time when compared with a poor C/D ratio. ^{52, 53, 55, 56}

For linear and near-linear controls (e.g., levers) which affect linear displays, the C/D ratio is usually defined as the linear distance of control displacement to distance of resulting display movement. Control displacement should be measured from the point where the operator's hand grasps the control.

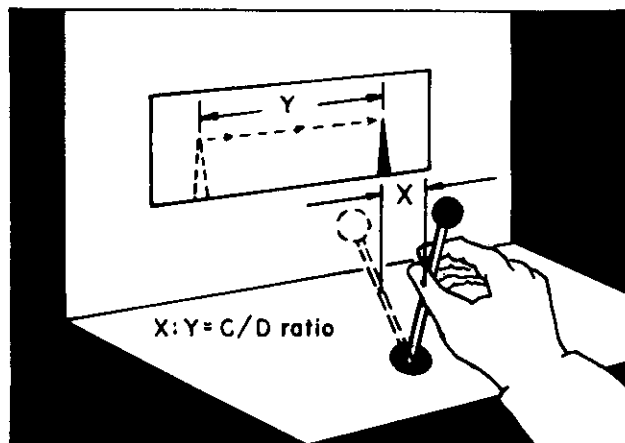

For small rotary controls (e.g., knobs) which affect linear displays, the C/D ratio is usually defined as the number of control rotations to distance of resulting display movement.

2.1.2 Optimizing C/D Ratio

In positioning a continuous adjustment (non-detent) control, the operator makes two types of movement:

a. A slewing movement (also referred to as "travel," "gross adjusting movement" and "primary movement") in which he rapidly moves his control close to the final desired position. An increase in the C/D ratio will increase slewing time because of the longer movements required. However, for linear controls, slewing time is only slightly greater for long movements than for short ones.^{6, 15, 16, 66, 70, 73}

b. A fine adjusting movement (also referred to as "adjusting movement" or "secondary movement") in which he places his control precisely in the desired position. Fine adjusting time is reduced either by increasing the C/D ratio or by easing the tolerance requirements (i. e., increasing the maximum acceptable error in positioning the control).⁵²

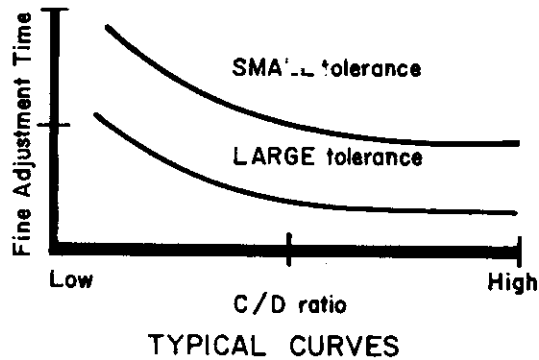

THE OPTIMUM C/D RATIO IS THAT WHICH MINIMIZES TOTAL TIME (SLEWING + FINE ADJUSTING) REQUIRED TO MAKE THE DESIRED CONTROL MOVEMENT.

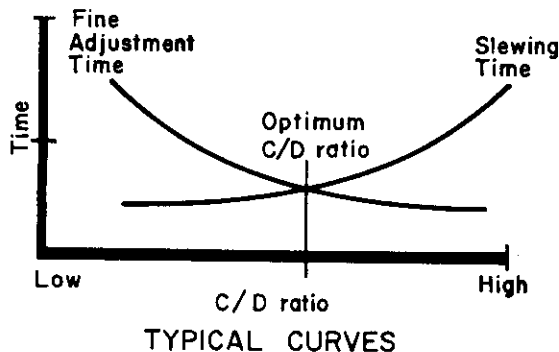

2.1.3 Primary Factors Affecting the C/D Ratio

- a. Display size: With tolerance kept constant, changing the size of the display may change total adjustment time.
- b. Tolerance: Fine adjusting time is reduced directly by easing the tolerance requirements. Slewing time is probably also reduced because the operator tends to move his control into position more slowly when he knows that it will have to be positioned precisely. Changing tolerance may change the optimum C/D ratio.
- c. Viewing distance: The effects of viewing distance upon C/D ratio are now being investigated. Research to date suggests that viewing distance does affect performance and that it might also change the optimum C/D ratio, although no definite relationships have been established as yet.⁷²
- d. Time delays: The type and extent of any time delay in the system may affect the optimum C/D ratio. For exponentially shaped time delays occurring between the control movement and the resulting display response, within reasonable limits, the longer the time delay, the smaller will be the optimum C/D ratio.⁶⁹

2.1.4 Recommendations

In most applied problems, the designer will be unable to determine the optimum C/D ratio from available research. Hence, whenever possible he should determine the optimum ratio experimentally, keeping in mind that it may be affected by display size, tolerance, viewing distance and time delays.

2.2 CONTROL RESISTANCE

Some force must always be applied to make a control move. The type and amount of resistance offered by the control (and the device to which it is coupled) affects the operator's force requirements.

There are four general types of resistance:

Spring loading

Static and sliding friction

Viscous damping

Inertia

Rarely, if ever, is control resistance of a single type. All controls have some mass and, hence, some inertia. Most controls move on a slide, shaft or pivot and, hence, have some static and sliding friction.

In terms of operator performance, there are interactions among the various types of resistance. Friction or viscous damping, for example, may be helpful in counteracting the adverse effects of excessive inertia.

Depending upon the type and amount, resistance can affect: ^{1, 28, 34, 35, 39, 42, 47, 48, 64, 77}

- a. Precision of control operation.
- b. Speed of control operation.
- c. "Feel" of the control.
- d. Smoothness of control movement.

- e. Susceptibility of the control to accidental activation and to the effects of jolting, vibration, buffeting, g-forces, tremor, the weight of the limb on the control, etc.

Listed in the following subsections are the most important characteristics of the four major types of resistance. The designer should build into the control the type(s) which best satisfies the performance requirements. (An optimum amount of resistance cannot be specified as yet, and should be determined empirically for each specific task.)

2.2.1 Spring Loading (Elastic Resistance) ^{3, 39, 48, 62, 63, 76, 77}

- a. Resistance varies directly with control displacement but is independent of velocity and acceleration.

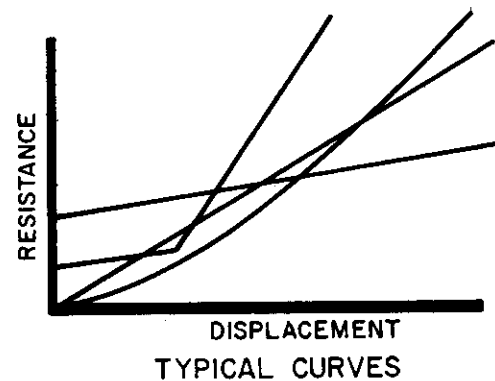

- b. Applies force toward the null position when the control is displaced; hence, aids in identifying the null position and in making adjustments around it.
- c. Returns automatically to the same (null) position when the operator's limb is removed; hence, is ideal for momentary contact or "dead-man" switch.
- d. Permits quick changes in direction to be made.

CONTROL DESIGN

Control Resistance

- e. Allows the operator's limb to rest on the control without activating it, providing there is sufficient resistance (preloading) at the null position.
- f. Reduces likelihood of undesired activation due to accidental brushing against the control, jolting, g-forces, large vibrations, buffeting.
- g. Provides the operator with feedback information ("feel") concerning control position.
- h. Provides constant or adjustable spring tension easily.
- i. Force gradient can be modified to provide special cues as to critical positions of the control (e. g., resistance suddenly increases as a limit is approached).

2.2.2 Static and Sliding Friction (Dry Frictional Resistance)

^{3, 26, 37, 38, 42, 45, 48, 53, 70}

- a. Resistance decreases sharply to a constant value when control starts to move smoothly and continuously. Resistance is independent of displacement and acceleration.

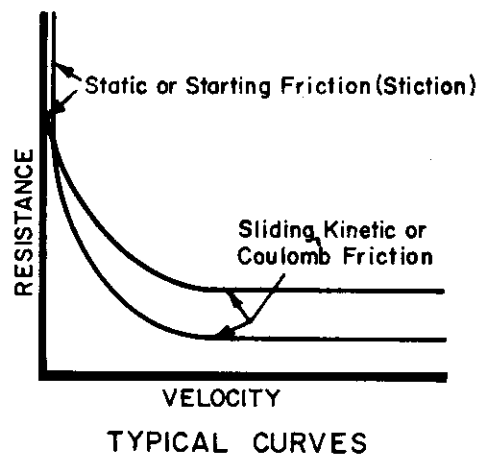

- b. Static friction tends to hold the control in position.

- c. Static friction reduces the likelihood of undesired activation due to accidental brushing against the control, jolting, g-forces, vibrations, buffeting, hand tremor.
- d. Static friction increases the difficulty in making precise settings.
- e. Allows the operator's limb to rest on the control without activating it, providing there is sufficient static friction.
- f. Static and sliding friction provide no feedback information ("feel") about the control position, but static friction may allow the control position to be felt without disturbing it.
- g. Difficult to design control to insure constant amount of friction, but "locking" device by which friction can be varied is easily provided.

2.2.3 Viscous Damping (Fluid Frictional Resistance)^{3, 39, 48}

- a. Resistance varies directly with control velocity but is independent of displacement and acceleration.

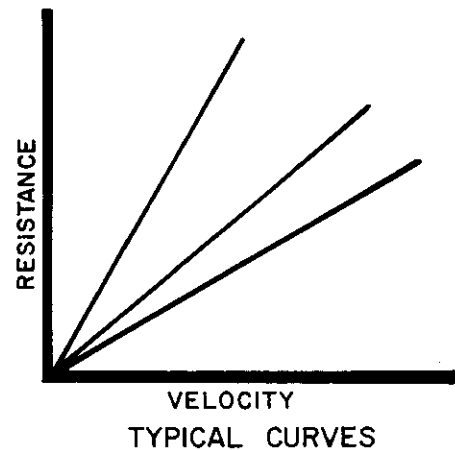

- b. Resists quick gross movements.

CONTROL DESIGN

Control Resistance

- c. Reduces likelihood of undesired activation due to accidental brushing against the control, jolting, g-forces, vibrations, buffeting, hand tremor.
- d. Aids in making smooth movements.
- e. Permits rapid changes in direction and small changes in position.
- f. Provides the operator with feedback information ("feel") about the velocity of control movement (although it is questionable whether he can use this information precisely).

2.2.4 Inertia (Inertial Resistance) ^{3, 37, 42, 46, 47, 48, 54, 70}

- a. Varies directly with control acceleration but is independent of displacement and velocity.

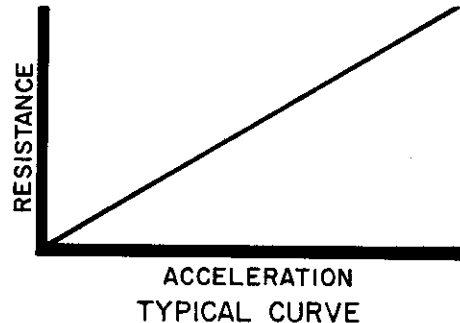

- b. Resists sudden changes in velocity, and thus aids in making smooth movements or gradual changes in velocity.
- c. Reduces fluctuations of movement due to small vibrations and tremor.
- d. Requires that large forces be applied in order to stop control movements quickly. Hinders any changes in direction of movement.

- e. Provides the operator with feedback information ("feel") about the acceleration of control movements (although it is questionable whether he can use this information precisely).
- f. Increases the difficulty of making precise adjustments quickly because of the danger of overshooting.
- g. High inertia can be used to maintain control movement without requiring continual application of force (e. g., spinning a handwheel to its off position).

2.3 CONTROL CODING⁴⁹

The primary purpose of coding controls is to make them easy to identify.

Making controls easy to identify will decrease the number of times a wrong control is used and will reduce the time required to find the correct control.^{19, 33} The proper application of control coding will be reflected not only in improved operator performance but also in reduced training time.

There are innumerable methods of coding controls. The six most common methods (each of which will be covered in detail in the subsections following) are:

Location	Mode-of-operation
Shape	Labeling
Size	Color

CONTROL DESIGN
Control Coding

Controls

These methods are self-evident except for mode-of-operation, which refers to coding on the basis of the type of movement associated with the control (e. g. , vertical movement against tension is typical of and reminds one of a toggle switch; rotary movement with detent action is typical of and reminds one of a rotary selector switch).

To some extent, control coding is the natural result of good workplace design (e. g. , standardized control positions aid in identification). However, when the primary purposes of control coding have not been met by other means, coding is in order. Important controls should always be easily distinguishable.

The specific type(s) of coding to be used depends upon:

- a. Total demands upon the operator during the time when the control must be identified.
- b. Extent and types of coding already in use.
- c. Illumination of the operator's workplace.
- d. Speed and accuracy with which controls must be identified.
- e. Space available for location of controls.
- f. Number of controls to be coded.
- g. Effects of coding upon precision, speed and comfort of manipulation.
- h. Cost and availability of special equipment required for coding.

The following rules should be followed in selecting which methods, if any, to use:

- a. Use standard codes when available.^{5, 84}
- b. Combine several methods of coding whenever possible.
- c. Use the code(s) with the most advantages and least disadvantages for each specific situation. A summary of the advantages and disadvantages of each primary method of coding is presented in Table III.

2.3.1 Location Coding

Location coding permits identifying controls by their position. Consistent location coding is an important factor in standardization. When the proper control must be selected without viewing it, location coding depends upon the accuracy with which blind hand reaching movements (i. e. , without looking) can be made to predetermined positions.^{14, 27, 29, 31, 32}

- a. Accuracy of control selection is greatest when controls are in front of the operator at shoulder level.
- b. Accuracy of control selection is better when controls are separated vertically rather than horizontally by the same distance.

RECOMMENDATIONS

- a. Locate the most important and most frequently used controls in front of the operator in the optimum manual area.
- b. When controls must be identified by blind reaching only, separate adjacent controls by at least 5 inches in their optimum location (shoulder level in front of the operator), and increase the separation as a location of the controls departs from the optimum.⁴⁹

TABLE III
Advantages and disadvantages of various types of coding

ADVANTAGES	TYPE OF CODING						
	LOCATION	SHAPE	SIZE	MODE-OF- OPERATION	LABELING	COLOR	
Improves visual identification.	x	x	x		x	x	
Improves non-visual identification (tactual and kinesthetic).	x	x	x	x			
Helps standardization.	x	x	x	x	x	x	
Aids identification under low levels of illumination and/or colored lighting.	x	x	x	x	x*	x*	
May aid in identifying control position (setting).		x		x	x		
Requires little (if any) training; is not subject to forgetting.							
DISADVANTAGES							
May require extra space.	x	x	x	x	x		
Affects manipulatability (ease of use) of the control.	x	x	x	x			

*True only when transilluminated.

TABLE III (Continued)

DISADVANTAGES	TYPE OF CONTROL				
	LOCATION	SHAPE	SIZE	MODE-OF- OPERATION	COLOR
Limited in number of available coding categories.	x	x	x	x	x
May be less effective if operator wears gloves.		x	x	x	
Control must be viewed (i.e., must be within visual areas and with adequate illumination present).					x

2.3.2 Shape Coding

Shape coding may be used for identifying controls visually and/or tactually.^{2, 9, 23} (The ability to discriminate by touch improves with training.²⁴) When feasible, it is desirable to select functional shapes which suggest the purpose of the control; the effectiveness of shape coding depends upon the ease with which shapes can be identified. (A number of knob shapes which may be used if shape coding is indicated are presented in Section 3.5.⁵⁰)

RECOMMENDATIONS

- a. Use standardized shapes whenever possible.^{57, 58, 59, 60, 79} Examples are shown in Figure 1.
- b. Make shapes identifiable visually.
- c. Avoid using sharp edges on the parts of the control which must be grasped.¹

2.3.3 Size Coding

Controls may be coded on the basis of size alone, although the number of sizes that can be used is quite limited.⁸⁰ The ability to discriminate shape is relatively independent of size; therefore, size coding may be superimposed upon shape coding.²⁸

Caution: Both size and shape coding may become less effective as the operator wears thicker gloves.

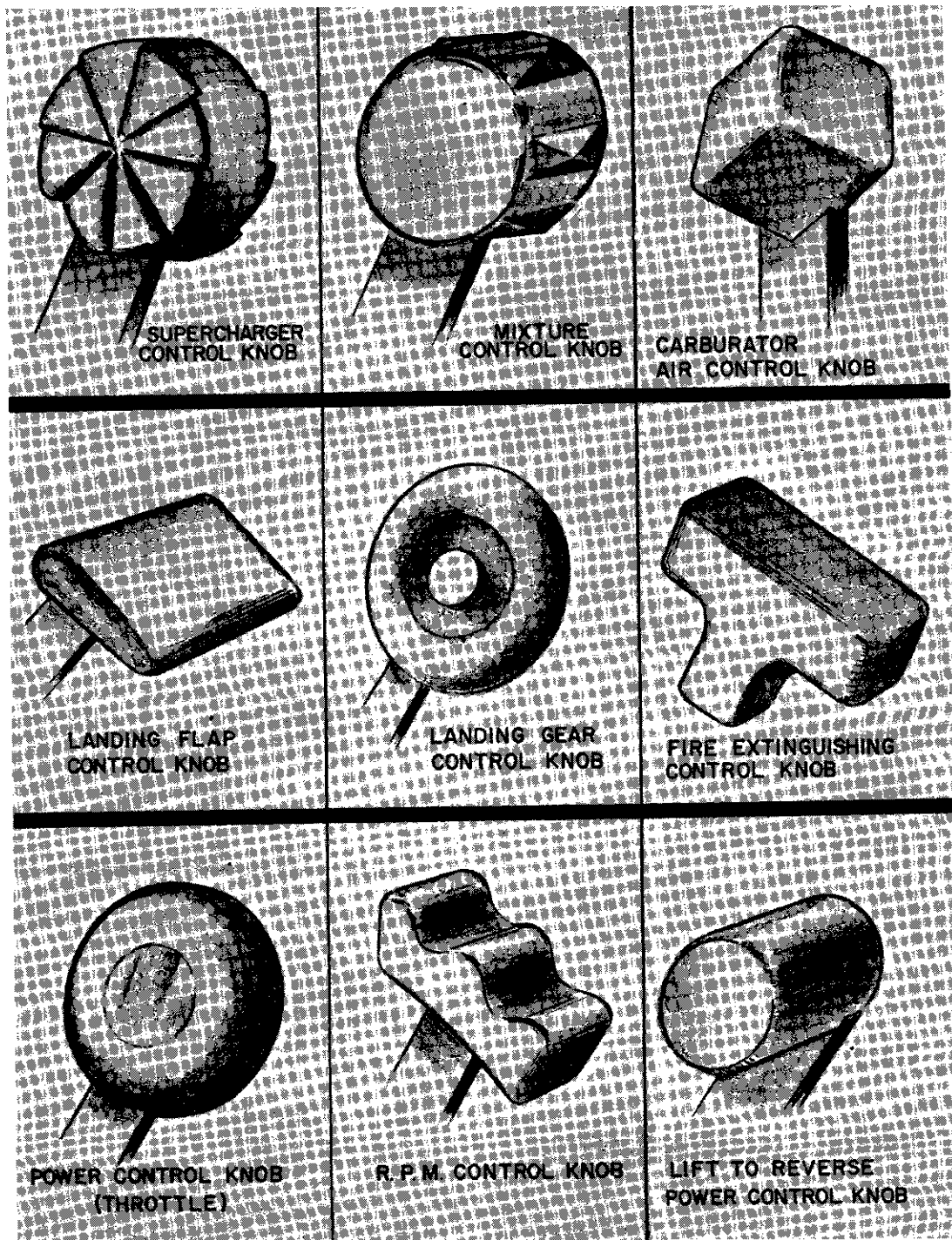

Figure 1. Standardized aircraft control shapes.

RECOMMENDATIONS

- a. When the operator cannot compare the sizes of all controls before selecting the proper one, only two or three different sized controls should be used (viz., small, medium and large).

- b. When the operator always compares two controls before selecting the desired one, size coding can be used for more than three categories.⁴⁹

Detailed information is available for "relative" (as against "absolute") size discriminations. The figure shows the diameters required for two round knobs when the operator compares each by touch alone before deciding which is larger. The larger knob should always be approximately 20 per cent larger than the smaller one for knobs ranging in diameter from 1/2 to 6 inches.

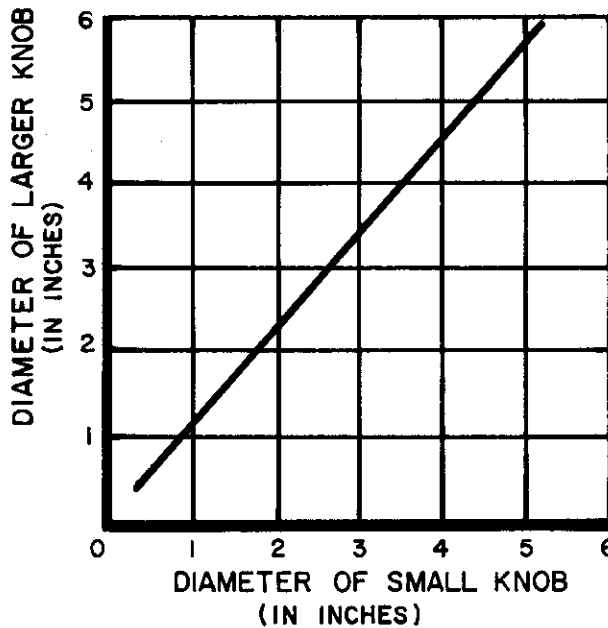

2.3.4 Mode-of-Operation Coding

The mode of operation of a control is a useful method of identifying it, particularly after the operator has become experienced in its usage. This method of coding may always be used with other methods. Its most severe limitation is that the operator must activate the control (or at least attempt to do so) in order to identify it.⁴⁹

RECOMMENDATIONS

- a. To use this method most effectively, the designer should vary one or more of the following: direction of movement, amount of displacement, type and amount of resistance.
- b. None of the above should be varied to the extent that it violates other design principles. (See Part 3.)

2.3.5 Labeling

Labeling is always an effective means of identifying controls and requires no special training. The two main prerequisites are adequate space and lighting.^{5, 19}

RECOMMENDATIONS

- a. The label should be either on the control or immediately adjacent to it.

- b. The label should be brief. However, only common abbreviations should be used (e. g., flaps, UHF, IFF).

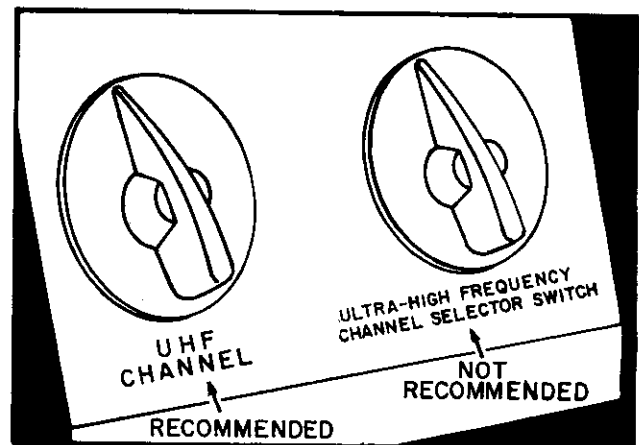

CONTROL DESIGN Control Coding

- c. The label should tell what is being controlled (e.g., landing gear, brightness).
- d. Common words should be used, technical words only when they are familiar to all operators (e.g., azimuth, elevation).
- e. Abstract symbols (squares, stars, etc.) should not be used when they require special training. Common symbols, used in a conventional manner, are acceptable (e.g., per cent sign, arrow).
- f. Letters and numerals should be standardized (see AND 10400) and easily legible (see HIAD 6A.201 and MIL-C-10812).

2.3.6 Color Coding ^{5, 78, 85}

Color coding is most effective when a specific meaning can be attached to the color (e.g., red for danger). The color of the control depends largely upon the color of the illuminant; controls will reflect their own colors only if illuminated by a white light. As intensity of illumination is reduced, the color of the control changes and is gradually lost. Hence, for color coding, at least a moderate amount of white light must be used. In general, color should not be used as the primary method for coding controls; it is effective when combined with other methods.

RECOMMENDATIONS

- a. Color coding should conform with existing standards. Table IV shows some examples; other special codes have been developed for electrical wiring, hydraulic lines, compressed gas cylinders, etc.

TABLE IV

General standards for color coding

COLOR	SAFETY CODE ①	AIRCRAFT COMPONENT COLORS ②	GROUND EQUIPMENT COLORS ③
Red	Fire protection equipment Fire exit signs Danger Stop	Fire warning light Fire extinguisher control handle (clear plastic with internal red warning light) Landing gear control handle (clear plastic with internal red warning light) First aid kits (red cross on white)	Safety and protective equipment (with red warning streamers where attached to airplane) Crash fire and rescue vehicles Fire protection equipment Danger and stop signs
Light amber	---	Master caution light	---
Orange	Dangerous parts of equipment High voltage areas	---	High voltage areas
Orange-yellow	---	Emergency exits and exit releases	Vehicles used on airport (with black stripes) Caution signals
Yellow	Caution; physical hazards (also yellow and black stripes)	---	Flight line equipment Physical hazards
Green (olive drab)	Safety and first aid equipment	---	Safety and first aid equipment First aid boxes (green cross on white) Aviator's breathing oxygen cylinder (with white band) Interiors of closed ground vehicles Gas masks Safe signal
Blue	Caution; "don't start" or equipment under repair	---	Covered electrical outlets Fuse box exteriors Exteriors of ground vehicles
Purple	Radiation hazards	---	---
Black	Traffic markings within enclosed areas (also black-white combinations)	Glare shields, control columns, control wheels, control stick grips, edge lighted panels Emergency instructions (black and white diagonal lines which appear black and red at night)	Top surface of vehicles used on snow or sand

① American Standards Association (Z53.1 - 1953) and National Safety Council.

② H1AD C. 2; see reference for flight deck and compartment colors.

③ HIGED A. 2. 7; see reference for color codes for fluid lines, fuses, chassis wiring, compressed gas cylinders, capacitors, resistors and electrical cables.

CONTROL DESIGN
Accidental Activation Prevention

- b. In general, only five colors should be used: red, orange, yellow, green, blue. However, additional colors can be used when essential.

Even under ideal conditions, an operator has difficulty in using effectively more than 10 or 12 colors. He can recognize many more colors but is limited primarily by his ability to attach a name to each.^{19, 49}

2.4 METHODS OF PREVENTING ACCIDENTAL ACTIVATION

It is frequently necessary to reduce the possibility of accidental activation of controls. In some situations controls may be located such that they are susceptible to being moved while reaching for, or operating, another control. In other situations the activation of a control may have such serious implications that it becomes desirable to design the control so that it cannot be operated in haste.

Seven methods of physically protecting controls against inadvertent activation are described in the following subsections. In the application of any of these methods, it is necessary to consider the extent to which other human engineering design features are compromised. For example, in some instances, even though the method provides protection against accidental activation, it increases the time required to operate the control to such an extent that it is unacceptable.

2.4.1 Recessing

Controls are recessed into the control panel so that they do not protrude. The major disadvantage of this method is the relatively large amount of

panel space consumed. A related technique is that of placing raised barriers around the control under consideration. For the control shown in the drawing below, an application of the barrier method might consist of a circular wall surrounding the control.

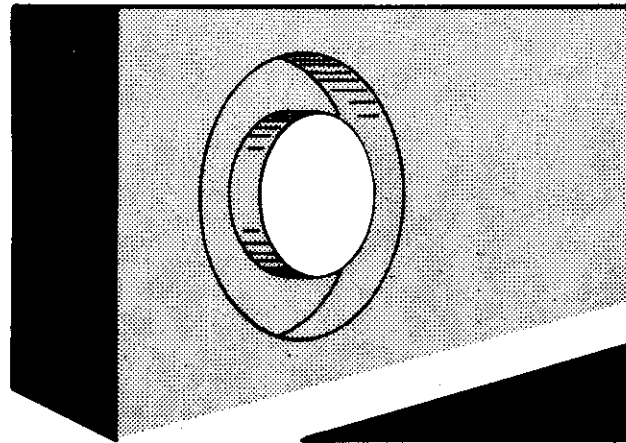

2.4.2 Location

Controls are located so that they are unlikely to be hit accidentally. This may be done by isolating one control from the others, or by arranging the controls so that the sequence of operations is not conducive to accidental activation of any control.

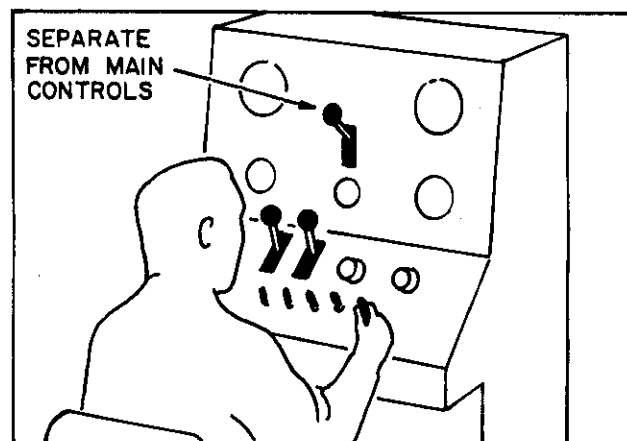

CONTROL DESIGN Accidental Activation Prevention

2.4.3. Orientation

The direction of movement of the control is oriented along an axis in which accidental forces are least likely to occur. Particular care should be taken to insure that desirable direction-of-motion relationships are not violated.

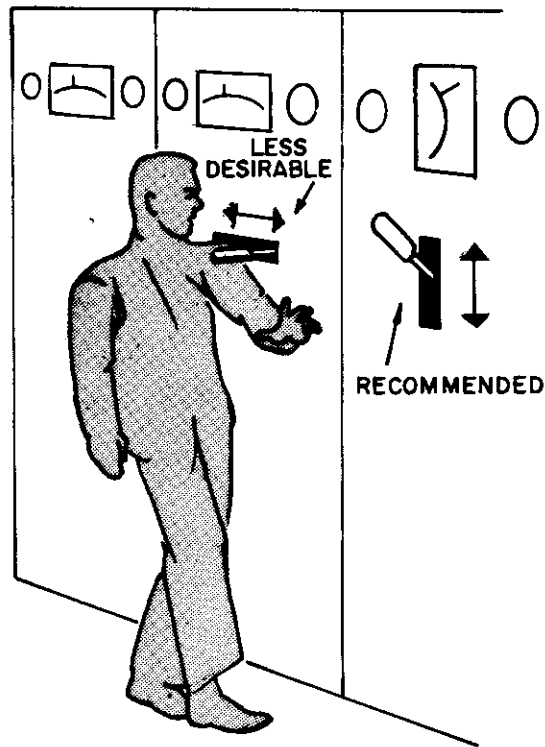

2.4.4 Covering

Protective covers or guards are placed over each control. If the control under consideration is operated frequently, this method should probably not be used.

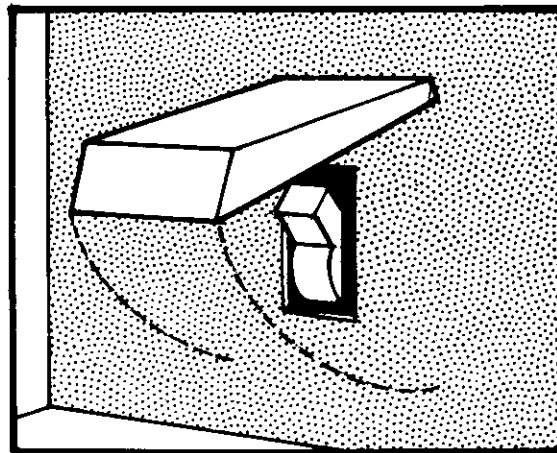

2.4.5 Locking

Controls are locked in position. In general, this method requires the sequential application of force in at least two directions before the control operation has any effect. This method is undesirable if constant locking and unlocking of a frequently operated control is required.

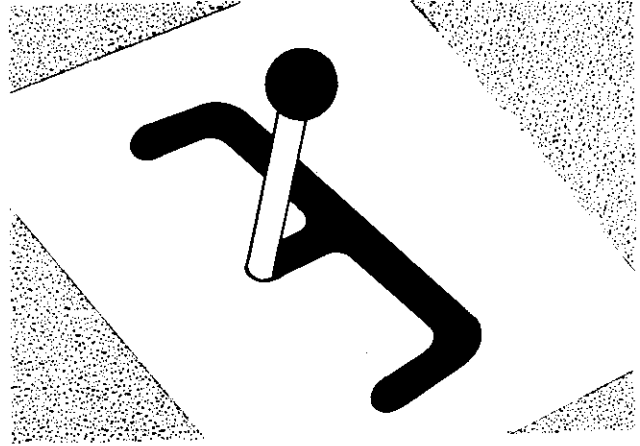

2.4.6 Operation Sequencing

A series of interlocks prevents Step 2 from being performed before Step 1, Step 3 before Step 2, Step 4 before Step 3, etc.

Case I: The steps prior to the last one have a direct effect upon system output. For example, a bomb release control cannot be operated unless the control which arms the bomb has already been activated. This method should not be used in situations where the sequence of operation may vary.

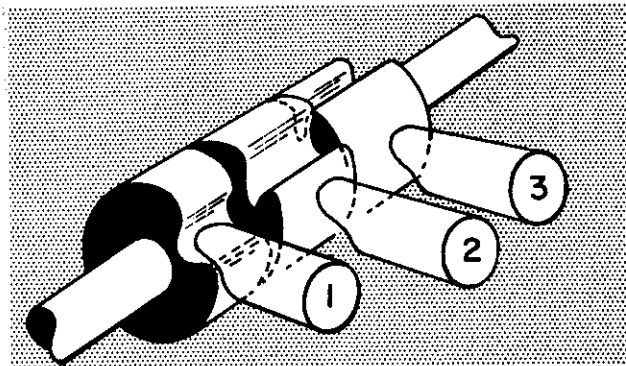

CONTROL DESIGN
Accidental Activation Prevention

Case II: The steps of operation prior to the final one have no direct result on the system output other than permitting the next control operation to be performed. In the simplest situation, a preliminary operation (e. g., pushing a button, squeezing a trigger) releases the control for its normal operation.

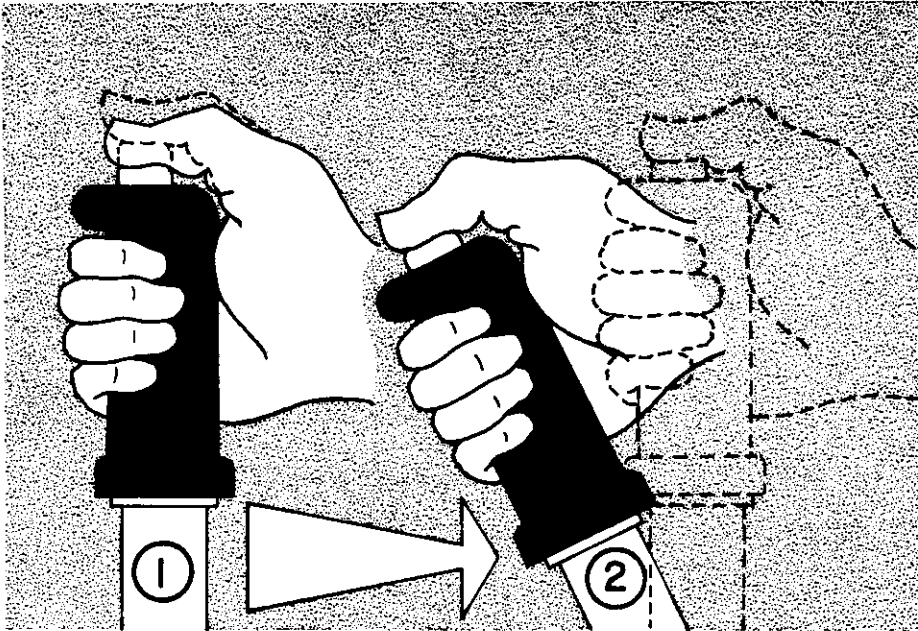
**2.4.7 Resistance**

Use of the proper type(s) and amount(s) of resistance prevents accidental forces (below the breakout force) from activating the control. A detailed coverage of resistance is found in Section 2.2.

PART 3

DETAILED DESIGN RECOMMENDATIONS FOR SPECIFIC CONTROLS

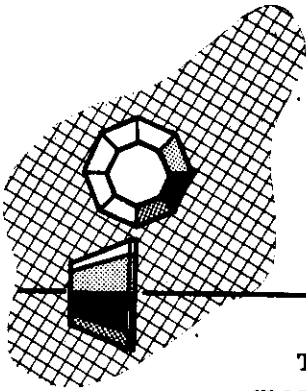

This part presents detailed recommendations for the design of the nine most commonly used controls (as defined in Part I):

- | | |
|----------------------------|---------------|
| 3.1 Hand Push Button | 3.6 Crank |
| 3.2 Foot Push Button | 3.7 Handwheel |
| 3.3 Toggle Switch | 3.8 Lever |
| 3.4 Rotary Selector Switch | 3.9 Pedal |
| 3.5 Knob | |

The design of controls similar to those listed above can be helped by extrapolating from these recommendations. The design of combined controls (e.g., a hand push button mounted on a lever) can be established from recommendations for individual controls.

The following design factors are covered for each control:

- Size:** Recommended dimensions (minimum and maximum) for each control.

- b. Displacement: Recommended range of control movement and, when applicable, optimum control-display (C/D) ratio.
- c. Resistance: Recommended amounts and types of resistance to be built into each control.

Note: For toggle switches, handwheels, cranks and levers, resistance is described in terms of linear resistance (i. e., the resistance at the point where the operator applies force to the control) rather than torque. For these controls, operator output can normally be considered as a force relatively independent of control radius.

For circular knobs resistance is described in terms of torque. The force which can be brought to bear on the control is a function of the "efficiency" of the operator's grasp (i. e., the amount by which the fingers must be spread, etc.), which, in turn, is related to knob diameter.

- d. General: Certain design recommendations specific to a given control but not generally applicable to all controls.

CAUTION: MOST OF THE VALUES RECOMMENDED IN THIS PART ARE BASED UPON THE AUTHORS' JUDGMENTS AND OBSERVATIONS RATHER THAN PUBLISHED RESEARCH. THEY ARE OFFERED AS GENERAL GUIDES AND ARE BELIEVED TO BE APPLICABLE FOR MOST NORMAL OPERATING CONDITIONS. UNDER SPECIAL CIRCUMSTANCES, SUCH AS THOSE CAUSED BY UNUSUAL ENVIRONMENTAL CONDITIONS, OTHER VALUES MAY BE MORE APPROPRIATE.

3.1 HAND PUSH BUTTON

3.1.1 Size

a. Minimum Diameter

Fingertip operation:

1/2 inch

Emergency controls which can be activated by thumb or heel of the hand:

3/4 inch

b. Maximum Diameter

No limitations set by operator performance.

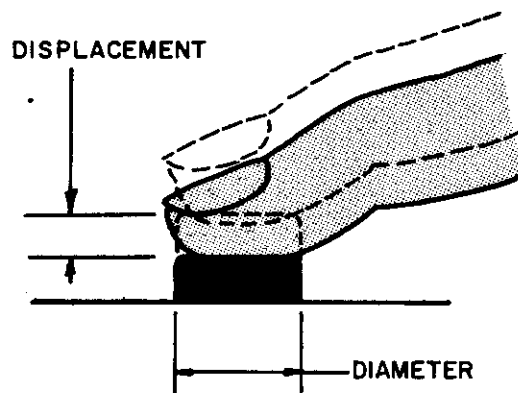

3.1.2 Displacement

a. Minimum:

1/8 inch

b. Maximum

For operation by thumb or fingertip:

1-1/2 inches

**DETAILED DESIGN RECOMMENDATIONS
Hand Push Button**

3.1.3 Resistance

a. Minimum

- Fingertip operation: 10 ounces
- Little finger squeeze: 5 ounces

b. Maximum

- Fingertip operation: 40 ounces
- Little finger squeeze: 20 ounces

c. Types of Resistance

1) Use elastic resistance, aided by a slight amount of sliding friction, if necessary, starting low and building up rapidly, with a sudden drop to indicate that the control has been activated.

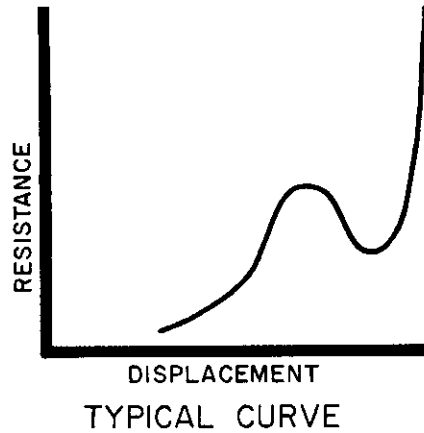

2) Minimize viscous damping and inertia.

3.1.4 General

a. Shape should be concave inward to fit the finger. When this is impractical, the surface should provide a high degree of frictional resistance to prevent slipping.

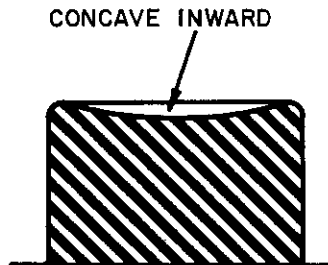

- b. To indicate that the control has been activated, an audible click should be provided when the working environment is not too noisy.
- c. For various means of coding and of preventing accidental activation, see Sections 2.3 and 2.4, respectively.

3.2 FOOT PUSH BUTTON

3.2.1 Size

a. Minimum Diameter: 1/2 inch

b. Maximum Diameter:

No limitations set by operator performance.

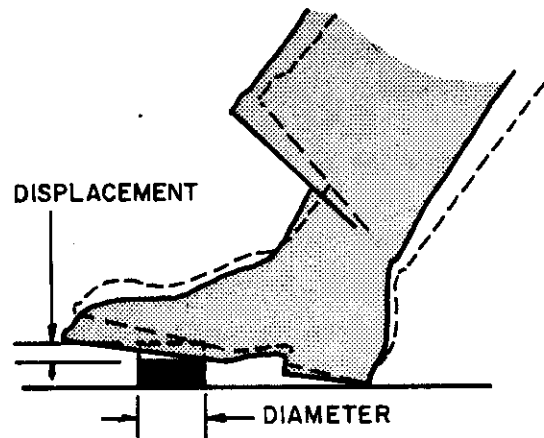

3.2.2 Displacement

a. Minimum

Normal operation: 1/2 inch

Operator wearing heavy boots: 1 inch

DETAILED DESIGN RECOMMENDATIONS
Foot Push Button

Controls

b. Maximum

Controls operated by ankle flexion only:^{13, 67} 2-1/2 inches

Controls operated by leg movements: 4 inches

3.2.3 Resistance

a. Minimum

Foot will not rest on the control: 4 pounds

Foot may rest on the control: 10 pounds

b. Maximum

Normal operation with foot resting or not resting on control: 20 pounds

c. Types of Resistance

- 1) Use elastic resistance, aided by static friction, to support foot.
- 2) Resistance should start low, build up rapidly, then drop suddenly to indicate that the control has been activated.
- 3) Minimize viscous damping and inertia.

3.2.4 General

Controls should normally be designed for toe-operation (by the ball of the foot) rather than heel-operation. Where space permits, push buttons should be replaced by a pedal hinged at the heel. This device serves as a push button while aiding in locating and activating the control.⁸

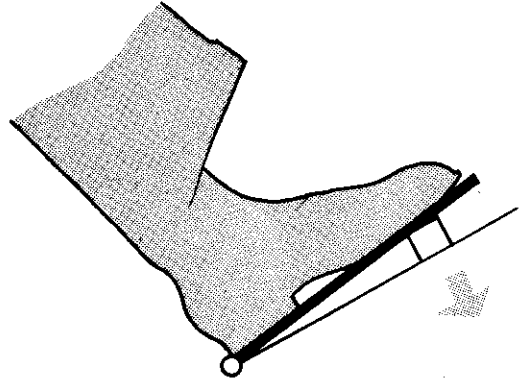

3.3 TOGGLE SWITCH

3.3.1 Size

a. Control Tip Diameter

Minimum: 1/8 inch

Maximum: 1 inch

b. Lever Arm Length

Minimum: 1/2 inch

Maximum: 2 inches

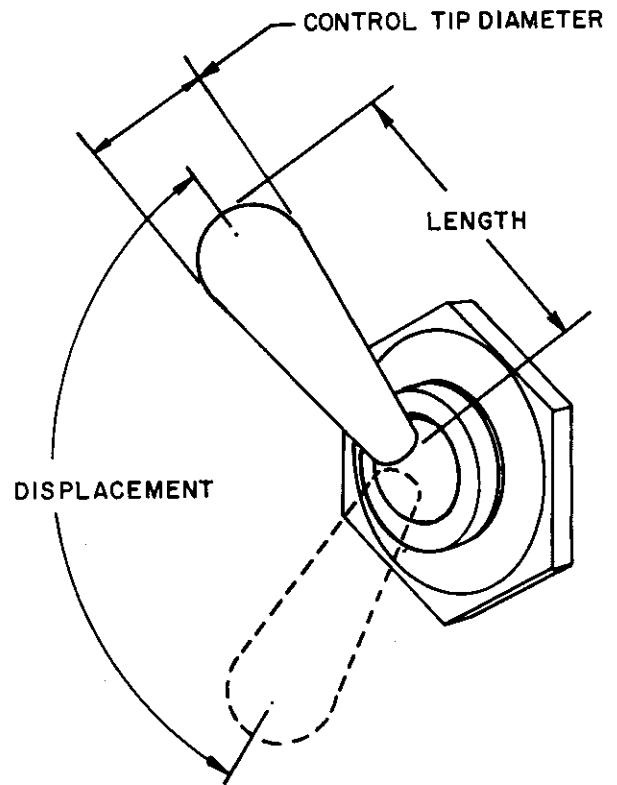

3.3.2 Displacement

- a. Minimum (between adjacent control positions): 40°
- b. Maximum (total displacement): 120°

3.3.3 Resistance*

- a. Minimum:⁷⁶ 10 ounces
- b. Maximum: 40 ounces

c. Types of Resistance

- 1) Use elastic resistance which builds up, then decreases as the desired position is approached, so that the control will snap into its position and cannot stop between adjacent positions.
- 2) Minimize friction and inertia.

3.3.4 General

- a. Toggle switches are always considered discrete adjustment controls. Small controls the same size and shape as toggle switches but used for

*Measured as a linear force applied at a point on the tip. See Introduction to this Part for rationale.

making continuous (non-detent) adjustments are covered under Levers (Section 3.8).

- b. When levers are used as discrete adjustment controls, for lever arms longer than 6 inches, the minimum separation between control positions should be 2 inches.

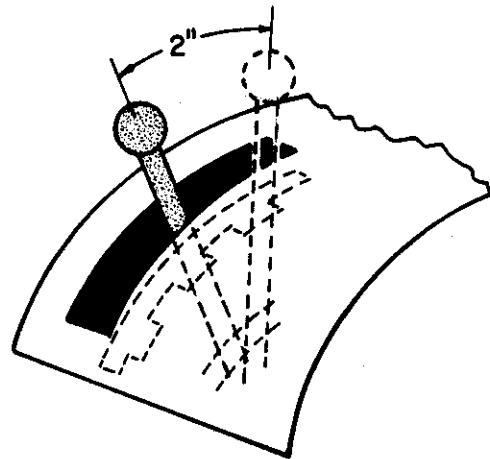

Note: An exception to this is when the control also serves as a visual indicator, in which case control positions may be placed very close to each other, their minimum separation being largely determined by the operator's ability to see it.

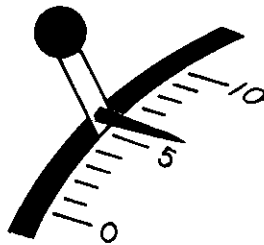

- c. For various means of coding and of preventing accidental activation, see Sections 2.3 and 2.4, respectively.

3.4 ROTARY SELECTOR SWITCH

3.4.1 Size

a. Moving Pointer with Fixed Scale

1) Pointer length

Minimum: 1 inch

Maximum: No limitations set by operator performance

2) Pointer width

Minimum: No limitations set by operator performance

Maximum: 1 inch

3) Pointer depth

Minimum: 1/2 inch

Maximum: 3 inches

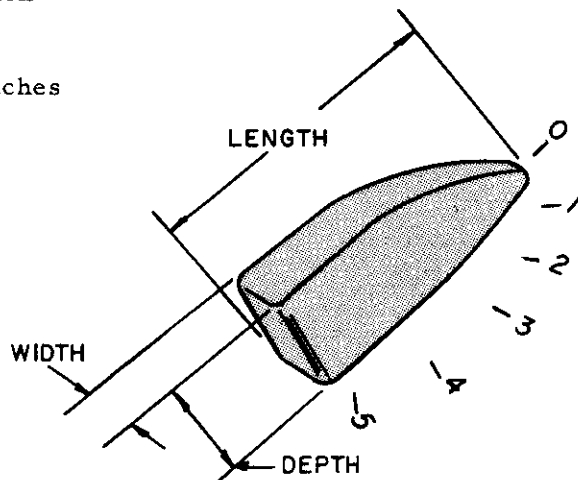

b. Moving Scale with Fixed Index

1) Knob diameter

Minimum: 1 inch

Maximum: 4 inches

2) Knob depth

Minimum: 1/2 inch

Maximum: 3 inches

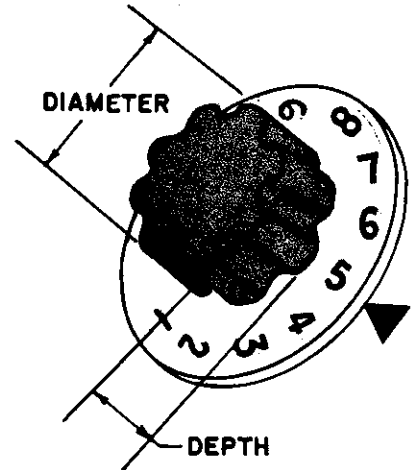

3.4.2 Displacement ^{17, 18, 84}

a. Minimum (between adjacent detents)

For visual positioning: 15°

For non-visual positioning: 30°

b. Maximum (between adjacent detents)

For facilitating operator performance: 40°

When special engineering requirements demand large separations: 90°

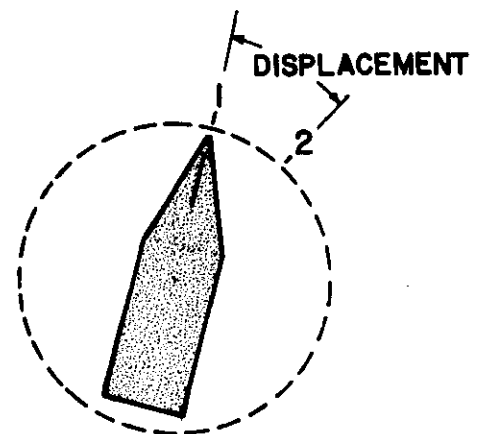

DETAILED DESIGN RECOMMENDATIONS
Rotary Selector Switch

3.4.3 Resistance*

a. Minimum: 12 ounces

b. Maximum: 48 ounces

c. Types of Resistance:

1) Provide detents at each control position (setting). Use elastic resistance which builds up, then decreases as each detent is approached, so that the control will fall into each detent and cannot easily stop between adjacent positions (detents).

2) Minimize friction and inertia.

3.4.4 General

a. It is undesirable for a rotary selector switch to have more than 24 positions. However, when more positions must be made available, the minimum separation between adjacent positions should be 1/4 inch at the index marks.

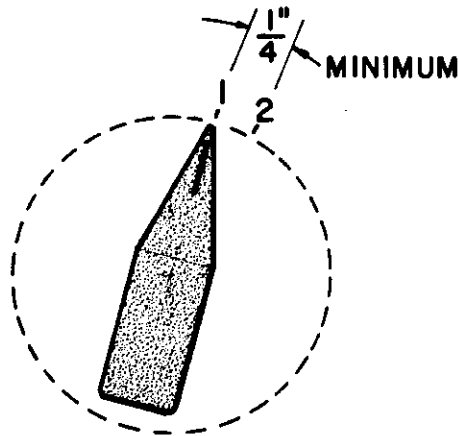

*Measured as a linear force when applied at a point on a non-circular knob. (See Introduction to this Part for rationale.) Round knobs should not be used as detent controls because they are not effective for the application of large torques.

- b. Whenever possible, control positions should not be 180° from each other in order to reduce errors in setting and in reading the wrong end of the moving pointer.

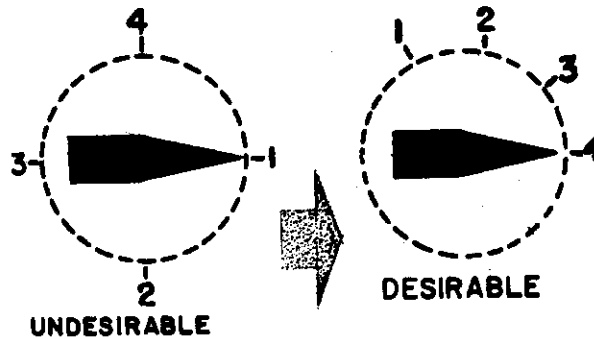

- c. Whenever feasible, stops should be placed at the beginning and end of the range of control positions. This will facilitate blind-positioning by enabling the operator to count the number of settings (by the feel of the detent action or by the sound of the click) from a starting position.
- d. Moving pointers should have bar-type knobs with tapered tips.

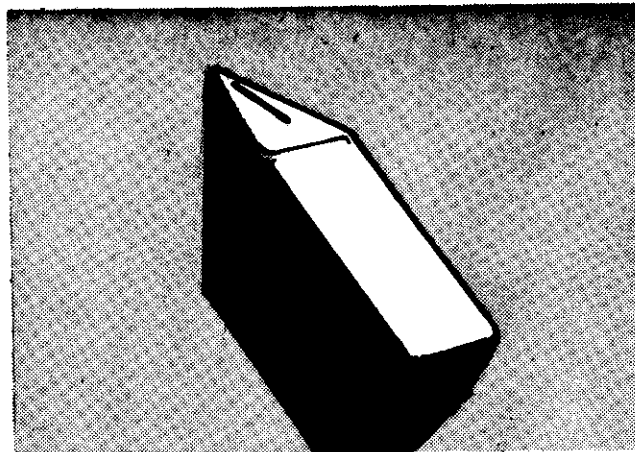

- e. These controls lend themselves well to shape coding. For detailed recommendations on shape coding, see Section 3.5.4. For other means of coding and of preventing accidental activation, see Sections 2.3 and 2.4, respectively.

DETAILED DESIGN RECOMMENDATIONS
Rotary Selector Switch

f. A moving pointer with a fixed scale is preferred for most tasks; however, a moving scale with fixed index can also be used. The primary advantages of each are: ^{5, 27}

1) Moving pointer

Can conform with direction-of-motion relationships without violating other principles.

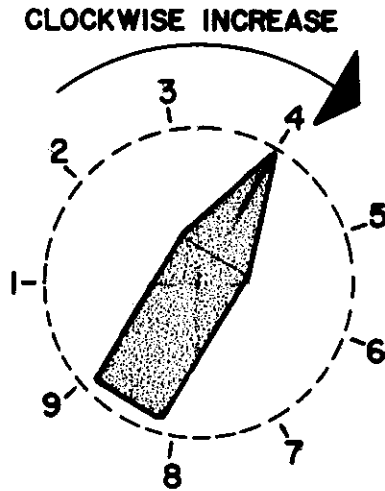

Facilitates check-reading of control position for individual controls and for arrays of controls.

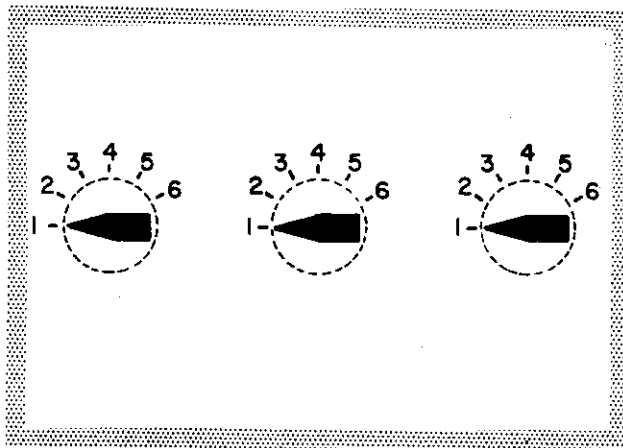

2) Moving scale

Setting of controls always reads from a fixed position.

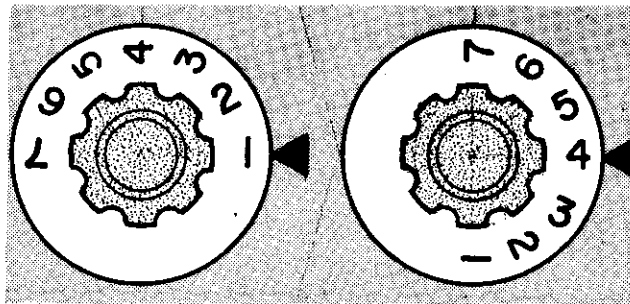

Index can be located at any one of the four cardinal points, depending upon which is most desirable for the specific situation. However, the orientation of the numbers must be altered according to the location of the index.

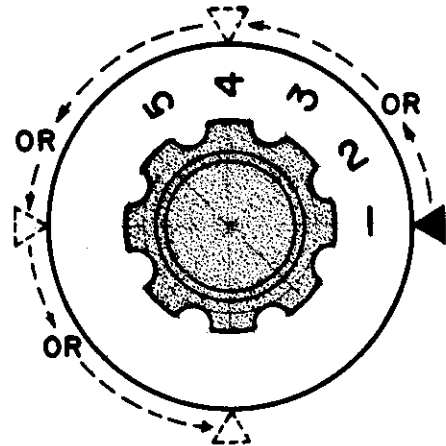

A small segment of the entire scale is all that need be shown through an open window, thereby reducing clutter.

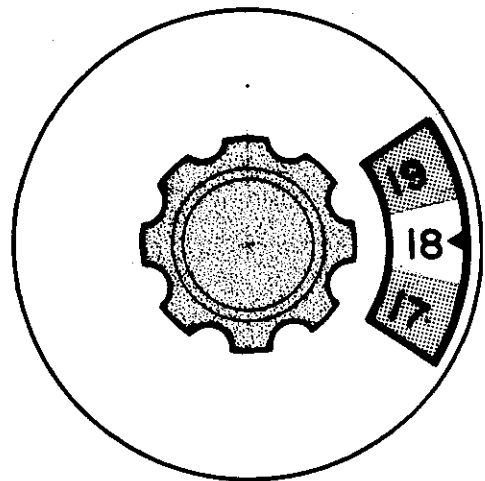

3.5 KNOB

3.5.1 Size

Note: Within the ranges recommended below, knob size is relatively unimportant provided the C/D ratio is optimum, the resistance low and the knob easily grasped.⁵² When panel space is limited, the use of minimum values for knob size will not degrade performance provided the resistance is very low.⁷⁵

DETAILED DESIGN RECOMMENDATIONS
Knob

a. Fingertip Grasp

1) Depth

Minimum: 1/2 inch

Maximum: 1 inch

2) Diameter

Minimum: 3/8 inch

Maximum: 4 inches

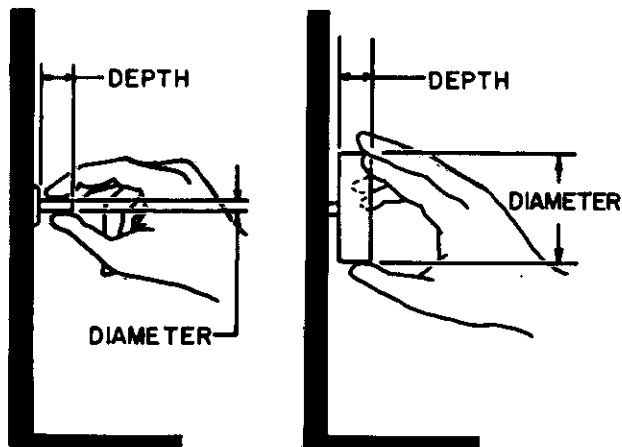

Note: When resistance is very low, knobs may be miniaturized. In this case the minimum depth should probably remain 1/2 inch, but the minimum diameter can be reduced to as little as 1/4 inch.⁷⁵

b. Palm Grasp

Minimum diameter: 1-1/2 inches

Maximum diameter: 3 inches

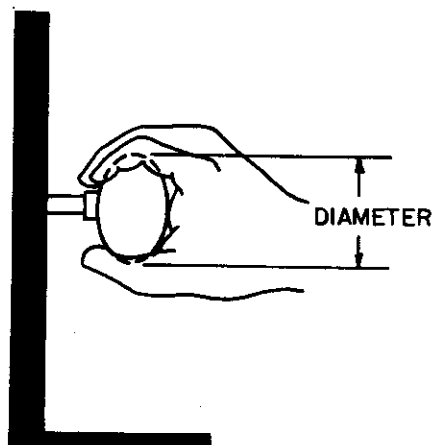

c. Thumb and Fingers Encircled

1) Diameter

Minimum: 1 inch

Maximum: 3 inches

2) Length

Minimum: 3 inches

Maximum: No limitations set by operator performance.

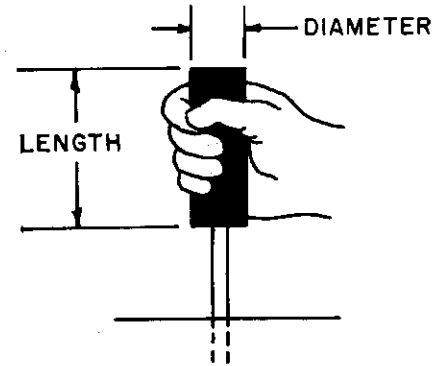
**3.5.2. Displacement**

Displacement should be determined by the desired C/D ratio. (See Section 2.1.)

3.5.3 Resistance

a. Minimum

No practical limit set by operator performance.

Centrails
DETAILED DESIGN RECOMMENDATIONS
Knob

b. Maximum

For fingertip operation with small
(1 inch diameter) knobs: 4-1/2 inch-ounces

For fingertip operation with larger
knobs (above 1 inch diameter): 6 inch-ounces

c. Types of Resistance

- 1) The type(s) of resistance to be provided depends primarily upon performance requirements. (See Section 2.2 for details.)
- 2) When other types of resistance are satisfactory for precise positioning tasks, changes in inertia have little practical effect upon performance (until an excessive level is reached).⁵⁴ The addition of inertia can counteract some of the harmful effects of friction,⁷⁰ and vice versa.

3.5.4 General

- a. Knobs lend themselves well to shape coding. For coding purposes, knobs may be divided into three classes:⁵⁰

Class A: For twirling or spinning, more than one full turn required, knob position unimportant.

Class B: Less than one full turn required, knob position unimportant.

Class C: Less than one full turn required, knob position important.

Figure 2 shows examples of all three classes. (Class A knobs may also be used for Class B functions.) Each knob is discriminable by touch alone

CLASS A

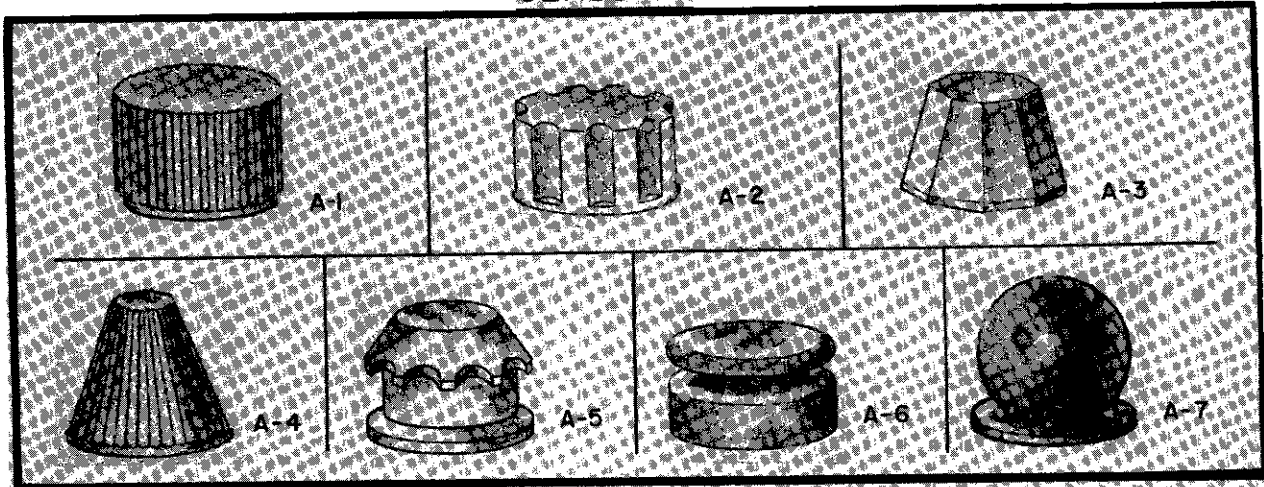

CLASS B

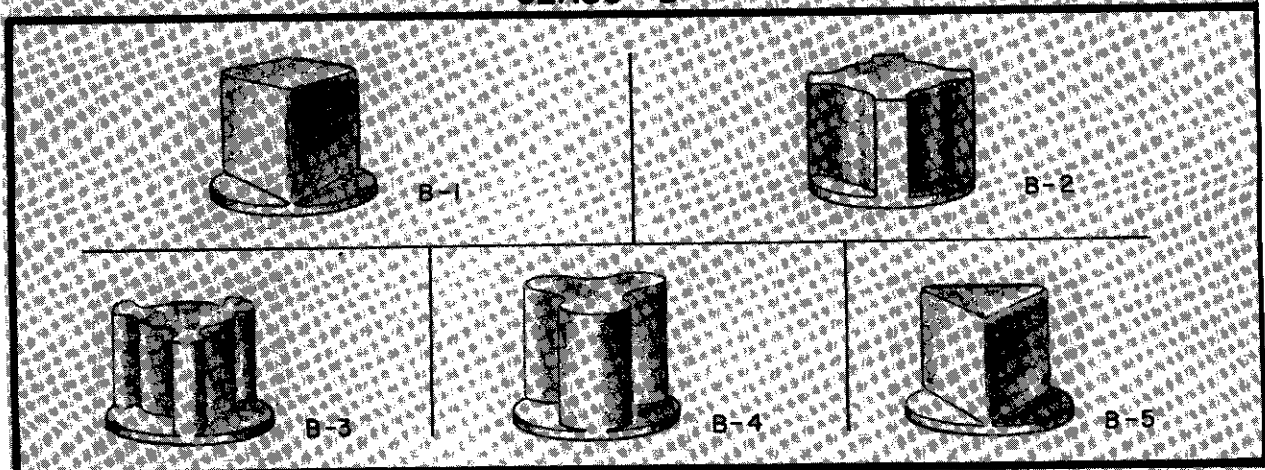

CLASS C

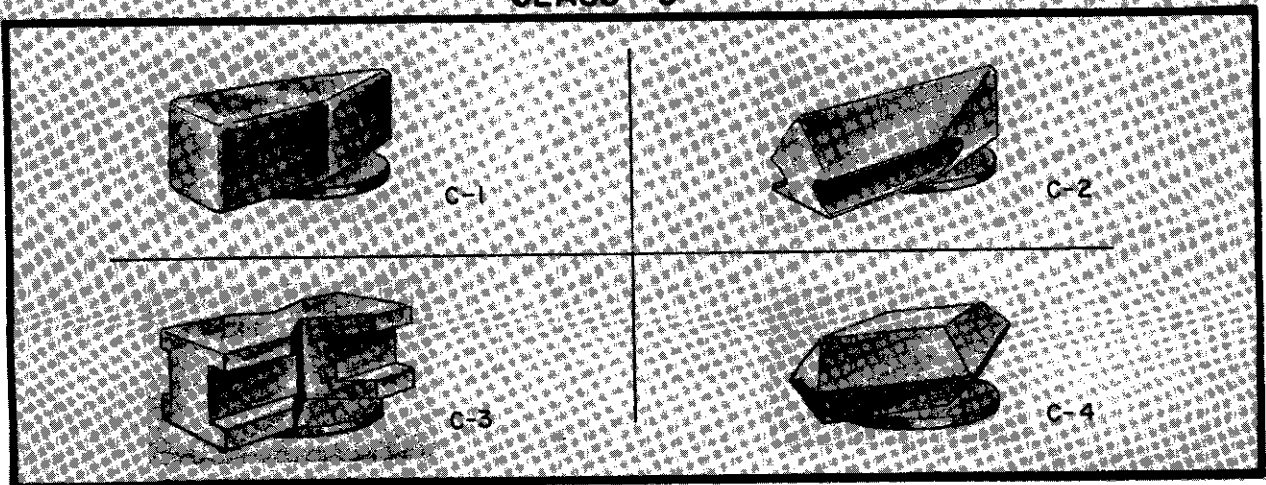

Figure 2. Control Knobs

DETAILED DESIGN RECOMMENDATIONS

Crank

with a bare hand or while wearing a lightweight glove. All of these knobs may be used together without confusing one from another, with the following exceptions:

Do not use Knob A-3 with Knob B-4. Do not use Knob B-1 with Knob B-5.

Do not use Knob B-2 with Knob B-3 or Knob B-4.

- b. For other means of coding and of preventing accidental activation, see Sections 2.3 and 2.4, respectively.
- c. A moving knob with a fixed scale is preferred for most tasks; however, a moving scale with a fixed index can also be used. (See Section 3.4.4 for a comparison of the primary advantages of each.)
- d. When bracketing is used for locating a visual or auditory null position (e.g., tuning a transmitter), the knob should move through an arc of 30° - 60° on either side of the null position in order for a misalignment to be just noticeable.²³

3.6 CRANK

3.6.1 Size

Minimum radius: 1/2 inch

Maximum radius:

Heavy load: 20 inches

Minimum load and very high (up to 275 rpm) rate:⁶⁸ 4-1/2 inches

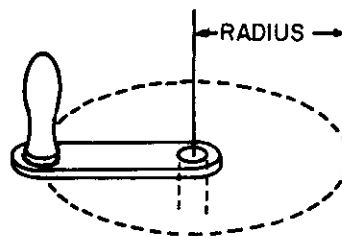

Under no-load conditions, small cranks can be turned more rapidly than large ones. However, as the load increases, the crank size which maximizes turning rate also increases.⁴

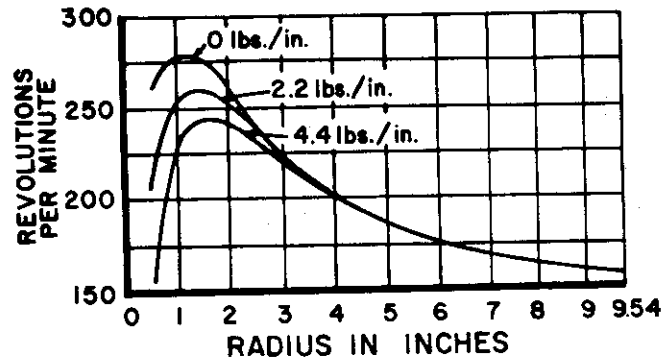

For rotating a crank at a constant rate, larger cranks (approximately 4-1/2 inch radius) are better than smaller ones.³⁸

3.6.2 Displacement

- a. Displacement should be determined by the desired C/D ratio. (See Section 2.1.)
- b. Cranks should be used primarily for tasks involving at least two rotations of control movement. Knobs and handwheels are better when the task requires less movement.

DETAILED DESIGN RECOMMENDATIONS

Crank

- c. For tasks involving large slewing movements plus small fine adjustments, a crank handle may be mounted on a knob or handwheel--the crank to be used for slewing, the knob or handwheel for fine adjusting.⁵² (An alternative design is to provide rate-control rather than position-control for such tasks.)

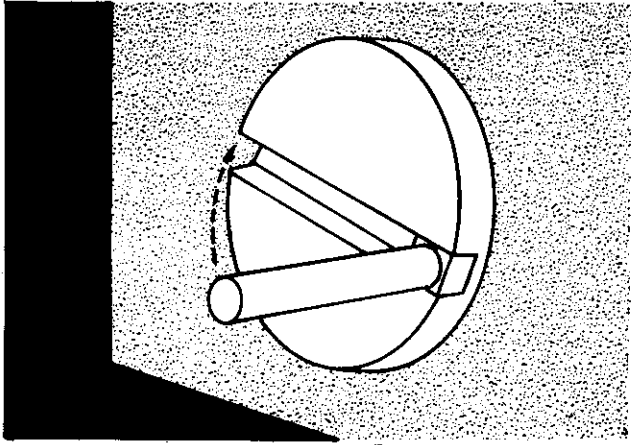

3.6.3 Resistance^{* 38}

- a. Small Cranks (less than 3-1/2 inch radius)

High-speed operation (rapid, steady turning)

Minimum: 2 pounds

Maximum: 5 pounds

- b. Large Cranks (5-8 inch radius)

- 1) High-speed operation (rapid, steady turning)

*Measured as a linear force applied at a point on the handle. See Introduction to this Part for rationale.

Minimum: 5 pounds

Maximum: 10 pounds

2) Making precise settings (adjusting between 1/2 - 1 rotation)

Minimum: 2-1/2 pounds

Maximum: 8 pounds

c. Types of Resistance

- 1) The type(s) of resistance to be provided depends primarily upon performance requirements. (See Section 2.2 for details.)
- 2) In general, any resistance will decrease the maximum rate of turning (about 275 rpm),^{47, 68}
- 3) Friction (2-5 pounds) reduces the effects of jolting.⁴⁵
- 4) Friction degrades performance in rotating a crank handle at a constant rate: primarily at low rates (3-10 rpm), slightly at moderate rates (about 30 rpm), negligibly at high rates (above 100 rpm).^{37, 42}
- 5) Inertia aids performance in rotating crank handles at a constant rate, particularly for small cranks and at low rates.^{37, 42}

3.6.4 General

- a. The grip handle should be designed so that it turns freely around its shaft.

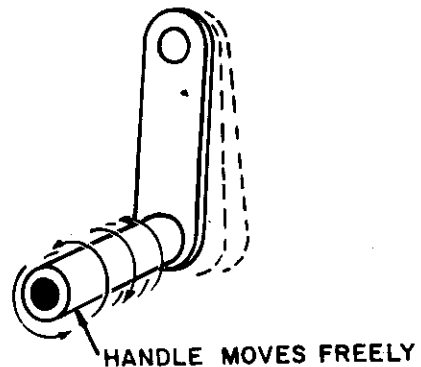

DETAILED DESIGN RECOMMENDATIONS
Handwheel

- b. For means of coding and of preventing accidental activation, see Sections 2.3 and 2.4, respectively.

3.7 HANDWHEEL ^{34, 35}

3.7.1 Size

Note: Handwheels are designed for two-hand operation. ^{21, 22} Rotary controls small enough to be grasped by one hand are classified as knobs and are covered in Section 3.5.

a. Handwheel Diameter

Minimum: 7 inches

Maximum:

Seated operator with hands at each end of the diameter (most desirable position for making precise setting): 21 inches

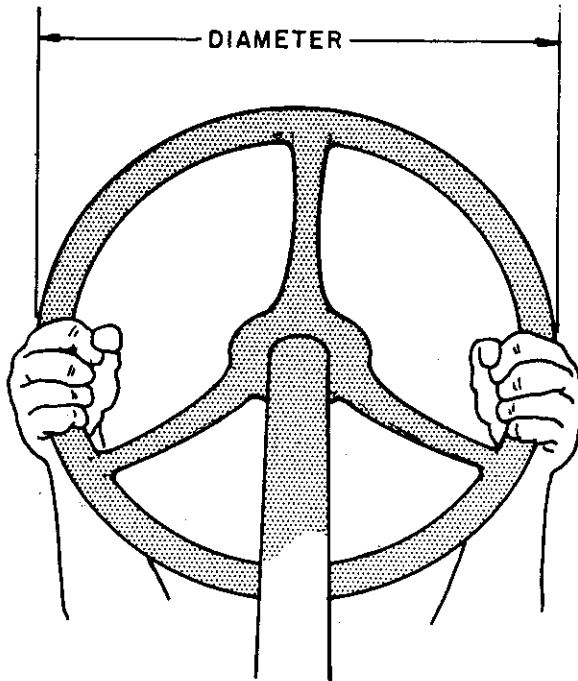

Operator does not have to hold handwheel at opposite ends of its diameter:

No limitations set by operator performance.

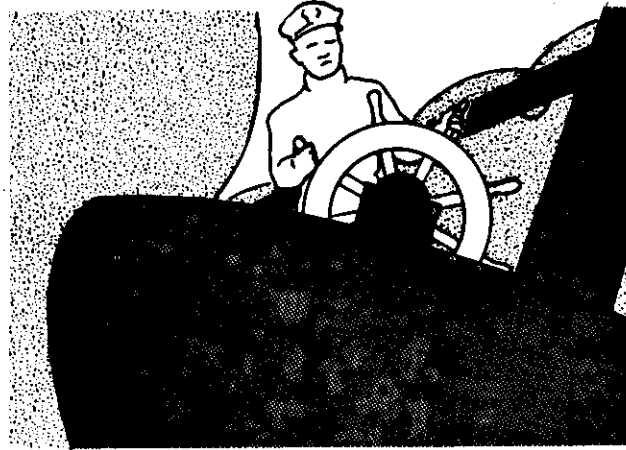

b. Cross-Sectional Diameter of Rim

Minimum: 3/4 inch

Maximum: 2 inches

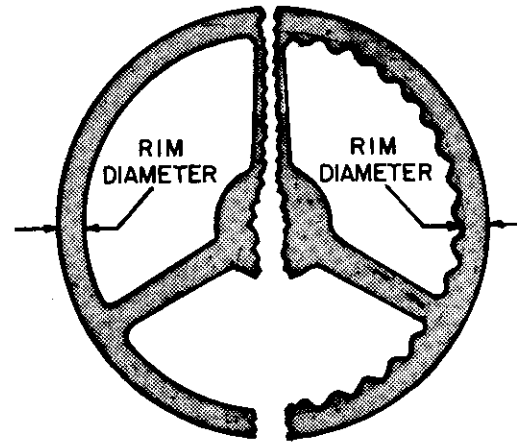

3.7.2 Displacement

- a. Displacement should be determined by the desired C/D ratio. (See Section 2.1.)

DETAILED DESIGN RECOMMENDATIONS
Handwheel

- 1) When the handwheel moves through a large arc, the C/D ratio can be increased either by increasing the number of control rotations per unit movement of the controlled object or by increasing handwheel diameter.

 - 2) When the handwheel movement is limited to small arcs, the C/D ratio can be increased by increasing the handwheel diameter. In such situations, control movements are nearly linear; hence, increasing the extent of control movement will increase the C/D ratio even though the arc of rotation (as measured in angular units) is not increased.
- b. A maximum displacement of 90° - 120° is desirable provided the optimum C/D ratio is not hindered. Larger displacements require the hands to shift position on the control.

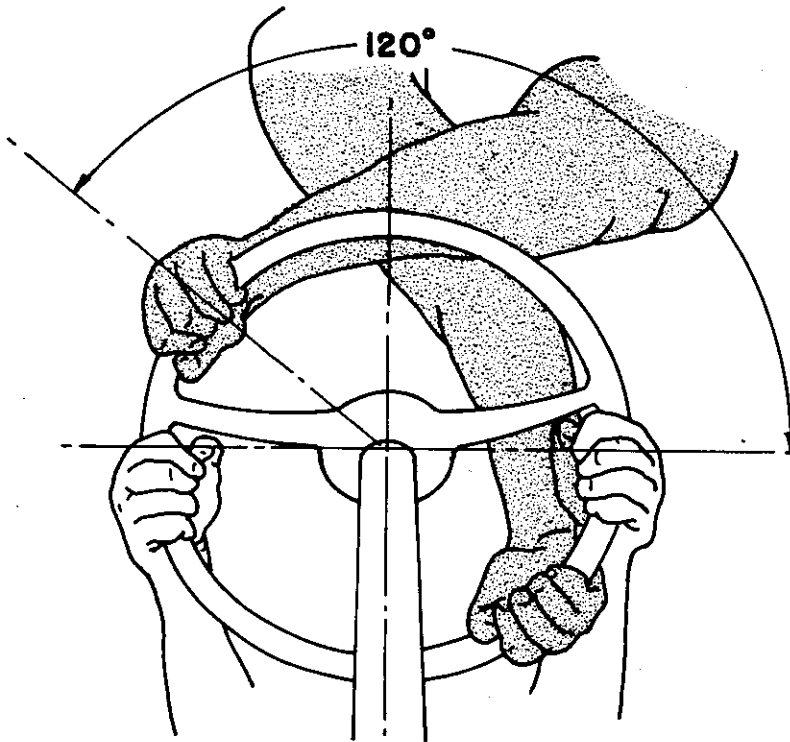

3.7.3 Resistance*

- a. Minimum: 5 pounds
- b. Maximum:
 - One-hand operation: 30 pounds
 - Two-hand operation: 50 pounds

Note: A seated operator can apply most force (torque) to a handwheel when it is located 16-19 inches forward of the Seat Reference Point.^{40, 65}

c. Types of Resistance

- 1) The type(s) of resistance to be provided depends primarily upon performance requirements. (See Section 2.2 for details.)
- 2) For controls moving through small arcs, inertia should be minimized.^{46, 47}
- 3) For aircraft wheels, resistance should be elastic and increase non-linearly from 5 to 30 pounds.⁸⁴

3.7.4 General

- a. Indentations should be built into the handwheel to aid in holding it.

*Measured as a linear force applied at a point on the circumference. See Introduction to this Part for rationale.

DETAILED DESIGN RECOMMENDATIONS

Lever

b. When large displacements must be made rapidly, a crank handle may be attached to the handwheel.

c. When the maximum displacement is less than 120°, only the two sections of the handwheel which the operator grasps may be provided.

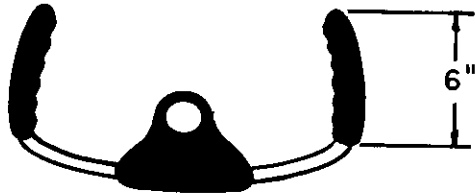

These parts are usually the chords of arcs, each approximately 6 inches long, across from one another. (Eliminating the rest of the control increases the visual and pedal areas.)^{27, 84}

d. For means of coding and of preventing accidental activation, see Sections 2.3 and 2.4, respectively.

3.8 LEVER*

3.8.1 Size

a. The desired length is a function of each specific situation, and is often determined by the mechanical advantage which is needed.

b. In making large fore-aft movements, a long lever is usually more desirable than a short one because movements of the long lever are more nearly linear.⁵⁶

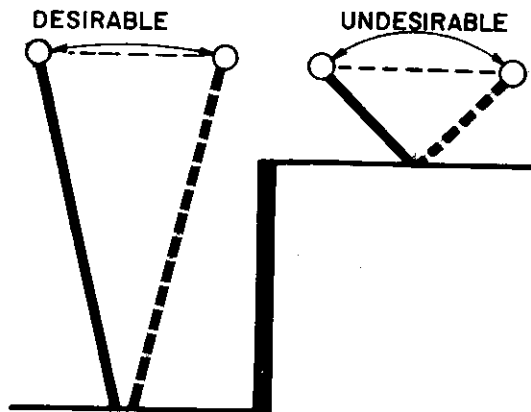

*Includes joystick.

3.8.2 Displacement

a. Minimum: None

b. Maximum:

Fore-aft movements: 14 inches⁶⁵

Lateral movements: 38 inches⁵⁶

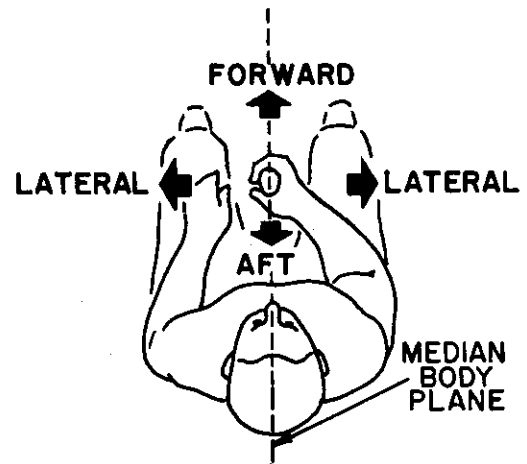

c. Displacement should be determined by the desired C/D ratio. (See Section 2.1.)

3.8.3 Resistance

a. Minimum

Lever handle grasped by hand (rather than finger): 2 pounds

Aircraft joystick:⁶⁴ 5 pounds

b. Maximum^{40, 44, 65}

1) Push-pull (fore-aft) movements

One-hand operation: Control along median plane of body, 10 inches forward from Seat Reference Point: 30 pounds

DETAILED DESIGN RECOMMENDATIONS
Lever

Controls

One-hand operation: Control along
median plane of body, 16-24 inches
forward from Seat Reference Point: 50 pounds

Note: The right hand can apply slightly
more force than the left, but not enough
to be considered significant.

The same amount of force can be applied
(push-pull) when the control is along the
median plane of the body as when it is
directly in front of the arm (7 inches
from the median plane). However, when
it is placed in front of the opposite (un-
used) arm, only 75 per cent as much
force can be applied.

Two-hand operation: When the control is 10-19 inches forward of
the Seat Reference Point, twice as much force can be applied as
for one-hand operation. Beyond this, however, two-hand operation
becomes less effective.

2) Right-left (lateral) movements

One-hand operation: Control 10-19
inches forward of Seat Reference Point: 20 pounds

Two-hand operation: Control 10-19
inches forward of Seat Reference Point: 30 pounds

c. Types of Resistance

- 1) The type(s) of resistance to be provided depends primarily upon per-
formance requirements. (See Section 2.2 for details.)

2) For any guidance joystick, elastic resistance which increases non-linearly may be used to improve "stick feel" for the operator.⁶⁵

d. Rigid vs. Moving (Spring-Loaded) Levers^{3, 39, 48, 77}

Levers are usually designed to move when force is applied. However, they may also be designed to remain fixed in one position; for these "rigid" (or "pressure") controls, the amount of force being applied is used as the input to the system. Both rigid and spring-loaded levers are characterized by their elastic resistance. Spring-loaded levers are generally preferred because their control positions (settings) can be determined visually and because they provide the operator with feedback information about both control position and resistance (thus giving him better "feel"). The primary advantage of rigid levers is that they require no extra space for displacement.

3.8.4 General

- a. Identification of levers can often be improved by shape coding their handles. For this and other means of coding, see Section 2.3.
- b. For means of preventing accidental activation, see Section 2.4.
- c. When the handle is spherical, it should meet the following specifications:

Minimum Diameter:

Finger grasp: 1/2 inch

Hand grasp: 1-1/2 inches

Maximum Diameter: 3 inches

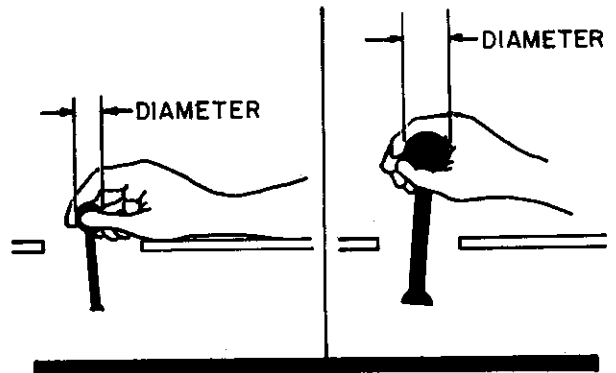

DETAILED DESIGN RECOMMENDATIONS
Lever

d. In making fine adjustments, support should be provided for the body part being used.^{25, 27, 71}

1) Elbow support for large hand movements.

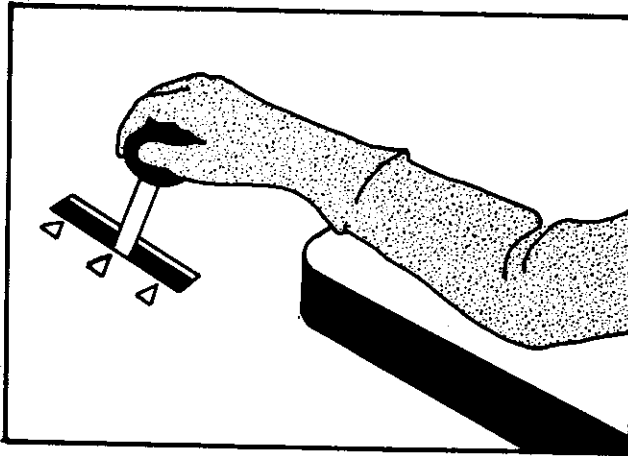

2) Forearm support for small hand movements.

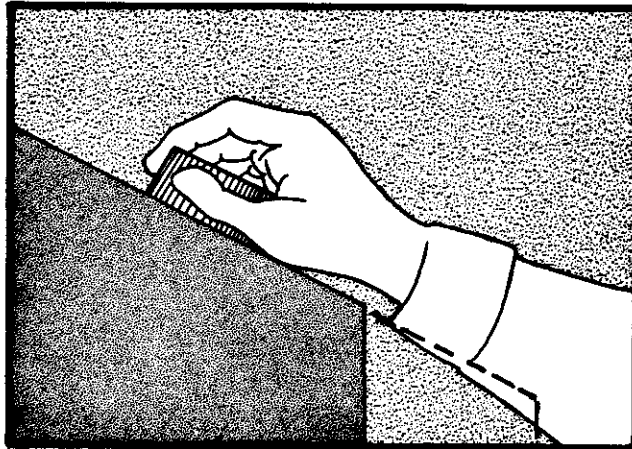

3) Wrist support for finger movements.

Note: In making very fine adjustments with a small joystick, operators often rest their wrist on the control panel and grasp the control pencil-style below the tip rather than on it. In such situations, the pivot point should be recessed below the surface on which the wrist rests.

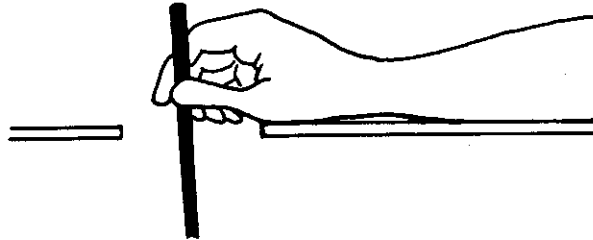

3.9 PEDAL

3.9.1 Size

- a. Minimum: 1 x 3 inches
- b. Maximum: This is determined by the space available and the danger of accidental activation. It is usually desirable for the control to be sufficiently large so that the entire foot can rest on it and/or apply force to it.

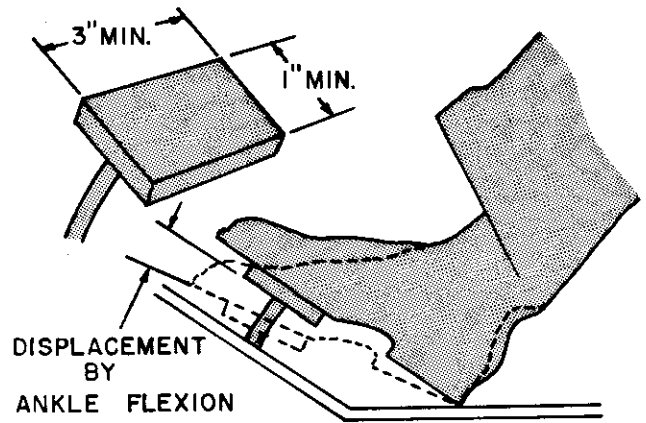

**DETAILED DESIGN RECOMMENDATIONS
Pedal**

3.9.2 Displacement

a. Minimum

Normal operation: 1/2 inch

Operator wearing heavy boots: 1 inch

b. Maximum

Ankle flexion only:^{13, 67} 2-1/2 inches

Leg movement: 7 inches

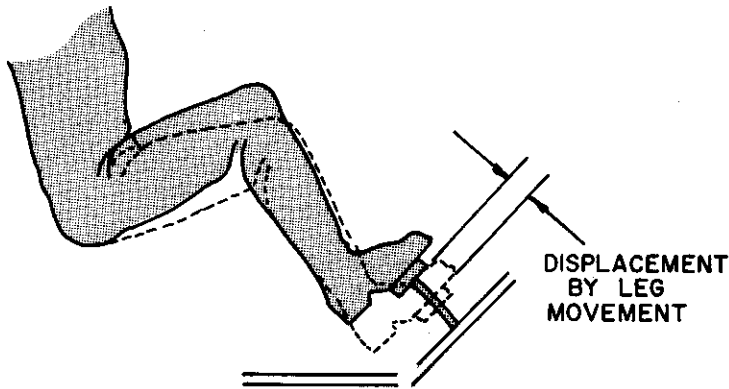

3.9.3 Resistance

a. Minimum

Foot will not rest on the control: 4 pounds

Foot may rest on the control: 10 pounds

b. Maximum

Ankle flexion only: 20 pounds

Leg movement: 180 pounds

c. Types of resistance

- 1) The type(s) of resistance to be provided depends primarily upon performance requirements. (See Section 2.2 for details.)
- 2) In most situations, the pedal should return to its null position when force is removed; hence, elastic resistance should be provided.

BIBLIOGRAPHY

1. Andreas, B.G. Bibliography of perceptual-motor performance under varied display-control relationships. University of Rochester, Scientific Report No. 1, AF Contract 30(602)-200, 1953.
2. Austin, T.R. and Sleight, R.B. Factors related to speed and accuracy of tactual discrimination. J. Exp. Psychol., 1952, 44, 283-287.
3. Bahrick, H.P., Fitts, P.M. and Schneider, R.H. Reproduction of simple movements as a function of factors influencing proprioceptive feedback. J. Exp. Psychol., 1955, 49, 445-454.
4. Baines, R.M. and King, E.S. A study in the relationship between maximum cranking speed and cranking radius. Motor Skills Research Exchange, 1950, 2, 24-28.
5. Baker, C.A. and Grether, W.F. Visual presentation of information. USAF, Wright Air Development Center, Wright-Patterson Air Force Base, WADC Technical Report 54-160, August 1954.
6. Barnes, R.M. An investigation of some hand motions used in factory work. Univ. Ia. Stud. Engng., 1936, Bulletin No. 6.
7. Barnes, R.M. Motion and time study. New York: John Wiley and Sons, Inc., 1950.
8. Barnes, R.M., Hardaway, H. and Podolsky, O. Which pedal is best? Factory Management and Maintenance, 1942, 100, 98.
9. Biel, W.C., Eckstrand, G.A., Swain, A.D. and Chambers, A.N. Tactual discriminability of two knob shapes as a function of their size. USAF, Wright Air Development Center, Wright-Patterson Air Force Base, WADC Technical Report 52-7, January 1952.
10. Bradley, J.V. Control-display association preferences for ganged controls. USAF, Wright Air Development Center, Wright-Patterson Air Force Base, Technical Report WADC 54-379, August 1954.

BIBLIOGRAPHY (Continued)

11. Bradley, J.V. and Stump, N.E. Minimum allowable dimensions for controls mounted on concentric shafts. USAF, Wright Air Development Center, Wright-Patterson Air Force Base, WADC Technical Report 55-355, December 1955.
12. Brennan, T.N. and Morant, G.M. Selection of knob shapes for radio and other controls. Medical Research Council, Unit of Applied Psychology, University of Cambridge, England, Report No. APU 702(a), January 1950.
13. Brown, C.W., Ghiselli, E.E., Jarrett, R.J., Minium, E.W. and U'Ren, R.M. Magnitude of forces which may be applied by the prone pilot to aircraft control devices. III. Foot controls. USAF, Air Materiel Command, Wright-Patterson Air Force Base, Technical Report AF TR 5955, October 1949.
14. Brown, J.S., Knauft, E.B. and Rosenbaum, G. The accuracy of positioning reactions as a function of their direction and extent. Office of Naval Research, Special Devices Center, Contract N5ori-57, Project No. 2, Report No. 1, 1947.
15. Brown, J.S. and Slater-Hammel, A.T. Discrete movements in the horizontal plane as a function of their length and direction. J. Exp. Psychol., 1949, 39, 84-95.
16. Brown, J.S., Wieben, E.W. and Norris, E.B. Discrete movements toward and away from the body in the horizontal plane. Office of Naval Research, Special Devices Center, Contract N5ori-57, Project No. 2, Report No. 6, September 1948.
17. Chapanis, A. Studies of manual rotary positioning movements: I. The precision of setting an indicator knob to various angular positions. J. Psychol., 1951, 31, 51-64.
18. Chapanis, A. Studies of manual rotary positioning movements. II. The accuracy of estimating the position of an indicator knob. J. Psychol., 1951, 31, 65-71.
19. Chapanis, A., Garner, W.R. and Morgan, C.T. Applied experimental psychology. New York: John Wiley and Sons, Inc., 1949.

BIBLIOGRAPHY (Continued)

20. Conrad, R. Some effects on performance of changes in perceptual load. Medical Research Council, Unit of Applied Psychology, University of Cambridge, England, Report No. APU 210/54, June 1954.
21. Craig, D.R. and Ellson, D.G. A comparison of one-handed and two-handed tracking. USAF, Air Materiel Command, Wright-Patterson Air Force Base, Memorandum Report No. MCREXD-695-2M, 21 July 1948.
22. Craig, D.R. and Ellson, D.G. A comparison of a two-handed and several one-handed control techniques in a tracking task. USAF, Air Materiel Command, Wright-Patterson Air Force Base, Memorandum Report No. MCREXD-644-2L, 21 July 1948.
23. Craik, K.J. and Vince, M.A. A note on the design and manipulation of instrument knobs. Medical Research Council, Unit of Applied Psychology, University of Cambridge, England, Report No. APU 14, 14 January 1945.
24. Eckstrand, G.A. and Morgan, R.L. The influence of training on the discriminability of knob shapes. USAF, Wright Air Development Center, Wright-Patterson Air Force Base, Technical Report WADC 52-126, February 1953.
25. Edwards, A.S. The finger tromometer. Amer. J. Psychol., 1946, 59, 273-283.
26. Ellson, D.G. and Gray, F.E. Effects of friction and mode of operation upon accuracy of tracking with the G.E. pedestal sight. USAF, Air Materiel Command, Wright-Patterson Air Force Base, Memorandum Report No. TSEAA-694-2c, 17 March 1947.
27. Ely, J.H., Thomson, R.M., and Orlansky, J. Layout of workplaces. USAF, Wright Air Development Center, Wright-Patterson Air Force Base, Technical Report WADC 56-171, September 1956.
28. Eriksen, C.W. Multidimensional stimulus differences and accuracy of discrimination. USAF, Wright Air Development Center, Wright-Patterson Air Force Base, Technical Report WADC 54-165, June 1954.

BIBLIOGRAPHY (Continued)

29. Fitts, P.M. A study of location discrimination ability. In Fitts, P.M. (Ed.) Psychological research on equipment design. Washington, D.C.: U.S. Government Printing Office, 1947.
30. Fitts, P.M. Engineering psychology and equipment design. In Stevens, S.S. (Ed.) Handbook of experimental psychology. New York: John Wiley and Sons, Inc., 1951.
31. Fitts, P.M. and Crannell, C.W. Location discrimination. II. Accuracy of reaching movements to twenty-four different areas. USAF, Air Materiel Command, Wright-Patterson Air Force Base, Technical Report 5833, 1950.
32. Fitts, P.M. and Crannell, C.W. Studies in location discrimination. In Hunt, D.P. (Ed.) The coding of aircraft controls. USAF, Wright Air Development Center, Wright-Patterson Air Force Base, Technical Report WADC 53-221, August 1953.
33. Fitts, P.M. and Jones, R.E. Analysis of factors contributing to 460 "pilot-error" experiences in operating aircraft controls. USAF, Air Materiel Command, Wright-Patterson Air Force Base, Memorandum Report No. TSEAA-694-12, 1 July 1947.
34. Foxboro Company. A study of factors determining accuracy of tracking by means of handwheel control. National Defense Research Committee, Office of Scientific Research and Development, Report No. 3451, 1942. Washington, D.C.: U.S. Department of Commerce, 1946.
35. Foxboro Company. A supplemental study of factors determining the accuracy of tracking by means of handwheel control. National Defense Research Committee, Office of Scientific Research and Development, Report No. 3452, 1942. Washington, D.C.: U.S. Department of Commerce, undated.
36. Foxboro Company. Handwheel speed and accuracy of tracking. National Defense Research Committee, Office of Scientific Research and Development, Report No. 3453, 1943. Washington, D.C.: U.S. Department of Commerce, undated.

BIBLIOGRAPHY (Continued)

37. Foxboro Company. Inertia, friction, and diameter in handwheel tracking. National Defense Research Committee, Office of Scientific Research and Development, Report No. 3454, 1943. Washington, D.C.: U.S. Department of Commerce, undated.
38. Gerall, A. A., Sampson, P. B., and Spragg, S. D. S. Method for studying performance on a simple tracking task as a function of radius and loading of control cranks. Army Medical Research Laboratory, Fort Knox, Kentucky, AMRL Project No. 6-95-20-001, Report No. 144, 15 November 1954.
39. Gibbs, C. B. The continuous regulation of skilled response by kinaesthetic feedback. Medical Research Council, Unit of Applied Psychology, University of Cambridge, England, Report No. APU 190-53, 1-13 March 1953.
40. Gough, M. N. and Beard, A. P. Limitations of the pilot in applying forces to airplane controls. Washington, D.C.: National Advisory Committee on Aeronautics, Technical Note No. 55, 1936.
41. Grether, W. F. A study of several design factors influencing pilot efficiency in the operation of controls. USAF, Air Materiel Command, Wright-Patterson Air Force Base, Memorandum Report No. TSEAA-694-9, 12 November 1946.
42. Helson, H. Design of equipment and optimal human operation. Amer. J. Psychol., 1949, 62, 473-497.
43. Henschke, U. K. and Mauch, H. A. A study of the design for a three-dimensional hand control for aircraft. USAF, Air Materiel Command, Wright-Patterson Air Force Base, Memorandum Report No. TSEAA-696-110, 12 May 1947.
44. Hertel, H. Determination of the maximum control forces and attainable quickness in the operation of airplane controls. National Advisory Committee for Aeronautics, Washington, D.C., Technical Memorandum No. 583, September 1930.

BIBLIOGRAPHY (Continued)

45. Hick, W.E. Friction in manual controls with special reference to its effect on accuracy of corrective movements in conditions simulating jolting. Medical Research Council, Unit of Applied Psychology, University of Cambridge, England, Report No. APU 18, 1945.
46. Hick, W.E. Reaction time for the amendment of a response. Quart. J. Exp. Psychol., 1949, 1, 175-179.
47. Hick, W.E. and Clarke, P. The effect of heavy loads on handwheel tracking. Medical Research Council, Royal Naval Personnel Research Committee, England, Report No. RNP 313, August 1946.
48. Howland, D. and Noble, M.E. The effect of physical constants of a control on tracking performance. J. Exp. Psychol., 1953, 46, 353-360.
49. Hunt, D. P. The coding of aircraft controls. USAF, Wright Air Development Center, Wright-Patterson Air Force Base, Technical Report WADC 53-221, August 1953.
50. Hunt, D. P. and Craig, D.R. The relative discriminability of thirty-one differently shaped knobs. USAF, Wright Air Development Center, Wright-Patterson Air Force Base, Technical Report WADC 54-108, December 1954.
51. Jenkins, W. L. Design factors in knobs and levers for making settings on scales and scopes. USAF, Wright Air Development Center, Wright-Patterson Air Force Base, Technical Report WADC 53-2, February 1953.
52. Jenkins, W. L. and Connor, M.B. Some design factors in making settings on a linear scale. J. Appl. Psychol., 1949, 33, 395-409.
53. Jenkins, W. L. and Karr, A. C. The use of a joy-stick in making settings on a simulated scope face. J. Appl. Psychol., 1954, 38, 457-461.
54. Jenkins, W. L., Maas, L. O. and Olson, M. W. Influence of inertia in making settings on a linear scale. J. Appl. Psychol., 1951, 35, 208-213.

BIBLIOGRAPHY

BIBLIOGRAPHY (Continued)

55. Jenkins, W. L., Maas, L. O. and Rigler, D. Influence of friction in making settings on a linear scale. J. Appl. Psychol., 1950, 34, 434-439.
56. Jenkins, W. L. and Olson, M. W. The use of levers in making settings on a linear scale. J. Appl. Psychol., 1952, 36, 269-271.
57. Jenkins, W. O. A follow-up investigation of shapes for use in coding aircraft control knobs. USAF, Air Materiel Command, Wright-Patterson Air Force Base, Memorandum Report No. TSEAA-694-4A, August 1946.
58. Jenkins, W. O. A further investigation of shapes for using in coding aircraft control knobs. USAF, Air Materiel Command, Wright-Patterson Air Force Base, Memorandum Report No. TSEAA-694-4B, September 1946.
59. Jenkins, W. O. Investigation of shapes for use in coding aircraft control knobs. USAF, Air Materiel Command, Wright-Patterson Air Force Base, Memorandum Report No. TSEAA-694-4, August 1946.
60. Jenkins, W. O. The tactual discrimination of shapes for coding aircraft-type controls. In Fitts, P. M. (Ed.) Psychological research on equipment design. Washington, D. C.: U. S. Government Printing Office, 1947.
61. Jones, R. E. A survey of pilot preferences regarding knob shapes to be used in coding aircraft controls. USAF, Air Materiel Command, Wright-Patterson Air Force Base, Memorandum Report No. TSEAA-694-4E, February 1947.
62. Klemmer, E. T. Rate of force application in a simple reaction time test. Operational Applications Laboratory, Air Force Cambridge Research Center, Air Research and Development Command, Bolling Air Force Base, AFCRC-TR-55-1, June 1955.
63. Knowles, W. B. and Newlin, E. P. Coding by groups as a mode of stimulus presentation. Naval Research Laboratory, Washington, D. C., NRL Report No. 4604, 1 September 1955.

BIBLIOGRAPHY (Continued)

64. Koepke, C. A. and Whitson, L. S. Power and velocity developed in manual work. Mech. Engng., 1940, 62, 383-389.
65. Orlansky, J. Psychological aspects of stick and rudder controls in aircraft. Aero. Engng. Rev., 1949, 8, 1-10.
66. Peters, W. and Wenborne, A. A. The time pattern of voluntary movements. Brit. J. Psychol., 1936, 26, 388-406.
67. Randall, F. E., Damon, A., Benton, R. S. and Patt, D. I. Human body size in military aircraft and personal equipment. USAF, Air Materiel Command, Wright-Patterson Air Force Base, Technical Report No. 5501, 10 June 1946.
68. Reed, J. D. Factors influencing rotary performance. J. Psychol., 1949, 28, 65-92.
69. Rockway, M. R. The effects of variations in control-display ratio and exponential time delay on tracking performance. USAF, Wright Air Development Center, Wright-Patterson Air Force Base, Technical Report WADC 54-618, December 1954.
70. Searle, L. V. and Taylor, F. V. Studies of tracking behavior. I. Rate and time characteristics of simple corrective movements. J. Exp. Psychol., 1948, 38, 615-631.
71. Shackel, B. The human limbs in control. 1. Apparatus; Optimum experimental conditions. Medical Research Council, Unit of Applied Psychology, University of Cambridge, England, Report No. APU 214/54, April 1954.
72. Shackel, B. The human limbs in control. 2. Optimum control-display ratios at different display distances. Medical Research Council, Unit of Applied Psychology, University of Cambridge, England, Report No. APU 215/54, April 1954.

BIBLIOGRAPHY (Continued)

73. Slater-Hammel, A. T. and Brown, J. S. Discrete movements in the horizontal plane as a function of their length and direction. Office of Naval Research, Special Devices Center, Contract No. N5ori-57, Project No. 2, Report No. 2, October 1947.
74. Spragg, S. D. S. and Devoe, D. B. Studies in the accuracy of movement. III. The bisection and duplication of angular extents as a function of size of angle and of type of end-point cue. Office of Naval Research, Special Devices Center, Report No. 241-6-4, October 1950.
75. Stump, N. E. Manipulability of rotary controls as a function of knob diameter and control orientation. USAF, Wright Air Development Center, Wright-Patterson Air Force Base, Technical Report 53-12, February 1953.
76. Stump, N. E. Toggle switches--activation time as a function of spring tension. USAF, Wright Air Development Center, Wright-Patterson Air Force Base, Technical Note WCRD 52-39, August 1952.
77. Weiss, B. The role of proprioceptive feedback in positioning responses. J. Exp. Psychol., 1954, 47, 215-224.
78. Weitz, J. The coding of airplane control knobs. In Fitts, P. M. (Ed.) Psychological research on equipment design. Washington, D. C.: U. S. Government Printing Office, 1947.
79. Whittingham, D. G. V. Experimental knob shapes. Medical Research Council, Unit of Applied Psychology, University of Cambridge, England, Report No. FPRC 702, September 1948.
80. Williams, S. B. On the manual estimation of size. In Hunt, D. P. (Ed.) The coding of aircraft controls. USAF, Wright Air Development Center, Wright-Patterson Air Force Base, Technical Report WADC 53-221, August 1953.
81. Woodson, W. E. Human engineering guide for equipment designers. Berkeley: University of California Press, 1954.

BIBLIOGRAPHY (Continued)

82. Cockpit controls: location and actuation of, for aircraft. Department of Defense, Defense Supply Management Agency, Office of Standardization, Washington, MIL-STD-203, 1953.
83. Handbook of human engineering data. (2nd Ed.) Tufts College, Institute for Applied Experimental Psychology, Office of Naval Research, Special Devices Center, Technical Report SPECDEVCEN 199-1-2a, 1 November 1952.
84. Handbook of instructions for aircraft designers. Air Research and Development Command, Manual No. 80-1, Headquarters, ARDC, Baltimore, Maryland.
85. The specifications of illumination and color in industry. Amer. Acad. of Ophthal. and Otol., January-February 1947.

INDEX

- Accidental control activation
 - effects of coding, 29-40
 - effects of inertia, 28-29
 - effects of sliding and static friction, 27
 - effects of spring loading, 26
 - effects of viscous damping, 28
 - pedal design, 77
 - relation to resistance, 25
 - (See also Prevention of accidental activation)
- Adjustment range, linear vs. rotary controls, 3
- Aircraft component color code, 39
- Blind positioning, 57
- Blind reaching
 - accuracy of, 31
 - use of combined controls, 6
- Body supports
 - elbow, 76
 - forearm, 76
 - wrist, 76-77
- Bracketing, 64
- Buffeting
 - effects of sliding and static friction, 27
 - effects of spring loading, 26
 - effects of viscous damping, 28
 - relation to resistance, general, 25
- Check-reading
 - effectiveness of, for various controls, 19
 - for rotary selector switch, 58
- Coding
 - advantages and disadvantages of various types, 32-33
 - color coding, 38-40
 - comparison among controls; 18
 - crank, 13
 - foot push button, 9
 - general rule, 7
 - hand push button, 8
 - handwheel, 14
 - knob, 12
 - labeling, 37-38
 - lever, 16
 - location coding, 31
 - methods of, 29
 - mode-of-operation coding, 36-37
 - pedal, 17
 - purpose of, 29
 - rotary selector switch, 10
 - selection rules, 30-37
 - shape coding, 34
 - size coding, 34-35
 - toggle switch, 9
- Color coding
 - advantages and disadvantages, 32-33
 - recommendations, 38, 40
 - requirements for, 38
- Combined controls
 - advantages of, 6
 - cautions, 6
 - effectiveness of various controls, 19
 - handwheel, 14
 - lever, 16
 - situations where useful, 6
- Continuous adjustment controls
 - characteristics of, 11-17
 - comparison with discrete adjustment controls, 3, 5
 - toggle switch vs. lever, 52-53
- Control characteristics, 7-19
 - comparison among controls, 18-19
 - crank, 13, 18-19
 - foot push button, 8-9, 18-19
 - hand push button, 7-8, 18-19
 - handwheel, 14-15, 18-19
 - knob, 11-12, 18-19
 - lever, 16, 18-19
 - pedal, 17-19
 - rotary selector switch, 10-11, 18-19
 - toggle switch, 9, 18-19
- Control coding (See Coding)
- Control, combined (See Combined controls)

INDEX (Continued)

- Control, continuous adjustment
 - (See Continuous adjustment controls)
- Control design, 45-79
 - crank, 64-68
 - foot push button, 49-51
 - hand push button, 47-49
 - handwheel, 68-72
 - knob, 59-64
 - lever, 72-77
 - pedal, 77-79
 - rotary selector switch, 54-59
 - toggle switch, 51-53
- Control, discrete adjustment (See Discrete adjustment controls)
- Control-display ratio
 - control movements, 22
 - definition, 21
 - effects of display size, 23
 - effects of time delays, 23
 - effects of viewing distance, 23
 - optimum for crank, 65
 - optimum for handwheel, 69-70
 - optimum for knob, 59
 - optimum for lever, 73
 - optimizing, 22
 - recommendations, 23
- Control "feel," 24-29
 - relation to inertia, 28
 - relation to resistance, general, 24
 - relation to spring loading, 26
 - relation to static and sliding friction, 27
 - relation to viscous damping, 28
- Control identification (See Identification and coding)
- Control, linear (See Linear controls)
- Control movements
 - ankle flexion, 50, 79
 - comparison among controls, 18-19
 - crank, 13
 - fine adjusting, 35
 - knob, 12
 - leg movements, 50, 79
 - lever, 16
 - pedal, 17
 - relation to control-display ratio, 22
 - relation to mode-of-operation, 37
 - relation to resistance, 24
 - slewing, 3, 5
 - with inertia, 28
 - with spring loading, 25
 - with static and sliding friction, 26
 - with viscous damping, 27
- Control position (displacement)
 - relation to mode-of-operation, 37
 - with inertia, 28
 - with spring loading, 25
 - with static and sliding friction, 26
 - with viscous damping, 27
- Control positions (settings),
 - identification of
 - comparison among controls, 18-19
 - crank, 13
 - foot push button, 9
 - hand push button, 8
 - handwheel, 14
 - knob, 12
 - lever, 16
 - pedal, 17
 - rotary selector switch, 10
 - toggle switch, 9
- Control positions, number of
 - comparison among controls, 18-19
 - discrete adjustment controls, 3, 5-6
 - rotary selector switch, 10
 - toggle switch, 9
- Control, rotary (See Rotary controls)
- Control settings (See Control positions)
- Covering of controls
 - preventing accidental activation, 40, 42
 - when to use, 42
- Crank, characteristics of, 13, 18-19
 - coding, 13, 18-19
 - crank handle, 12, 13
 - identification of control
 - position, 13, 18-19
 - movement, 13, 18-19

INDEX (Continued)

- space requirements, 13, 18-19
- uses, 13
- Crank, design of, 64-68
 - displacement, 65-66
 - general, 67-68
 - resistance, 66-67
 - size, 64-65
- Crank handle
 - design of, 67
 - with handwheel, 13, 72
 - with knob, 12, 13
- Depth (thickness), control
 - knob, 60
 - rotary selector switch, 54, 55
- Detent action
 - relation to mode-of-operation, 37
 - rotary selector switch, 56
- Diameter, control
 - effects of slewing time, 22
 - foot push button, 49
 - hand push button, 47
 - handwheel, 68
 - handwheel rim, 69
 - knob, 60-61
 - lever, 75
 - rotary selector switch, 55
 - toggle switch, 51
 - (See also Radius)
- Direction-of-movement relationships
 - general rules, 3-4
 - requirements for various controls, 7-19
 - rotary selector switch, 58
- Discrete adjustment controls
 - advantages of, 3, 5
 - characteristics of, 7-11, 18-19
 - comparison with continuous adjustment controls, 5
 - maximum number of settings, 5
 - toggle switch vs. lever, 52-53
- Displacement of control
 - crank, 65-66
 - foot push button, 49-50
 - hand push button, 47
 - handwheel, 69-70
 - knob, 61
 - lever, 73
 - pedal, 78
 - rotary selector switch, 55
 - toggle switch, 52
- Display size, effects on control-display ratio, 23
- Dry frictional resistance (See Friction, sliding and static)
- Dual operation of controls (sequencing)
 - preventing accidental activation, 40, 43
 - when to use, 43
- Elastic resistance (See Spring loading)
- Elbow rest (support), 76
- Exponential time delays, relation to control-display ratio, 23
- Fine adjusting movements
 - cranks, 66
 - effects of control-display ratio, 22
 - for continuous adjustment controls, 3, 5
 - relation to tolerance, 23
- Fingertip operation
 - hand push button, 47-48
 - knob, 60
 - lever, 73
- Fixed vs. moving pointer, 58-59, 64
- Fixed vs. moving scale, 58-59, 64
- Fluid frictional resistance (See Viscous damping)
- Foot push button, characteristics
 - of, 8-9, 18-19
 - identification of control position, 9, 18-19
 - operating time, 9, 18-19
 - space requirements, 8, 18-19
 - toe vs. heel operation, 9
 - types of, 8, 18-19
- Foot push button, design of, 49-51
 - displacement, 49-50
 - general, 51

INDEX (Continued)

- resistance, 50
- size, 49
- Force characteristics of controls
 - comparison among controls, 18-19
 - hand push button, 8
 - handwheel, 14, 71
 - lever, 16, 73-74
 - pedal, 17 (See also Resistance, control)
- Force requirements
 - foot controls, 2
 - hand controls, 2, 5-6 (See also Resistance, control)
- Friction, static and sliding
 - characteristics of, 24, 26-27
 - for crank, 67
 - for foot push button, 50
 - for hand push button, 48
 - for knob, 62
 - for rotary selector switch, 56
 - for toggle switch, 52
- Function of control
 - for coding, 29
 - general, 1
- Gain, 21
- G-forces
 - effects of spring loading, 26
 - effects of static and sliding friction, 27
 - effects of viscous damping, 28
 - relation to resistance, general, 25
- Gloves, effects of, 34
- "Goodness" of control, 1
- Hand push button, characteristics
 - of, 7-8, 18-19
 - coding, 8, 18-19
 - direction-of-movement requirements, 8, 18-19
 - operating time, 8, 18-19
 - space requirements, 7, 18-19
 - types of, 7
 - use in arrays, 8, 18-19
- Hand push button, design of, 47-49
 - displacement, 47
 - general, 48-49
 - resistance, 48
 - shape, 48
 - size, 47
- Handwheel, characteristics
 - of, 14-15, 18-19
 - arc of rotation, 15
 - coding, 14
 - combined controls, 14, 18-19
 - forces, 14
 - identification of control position, 14, 18-19
 - space requirements, 14, 18-19
 - uses, 14
- Handwheel, design of, 68-72
 - displacement, 69-70
 - general, 71-72
 - resistance, 71
 - size, 68-69
- Identification
 - advantages and disadvantages of coding for, 32-73
 - characteristics of various controls, 7-19
 - general rule, 7 (See also Coding)
- Illumination
 - relation to types of coding, 32-33
 - requirements for color coding, 38
 - requirements for labeling, 37
- Inertia
 - characteristics of, 28-29
 - for crank, 67
 - for foot push button, 50
 - for hand push button, 48
 - for handwheel, 71
 - for knob, 62
 - for rotary selector switch, 56
 - for toggle switch, 52
- Informational needs of operators, 1, 29-30
- Isolation of controls
 - preventing accidental activation, 41
 - when to use, 41
- Jolting
 - effects of spring loading, 26

INDEX (Continued)

- effects of static and sliding friction, 27
- effects of viscous damping, 28
- relation of resistance, general, 24-25
- Joystick (See Lever)
- Knob, characteristics of
 - coding, 12, 18-19, 34, 62-63
 - crank handle, 12
 - ganged, 12
 - identification of control position, 12, 18-19
 - movement, 12, 18-19
 - space requirements, 11, 18-19
 - stationary vs. rotating pointer, 12
 - uses, 11
- Knob, design of, 59-64
 - displacement, 61
 - general, 62-65
 - resistance, 61-62
 - size, 59-61
- Knobs, ganged (concentric), 12, 18-19
- Labeling
 - advantages and disadvantages, 32-33
 - prerequisites, 37
 - recommendations, 37-38
- Learning (training), relation to coding, 29, 34
- Length, control
 - knob, 61
 - rotary selector switch, 54
 - toggle switch, 51
- Lever, characteristics of
 - arc of rotation, 16
 - coding, 16, 18-19
 - combined controls, 16, 18-19
 - forces, 16
 - identification of control position, 16, 18-19
 - movement, 16, 18-19
 - space requirements, 16, 18-19
 - types of, 16
 - use in arrays, 18-19
- Lever, design of, 72-77
 - displacement, 73
 - general, 75-77
 - resistance, 73-75
 - size, 72
- Linear controls
 - adjustment range, 3
 - control-display ratio, 21
 - controls in this category, 3, 4, 72
 - use with various system responses, 3-4
- Location coding, 31-33
 - advantages and disadvantages, 32-33
 - blind hand reaching, 31
 - recommendations for, 31
- Location of controls
 - preventing accidental activation, 40-41
 - when to use, 41
- Locking of controls
 - preventing accidental activation, 40, 43
 - when to use, 43
- Miniaturized knobs, 59-60
- Mode-of-operation coding
 - advantages and disadvantages, 32-33
 - definition, 30
 - recommendations for, 36-37
- Moving knob vs. moving scale, 58-59, 64
- Moving vs. fixed pointer, 58-59, 64
- One hand vs. two hands, force, 73-74
- Operating time (See Speed characteristics of controls)
- Operation sequencing of controls, 43-44
 - preventing accidental activation, 40, 43-44
 - when to use, 43-44
- Orientation of controls
 - preventing accidental activation, 40, 42
 - when to use, 42
- Palm grasp, knob design for, 60
- Pedal, characteristics of, 17-19
 - coding, 17-19
 - force, 17-19
 - identification of control position, 17-19

INDEX (Continued)

- movement, 17-19
 - space requirements, 17-19
 - speed, 17-19
 - types of, 17
- Pedal, design of, 77-79
 - displacement, 78
 - resistance, 78-79
 - size, 77
- Performance requirements
 - for coding, 29-31
 - for control-display ratio, 22
 - for resistance, 24-25
 - general, 1
- Pointer design
 - moving vs. fixed, 58-59
 - rotary selector switch, 57
- Precision requirements
 - discrete vs. continuous adjustment
 - controls, 3, 5
 - effects of inertia, 28-29
 - effects of resistance, general, 24
 - effects of spring loading, 25-26
 - effects of static and sliding
 - friction, 27
 - effects of viscous damping, 27-28
 - hand controls, 2
 - rotary controls, 3
- Pressure vs. moving lever, 75
- Prevention of accidental
 - activation, 40-44
 - covering, 40, 42
 - location, 40-41
 - locking, 40, 43
 - operation sequencing, 40, 43-44
 - orientation, 40, 42
 - recessing, 40-41
 - resistance, 24-29, 40-44
- Push button (See Hand push button
 - and Foot push button)
- Radius, control
 - crank, 64-65 (See also Diameter,
 - control)
- Recessing of controls
 - preventing accidental activation, 40-41
 - when to use, 41
- Recommendations
 - color coding, 38-40
 - control coding, general, 30-31
 - control-display ratio, 23
 - design of controls, 45-79
 - design of crank, 64-68
 - design of foot push button, 49-51
 - design of hand push button, 47-49
 - design of handwheel, 68-72
 - design of knob, 59-64
 - design of lever, 72-77
 - design of pedal, 77-79
 - design of rotary selector switch, 54-59
 - design of toggle switch, 51-53
 - labeling, 37-38
 - location coding, 31
 - mode-of-operation coding, 3
 - shape coding, 34
 - size coding, 36 (See also Rules)
- Resistance, control
 - crank, 66-67
 - foot push button, 50
 - hand push button, 48
 - handwheel, 71
 - inertia, 28-29
 - knob, 61-62
 - lever, 73-75
 - pedal, 78-79
 - rotary selector switch, 56
 - sliding friction, 26-27
 - spring loading, 25-26
 - static friction, 26-27
 - toggle switch, 52
 - uses of, 24-25
 - viscous damping, 27-28
- Right vs. left hand, force, 74
- Rigid vs. moving lever, 75
- Rotary controls
 - adjustment range, 3, 5-6
 - control-display ratio, 21
 - controls in this category, 4
 - use with various system responses, 3-4
 - way to measure resistance, 46

INDEX (Continued)

- Rotary selector switch,
 - characteristics of
 - coding, 10, 18-19
 - identification of position, 10, 18-19
 - operating time, 10, 18-19
 - positions, number of, 10, 18-19, 56
 - space requirements, 10, 18-19
 - stationary vs. moving pointer, 11
- Rotary selector switch, design of, 54-59
 - displacement, 55
 - general, 56-59
 - knob shape, 57
 - location of control positions, 56-57
 - moving vs. fixed pointer, 58-59
 - number of positions, 56
 - resistance, 56
 - size, 54-55
- Rules
 - control coding, 30-31
 - control selection, 2-7 (See also Recommendations)
- Safety color code, 38-39
- Self-centering, 25
- Sensitivity, 21
- Sequential operation, 6
- Settings (See Control positions)
- Shape coding
 - advantages and disadvantages, 32-33
 - effectiveness with various controls, 18-19
 - for tactual identification, 34
 - for visual identification, 34
 - recommendations, general, 34
 - recommended shapes, 34, 35, 62-64
 - with knobs, 62-64
 - with levers, 75
 - with rotary selector switches, 57
- Simultaneous operation
 - hand push button, 8
 - toggle switch, 9
 - use of combined controls, 6
- Size coding
 - advantages and disadvantages, 32-33
 - caution, 34
 - effectiveness with various controls, 18-19
 - recommendations, 36
 - relative vs. absolute discriminations, 36
- Size of controls
 - crank, 64-65
 - foot push button, 49
 - hand push button, 47
 - handwheel, 68-69
 - knob, 59-61
 - lever, 72
 - pedal, 77
 - rotary selector switch, 54-55
 - toggle switch, 51
- Slewing movements
 - crank handle, 12, 66
 - for continuous adjustment controls, 3, 5, 22
 - for linear controls, 22
 - for small rotary controls, 22
 - relation to tolerance, 23
- Space requirements for controls
 - coding, 30
 - comparison among controls, 18-19
 - crank, 13
 - foot push button, 8
 - hand push button, 7
 - handwheel, 14
 - knob, 11
 - lever, 16
 - pedal, 17
 - rigid vs. moving lever, 75
 - rotary selector switch, 10
 - toggle switch, 9
- Speed characteristics of controls
 - comparison among controls, 18-19
 - crank, 13, 64-65
 - foot push button, 9
 - hand push button, 8
 - rotary selector switch, 10
 - toggle switch, 9

INDEX (Continued)

- Speed requirements
 - discrete vs. continuous adjustment
 - controls, 3, 5
 - effects of inertia, 28
 - effects of resistance, general, 24
 - effects of spring loading, 26
 - effects of static and sliding friction, 27
 - effects of viscous damping, 27
 - hand controls, 2
- Spring loading (elastic resistance)
 - characteristics of, 25-26
 - for foot push button, 50
 - for hand push button, 48
 - for handwheel, 71
 - for lever, 75
 - for pedal, 79
 - for rotary selector switch, 56
 - for toggle switch, 52
- Standardization
 - for identification, 7
 - relation to coding, general, 30-31
 - relation to location coding, 31
 - relation to shape coding, 34
- System responses
 - controls to use with, 5-6
 - various types of, 3, 5-6
- Task requirements
 - for coding, 30
 - general, 1
- Thumb and finger encircled, knob
 - design for, 61
- Time delays, relation to control-display ratio, 23
- Toe vs. heel operation, 51
- Toggle switch, characteristics of
 - identification of control
 - position, 9, 18-19
 - operating time, 9, 18-19
 - positions, number of, 9
 - space requirements, 9, 18-19
 - use in arrays, 9, 18-19
- Toggle switch, design of, 51-53
 - displacement, 52
 - general, 52-53
 - resistance, 52
 - size, 51
- Tolerances
 - effects on fine adjusting time, 22
 - effects on slewing time, 23
 - relation to control-display ratio, 23
- Tremor
 - effects of inertia, 28
 - effects of static and sliding friction, 27
 - effects of viscous damping, 28
 - relation of resistance, general, 24-25
- Vibration
 - effects of inertia, 28
 - effects of spring loading, 26
 - effects of static and sliding friction, 27
 - effects of viscous damping, 28
 - relation to resistance, general, 24-25
- Viewing distance, effects of control-display ratio on, 23
- Viscous damping
 - characteristics of, 27-28
 - for foot push button, 50
 - for hand push button, 48
- Width, rotary selector switch, 54
- Work, distribution of, 2
 - among feet, 2
 - among hands, 2
 - among limbs, 2
- Workplace requirements
 - general, 1 (See also Space requirements)
- Wrist rest (support), 76-77