

Unclassified

SECURITY CLASSIFICATION OF THIS PAGE (When Data Entered)

REPORT DOCUMENTATION PAGE		READ INSTRUCTIONS BEFORE COMPLETING FORM
1. REPORT NUMBER AFFDL-TR-74-116	2. GOVT ACCESSION NO.	3. RECIPIENT'S CATALOG NUMBER
4. TITLE (and Subtitle) BACKGROUND INFORMATION AND USER'S GUIDE FOR MIL-F-9490	5. TYPE OF REPORT & PERIOD COVERED Final Report	
	6. PERFORMING ORG. REPORT NUMBER D3-8688-6	
7. AUTHOR(s) James L. Townsend Eugene T. Raymond	8. CONTRACT OR GRANT NUMBER(s) F33615-72-C-1090	
9. PERFORMING ORGANIZATION NAME AND ADDRESS The Boeing Company 3801 S. Oliver Wichita, Kansas 67210	10. PROGRAM ELEMENT, PROJECT, TASK AREA & WORK UNIT NUMBERS Project No. 8225	
11. CONTROLLING OFFICE NAME AND ADDRESS Air Force Flight Dynamics Laboratory Wright Patterson AFB, Ohio 45433	12. REPORT DATE January 1975	
	13. NUMBER OF PAGES 234	
14. MONITORING AGENCY NAME & ADDRESS (if different from Controlling Office)	15. SECURITY CLASS. (of this report) Unclassified	
	15a. DECLASSIFICATION/DOWNGRADING SCHEDULE	
16. DISTRIBUTION STATEMENT (of this Report) Approved for public release; distribution unlimited.		
17. DISTRIBUTION STATEMENT (of the abstract entered in Block 20, if different from Report)		
18. SUPPLEMENTARY NOTES		
19. KEY WORDS (Continue on reverse side if necessary and identify by block number) Specification Flight Control System Requirements		
20. ABSTRACT (Continue on reverse side if necessary and identify by block number) This document is published in support of Military Specification MIL-F-9490D, "Flight Control Systems - Design, Installation and Test of, Piloted Aircraft, General Specification For". It was written to aid the MIL-F-9490D user in interpretation and use of the specification. The philosophy adopted by the Air Force for this revision of MIL-F-9490 is discussed and, where pertinent, the limitations of the		

DD FORM 1473 1 JAN 73 EDITION OF 1 NOV 65 IS OBSOLETE

Unclassified

SECURITY CLASSIFICATION OF THIS PAGE (When Data Entered)

Unclassified

SECURITY CLASSIFICATION OF THIS PAGE(When Data Entered)

20. ABSTRACT (Cont.)

data or arguments used to support individual requirements are stated. Pertinent literature has also been referenced in conjunction with individual requirements, where recent supporting research and development has been accomplished.

Unclassified

SECURITY CLASSIFICATION OF THIS PAGE(When Data Entered)

PREFACE

This technical report was prepared for the Air Force Flight Dynamics Laboratory and the Aeronautical Systems Division as an interdivisional effort by The Boeing Company in fulfillment of AFFDL Contract F33615-72-C-1090.

Principal authors of this report are James L. Townsend, Boeing-Wichita and Eugene T. Raymond, Boeing-Seattle. Several other Boeing engineers authored subsections of the draft MIL-F-9490D, which is included as a part of this technical report. Included are J. McWha, J. Boone, D. Martin and K. Mitchell, Seattle; F. Moffett, Wichita and H. McCafferty and W. Eason, Philadelphia.

This effort was guided by a joint AFFDL-ASD steering committee. Paul E. Blatt, AFFDL, and Joseph A. Farris, ASD, were the steering committee co-chairmen. Thomas D. Lewis was the project monitor. Other committee members included: Ron Anderson, Bob Woodcock, Bill Brown and Frank George of the AFFDL and Don Sovine of ASD.

Contracts

TABLE OF CONTENTS

	PAGE
I INTRODUCTION	1
II STATEMENT AND DISCUSSION OF REQUIREMENTS	8
1.0 SCOPE	8
1.1 Scope	8
1.2 Classification	8
1.2.1 Flight Control System (FCS) classifications	8
1.2.1.1 Manual flight control systems (MFCS)	8
1.2.1.2 Automatic flight control systems (AFCS)	9
1.2.2 FCS operational state classifications	9
1.2.2.1 Operational State I (Normal operation)	9
1.2.2.2 Operational State II (Restricted operation)	9
1.2.2.3 Operational State III (Minimum safe operation)	9
1.2.2.4 Operational State IV (Controllable to an immediate emergency landing)	10
1.2.2.5 Operational State V (Controllable to an evacuable flight condition)	10
1.2.3 FCS criticality classifications	11
1.2.3.1 Essential	11
1.2.3.2 Flight phase essential	11
1.2.3.3 Noncritical	11
2.0 APPLICABLE DOCUMENTS	12
3.0 REQUIREMENTS	16
3.1 System requirements	16
3.1.1 MFCS performance requirements	16
3.1.2 AFCS performance requirements	19
3.1.2.1 Attitude hold (pitch and roll)	20
3.1.2.2 Heading hold	20
3.1.2.3 Heading select	20
3.1.2.4 Lateral acceleration and sideslip limits	21
3.1.2.4.1 Coordination in steady banked turns	21
3.1.2.4.2 Lateral acceleration limits, rolling	21
3.1.2.4.3 Coordination in straight and level flight	21
3.1.2.5 Altitude hold	21
3.1.2.6 Mach hold	22
3.1.2.7 Airspeed hold	22
3.1.2.8 Automatic navigation	23
3.1.2.8.1 VOR/TACAN	23
3.1.2.9 Automatic instrument low approach system	24
3.1.2.9.1 Localizer mode	24
3.1.2.9.2 Glide slope mode	25
3.1.2.9.3 Go-around mode	25
3.1.2.10 All weather landing system	27
3.1.2.10.1 All weather landing performance standards - variations of aircraft and airborne equipment configurations	27
3.1.2.10.2 Performance standards-ground based equipment variations	28

Contracts

TABLE OF CONTENTS (CONT'D)

	PAGE
3.1.2.11 Flight load fatigue alleviation	29
3.1.2.12 Ride smoothing	30
3.1.2.12.1 Ride discomfort index	31
3.1.2.13 Active flutter suppression	36
3.1.2.14 Gust and maneuver load alleviation	36
3.1.2.15 Automatic terrain following	36
3.1.2.16 Control stick (or wheel) steering	36
3.1.3 General FCS design	37
3.1.3.1 Redundancy	37
3.1.3.2 Failure immunity and safety	38
3.1.3.2.1 Automatic terrain following failure immunity	40
3.1.3.3 System operation and interface	40
3.1.3.3.1 Warmup	40
3.1.3.3.2 Disengagement	41
3.1.3.3.3 Mode compatibility	41
3.1.3.3.4 Failure transients	41
3.1.3.4 System arrangement	41
3.1.3.5 Trim controls	42
3.1.3.6 Stability	43
3.1.3.6.1 Stability margins	43
3.1.3.6.2 Sensitivity analysis	44
3.1.3.7 Operation in turbulence	48
3.1.3.7.1 Random turbulence	48
3.1.3.7.2 Discrete gusts	49
3.1.3.7.3 Wind model for landing and takeoff	53
3.1.3.8 Residual oscillations	60
3.1.3.9 System test and monitoring provisions	61
3.1.3.9.1 Built-in-test equipment (BIT)	61
3.1.3.9.2 Inflight monitoring	61
3.1.4 MFCS design	65
3.1.4.1 Mechanical MFCS design	67
3.1.4.1.1 Reversion - boosted systems	67
3.1.4.2 Electrical MFCS design	67
3.1.4.2.1 Use of mechanical linkages	68
3.1.5 AFCS design	69
3.1.5.1 System requirements	69
3.1.5.1.1 Control stick (or wheel) steering	69
3.1.5.1.2 Flight director subsystem	70
3.1.5.2 AFCS interface	70
3.1.5.2.1 Tie-in with external guidance	70
3.1.5.2.2 Servo engage interlocks	70
3.1.5.2.3 Engage-Disengage transients	70
3.1.5.3 AFCS emergency provisions	70
3.1.5.3.1 Manual override capability	70
3.1.5.3.2 Emergency disengagement	71
3.1.6 Mission accomplishment reliability	72
3.1.7 Quantitative flight safety	72
3.1.7.1 Quantitative flight safety - all weather landing system (AWLS)	79

Contracts

TABLE OF CONTENTS (CONT'D)

	PAGE
3.1.7.1.1 Assessment of average risk of a hazard	80
3.1.7.1.2 Assessment of specific risk	80
3.1.8 Survivability	87
3.1.8.1 All-engines-out control	87
3.1.9 Invulnerability	92
3.1.9.1 Invulnerability to natural environments	92
3.1.9.2 Invulnerability to lightning strikes and static atmospheric electricity	93
3.1.9.3 Invulnerability to induced environments	94
3.1.9.4 Invulnerability to onboard failures of other systems and/or equipment	95
3.1.9.5 Invulnerability to maintenance error	96
3.1.9.6 Invulnerability to pilot and flight crew inaction and error	97
3.1.9.7 Invulnerability to enemy action	99
3.1.10 Maintenance provisions	99
3.1.10.1 Operational checkout provisions	99
3.1.10.2 Malfunction detection and fault isolation provisions	99
3.1.10.2.1 Use of cockpit instrumentation	100
3.1.10.2.2 Provisions for checkout with portable test equipment	100
3.1.10.3 Accessibility and serviceability	100
3.1.10.4 Maintenance personnel safety provisions	100
3.1.11 Structural integrity	102
3.1.11.1 Strength	102
3.1.11.1.1 Damage tolerance	102
3.1.11.1.2 Load capability of dual-load-path elements	102
3.1.11.2 Stiffness	103
3.1.11.3 Durability	105
3.1.12 Wear life	106
3.2 Subsystem and component design requirements	107
3.2.1 Pilot controls and displays	107
3.2.1.1 Pilot controls for CTOL aircraft	107
3.2.1.1.1 Additional requirements for control sticks	107
3.2.1.1.2 Additional requirements for rudder pedals	107
3.2.1.1.3 Alternate or unconventional controls	108
3.2.1.1.4 Variable geometry cockpit controls	108
3.2.1.1.5 Trim switches	108
3.2.1.1.6 Two-Speed trim actuators	108
3.2.1.1.7 FCS control panel	108
3.2.1.1.8 Normal disengagement means	108
3.2.1.1.9 Preflight test controls	108
3.2.1.2 Pilot controls for rotary-wing aircraft	110
3.2.1.2.1 Interconnection of collective pitch control and throttle(s) for helicopters powered by reciprocating engine(s)	110

Controls

TABLE OF CONTENTS (CONT'D)

	PAGE
3.2.1.2.2 Interconnection of collective pitch control and engine power controls for helicopters powered by turbine engines	110
3.2.1.2.3 Alternate or unconventional controls	110
3.2.1.3 Pilot controls for STOL aircraft	111
3.2.1.4 Pilot displays	113
3.2.1.4.1 FCS annunciation	113
3.2.1.4.2 FCS warning and status annunciation	114
3.2.1.4.3 Lift and drag device position indicators	114
3.2.1.4.4 Trim indicators	114
3.2.1.4.5 Control surface position indication	115
3.2.2 Sensors	116
3.2.3 Signal transmission	117
3.2.3.1 General requirements	117
3.2.3.1.1 Control element routing	117
3.2.3.1.2 System separation, protection, and clearance	118
3.2.3.1.3 Fouling prevention	118
3.2.3.1.4 Rigging provisions	119
3.2.3.2 Mechanical signal transmission	119
3.2.3.2.1 Load capability	119
3.2.3.2.2 Strength to clear or override jammed hydraulic valves	120
3.2.3.2.3 Power control override provisions	120
3.2.3.2.4 Control cable installations	120
3.2.3.2.5 Push-Pull rod installations	133
3.2.3.2.6 Control chain	135
3.2.3.2.7 Push-pull flexible controls	135
3.2.3.3 Electrical signal transmission	136
3.2.3.3.1 Electrical flight control (EFC) interconnections	137
3.2.3.3.2 Multiplexing	139
3.2.4 Signal computation	140
3.2.4.1 General requirements	140
3.2.4.1.1 Transient power effects	140
3.2.4.1.2 Interchangeability	140
3.2.4.1.3 Computer signals	140
3.2.4.2 Mechanical signal computation	141
3.2.4.2.1 Element loads	141
3.2.4.2.2 Geared mechanisms	141
3.2.4.2.3 Hydraulic elements	141
3.2.4.2.4 Pneumatic elements	142
3.2.4.3 Electrical signal computations	142
3.2.4.3.1 Analog computation	143
3.2.4.3.2 Digital computation	143
3.2.5 Control power	145
3.2.5.1 Power capacity	145
3.2.5.2 Priority	146
3.2.5.3 Hydraulic power subsystems	146
3.2.5.4 Electrical power subsystems	147

Contracts

TABLE OF CONTENTS (CONT'D)

	PAGE
3.2.5.4.1 Electromagnetic interference limits	148
3.2.5.4.2 Overload protection	148
3.2.5.4.3 Phase separation and polarity reversal protection	148
3.2.5.5 Pneumatic power subsystems	151
3.2.6 Actuation	151
3.2.6.1 Load capability	151
3.2.6.1.1 Load capability of elements subjected to pilot loads	151
3.2.6.1.2 Load capability of elements driven by power actuators	151
3.2.6.2 Mechanical force transmitting actuation	152
3.2.6.2.1 Force transmitting powerscrews	152
3.2.6.3 Mechanical torque transmitting actuation	153
3.2.6.3.1 Torque tube systems	153
3.2.6.3.2 Gearing	154
3.2.6.3.3 Flexible shafting	154
3.2.6.3.4 Helical splines	154
3.2.6.3.5 Rotary mechanical actuators	154
3.2.6.3.6 Torque limiters	154
3.2.6.3.7 No-Back brakes	155
3.2.6.4 Hydraulic actuation	155
3.2.6.4.1 Hydraulic servoactuators	155
3.2.6.4.2 Motor-pump--servoactuator (MPS) packages	157
3.2.6.4.3 Actuating cylinders	157
3.2.6.4.4 Force synchronization of multiple hydraulic servoactuators	157
3.2.6.4.5 Hydraulic motors	158
3.2.6.5 Electromechanical actuation	158
3.2.6.6 Pneumatic actuation	158
3.2.6.6.1 High-pressure pneumatic actuation provisions	158
3.2.6.6.2 Pneumatic drive turbines	158
3.2.6.7 Interfaces between actuation systems, support structure, and control surfaces	159
3.2.6.7.1 Control surface stops	159
3.2.6.7.2 Control surface ground gust protection	159
3.2.6.7.3 Control surface flutter and buzz protection	160
3.2.7 Component design	165
3.2.7.1 Common requirements	165
3.2.7.1.1 Standardization	165
3.2.7.1.2 Interchangeability	165
3.2.7.1.3 Selection of specifications and standards	165
3.2.7.1.4 Identification of product	165
3.2.7.1.5 Inspection seals	165
3.2.7.1.6 Moisture pockets	165
3.2.7.2 Mechanical components	166
3.2.7.2.1 Bearings	166
3.2.7.2.2 Controls and knobs	166

Contracts

TABLE OF CONTENTS (CONT'D)

	PAGE
3.2.7.2.3 Dampers	166
3.2.7.2.4 Structural fittings	166
3.2.7.2.5 Lubrication	167
3.2.7.3 Electrical and electronic components	167
3.2.7.3.1 Dielectric strength	167
3.2.7.3.2 Microelectronics	167
3.2.7.3.3 Burn-in	167
3.2.7.3.4 Switches	167
3.2.7.3.5 Thermal design of electrical and electronic equipment	167
3.2.7.3.6 Potentiometers	168
3.2.8 Component fabrication	169
3.2.8.1 Materials	169
3.2.8.1.1 Metals	169
3.2.8.1.2 Nonmetallic materials	169
3.2.8.1.3 Electric wire and cable	169
3.2.8.2 Processes	169
3.2.8.2.1 Construction processes	169
3.2.8.2.2 Corrosion protection	169
3.2.8.2.3 Fabrication of electrical and electronic components	169
3.2.8.3 Assembling	169
3.2.8.3.1 Mechanical joining	169
3.2.8.3.2 Joint retention	169
3.2.8.3.3 Assembly of electronic components	171
3.2.9 Component installation	173
3.2.9.1 Basic requirements	173
3.2.9.2 Locating components	173
3.2.9.3 Installation in fuel system areas	173
3.2.9.4 Electrical and electronic component installations	173
3.2.9.5 Electrical and electronic equipment cooling	173
3.3 Rotary wing performance and design	174
3.3.1 Special manual FCS performance requirements	174
3.3.2 Special automatic FCS performance requirements	174
3.3.2.1 Attitude hold (pitch, roll, and yaw)	174
3.3.2.2 Heading hold and heading select	174
3.3.2.3 Altitude hold	174
3.3.2.3.1 Barometric altitude stabilization	174
3.3.2.3.2 Stabilization of altitude above the terrain	174
3.3.2.4 Hover hold	174
3.3.2.5 Vernier control for hovering	175
3.3.2.6 Groundspeed hold	175
3.3.3 Special design requirements	175
3.3.3.1 Manual FCS design	175
3.3.3.1.1 Control feedback	175
3.3.3.1.2 Feel augmentation	176
3.3.3.2 AFCS design	176
3.3.3.3 Swashplate power actuators	176

TABLE OF CONTENTS (CONT'D)

	PAGE
3.3.3.3.1 Redundancy	176
3.3.3.3.2 Jamming	176
3.3.3.3.3 Frequency response	176
3.3.3.4 Actuation stiffness	177
3.3.3.5 Fatigue life design	177
3.3.3.5.1 Fail-safe	177
3.3.3.5.2 Display	177
3.3.3.6 Built-in test	178
4.0 QUALITY ASSURANCE	179
4.1 General requirements	179
4.1.1 Methods for demonstration of compliance	179
4.1.1.1 Analysis	179
4.1.1.2 Inspection	179
4.1.1.3 Test	179
4.2 Analysis requirements	179
4.2.1 Piloted simulations	179
4.3 Test requirements	182
4.3.1 General test requirements	182
4.3.1.1 Test witness	182
4.3.1.2 Acceptance tests	182
4.3.1.3 Instrumentation	182
4.3.1.4 Test conditions	183
4.3.2 Laboratory tests	183
4.3.2.1 Component tests	183
4.3.2.2 Functional Mockup and simulator tests	186
4.3.2.3 Safety-of-flight tests	188
4.3.2.3.1 Component safety-of-flight tests	188
4.3.2.3.2 System safety-of-flight tests	188
4.3.3 Airplane ground tests	188
4.3.4 Flight tests	199
4.4 Documentation	199
4.4.1 Flight control system development plan	199
4.4.2 Flight control system specification	200
4.4.3 Design and test data requirements	201
4.4.3.1 FCS analysis report	201
4.4.3.2 FCS qualification and inspection report	202
4.4.3.3 FCS test report	202
5.0 PREPARATION FOR DELIVERY	205
5.1 Packaging requirements	205
6.0 NOTES	205
6.1 Intended use	205
6.2 Procedure for requesting deviations	205
6.3 Reordered equipment or second source procurement	205
6.4 User's guide	205
6.5 Abbreviations	205
6.6 Definitions	205

TABLE OF CONTENTS (CONT'D)

	PAGE
6.7 Use of limited coordination specifications	210
6.8 Identification of changes	210
REFERENCES	211
APPENDIX A DERIVATION OF RELIABILITY REQUIREMENTS FROM ACTUAL FIELD SAFETY EXPERIENCE DATA	217
APPENDIX B METHODS OF DETERMINING COMPONENT OR SUBSYSTEM RELIABILITY INCREASES REQUIRED TO COMPENSATE FOR BLIND REDUNDANCIES	231

Contracts

LIST OF FIGURES

FIGURE		PAGE
1D	AF/Contractor interaction during development process . . .	3
1	Acceleration weighing functions	32
2D	Effect of combined acceleration on pilot rating	34
3D	Typical FCS block diagram	46
4D	Exceedance probability vs. altitude and RMS Gust Amplitude	54
2	Cumulative probability of reported mean wind and cross wind when landing	55
5D	Mean smoothed spectrum at 100 ft height compared with model spectra having the same RMS and various values of scale lengths	58
6D	Mean smoothed spectra for six one-hour runs, fitted to give same spectral density at short wave lengths . . .	59
7D	Typical division of overall aircraft allowable loss rate	77
8D	Simplified version of approach outcome "tree"	82
9D	Longitudinal approach outcome "tree"	83
10D	Lateral approach outcome "tree"	84
11D	Longitudinal approach and landing performance "tree" . . .	85
12D	Lateral approach and landing performance "tree"	86
13D	Effects of pulley dimension on cable life 3/16" 7 x 19 preformed stainless steel cable	127
14D	Rigging load and operating deflection	130
15D	Actuator stiffness determination	161
16D	Actuator stiffness vs frequency	162
17D	Typical limit cycle ground test characteristics	191
18D	Typical limit cycle ground test characteristics of the pitch SAS of the HL-10 lifting body at various points within the system	192
19D	B-52 CCV ground test mechanization	194
A1	Aircraft major accidents - material failure primary cause - per 100,000 hours	225
A2	Aircraft major accidents - material failure primary cause - per 100,000 flights	226
A3	Potential and actual material failure aircraft loss rates (fighter aircraft)	227

LIST OF FIGURES (CONT'D)

FIGURE		PAGE
A4	Potential and actual material failure aircraft loss rates (Helicopter aircraft)	228
A5	Potential and actual material failure aircraft loss rates (bomber/transport aircraft)	229
A6	Potential and actual material failure aircraft loss rates (F-111 aircraft)	230

LIST OF TABLES

TABLE		PAGE
I	Minimum acceptable control accuracy	22
II	Ride discomfort index limits	30
ID	Minimum redundancy levels for nonmechanical implementations	38
III	Gain and phase margin requirements	43
IV	Turbulence intensity exceedance probability	49
V	RMS gust intensities for selected cumulative exceedance probabilities	50
VI	RMS turbulence level and scale length by axis	56
VII	FCS quantitative flight safety requirements	73
IID	Flight control system ground test experience	198
IIID	Recommended verification means	201
BI	Solution of single-blind redundancy	232
BII	Solution of double-blind redundancy	233

Contrails

SECTION I

INTRODUCTION

This document is published in support of Military Specification MIL-F-9490D, "Flight Control Systems - Design, Installation and Test of Piloted Aircraft, General Specification For". The Air Force Flight Dynamics Laboratory, with the contracted help of The Boeing Company, has conducted a two year revision effort to update MIL-F-9490. The purpose of this document is to explain the philosophy and data used to update the specification and to aid the MIL-F-9490 user in interpreting the requirements. The current Military Specification shall apply in the event of conflict with this document.

Discussion sections are included in this document for each requirement or sequence of related requirements, following the organization and outline of MIL-F-9490D. Where pertinent, general discussions are included to explain the philosophy behind major changes in MIL-F-9490C requirements. Appendices are included which discuss detailed information on special subjects such as reliability.

The revision effort was initiated in early 1972 with a series of meetings between the Air Force and Boeing to establish an overall revision philosophy. These meetings at Wright-Patterson Air Force Base were extended in April 1972 to include the following members of industry.

- 11 April - General Dynamics (Fort Worth)
- 11 April - Honeywell
- 12 April - Sikorsky
- 13 April - Lockheed-Georgia
- 14 April - North American Rockwell
- 18 April - Sperry
- 18 April - General Electric
- 19 April - Bendix
- 20 April - McDonnell (St. Louis)
- 21 April - Calspan Corporation
- 21 April - Vought Aeronautics

Fairchild Republic Division, although unable to attend the AF/Industry Meetings, submitted written recommendations on 19 April. This series of meetings, provided a cross-section of opinion from the industry on the deficiencies of the existing specification and provided a base for the initial revision effort.

Visits to the General Dynamics (Fort Worth) and North American Rockwell (Los Angeles) plants were made during May to follow-up on recommendations made during the AF/Industry meetings.

On June 6 and 7 a series of Boeing internal MIL-F-9490 meetings were held in Seattle. The purpose of these meetings was to discuss the general content to be included in major specification subsections and to identify individuals responsible for initial drafts. Follow-on meetings between the

Contrails

AFFDL steering committee and Boeing were held approximately quarterly for the next two years as drafts of the User's Guide and Specification evolved.

As the draft approached completion, the Air Force submitted it to pertinent members of industry and government for review and comment. A first review took place in the Fall of 1973 and the second and final review was accomplished during April and May of 1974. The comments received were considered by the Air Force steering committee and integrated into the drafts by the authors where pertinent.

From the initial planning, the revision of MIL-F-9490 was based upon a philosophy of the "LOGICAL DEVELOPMENT SEQUENCE" of sound engineering practice from which most successful flight control systems evolve. Most air-frame primes already practice the procedures outlined and will not have to undertake additional tasks in MIL-F-9490 with which they are unfamiliar. Once a contract is awarded for a new weapon system, the LOGICAL DEVELOPMENT SEQUENCE as shown in Figure 1D consists of:

- a. A detailed Flight Control System Specification prepared by the contractor which establishes the flight control functions, performance, reliability safety, maintainability, and survivability requirements to satisfy mission requirements and performance established by the contract work statement. It is intended that this be a viable document updated as necessary throughout the design process to reflect changes which become apparent as the system design matures.
- b. Design phase to implement the detailed requirements established by the Flight Control System Specification. Analysis is performed in conjunction with the design phase to satisfy stability, performance, reliability, safety, maintainability, survivability and cost requirements. Component designs are established. Pilot-in-the-loop simulations are conducted employing math models of the control system to verify the flying quality and human factor elements of the design under realistic mission task formulation. Make or buy component and system hardware specifications are produced from this phase of the development.
- c. Fabrication and assembly of components accompanied by qualification and/or flight-worthiness tests of equipment.
- d. Repeat of pilot-in-the-loop simulation tests with flight hardware interconnected to the computer simulation of the aircraft dynamics. Final tests would be combined with an operational mockup (iron-bird) realistically evaluating total flight control system operation under proper loading of the actuators and electrical and hydraulic power supplies. Note that the operational mockup can be the same test rig required by MIL-H-5440 Hydraulic Systems Specification. Failure effects of the flight control system would also be evaluated on this test rig.
- e. Installation of the FCS into the aircraft and ground tests to verify the operation. Ground testing would include frequency response, structural effects, gain margin (limit cycle), and EMI tests in the aircraft prior to test flight.

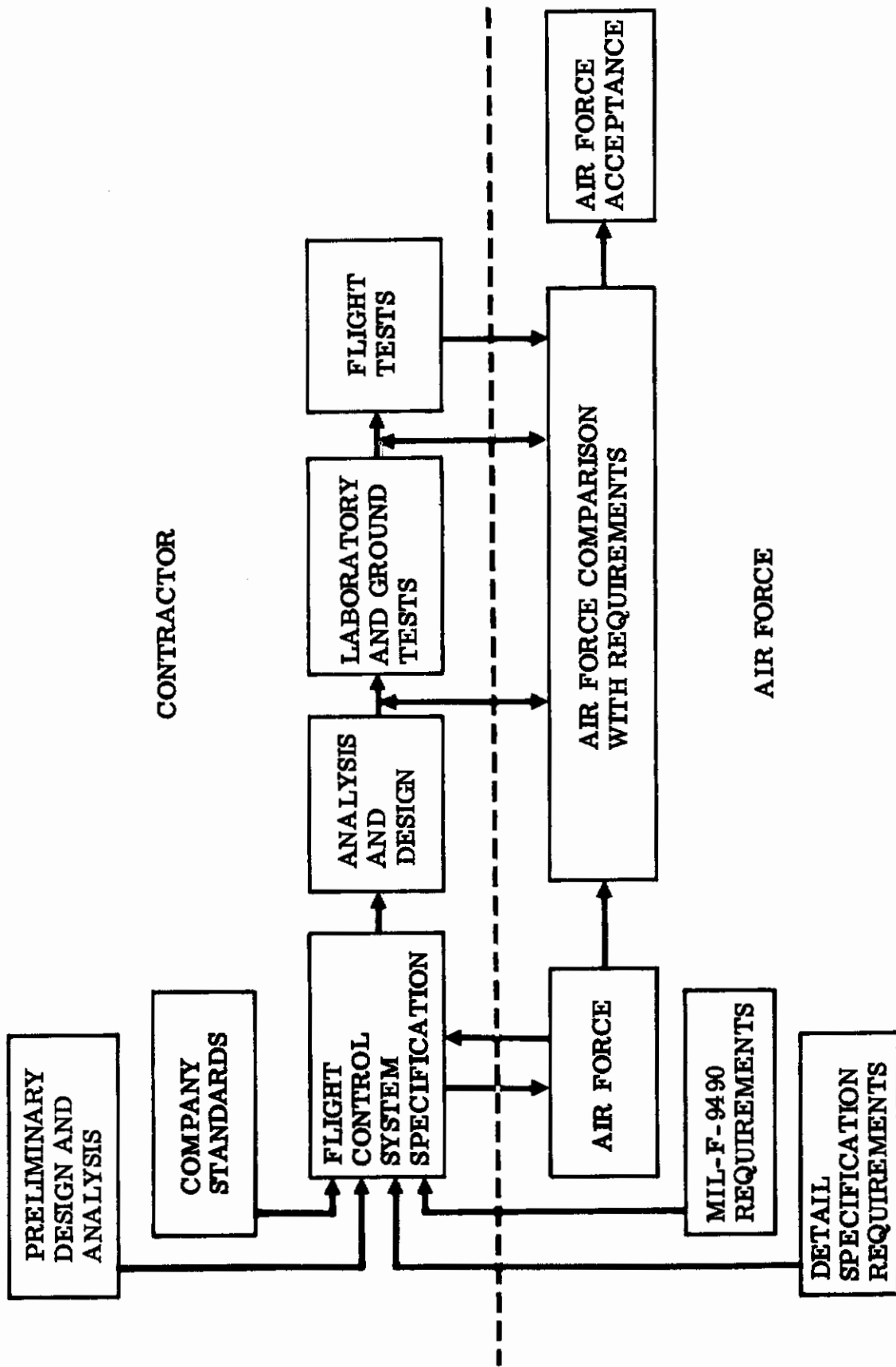

Figure 1D. AF/Contractor interaction during development process

Contrails

f. Flight tests throughout the specified flight envelope and mission correlation should be maintained throughout the flight phase with analysis and simulator results.

While the actual development sequence is rarely a clear-cut series of events but most often results in an iterative redesign and redefine design cycle with many phases going on simultaneously in parallel, this structure serves as the framework for the MIL-F-9490 revision and major documentation sources. Also, the LOGICAL DEVELOPMENT SEQUENCE is based upon flight control requirements for major production aircraft developments. For less stringent programs such as advanced developments, prototype aircraft, experimental aircraft, off-the-shelf aircraft buys, etc., the procuring agency may elect to bypass particular design requirements and some of the rigorous steps in development or in documentation. In those cases, exception will be taken in the contract designating those phases which will be exempted.

Freedom is to be allowed to the flight control system designer to select the mechanization techniques, redundancy requirements, and analysis methods which best satisfy overall aircraft performance, mission tasks, safety, maintainability, and cost constraints. Once the designer has selected his technical approach, MIL-F-9490 contains three sections consisting of System, Subsystem, and Component requirements based on past experience and recent flight control technology developments which are to govern the final development and test effort.

Figure 1D also defines the Air Force/contractor interactions desired throughout the LOGICAL DEVELOPMENT SEQUENCE for the flight control system. The objective is to establish key milestones throughout the development and test cycle which will provide the Air Force assurance that the end design will satisfy the requirements rather than discovering design deficiencies in the flight test or operational stages. Documentation has been identified at key points throughout the development cycle and must be periodically updated as the system design matures. Documentation consists of:

- a. FCS Development Plan
- b. FCS System Specification
- c. Analysis Report (Including reliability, maintainability, safety, survivability, and simulation results)
- d. FCS Qualification and Inspection Report
- e. Final Test Report (Includes ground and flight test results)

Only those documents specified in the DD 1423 Contract Data Requirements List for the specific procurement are required deliverable items.

Factors relating to particular classifications and requirements of MIL-F-9490 will be specified in advance by the Air Force for a specific procurement. Typical factors to be provided by the government include:

- a. Mission scenario which is relatable to control law performance for specific mission tasks. Total environment such as anticipated global

Contracts

deployment and enemy retaliation threat should also be included. Quantitative mission tasks performance such as unguided weapon delivery criteria may be specified which impact the design of the flight control system.

b. Flight Control System Operation States

c. AFSC Modes

d. Reliability, Maintainability, Safety, Survivability and Cost Constraints. (Normally these factors are presented in terms of entire weapon system requirements and the contractor must budget each subsystem requirement accordingly.)

The specification has been organized around the major topics of system requirements, subsystem requirements and component requirements. The organization tree shown below illustrates this general organization.

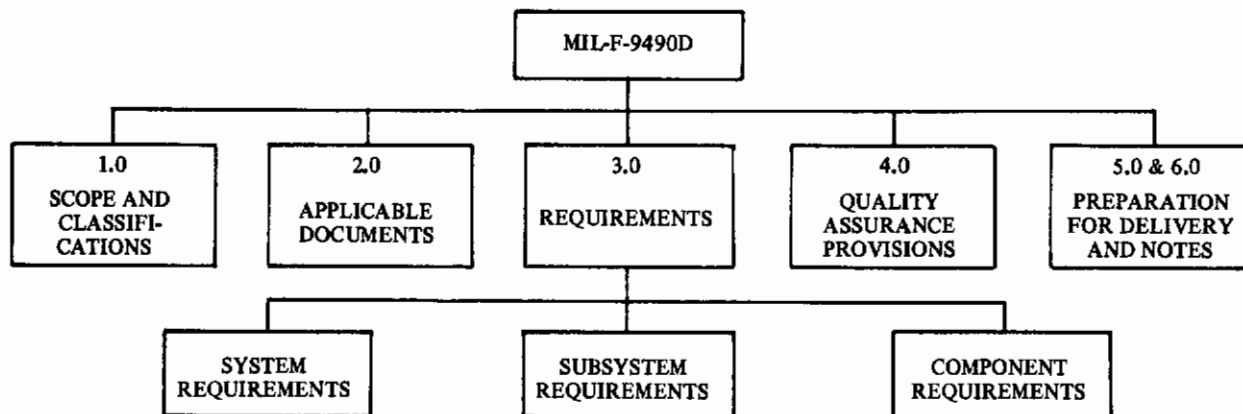

The first tier breakdown is standard, including scope, classifications, applicable documents, requirements, quality assurance provisions, preparation for delivery and notes. Within the requirements section, those requirements most important to system designers have been separated from requirements governing subsystem and component design. This was done in recognition that many prime contractors use separate organizations for FCS synthesis and design and for subsystem and component design. It must be recognized that the entire specification contains interrelated requirements which must be considered by each design team involved in the design process. One of the challenges of modern complex FCS design is to insure that communication within the interrelating technologies exists and that formal organizational structure does not prohibit or discourage interdisciplinary interaction at the working level.

System requirements include performance and design. One of the major expansions made under this revision was a comprehensive coverage of the "ilities" at the system level. System level failure immunity and other design requirements also received considerable attention. The organization tree shown below illustrates coverage included under system requirements.

Contrails

Many of these requirements are stated in terms of probabilities and the term "extremely remote" is often used. In each procurement, this term will have a quantitative value as specified by the procuring activity. This and other terms are defined in 6.6 of the specification.

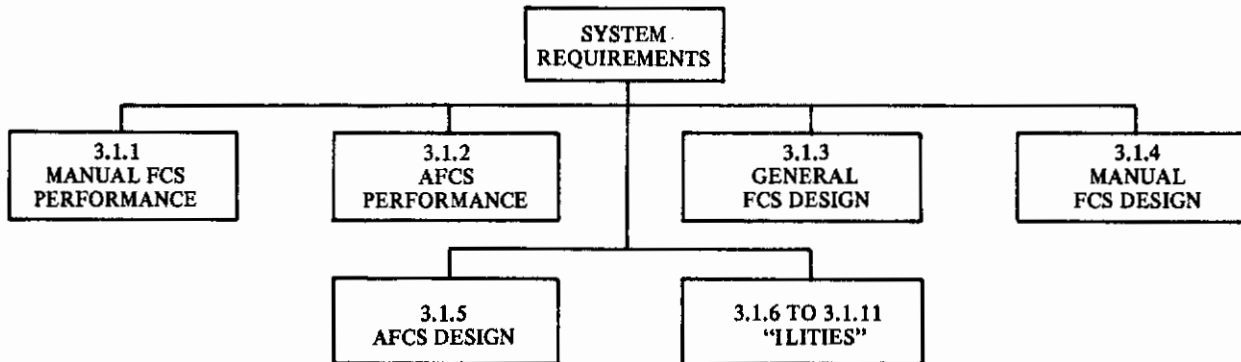

Subsystem requirements include pilot controls and displays, sensors, signal transmission and computation, control power and actuation requirements. The organization tree shown below illustrates this coverage.

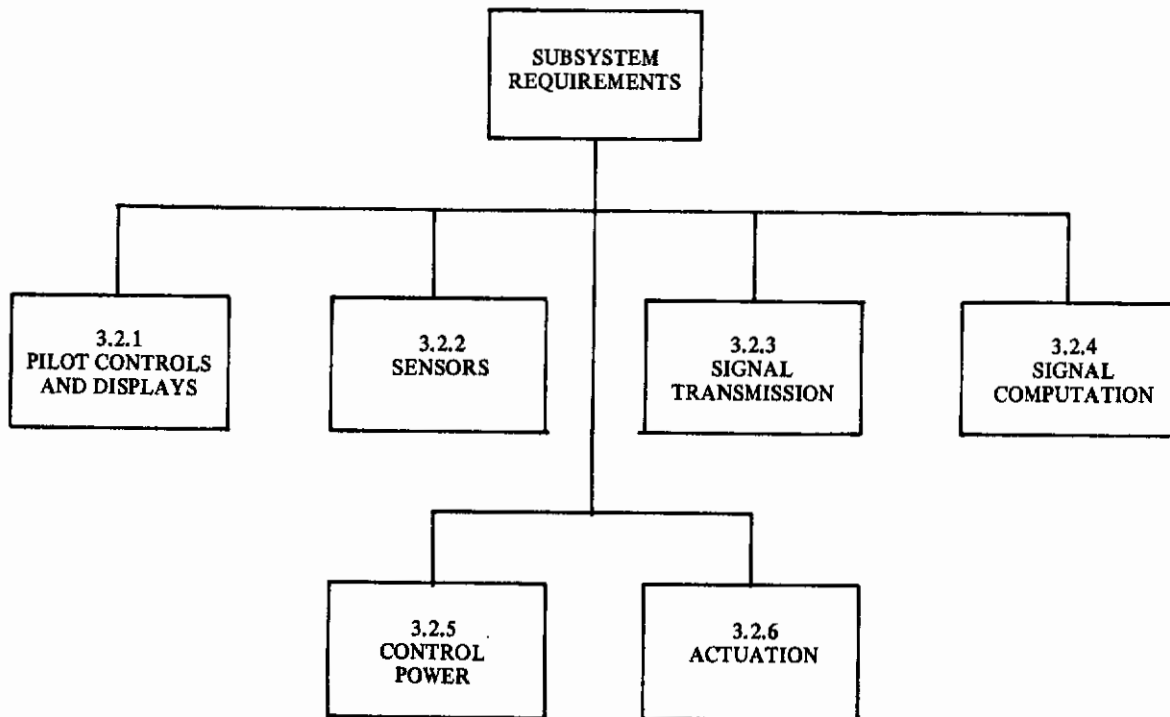

Contrails

Component design, fabrication and installation are included under component requirements in 3.2.7 through 3.2.9. Frequent reference to specific paragraphs of the AFCS Design Handbooks was made in this area and throughout the specification where additional design guidance is needed.

Classifications used in MIL-F-9490D include FCS types, FCS Operational States and FCS criticalities. FCS types are separated into Manual and Automatic FCS based on whether or not active pilot inputs are involved.

Five FCS Operational States are used to specify requirement. These states are illustrated below with key characteristics noted.

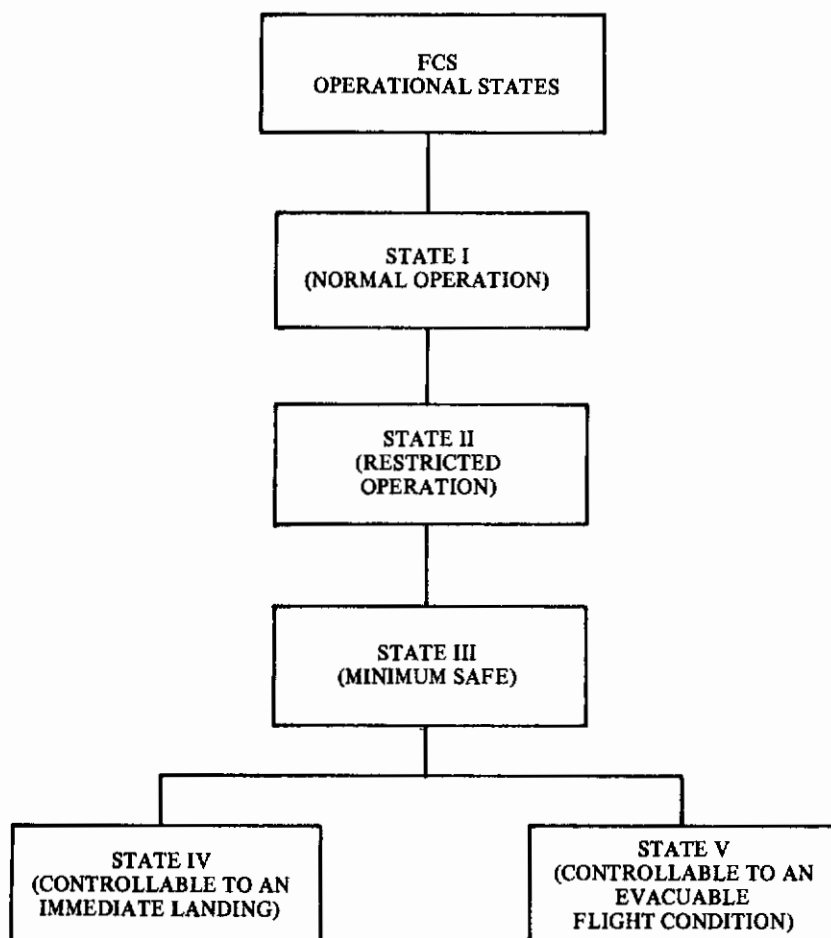

Three criticality classifications were adopted to organize requirements. Essential, flight phase essential and noncritical FCS functions are defined. The key separation is whether the function is needed to insure flight safety either full time, only during certain flight phases or not at all. These classifications are defined in Section 1.0 of the specification.

SECTION II

STATEMENT AND DISCUSSION OF REQUIREMENTS

1. SCOPE

1.1 Scope. This specification establishes general performance, design, development and quality assurance requirements for the flight control systems of USAF manned piloted aircraft. Flight control systems (FCS) include all components used to transmit flight control commands from the pilot or other sources to appropriate force and moment producers. Flight control commands may result in control of aircraft flight path, attitude, airspeed, aerodynamic configuration, ride, and structural modes. Among components included are the pilot's controls, dedicated displays and logic switching, transducers, system dynamic and air data sensors, signal computation, test devices, transmission devices, actuators, and signal transmission lines dedicated to flight control. Excluded are aerodynamic surfaces, engines, helicopter rotors, fire control devices, crew displays and electronics not dedicated to flight control. The interfaces of flight control systems with related subsystems are defined.

DISCUSSION

The scope for this MIL-F-9490 revision remains essentially the same as in MIL-F-9490C. Structural mode control and control of aerodynamic configuration have been emphasized in the scope statement since there have been advances in these areas in recent years.

The key to the definition of a flight control system is the term "all components used". The partial listing given is not meant to be complete. In each procurement a decision on what components are used to transmit commands must be made. Definition of interfaces and their characteristics must also be established.

Interfaces of flight controls with other subsystems must be considered by the contractor in meeting many of the requirements of MIL-F-9490. Reliability and failure immunity requirements, for example, require that failure effects in nondedicated subsystems be considered when such effects can impact flight controls.

1.2 Classification

1.2.1 Flight control system (FCS) classifications

1.2.1.1 Manual flight control systems (MFCS). Manual Flight Control Systems consist of electrical, mechanical and hydraulic components which transmit pilot control commands or generate and convey commands which augment pilot control commands, and thereby accomplish flight control functions. This classification includes the longitudinal, lateral-directional, lift, drag and variable geometry control systems. In addition, their associated augmentation, performance limiting and control devices are included.

Contrails

1.2.1.2 Automatic flight control systems (AFCS). Automatic Flight Control Systems consist of electrical, mechanical and hydraulic components which generate and transmit automatic control commands which provide pilot assistance through automatic or semiautomatic flight path control or which automatically control airframe response to disturbances. This classification includes automatic pilots, stick or wheel steering, autothrottles, structural mode control and similar control mechanizations.

DISCUSSION

FCS Classifications have been changed from the Primary, Secondary, Automatic classifications of MIL-F-9490C to Manual and Automatic FCS. The change from Primary/Secondary FCS to Manual FCS was made as a result of a serious concern with the high percentage (up to 50 percent) of recent Air Force incident/accident reports which are due to secondary flight control problems. To reduce the number of problems with Secondary Controls, the differentiation between Primary/Secondary control requirements in areas such as failure immunity has been dropped or sharply reduced.

Stability and Command Augmentation are included under Manual Flight Controls in this revision due to the increasing reliance of manual controls on augmentation. Structural Mode Control is included as an Automatic FCS function, with emphasis in this revision on ride smoothing and fatigue alleviation. Semiautomatic control includes flight director functions when the option of automatic or semiautomatic operation is provided.

Systems are classified as Structure Mode Control Systems only when this classification reflects their primary function. Most Dutch roll dampers reduce loads and improve ride in turbulence, although this is not their primary function.

1.2.2 FCS Operational State classifications

1.2.2.1 Operational State I (Normal operation). Operational State I is the normal state of flight control system performance, safety and reliability. This state satisfies MIL-F-8785 or MIL-F-83300 Level 1 flying qualities requirements within the operational flight envelope and Level 2 within the service envelope and the stated requirements outside of these envelopes.

1.2.2.2 Operational State II (Restricted operation). Operational State II is the state of less than normal equipment operation or performance which involves degradation or failure of only a noncritical portion of the overall flight control system. A moderate increase in crew workload and degradation in mission effectiveness may result from a limited selection or normally operating FCS modes available for use; however, the intended mission may be accomplished. This state satisfies at least MIL-F-8785 or MIL-F-83300 Level 2 flying qualities requirements within the operational flight envelope and Level 3 within the service envelope.

1.2.2.3 Operational State III (minimum safe operation). Operational State III is the state of degraded flight control system performance, safety or reliability which permits safe termination of precision tracking or maneuvering tasks, and safe cruise, descent, and landing at the destination

Contrails

of original intent or alternate but where pilot workload is excessive or mission effectiveness is inadequate. Phases of the intended mission involving precision tracking or maneuvering cannot be completed satisfactorily. This state satisfies at least MIL-F-8785 or MIL-F-83300 Level 3 flying qualities requirements.

1.2.2.4 Operational State IV (controllable to an immediate emergency landing). Operational State IV is the state of degraded FCS operation at which continued safe flight is not possible; however, sufficient control remains to allow engine restart attempt(s), a controlled descent and immediate emergency landing.

1.2.2.5 Operational State V (controllable to an evacuable flight condition). Operational State V is the state of degraded FCS operation at which the FCS capability is limited to maneuvers required to reach a flight condition at which crew evacuation may be safely accomplished.

DISCUSSION

FCS operational state classifications define a general framework about which FCS performance, in terms of FCS operational state, can be related to FCS reliability and safety requirements. These states parallel the MIL-F-8785B flying qualities Levels 1, 2 and 3. For example, FCS Operational State I may be equated with Level 1 flying qualities within the normal flight envelope. However, the FCS Operational State II may correspond to either Level 1 or Level 2 flying qualities. FCS Operational State II may result due to loss of a ride smoothing or automatic guidance function, for example, while Level 1 flying qualities are maintained.

A State III FCS operational level may be reached through degradation of any flight control function to a state which requires landing at the nearest friendly base. A FCS failure mode leading to Level 3 flying qualities will result in an Operational State III designation. In addition, single or multiple channel failures resulting in a minimum safe configuration in a redundant FCS required for safety-of-flight, may also result in FCS Operational State III even though the remaining FCS channel(s) may still provide Level 1 flying qualities. Note that in some cases single thread mechanical controls may meet reliability requirements. In these cases, redundancy is not required for Level 1 operation.

The Operational State IV classification is a new concept which recognizes that a level of FCS performance is required for aircraft such as MIL-F-8785 Class III following critical failures within the flight controls, engines or other systems which prohibit continued safe flight. The intent of this classification is to provide for those FCS minimum requirements needed to escape a hostile area or flight conditions to arrive at a safe evacuable flight condition.

In each procurement the procuring activity will specify whether State IV or State V applies (See 3.1.8).

1.2.3 FCS criticality classification

1.2.3.1 Essential. A function is essential if loss of the function results in an unsafe condition or inability to maintain FCS Operational State III.

1.2.3.2 Flight phase essential. A function is flight phase essential if loss of the function results in an unsafe condition or inability to maintain FCS Operational State III only during specific flight phases.

1.2.3.3 Noncritical. A function is noncritical if loss of the function does not affect flight safety or result in control capability below that required for FCS Operational State III.

DISCUSSION

Classifications of criticality are defined around which system implementation requirements can be organized. MIL-F-9490C assumed that all Primary FCS were flight essential and all Secondary FCS were noncritical. No general criticality distinction is made in this specification among the FCS classifications of Manual FCS and the classifications of Automatic FCS. For each procurement, the contractor will evaluate the criticality of each flight control function based on the mission requirements specified by the procuring agency and design approach selected by the contractor. For example, in a given procurement one contractor may choose to utilize an airplane configuration which requires an essential stability augmentation system, while a competing contractor may select a different airplane configuration which accomplishes the same mission, but uses a noncritical stability augmentation system.

2.0 APPLICABLE DOCUMENTS

2.1 The following documents, of the issue in effect on the date of invitation for bids or request for proposal, form a part of this specification to the extent specified herein. The requirements of this specification shall govern for flight control system design where conflicts exist between this specification and other referenced specifications.

SPECIFICATIONS

Military

MIL-T-781	Terminal, Wire Rope, Swaging
MIL-F-3541	Fitting, Lubrication
MIL-U-3963	Universal Joint, Antifriction Bearings
MIL-B-5087	Bonding, Electrical and Lightning Protection, for Aerospace Systems
MIL-W-5088	Wiring, Aircraft, Selection and Installation of
↓ MIL-E-5400	Electronic Equipment, Airborne, General Specification for
↓ MIL-H-5440	Hydraulic Systems, Aircraft Types I and II, Design, Installation, and Data Requirements for
↓ MIL-C-5503	Cylinder, Aeronautical, Hydraulic Actuating, General Requirements for
↓ MIL-P-5518	Pneumatic Systems, Aircraft, Design, Installation, and Data Requirements for
↓ MIL-T-5522	Test Procedure for Aircraft Hydraulic and Pneumatic Systems, General
MIL-S-5676	Splicing Cable Terminal, Process for, Aircraft
MIL-T-5677	Thimble, Wire Cable, Aircraft
MIL-B-5687	Bearing, Sleeve, Washers, Thrust, Sintered, Metal Powder, Oil-Impregnated
MIL-C-6021	Casting, Classification and Inspection of
MIL-B-6038	Bearing, Ball, Bellcrank, Antifriction, Airframe
MIL-B-6039	Bearing, Double Row, Ball, Sealed, Rod End, Antifriction, Self-Aligning
MIL-E-6051	Electromagnetic Compatibility Requirements, Systems
MIL-T-6117	Terminal, Cable Assemblies, Swaged Type
MIL-J-6193	Joint, Universal, Plain, Light and Heavy Duty
MIL-G-6641	Gearbox, Aircraft Accessory Drive, General Specification for
MIL-P-7034	Pulley, Groove, Antifriction-Bearing, Grease-Lubricated, Aircraft
MIL-I-7064	Indicator, Position, Elevator Trim Tab
MIL-E-7080	Electric Equipment; Aircraft, Selection and Installation of
MIL-F-7190	Forging, Steel, for Aircraft and Special Ordnance Applications
MIL-D-7602	Drive, Turbine, Air, Aircraft Accessory, General Specification for
MIL-B-7949	Bearing, Ball, Airframe, Antifriction
MIL-C-7958	Control, Push-Pull, Flexible and Rigid
MIL-M-7969	Motor, AC, 400 Cycle, 115/200 Volt System, Aircraft, General Specification for

Contracts

MIL-M-7997	Motor, Aircraft Hydraulic, Constant Displacement, General Specification for
MIL-I-8500	Interchangeability and Replaceability of Component Parts for Aircraft and Missiles
✓ MIL-P-8564	Pneumatic System Components, Aeronautical, General Specification for
MIL-M-8609	Motor, DC, 28 Volt System, Aircraft, General Specification for
✓ MIL-S-8698	Structural Design Requirements, Helicopters
✓ MIL-H-8775	Hydraulic System Components, Aircraft and Missiles, General Specification for
✓ MIL-F-8785	Flying Qualities of Piloted Airplanes
MIL-A-8860	Airplane Strength and Rigidity, General Specification for
MIL-A-8861	Airplane Strength and Rigidity, Flight Loads
MIL-A-8865	Airplane Strength and Rigidity; Miscellaneous Loads
MIL-A-8866	Airplane Strength and Rigidity - Reliability Requirements, Repeated Loads, and Fatigue
MIL-A-8867	Airplane Strength and Rigidity, Ground Tests
MIL-A-8870	Airplane Strength and Rigidity Flutter; Divergence, and Other Aeroelastic Instabilities
MIL-T-8878	Turnbuckle, Positive Safetying
MIL-S-8879	Screw Threads, Controlled Radius Root with Increased Minor Diameter; General Specification for
✓ MIL-H-8890	Hydraulic Components, Type III, -65° to +450°F, General Specification for
✓ MIL-H-8891	Hydraulic Systems, Manned Flight Vehicles, Type III, Design, Installation, and Data Requirements for
MIL-A-8892	Airplane Strength and Rigidity, Vibration
MIL-A-8893	Airplane Strength and Rigidity, Sonic Fatigue
MIL-B-8976	Bearing, Plain, Self-Aligning, All-Metal
MIL-S-9419	Switch, Toggle, Momentary, Four-Position On, Center Off
MIL-C-18375	Cable, Steel (Corrosion-Resisting, Nonmagnetic) Flexible, Preformed (for Aeronautical Use)
MIL-A-21180	Aluminum-Alloy Casting, High Strength
MIL-A-22771	Aluminum Alloy Forgings, Heat Treated
MIL-K-25049	Knob, Control, Equipment, Aircraft
MIL-G-25561	Grip Assembly, Controller, Aircraft, Type MC-2
MIL-V-27162	Valve, Servocontrol, Electrohydraulic, General Specification for
MIL-C-27500	Cable, Electrical, Shielded and Unshielded, Aircraft and Missile
MIL-E-38453	Environmental Control, Environmental Protection, and Engine Bleed Air Systems, Aircraft, and Aircraft Launched Missiles, General Specification for
MIL-M-38510	Microcircuit, General Specification for
MIL-B-81820	Bearing, Plain, Self-Lubricating, Self-Aligning, Low Speed
MIL-F-83142	Forging, Titanium Alloys, for Aircraft and Aerospace Applications
✓ MIL-F-83300	Flying Qualities of Piloted V/STOL Aircraft
✓ MIL-W-83420	Wire Rope, Flexible, for Aircraft Control
✓ MIL-A-83444	Airplane Damage Tolerance Requirements

Contrails

STANDARDS

Military

MIL-STD-130	Identification Marking of U.S. Military Property
MIL-STD-143	Standards and Specifications, Order of Precedence for the Selection of
↓ MIL-STD-250	Aircraft Station Controls and Displays for Rotary Wing Aircraft
MIL-STD-421	Chain Roller; Power Transmission and Conveyor, Flat Link Plates, Single Pitch, Single and Multiple Strand, Connective Links and Attachment Links
MIL-STD-454	Standard General Requirements for Electronic Equipment
MIL-STD-461	Electromagnetic Interference Characteristics Requirements for Equipment
MIL-STD-480	Configuration Control - Engineering Changes, Deviations and Waivers
MIL-STD-704	Electric Power, Aircraft, Characteristics and Utilization of
MIL-STD-810	Environmental Test Methods
MIL-STD-838	Lubrication of Military Equipment
MIL-STD-1472	Human Engineering Design Criteria for Military Systems, Equipment and Facilities
MIL-STD-1530	Aircraft Structural Integrity Program, Airplane Requirements
MIL-STD-1553	Aircraft Internal Time Division Multiplex Data Bus
MS15002	Fittings, Lubrication (hydraulic) Surface Check, Straight Threads, Steel, Type II
MS15981	Fasteners, Externally Threaded, Self-Locking, Design and Usage Limitations for
MS24665	Pin, Cotter
MS33540	Safety Wiring and Cotter Pinning, General Practices for
MS33572	Instrument, Pilot, Flight, Basic, Standard Agreement for
MS33588	Nuts, Self-Locking, Aircraft Design and Usage Limitations of
MS33602	Bolt, Self Retaining, Aircraft Reliability and Maintainability Design and Usage, Requirements for
MS33736	Turnbuckle Assemblies, Clip Locking of

PUBLICATIONS

Military Handbooks

MIL-HDBK-5	Metallic Materials and Elements for Aerospace Vehicle Structures
MIL-HDBK-17	Plastics for Flight Vehicles

Air Force Systems Command Design Handbooks

AFSC DH 1-2	General Design Factors
AFSC DH 1-4	Electromagnetic Compatibility
AFSC DH 1-5	Environmental Engineering

Contracts

AFSC DH 1-6 System Safety
AFSC DH 2-1 Airframe
✓ AFSC DH 2-2 Crew Stations and Passenger Accommodations

(Copies of specifications, standards, drawings, publications and handbooks required by suppliers in connection with specific procurement functions should be obtained from the procuring activity or as directed by the contracting officer.)

2.2 Other Publications. The following documents form a part of this specification to the extent specified herein. Unless otherwise indicated, the issue in effect on date of invitation for bids or request for proposal shall apply.

National Aircraft Standard

NAS 516 Fitting, Lubrication - 1/8 Inch Drive, Flush Type

(Copies of National Aircraft Standards may be obtained from the Aircraft Industries Association of America, Inc., Shoreham Building, Washington, D. C.)

SAE Aerospace Recommended Practices

ARP 988 Electrohydraulic Mechanical Feedback Servoactuators
ARP 1281 Servoactuators: Aircraft Flight Controls, Power
 Operated, Hydraulic, General Specification for

(Application for copies should be addressed to the American Society of Automotive Engineers, Two Pennsylvania Plaza, New York, New York 10001.)

ICAO Practices

ICAO Annex 10 International Civil Aviation Organization Publication -
 Aeronautical Telecommunications Vol. II, Communication
 Procedures, International Standards, Recommended Prac-
 tices and Procedures for Air Navigation Services

FAA Advisory Circular

FAA Advisory Criteria for Approving Category I and Category II Land-
Circular 120-29 ing Minima for FAR 121 Operators

Technical Reports

AFFDL-TR-74-116 Background Information and User Guide for MIL-F-9490D

(Technical society and technical association specifications and standards are generally available for reference from libraries. They are also distributed among technical groups and using Federal agencies.)

3.0 REQUIREMENTS

3.1 System requirements. The FCS shall comply with the following requirements.

DISCUSSION

The following sections specify general requirements for flight control systems. Additional detail system requirements and the aerodynamic and flight configurations, external stores configurations, and aircraft performance range through which the flight control system will be required to satisfy these requirements shall be as defined in the procurement detail specification. Paragraph 3.2 defines subsystem and component requirements and 3.3 defines special flight control system requirements for rotary wing aircraft.

This section specifies system requirements in terms of performance and design requirements. This specification does not place priorities on either performance or design requirements, considering all requirements to be of equal importance. Performance requirements specify what the system must provide or do. Design requirements constrain the system design to insure that system operation will be acceptable in service. The reader should be fully aware that system development must include consideration of costs, maintenance, complexity, and safety, as well as performance. Procuring activity desires or requirements may be often in conflict in two or more of these asset/liability areas. The contractor is expected to perform trade studies to evaluate tradeoffs involved. Data from these trade studies will normally be required to obtain deviations, as noted in 6.2.

3.1.1 MFCs Performance requirements. The MFCs shall comply with applicable general flying quality requirements of MIL-F-8785 or MIL-F-83300 and the special performance requirements of the procurement detail specification.

DISCUSSION

The sources for Manual FCS performance requirements are MIL-F-8785, MIL-F-83300 and the procurement detailed specification. This specification defines design requirements for all FCS and performance requirements for Automatic FCS. Reference 1 provides background and user information supporting MIL-F-8785B.

Research has been pursued in recent years to identify analytical procedures and techniques which provide an organized approach to satisfying Manual FCS performance requirements. The weapons delivery requirements of individual procurements can often be best approached through a paper pilot (Reference 2) or simulation approach. Reference 3 documents a series of Air Force studies on piloted weapon delivery which may be helpful in procurements where strafing, dive bombing, or aerial gunnery is a mission requirement. Reference 4 documents a similar study considering higher order controls system dynamics. Reference 5 discusses multimode flight control for precision weapon delivery and concludes that a control system specifically designed for gunnery is superior to a conventional SAS for weapons delivery purposes. Reference 6 documents a study to develop improved design criteria for command augmentation. The study consisted of eight parts, including a

Contrails

survey of operational problems, a review of system-gain changing requirements and techniques, stabilization criteria for frequency modes, an analysis of stall-spin maneuvers, an analysis of system/airframe compatibility testing, definition of criteria for built-in-test equipment, and catalogs of flight control actuator designs and of dominant performance characteristics which affect flying qualities.

References 7 and 8 document a flight test evaluation of a high gain CAS in an F-4. One conclusion of this flight test was that MIL-F-8785B (ASG) does not properly address the requirements for a stable, controllable platform for accomplishing a tracking task. Reference 9 is an interesting study titled "Outsmarting MIL-F-8785B (ASG), The Military Flying Qualities Specification." This study points out some of the weaknesses of MIL-F-8785B and may aid the controls designer in understanding his complex task. Reference 10 describes the benefits of a Stall Inhibitor System developed for the F-111.

Reference 11 documents a survey of classical and modern control analysis methods for FCS design. This reference points out that a very large amount of published material exists relating to the design of flight control systems. Many methods are available for synthesis of controllers, ranging from classical cut-and-try methods to optimal techniques. Within the industry control designers are making use of a spectrum of these techniques, together with a fair amount of intuition, simulation, and hard work, to generate workable designs. No one technique has been shown to produce consistently superior designs.

An important conclusion of Reference 11 is that: "There does not exist any method or combination of methods which will permit a person not experienced in control to generate a workable design."

Numerous "good practices" are recommended in these references which are based on specific experience with individual airplanes or groups of airplanes. Due to the unique demands of individual procurements, most of these recommendations are not incorporated in this specification as requirements. However, for emphasis, the following recommended practices are listed for consideration.

Selectable command modes. Pilots will select and adapt to special augmentation modes during weapons delivery and other special flight phases where special mission task requirements conflict with normal flying qualities. The contractor should consider selectable command modes, where pertinent. But inconsistencies in display indications or the result of cockpit control motions can be confusing to the pilot. For example, reversals of sense must be avoided.

Stabilization axis. In control system designs in which the pilots lateral controller operates both ailerons and rudder or their equivalent, consideration should be given to the resultant effective axis of rotation. If one of the prime weapons of the vehicle is a fixed body mounted gun, the preferred effective axis of rotation should be coincident with the gun axis, which itself should be aligned along a stability axis defined by the anticipated angle-of-attack in firing mode. If the gun axis differs considerably from a stability axis at delivery, rotation about the gun axis

Contrails

will cause angle-of-attack to translate into sideslip, possibly of unacceptable amounts, and in this event the preferred axis should be between the gun and stability axes at a point at which sideslip in normal firing maneuvers is maintained at a satisfactorily small value. These considerations may conflict with the need to keep lateral acceleration in bounds at the cockpit.

Direct flight path control. Control systems for vehicles having pure sideforce generators should be designed bearing in mind the possible improvements in weapon delivery accuracy achievable by unconventional response to pilot controls. Control systems combining direct lift and sideforce generators, decoupling feedback and feed forward, and possibly a controller in addition to the usual stick and pedals may be used if expected improvements in weapon delivery accuracy can be demonstrated analytically or by simulation to the satisfaction of the procuring agency. Consideration should be given to control schemes in which the pedals or a separate controller give direct lateral flight path control with zero bank or sideslip and in which a column or a separate controller produces vertical flight path control with zero or small pitch change. The pilot's ability to handle an additional control, of course, is a factor.

Gust and external disturbance response. Designs where specific measures are taken to improve the gust and external disturbance response of the aircraft are recommended. The maintenance of ground track despite turbulence is of particular importance when high, level bombing is the probable vehicle mission. Designs incorporating the decoupling of sideslip from lateral control and bank angle from directional control should be examined particularly carefully with respect to the bank angles generated by side gusts. Decoupling techniques in current use can cause deterioration in gust response if attention is not given specifically to preventing the deterioration.

Limit cycles during weapons delivery. Adaptive or other automatic gain changing systems relying on limit cycle detection for gain changing decisions should be designed paying particular attention to the avoidance of the limit cycle during flight conditions at which weapons will be delivered. The limit cycle should be undetectable to the pilot. Similarly, if system gain changing takes place during weapon delivery, while the servos are moving, no thumping sensations should be experienced by the pilot and flying qualities must remain satisfactory throughout, despite the gain changes.

Trim changes. Apparent trim changes originating in the augmentation or control systems should be avoided whether due to extended low frequency response in the systems or to a normal accelerometer sensing less than 1g in a climb or dive. An automatic trim system reducing these apparent trim changes to below pilot threshold will normally be acceptable. Where there are directional trim changes with speed change during a weapon delivery run, systems designed to minimize the trim change are desirable.

Constant stick forces. Systems incorporating washout filters on sensor outputs or elsewhere in the system should be designed to avoid changes in stick force with time during sustained constant normal-acceleration turns.

Controls

Symmetrical stick forces. Control systems incorporating models should be designed to provide identical sensitivity for nose-down and nose-up commands. Whatever the system design, the stick forces for a given magnitude response should be the same irrespective of the sign of the command. This applies both laterally and longitudinally.

Aircraft flexibility. There can be effects beyond the impact of aero-elasticity on aircraft handling and flight control systems. For example, the design of a control-augmentation system to be used in part for weapon delivery must address itself to the effects of aircraft flexibility on weapon delivery accuracy. A reduction in amplitude of flexible body oscillation may be necessary to reduce oscillatory boresight errors. Static boresight errors due to loading in high-g maneuvers should also be considered in estimating delivery accuracy degradation due to flexibility.

Hysteresis. Hysteresis or backlash at any point in the control-augmentation system should be controlled either by antibacklash springs or by other means, at least to the point that limit cycles existing anywhere are imperceptible to the pilot at any flight condition at which weapons may be delivered.

Gun moments. The effect of firing high repetition rate small caliber weapons or large projectiles from the aircraft on the stability of the vehicle should be understood and compensated for in the control system design.

Growth capability. A candidate system concept should be carefully examined for growth capability before selection for design and development. Reference 13 documents how the complexity of a system can escalate as knowledge of aircraft dynamic characteristics are refined and the detail problems of designing flight-critical controls become known.

3.1.2 AFCS Performance requirements. When the following AFCS functions are used, the following specified performance shall be provided. Unless otherwise specified, these requirements apply in smooth air and include sensor error. Except where otherwise specified, a damping ratio (6.6) of at least 0.3 critical shall be provided for nonstructural AFCS controlled mode responses. Specified damping requirements apply only to the response characteristics for perturbations an order of magnitude greater than the allowable residual oscillation.

DISCUSSION

The AFCS performance specified in this Section is intended to include "not-to-exceed" parameters which are felt necessary for proper fleet operation. Pilot relief functions are specified to reduce crew fatigue to a level consistent with mission requirements. Automatic landing and terrain following are specified to extend mission capabilities in applications where the mission warrants the additional complexity. Performance is generally specified with respect to sensor indicated values. In many cases, sensor accuracy is set by manual control considerations. Where performance is not specified with respect to an FCS sensor reference, sensor error must be included in meeting the requirement.

Contrails

The concept of specifying performance to include sensor error may lead to deviation requests where sensors are government furnished and do not permit meeting the stated performance. Where sensors are government furnished, the procuring activity must accept the responsibility for providing sensors of adequate accuracy.

3.1.2.1 Attitude hold (pitch and roll). Attitudes shall be maintained in smooth air with a static accuracy of ± 0.5 degree in pitch attitude (with wings level) and ± 1.0 degree in roll attitude with respect to the reference. RMS attitude deviations shall not exceed 5 degrees in pitch or 10 degrees in roll attitude in turbulence at the intensities specified in 3.1.3.7. When using a flight controller (turn knob) the aircraft shall return to a wings level attitude when the turn control is placed in the detent position. Accuracy requirements shall be achieved and maintained within 3 seconds of mode engagement for a 5 degree attitude disturbance for MIL-F-8785 Class IV aircraft, and within 5 seconds for MIL-F-8785 Classes I, II and III aircraft.

3.1.2.2 Heading hold. In smooth air, heading shall be maintained within a static accuracy of ± 0.5 degree with respect to the reference. In turbulence, RMS deviations shall not exceed 5 degrees in heading at the intensities specified in 3.1.3.7. When using a flight controller, heading hold shall automatically engage as the controller is returned to the detent position.

3.1.2.3 Heading select. The aircraft shall automatically turn through the smallest angle to any heading selected or preselected by the pilot and maintain that heading to the tolerances specified for heading hold. The contractor shall determine a bank angle limit which provides a satisfactory turn rate and precludes impending stall. The heading selector shall have 360 degrees control. The aircraft shall not overshoot the selected heading by more than 1.5 degrees with flaps up or 2.5 degrees with flaps down. The roll rate shall not exceed 10 deg/sec and roll acceleration shall not exceed 5 deg/sec/sec for MIL-F-8785 Classes I, II and III aircraft, or double these values for MIL-F-8785 Class IV aircraft.

DISCUSSION

Attitude hold maneuver limits are not included in this general requirement due to the lack of agreement on maneuver limits. MIL-F-9490C set maneuver limits for the attitude hold function ± 60 degrees in roll, ± 15 degrees in pitch, and ± 7 degrees yaw angle for control stick steering applications. Maneuver limits will normally be specified in the detailed specification or will be established by the contractor for each procurement based on requirements of that procurement.

The accuracy requirement of ± 0.5 degrees for attitude hold modes represents a typical air transport requirement, Reference 13, and state-of-the-art capability. The accuracy requirement in turbulence applies only up to the turbulence amplitude limits specified herein. Attitude hold and other pilot assist AFCS modes will normally be classified as noncritical functions and, as such, the turbulence requirement stated will normally apply only in light turbulence.

Contrails

The 10 degrees bank, 5 degrees pitch angle and the 5 degrees heading limit in turbulence is intended to provide the pilot with a reasonably stable platform during flight in the turbulence environment to which the attitude and heading hold loops will be designed. A system which is easily saturated in turbulence will have trouble meeting these requirements, and should be avoided.

The heading hold static accuracy requirement of 0.5 degree reflects the current state-of-the-art. Reference 13 states typical air transport heading hold requirements, which may be considered in pertinent applications, as follows: when selection of this mode is made while the aircraft is turning, the airplane should return to wings-level at a roll rate not to exceed 6.0 deg/sec, a roll acceleration not to exceed 3.0 deg/sec/sec, and should hold the heading that exists at the time the airplane is within approximately 3 degrees of wings level.

The bank angle limit for Heading Select, to be determined by the contractor, will probably be unique for each new procurement. The requirement to preclude impending stall is meant to apply with normal power settings. This pilot relief mode is not expected to normally result in steep banks or operation near stall.

3.1.2.4 Lateral acceleration and sideslip limits. Except for flight phases using direct side force control, the following performance shall be provided whenever any lateral-directional AFCS function is engaged. Lateral acceleration refers to apparent (measured, sensed) body axis acceleration at the aircraft center of gravity.

3.1.2.4.1 Coordination in steady banked turns. Sideslip angle shall not be greater than 2 degrees and lateral acceleration shall not exceed 0.03g, while at steady bank angles up to the maneuver bank angle limit reached during normal maneuvers with the AFCS engaged. For rotary wing aircraft, only the lateral acceleration limit applies.

3.1.2.4.2 Lateral acceleration limits, rolling. Body axis lateral acceleration at the cg shall not exceed $\pm 0.1g$ for aircraft with roll rate capability up to 30 deg/sec, $\pm 0.2g$ for aircraft with roll rate capability of 30 to 90 deg/sec, or $\pm 0.5g$ for aircraft with roll rates over 90 deg/sec. These limits shall be satisfied for aircraft in essentially constant altitude flight while rolling smoothly from one side to the other at bank rates up to the maximum obtainable through AFCS modes.

3.1.2.4.3 Coordination in straight and level flight. The accuracy while the aircraft is in straight and level flight shall be maintained within a sideslip angle of ± 1 degree and a lateral acceleration of $\pm 0.02g$ at the cg, whichever is lower. For rotary wing aircraft, only the lateral acceleration limit applies.

3.1.2.5 Altitude hold. Engagement of the altitude hold function at rates of climb or descent less than 2000 fpm shall select the existing indicated barometric altitude and control the aircraft to this altitude as a reference. The resulting normal acceleration shall not exceed 0.2g incremental for MIL-F-8785 Classes I, II and III aircraft, or 0.5g incremental for MIL-F-8785

Contrails

Class IV aircraft. For engagement at rates above 2000 feet per minute the AFCS shall not cause any unsafe maneuvers. Within the aircraft thrust-drag capability and at steady bank angles, the mode shall provide control accuracies shown in Table I.

TABLE I MINIMUM ACCEPTABLE CONTROL ACCURACY

BANK ANGLE (DEG.) ALT. (FT.)	0 - 1	1 - 30	30 - 60
55,000 to 80,000	$\pm 0.1\%$ at 55,000 varying linearly to $\pm 0.2\%$ at 80,000	± 60 ft. or $\pm 0.3\%$ whichever is larger	± 90 ft. or $\pm 0.4\%$ whichever is larger
30,000 to 55,000	$\pm 0.1\%$		
0 to 30,000	± 30 ft.		

These accuracy requirements apply for airspeeds up to Mach 1.0. Double these values are permitted above Mach 1.0 and triple these values apply above Mach 2.0. Following engagement or perturbation of this mode at 2000 feet per minute or less, the specified accuracy shall be achieved within 30 seconds. Any periodic residual oscillation within these limits shall have a period of at least 20 seconds.

3.1.2.6 Mach hold. The Mach number existing at the engagement of Mach hold shall be the reference. After engagement and stabilization on Mach hold, the AFCS shall maintain indicated Mach number and the error shall not exceed ± 0.01 Mach or ± 2 percent of indicated Mach, whichever is larger, with respect to the reference. Any periodic oscillation within these limits shall have a period of at least 20 seconds. The contractor shall establish a mode response or maximum time to capture requirement which is suitable for the mission phase.

3.1.2.7 Airspeed hold. The airspeed existing at the engagement of airspeed hold shall be the reference. Indicated airspeed shall be maintained within \pm knots or ± 2 percent, whichever is greater, of the reference airspeed. Any periodic oscillation within this limit shall have a period of at least 20 seconds. The contractor shall establish a mode response or maximum time to capture requirement which is suitable for the mission phase.

DISCUSSION

Altitude hold requirements include acceleration amplitude limits. For reference, commercial transports normally limit normal acceleration for altitude hold engagement to 0.15g incremental. Residual oscillations are permitted within the amplitude limits specified herein. Response requirements are specified similar to those used in a recent commercial transport AFCS development and in a recent USAF fighter AFCS development.

Provisions should normally be included to disengage altitude hold at a given angle of attack. The F-111, for example, can get in a situation where more thrust is required than is available and the altitude hold feature will continue to increase angle of attack until stall.

In addition to the altitude hold accuracies specified for steady bank angles, performance in maneuvering flight should also be considered by the designer. Also the designer should not overlook the need to control altitude excursions during airspeed changes. Altitude hold deviations during normal airplane configuration changes should also be considered.

Airspeed hold requirements are specified which are similar to those used in commercial applications. Minimum damping is specified in 3.1.2 for the transient response following a disturbance; however, there is no damping requirement for small oscillations within the performance tolerance bands. The contractor is required to establish a maximum time for recapture of the commanded airspeed or Mach following a disturbance which is suitable for the mission phase. This value will be based on the control characteristics of the individual aircraft being developed and should be included in the FCS Specification (4.4.2).

Altitude hold and airspeed hold tolerance increase with airspeed. YF-12 experience has shown that tolerances may need to be relaxed for flight near Mach 3.0. Otherwise, the tight loops needed to hold Mach may result in large altitude variations and degraded ride qualities.

The sideslip angle limits specified herein are not applicable for helicopters. Helicopters normally fly at varying small sideslip angles in trimmed level flight with zero lateral acceleration because of the variation of the inplane rotor forces as a function of flight condition.

3.1.2.8 Automatic navigation.

3.1.2.8.1 VOR/TACAN. When preconditions for radial capture are satisfied the AFCS shall cause the aircraft to maneuver to acquire the radial beam center. Maximum roll rate and attitude commands shall be limited to provide a smooth capture and subsequent tracking of the radial. The following performance requirements for VOR are stated in terms of crosstrack error (feet) and radial error (expressed in μ amps; 1 degree = 15 μ amps) to provide for systems using either ARINC 547 or 579 VOR receivers. For ARINC 547 receivers only the radial error applies. Crosstrack error applied to the ARINC 579 receiver operating in the primary mode (co-located VOR/DME), and radial error applies in the reversionary mode (DME inoperative or not available).

Contrails

3.1.2.8.1.1 VOR capture and tracking. Overshoot shall not exceed 5,800 feet (20 μ a) beyond the desired ground track line in a no-wind condition for captures 50 miles or more from the station with intercept angles up to 45 degrees. Following capture at 50 miles or more, the aircraft shall remain within an average of 5,800 feet (20 μ a) from the VOR radial beam center, with this error allowance decreasing proportional to the distance from the VOR station. Average tracking error shall be measured over a 5 minute period between 50 and 10 miles from the station or averaged over the nominal aircraft flight time between the same distance limits, whichever time is shorter.

3.1.2.8.1.2 TACAN capture and tracking. Overshoot shall not exceed 6,300 feet beyond the desired ground track line in a no-wind condition for captures 120 miles or more from the station with intercept angles up to 30 degrees. The required 0.3 damping ratio shall be exhibited for continuous tracking between 120 miles and 20 miles from the station.

3.1.2.8.1.3 Overstation. The VOR/TACAN mode shall include automatic means for maintaining the aircraft within ± 1 degree of aircraft heading or ground track existing at the inbound edge of the VOR zone of confusion (ZOC). During overflight of the ZOC, adjustment of the preset course heading or its equivalent shall cause the roll AFCS to maneuver the aircraft to capture the appropriate outbound radial upon exiting from the ZOC. The VOR/TACAN capture maneuvering limits may be reinstated during overstation operation.

3.1.2.9 Automatic instrument low approach system. The approach mode of the AFCS shall respond to localizer signals for lateral guidance and glide slope signals for vertical guidance. The system shall be designed to automatically steer the aircraft to a minimum decision height of 100 feet during ICAO Category II weather minimums. The system shall provide timely warning to permit the pilot to complete the landing if runway visual contact is established or to safely execute a go-around following any single failure or combination of failures not shown to be extremely remote as defined in 6.6. The system shall comply with the tracking requirements of 3.1.2.9.1 through 3.1.2.9.3 for probable combinations of headwinds to 25 knots, tailwinds to 10 knots, and crosswinds to 15 knots, with the probability of occurrence of such winds and associated turbulence and wind shears as defined in 3.1.3.7.3.

3.1.2.9.1 Localizer mode. The AFCS shall cause the aircraft to maneuver to acquire the localizer beam. Heading or roll rate and attitude commands shall be limited to provide a smooth capture and subsequent tracking of the localizer beam. Overshoot shall not exceed 0.5 degrees (37.5 μ a) radial error from localizer beam center for captures with initial intercept angles of 45 degrees at 8 miles from runway threshold and increasing linearly to 60 degrees at 18 miles from runway threshold in a no wind condition. During localizer capture the system shall exhibit a damping ratio of at least 0.1 within the noted capture ranges, including the effects of system nonlinearities. The system shall be considered to be tracking whenever the following conditions are satisfied: localizer beam error is 1 degree (75 μ a) or less, localizer beam rate is 0.025 deg/sec (2 μ a/sec) or less, and roll attitude is 5 degrees or less. During beam tracking the system shall exhibit a damping ratio of 0.2 or greater at a distance of 40,000 feet from the localizer

Contrails

transmitter. The AFCS shall maintain the aircraft 2σ position within 0.33 degrees (25μ a) of localizer beam center whenever the aircraft is between (1) 40,000 feet horizontal distance from the localizer transmitter, and (2) the point where 100 feet above the ground is reached; these criteria shall be based on a Category II localizer ground installation and 10,000 foot runway as defined by ICAO Annex 10.

3.1.2.9.2 Glide slope mode. The pitch AFCS shall cause the aircraft to maneuver to acquire the glide slope beam. Neither the position of the aircraft above or below the glide slope nor vertical speed of the aircraft at time of mode selection shall be incorporated as a precondition for mode engagement. When preconditions are satisfied, overshoot shall not exceed 0.16 degrees (35μ a) of radial error from glide slope beam center when capturing from below the beam in level flight at an altitude greater than 800 feet above the glide slope transmitter datum altitude in a no-wind condition. The system shall exhibit a damping ratio of 0.085 or greater subsequent to the first overshoot for the conditions defined. On a Category II ILS ground facility (including 10,000 foot runway) as defined in ICAO Annex 10, the pitch AFCS shall maintain the aircraft glide slope antenna 2σ opposition within 0.16 degrees (35μ a) of beam center or within 12 feet of beam center, whichever is greater, between the altitudes of 700 feet and 100 feet above the glide slope transmitter datum.

3.1.2.9.3 Go-around mode. The automatic go-around mode shall be manually engaged only. The AFCS shall be designed such that no single failure, or combination of failures not extremely remote, will cause the aircraft to maneuver to increase the rate of descent upon engaging the go-around mode. If the go-around mode is designed for concurrent operation with other automatic control systems, a single switch location or pilot action shall engage all systems into the appropriate mode for go-around. Should one or any combination of concurrently operating automatic control systems be inoperative at the time of AFCS go-around mode engagement, the AFCS shall comply with the performance requirements based on normal go-around procedures including manual management of thrust, flaps, and landing gear.

3.1.2.9.3.1 Pitch AFCS go-around. The pitch AFCS shall cause the aircraft to smoothly rotate sufficiently to establish a positive rate of climb such that the aircraft will not intersect the obstacle clearance planes defined in FAA Advisory Circular 120-29 more often than 1 in 10^6 events for the wind conditions defined in 3.1.2.9, and including high altitude, hot day conditions as defined by the procuring activity. In the event of inadvertent loss of an engine just prior to or during automatic go-around, the system shall not cause the aircraft to approach stall within 30 seconds of mode engagement, based on design approach speed. If operating procedures require the mode to be disengaged upon inadvertent loss of an engine, a timely warning shall be provided for the pilot to initiate the disengage procedure. Disengagement under this condition shall be accomplished manually.

3.1.2.9.3.2 Lateral-heading AFCS go-around performance standards. The lateral-heading AFCS shall maintain the aircraft 4σ position within the lateral boundaries of the obstacle clearance planes during wind conditions as specified in 3.1.2.9. This capability shall be maintained in the event of the most critical engine failure just prior to or during automatic go-around.

If normal procedure is to disengage the go-around mode after inadvertent loss of one engine, under the wind conditions cited a pilot of normal skill shall be able to recover airplane heading such that intersection with the obstacle clearance planes will occur no more than 1 in 10^6 events during recovery.

3.1.2.9.3.3 Minimum Go-around altitude. A minimum altitude for engaging automatic go-around shall be established such that the probability of incurring structural damage to the landing gear, wing tips, or control surface is extremely remote. The minimum altitude shall include normal performance under the wind conditions specified in 3.1.2.9 and the probability of inadvertent loss of an engine at any time within 12 seconds preceding mode engagement.

DISCUSSION

The performance requirements established for VOR/TACAN operation are based on current aviation industry practices and represent the cumulative effect of evolution of airborne equipment capability and pilot acceptability.

The overstation mode requirements for VOR and TACAN defined in 3.1.8.1.3 include provisions for resetting the beam capture logic. One of the more common complaints from military and commercial pilots relates to limited capture performance for the outboard radial. Generally these complaints have occurred because the AFCS remains in a tracking mode during station overflight. Consequently, outboard captures are hampered by extremely limited bank angles, etc., designed to ensure good tracking performance. Future configurations should provide for more favorable outbound capture performance by development of more comprehensive control laws or providing capture logic reset as a function of station overflight.

With the addition of inertial navigation systems and area navigation systems to the airborne computer installation, substantial additional computational capability is established external to the traditional autopilot computers. Thus, the location of specific control laws such as VOR, localizer, and glide slope modes have become more flexible. Depending upon the specific aircraft configuration, it may be practical to process the control information for these modes externally to the autopilot computers and to provide steering command signals to the AFCS in lieu of raw data.

Specific requirements for Inertial Navigation, Area Navigation, or Vertical Navigation control are not included in this specification since these requirements will depend on the aircraft mission. Normally these requirements will be included in the procurement detailed specification, when such functions are required.

Requirements for a Microwave Landing System (MLS) approach mode have not been included because of the lack of definitive information on MLS ground facilities and contingent approach procedures.

The main point of the Automatic Instrument Low Approach System requirement is to emphasize that the purpose of an approach coupler is to position the aircraft accurately at a point from which a landing may be safely completed. Critical failures in the system must be annunciated quickly enough that the crew may take effective corrective action.

The localizer mode and approach coupler mode requirements include the environmental conditions under which the requirements shall be met. Minimum damping is specified; however, these values will normally be exceeded since the operation in turbulence requirements of 3.1.3.7 should dictate damping levels.

The environmental conditions comprise probable combinations of head, tail and crosswinds determined from statistical combinations (i.e., mutual convolution) of the wind distributions as illustrated in Figure 2.

If certain other automatic functions must be operable to meet the requirements, e.g., stability augmentation systems or autothrottles, this must be clearly stated in the FCS Analysis Report.

The localizer mode and approach coupler mode requirements include the environmental conditions under which the requirements shall be met. If certain other automatic functions must be operable to meet the requirements, e.g., stability augmentation systems or autothrottles, this must be clearly stated in the FCS Analysis Report.

3.1.2.10 All weather landing system. The following all weather landing system requirements pertain to the latter stages of the approach; i.e., that portion of the approach below the decision height or the alert height, as defined in 6.6. All weather landing system shall comply with the following landing accuracies:

a. Longitudinal dispersion of the main landing gear touchdown point shall not exceed 1500 feet with a 2-sigma probability, with a mean touchdown point beyond the glideslope intersection with the runway. The 1500 foot dispersion need not be symmetrically located about the nominal touchdown point. The aircraft sink rate at touchdown shall not exceed the structural limit of the landing gear except as an extremely remote (6.6) occurrence.

b. The lateral dispersion of the aircraft centerline at the main landing gear at touchdown shall not exceed 27 feet on either side of the runway centerline with a 2-sigma probability. The roll out guidance system (normally used during ICAO Category IIIB or IIIC visibility conditions) shall cause the aircraft to track parallel to or convergent with the centerline of the runway.

c. The systems shall meet these requirements considering reasonable combinations of head winds to 25 knots, tail winds to 10 knots, and crosswinds to 15 knots, according to the probability of encountering these winds and their associated turbulence as specified in 3.1.3.7.3, along with expected variations in aircraft configurations as specified in 3.1.2.10.1, and expected variations in ground facility performance as specified in 3.1.2.10.2.

3.1.2.10.1 All weather landing performance standards - variations of aircraft and airborne equipment configurations. All weather landing performance requirements shall be met while including the effects on performance of the following aircraft and airborne equipment variations expected to occur in normal service.

- a. Landing weight and center of gravity variations.
- b. Landing flap setting variations.
- c. Aircraft approach speed variations.
- d. Glide slope and localizer airborne receiver centering errors.
- e. AFCS all weather landing system sensor, computer and servoactuator tolerances.
- f. Performance tolerances of automatic control systems operating concurrently with the AFCS all weather landing system; e.g., stability augmentation systems, load alleviation systems.

3.1.2.10.2 Performance standards - ground based equipment variations. Proof of compliance with performance requirements for All Weather Landing systems shall include the effects of expected variation in type and quality of the ground based equipment. ILS beam structure, associated tolerances and alignment errors, monitoring, touchdown zone lighting, terrain clearances, and controlled or critical taxi zones shall be considered to meet the requirements for Categories II or III operations as defined by ICAO Annex 10.

DISCUSSION

All weather landing refers to those approaches conducted in limited visibility conditions such as those defined by ICAO as Category II or Category III visibility conditions. Performance requirements for the initial stages of the approach, i.e., from ILS capture to the decision height, are defined in 3.1.2.9.1, Localizer Mode, and 3.1.2.9.2, Glide Slope Mode. Performance requirements for the remainder of the approach, touchdown, and roll out are defined in 3.1.2.10.

The requirements are intended to apply to conventional takeoff and land aircraft. Dispersion requirements, for example, may be more stringent for STOL aircraft.

Because of the limitations of pilot perception and aircraft maneuverability under the combined influence of limited visibility and operations at extremely low altitudes, the primary emphasis of design for all weather landing systems is in terms of assuring safety of operation of the system. Although all weather landing state-of-the-art has been generally established through government and military programs, codification of all weather landing requirements has occurred to a greater degree in civil programs because of their relationship with and obligations to various regulatory agencies around the world. Thus it is rational for MIL-F-9490 to draw upon the civil codifying experience for not only that which is presently existing, but to include trends which are obvious to the industry as additional experience with various all weather landing systems' configurations is accrued. For this reason, the requirements given herein are based on the performance accuracies, reliability requirements, and methods of showing compliance with the requirements as defined in FAA advisory circulars 20-57A, 120-28A, and 120-29, and in CAA paper number 367. See also the further discussion of the closely related requirements on all weather landing system reliability and hazard analyses, 3.1.7.1.

Contrails

In order to provide a baseline of normal performance to substantiate system safety of operation during "no-fault" conditions, a statistical analyses of touchdown performance must be provided which includes the expected variation of performance-affecting parameters which are common to all aircraft. Unusual modes of operation, or parameters which are peculiar to certain aircraft are not included in the list of parameters provided in 3.1.2.10.1 and 3.1.2.10.2. It is expected that these will be specified by the responsible procurement activity.

Normal performance (boundary conditions) have not been defined here. These latter conditions must be established through analysis of associated specific risks (as defined in 3.1.7.1.2). This analysis may lead to limiting requirements such as those defined in FAA advisory circular 20-57A.

A statistical model must be derived to show the probability distribution of each parameter considered in the analysis. The dispersions due to each of these parameters must be calculated and mutually convolved to provide a cumulative dispersion using the expression:

$$P(y > Y) = \int_{-\infty}^{\infty} \int_{-\infty}^{\infty} \dots \int_{-\infty}^{\infty} P(y > Y/d_1, d_2, \dots, d_n) dd_1, dd_2, \dots, dd_n$$

$P(y > Y)$ = probability that dispersion y exceeds the given value Y

d_1, d_2, \dots, d_n are the disturbances

A discussion of the calculations involved is contained in References 14, 15, 16 and 17.

3.1.2.11 Flight load fatigue alleviation. A fatigue alleviation control system may be used where it is advantageous to the weapon system. The fatigue alleviation system shall comply with applicable requirements of MIL-A-8866 in addition to the requirements of this specification.

DISCUSSION

The performance requirements for fatigue alleviation systems are included in the structures specifications. As the name implies, the primary purpose of these systems is to reduce fatigue damage rate at critical locations and thereby extend airframe fatigue life. The B-52G and H fleet currently includes a system which provides both a stability augmentation function and a fatigue alleviation function, References 18 and 19.

Where a Structural Mode Control System is implemented as a noncritical FCS, the interaction between the structural system and essential or flight phase essential manual FCS augmentation functions should be minimized. Separation is normally needed by bandpass or frequency of operation to avoid changes in flying qualities with and without the Structural Mode Control System. This separation may be attained through use of bandpass filters, washout networks or multiple sensors.

Separation may also be needed in system implementation to prevent failure propagation from structural systems into a system of higher criticality. Use of dedicated surfaces should always be considered to obtain failure immunity. Generally, the control surfaces used for manual control

are not properly located to obtain best structural mode control performance and an increment in performance may also be obtained through use of properly located and dedicated control surfaces.

Fatigue alleviation systems normally operate at relatively high frequencies and at relatively low forces. When control surfaces are used for Fatigue Alleviation, which are also required to provide the relatively high forces needed for manual control, low control surface amplitudes result. Consequently the effects of hysteresis, backlash and similar nonlinearities are more important and require a more detailed nonlinear analysis than is needed for automatic FCS operating at lower frequencies and higher amplitudes. Where practical, force and moment producers should always be selected to best provide the functions needed. Use of properly located and sized control surfaces for Structural Mode Control will eliminate problems of this type.

As part of a fatigue alleviation synthesis, some consideration should be given to the effect on loads at all airframe locations and not just at the fatigue critical location. Among loading sources normally considered when evaluating the performance of fatigue alleviation systems are: flight in turbulence, ground-air-ground cycles and maneuver loading.

3.1.2.12 Ride smoothing. With the Ride Smoothing AFCS and other FCS in Operational State I, the following short term and applicable long term vertical or lateral axis ride discomfort index levels shall not be exceeded at any crew station during flight in the turbulence level specified in Table II.

**TABLE II
RIDE DISCOMFORT INDEX LIMITS**

Ride Discomfort Index, D_i		Flight Phase Duration (Exposure Time)	Probability of Exceeding RMS Turbulence Intensity
Long Term Requirement	0.10	Over 3 Hours	0.20
	0.13	From 1.5 to 3 Hours	0.20
	0.20	From 0.5 to 1.5 Hours	0.20
Short Term Requirement	0.28	Less than 0.5 Hour	0.01

The requirements apply, separately, to each of the vertical and lateral axes. For the lateral axis requirement only lateral gusts apply and for vertical acceleration only vertical gusts apply. Effects of attitude hold or other pertinent AFCS modes shall be included where used. This requirement normally applies only where a Ride Smoothing AFCS is specified by the procuring activity. However, where ride smoothing is not specified and other AFCS modes degrade ride quality, the resulting ride shall not degrade to below the levels specified.

3.1.2.12.1 Ride discomfort index. Ride discomfort index is defined as:

$$D_i = \left[\int_{0.1}^{f_t} |W(f)|^2 |T_{cs}(f)|^2 \phi_u(f) df \right]^{1/2}$$

- D_i = Ride Discomfort Index, (vertical or lateral)
- $W(f)$ = Acceleration weighting function (vertical or lateral) 1/g
- $T_{cs}(f)$ = Transmissibility, at crew station, g/ft/sec
- $\phi_u(f)$ = Von Karman gust power spectral density of intensity specified in 3.1.2.12 and form specified in MIL-F-8785
- f = Frequency, Hz
- f_t = Truncation frequency (frequency beyond which aeroelastic responses are no longer significant in turbulence) (1)

Acceleration weighting functions are defined for vertical and lateral acceleration by figure 1. Probability of exceedance versus turbulence intensity is specified in 3.1.3.7.

DISCUSSION

When used, ride smoothing systems are required to provide a degree of ride quality as defined by the Ride Discomfort Index. Ride requirements are stated in terms of probabilities, since the ride discomfort addressed by this requirement is generated by random turbulence. The exceedance probabilities and corresponding Ride Discomfort Index values specified are based on the recommendations of References 20 and 21. Generally these requirements should provide ride quality equal to or better than that existing in currently operating aircraft within the USAF inventory.

The ride requirement for the basic aircraft, without a ride smoothing system, is included in MIL-A-8892. This requirement currently limits any single frequency vibration to ± 0.1 g, zero to peak, at frequencies below 22 Hertz. This MIL-A-8892 requirement is currently being considered for revision within the AFFDL to include coverage similar to that included here. Consideration of multiple frequency aeroelastic responses and human sensitivity weighting factors is considered mandatory for evaluation of ride in turbulence.

There is disagreement in the literature on the proper approach for evaluating combined axis accelerations. Reference 20 recommends a method for evaluating combined axis accelerations based on USAF experience. Reference 22, the ISO standard, recommends that accelerations in separate axes be considered separately; and Reference 23, a commercial aircraft study, recommended another method for combined axis acceleration evaluation.

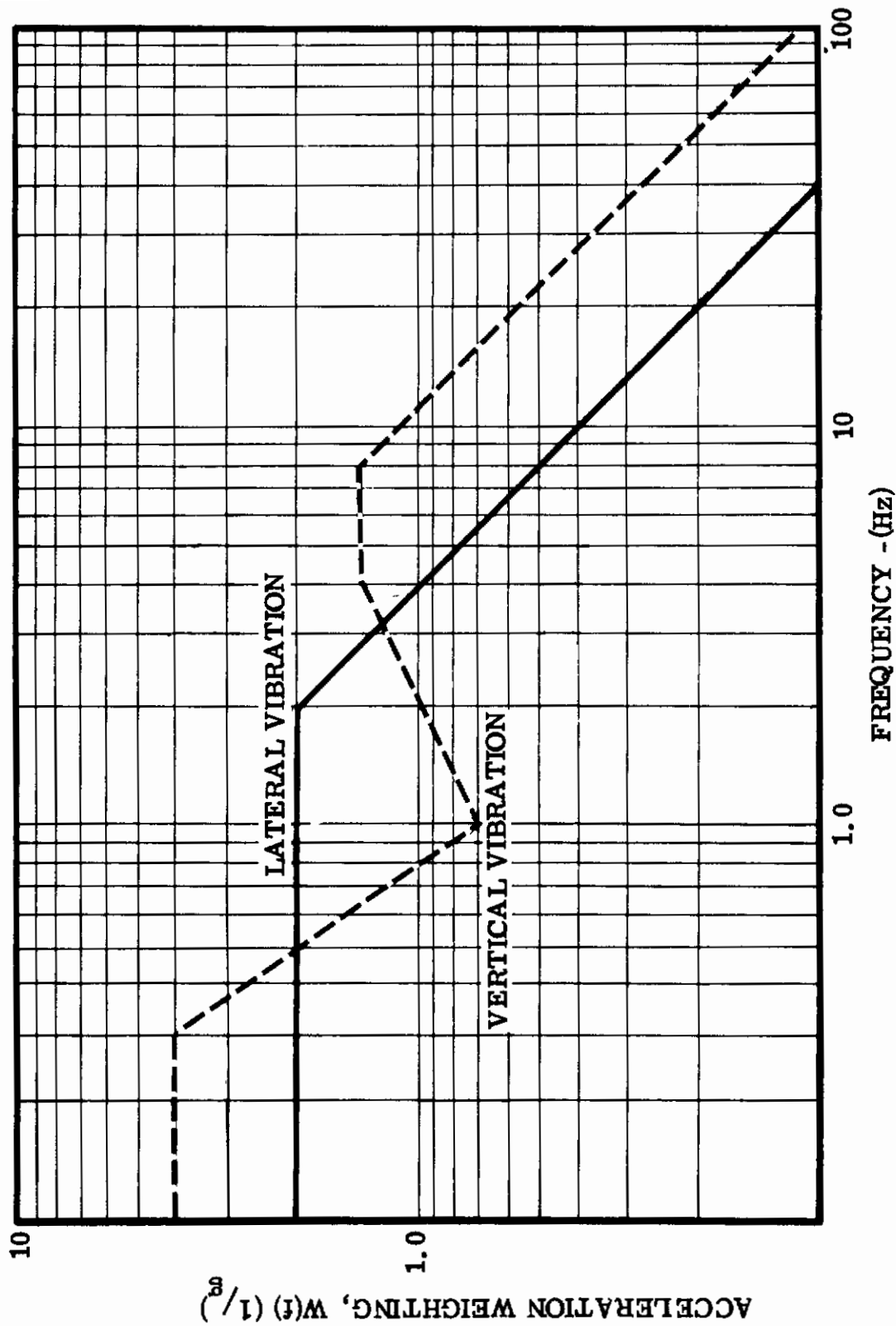

Figure 1. Acceleration weighing functions

Contrails

Due to the lack of agreement on method and limited test data available on combined axis accelerations, this requirement follows the ISO recommendation and places requirements only on vertical and lateral axis accelerations, separately. The reader should note that vertical ride discomfort is to be evaluated due to vertical axis turbulence only and lateral ride evaluated due to lateral turbulence only. No requirement is specified for roll gusts or longitudinal gusts, although for some STOL applications longitudinal gusts should be considered.

The turbulence intensities to be used are determined by the exceedance probabilities specified for Ride Discomfort Index. Generally, the system is required to reduce ride discomfort to the levels specified while flying in turbulence with a cumulative exceedance probability equal to or less than the probability specified. System nonlinearities must be considered. System deadzone and other nonlinearities must not be so large that ride discomfort exceeds the 0.10 or other pertinent long term limits in light turbulence. System saturation must not be so severe in turbulence at the 0.01 exceedance level that the 0.28 ride discomfort limit is exceeded. The reliability requirements for implementing a ride smoothing system are specified, in terms of mission accomplishment probability, in 3.1.6. The reader should note that cumulative exceedance probabilities for turbulence are stated in terms of stationary probabilities rather than the nonstationary probabilities used in reliability work.

Turbulence exceedance probabilities are tabulated in Table V of 3.1.3.7.

A stationary probability or cumulative probability of exceedance for turbulence encounter means that at a randomly selected time during flight, the probability of being in turbulence at or above the stated intensity is of a given value. This does not define the probability of exceeding a given level of turbulence during a given flight or flight segment. On a fleet lifetime basis, this probability can be interpreted as the portion of total flight time to be spent above the stated intensity. Since the statistics upon which these probabilities are based were measured over extended operating times, the temptation to convert these values to hours/hour or hours per individual flight should be resisted.

The levels of ride discomfort specified are based on short term tolerance and long term tolerance. Data from References 20, 22 and 24, indicate that below a Ride Discomfort Index of 0.07, little or no degradation in crew performance or passenger comfort is expected. Above a Ride Discomfort Index of 0.28 the USAF references indicate crew action must be initiated to reduce the acceleration environment by changing flight path, altitude and/or air-speed. Figure 2D illustrates unpublished data from a commercial airplane moving base simulator study in terms of incremental pilot ratings (Cooper scale) due to accelerations which also indicate a limit near 0.28 for an incremental pilot rating of 3. (Note that a satisfactory rating of 3.5 in calm air plus an incremental rating of 3 in turbulence yields a total rating of 6.5.)

- NOTES: 1. UNPUBLISHED BOEING DATA FOR
COMMERCIAL AIRPLANES
2. DATA OBTAINED FROM MOVING
BASE SIMULATOR STUDY

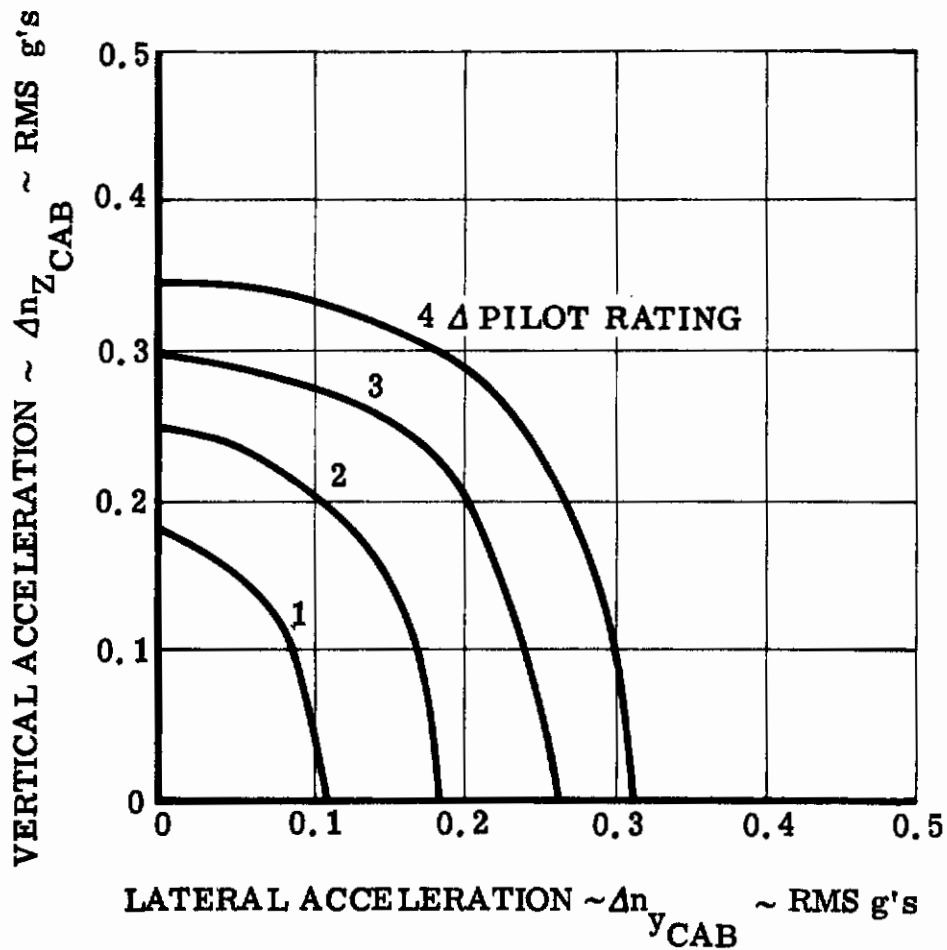

Figure 2D. Effect of combined acceleration on pilot rating

Contrails

The only known production ride smoothing system designed to date, the B-1 system, used a vertical long term index near 0.10. The lateral B-1 requirement was more stringent. Commercial feasibility studies have used much more conservative design goals. Reference 25, for example, used an unweighted index of 0.03 in 0.01 turbulence. This is equivalent to an unweighted index of 0.015 in 0.20 turbulence at low level and is roughly a factor of 10 more stringent than the MIL-F-9490D criterion. The procuring activity, of course, may redefine the required values of the ride discomfort index to be used for specific procurements, based on unique mission requirements.

The B-52 is known for its marginal ride during low level penetrations. When compared to this long term criteria (3 hrs. = 0.10) the B-52 exceeds the criterion for medium and light gross weights and satisfies the criterion for heavier gross weights. Thus, for the initial penetration flight phase the B-52 ride is acceptable.

For later phases the ride is unacceptable, if the remaining low level flight phase exceeds three hours.

The Figure 1 acceleration weighting functions are based on the MIL-STD-1472 human sensitivity curves, Reference 22, as extrapolated to lower frequencies by Reference 26. The extrapolations below 1.0 Hertz, especially for lateral vibration, are supported by a minimum of data. However, the values defined represent the best current consensus of experts within the 6750th Aerospace Medical Research Laboratory and reflect the current U.S. recommendation to the International Organization for Standardization for human exposure to vibration from 0.1 to 1.0 Hertz. The weighting functions defined are truncated at 0.1 Hertz and at high frequencies.

The reason for weighting function truncation is the limitations of the test equipment used to generate data upon which these curves are based. Moving base simulators can be used to simulate aircraft at low frequencies; however, the data obtained below 0.1 to 0.2 Hertz is of questionable value since continuous oscillations at these frequencies do not normally occur in flight. In many cases, the pilot or AFCS will control low frequency motions, effectively smoothing these oscillations and reducing the truncation error resulting from this approach. (See Reference 27.) Note that attitude hold or other pertinent modes are to be simulated to satisfy this requirement. These modes should approximate pilot or AFCS suppression of low frequency responses. Truncation at higher frequencies is permitted since the gust spectrum has very little power beyond 30 Hertz. Since structural models seldom extend to 30 Hertz, in practice integration is normally stopped near the frequency of the highest aeroelastic mode modeled. The requirement is to include significant effects to the truncation frequency. Due to gust filter roll off, integration beyond 15 Hertz seldom affects the integral value significantly.

The intent of this requirement is to specify the ride experienced by the crew. Soft seats or other isolation techniques used should be considered in meeting this requirement. Care must be taken that relative motion between the crew member and his controls and instruments, resulting from isolation techniques, does not degrade crew performance. Visual problems, for example, can be aggravated by relative motion.

Contrails

There are several current sources of literature available on ride smoothing systems. Reference 28 describes development of the B-1 ride smoothing system which was synthesized using the ILAF concept. References 29 through 33 describe the development of the ILAF concept. Reference 34 describes a study of model suppression on the YF-12A airplane.

3.1.2.13 Active flutter suppression. An active flutter suppression control system may be used where it is advantageous to the weapon system. The flutter suppression control system shall conform to the applicable requirements of MIL-A-8870 in addition to the requirements of this specification.

3.1.2.14 Gust and maneuver load alleviation. An active gust and maneuver load alleviation control system may be used where it is advantageous to the weapon system. The active load alleviation control system shall conform to the applicable requirements of MIL-A-8861 in addition to the requirements of this specification.

DISCUSSION

Active Flutter Suppression is an emerging technology and, as such, few specific requirements have been suggested for such systems. References 35-43 record some of the recent development in flutter suppression.

Gust and maneuver load systems are also currently being developed. Examples are the B-52 CCV program, Reference 44, and the C-5A Structural Improvement program. The L-1011 also relied on the yaw damper to reduce design loads. (See Reference 27.)

3.1.2.15 Automatic terrain following. Performance requirements shall be as specified by the procuring activity.

DISCUSSION

Although the concept of automatic terrain following is well founded, the methodology of specifying performance is, as yet, unproven. Reference 45 provides a discussion of recommended criteria for the design of Manual and Automatic Terrain Following Systems. This document describes recent Terrain Following literature and the rationale used to establish terrain following requirements. Criteria and design constraints are provided in the inter-related areas of safety performance, reliability, stability, vulnerability, structural fatigue, ride comfort and costs.

3.1.2.16 Control stick (or wheel) steering. The pilot shall retain full capability to maneuver the airplane within the applicable control force and maneuver limits of MIL-F-8785 or MIL-F-83300. Automatic disengagement of the AFCS with reversion to manual control is permitted in meeting this requirement.

DISCUSSION

Control wheel (or stick) steering relies on the use of the control wheel and/or column to introduce the pilot's manual inputs into the system when the AFCS is engaged and controlling the aircraft. Many different types of steering systems exist and may be implemented in the future. Two basic types include the proportional type and the disconnect type.

Contrails

Two types of proportional type steering systems are "power steering" and "controlled reference" systems. These systems allow the AFCS to react in a proportional manner to pilot induced force on the control wheel/stick.

The "power steering" type system merely provides power boost and, during the maneuver, there is no AFCS-provided stabilization.

The "controlled Reference" steering system is the most sophisticated of the various steering systems. The AFCS remains engaged during maneuvers and provides whatever stabilization has been selected. The wheel or stick force sensor provides a bias as a function of pilot applied manual control force to modify the stabilization of the AFCS. The controlled parameter is normally airplane attitude; however, functions such as vertical speed, flight path angle, Mach number or turn rate may also be implemented as the controlled parameter. The datum for these references can be slewed as a function of force applied to the wheel/stick.

The disconnect type steering systems merely disconnect the AFCS temporarily during a pilot commanded maneuver and re-engages following completion. Force switches may be used to control disconnect and re-engage logic.

The intent of this requirement is to ensure that the pilot retains full maneuver capability. The disconnect type systems attain this capability by temporarily disengaging the AFCS and relying on the MFCS. The "power steering" and "controlled reference" type system may also be designed to automatically disengage the AFCS prior to reaching design maneuver limits. For example, the B-52 includes a "g limiter" which restricts the pilot to less than design g's through the steering system. However, design maneuvers can be obtained by increasing control forces, such that the AFCS automatically reverts to manual control and design maneuvers can be obtained within reasonable control force levels. The B-52 steering system is designed to minimize the transients resulting from this reversion to manual control.

This requirement also includes consideration of stick force/g. With the steering system functioning, stick force/g must remain within the range of values cited in the flying quality specifications.

3.1.3 General FCS design. Flight control systems shall be as simple, direct, and foolproof as possible, consistent with overall system requirements.

3.1.3.1 Redundancy. The contractor shall determine the redundancy approaches and levels required to satisfy the requirements of this specification.

DISCUSSION

Redundancy may be needed to satisfy the reliability, invulnerability, failure immunity or other requirements of this specification. Recent fleet histories have shown that even single thread mechanical flight control can provide high reliability and failure immunity. However, mechanical redundancy, electrical redundancy and redundancy obtained through mixing mechanical and electrical controls is often used to obtain improved reliability, invulnerability and failure immunity characteristics. Use of dissimilar parts is a preferred approach for obtaining viable redundancy.

Contrails

For electrical flight controls, redundancy is easily obtained and is commonly used to obtain single and dual fail operate systems. Table ID illustrates minimum redundancy levels for the corresponding controls.

TABLE ID
MINIMUM REDUNDANCY LEVELS FOR NONMECHANICAL IMPLEMENTATIONS

FCS CRITICALITY	MINIMUM REDUNDANCY
Essential	Fail-Operational
Flight Phase Essential	Fail-Passive
Noncritical	Fail-Safe

In practice, these redundancy levels are normally exceeded by one level for the flight phase essential and essential controls due to reliability, flight safety or other considerations for the particular implementation.

3.1.3.2 Failure immunity and safety. Within the permissible flight envelope, no single failure or failure combination, which is not extremely remote, in the FCS or related subsystems shall result in any of the following effects before a pilot or safety device can be expected to take effective corrective action. For this specification, extremely remote is defined as numerically equal to the maximum aircraft loss rate due to relevant FCS material failures specified in 3.1.7.

a. Flutter, divergence, or other aeroelastic instabilities within the permissible flight envelope of the aircraft, or a structural damping coefficient for any critical flutter mode below the fail-safe stability limit of MIL-A-8870.

b. Uncontrollable motions of the aircraft or maneuvers which exceed limit airframe loads.

c. Inability to safely land the aircraft.

d. Any asymmetric, unsynchronized, unusual operation or lack of operation of flight controls that results in worse than FCS Operational State III.

e. Exceedance of the permissible flight envelope or inability to return to the service flight envelope.

DISCUSSION

The intent of this requirement is to insure that no failure(s), not extremely remote, can result in an inflight hazard. For noncritical controls the pilot may be required to detect and counteract failures by either deactivating the controls or the failed portion thereof, or by overriding. When this occurs, use of the controls must not require exceptional pilot skill or strength, and should allow use of the controls in the normal sense during override.

Controls

This requirement does not absolutely require redundancy. Recent fleet history, References 46 and 47, shows that single thread mechanical controls can provide failure immunity with high reliability. However, as control technology evolves the trend is toward electrical implementations with multiple redundancy. In each procurement, the procuring activity will specify the numerical probability associated with the term "extremely remote" (See definition in 6.6) and the contractor will establish failure rate prediction needed to satisfy this requirement. The reader should note that mechanizations which satisfy these failure immunity requirements are necessary, but may not be sufficient to meet reliability or flight safety requirements. For example, most redundant systems provide at least a single fail operate capability, where little or no degradation in performance results from single failures.

Mechanical interconnection of flaps and other controls may be required to provide the synchronization required by (d). If a mechanical flap interconnection is required to meet synchronization requirements, it must satisfy the structural integrity requirements of 3.1.11. It should withstand applicable unsymmetrical loads including those resulting from flight with the engines on one side of the plane of symmetry inoperative and the remaining engines at takeoff power. For airplanes with flaps that are not subjected to propeller slipstream or engine exhaust conditions, the structure should be designed for the loads imposed when the wing flaps on one side are carrying the most severe load occurring in the prescribed symmetrical conditions and those on the other side are carrying not more than 80 percent of that load. The flap interconnection should also be designed for the loads resulting when the flap surfaces on one side of the plane of symmetry are jammed and immovable while the surfaces on the other side are free to move and the full power of the surface actuating system is applied.

In the event of a failure of the high lift control system actuators such as a screwjack, hydraulic cylinder, etc., the high lift device should maintain synchronization, or remain synchronized without motion. There are several methods of providing systems which will do this, such as providing duplicate push-pull rods, torque tube systems, cable systems, etc., duplicating the drive unit and installing separate actuators at each high lift device segment and interconnecting the actuators, and providing an automatic shutoff system which receives position signals from each of the segments or from the outer ends of the torque tube system. Aircraft whose landing roll becomes critical, with respect to normal runway lengths and zero wind conditions, if high lift devices are not available, should not use automatic shutoffs which may deprive them of the use of these devices.

MIL-F-9490C included specific failure immunity requirements in terms of limits on control surface rates and authority and in terms of structural protection means. To meet the more general failure immunity requirements of this specification, these areas will also have to be considered.

For example for intermittent controls such as trim, high lift devices, etc., maximum surface rates should not exceed the rate which can create a maneuver generating limit airframe loads before the pilot or a safety device can react. This applies at all flight conditions, both at the maximum airspeed at which the control surface can be actuated and at the airspeed at which control surface operation yields maximum structural loading.

Inadvertent flap or control surface retraction or extension should be considered and prevented if hazardous flight occurrences such as altitude loss or stall during landing or aerial refueling can occur due to such retraction or extension. Inadvertent surface displacements due to both failure states and pilot error should be considered. In all cases, compensating action by the pilot should be considered, when pertinent, following the control surface movement. For large commercial aircraft in cruise, a three to five second reaction time is commonly used to represent the time required to react and regain positive control following failures. Such time delays are discussed in MIL-F-8785B and associated backup document AFFDL-TR-69-72, Reference 1.

Airplane structure should not be endangered by FCS or interfacing subsystem malfunctions. All FCS failure states resulting in a hazardous surface oscillation, hardover or other hazardous motion which cannot be overcome by pilot action should be prevented either by authority limiting, redundancy or other means.

3.1.3.2.1 Automatic terrain following failure immunity. The terrain following system shall detect any potentially critical failure, not shown to be extremely remote, in the command generation scheme, sensors, (including radar and radar altimeter) or terrain following AFCS and provide warning to the pilot. Any failure resulting in loss of the automatic terrain following function or unsafe flying condition shall provide safe exit (automatic fly-up) from the low altitude, high speed environment. Take over or injection of commands by the pilot while the system is operating shall permit a smooth and positive transition without adverse transients. AFCS function accuracy (heading and roll attitude hold) shall be maintained to the degree specified in 3.1.2.

DISCUSSION

An automatic fly-up command mechanization should be provided for safe exit while in the ATF mode. Monitoring of aircraft performance whether by an external system (radar altimeter override) or integral with the control law should utilize both altitude and altitude rate. Adequate display should be provided to allow pilot evaluation of the situation.

3.1.3.3 System operation and interface. Wherever a noncritical control or any other aircraft subsystem is interfaced with essential or flight phase essential flight control channels, separation and isolation shall be provided to make the probability of propagated or common mode failures extremely remote.

3.1.3.3.1 Warmup. After power is applied to the FCS, the warmup time required to meet this specification shall not be more than 90 seconds for MIL-F-8785 Class IV aircraft and not more than 3 minutes for other types of aircraft.

DISCUSSION

This requirement applies to both electronic, hydraulic and other system components. Specified system performance must be provided following this warmup period. Note that 3.1.9 permits temporary State II performance following warmup under unusual conditions.

3.1.3.3.2 Disengagement. Provisions shall be made for positive inflight disengagement of flight phase essential and noncritical electrical controls under all load conditions. No out of trim condition shall exist at disengagement which cannot be easily controlled by the pilot. The pilot shall be informed of automatic disengagement. Disengagement circuitry shall be designed such that a failure of the circuitry itself does not prevent automatic or manual disengagement.

3.1.3.3.3 Mode compatibility. Mode compatibility logic shall provide flexibility of FCS operation and ease of mode selection. The mode selection logic shall:

- a. Make correct mode selection by the crew highly probable.
- b. Prevent the engagement of incompatible modes that could create an immediate undesirable situation or hazard.
- c. Disconnect appropriate previously engaged modes upon selection of higher priority modes.
- d. Provide arming of appropriate modes while certain modes are engaged.
- e. Provide for the engagement of a more basic FCS mode in the event of a failure of a higher priority mode.

DISCUSSION

When a choice of FCS mode selections is made available it is necessary to specify a mode hierarchy and to ensure that the mode selection logic can handle all possible combinations of desirable and inadvertent selection.

3.1.3.3.4 Failure transients. Aircraft motions following sudden flight control system or component failures shall be such that dangerous conditions can be avoided by pilot corrective action. Time delays between the failure and initiation of pilot corrective action shall be as established by MIL-F-8785. Transients due to failures resulting in FCS Operational States I or II within a redundant FCS shall not exceed $+0.5g$ incremental normal or lateral acceleration at the center-of-gravity or $+10$ deg/sec roll rate. Transients due to failures within the FCS resulting in FCS Operational State III shall not exceed 75 percent of limit load factor or $+1.5$ g's from the initial value, whichever is less, at the most severe flight condition.

DISCUSSION

These failure transient requirements have been set considering safety needs and characteristics of redundant systems. No specific limits are given for sideslip angle, although the general requirement to avoid dangerous conditions will lead to the contractor establishing limits on sideslip. MIL-F-8785 includes additional failure transient requirements.

3.1.3.4 System arrangement. Systems shall be arranged as required to satisfy the reliability, invulnerability, failure immunity and other general requirements of this specification.

DISCUSSION

System arrangement is largely determined by the general requirements of this specification such as reliability and flight safety. System separation, protection and clearance is specified by 3.2.3.1.2 for signal transmission elements.

3.1.3.5 Trim controls. Each of the principal control axes shall have trim controls. Wherever worse than Operational State III would result from a power-operated trim control failure that is not extremely remote, the pilot shall be given override capability for the failed control. For series trim control, no worse than Operational State III shall result from a trim control becoming inoperative in any position, except for extremely remote failures. Engagement of the AFCS shall automatically initiate any needed pitch trim. Aircraft subject to short alerts shall have the capability incorporated to return all trim to the takeoff position automatically. Any automatically controlled trim shall incorporate positive means to avoid potentially hazardous adverse trim near stall. In multicrew aircraft with electrical trim systems, interlocks in the circuitry shall prevent simultaneous commands by two aircrew members from causing any operation in opposing directions at the same time.

DISCUSSION

These controls should preclude inadvertent or abrupt operation and each should operate in the plane and sense of aircraft motion it affects. Trim system irreversibility is specified in MIL-F-8785 and is an important consideration. Airplanes which have provisions for manual control of essential or flight phase essential FCS in the event of power failure should also provide manual trim in the event of power failure.

Automatic trimming functions must operate at rates which allow the AFCS to meet AFCS transient performance requirements.

Inoperative trim is a particularly important consideration when series trim is employed. With that type mechanization the stick position provides no cue about the amount of control authority remaining to the pilot. For other mechanizations, pilot override would normally be considered an appropriate way to provide Operational State III.

AFCS trim circuitry should be arranged to reduce the effect of a failure in the AFCS on manual trim operation following AFCS disengagement. The failure immunity requirements of this specification set limits on such effects.

Care should be taken in AFCS design to minimize friction and inertia contributed by the disengaged AFCS to the MFCS. The flying qualities specifications set limits on the MFCS which must be satisfied with the AFCS disengaged. The flying qualities specifications also specify trim rate, trim stall and control force requirements related to trim.

3.1.3.6 Stability. For FCS using feedback systems, the stability as specified in 3.1.3.6.1 shall be provided. Alternatively, when approved by the procuring activity, the stability defined by the contractor through the sensitivity analyses of 3.1.3.6.2 shall be provided. Where analysis is used to demonstrate compliance with these stability requirements, the effects of major system nonlinearities shall be included.

3.1.3.6.1 Stability margins. Required gain and phase margins about nominal are defined in Table III for all aerodynamically closed loop FCS. With these gain or phase variations included, no oscillatory instabilities shall exist with amplitudes greater than those allowed for residual oscillations in 3.1.3.8, and any nonoscillatory divergence of the aircraft shall remain within the applicable limits of MIL-F-8785 or MIL-F-83300. AFCS loops shall be stable with these gain or phase variations included for any amplitudes greater than those allowed for residual oscillations in 3.1.3.8. In multiple loop systems, variations shall be made with all gain and phase values in the feedback paths held at nominal values except for the path under investigation. A path is defined to include those elements connecting a sensor to a force or moment producer. For both aerodynamic and nonaerodynamic closed loops, at least 6 db gain margin shall exist at zero airspeed. At the end of system wear tests, at least 4.5 db gain margin shall exist for all loops at zero airspeed. The margins specified by Table III shall be maintained under flight conditions of most adverse center-of-gravity, mass distribution, and external store configuration throughout the operational envelope and during ground operations.

TABLE III
GAIN AND PHASE MARGIN REQUIREMENTS (dB, DEGREES)

Mode Frequency Hz	Airspeed	Below V_{0MIN}	V_{0MIN} To V_{0MAX}	At Limit Airspeed (V_L)	At $1.15 V_L$
$f_M < 0.06$		GM = 6 dB (No Phase Require- ment Below V_{0MIN})	GM = ± 4.5 PM = ± 30	GM = ± 3.0 PM = ± 20	GM = 0 PM = 0 (Stable at Nominal Phase and Gain)
$0.06 \leq f_M < \text{First Aero-ElasticMode}$	GM = ± 6.0 PM = ± 45		GM = ± 4.5 PM = ± 30		
$f_M > \text{First Aero-ElasticMode}$	GM = ± 8.0 PM = ± 60		GM = ± 6.0 PM = ± 45		

Contrails

where: V_L	= Limit Airspeed (MIL-A-8860).
$V_{O_{MIN}}$	= Minimum Operational Airspeed (MIL-F-8785).
$V_{O_{MAX}}$	= Maximum Operational Airspeed (MIL-F-8785).
Mode	= A characteristic aeroelastic response of the aircraft as described by an aeroelastic characteristic root of the coupled aircraft/FCS dynamic equation-of-motion.
GM = Gain Margin	= The minimum change in loop gain, at nominal phase, which results in an instability beyond that allowed as a residual oscillation.
PM = Phase Margin	= The minimum change in phase at nominal loop gain which results in an instability.
f_M	= Mode frequency in Hz (FCS engaged).
Nominal Phase and Gain	= The contractor's best estimate or measurement of FCS and aircraft phase and gain characteristics available at the time of requirement verification. (2)

3.1.3.6.2 Sensitivity analysis. Tolerances on feedback gain and phase shall be established at the system level based on the anticipated range of gain and phase errors which will exist between nominal test values or predictions and in-service operation due to such factors as poorly defined nonlinear and higher order dynamics, anticipated manufacturing tolerances, aging, wear, maintenance and noncritical material failures. Gain and phase margins shall be defined, based on these tolerances, which will assure satisfactory operation in fleet usage. These gain and phase tolerances shall be established based on variations in system characteristics either anticipated or allowed by component or subsystem specification. The contractor shall establish, with the approval of the procuring agency, the range of variation to be considered based on a selected probability of exceedance for each type of variation. The contractor shall select the exceedance probability based on the criticality of the flight control function being provided. The stability requirements established through this sensitivity analysis shall not be less than 50 percent of the magnitude and phase requirements of 3.1.3.6.1.

DISCUSSION

The gain and phase margin definitions listed are commonly used within flight control technology, and are not the classical definitions found in most textbooks. These margins are both positive and negative. A negative gain variation (reduction) can lead to instability on a basically unstable airframe which relies on the feedback system for dynamic stability. Positive and negative phase margins denote the amount of lag and lead that may be added, respectively, before instability occurs.

Contrails

The margins specified vary with frequency. These margins can be determined using classical linear analysis techniques, adjusted for known nonlinearities. Normally in test a lower frequency mode will set the test margins, and gain margins at higher frequencies will be unobservable. Consequently, compliance with these gain and phase margin requirements will likely be demonstrated through analysis in most procurements.

Figure 3D illustrates a typical FCS block diagram. Several feedback loops are shown; however, only one feedback path is shown, since only one sensor and one moment producer are involved. Thus, only one control path exists and only one stability requirement applies.

Stability margins are required for FCS to allow for variations in system dynamics. Three basic types of variations exist:

Math modeling and data errors in defining the nominal system and plant.

Variations in dynamic characteristics caused by changes in environmental conditions, manufacturing tolerances, aging, wear, noncritical material failures, and off-nominal power supplies.

Maintenance induced errors in calibration, installation and adjustment.

Most low frequency math modeling errors can be adjusted out during ground or flight tests to obtain the desired nominal operating characteristics. At high frequencies, math modeling errors are difficult to identify and compensate for during testing due to the approximations used to implement operational mockups, the limited amount of flight test time available and/or the limitations of instrumentation commonly used. In addition to the variations caused by the factors listed above, variations may exist due to usage of an inadequate number of flight conditions for a given analysis or flight test program. Within the industry, flight control synthesis is normally accomplished using equations-of-motion defining aircraft and system characteristics at selected points on the flight envelope in various aircraft configurations. Flight testing is also normally concentrated at a limited number of points within the flight envelope. Selection of the number and type of flight conditions to be used is an individual decision in each procurement.

Another source of variations occurs following completion of the aircraft development. Following initial fleet usage, most aircraft experience a series of minor modifications to improve airplane operating characteristics. These modifications, which typically result in quite minor configuration changes on an individual basis, can result in significant changes in flight control stability margins as modifications are accumulated through several years. The original flight control system design should allow for a degree of such variations, such that FCS modification is not needed following all aircraft modifications.

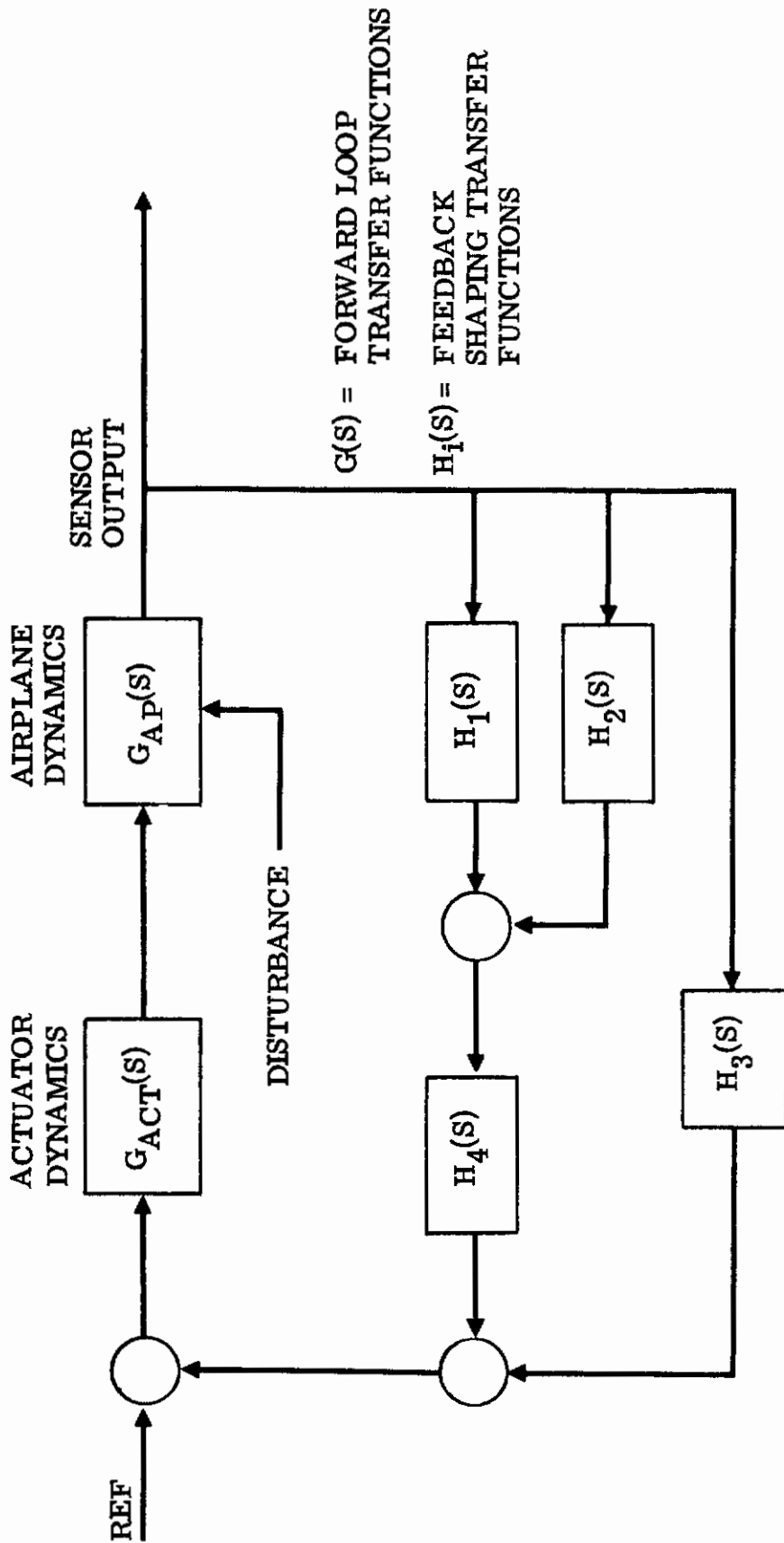

Figure 3D. Typical FCS Block Diagram

Contrails

The intent of including effects of major nonlinearities in analyses used to demonstrate compliance is to insure that adequate margins are retained with the systems operating both in the linear and nonlinear range. Most FCS exhibit rate limiting nonlinearities with large control surface amplitudes at higher frequencies. Deadband or hysteresis is also usually present. Where linear analysis techniques such as root locus are used, phase and gain characteristics for the feedback elements operating at small perturbations should be considered to evaluate nonlinearities such as break-out deadzones or hysteresis and, separately, phase and gain characteristics for feedback elements operating at medium and large control surface amplitudes should be considered to evaluate the near linear case and the rate limiting case. Where simulation is used, these nonlinearities can be included directly and evaluated by measuring frequency responses at different control surface amplitudes. The contractor may choose to use both linear analyses and nonlinear simulation techniques to demonstrate compliance with these requirements, since the linear analysis approach normally provides a better representation of aeroelastic effects and the simulation approach normally is superior for nonlinear evaluations.

The math models to be used for these stability analyses will vary with each procurement. The contractor will determine what math model complexity is required for each procurement and should include this model description in the FCS Development Plan (4.4.1).

The gain and phase margins specified are in the range of values used in previous successful procurements, and are considered the minimums which will provide largely trouble free service during fleet usage. Reference 48 recommends the 6 dB zero airspeed requirement and provides a discussion of NASA ground and flight testing of stability augmentation systems. Reference 49 recommends a 12 dB requirement.

Margins are specified for aerodynamically closed loops and nonaerodynamic loops. An aerodynamic loop is one which relies on aerodynamics for loop closure such as a stability augmentation or AFCS loop. Nonaerodynamic loops do not rely on aerodynamics for loop closure. An example is a servo-actuator loop.

A recommended practice for higher frequency modes is to gain stabilize all modes (± 180 degrees phase margin). A feedback signal attenuation of at least second order beyond the actuator second order frequency is also commonly used. Reference 50, for example, used a 180 degrees phase margin criteria beyond 5 Hertz.

An example of problems encountered in the past with nonaerodynamic loop stability is the B-52 stick steering AFCS. During ground testing of the A/A 42G-11 AFCS a 4.2 Hertz instability was encountered in the pitch control system. This problem occurred the first time the equipment was installed in B-52 60-002 and resulted in a 4.2 Hertz unstable oscillation of the control column which would build up until an automatic disconnect occurred through the overpower circuit. This problem was eliminated by attenuating the loop gain near 4.2 Hertz through filter modification and relocation of the pitch force transducer. To avoid such problems, a stability analysis of the

nonaerodynamic loops should be accomplished with column inertia, feel system characteristics and other MFCS parameters properly modeled. In some applications the pilot may couple with the system and pilot mass or inertia may have to be included in the analysis. The full range of excursions expected in service should be simulated or otherwise analyzed, especially where breakout dead zones, hysteresis, and rate limiting result in significant nonlinear system characteristics.

Reference 6 documents a sensitivity analysis performed to establish gain and phase margin criteria required to accommodate tolerances in the structural frequencies. Similar analyses can be used to determine stability margins at all frequencies for a given procurement based on the inaccuracies anticipated in the parameters and modeling technique used and based on the depth of analyses planned to investigate off-nominal conditions and the effects of wear and aging.

The stability margins specified vary in size with mode frequency and airspeed. The reduction in margin at V_L , reflects a willingness to accept reduced stability and/or performance while flying outside the operational envelope. The increased margins at higher frequencies reflect needs based upon the decreasing accuracy of state-of-the-art modeling and testing techniques at higher frequencies.

3.1.3.7 Operation in turbulence. In Operational State I, while flying in the following applicable random and discrete turbulence environment, the FCS shall provide a safe level of operation and maintain mission-accomplishment capability. For essential and flight phase essential controls, at least Operational State III shall be provided in the specified flight-safety turbulence levels. Noncritical controls shall provide at least Operational State II in turbulence up to the intensities specified in 3.1.3.7.1. Noncritical controls operating in turbulence at intensities above the specified turbulence level, shall not degrade flight safety or mission effectiveness below the level that would exist with the control inactive. Either manual or automatic means to inactivate the control for flight in heavy turbulence may be used, when required. The dynamic analysis or other means used to satisfy this requirement shall include the effects of rigid body motion, significant flexible degrees of freedom and the flight control system. Significant nonlinear effects shall be represented by conservative nonlinear or equivalent linear representations.

3.1.3.7.1 Random turbulence. The RMS turbulence intensity to be used for normal flight and for terrain following shall have a cumulative probability of exceedance as shown in Table IV. Table V defines RMS vertical gust amplitude versus altitude for selected exceedance probabilities. The relationship among vertical, lateral and longitudinal RMS intensities and scales as specified in MIL-F-8785 shall be used to establish intensities for lateral and longitudinal gusts. The listed turbulence intensity levels apply at the turbulence penetration airspeed, V_G . At the maximum level flight airspeed, V_H these intensity levels are reduced to 38 percent of the specified levels. The mathematical forms of continuous random turbulence to be used in conjunction with the specified intensity levels are as specified in MIL-F-8785 and the airspeeds cited are as specified in MIL-A-8860.

TABLE IV
TURBULENCE INTENSITY EXCEEDANCE PROBABILITY

FCS Function Criticality \ Aircraft Class	MIL-F-8785 Class III	MIL-F-8785 Class I, II & IV
Essential	10^{-6}	10^{-5}
Flight Phase Essential	$\frac{1}{T}10^{-6}$	$\frac{1}{T}10^{-5}$
Noncritical	10^{-2}	10^{-2}

where: T = The longest time spent in essential flight phase segment in any mission/total flight time per mission. (3)

3.1.3.7.2 Discrete gusts. Discrete gust amplitudes to be used shall be established using the relationship between random and discrete gust amplitudes in accordance with MIL-F-8785, and the RMS amplitudes specified in 3.1.3.7.1. The 1-cosine discrete gusts defined by MIL-F-8785 shall be applied with wavelengths tuned to provide maximum excitation.

DISCUSSION

Turbulence levels are specified in terms of exceedance probabilities and FCS function criticality. Exceedance probabilities are stationary probabilities as opposed to the nonstationary probabilities used in reliability analyses. See the discussion under 3.1.2.11.2.2 for a discussion of the difference. For essential controls, the airplane turbulence penetration capability may be set by the structural length of the airframe, the augmentation capability of control system, or a combination of the two. Reference 51 describes recent incidents in large jet transport operation where some loss of longitudinal control occurred in heavy turbulence. The search for the cause of these incidents has centered on possible effects of severe turbulence, such as structural vibration of the pilot's cockpit which limit the pilot's ability to read instruments or the possibility of pilot disorientation due to apparently conflicting indications from his instruments, combined with unusual motion sensations. Reference 52 also tabulated and discussed recent accidents caused by severe turbulence. This paper concludes that the main hazard is loss of control followed by structural breakup during recovery attempts. The author pointed out that the cost of turbulence to DOD operations is difficult to evaluate, but estimated costs for the three year period of 1963-65 at \$30,000,000 for DOD aircraft loss and damage.

Most noncritical controls do not affect turbulence penetration capability and the noncritical controls designer is primarily concerned with maintaining acceptable performance in terms of pilot relief or ride quality while in turbulence. Noncritical systems such as ride smoothing systems may be designed to permit saturation in moderate turbulence while maintaining a reduced level of ride improvement. Many pilot relief AFCS modes are commonly

TABLE V
RMS GUST INTENSITIES FOR SELECTED CUMULATIVE
EXCEEDANCE PROBABILITIES, FT/SEC TAS

FLIGHT SEGMENT	ALTITUDE (FT - AGL)	PROBABILITY OF EXCEEDANCE						
		2×10^{-1}	10^{-1}	10^{-2}	10^{-3}	10^{-4}	10^{-5}	10^{-6}
TERRAIN FOLLOWING	UP TO 1000 (LATERAL)	4.0	5.1	8.0	10.2	12.1	14.0	23.1
	UP TO 1000 (VERTICAL)	3.5	4.4	7.0	8.9	10.5	12.1	17.5
NORMAL FLIGHT CLIMB CRUISE AND DESCENT	500	3.2	4.2	6.6	8.6	11.8	15.6	18.7
	1,750	2.2	3.6	6.9	9.6	13.0	17.6	21.5
	3,750	1.5	3.3	7.4	10.6	16.0	23.0	28.4
	7,500	0	1.6	6.7	10.1	15.1	23.6	30.2
	15,000	0	0	4.6	8.0	11.6	22.1	30.7
	25,000	0	0	2.7	6.6	9.7	20.0	31.0
	35,000	0	0	0.4	5.0	8.1	16.0	25.2
	45,000	0	0	0	4.2	8.2	15.1	23.1
	55,000	0	0	0	2.7	7.9	12.1	17.5
	65,000	0	0	0	0	4.9	7.9	10.7
	75,000	0	0	0	0	3.2	6.2	8.4
	OVER 80,000	0	0	0	0	2.1	5.1	7.2

Contrails

disengaged when turbulence is encountered. Reference 53 describes a study to determine the optimum AFCS mode configuration for flight in severe turbulence. This study recommends engaging the roll and yaw attitude hold modes with system gains considerably reduced for turbulence penetration. All pitch modes and the Heading Hold mode should be disengaged, based on this study. However, it is important to avoid inadvertent automatic mode disengagement in light turbulence.

The turbulence intensities for essential and flight phase essential controls are intended to result in control systems capable of operating at least a minimum safe (Operational State III) condition in the maximum turbulence intensity which the structure can penetrate without exceeding limit load. The turbulence intensities specified for noncritical controls are much lower than those defined for essential controls and are correlated with the mission accomplishment probability specified for an individual procurement.

The Flutter Mode Control System designed for the B-52 CCV flight demonstration (Reference 23) was required to operate in turbulence with an exceedance probability of 10^{-6} .

MIL-F-9490C required AFCS to be designed for a tuned discrete gust of 40 ft/sec amplitude. The system function specified was limited to damping only and no requirement was placed on manual FCS. This requirement is stated in terms of minimum safe operation (Operational State III) for essential controls and in terms of restricted operation (Operational State II) for noncritical controls. Changes in system damping ratios, frequencies and other characteristics caused by system saturation in turbulence are permitted providing the specified operational states are maintained. Stability augmentation systems can often tolerate substantial displacement saturation and some rate saturation while maintaining a reduced level of performance. Noncritical controls, which must be designed fail-safe (3.1.3.2), can often tolerate severe displacement saturation.

Control system rate limiting must be emphasized for FCS controlling an unstable airframe, since rate limiting as well as displacement can cause loss of stability. The procedure used for the American SST design, see Reference 12, was to rely on simulation studies to establish the allowable actuator minimum rate requirements. The design condition was piloted flight in heavy turbulence at landing approach. These minimum rate requirements were less than the common criterion of providing stop-to-stop surface travel in one second. After the minimum rate requirements were established, it was verified that the system could provide these minimum rates under any combinations of failures which would still allow at least minimum safe control.

Reference 54 describes a method for predicting the performance of the total pilot-vehicle system for command tracking and altitude hold tasks in turbulence. This method is based on pilot model theory and prediction of tracking errors. The validity and accuracy of this method has been ascertained by means of moving base simulation and the contractor may want to use a similar method to comply with this requirement.

Reference 55 includes an excellent discussion of the current state-of-the-art in understanding the problem of flight safety in turbulence. The author points out that control has been an important, and perhaps critical factor in

Contrails

recent turbulence related aircraft losses. It was noted that commercial transports have been estimated to spend between 0.01 and 0.1 percent of their flight time in thunderstorms, despite the high priority given to storm avoidance. Mountain waves are also a serious flight safety problem and have resulted in aircraft loss. Clear air turbulence, although quite common, is not generally considered a flight safety problem.

The Reference 55 study emphasized that turbulence normally occurs in patches and recommends a five-mile wide patch for simulation. Reference 52 indicates an average patch duration of approximately one minute for moderate to severe turbulence for world-wide civil aircraft operation. The turbulence requirements of this specification should be evaluated using the turbulence patch approach, although the length of the patch may be selected by the contractor as either less or greater than five miles, depending on the mission requirements of the procurement.

The specified turbulence intensity levels are reduced in magnitude as airspeed is increased beyond the turbulence penetration airspeed. This procedure is based on the precedent of the MIL-S-8861 gust load requirement and similar FAA requirements which allow similar reductions at speeds above the gust penetration airspeed.

The analytical form for turbulence mathematical models specified in MIL-F-8785 are referenced for use in flight controls analyses. The major difference between the turbulence requirements of MIL-F-9490 and MIL-F-8785 is in the required intensity levels. The requirements of MIL-F-8785 are restricted to flying qualities and are generally more lenient than those specified in this specification. The turbulence intensity requirements specified herein for essential and flight phase essential systems are based on safety considerations with a prime objective to retain minimum safe operation in any environment the structure may be expected to penetrate.

The curves shown in Figure 4D, which illustrate the probabilities tabulated in Table V, were established using the following relationship:

$$P(\sigma_g) = P_1 + P_2 - \int_0^{\sigma_g} \frac{P_1}{b_1} \sqrt{\frac{2}{\pi}} e^{\left(\frac{-\sigma_g^2}{2b_1^2}\right)} d\sigma_g - \int_0^{\sigma_g} \frac{P_2}{b_2} \sqrt{\frac{2}{\pi}} e^{\left(\frac{-\sigma_g^2}{2b_2^2}\right)} d\sigma_g$$

where

- $P(\sigma_g)$ = cumulative probability that σ_g will equal or exceed a given level.
- σ_g = root mean square value of gust velocity relative to the airplane body axis, ft/sec TAS.
- P_1 = proportion of flight time spent in nonstorm turbulence at a given altitude.
- P_2 = proportion of flight time spent in storm turbulence at a given altitude.

Contrails

and

$$\int_0^{\sigma_g} \frac{P_1}{b_1} \sqrt{\frac{2}{\pi}} e^{\left(\frac{-\sigma_g^2}{2b_1^2}\right)} d\sigma_g = 2P_1 \int_0^{\frac{\sigma_g}{b_1}} \sqrt{\frac{1}{2\pi}} e^{\left(\frac{-\sigma_g^2}{2b_1^2}\right)} d\sigma_g$$

Values of P_1 , P_2 , b_1 and b_2 were taken from MIL-A-008861A. Table V lists values of RMS turbulence intensities for various exceedance probabilities, altitudes and flight segments.

3.1.3.7.3 Wind model for landing and takeoff. The following wind model form shall be used for automatic navigation and all weather landing system design as required by 3.1.2.9 and 3.1.2.10. This model applies for low altitude approach and landing flight phases at conventional airports and shall not be applied at heights greater than 500 feet above mean runway level.

3.1.3.7.3.1 Mean wind. The probability of occurrence of total mean wind and mean crosswind components as shown on figure 2 as a function of wind speed in knots as measured at a reference altitude of 20 feet above mean surface level.

3.1.3.7.3.2 Wind shear. Wind shear shall be included in each simulated approach and landing unless its effect can be accounted for separately. The magnitude of the shear is defined by the expression

$$u = .46 U \log_{10}(Z) + .4 U$$

where u = mean wind at height Z feet in feet/sec (true)

U = mean wind at 20 feet in feet/sec (true)

Z = height above ground (feet) (4)

3.1.3.7.3.3 Wind model turbulence. The longitudinal wind component (in the direction of the mean wind) and vertical and lateral wind components shall each be represented by a Gaussian process having a spectral density, $\Phi(\Omega)$ of:

$$\Phi(\Omega) = \sigma_i^2 \frac{2L_i}{\pi} \frac{1}{(1 + \Omega^2 L_i^2)}, \left(\frac{FT}{SEC}\right)^2 / \frac{RAD}{FT}$$

where: σ_i = RMS turbulence level in an axis in feet/sec

L_i = Scale length in an axis, feet

Ω = Spatial frequency in radians/ft. (5)

and the value for σ and L is shown on Table VI.

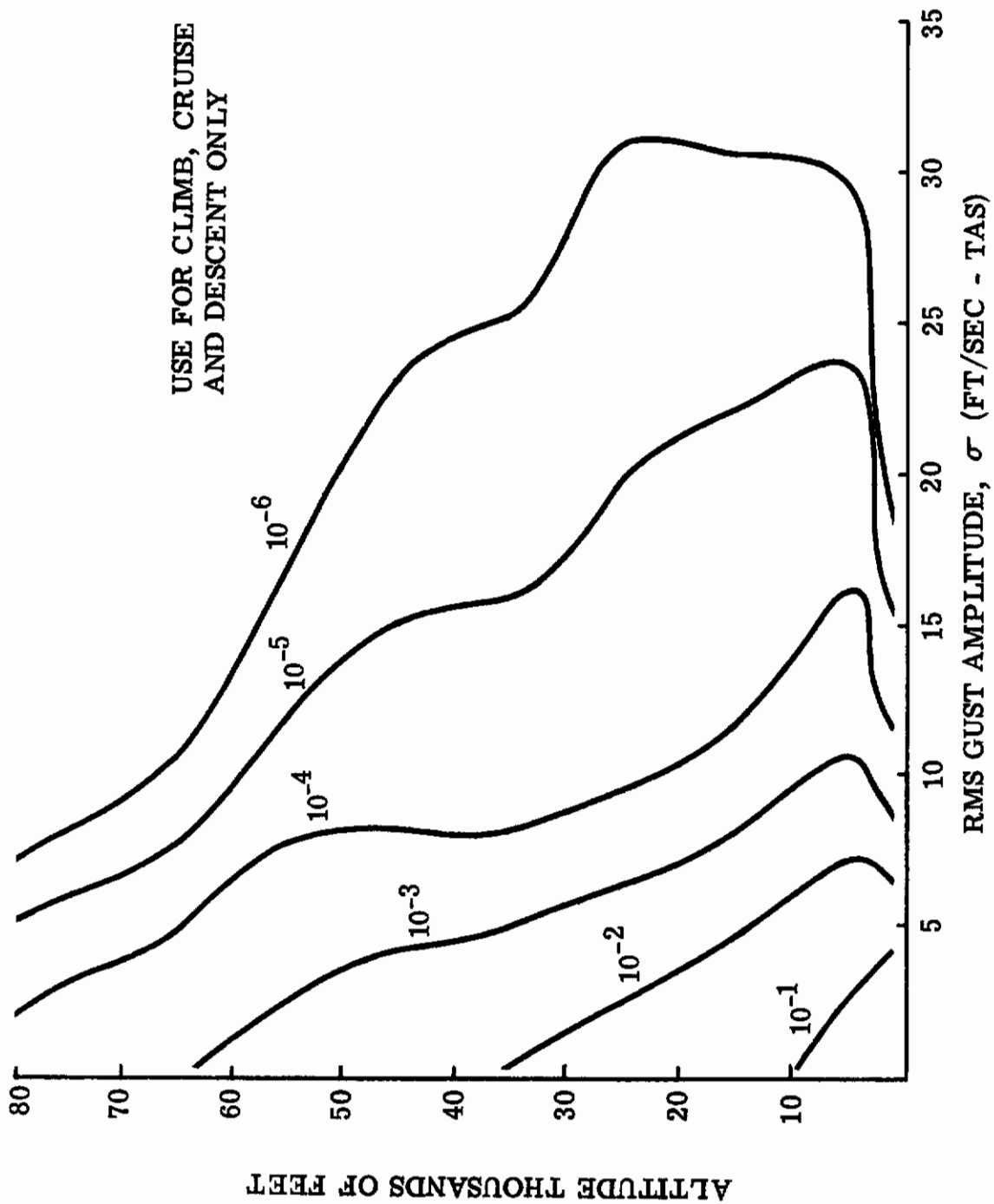

Figure 4D. Exceedance probability vs. altitude and RMS gust amplitude

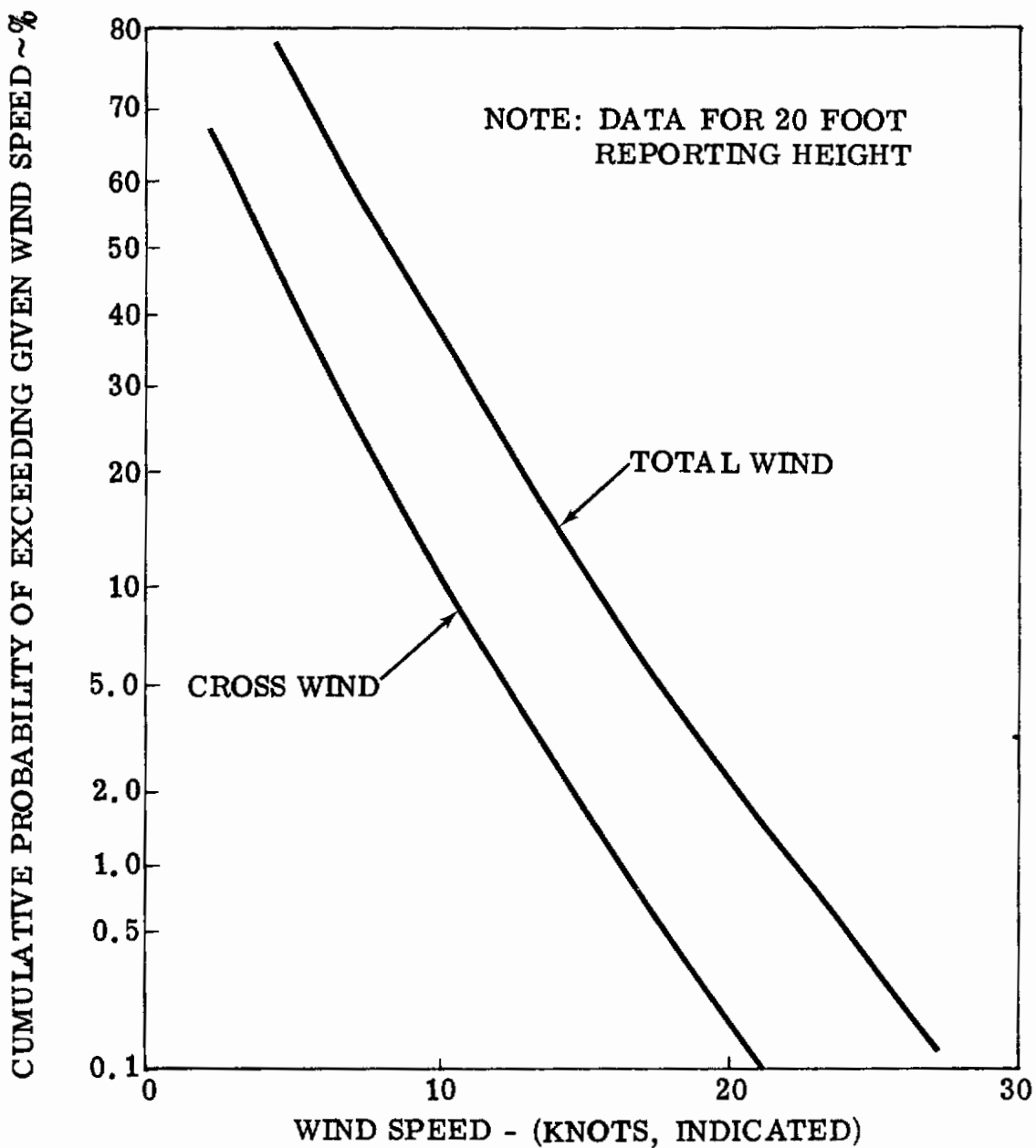

Figure 2. Cumulative probability of reported mean wind and cross wind when landing

TABLE VI
RMS TURBULENCE LEVEL AND SCALE LENGTH BY AXIS

	Vertical	Lateral	Longitudinal
σ	0.1 U	0.2 U	0.2 U
L	15 Ft for $Z \leq 30$ Ft .5 Z Ft for $30 \leq Z \leq 1000$	600 Ft 1000 Ft	600 Ft

DISCUSSION

The wind model currently adopted for MIL-F-9490D is based on the model described in British Civil Air Regulations (BCAR) paper 367, Issue 3, January 1970. The criteria leading to adoption of this model are:

It most nearly fits the spectral power density curve of observed winds compared to any other analytical model presently in use.

Correlative data comparing in-service aircraft performance with lab data is available.

The model is easily simulated by digital or analog equipment and requires only a moderate amount of memory or analog equipment.

New more comprehensive wind models are currently under study, but it is reasonable to expect that they will not be incorporated into MIL-F-9490 until such time as they have been demonstrated to comply with the criteria stated above. Incorporating untried models would only serve to destroy a consistent baseline of comparison between modern military and civil aviation systems along with the benefits accruing from such comparisons.

The wind model defined is intended for use in approach, landing and take-off simulation. It is specifically a low altitude model and should not be relied on for altitudes above 500 feet above mean surface level. The model has been modified from that in the referenced BCAR paper to reflect a wind-reporting height of 20 feet above the surface. This modification brings the model in line with American tower reporting procedures.

The wind shear defined in 3.1.3.7.3.2 is based on the consideration that in neutrally stable air, the wind profile between 10 feet and 300 feet above the surface may be given by

$$\frac{Ku}{u^*} = \ln \frac{Z}{Z_0} \text{ or } u = \frac{u^*}{K} \ln \frac{Z}{Z_0}$$

where

- K = von Karman constant = 0.4
- u = wind velocity at height Z above the surface
- u* = friction velocity, considered to be a constant up to a height of at least 300 feet above the surface
- Z₀ = aerodynamic roughness height (0.15 feet for terrain typical of airfields)

Larger wind shears can occur in convectionally stable conditions (essentially laminar flow) which usually occur at night with mean wind speeds less than 20 feet/second. However, the circumstances are less severe since the associated turbulence will be less than the levels given in 3.1.3.7.3.3.

In conditions of roughly neutral atmospheric stability, the rms of the horizontal wind speed fluctuations is close to 0.20 U ft/sec. (U is the 20-foot reported wind in feet/sec.) for terrain typical of airfields and it can be taken as independent of height from 10 ft. up to at least 300 ft. In unstable conditions the rms is likely to be relatively larger (up to 0.33 U), while in stable conditions lower rms values occur, down to almost zero. For mean wind speeds greater than 30 ft/sec., atmospheric stability is likely to be nearly neutral.

In conditions of nearly neutral atmospheric stability, over a range of wavelengths from 300 ft. to 3,000 ft., the spectral density of the horizontal gusts behaves as the kth power of wavelength, where k varies with height, between above 1.4 at 100 ft. and 1.1 at 10 ft. At altitudes above 100 ft., k approaches 1.67 and is approximately equal to this value at wavelengths shorter than 300 ft. at all heights. Adequate data is not available for definite statements to be made about the behavior of the spectral density at wavelengths longer than 3,000 ft. but it would be reasonable to assume that it is constant. The model defined in 3.1.3.7.3.3 is chosen to give agreement with the measured data for wavelengths between about 300 ft. and 5,000 ft. (see Figures 5D and 6D).

In the Gaussian process model, changes in longitudinal wind velocity over an arbitrary distance have a Gaussian distribution. Although giving an adequate description of measured wind decreases, the Gaussian model underestimates the probability of large wind increases. In adopting the Gaussian model, the consideration is made that critical aircraft performance parameters are most significantly influenced by wind decreasing.

Data on vertical gusts below 300 ft. above the surface in strong winds (in excess of 30 ft/sec) is much less extensive than it is for horizontal gusts. Available information is that the rms of turbulence intensity is about one-half that of the horizontal component. The spectral density appears closer to the form given in 3.1.3.7.3.3 than that of the horizontal gusts. However, the scale length varies significantly with height as indicated by the table of parameters in 3.1.3.7.3.3.

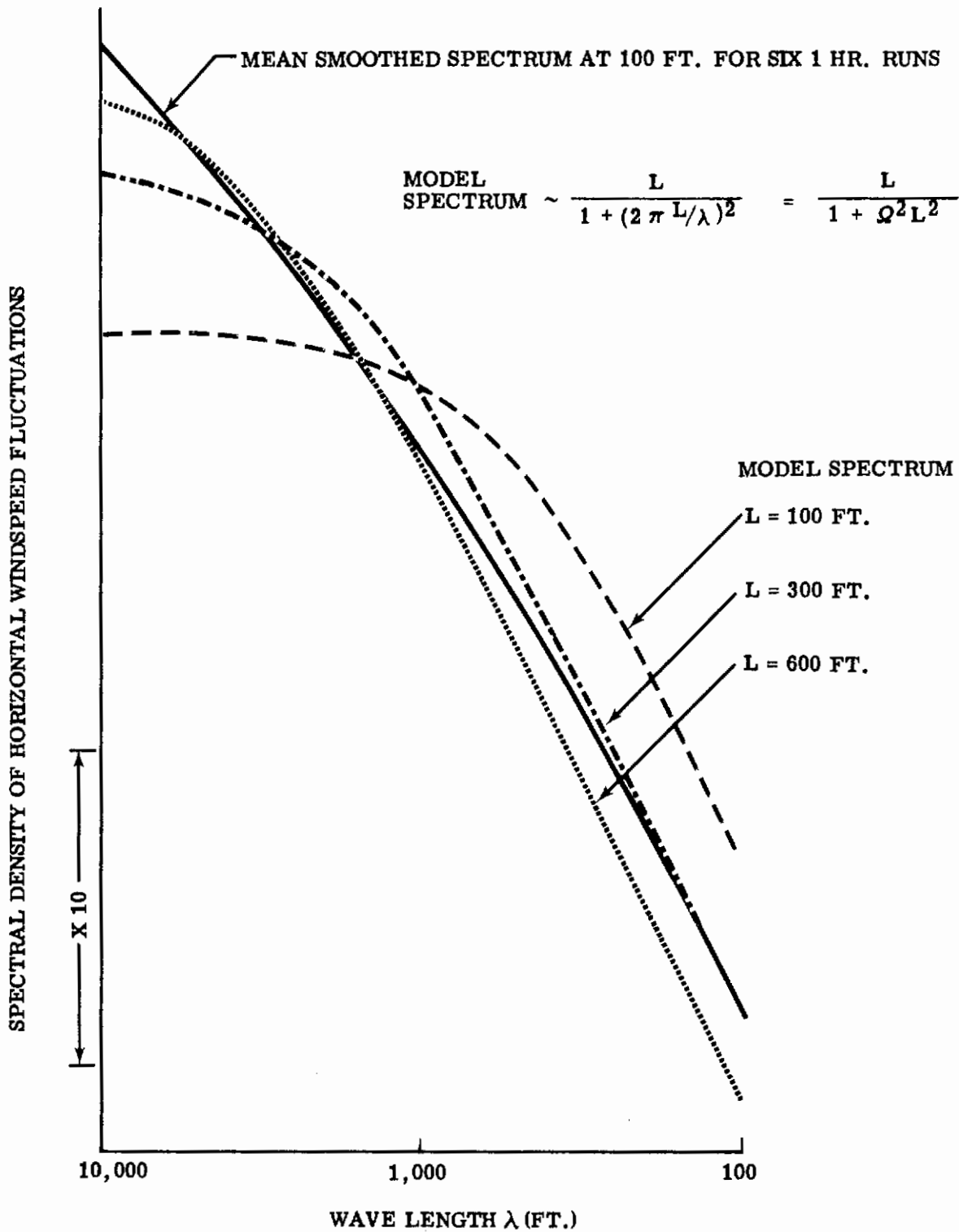

Figure 5D. Mean smoothed spectrum at 100 ft. height compared with model spectra having the same RMS and various values of scale lengths

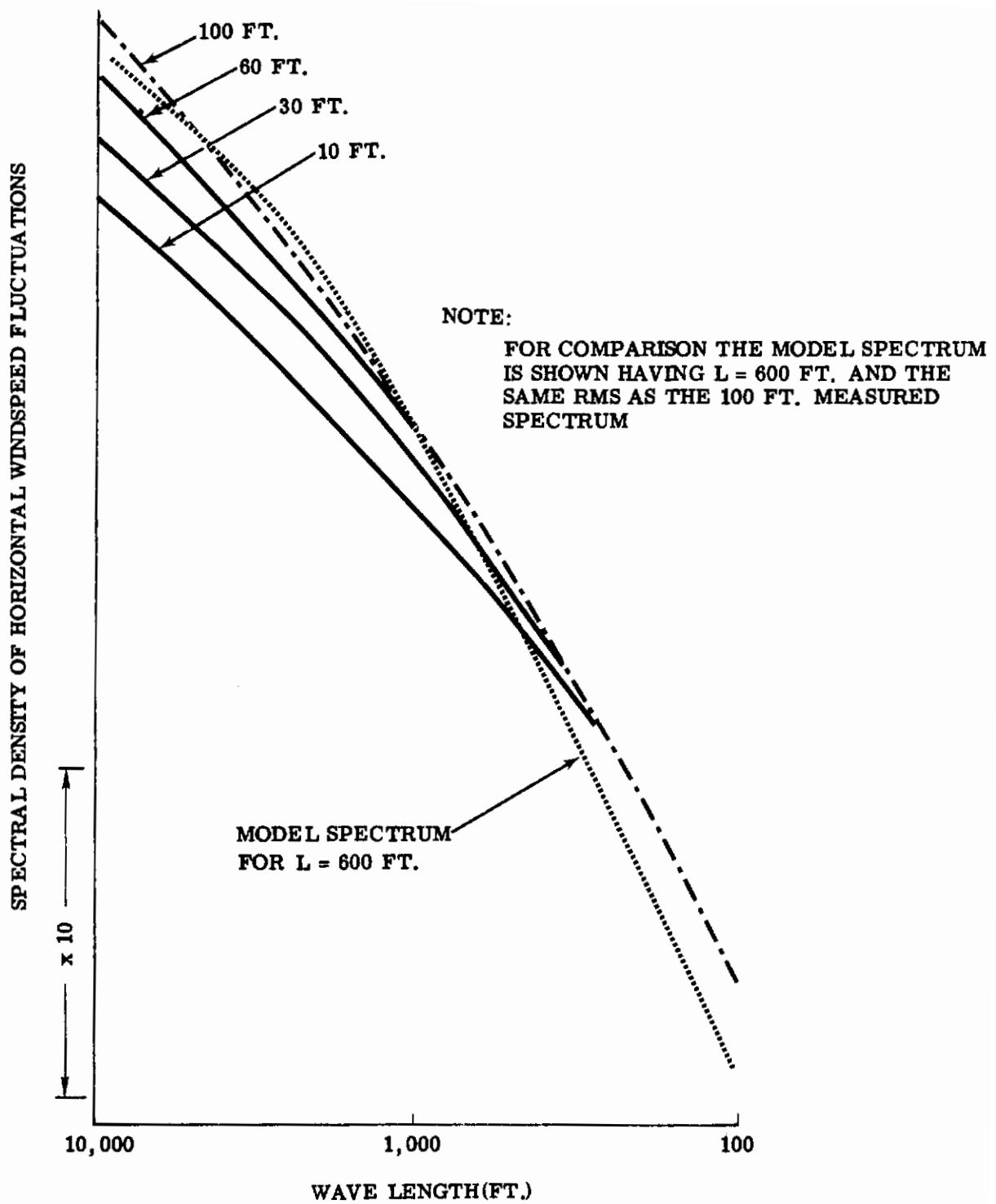

Figure 6 D. Mean smoothed spectra for six 1 hour runs, fitted to give same spectral density at short wave lengths

In unstable conditions, particularly in the presence of cumulo nimbus or well developed cumulus clouds, large and rapid fluctuations in wind speed and direction occur which are apparently unrelated to the mean speed or direction of the wind before their occurrence, which is usually light and seldom greater than 30 ft/sec. These large and rapid fluctuations are not represented in the gust model of 3.1.3.7.3.3. The model spectra provide a good prediction of large gusts associated with winds stronger than 30 ft/sec on an annual basis. But, the model significantly underestimates largest annual gusts associated with lighter winds. For example, the probability of large gusts associated with a mean wind speed of 15 ft/sec are predicted to be about half of the observed value.

3.1.3.8 Residual oscillations. For normal operation and during steady flight, FCS induced aircraft residual oscillations at all crew and passenger stations shall not exceed 0.04g's vertical or 0.02g's lateral peak to peak acceleration. Residual oscillations in pitch attitude angle shall satisfy the longitudinal maneuvering characteristic requirements of MIL-F-8785. Residual oscillations in roll and yaw attitude at the pilot's station shall not exceed 0.6 degree peak to peak for flight phases requiring precision control of attitude.

DISCUSSION

These residual oscillation requirements apply to both manual and automatic FCS under normal conditions. These limits do not apply to failure states such as FCS Operational States below State I. The amplitudes specified correspond roughly to the perceptible level. There is some disagreement in the literature on the exact level of perception. Different researchers have established slightly different perception levels based on using different test environments and test subjects. Perception level also varies with frequency. Reference 24, for example, lists results of low frequency moving base testing which suggests low frequency perception levels roughly 25 percent below those specified for normal acceleration. However, in general, the amplitudes specified should prove acceptable in general military usage.

MIL-F-8785 includes pitch axis residual oscillation requirements in general terms with a 0.10g maximum cited. These requirements are more specific and include all axes. The intent of this requirement is to prohibit FCS residual oscillations which can be detected by the crew.

The angular attitude oscillation requirement is based on tracking accuracy concerns. Little or no data is available to substantiate the limits specified, which are double the previous MIL-F-9490C limits. Roll residual oscillations of 0.7 degree have been reported for the AWACS airplane without crew complaint. Reference 13 recommends ± 0.5 degrees of 1.0 degree peak to peak as the roll attitude limit for commercial transport design. Residual oscillations in pitch attitude and heading are also limited to ± 0.25 degree or 0.5 degree peak to peak. These higher values are acceptable for flight phases not requiring precision control of attitudes. In procurements having stringent tracking accuracy requirements, residual oscillations will likely be reduced even below the limits specified to obtain desired performance.

Contrails

Residual oscillatory surface deflection limits of 0.5 degree peak to peak to take care of equipment wear considerations, as well as crew discomfort should be considered based on the conclusions of Reference 48.

3.1.3.9 System test and monitoring provisions. Test and monitoring means shall be incorporated into the essential and flight phase essential FCS as required to meet the following requirements of this specification:

Mission Reliability	3.1.6
Flight Safety	3.1.7 to 3.1.7.1
Fault Isolation	3.1.10.2 to 3.1.10.2.2
Failure Immunity & Safety	3.1.3.2 to 3.1.3.2.1
Survivability	3.1.8 to 3.1.8.1
Invulnerability	3.1.9 to 3.1.9.7

The effect of detected and undetected FCS failures taken with the probability of occurrence of such failures shall comply with the system reliability and safety requirements. This requirement shall include all failures, both active and latent, and failures in all components of the system, including mechanical, electrical and hydraulic components.

3.1.3.9.1 Built-In-Test equipment (BIT). The total maintenance aid testing, including BIT, and inflight monitoring where used, shall provide an integrated means of fault isolation to the LRU level with a confidence factor of 90 percent or greater. BIT functions shall have multiple provisions to ensure they cannot be engaged in flight. The test equipment shall not have the capability of imposing signals which exceed operating limits on any part of the system or which reduces its endurance capability or fatigue life. Ground test signals shall not be of sufficient magnitude to drive actuators into hard-stop limits.

3.1.3.9.1.1 Preflight or pre-engage BIT. Preflight or pre-engage BIT may be automatic or pilot-initiated, and includes any test sequence normally conducted prior to takeoff or prior to engagement of a control to provide assurance of subsequent system safety and operability. It should be demonstrated that redundant MFCS electronic channels are operating normally without any safety-critical latent failures prior to takeoff. This includes all backup or normally disengaged channels, and fault monitoring and failure isolation elements. The preflight tests shall not rely on special ground test equipment for their successful completion. Any test sequence which could disturb the normal activity of the aircraft in a given mode shall be inhibited when that mode is engaged.

3.1.3.9.1.2 Maintenance BIT. Where required, BIT shall also be provided as a postflight maintenance aid for the FCS. BIT shall be designed to avoid duplicating test features included as part of the preflight test or monitoring functions.

3.1.3.9.2 Inflight monitoring. Continuous monitoring of equipment performance and critical flight conditions shall be active as a minimum, during essential or flight phase essential modes of operation. False monitoring warnings, including the automatic or normal pilot response thereto, shall not constitute a specific hazard in excess of the system reliability requirements.

DISCUSSION

As flight control systems become more complex, system test takes on greater importance as a means for improving safety, assuring mission success and reducing maintenance costs. Reference 56 suggests methods for reducing unscheduled and no-defect maintenance and inflight malfunctions of FCS used in high performance aircraft such as the F-14. This work was based on the finding that the actuators are the most troublesome FCS components to maintain and present methods of detecting and isolating FCS malfunctions, inflight and preflight, are inadequate.

The total test and monitoring capability necessary for essential and flight phase essential FCS has been defined in terms of two broad categories, inflight monitoring and ground functions (BIT). The rationale supporting two categories lies in the objectives for each. Inflight and preflight functions comprise those tests and monitoring systems necessary to assure compliance with system safety, survivability, invulnerability and reliability requirements called out in 3.1.3.9. Assurance of operational compliance with the ground rules used to determine reliability, safety, survivability, and invulnerability may demand that ways be provided to check operational states. The arrangement and implementation of test and monitoring circuitry, and the equipment or flight conditions checked by the inflight and preflight functions should be selected to ensure compliance with these requirements.

Ground test functions (BIT) are defined in order to achieve an acceptable level of maintainability and may rely on special preconditions or ground equipment to augment the tests. Consequently, in order to avoid significant impact on system reliability through complexity, it is necessary to minimize the equipment dedicated to BIT before reaching the point of diminishing returns where the majority of the BIT-identified faults are malfunctions of the BIT equipment. For this reason, the most feasible comprehensive maintenance aid philosophy is an integration of the capabilities of the inflight, preflight and ground test functions with a prohibition against duplication of functions.

The test and monitoring systems may comprise any one or combination of the following functions:

Continuous In-Line Monitoring - Concerns monitoring techniques incorporated in digital computer software to verify the integrity of that computer.

Tracer Monitor - Used in analog computers to verify that an amplifier or similar circuit will pass a particular test. It can also be used to verify the presence of an a-c excitation voltage.

Status Monitor - Monitors the status signal from another channel or other source.

Comparison Monitor - Commonly called a comparator. Can compare across channels, across voters or a channel to a model.

Sequential Off-Line Monitor - Used to test in-air, off-line subsystems.

Contrails

Standard Comparator - A stimulus of known value inserted into a unit under test and the response compared against a standard.

Logic Test - An interrogation or comparison of logic devices to determine the actual state.

Preflight and Inflight testing and monitoring are essential to safe operation. The functions to be monitored and in part, the monitoring methods, will be the result of analyses and studies to be made along with the system design. Certain requirements or criteria may be established as essential to a safe system. These should include the following:

All active, and most passive failure should be detected,

The comparator limits and trip times should be great enough to prevent nuisance disconnects,

Failure transients should be less than a safe specified g level, see 3.1.3.3.4.,

Noncritical passive failures may be detected by BIT or ground test, and

The system reliability should be high enough to make the probability of two similar critical passive failures virtually nil during one flight.

The capability of the IFM to detect and disengage faults is directly related to flight safety requirements and pilot confidence in the system. An IFM should be capable of detecting

Any failure which degrades performance below the system specification requirements,

Monitoring circuitry failures which could mask failures of functional circuitry, and

Single failures which could cause loss of aircraft control if combined with another subsequent failure.

Additionally, a low nuisance trip rate is desirable if pilot confidence is to be maintained in failure indications. A nuisance trip rate should be selected which,

Assures pilot confidence in the system by not crying "wolf" frequently, or disengaging the system during critical phases of the mission,

Requires selection of failure threshold settings which reflect true primary failures as defined above,

Keeps failure transients from being excessive, i.e., too wide a failure threshold setting, and

Contrails

Keeps the system from always being in a failed state, i.e., too tight a failure threshold setting.

Preflight tests for essential and flight phase essential FCS should be provided to enable the pilot to determine whether or not the safety critical portions of the FCS are functioning properly. It should be demonstrated that redundant MFCS electronic channels are operating normally without any safety-critical latent failures prior to takeoff. Depending on the dispatch rules used in calculating flight safety reliability, the pilot may need to know the operational/failure state channel by channel and axis by axis. This includes all backup or normally disengaged channels. Pilot operated preflight check requirements should be integrated into the FCS, and not require use of ground test equipment. It should be possible to perform preflight tests by manipulation of the following equipment:

The FCS preflight test means of activation.

The aircraft control stick or wheel.

The aircraft control pedals.

The controls on the FCS control console.

Flaps and speedbrake controls, etc.

Results of the preflight tests should indicate to the pilot the proper functioning of the FCS as it may affect system safety. The test provisions should include the capability for determining the integrity of the following:

The control paths between pilot's control input and the aircraft power control units.

MFCS feedback sensors and control paths.

MFCS fault monitoring and failure isolation systems for sensors, electronics, and servosystems.

The manual trim systems.

They should also be able to determine the functional capability of the following in their fail-operational modes:

Electronic computation and control paths to FCS secondary actuators, excluding sensors.

Fault monitoring and failure isolation system for sensors, electronics, and servosystems.

Additional test capability for checking the command limiting and structural protection systems should be provided. The test provisions should be mechanized to enable the pilot to complete all preflight tests in less than two minutes after warmup time. Test equipment should not have the capability of imposing signals which exceed operating limits on any part of the system or which reduce its wear capability or fatigue life.

Contrails

BIT is incorporated in the FCS as a maintenance aid and comprises two major activities:

Maintenance Preflight - A crew chief activated test directed to detection of faults without regard to location and run on internal APU or battery power to avoid engine operation.

Maintenance Fault Isolation - A maintenance activated test directed specifically to maintenance troubleshooting.

Criteria for an operational BIT system should include:

Elimination of Aerospace Ground Equipment (AGE) required in addition to normal flight line AGE to perform preflight and routine maintenance checks,

Elimination of personnel in addition to normal ground crew required in order to perform the BIT operation, and

Testing comprehensive enough to assure safe aircraft mission completion.

Design to provide positive disengagement in flight and personnel and equipment safety during ground operation.

In discussions with airlines maintenance managers, such as at the annual Avionics Maintenance Conference, they indicate mixed feelings about BIT. Many have stated that, in general, BIT is ineffective and has caused more problems than it has solved (too many false alarms); and, in many cases, they are disconnecting the BIT circuits and painting over the bullseyes or removing them to increase reliability. On the other hand, in the case of Category III triple-redundant autoland systems, they find that they need BIT to maintain the complex equipment.

This experience should be seriously considered. It should be recognized that self-test capability will be required on many of the new systems which are evolving, but that it should not be imposed across the board for all systems. In many cases, other methods are adequate, more reliable and more economical. Some BIT systems require circuitry which equals or exceeds the complexity of the circuits being tested and can degrade overall reliability, or reduce effectiveness of the aircraft because of erroneous fault indications.

3.1.4 MFCs design. The following requirements apply. References to mechanical or electrical MFCs apply only when the mechanization is used:

a. Augmentation. When used, augmentation systems shall be compatible with all control modes and airframe dynamic considerations. Single failures in a gain scheduling system, not classed as extremely remote, shall not degrade augmentation system performance below Operational State II. Pilot-operated gain changing devices shall only be used as emergency backup equipment. Specific approval shall be obtained from the procuring activity for this feature. Positive mechanical or electrical stops shall be provided in gain schedulers to preclude exceeding limiting gain values.

b. Ratio changing mechanisms. Where ratio changing mechanisms are used, monitors and emergency positioning means shall be provided if improper positioning can result in a safety of flight hazard.

c. Control centering, breakout forces and free play. The corresponding design requirements of MIL-F-8785 or MIL-F-83300 shall be met. Selected sensitivity and breakout forces shall not lead to overcontrol tendencies.

d. Reversion. If a backup mode is provided for a flight control system at least FCS Operational State III shall be provided following reversion. While disengaged, interaction of backup mode provisions with the normal mode shall not degrade operation below State I. If a single FCS power system is used in an essential or flight phase essential fully powered system, emergency mechanical reversion or an emergency power source shall be provided. On single-engine aircraft, the emergency power source shall be independent of engine operation. It shall be possible to re-engage the normal power source in flight following operation with manual reversion controls or emergency power. Manual or automatic changeover to or from emergency provisions shall not result in capability worse than FCS Operational State III.

e. Controller kinematics. Kinematics shall preclude hazardous unintentional inputs (crosstalk) into one or more axes with normal control motions within the limits of ultimate structural load factor, design maneuver, and turbulence induced accelerations experienced at the crew station.

f. Feedback to crew station controls. The control device motion and force required to accomplish stability and control augmentation shall not be evident at the crew station controls. Vibratory forces or motion acting upon elements downstream of the controller shall not be evident at the crew station controls. Force and motion feedback to crew station controls shall be considered as not evident if the force magnitude is less than half the lowest breakout force of the applicable control.

DISCUSSION

Performance requirements for MFCS are specified in 3.1.1 by reference to applicable specifications and general design requirements to be satisfied by all FCS are defined in 3.1.3.

Where augmentation systems are used, the operation in turbulence requirements of 3.1.3.7 are important considerations and should be considered early in the design process.

The 680-J program (References 49 and 57) investigated the need for multiple modes, one or more of which exists solely for the purpose of providing a backup for the primary mode. The Mechanical Back-Up (MBU) and Electrical Back-Up (EBU) modes included in the 680-J Survivable Flight Control System (SFCS) fall into this category. The MBU mode caused some degradation of the pitch normal mode stability properties at low amplitudes. This was attributed to deadband and friction in the Mechanical Isolation Mechanism (MIM) which shifted the mechanical system in and out. The MBU and MIM were removed for Phase IIB flight test.

Contrails

If an EBU mode is included in a future design it should not be allowed to significantly degrade the normal mode of operation. For some applications, inclusion of either an MBU or EBU would be useless, as in a case where the unstable nature of an aircraft may preclude control with a simple, open loop control system. Unless a clear need for an open loop backup mode can be established, none should be provided in a production system. A better approach would be to strengthen the primary mode at those points where weaknesses tend to justify an EBU.

3.1.4.1 Mechanical MFCS design. In the design of mechanical components, the reliability, strength and simplicity of the system shall be paramount considerations. The signal transmission between the pilot's controls and the control surfaces shall be redundant to the extent required to meet reliability, failure immunity, invulnerability and other requirements of this specification.

3.1.4.1.1 Reversion - boosted systems. In the mechanical version mode, at least FCS Operational State III shall be provided. The normal, boosted, control forces shall provide FCS Operational State I. It shall be possible to re-engage boost following operation with mechanical reversion.

DISCUSSION

These requirements for mechanical MFCS apply only where mechanical implementation is used. The level of mechanical redundancy to be used is determined by failure immunity, reliability, survivability and invulnerability characteristics required for individual procurements.

For fully powered MFCS on multiple engine aircraft, emergency power requirements may be determined by the invulnerability to engine failure requirements of 3.1.9.4.

3.1.4.2 Electrical MFCS design: Electrical flight control systems (6.6) shall be designed with special consideration to invulnerability to lightning strikes and to the thermal, EMI and other induced environments of 3.1.9.3.

DISCUSSION

Major progress in developing Electrical Flight Controls has been made in recent years. Reference 58 discusses integration of hybrid electrical-mechanical systems and presents a somewhat unique design approach to mechanize a hybrid system. This concept features the use of aerodynamic summing to separate the electrical and mechanical signal transmission paths.

Reference 59 describes some of the problems encountered in designing the USA SST control augmentation system. A four channel system using mechanical voting with a separate mechanical backup FCS was used to transmit pilot commands.

References 60, 61, 62 and 12 are among current literature describing advances in Electrical MFCS technology. Reference 12 provides insight into the problems inherent in providing self-test for the complex systems used for

the USA SST. The impact of failure immunity and invulnerability considerations is also described for this application. Reference 61 describes design and flight experience with a digital electrical flight control system on an F-8 aircraft. A sampled data design synthesis example is included which demonstrates the roll of various analytical and simulation methods. This effort revealed that verification of digital flight control software requires an extensive effort, which should not be underestimated. Use of an iron bird simulation was considered indispensable for a development of this nature. A lesson learned, and an inherent consideration in electrical flight control, is the need to replace the slop normally present in a mechanical system with some equivalent electrical deadband in the pilot's input path. Reference 62 makes the point that Control Configured Vehicle and electrical flight control concepts are interrelated and points out increased capabilities obtained with the F-4 flight test aircraft.

Reference 60 concludes that safety and survivability requirements as opposed to mission reliability requirements may dictate the complexity of an electrical MFCS. Problem areas such as sensor accuracy and alignment control and display panel cockpit real estate limitations and lightning strike susceptibility are discussed.

The 680-J program (References 49 and 57) and the American SST program both found the growth of complexity encountered during design of complex flight controls to be a problem. The basic simplicity and pure separation obtained through aerodynamic summing should be seriously considered in the future. A basic recommendation of the 680-J program was to eliminate electronic or mechanical voting in future designs when the aerodynamic configuration permits the use of multiple independent surfaces which provide aerodynamic summing. Recent developments which successfully used a form of aerodynamic summing include the DC-10 and the B-52 CCV flutter mode control system.

3.1.4.2.1 Use of mechanical linkages. If a separate artificial feel system is used, or if mechanical linkages are used to connect a signal conversion mechanism with the control surface actuators, friction and freeplay shall not result in FCS operation below State I. Longitudinal and directional controls shall be mass balanced in the fore and aft direction and lateral controls shall be provided inboard to outboard balance, consistent with structural mode and longitudinal force requirements. Any residual vertical imbalance shall be consistent with feel requirements.

DISCUSSION

Future system designs may utilize a fixed center or side stick or a stick to which the feel mechanism is directly attached. However, if a separate artificial feel system is required it should be located as near to the pilot's control stick as possible to minimize the use of mechanical linkage which produces friction and freeplay. Even so, 680-J program flight testing demonstrated that even small amounts of friction and freeplay located at the stick produce objectionable control system operation and degradation of tracking performance. The design of the electronics is affected by the

friction level since the electrical breakout force designed into the electronics must be equal to or greater than the sum of the feel breakout and friction forces. Flight testing has shown that the pilot has control difficulty due to small amplitude instability, when the airplane responds to controller inputs prior to movement of the controller itself. However, the electrical breakout force cannot be allowed to exceed the mechanical breakout of the feel system by a large margin because the resulting controller motion will appear to have excessive freeplay. The mechanical and electrical breakout should be matched as closely as possible. Tolerances should be specified which assure that the electrical breakout will be the higher of the two. Freeplay can usually be reduced by using precision bearings at the expense of increasing friction. If freeplay producing linkage cannot be avoided, the linkage may be preloaded by springs of a high enough force level to eliminate the freeplay.

Linkage may also be required in some electrical control systems in which it is undesirable to incorporate or integrate the signal conversion mechanism into the surface actuator. The output of the servo control unit would then operate the control surface actuators through mechanical linkage. Again, the amount of mechanical linkage used must be held to a minimum to minimize friction and free-play. If any appreciable amount is used, precision bearings and system preloading again should be considered. At this point in the system, friction and free-play cause increased phase lag during closed loop operation which could result in noticeable small amplitude limit cycling.

If mechanical linkage must be incorporated into the electrical flight control system then inertial balancing becomes an important design parameter which should be considered during the design stages. Inertial imbalance of the mechanical linkage may produce forces which can be felt by the force sensing device of the electronics. All controller mechanizations will require attention to kinematics with regard to applicable vehicle rates, attitudes and accelerations in all degrees of freedom. For example, longitudinal and directional control systems will require mass balancing in the fore and aft direction as well as the vertical direction. Lateral systems would require inboard to outboard balance as well as vertical balance. A stick force and/or position proportional to normal acceleration may be desirable. If so, the feel system should include the desired residual imbalance. See Reference 1 for a detailed discussion of bobweights, control balance and feel. Initial design of future electrical control systems should include a means of altering the mass to provide system balance in the flight test airplane.

3.1.5 AFCS design. AFCS shall be provided to the extent specified by the procuring activity.

3.1.5.1 System requirements. When the specified modes are used, the following design requirements apply.

3.1.5.1.1 Control stick (or wheel) steering. If this mode is required, MIL-F-8785, or if applicable, MIL-F-83300, shall be used as the basis for control capability.

3.1.5.1.2 Flight director subsystem. If common mode selection is used, it shall be possible to select control stick steering with flight director operation in place of any of the other AFCS modes. Single-channel flight director operation shall be possible when all but one channel of a redundant system has failed.

3.1.5.2 AFCS interface.

3.1.5.2.1 Tie-In with external guidance. Internal FCS switching with zero command signal input from external guidance systems shall not cause transients greater than engage transients per 3.1.5.2.3. Noise content in usable external guidance signals shall not saturate or bias any component of the FCS, shall not impair the response of the aircraft to the proper guidance signals, and shall not cause objectionable control motion or attitude variation. Steering information transmitted to the AFCS shall be compatible with the accuracy and dynamic performance requirements of the guidance loop. The tie-in provisions shall not degrade performance of other subsystems by causing excessive loading or saturation.

DISCUSSION

Steering information may be transmitted to the AFCS by analog or digital means. For digital implementations, sampling frequency and number of bits per signal are important compatibility considerations. For analog data links, gain variation and zero shift of the data link should be considered to assure compatibility with guidance loop requirements.

3.1.5.2.2 Servo engage interlocks. Interlocks shall be provided to prevent servo engagement and to provide disengagement in the presence of conditions that render disengagement safer than engagement. Manual override of interlocks shall be provided wherever such override capability will enhance flight safety.

3.1.5.2.3 Engage-Disengage transients. Normal engagement or disengagement of AFCS modes shall not result in transients exceeding the limits set on MFCS engage-disengage transients by MIL-F-8785 and MIL-F-83300. Normal engagement transient requirements shall be met 2 seconds after completion of any maneuver up to the maneuver limits of the aircraft or the limits of sensor equipment being used.

3.1.5.3 AFCS emergency provisions.

3.1.5.3.1 Manual override capability. It shall be possible to manually overpower or countermand the automatic control action of the AFCS using the normal pilot controls. Required pilot forces shall not exceed pilot capabilities as defined by MIL-STD-1472. The overpower force for V/STOL aircraft and helicopters shall not exceed the limit cockpit control forces specified for Level 1 operation in MIL-F-83300. Manually overriding the AFCS shall not result in an instability due to force fight between the pilot and the AFCS.

DISCUSSION

The purpose of manual override capability is to allow the pilot to immediately respond to an unforeseen emergency situation. The typical maximum forces listed below for override are consistent with modern aircraft system practices and have been shown to be substantial enough to prevent inadvertent pilot inputs to the control surfaces during normal automatic system maneuvers.

Single channel AFCS operations (single servo engaged)

Rudder	- 80 pounds
Elevator	- 20 pounds (stick) - 35 pounds (wheel)
Aileron	- 10 pounds (stick) - 20 pounds (wheel)

Redundant channel AFCS operations (servos engaged in a redundant configuration)

Rudder	- 120 pounds
Elevator	- 30 pounds (stick) - 50 pounds (wheel)
Aileron	- 15 pounds (stick) - 30 pounds (wheel)

These forces are also adequately limited to allow pilot-initiated recovery procedures in the event the AFCS misfunctions. The pilot has the option to disengage the automatic system through normal disengagement switches provided, or to override the system and disengage it after the initial recovery maneuver.

Manual override for EFCS ("fly-by-wire") does not necessarily require mechanical means. The electrical command authority of control stick steering or of the basic EFCS may be used to fulfill this requirement.

For override, there is no requirement to provide a force level allowing the pilot to precisely control aircraft altitude or position. It is expected that override will be used to initiate a recovery maneuver followed in a short time by manual disconnect or disengagement of the automatic flight control system.

3.1.5.3.2 Emergency disengagement. Positive emergency means of disengagement, in addition to normal mode selection, shall be provided for AFCS. The emergency disengagement means shall also ground the power input side of the servo engage solenoids. No intervening switching mechanism between the point of ground and the solenoid shall exist.

DISCUSSION

The switching mechanism used should provide a means of positively grounding the power input side of the servo engage solenoids. It is unlikely that the main servo engage power wire(s) will be routed up to the flight deck, then down to the solenoid, particularly on transport or bomber size aircraft. Therefore, the cockpit switches may incorporate further means to remotely apply the ground. Consequently, fail-safe design procedures should be used for any supplementary circuitry to insure the integrity of the emergency disconnect function.

Servo engage-disengage solenoids should not have high engage-disengage voltages or current differentials. For example, a nominal 28-volt D.C. solenoid that engages at 26 volts and disengages at 6 volts is less desirable than one that engages at 18 volts and disengages at 15 volts. The disengage circuit configuration should be carefully designed to avoid the possibility of ground loop voltages, under normal and plausible failure states of any interfacing equipment, causing uncommanded engagement or disengagement. Normal operation includes effects of transients such as lightning currents.

3.1.6 Mission accomplishment reliability. The probability of mission failure per flight due to relevant material failures in the flight control system shall not exceed the applicable limit specified below. Failures in power supplies or other subsystems that do not otherwise cause mission failure shall be considered where pertinent. Each mission to which this requirement applies shall be established and defined by the contractor, subject to approval of the procuring activity.

a. Where overall aircraft mission accomplishment reliability is specified by the procurement activity, $Q_{M(fcs)} \leq (1 - R_M)A_{M(FCS)}$

b. Where overall aircraft mission accomplishment reliability is not specified, $Q_{M(fcs)} \leq 1 \times 10^{-3}$

where: $Q_M(fcs)$ = Maximum acceptable mission unreliability due to relevant FCS material failures.

R_M = Specified overall aircraft mission accomplishment reliability.

$A_{M(fcs)}$ = Mission accomplishment allocation factor for flight control (chosen by the contractor). (6)

DISCUSSION

See discussion under 3.1.7.

3.1.7 Quantitative flight safety. The probability of aircraft loss per flight, defined as extremely remote, due to relevant material failures in the flight control system shall not exceed:

$$Q_{S(fcs)} \leq (1 - R_S)A_{S(fcs)}$$

where: $Q_{S(fcs)}$ = Maximum acceptable aircraft loss rate due to relevant FCS material failures.

Contrails

$A_{S(fcs)}$ = Flight safety allocation factor for flight control (chosen by the contractor).

R_S = Overall Aircraft Flight Safety Requirements as specified by the procuring activity. (7)

Failures in power supplies or other subsystems that do not otherwise cause aircraft loss shall be considered where pertinent. A representative mission to which this requirement applies shall be established and defined in the FCS specification (4.4.2). If overall aircraft flight safety in terms of R_S is not specified by the procuring activity, the numerical requirements of table VII apply.

TABLE VII
FCS QUANTITATIVE FLIGHT SAFETY REQUIREMENTS

		MAXIMUM AIRCRAFT LOSS RATE FROM FCS FAILURES
OVERALL A/C FLIGHT SAFETY REQUIREMENT NOT SPECIFIED BY PROCURING ACTIVITY	MIL-F-8785 CLASS III AIRCRAFT	$Q_{S(fcs)} \leq 5 \times 10^{-7}$
	ALL ROTARY WING AIRCRAFT	$Q_{S(fcs)} \leq 25 \times 10^{-7}$
	MIL-F-8785 CLASS I, II & IV AIRCRAFT	$Q_{S(fcs)} \leq 100 \times 10^{-7}$

DISCUSSION - ANALYSIS CONSIDERATIONS

Reliability and flight safety requirements for the material flight control system (hardware reliability without consideration of pilot errors) are specified on a probabilistic basis for the two operational levels most significant to the aircraft and its weapon system or other function; i.e., flight safety and mission accomplishment.

A similar reliability requirement is included in MIL-F-8785B. A single analysis should satisfy both requirements, although different analysis results will apply to each requirement. Basic differences between the two reliability requirements are:

MIL-F-8785B takes a worst case approach and assumes a maximum mission length and that all failures occur at the critical point in the flight envelope (with regard to flying qualities). Limits are placed on encountering Level 2 and Level 3 flying qualities. No direct requirement is placed on mission accomplishment. See Reference 1 for a discussion of this requirement.

MIL-F-9490D places a requirement on mission accomplishment probability directly. The probability of experiencing a failure is to be considered with the associated probability of being in a flight condition where

Contrails

such a failure is critical. Failures associated with CCV systems, such as ride smoothing, must be considered where the function provided is other than flying quality.

Due to these basic differences in approach to specifying reliability, the numbered values cited by MIL-F-9490D are at least an order of magnitude more stringent than those found in MIL-F-8785 if one compares mission accomplishment to Level 1 flight safety to Level 2. However, the intent of both specifications appears to be similar, and the implementations needed to satisfy the flying quality requirement should be similar to those needed to satisfy the flight controls requirement.

The flight safety analysis should consider all failure modes that threaten flight safety, whether single failures or combinations of failures, and whether extremely remote or not. Likewise the mission accomplishment reliability analysis should consider all failure modes that threaten mission accomplishment, whether single failures or combinations and whether extremely remote or not. It should not be inferred that the probability of aircraft loss due to relevant material failures in the FCS is identical to the probability of experiencing one or more failure modes that degrade performance below Operational State III. Many of the failure modes that degrade performance below State III will be critical only under certain unfavorable combinations of variables such as:

Visibility Conditions

Turbulence Levels

Airspeed or Mach Number

Altitude

Pilot Warning and Reaction Time

Gross Weight

Center of Gravity Location

Thus if a given failure mode will result in aircraft loss only under combinations of the above variables which can reasonably be expected 10 percent of the time, a failure probability of 10^{-7} per mission will contribute an increment of only 10^{-8} to aircraft loss probability. The designer, however, must beware of over reliance on this philosophy. He still has the responsibility to strive to eliminate as many hazards as practicable, regardless of probability and avoid dismissing a potential problem with just the thought, "Oh, that will never happen".

Where criticality varies with mission phase, it is generally necessary to construct a suitable mathematical model for each critical failure mode. In some cases it may be necessary to distinguish between failure modes that are hazardous chiefly at the time of occurrence because they introduce an element of surprise and require immediate pilot reaction, and failure modes that are hazardous chiefly because they leave the system in a degraded condition that makes unusual demands on the pilot's skill in some subsequent mission phase.

Contrails

An FCS Specification should be prepared by the contractor (4.4.2), which includes the intended mission. This definition should:

Clearly distinguish between wartime safety and peacetime safety. Different rules can be expected for operation, dispatch, maintenance, etc.

Define abort criteria if peacetime safety is to be the basis.

To a lesser degree, the same principles may sometimes be applied to the probability of mission failure. A failure mode that degrades performance below State II does not necessarily result in mission failure. All the pertinent variables must be taken into account when computing the increment of mission failure probability that results from a given probability of occurrence of each specific system failure mode.

The fact that a given function is not classed as essential does not necessarily assure that all the failure modes of the associated hardware are noncritical. Such hardware, even if its basic function is not essential, may have dangerous failure modes (hardover, oscillatory, divergent, etc.) that can threaten loss of aircraft. The flight safety analysis must include any such modes, in addition to the various failure modes of hardware performing essential or mission-phase-essential functions.

The flight safety analysis, as well as the mission accomplishment reliability analysis, must take into account the failure modes of monitoring and self-test subsystems, to whatever extent these modes can impact flight safety or mission accomplishment reliability. Also to be accounted for are latent failure modes that might go undetected and so uncorrected, even with operative monitoring and test systems.

Probabilities of component failures should include allowances for normal wearout as well as random failure, unless it is assured that the assembly involved will be subject to scheduled overhauls at intervals sufficiently short to preclude significant wearout. This consideration applies particularly to hydraulic seals, bearings, and other parts that are typically replaced in scheduled overhaul; also to cooling blowers for electronic equipment, particularly if they contain brushes.

Note that survivability and invulnerability are related to reliability but are specified in following sections, in absolute terms rather than on a probability basis.

DISCUSSION - NUMERICAL REQUIREMENT

Concept

Inn a qualitative sense, the probability of aircraft loss to relevant material failures in the flight control systems must be "extremely remote", which is defined as the probability of an event occurring which, although theoretically possible, is not expected in the life of the aircraft. Extremely remote failures are those with a probability of occurrence in the

range of a wing structural failure due to an extreme load condition, seizing or binding of a high-force hydraulic actuating cylinder, or the simultaneous occurrence of two or more statistically independent failures, the individual probabilities of which are very low. For this specification extremely remote is defined (6.6) as numerically equal to $Q_{S(fcs)}$, the specified quantitative FCS flight safety.

Flight Safety Requirement

To provide a means for determining compliance with the requirement, a numerical value must be established. In many cases, a flight safety requirement for the overall aircraft or weapon system, R_S , will be specified and the maximum allowable probability of aircraft loss due to material failures in the flight control system, $Q_{S(fcs)}$, can be established by the contractor based upon the proportion of the maximum allowable probability of aircraft loss, due to all material failures, which is allocated to the flight control system.

A typical division or budgeting of the overall allowable loss rate is depicted in Figure 7D. Using a typical value of $A_{S(fcs)}=0.10$ and assuming a specified flight safety requirement for the overall aircraft, $R_S=0.9999$, then:

$Q_{S(fcs)} \leq (1-0.9999) 0.10 \leq .00001$ losses/flight or no more than one aircraft loss in 100,000 flights due to material failures in the flight control system.

In budgeting the overall allowable loss rate into system allocations, the interdependency of systems must be recognized. For instance, powered flight control systems cannot be separated from the hydraulic and electrical power systems. Where dedicated power systems are used, reliability interfaces must be established and such failures included in the FCS flight safety evaluation.

The numerical requirements specified for use in cases where flight-safety is not otherwise specified are based on actual Air Force field safety experience data, such as documented in Reference 46 and as shown in Appendix A herein, used as follows:

For MIL-F-8785 Class III aircraft, field safety experience data for the B-52, C-135, and C-141 aircraft were examined; and, their major accidents (due to all material failures) in the 1964-1973 time period were reported to occur at rates of 2,145/100,000, 0.846/100,000, and 0.822/100,000 flights, respectively. Of these accidents, 1.365 B-52 aircraft were destroyed per 100,000 flights, 0.363 C-135 aircraft were destroyed per 100,000 flights, and no C-141 aircraft were lost. Although there were no aircraft lost due to material failures in the flight control system, the flight control system failure which resulted in a major accident of a B-52 airplane could easily have been catastrophic, and therefore the combined major accident rate of 0.055/100,000 flights due to material failures in the flight control system was adopted as representative of this class of aircraft.

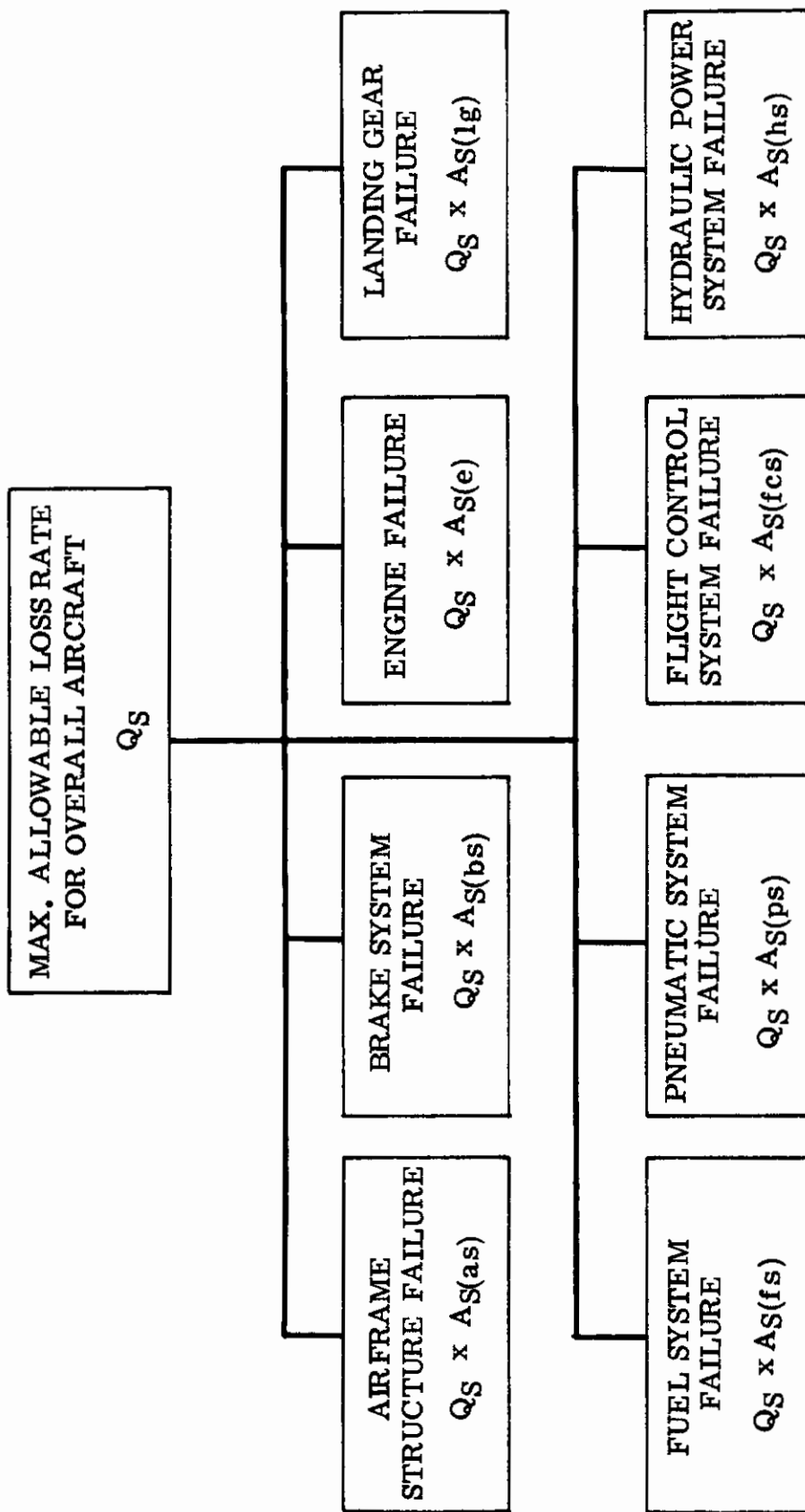

$$Q_S = Q_S \left(A S(as)^{+A} S(bs)^{+A} S(e)^{+A} S(1g)^{+A} S(fs)^{+A} S(ps)^{+A} S(fcs)^{+A} S(hst) \dots \right)$$

Figure 7D. Typical division of overall aircraft allowable loss rate

Contrails

For MIL-F-8785 Classes I, II & IV aircraft, field safety experience for the F-4 was examined, and their major accidents (due to all material failures) in the same 10-year period was found to be 3.158/100,000 flights. Of these accidents, aircraft were lost at the rate of 2.378/100,000 flights. Of these, 0.546 and 0.351 were lost per 100,000 flights due to flight controls and hydraulic systems, respectively, for a combined rate of 0.897/100,000 flights, which was rounded off and adopted as representative of this class aircraft.

The need for a higher degree of reliability for MIL-F-8785 Class III aircraft is self-evident inasmuch as there are often no provisions for evacuating personnel in flight and/or because they are designed to carry nuclear weapons or other stores or equipment which must be recovered if at all possible. At the same time, a higher degree of reliability is usually easier to accomplish because such aircraft are generally larger and can more easily accommodate the additional redundancy required. In addition, the design penalties, weight, and cost for ejection seats or escape capsules, usually provided in MIL-F-8785 Class IV aircraft, are not usually required for Class III aircraft.

For rotary-wing aircraft, field safety experience data for the H-1, H-3, H-43, and H-53 helicopters were examined. Their combined major accident rate (due to all material failures) was found to be 1.826/100,000 flights. Of these accidents, aircraft were destroyed at the rate of 1.345 per 100,000 flights, with losses due to failures in the flight control system and hydraulic power system occurring at rates of 0.192 and 0.096 per 100,000 flights, respectively. These combine for a rate of 0.288 per 100,000 flights.

In calculating the predicted reliability of any given flight control system to show compliance with the stated requirement, it must be recognized that it will not always be possible to determine (on the actual airplane) that all subsystems and components are failure-free and operable at the end of preflight check. In some designs, it may be feasible to check for complete freedom from failure only at longer maintenance intervals. In those cases it will be necessary to design to a higher reliability to compensate for the fact that daily takeoffs may be made with some components or subsystems already in a failure state. See Appendix B for methods of determining reliability increases required to compensate for blind redundancies.

Mission Accomplishment Requirement

In many cases, a mission accomplishment reliability requirement for the aircraft or weapon systems, R_M , will be specified and the maximum allowable probability of mission failures due to material failures in the flight control systems, $Q_{M(fcs)}$, can be established by the contractor based upon the proportion of the maximum allowable probability of mission failure, due to all material failures, which is allocated to the flight control system. A typical mission-accomplishment reliability requirement for an aircraft weapon system might be 0.99 per mission, corresponding to a maximum allowable mission failure rate of 0.01 per mission. For this case, a typical value of $A_{M(fcs)}$, might be 0.10 resulting in a maximum allowable mission failure rate, due to relevant material failures in the flight control systems, of $Q_{M(fcs)} \leq .001$ aborts/flight, or no more than one mission abort in 1000 flights due to material failures in the flight control system.

For other aircraft which are dependent upon a large number of complex onboard equipment to achieve mission accomplishment, such as an airborne warning and command system aircraft possessing a large and complex avionics system, a lower mission-accomplishment reliability requirement such as 0.90 might be appropriate. For this case, however, $A_{M(fcs)}$, might be as low as 0.01 since a much greater proportion of the allowable failures would be allocated to the avionics equipment. However, in this particular example, $Q_{M(fcs)}$ for the flight control systems is again $\leq .001$ aborts/flight (i.e., $Q_{M(fcs)} \leq (0.90)(.01)$).

Therefore, in view of these possibilities, the maximum allowable rate of .001 or 1 mission abort per 1000 flights due to material failures in the flight control system as established for use in cases where a specific mission accomplishment reliability requirement is not specified by the procuring activity.

References 47 and 63 also provide pertinent background information. Reference 47 reports on a study which documents reliability experience on naval tactical aircraft. Reference 63 describes unique features of the B-1 FCS and discusses the flight safety and mission accomplishment reliability budgets established for the B-1 flight control system. The B-1 FCS was designed with an allowable mission failure rate due to FCS failures of 1 per 1034 flights according to Reference 63. References 59 and 12 document the design of the USA SST flight controls. Very stringent reliability goals were adopted for this system and the last prediction prior to SST contract cancellation showed loss rates in the range of 10^{-8} per mission. The design criteria adopted and a discussion of some of the problems encountered is presented. An important conclusion of this development was that reliability calculations are really only applicable to a system that has had the design errors worked out of it. Reliability calculations are useful for determining the better of several design approaches, but they cannot assure safety during the first few hundred hours of flight. The SST development was planned such that reliability of new designs was to be tested in the true flight environment prior to depending on them for safety. This was to be achieved by providing for use of the all mechanical backup control mode during early flights. These flights were to be restricted to light gross weights with a forward cg where augmentation was not mandatory.

3.1.7.1 Quantitative flight safety--all weather landing system (AWLS). The average hazard due to the use of the all weather landing system shall be less than the risk allowed in the contractor's reliability budget for the all weather landing system. To meet the requirements of 3.1.7, the contractor shall allocate the FCS safety budget among AWLS and other FCS. The specific risk of a hazard due to use of the landing system under an environment limit or operational restriction shall not increase the allowed risk by a factor of more than thirty. An alert height shall be established at an altitude such that, with all systems operative at the alert height, the probability of a hazard occurring during the landing is extremely remote, as defined in 6.6.

3.1.7.1.1 Assessment of average risk of a hazard. The average risk of a hazard due to use of the all weather landing system shall be established considering:

- a. The effect of each failure and combination of failures on system performance and the probability of their occurrence.
- b. The effect of each relevant failure and combination of failures in systems operating concurrently with the all weather landing AFCS on aircraft performance and the probability of their occurrence.
- c. The probability of the system not performing within the required levels as specified in 3.1.2.10 taken in conjunction with the probability that exceedance of those performance levels will result in a hazard.

3.1.7.1.2 Assessment of specific risk. For each environmental limitation or operational restriction which limits the use of the all weather landing system, the specific risk shall be established. This evaluation shall comprise the average risk assessment, adjusted for a 1.0 probability of occurrence of environmental limits associated with the operational restriction.

DISCUSSION

An assessment of all weather landing system safety should be compiled to correlate the reliability analyses. The assessment should comprise:

An analysis of the average risk associated with the system.

Analyses of specific risks incurred for unusual or limiting conditions.

A description of assumptions and supporting rationale used to develop the preceding analyses.

The average risks are defined as the risks incurred by using the system under normal operational conditions but during a limited visibility condition. The potential source of these risks are comprehensive since many systems other than the AFCS can cause conditions contributive to a hazard during landing. Thus, the supportive analysis must include the possible contribution to hazard of such diverse systems as the AFCS, the manual flight control system, including the stability augmentation systems, etc.

Malfunction or misfunction of the airborne systems may result in one or a number of incidents such as those appearing in Figures 9D and 10D.

The probability of occurrence of each of these incidents must be determined, considering the likely pilot actions for the required visibility conditions.

Contrails

An incident may occur due to:

The effect of a single failure or combination of failures.

The performance of a failure-free system, i.e., variability of the characteristic system parameter about its average value or operating condition beyond design limits, or just a rather unlikely occurrence.

The effect of a failure combined with poor performance not related to the failure.

Specific risk is defined as the risk incurred whenever the aircraft is operating in a limiting condition, either environmental or procedural, while landing under limited visibility conditions. The specific risk analysis provides the rationale for establishing such limits. The specific risk analysis comprises the same data which formed the average risk analysis, except adjusted to account for the limiting condition, such as an extreme crosswind, or maximum approach speed, and so on. An analysis is required for each limiting condition, taken one at a time. In addition, the analysis may include performance-affecting parameters for which a statistical distribution is not feasible, such as unusual location of the glide slope or localizer transmitter, extreme approach terrain profiles, or worst case combinations of runway gradients.

A complete statement of assumptions and supporting rationale serves two purposes within the context of a system safety assessment. The statistical analysis will be based on statistical data taken using limited exposure times of components and equipment. The exposure times and resulting limited confidence in the corresponding data may substantiate in-flight or ground test procedures or regimen necessary to maintain the basic safety status of the system(s). Occasionally an assumption is established in lieu of definitive data or nonexistent data. As such data becomes available, a more accurate assessment may be made of its impact on the basis for system safety.

Reference 16 describes a logical method of evaluating the safety of a landing system. Figure 8D is a model of the possible outcomes of any approach. It is required that the probability of a hazard due to use of the all weather landing system should be extremely remote. Note that the analysis must reconsider the approach outcome probabilities after executing a missed approach. The outcome tree of Figure 8D may be further subdivided into detailed longitudinal and lateral outcomes as shown in Figures 9D and 10D which show some of the incidents which may be hazardous. Having built up these performance trees, the probabilities of each event must be evaluated to determine the probability of a successful landing as shown in Figures 11D and 12D.

Since not all incidents will result in a hazard, a relationship of incidents/hazards must be assumed. British Civil Air Regulations, paper 367, Issue 3, January 1970, proposed values considered to be representative of past experience and this should be used unless it can be shown that these values are not valid for the procurement aircraft. The incident and ratios assume that the landing facility meets the recommendations of ICAO Annex 14 with regard to the strip surrounding the runway. This extends 200 feet before the

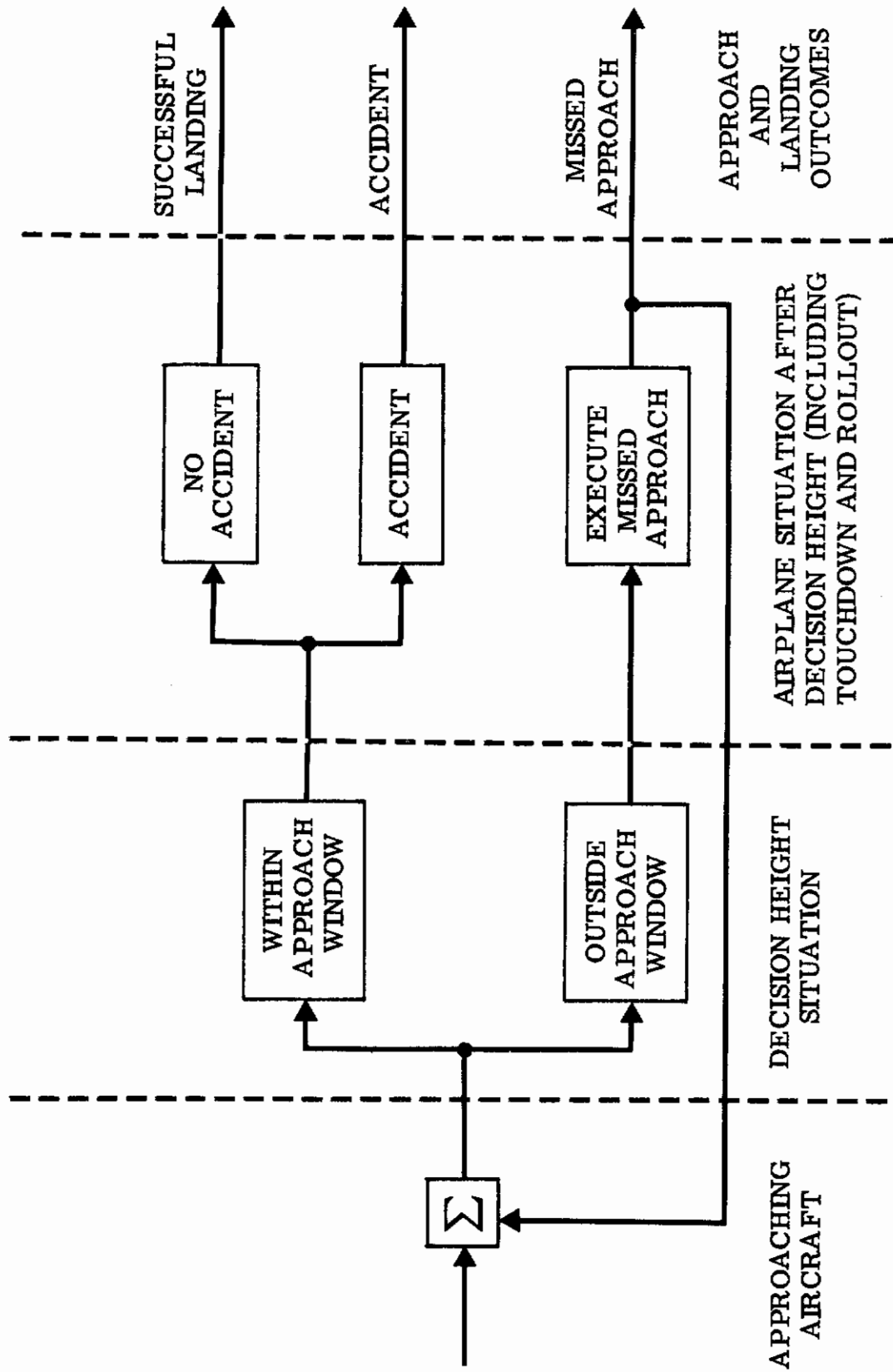

Figure 8D. Simplified version of approach outcome "tree"
(General breakdown of possible approach consequences)

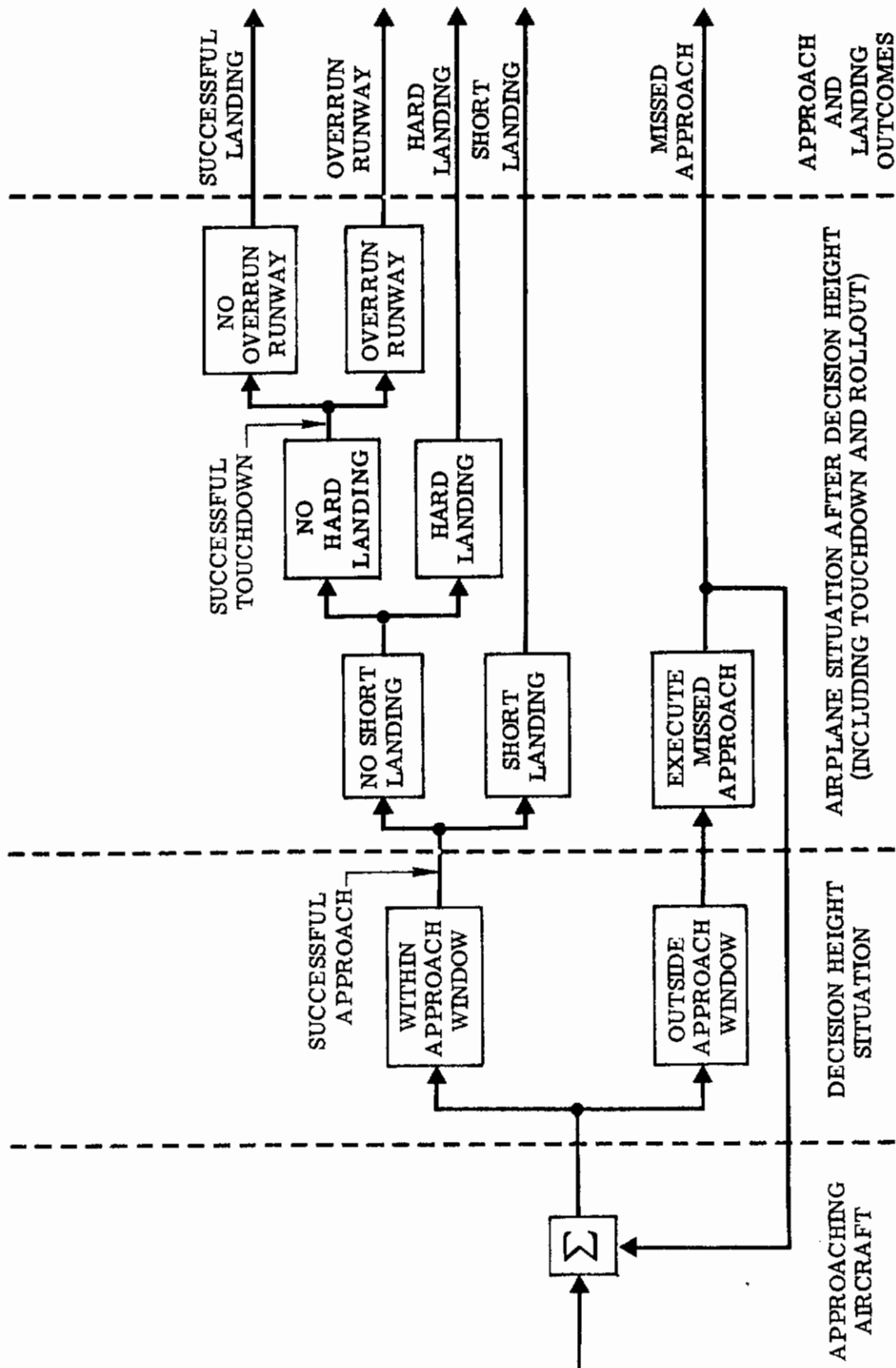

Figure 9D. Longitudinal approach outcome "tree"

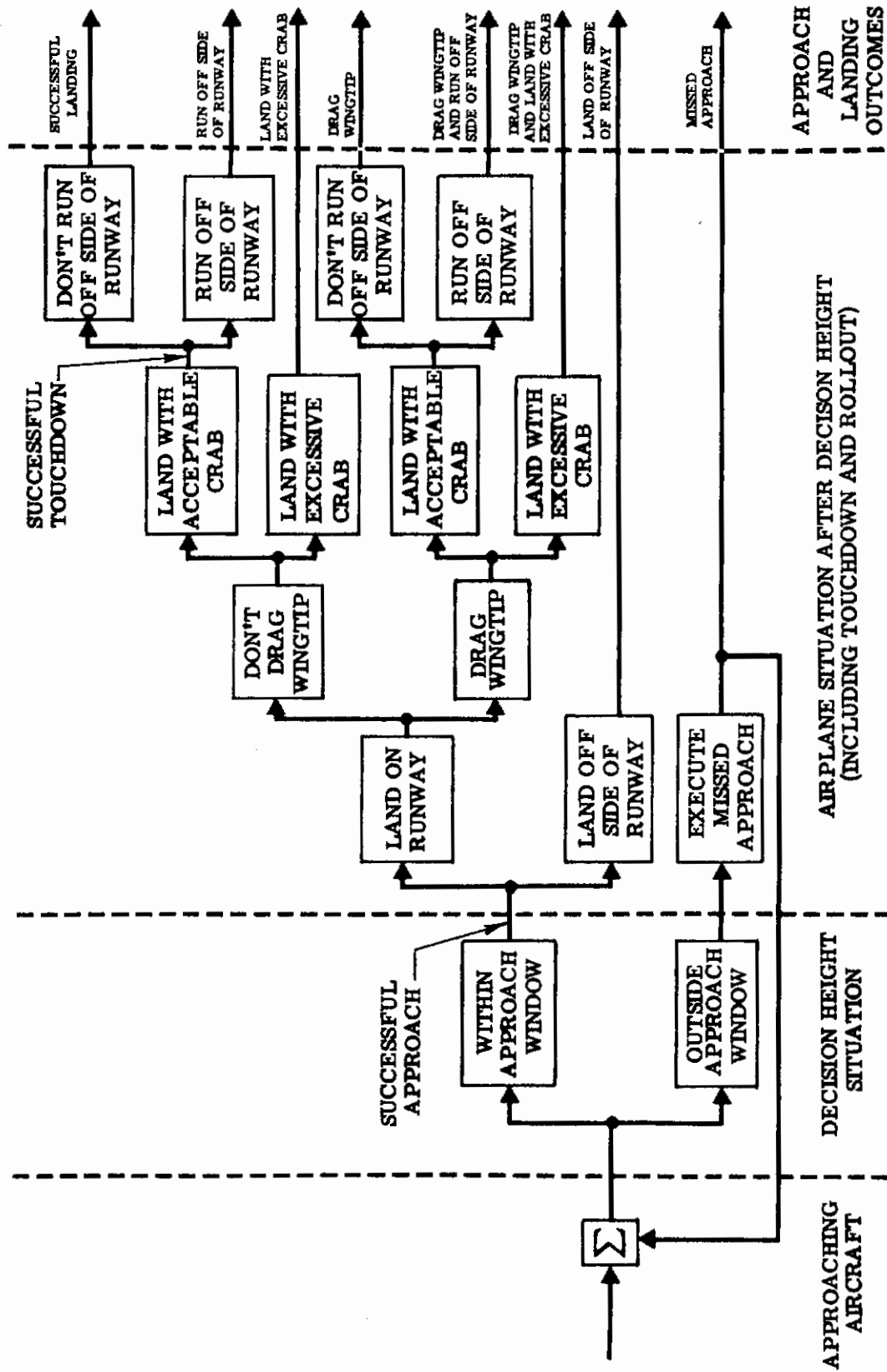
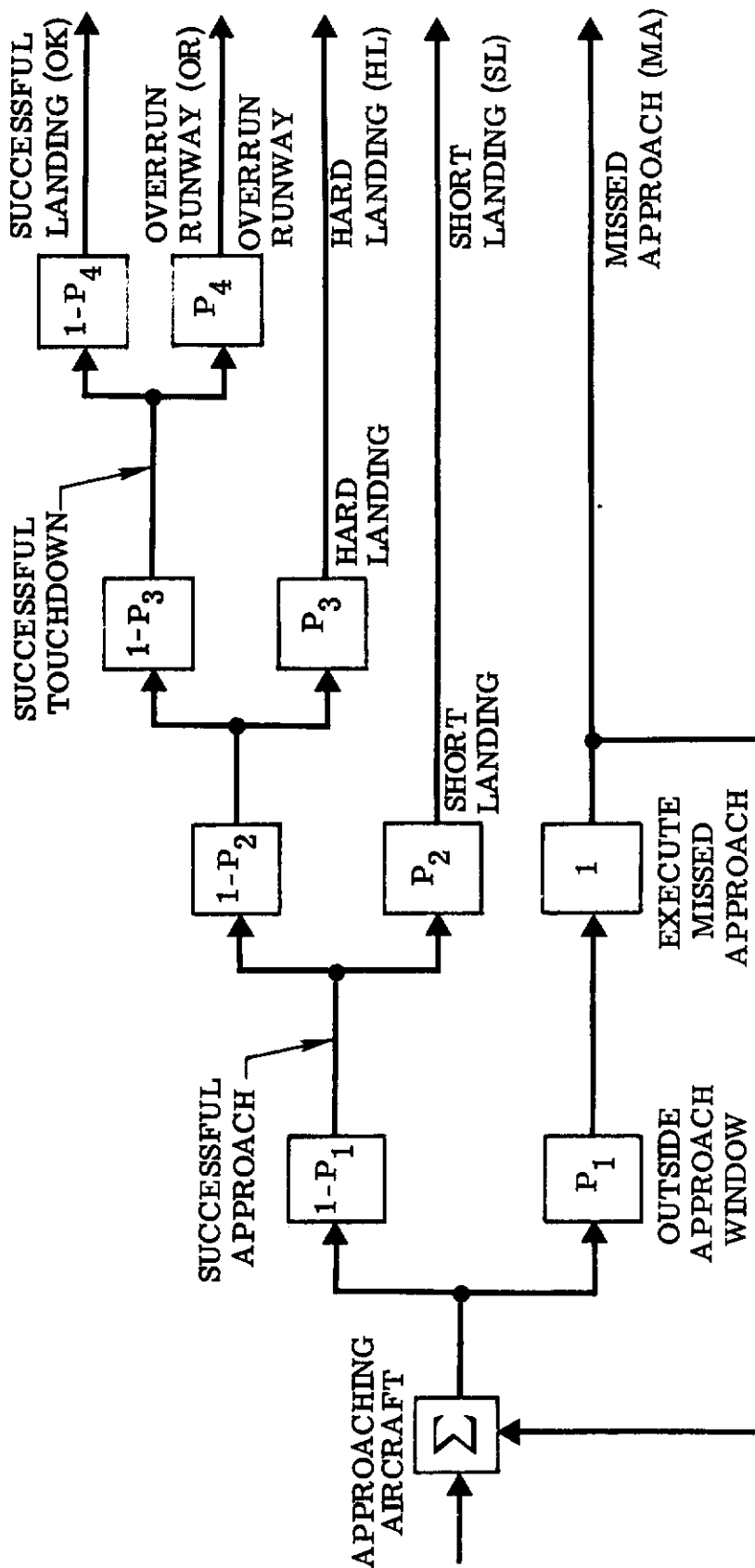

Figure 10D. Lateral approach outcome "tree"



DEFINITIONS

- P_1 = PROBABILITY OF BEING OUTSIDE LONGITUDINAL APPROACH WINDOW
- P_2 = PROBABILITY OF A SHORT LANDING
- P_3 = PROBABILITY OF A HARD LANDING, GIVEN THAT YOU DID NOT HAVE A SHORT LANDING
- P_4 = PROBABILITY OF OVER-RUNNING RUNWAY, GIVEN THAT YOU MADE A SUCCESSFUL TOUCHDOWN

LONGITUDINAL APPROACH AND LANDING OUTCOME PROBABILITIES

$$P_{OK} = (1-P_1)(1-P_2)(1-P_3)(1-P_4)$$

$$P_{OR} = P_4(1-P_1)(1-P_2)(1-P_3)$$

$$P_{HL} = P_3(1-P_1)(1-P_2)$$

$$P_{SL} = P_2(1-P_1)$$

$$P_{MA} = P_1$$

Figure 11D. Longitudinal approach and landing performance "tree"

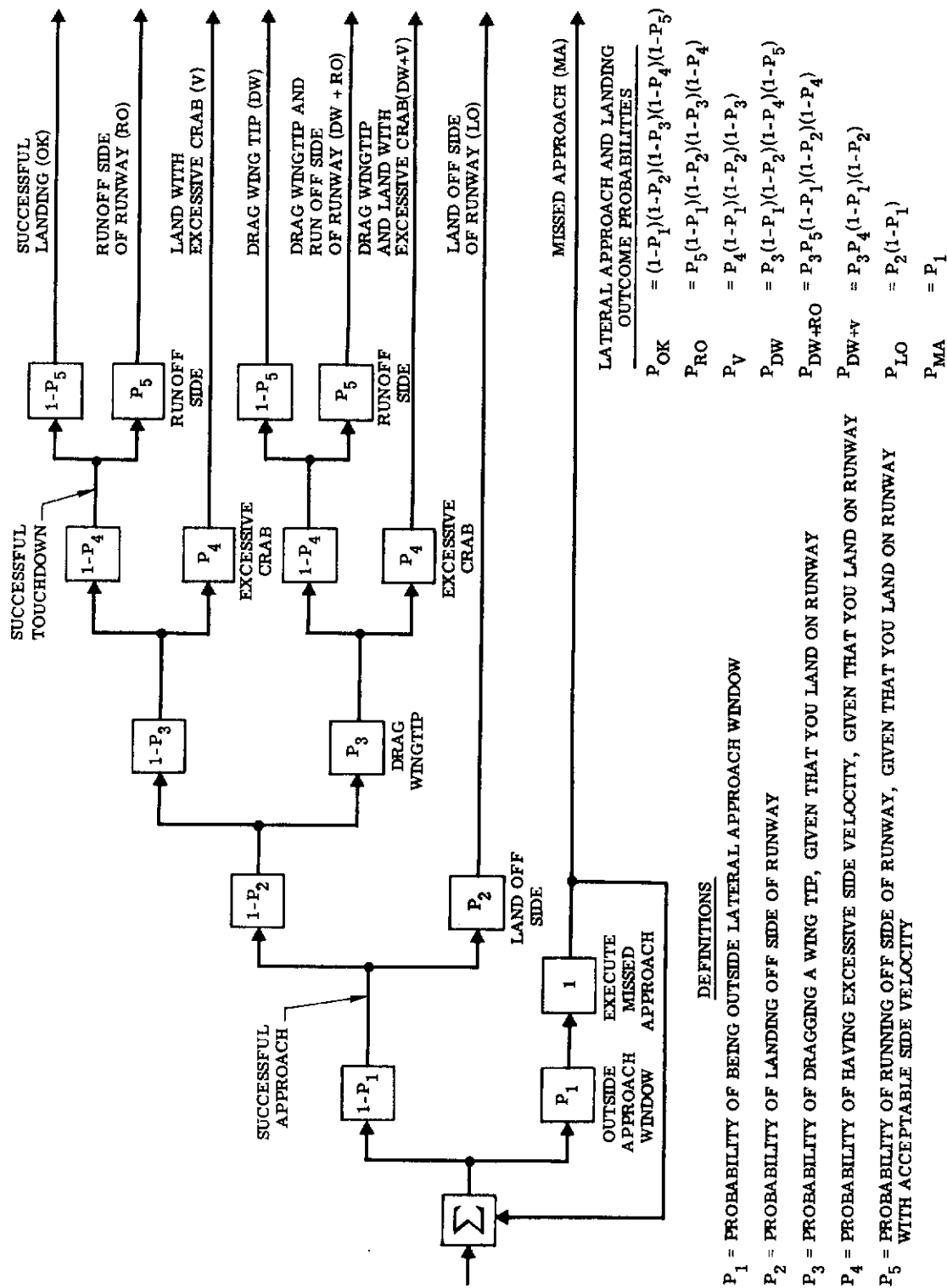

Figure 12D. Lateral approach and landing performance "tree"

Contrails

threshold and to 500 feet on each side of the runway centerline of which 250 feet has a prepared surface, the remainder being clear of obstructions. Where these recommendations are not met, the values given below should be redefined.

<u>INCIDENTS</u>	<u>HAZARD: INCIDENT</u>
a. Overrun runway but not more than 200 feet	1:100
b. Overrun runway more than 200 feet	1:1
c. Hard landing harder than design ultimate vertical velocity	1:10
d. Short landing but not more than 200 feet short of threshold	1:30
e. Short landing more than 200 feet short of threshold	1:1
f. Runoff side of runway but not more than 250 feet from centerline	1:30
g. Runoff side of runway more than 250 feet from centerline	1:1
h. Land with excessive crab, sufficient to collapse gear	1:10
i. Drag wingtip before gear touches ground	1:1
j. Drag wingtip after gear touches ground	0:1
k. Land off side of runway but not more than 200 feet from centerline	1:30
l. Land off side of runway more than 200 feet from centerline	1:1

3.1.8 Survivability. FCS Operational State IV or State V shall be provided as required by the procuring activity.

3.1.8.1 All engines out control. For those aircraft which are dependent upon engine generation of flight control system power, supplementary means or power source shall be provided as necessary to supplement the control power available from the engine(s) where engines are unproven, airframe aerodynamics not established in flight, or windmilling power is insufficient to maintain operational State IV control capability anywhere in the aircraft operational envelope. Flight control system design (including power sources) shall be such that unintentional loss of any or all engine thrust shall not result in less than FCS Operational State IV including any necessary transition to emergency source(s) of power. Provision shall be made for inflight reversion to normal power wherein the transmission shall not result in a worse FCS operational state.

Contrails

DISCUSSION

The foregoing survivability requirements are specified in recognition of the following factors:

That aircraft performance requirements for range, payload, speed, etc., often dictate the need for such lightweight, compact airframes that it is difficult to provide the necessary redundancy and/or spatial separation of subsystems to meet the specified flight-safety requirements.

That such stringent performance requirements also make it difficult to provide the required invulnerability to enemy action.

That supersonic speeds, size, or other factors introduce aerodynamic surface hinge moments of such magnitude that fully powered systems, without provision for revision to mechanical control, are required.

That for some advanced aircraft, the performance requirements are so stringent that state-of-the-art advancements requiring several years of refinement after introduction of the aircraft into service, before attainment of a given reliability requirement can be assured, will be required (e.g., historical experience with such advanced aircraft as the F-100, B-58, and F-111).

The Air Force has recognized these factors, and the development of survivability motor-pump servoactuator ("power-by-wire") units on the ADP 680-J program has demonstrated that practical limited-authority control servos can be incorporated to achieve these survivability requirements. See References 49, 64, 65, and 66. Also, see 3.2.6.5.4 herein for requirements for integrated survivability servoactuators.

It should also be recognized that incorporation of such limits can have major impact upon the design of flight control actuation installations. Therefore, unless otherwise specified by the procuring activity, such units are required only for those aircraft where it is agreed that the design or performance requirements are such that the flight-safety requirements and/or invulnerability to enemy action requirements cannot otherwise be met.

In addition, it should be recognized that the primary intent of the survivability provisions is to provide sufficient control capability for the flight crew and other occupants to survive situations in which the aircraft will usually be lost or suffer major damage; and, where appropriate, to also provide a last-ditch capability to safely recover the aircraft's stores and/or vital equipment. Even with highly advanced, high performance aircraft, the design should be highly resistant to loss due either to random equipment failure or enemy action.

The all-engines-out control requirement is based upon potential economic consequence in loss of aircraft or personnel hazard exposure under certain conditions. All aircraft engine power may be lost from a number of circumstances involving flight envelope expansion of prototype or developmental aircraft, common failure modes or design deficiencies of engines, engine control systems, and inlet ducting, loss of fuel or fuel pumping capability,

Contrails

and lack of engine windmilling power capability, where critical for flight control purposes. It is not the intent of this requirement to arbitrarily require the addition of emergency power source(s) for use in flight to provide Operational State IV capability. It is intended that this minimum control capability requirement be carefully addressed and compliance assured in both aircraft developmental and operational phases. The particular mission or class of aircraft may dictate a better operational state for the flight controls under all-engine-out flight.

This survivability requirement may be satisfied with a standby emergency FCS which provides the control capability to return to base and successfully land the aircraft.

Reference 67 describes a study whose objectives were to determine minimum requirements for backup FCS and to develop a design procedure for synthesizing minimum backup systems.

This study found that pilot-based requirements are not all precisely defined and must be postulated. Hypothesized pilot requirements, called analytical measures of "flyability" and "landability", developed through this study are included therein.

Reference 68 predicts that a requirement for a standby flight control capability will also exist in future equipped with active redundant fly-by-wire control systems. Quadruple (two-fail-operate) identical channels with comparative failure monitoring between channels at various critical points throughout the control path have been proposed to permit completion of the mission after any single failure and successful recovery of the aircraft following a second similar random failure.

However, no matter how complete the design analysis, the circuit protection incorporated, or the physical protection of channels, catastrophic, high-intensity short circuits produced by battle damage or failed electrical components can propagate the failure throughout all identical channels if common points exist. When identical, redundant channels are employed, identical failure modes also may exist. If severe physical or environmental conditions (i.e., temperature, vibration, radiation, shock) are encountered which exceed original design criteria, failure of all redundant channels can result within a relatively short time period. Redundancy is designed to protect against random component failures but little advantage is gained when all channels are simultaneously overstressed.

A questionable major assumption in reliability computational theory is that one failure does not propagate additional failures. While great strides have been made in development of fail-passive electronic designs, completely fail-passive systems do not exist. Murphy's Law is rarely violated! In particular, combat damage greatly increases the probability of multiple failures and high intensity shorts. Also, no fail-passive motion sensors now exist. It is impossible to predict and protect against all conditions and failures to which the aircraft will be subjected. Historical cases for this situation are plentiful and the following are listed as typical examples:

Contrails

F-4 and F-105 Aircraft--Numerous aircraft have been lost to ground-fire due to simultaneous rupture of redundant hydraulic lines at critical points throughout the fuselage and wing where they are routed in close proximity to one another. Design philosophy originally applied to these vehicles considered that these aircraft would not be employed in a combat environment where groundfire could be effective.

X-15, Nr. 1--All electrical and hydraulic power were lost on one flight at the apogee of its trajectory when an experimental electronics unit shorted under cold temperature conditions. One hydraulic APU was finally restarted and the aircraft was recovered with no electrical power available. Circuit protection was installed which should have prevented loss of both redundant electrical systems.

F-111A, Nr. 15--Engine stall resulted in subsequent loss of primary system hydraulics and was very quickly followed by loss of the utility hydraulics which form the reserve system. Difficulty in maintaining control resulted in ejection of both pilots and loss of the aircraft.

X-22--One aircraft was severely damaged when both dual hydraulic tubing runs ruptured almost simultaneously due to fatigue developed from an unexpected resonant vibration condition.

F-14--The first F-14 was lost due to the same cause.

B-52--A B-52 was lost at WPAFB in 1974 due to similar fatigue related dual hydraulic tubing failures. A first failure occurred and crew warning was displayed, indicating loss of fluid in one hydraulic system. The mission was continued and two hours later a similar failure occurred in the second hydraulic system, resulting in complete loss of elevator control. A night landing attempt in poor visibility conditions using stabilizer trim was unsuccessful.

Ideally from the survivability standpoint, the standby flight control system would be mechanized with (1) no parts identical to the normal Manual FCS components, (2) complete independence from the normal FCS, (3) an independent power medium, and (4) physical dispersion and isolation from all normal manual FCS components and transmission elements to minimize the possibility of unpredicted failures or hits from knocking out all means of control. Also, a high degree of versatility for pilot selection of alternate control surfaces (i.e., split surfaces, flaps, spoilers, etc.) is desirable to permit relatively stabilized flight with severe damage to the control surfaces. The key to the success of developing a highly simplified standby FCS is the fact that performance requirements are considerably less in the emergency mode than are the performance requirements for normal mission operation.

It must also be noted that principles of system design for survivability and low vulnerability are often in direct contradiction to principles of good maintenance. For example, good maintenance design would locate redundant elements close together for ease of service checkout, and replacement.

Contrails

Use of nonidentical components between the FCS and the standby FCS to avoid identical failure modes, increases logistics, training and repair problems.

Recommended design requirements for standby emergency flight control systems established by Reference 68 include:

The standby FCS should be the minimum, simplest form of system which will permit recovery of the aircraft, return to base, and landing following loss of the normal FCS due to battle damage or component failures. Adequate control surface effectiveness to maintain trimmed flight and to permit low level maneuvering in the landing zone is assumed. No attempt to complete the mission on standby FCS should be expected. A minimum of two (2) hour flight on standby FCS should be possible.

Complete independence should be maintained between the normal manual FCS and the standby FCS channels. This should include control stick, controller, sensors, actuators, and power supplies (electrical, hydraulic, or pneumatic). A control power medium different from that used in the normal system should be considered.

Standby control system design should be as simple as possible to provide handling qualities of Level 3 or better. Closed-loop control should only be employed if this requirement cannot be satisfied with direct control techniques. Safety aspects which will permit return of the aircraft and crew should predominate over more complex designs having higher performance.

Engagement of the standby FCS should be automatic upon loss of one or more FCS hydraulic pressures. In addition, the pilot should be provided with a switch to engage or override the automatic device if complete normal FCS failure should result due to any other cause or if false switching should occur when hydraulic pressure has not been lost.

Provisions should be included to permit instantaneous, positive control transfer from the normal FCS to the standby FCS or vice versa. Transfer should be accomplished without inducing aircraft transients exceeding structural limits or +2.0 g's whichever is lower due to displacement of the control surfaces from the trim position. To achieve minimum duty cycle, protect against random failures, and provide small sized equipment, the standby FCS should be designed to be flown in the nonenergized state. When not in use, the standby FCS should not interfere or degrade performance of the normal FCS. Physical interface within the cockpit must be minimized. Ejection envelopes must be maintained.

Standby flight control systems should be low-cost, light weight, highly reliable, and easily installed in existing combat aircraft. Electrical, hydraulic, and pneumatic additions and modifications should be held to a minimum. DC electrical power should be the primary electrical source. Field modification of existing aircraft is extremely desirable.

All emergency standby pumps and power supplies should be physically located as close to the actuators as possible to reduce the vulnerability of long transmission runs. All major components of the standby FCS should be protected by armor or located in a naturally protected area.

High temperature transmission elements (tubing, wires, fittings, connectors, etc.) should be installed throughout the system to insure that fires in any area will not result in loss of operation of the standby FCS.

If closed-loop emergency control is required for flight safety, structural filters in the standby FCS control loops should be neglected unless complete structural instability would result. High-gain control loops which would excite the structural modes should be avoided.

Hardover failure of the standby FCS should be monitored (i.e., by means of a 'g' cutoff) to return the aircraft to a safe trim attitude. The design shall be fail-passive where possible so that failure of any part will not result in erratic high-frequency oscillations or hardover commands. Means should be provided to disengage a seized standby actuator which would prevent normal control by the FCS. Slab-lock should be an integral function of the standby FCS, serving as the final emergency mode of operation.

Checkout of the standby FCS should be a normal part of the ground test prior to each takeoff. In addition, cycling of the standby FCS in flight prior to entering a battle zone is suggested.

3.1.9 Involvability. Degradation in flight control system operation due to variations in natural environments, adverse events of nature, induced environments, onboard failure of other systems, maintenance error, flight crew error or enemy actions shall be within the following limits.

3.1.9.1 Involvability to natural environments. Flight control systems shall be designed to withstand the full range of natural environmental extremes established for the particular vehicle or system without permanent degradation of performance below FCS Operational State I, or temporary degradation below FCS Operational State II. Reductions below State I shall be experienced only at adverse environmental extremes not normally encountered and shall be transient in nature only; and, the function shall be recovered as soon as the aircraft has passed through the adverse environment. System components and clearances with structure and other components shall be adequate to preclude binding or jamming, instability, or out of specification operation of any portion of the system due to possible combinations of temperature effects, ice formations, loads, deflections, including structural deflections, and buildup of manufacturing tolerances.

DISCUSSION

Normally, the aircraft specification or contract will define the natural environments or global operational areas in which the aircraft must perform. The AFSC Design Handbook DH 1-5 DN 1C1, Environmental Requirements, describes methods for establishing environmental criteria for specific systems and vehicles. It must be kept in mind that, unless elaborate compensation features are provided in the design, some temporary performance degradation (such as reduced response and increase in force levels at low subzero temperature conditions) will normally occur in most flight control systems when subjected to adverse conditions. This degradation is usually tolerable if temporary, completely recoverable, and FCS operation does not degrade below State II capability. If a specific vehicle is required to operate primarily in a certain combination of adverse environments, such that no degradation below State I capability can be tolerated, this requirement must be specified in the vehicle specification or contract.

Contrails

3.1.9.2 Involvability to to lightning strikes and static atmospheric electricity. Flight control system shall maintain State II capability or better when subjected to electric field and lightning discharges as specified in MIL-B-5087 and in AFSC Design Handbook DH 1-5, except that a temporary, recoverable, more extensive loss of performance to State III is allowable in the event of a direct lightning strike.

DISCUSSION

This requirement takes on added significance as more reliance is placed on electrical means of control in the flight control systems (such as essential use of fly-by-wire, stability augmentation, load alleviation, and/or ride smoothing features), and the possibility of lightning strikes cannot be ignored. Recent history of commercial jet airplane operations indicates that regularly scheduled aircraft experience an average of at least one lightning strike per year.

The problem of providing adequate protection may be compounded by the use of new composite materials and advanced structural concepts in the airframe structure and aerodynamic surfaces which are being developed to save weight and improve life. The use of titanium, stainless steel, bonded structure, and boron/graphite structure introduces new problems in the electrodynamic design areas. Changes in structure electrical conductivity can have adverse electrical effects including loss of effectiveness of the structure as a shield against magnetic and electrostatic fields. The structure may no longer be available to provide suitable antenna ground planes, lightning protection, electrical power ground return, and shielding from induced voltages into critical avionics and flight control systems and interior aircraft components. Electrical compatibility may require additional ground return wire, shielding, conductive coatings, and special joining techniques novel to composite and advanced structure. New materials and structural concepts should be thoroughly evaluated to determine the most effective method of providing electrical compatibility with a minimum weight penalty.

Detecting and avoiding lightning is a simple concept. However, a considerable future development may be required before it can be considered practical for use in a tactical aircraft due to the space and weight requirement of the airborne lightning detection equipment, the nuisance of false alarms, and the compromise of a planned mission imposed by avoiding lightning.

Neutralizing the aircraft is another appealing concept. Statistics on lightning strikes on various aircraft types indicate substantial differences between the number of lightning strikes reported per flight hour for various aircraft types. These statistics indicate that some aircraft configurations are inherently less vulnerable to lightning strikes or that the aircraft configuration is less prone to initiate lightning strikes. Results of future studies of this phenomenon may identify aircraft design features which reduce vulnerability to lightning.

A technique considered most likely to yield satisfactory results is to harden the aircraft to adequately resist lightning strikes which may attach to the aircraft in flight. Potential ways to approach aircraft hardening include:

Contrails

Protection should be provided from lightning-induced transients on electronic flight control interconnect wiring. Large currents resulting from a lightning strike flowing through the aircraft skin can induce significant voltages on adjacent interconnect wiring. To minimize these transient effects, balanced circuits using twisted shielded wires should be used where possible and the wiring should be physically separated from likely lightning current paths. Redundant channels should be physically separated from each other.

Certain air data and aircraft parameters are required as inputs for electrical flight control systems. This information is obtained from probes mounted external on the aircraft. These probes can be damaged by lightning strikes. To prevent damage, lightning diverters can be used to protect the orifices and lightning arrestors can be used to protect the electrical circuits.

Integrity of the electrical power system is required for electrical flight control system operation. Points of entry into the electrical system such as external light wiring and pitot tube heater wiring should be assessed for vulnerability. The wiring can be protected by lightning arrestors located near the point of lightning current entry if required. Power generation and distribution should also be examined for potential susceptibility to transients. If such susceptibility exists, then arrestors should be installed.

To provide confidence that a particular lightning protection system will be adequate, lightning simulation testing should be performed on new aircraft configurations. Scale model tests should be performed to define potentially vulnerable locations on the aircraft where lightning will attach. Components located in these vulnerable areas (e.g., wing tip lights) should be tested for high current and voltage. Consult MIL-E-6051 concerning lightning tests and static electricity. Reference 85, "Final Draft, Aerospace Recommended Practice, Lightning Effects Tests on Aerospace Vehicles and Hardware" prepared by SAE Committee AE4, Special Task F, 1 May 1974, provides a definitive comprehensive guide to lightning simulation and verification testing of aerospace vehicles. This document has wide general acceptance and is expected to be formalized in 1975.

3.1.9.3 Invulnerability to induced environments. Flight Control systems shall withstand the full range of worst case induced temperatures and temperature shock, acceleration, vibration, noise and shock, induced pressures, explosive and corrosive atmospheres, electromagnetic interference (EMI), and nuclear radiation including electromagnetic pulse, projected in missions for the particular aircraft, without permanent degradation or loss of capability to maintain FCS Operational State II capability. These induced environments within structural and crew survival limits shall not result in temporary degradation during the exposure to the environment below FCS Operational State IV capability. The FCS shall meet the requirements of MIL-A-8892, MIL-A-8893, and the applicable requirements of MIL-E-6051 and MIL-STD-461.

DISCUSSION

Unlike natural environments, induced environments usually cannot be specified in the contract or statement of work, but will be dependent upon the design of the particular vehicle, its engines, and its subsystems. AFSC

Contrails

Design Handbook DH 1-5, Design Notes 1B1, Natural and Induced Environments, and 1C1 Environmental Requirements, give considerable background information. In addition to that, there are environments induced by the flight control power systems, operating normally and under partial failure conditions, which must also be considered.

Induced vibrations emanate from aerodynamic and engine acoustic energy impinging on aircraft structure, and from mechanical vibrations of the engine and other equipment. Severe levels can induce malfunctions and fatigue failures in flight control components. All control system elements must be designed to operate satisfactorily without loosening, malfunction, or failure in the vibration environment induced during all required operating conditions for the aircraft.

Some adverse environments induced by the hydraulic power system are: temperature rise due to inefficiencies in the pumps and other parts of the system, pressure impulses produced by the pump (pump ripple) and through waterhammer effect due to rapid opening and closing of control valves, and temperature shock. The latter can cause sticking servovalves which could lead to erratic, or even complete loss of surface control. The most likely cause is the creation of differential fluid temperatures between the two systems in a dual-tandem servoactuator as a result of either a malfunctioning pump in one system or an open relief valve bypassing fluid below the pump cutoff pressure. Thermal shock tests must be set up very carefully to determine if a system is immune to these conditions.

3.1.9.4 Involvability to onboard failures of other systems and equipment. The FCS shall meet its failure state/reliability budget, as allocated within the weapon system, for self-generated failure (within the FCS) and for those FCS failures induced by failures of other interfacing systems within the weapons systems (3.1.6, 3.1.7). In addition, the FCS design shall comply with the following:

a. Essential and flight phase essential flight control systems shall retain FCS capability at Operational State III (minimum safe) or better after sustaining the following failures:

- (1) Failure of the critical engine in a two-engine aircraft.
- (2) Failure of the two most critical engines in aircraft having three or more propulsive engines.
- (3) Failure of any single equipment item or structural member which, in itself, does not cause degradation below State III. This includes any plausible single failure of any onboard electrical or electronic equipment in any subsystem of the aircraft.

b. Flight control systems, including the associated structure and power supplies on Class III aircraft, shall be designed so that the probability of losing the capability of maintaining FCS operation to no less than State IV as a result of an engine or other rotor burst is extremely remote (6.6).

c. Flight control systems, including the associated structure and power supplies on MIL-F-8785 Class I, II and IV aircraft, shall be designed so that the probability of degrading FCS operation below State V as a result of an engine or other rotor burst is extremely remote (6.6).

DISCUSSION

The requirement is included to ensure that hazards due to failure of other systems and equipment are recognized and that adequate measures are taken in the design to ensure that the flight control system is protected from such failures. Most aircraft can survive engine failures, including rotor burst, landing gear tire burst, and failure of other systems such as radio-radar transmitter-transmission line failures. However, with the increased use of full-powered flight control systems, additional care must be taken to ensure that the airplane won't be lost due to failures it could otherwise survive.

Protection from the failure of high-energy system components such as pneumatic cylinders, hydraulic accumulators, and high-force spring cartridges, must be given special attention.

There have been recent instances of crashes caused by flight control system malfunctions resulting from hazards originating outside the FCS. A Caravelle crash resulting from a wheel well fire, causing a total hydraulic failure, and DC-10 crashes, caused by cabin floor collapse following an explosive decompression, are examples.

In addition, electrical flight controls are more vulnerable than conventional flight controls to certain hazards; special emphasis should be placed on the design and tests of EFCS equipment. Examples are:

Modest temperature increases which would not affect a conventional flight control system can cause electronic components to overheat and malfunction. Accordingly, cooling air supply failures must not affect more than one channel of an AFCS computation or sensor capability.

Local fires must not be allowed to propagate through areas of more than one channel of AFCS computation or sensor capability. Both separation and measures to prevent flame propagation are needed.

3.1.9.5 Involvability to maintenance error. Flight control systems shall be designed so that it is physically impossible to install or connect any component item improperly without one or more overt modifications of the equipment or the aircraft. Provisions for adjusting the flight control system on the aircraft, except during initial buildup, major overhaul, or rigging during major maintenance activities, shall be minimized. All line replaceable units (LRU's) shall be designed to permit making internal adjustments only on the bench. The system shall require only a minimum of rerigging following replacement of LRU's. In addition, all control linkages and other flight control mechanisms shall be designed to resist jamming from inadvertent entry of maintenance tools or other material.

DISCUSSION

This requirement is especially important with the increasing complexity of flight control systems and components which tend to increase the potential for serious maladjustment through maintenance error. In general, the first cost due to increased engineering effort and tooling will be somewhat higher than normal to meet this requirement, but the overall costs of maintenance and the probability of failure or loss of performance will be much lower. The concept has been used on some systems on commercial jet airplanes whose overall record of dispatch reliability in day-to-day operations is a very worthwhile goal.

In the study completed in 1972 to document aircraft flight control systems field safety experience with the F-111A, F-4D, C-141, and B-52G/H airplanes, Reference 46, it was found that (of the causes for FCS failure) faulty maintenance actions, while not as numerous as material failures, were equally catastrophic in some instances. In general, maintenance actions that result in accidents or hazards are not as easily corrected through design action. The man who neglects to install a cotter pin or safety wire would probably also neglect to assure the self-retaining bolt was in fact self-retaining or that a self-locking nut was not reused.

However, additional design assurances such as adequate access, caution notes, identification markings, and unsymmetrical installations would help to "deMurphyize" installations and assist maintenance personnel to do the job right the first time. Specific conclusions/recommendations related to maintenance were:

Require irreversible parts for critical applications where reverse assembly or installation results in change in function or in possible interference.

Require that adjacent electrical/hydraulic connections have physical differences so that interchanging connections are impossible.

Require adequate protection be provided for critical components subject to damage during routine maintenance.

Ensure that technical orders and manuals contain adequate warning and caution notes when dimensions or procedures are critical or where malpractice can result in damage to equipment or injury to personnel.

Note that, in addition to the foregoing, requirements for maintenance provisions are specified in Paragraph 3.1.10.

3.1.9.6 Invulnerability to pilot and flight crew inaction and error. Flight control systems shall be designed to minimize the possibility of any flight crew member controlling or adjusting system equipment to a condition state which could degrade FCS operation.

a. Protection against improper position and sequencing of controls-- Wherever practical, cockpit controls, other than stick or wheel and rudder

Contrails

pedals, shall be equipped with positive action gates to prevent inadvertent positioning which can compromise safe operation of the aircraft. Positive interlocks to prevent hazardous operation or sequencing of switches shall be provided.

b. Protection against inflight engagement of control surface locks.

c. Pilot reaction to failure--Flight control systems shall be designed so that the normal pilot reaction to cues provided by probable failure conditions is instinctively correct.

d. Warning requirements--

(1) Warning information shall be provided to alert the crew to unsafe system operating conditions. Systems, controls, and associated monitoring and warning means shall be designed to preclude crew errors that create additional hazards.

(2) A clearly distinguishable warning shall be provided to the pilot under all expected flight conditions for any failure in a redundant or monitored flight control system which could result in an unsafe condition if the pilot were not aware of the failure.

DISCUSSION

Like prevention of maintenance error, the system designer can do much to minimize pilot and flight crew error. The Reference 46 study summarized that flight crew actions were involved in only a small number of failure case histories. However, the following significant recommendations were drawn:

Require positive interlocks to prevent hazardous operation or sequencing of switches.

Require that positive warning cues be provided when the pilot is required to maintain his head "out-of-cockpit" during maximum maneuvering situations. Consider use of head-up displays.

Require that a loss-of-control prevention device be incorporated in aircraft that are not highly resistant to departure from controlled flight.

Ensure that the flight test program adequately identifies near-stall/stall/post-stall characteristics.

Require positive stick centering as outlined in MIL-F-8785 after modification as well as during initial design.

Require that all cockpit controls be equipped with positive action gates to prevent inadvertent positioning which can compromise the safety and operation of the aircraft. An example is an idle cutoff detent on throttles.

Require cockpit instrument illumination level compatibility be demonstrated in a simulator or by other means.

Contrails

One example where interlocks may be needed to prevent hazardous operation involves variable geometry controls. Redundant interlocks should be used to prevent inadvertent actuation of control systems that would produce structural damage, if actuated. For instance, flap actuation with wings swept must be prevented.

The intent of this warning requirement is to provide crew warning where a hazard cannot be otherwise avoided. Warning lights should not be used as a substitute for adequate FCS design.

3.1.9.7 Invulnerability to enemy action. Essential and flight phase essential flight control systems, including associated structure and power supplies, on all aircraft designed for combat operations shall withstand at least one direct encounter from the threat defined by the procuring activity without degradation below Operational State III.

DISCUSSION

F-105 losses in North Vietnam and Laos have been documented and type of threat responsible for losses and the type of system damage responsible for these losses has been recorded. Due to unacceptably high losses due to flight control system damage, this requirement has been adopted for future procurement.

This requirement establishes the minimum protection required for all aircraft designed for combat operations. Adequate redundancy, alternate controls, separation, shrouding, and/or armour protection should be used to prevent degradation below the specified performance level. See Reference 69 for discussion of gunfire tests on airplane flight control servoactuators. Reference 70 provides design guidance for protecting hydraulic systems from ground fire, and also lists other pertinent documentation. AFSC Design Handbook, DH2-7, also provides guidance information.

3.1.10 Maintenance provisions. FCS design and installation shall permit normally available maintenance personnel to safely and easily perform required maintenance under all anticipated environmental conditions. Means shall be provided to facilitate the accomplishment of all required maintenance functions including: operational checkouts, system malfunction detection, fault isolation to the LRU (line replaceable unit) level, LRU removal and replacement, inspection, overhaul, servicing, and testing.

3.1.10.1 Operational checkout provisions. Flight control systems shall be designed with provisions for operation on the ground, without operating the main engines, to verify system operation and freedom from failure to the maximum extent practical. They shall be designed to operate with the power generation subsystems supplied by standard Air Force ground carts, as specified by the procuring activity or by self-contained power supplies.

3.1.10.2 Malfunction detection and fault isolation provisions. Means providing a high probability for detecting failures and monitoring critical performance conditions as required to isolate faults to the LRU level shall be incorporated in all flight control electrical and electronic systems

Contrails

required to perform essential and flight phase essential functions. These means may include cockpit instrumentation and built-in test equipment. For the mechanical and fluid power portions of the flight control system, provisions for the use of portable test equipment may also be incorporated as required to meet the maintenance support and operational concept of the particular weapon system.

3.1.10.2.1 Use of cockpit instrumentation. Where acceptable procedures result or are provided, cockpit instrumentation may be used for malfunction detection and fault isolation where it provides readily understandable condition indication either alone or in coordination with built-in test equipment, or with portable test equipment (for nonelectrical and nonelectronic components).

3.1.10.2.2 Provisions for checkout with portable test equipment. Where the use of built-in test equipment would cause excessive penalties and where the use of portable test equipment is compatible with the maintenance support concept, provisions shall be made to permit the use of generally available and commonly used portable test equipment. Components which require peculiar, special, or new items of test equipment shall be avoided.

3.1.10.3 Accessibility and serviceability. Components shall be designed, installed, located, and provided with access so that inspection, rigging, removal, repair, replacement, and lubrication can be readily accomplished. Suitable provisions for rigging pins, or the equivalent, shall be made to facilitate correct rigging of the control system.

3.1.10.4 Maintenance personnel safety provisions. Systems and components shall be designed to preclude injury of personnel during the course of all maintenance operations including testing. Where positive protection cannot be provided, precautionary warnings or information shall be affixed in the aircraft and to the equipment to indicate the hazard, and appropriate warnings shall be included in the application maintenance instructions. Safety pins, jacks, locks, or other devices intended to prevent actuation shall be readily accessible and shall be highly visible from the ground or include streamers which are. All such streamers shall be of a type which cannot be blown out of sight such as up into a cavity in the aircraft.

DISCUSSION

Successful operation of an aircraft and its flight control system is highly dependent upon the ability of the service personnel to effectively maintain it in the fully operational condition. The foregoing requirements emphasized that the features which allow effective maintenance must be designed into the system to provide service personnel the means for safe, speedy detection, location, and correction of faults, and the accessibility necessary for preventive and corrective maintenance and for part removal and replacement.

Functional Checkout Provisions

The need to provide direct, easily accomplished capability for checking the system's operational status on the ground without operating the main

Contrails

engines is self-evident. However, full performance need not be demonstrated if system condition and freedom of failure adequate for safe completion of all operational modes can be satisfactorily demonstrated. Therefore, it will usually not be necessary to supply hydraulic flow from the ground cart, APU, GPU, etc., at the full system design flow rate. Also, it is recognized that it is impractical to verify the condition of engine driven pumps, generators, and associated components and circuitry without running engines.

Malfunction Detection and Fault Isolation Provisions

The specified requirements emphasize that the means to detect failures and isolate faults to the LRU level in essential flight control electrical and electronic systems must be incorporated into the basic onboard equipment. However, these functions are not necessarily required in flight. It is also recognized that such a requirement often cannot be met with practicality in the mechanical and fluid power portions of the system, and that provisions for checkout with portable test equipment should be made with recognition of the problem in keeping the test equipment current with airplane changes.

Careful attention to detail circuitry is required early in the design phase in order to satisfactorily incorporate the necessary built-in test equipment.

Accessibility and Serviceability

In addition to the specified requirements, the design of mechanical controls should be such that removal and replacement of components, including the control surfaces, can be accomplished without disturbing the rigging insofar as possible. Special tools required for installation and rigging of the control systems should be kept to a minimum and be in accordance with the applicable specifications. Care should also be taken to avoid installation of items which may require replacement in areas where removal and reinstallation is extremely difficult, such as torque tubes buried in wings.

Maintenance Personnel Safety

It is incumbent upon the design organization to ensure that all components and systems are designed and installed to allow maintenance without significant hazard to the service personnel. It must be recognized that some hazards cannot be avoided or eliminated altogether, and that precautionary warnings must be attached to or adjacent to the actual components and be included in the maintenance procedures and instructions.

In the flight control system, two of the most hazardous areas of concern to the maintenance personnel are:

The inadvertent release of stored mechanical, hydraulic, pneumatic, or electrical energy; i.e., from springs, air-oil accumulators, air bottles, charged capacitors, etc., which can be hazardous even with system power sources turned off.

Inadvertent motion or excessive rate of motion of control surfaces or control and power actuators both within the flight control system and in other systems using the same power sources, such as for the actuation of wheel-well or weapon-bay doors.

Contrails

All devices which contain any type of stored energy (such as mechanical, electrical, hydraulic, or pneumatic), or which can produce energy capable of causing injury to maintenance personnel, should be provided with positive means of disconnecting the source of energy, or allowing controlled release of the energy, or preventing inadvertent energy release.

In addition to using safety pins, locks, or other devices to prevent inadvertent actuation of other systems, all flight control system checkout and test provisions should be designed with personnel safety in mind. During actual performance of such functions, close coordination between personnel operating cockpit controls and others observing system operation must be maintained. Other maintenance functions which could possibly be in conflict should be prohibited at the same time, and all personnel should be kept clear of control surfaces to prevent being knocked off balance or otherwise injured.

3.1.11 Structural integrity.

3.1.11.1 Strength. The overall flight control systems shall be designed to meet the applicable load, strength, and deformation requirements of MIL-A-8860, MIL-A-8861, MIL-A-8865, MIL-S-8698, and MIL-STD-1530. The components of the systems shall be designed in accordance with the strength requirements of MIL-A-8860, MIL-C-6021, MIL-F-7190, MIL-A-21180, MIL-A-22771, MIL-F-83142, MIL-HDBK-5, and MIL-HDBK-17.

3.1.11.1.1 Damage tolerance. Those structural elements of the flight control system that are essential to safety of flight (to control essential and flight phase essential functions) shall meet the damage tolerance requirements of MIL-A-83444.

3.1.11.1.2 Load capability of dual-load-path elements. The load path remaining after a single failure in dual-load-path elements shall meet the following requirements:

a. Where the failure is not evident by visual inspection or by obvious changes in control characteristics, the remaining path shall be capable of sustaining a fatigue spectrum loading based on one overhaul period. The time interval corresponding to an overhaul period shall be established by the contractor. The remaining path shall also withstand, as ultimate load, loading equal to 1.5 times the limit loads specified in MIL-A-8865, or 1.5 times the limit loads specified in MIL-A-8865, or 1.5 times the load from an alternate source such as a powered actuation system or loads resulting from aerodynamic or other forces, if such load is greater.

b. Where the single failure is obvious, the remaining load path shall be capable of withstanding, as ultimate load, loading equal to 1.15 times limit loads specified in MIL-A-8865, or 1.15 times the load from an alternate source, such as a powered actuation system or loads resulting from aerodynamic or other forces, if such load is greater.

DISCUSSION

These are basic requirements for aircraft design. Additional information and guidance can be found in AFSC Design Handbook DH2-1, Design Note DN 2A1: Strength and Rigidity. In addition, it is incumbent upon the design

organization to exercise great care in application, design, and in due regard for plausible misfeasance in use to assure that no parts of the system or components may be subjected to operation, either intermittently or continuously, at loads greater than for which the part has been designed.

The essence of these requirements is that the design of structural elements of flight control systems shall be such that, in the event of failure of a single principal element, the remaining structure shall be capable of sustaining operational loading without endangering flight safety. Fail-safe design can be achieved in a number of ways, including the following, to provide adequate residual strength for repeated loads following initial failures:

By multiple load path structure.

By use of multiple structural members to prevent crack propagation beyond given boundaries.

By apportioning structure to ensure that undetectable cracks do not become unstable between inspection intervals.

The use of dual-load path configurations in the design of structural and mechanical elements in essential subsystems has been standard practice for commercial jet airlines for many years. The safety factor of 1.5 specified in 3.1.11.1.2.a for load paths in which failures are not easily detected, is the same as required for single load path structure. The factor of 1.15 specified in 3.1.11.1.2.b for load paths in which failures are easily detected, is to provide a reasonable margin for dynamic effects which may be caused by a failure in the redundant load path. However, it is assumed that the failed part will be replaced before accumulated fatigue damage becomes a significant factor.

3.1.11.2 Stiffness. The stiffness of flight control systems shall be sufficient to provide satisfactory operation and to enable the aircraft to meet the stability, control, and flutter requirements as defined in the applicable portions of MIL-F-8785, MIL-A-8870, MIL-F-83300 and MIL-A-8865. Normal structural deflections shall not cause undesirable control system inputs or outputs.

DISCUSSION

It is required, as specified in MIL-A-8870, that aircraft construction, materials, and design shall be such that there will be no flutter, buzz, divergence, or other dynamic aeroelastic, aerothermoelastic, or aeroservoelastic instabilities of the airplane or its components at all speeds up to $1.15 V_L$ for all design ranges of altitudes, thermal conditions, and maneuvers where losses in rigidity (stiffness) may occur, and at all weights, external store configurations, and other loading conditions. Assurance of compliance is required by analytical or experimental data (including flight test data up to limit speeds), or both, that an increase of 15 percent in equivalent airspeed at all points on the limit speed envelope of the airplane, both at constant Mach number, and separately, at constant altitude, will not result in flutter, buzz, divergence, or other dynamic aeroelastic, aerothermoelastic, or aeroservoelastic instabilities.

Contrails

Detail design requirements are specified in MIL-A-8870 and include the following which are quoted whole or in part with minor modifications as deemed necessary to avoid misunderstanding:

Augmentation systems. For airplanes with augmentation systems, the specified flutter margins and damping requirements must be met both with the system operative and with it inoperative. If augmentation is essential to safety of flight, augmentation-off flight tests cannot be performed in the portion of the flight envelope where its function is essential.

Fail-safe stability. Aircraft must be free from flutter, divergence, or other aeroelastic instabilities at all speeds up to V_L following any of a specified list of failures, malfunctions, and adverse conditions plus any other probable single failure, malfunction, or adverse condition affecting flutter or divergence. The specified list includes "failure, malfunction, or disconnection of any single element of the main flight control system, augmentation systems, automatic flight control systems, tab control system, or in any flutter damper connected to a control surface or tab." "Detail design shall be such as to provide multiple load paths to eliminate critical single failures, or as a minimum, the design should provide a safe life of critical elements. With such a failure, the damping coefficient, g , shall be at least 1 percent (0.01) for all critical flutter modes at all altitudes and speeds up to V_L ."

"Variable geometry airplanes. Airplanes having variable or movable geometry such as tilt wings, variable sweep, variable dihedral, rotary airfoils, and pivoting stores shall be designed to preclude flutter. Free play in pivots and joints and the aerodynamic interaction between lifting surfaces in close proximity shall be included in flutter-safety evaluations."

"Control surface and tabs. Each control surface or tab shall be either mass balanced or ... restrained ... to preclude flutter in all critical modes, under all flight operations, for both normal and emergency operating conditions of the actuating system. The adequacy of mass balance or stiffness shall be established by flutter analyses or model tests."

In MIL-A-8870, it is stated that the surface or tab be mass balanced or "made irreversible by sufficiently high stiffness and compliance with free-play requirements to preclude flutter ...". It should be noted, however, that the stiffness requirements can be met by using force servos or control surface locks (which engage upon failure of the actuation system to function) as well as by using so-called irreversible (position) servos.

In addition, MIL-A-8870 also states that, "In determining the adequacy of the stiffness, the rigidity (stiffness) of all actuating elements, the rigidity (stiffness) of the control surface or tab shall be included. In addition, rotational freeplay of the tabs and control surfaces shall be less than or equal to that specified in 3.2.7.3.1 (Freeplay of Irreversible Control Surfaces) and 3.2.7.3.2 (Freeplay of Irreversible Tabs) throughout the service life of the airplane."

Controls

Control surface balance is also important for minimizing control forces and maintaining stability. The three important balance considerations: aerodynamic, static, and dynamic balance, are discussed in some detail in AFSC Design Handbook DH 2-1, Design Note 3B2; Control Surfaces.

"Hydraulic dampers. In the event that mass balance or irreversibility is impracticable, hydraulic dampers may be used for the prevention of flutter. Flutter analyses or flutter model tests shall be performed to assure that the obtainable damping is sufficient to prevent flutter. The rigidities (stiffness) of the damper elements and the supporting structure to which the elements are attached shall be sufficiently high to preclude loss of damper effectiveness by structural deformation (deflection) at the flutter frequencies. The freeplay of the damper shall not exceed that specified in 3.2.7.3." (In MIL-A-8870).

"Single-degree-of-freedom flutter of control surfaces. Flutter, such as control surface buzz, shall be prevented by providing control surface torsional and rotational rigidity (stiffness), by use of hydraulic dampers, by use of aerodynamic configurations which are not susceptible to this phenomenon, or by a combination of these means. In airplanes whose V_L equals 0.8 Mach number or greater, space, rigidity (stiffness), and strength shall be provided for incorporating hydraulic dampers in anticipation of their use.

"Other controls and surfaces. When not displaced from the retracted position in flight, flaps extending outboard of the 50 percent span station of the main surface shall, if practicable, be rigidly locked in the retracted position. Airplane components which may be exposed to the airstream and which can be important with respect to flutter (including, but not limited to, trailing edge flaps which are impracticable to lock; dive brakes; spoilers; scoops; leading edge flaps; and fixed, retractable, or jettisonable ventral fins) shall be made free from flutter by suitable mass balance, hydraulic dampers, structural rigidity (stiffness), or irreversible control systems. The irreversibility criteria for control surfaces specified in 3.2.7.3 shall be applicable. In cases where mass-balanced reversible spoilers are employed, coincidence between the spoiler rotational natural frequency and low natural frequencies of the main supporting structure shall be avoided in order to prevent objectionable, lowly damped, gust-excited oscillations."

3.1.11.3 Durability. Flight control systems shall be designed to meet the durability requirements of MIL-A-8866 and equal to that of the airframe primary structure considering the total number of ground and flight load cycles expected during the specified design service life and design usage of the aircraft from all commands; e.g., from the MFCS, AFCS, servo feedback and from load inputs. The requirements of MIL-A-8892 regarding vibrations and MIL-A-8893 regarding sonic fatigue also apply to the FCS.

DISCUSSION

These are basic requirements for aircraft design, and it is especially important that all essential and flight phase essential components comply.

Contracts

As stated in MIL-A-8866, "The procuring activity shall specify the design service life and design usage. Where structural capabilities are provided by the contractor beyond that specified by the procuring activity, these additional capabilities shall be included in the design usage, and the design service life shall be maintained and so stipulated in the contract specification. The design usage shall be based on the mission requirements of the weapon system and shall stipulate the average usage per fleet airplane in terms of:

Total Flight hours.

Total number of flights.

Total number and type of landings.

Total service years.

Mission profiles for each type of mission including training flights to be flown. These profiles shall be divided into the mission segments according to operational segments (i.e., climbout, cruise, inflight refueling, low-altitude penetration, air-to-air combat, air-to-ground combat, etc.). The mission profiles shall also stipulate the approximate duration, altitude, airspeed, and payload configuration requirements for each mission segment.

Number of flights of each mission.

Proportion of low altitude usage (other than for takeoff and landing operations) between highest obstacle clearance, terrain following and contour flying, and their respective terrain clearance requirements.

Definition of the terrain roughness models and the number of terrain following and contour flying flights for each model or definition of the low altitude routes and the number of flights for each route.

Terrain following maneuver load factor authority (automatic terrain following mode) requirements".

From this information, the contractor can define the number of flight load cycles to be expected during the lifetime of the aircraft; and, with a design fatigue-scatter factor, as defined in MIL-A-8866, the number of fatigue flight loading cycles required for design can be determined. In addition, the accumulation of load cycles during ground checkouts prior to flight and during troubleshooting maintenance operations must be accounted for. Components and other elements subjected to loads from hydraulic actuators bottoming under full system pressure can accumulate significant fatigue damage during such operations. Note that fatigue life requirements may be more stringent than wear life requirements inasmuch as replacement or rework of parts subject to wear is allowed. (See 3.1.12)

3.1.12 Wear life. Mechanical elements of the FCS shall be designed to have wear life equal to the wear life specified for the overall aircraft. Parts subject to wear, such as hydraulic seals, bearings, control cables, sensors

Contrails

and hydraulic actuator barrels, may be replaced or their wearing surfaces renewed after they exceed their useful life. However, all replacements shall be within the FCS wear out-replacement budget established for the overall weapon system. Electronic and other nonmechanical LRU's shall remain economically repairable and shall meet reliability requirements throughout the specified airframe lifetime.

DISCUSSION

This requirement parallels that of 3.1.11.3 for fatigue life in that the wear life of the flight control system and its components must also meet the requirements specified for the primary aircraft structure. Predictions of the number of operating cycles and their load and stroke distribution should be based in large part on preflight, taxi, and flight test experience with similar aircraft. It must be recognized that the elements of the system which are commanded by the stick or wheel and rudder pedals will usually receive the bulk of the long-stroke cycles, the elements commanded by the AFCS and stability augmentation systems will usually receive the bulk of the short-stroke cycles, and that many elements will receive all the commands. In order to develop adequate designs and conduct meaningful tests, life cycle predictions for each portion of the system must be made and a budget established for wear life of all FCS parts.

Electronic and other nonmechanical components wear life (useful life) should also be defined in cost effectiveness terms for a particular weapon system. For example, a criterion might be: FCS components shall not require parts replacement maintenance in excess ___ percent of the original cost basis throughout the airframe lifetime.

3.2 Subsystem and component design requirements.

3.2.1 Pilot controls and displays. Wherever an FCS control, display or annunciator is interfaced with redundant flight control channels, mechanical and electrical separation and isolation shall be provided to make the probability of common mode failures at least extremely remote. FCS controls and displays shall be designed in accordance with MIL-STD-1472.

3.2.1.1 Pilot controls for CTOL aircraft. Pilot's cockpit controls for conventional takeoff and landing (CTOL) aircraft shall be designed and located in accordance with AFSC Design Handbook DH 2-2, DN 2A1, Aircrew Controls; DN 2A5, Flight Controls; and the following subparagraphs. Strict adherence to the prescribed location and maximum range of motion of these controls is required.

3.2.1.1.1 Additional requirements for control sticks. If a control stick is used and is removable, it shall be positively retained in place when installed. It shall be possible to install the stick only in the correct manner, and suitable means shall be provided to prevent rotation of the stick.

3.2.1.1.2 Additional requirement for rudder pedals. Rudder pedals shall be interconnected to insure positive movement of each pedal in both directions.

Controls

3.2.1.1.3 Alternate or unconventional controls. If pilot's controls other than the conventional center located sticks, W-type wheels, rudder pedals, trim controls and indicators, wing incidence control, wing sweep control, landing flap control and indicator, speedbrake control, and automatic flight control panels specified in AFSC Design Handbook DH 2-2, DN 2A5, are utilized, demonstration of their adequacy and suitability is required prior to installation in an aircraft.

3.2.1.1.4 Variable geometry cockpit controls. Wing incidence controls and wing sweep controls shall be designed and located in accordance with AFSC Design Handbook DH 2-2, DN 2A5; Flight Controls. Other controls shall be such that actuation in a forward, upward, or clockwise direction results in increased magnitude of the controlled variable except where such motion is in unavoidable conflict with an obvious and direct relationship between the control motion and resulting change of the controlled variable.

3.2.1.1.5 Trim switches. Electrical trim system switches of the five-position, center-off, toggle type shall be in accordance with MIL-S-9419. Control stick grips in accordance with MIL-G-25561 shall already have the trim switches, conforming to MIL-S-9419, installed. Three-position trim switches shall be approved switches similar or equivalent to the MIL-S-9419 switches.

3.2.1.1.6 Two-Speed trim actuator. Two-speed trim actuator systems shall be designed to preclude runaway or inadvertent operation in the high-speed trim mode.

3.2.1.1.7 FCS control panel. The FCS control panel shall provide the pilots with the integrated means to select the MFCS and AFCS functions.

3.2.1.1.8 Normal disengagement means. Means for disengagement of all modes of the AFCS shall be provided which are compatible with the requirements of 3.1.9.6.

3.2.1.1.9 Preflight test controls. Additional controls shall be provided in the cockpit for initiating and controlling the progress of preflight tests, where necessary.

DISCUSSION

A high degree of commonality between cockpits of aircraft of the same type is required in order to minimize the possibility of human error as pilots transition from one aircraft model to another. The specified sections of AFSC Design Handbook DH 2-2 include design and location requirements for cockpit controls for conventional aircraft primarily by reference to MIL-STD-203 plus several updating revisions. A number of new control concepts such as hand and wrist operated side-arm controllers, and the RAMS-Horn and Brolley-Handle controls to replace the conventional W-type wheel on large aircraft, will provide increased visibility of the flight deck control panels for use of moving map displays and other advanced pilot aids. Demonstration of their adequacy may be accomplished by installation on a flight control simulator and/or in the second cockpit of a trainer or research aircraft as agreed by the procuring activity.

Contrails

In demonstrating adequacy, the procedures described and data in Reference 71 may be helpful. Reference 71 documents an inflight investigation of the characteristics of three unconventional cockpit controllers in a variable stability airplane. Controllers evaluated included a circumferential wheel segment and column, a circumferential wheel segment with a hand-size controller mounted on the right hand top of the segment, and a dual side arm hand-size controller. The controllers were evaluated by the pilots while performing various up-and-away and approach flight maneuvers. A B-26 variable stability airplane was mechanized to simulate the characteristics of a B-1 type airplane in three task flight phases. The primary objective of the study was to determine the relative merits of the controller concepts in an overall airplane mission oriented environment. The study concluded that the dual side-arm controller configuration is the most promising for future application.

Reference 72 recommends that the AFCS control panel be located on the left hand console just aft of the throttle quadrant for aircraft with control sticks such as the F-12 series aircraft. This reference includes a description of the manual and automatic FCS of the F-12 series aircraft and the design philosophy utilized in the design of the control system is reviewed.

Reference 73 contains a good survey of the various approaches to the design of primary hand controllers.

One FCS control panel implementation approach which provides means to manage the AFCS functions includes:

The AFCS engage/disengage switch should provide the means for engaging and disengaging the automatic control function. The switch should be mechanically or electrically interlocked in the OFF condition until all engage interlock requirements are satisfied. Flight director command signals should operate independently of the engage/disengage switch.

The mode select switches should function as remote switching devices to control the operational modes of the AFCS. The mode select switches should allow simultaneous engagement of compatible modes and should be mechanically and/or electrically interlocked to prevent simultaneous engagement of incompatible modes.

Parameter select controls should provide the following capability for pilot-assist modes having preselect capability.

(a) Ability to preset the selected reference parameter value prior to mode engagement.

(b) Ability to have the selected parameter synchronized with the existing conditions prior to mode engagement so that the existing condition is held upon mode engagement.

(c) Ability to update the selected reference parameter during operation of the mode.

Controls

Parameter select controls should provide capability for setting parameter values as required by the AFCS guidance modes. The parameter setting device should be simple to use and the value selected shall be continuously displayed.

3.2.1.2 Pilot controls for rotary-wing aircraft. The pilot's cockpit controls shall be designed and located in accordance with the applicable portions of AFSC Design Handbook DH 2-2, DN 2A1, SN 1(2), MS 33572, MIL-STD-250, and the following subparagraphs. Strict adherence to the prescribed location and range of motions of these controls is required. If a control stick is removable, it shall be positively latched in place when installed. It shall be possible to install the stick only in the correct manner, and suitable means shall be provided to prevent rotation of the stick. Directional pedals shall be interconnected to insure positive movement of each pedal in both directions.

3.2.1.2.1 Interconnection of collective pitch control and throttle(s) for helicopters powered by reciprocating engine(s). The collective pitch control shall be interconnected with the throttle control(s) and synchronized to provide the proper throttle setting(s) as collective pitch is increased or decreased. Means shall also be provided to permit throttle control, independent of collective pitch lever movement, by rotation of the grip on the lever.

3.2.1.2.2 Interconnection of collective pitch control and engine power controls for helicopters powered by turbine engine(s). An engine power level control lever shall be provided for each engine. The power level control lever shall have three discrete positions: off, idle, and fly, which shall establish three operating ranges of engine power. A fourth optional discrete position may be incorporated to provide a contingency emergency power level. The collective pitch controller may be interconnected with the engine power control such that (for a given power level control position) it establishes the approximate power being delivered to the rotor, and also signals power level changes in maneuvering flight to minimize transient rotor speed droop and overspeed. Rotor speed select control shall be provided on the collective pitch controllers. Individual engine power trim or power turbine speed trim controls may be located on the collective pitch controllers or on the engine power level control panel.

3.2.1.2.3 Alternate or unconventional controls. If pilot's controls other than the conventional center located cyclic pitch sticks, left-hand side located collective pitch sticks, directional pedals, control system power boost controls, automatic flight control system controls, and trim controls specified in MIL-STD-250 are utilized, demonstration to the satisfaction of the procuring activity of their accuracy and suitability is required.

DISCUSSION

A helicopter pilot normally flies with hands on the controls due to the dynamics of the aircraft and the requirements of various helicopter missions. Temporary locking of the thrust lever or collective pitch controller will free his left hand to operate switches on the console, etc.

Controls

It has evolved that the rotary-wing aircraft pilot sits in the right-hand seat, which is probably the major departure from fixed-wing aircraft design practice. The second significant difference is in the force level of the controls. Helicopter control forces are significantly lighter than for fixed-wing aircraft because of the delicate requirements of hover mode operation. Frequently, however, helicopters are fitted with maneuvering force-feel systems which become effective in forward flight.

The helicopter industry has remained with the center stick and pedals because of the obvious awkward nature of handling a control wheel in hover. The pedals on older helicopters traveled in circular arcs. The recent trend is to make their travel more straight, which, however, complicates the linkage somewhat.

The thrust lever has frequently been a cause of pilot-induced vertical oscillations because its up and down motion is in the same sense as that of the aircraft and therefore requires careful attention to damping and force level. Recent development programs with electrical flight controls and advanced flight control concepts have provided limited evaluations of side arm controllers. It is apparent that a considerable amount of effort is required to make these acceptable for production rotary wing aircraft.

3.2.1.3 Pilot controls for STOL aircraft. Pilot's cockpit controls for short takeoff and landing (STOL) aircraft shall be designed and located in accordance with the requirements specified in 3.2.1.1, and subsections, for CTOL aircraft, and MIL-F-83300 for V/STOL aircraft as applicable.

DISCUSSION

There is a need to retain as much commonality as practical between cockpit controls for STOL and CTOL aircraft to minimize the possibilities of pilot control error. Recognizing that it is too early in the development history of STOL aircraft to specify firm requirements, the tentative requirements that follow are included to provide guidance. They are based on preliminary design studies of potential STOL aircraft types but have not yet been verified by actual use. If design or other factors related to a specific new STOL aircraft lead to alternate designs, they should be pursued and coordinated with the procuring activity for approval.

Thrust vector control(s) for powered-lift fixed-wing STOL aircraft. For aircraft with vectorable engine thrust controlled by a cockpit lever, or levers, the thrust vector control lever(s) should meet the following requirements as applicable:

a. For single seat or tandem cockpits, and side-by-side fighter cockpits with the throttle on the left-hand side, the thrust vector lever should be located just to the right (inboard) of the throttle lever(s) and approximately on the same axis.

b. For side-by-side cockpits with throttles on a center console, the thrust vector levers should be located adjacent to the throttle lever(s) such that they can be easily controlled by either pilot.

Controls

c. The angular travel of the thrust vector control lever(s) should be approximately equal to the angular travel of the throttle lever(s) from flight idle to maximum thrust. Forward lever movement should direct engine thrust aft and result in forward aircraft acceleration, and aft movement should direct thrust down and result in increased upward forces on the aircraft.

d. The thrust vector lever(s) should have feel characteristics similar to the throttle lever(s). Friction should hold the thrust vector control in any set position, and the breakout force should be no more than 3 ± 1 pounds.

e. Thrust vector lever(s) should be designed and located so that they may be moved by the pilot (or copilot) with one hand in a single motion simultaneously with the throttle(s) such as for a go-around.

f. The transition from one set of controls to another set should be smooth and should not cause undesirable transients.

g. Loss of one engine should not prevent control of vector controls on the remaining operable engine.

Speed command control(s) for powered-lift fixed-wing STOL aircraft with engine controls integrated with longitudinal aerodynamic controls. For aircraft with a speed control system with engine controls integrated with longitudinal aerodynamic control for use in the STOL flight mode, the cockpit speed controller should consist of a speed command lever or lever(s) as follows:

a. For single-seat or tandem cockpits, and side-by-side fighter cockpits with the throttle on the left-hand side, the speed command lever should be located just to the right (inboard) of the throttle lever(s) and approximately on the same axis.

b. For side-by-side cockpits with throttles on a center console, the speed command levers should be located adjacent to the throttle lever(s) such that they can be easily controlled by either pilot.

c. The angular travel of the speed command lever(s) should be approximately equal to the angular travel of the throttle lever(s) from flight idle to maximum thrust. Forward lever movement should command increased speed, and aft movement decreased speed.

d. The speed command lever(s) should have feel characteristics similar to the throttle lever(s). Friction should hold the speed command control in any set position and the breakout force should be 3 ± 1 pounds.

e. Speed command lever(s) should be designed and located so that they may be moved by the pilot (or copilot) with one hand in a single motion simultaneously with the throttles such as for a go-around.

f. The speed command control(s) and throttle control(s) should be designed such that the latter can override the former for reversion to the conventional flight mode.

Controls

g. The incorporation of the speed command control should not interfere with the normal relationship of the throttle lever(s) and the engine fuel control(s).

h. The transition from one set of controls to another set should be smooth and not cause undesirable transients.

Lift vector control(s) for powered-left fixed-wing STOL aircraft, with flap controls integrated with thrust vector controls. For such aircraft, the cockpit lift vector control, for use in STOL flight should consist of a lift vector command lever or lever(s) as follows:

a. For single-seat or tandem cockpits, the lift vector control lever should be located just to the right (inboard) of the throttle lever(s) and on the same axis.

b. For side-by-side cockpits, the lift vector control levers should be located adjacent to the throttle lever(s) such that they can be easily controlled by either pilot.

c. The angular travel of the lift vector control lever(s) should be approximately equal to the total angular travel of the flap position control lever. Forward lever movement should command decreased magnitude of the lift vector, and aft movement should command increased magnitude of the lift vector.

d. The lift vector control lever(s) should have feel characteristics similar to the throttle lever(s). Lever friction should hold it in any set position, and the manual override (breakout) force should be 3 ± 1 pounds.

e. Lift vector control lever(s) should be designed and located so that they may be moved by the pilot (or copilot) with one hand in a single motion simultaneously with the throttles such as for a go-around.

f. The flap control lever should be mechanized to track the flap position command when the lift vector control lever(s) is (are) in use.

g. In conventional flight modes, the lift vector control lever(s) should command thrust vector orientation.

h. The transition from one set of controls to another set should be smooth and not cause undesirable transients.

3.2.1.4 Pilot displays.

3.2.1.4.1 FCS annunciation. The FCS control panel or associated panels shall provide means to display:

- a. AFCS engaged.
- b. Mode engaged.
- c. That automatic mode switching has occurred--if required.
- d. Preselected values for selectable mode parameters.

3.2.1.4.2 FCS warning and status annunciation. FCS warning and status annunciation shall be provided in the cockpit. Annunciation shall be designed to clearly indicate the associated degree of urgency.

- a. First degree--Immediate action required (warning may be audible).
- b. Second degree--Caution, action may be required.
- c. Third degree--Informational, no immediate action required.

A panel comprising means for displaying first degree annunciations shall be located within the normal eye scan range of the command pilot. A first degree warning or status indication, which applies only to a particular mode or phase of flight, shall be inhibited or designed to clearly indicate a lesser degree of urgency for all other modes or phases of flight.

3.2.1.4.2.1 Preflight test (Bit) status annunciation. If BIT is used, this display shall:

- a. Indicate the progress of the preflight test.
- b. Instruct the crew to provide required manual inputs.
- c. Indicate lack of system readiness when failure conditions are detected.

3.2.1.4.2.2 Failure status. Failure warnings shall be displayed to allow the crew to assess the operable status of redundant or monitored flight control systems. Automatic disengagement of an AFCS mode shall be indicated by an appropriate warning display. Manual disengagement by the crew shall not result in warning annunciation.

3.2.1.4.2.3 Control authority annunciation. If available manual control authority can be reduced below the level required for maneuver control by a function such as automatic trim or stability augmentation, pilot displays shall be provided to indicate available control authority for essential and flight phase essential FCS. Warning shall be provided if remaining manual control becomes critical.

3.2.1.4.3 Lift and drag device position indicators. Indicators shall be provided in the cockpit to indicate to the pilot(s) the position of each lift or drag device having a separate control. They shall also indicate the correct takeoff, enroute, approach, and landing positions; and, if any extension of the lift and drag devices beyond the landing position is possible, the indicators shall be marked to identify the range of extension. In addition, an indication of unsymmetrical operation or other malfunction in the lift or drag device systems shall be provided whenever necessary to enable the pilot(s) to prevent or counteract an unsafe flight or ground condition.

3.2.1.4.4 Trim indicators. Suitable indicators shall be provided to:

- a. Indicate the position and the range of travel of each trim device.

Contrails

b. Indicate the direction of the control movement relative to the airplane motion.

c. Indicate the position of the trim device with respect to the range of adjustment. (Trim devices such as the magnetic brake used in helicopters to instantaneously relieve pilot's control forces by changing the feel force reference to zero at the control position held by the pilot at the time the trim switch is activated shall not require separate trim indicator.)

d. Provide pilot warning of trim failures which could result in exceeding the State III requirements of 3.1.3.3.4.

Aircraft which require takeoff longitudinal trim setting in accordance with cg location shall have suitably calibrated trim position indicators. Where suitable, trim indicators shall be in accordance with MIL-I-7064. In aircraft requiring quick takeoff capability or certain single pilot aircraft, which use a single trim setting for all takeoff conditions, a trim for takeoff light shall be provided.

3.2.1.4.5 Control surface position indication. Indicators shall be provided in the cockpit for all control surfaces whose positions are indicative of potential flying qualities below Level 3, when the cockpit controls do not provide a positive indication of long term or steady state control surface position, or where the effects of control surface positioning is not readily detectable by other means.

DISCUSSION

The following general considerations apply to systems designed for redundant operations--typified by the all weather landing system:

The crew should be aware of the operational status of the landing system, by annunciation of modes or warning that action is required. It is desirable that three categories of warning be provided to the flight crew so that immediate attention to a problem is demanded only in the event of a critical condition, e.g., failure of a necessary system at low altitude. The three categories of warning are defined in terms of the associated degree of urgency for responsive action.

a. Immediate Action Required--loss of system function, hazardous condition imminent. An example of this situation might be taken as total loss of the AFCS at low altitudes during a limited visibility approach.

b. Caution, Action may be Required--probable loss of system function. Hazardous condition may be developing. Pilot should make an assessment of system status before responding.

c. Informational, No Immediate Action Required--possible loss of system function in near future. No impending hazard. An example is pretest of a system identifying a failure. Hazard can be avoided by avoiding use of that system or mode.

Contrails

The probability of losing the capability to isolate failures and annunciate system status should be minimized. This may require special considerations relative to power source selection. For example, if failures are annunciated by lights, then the design must ensure power to the lights when the channel failure is a power failure.

The probability of the crew mismanaging a safety-critical system should be minimized. Zealous pursuit of this objective can lead to criteria which require that interlock logic be implemented that prevents the crew from isolating a critical channel unless the channel has been annunciated as failed, and which prevent the crew from re-engaging critical channels that have been isolated due to a prior failure indication.

The system design should allow smoke clearing procedures so that the crew can safely cut power to any electrical box which might produce obnoxious amounts of smoke and fumes.

The annunciation and control functions should be implemented so that it is not possible to propagate failures or false failure annunciations across the redundant channels.

Wire runs, cable runs, and cross-channel cabling should be minimized.

Since the annunciation and control box may be common to all channels, special precaution may be required to protect against injury to, or destruction of, this box causing loss of all operating channels.

Reference 12 describes the design trades performed to develop the pilot displays for the American SST. Specific options considered, the packaging design used and conclusions reached are discussed.

The requirement to annunciate manual control authority when masked by automatic trim is in response to aircraft lost due to loss of pitch control. An F-111 was lost following a failure in the fuel transfer system which caused an aft cg condition to develop. The series autotrim, which is part of the F-111 augmentation, maintained the stick in the trimmed position and the stability augmentation masked the degrading pitch stability. As air-speed was reduced and control limits were reached, the F-111 went out of control and was lost, Reference 6.

Runaway trim has caused many accidents in the past. Many of these accidents occurred because the pilot was not aware of the malfunction until it was too late. Low altitude, night and instrument conditions affect the pilot's capability to detect and react. Commercial transport aircraft provide an aural warning whenever pitch trim is changing. Such a device is highly desirable, particularly if a single failure can result in runaway trim.

3.2.2 Sensors. Sensors shall be installed in locations which allow adequate sensing of the desired aircraft and flight control system parameters, and which minimize exposure to conditions which could produce failures or undesired output signals.

DISCUSSION

Careful attention must be given to the location and detail installation of all sensors to ensure that they provide signals of the quality necessary for the flight control system without distortion due to undesirable structural modes or other effects. The locations must not be such as to subject the sensors to damage or change of output characteristics due to environmental conditions, and must be accessible for inspection, removal, and reinstallation by maintenance personnel. Redundant air data sensors, for example, can cause problems because of natural variations in local flow fields with angle of attack and sideslip.

Reference 12 describes the sensor selection trades considered for the American SST which determined the type of sensor to be used and the preferred locations for these sensors.

3.2.3 Signal transmission

3.2.3.1 General requirements.

3.2.3.1.1 Control element routing. Within the restrictions and requirements contained elsewhere in this specification, all portions of signal transmission subsystems, including cables, push-pull rods, torque tubes, and electrical wiring shall be routed through the airplane in the most direct manner over the shortest practical distances between points being connected. Protection from use as steps or handholds shall be provided.

DISCUSSION

Considerable care must be taken in the design of control signal transmission installations in order to meet the foregoing requirements. These and many other considerations, such as the ability to provide the required signal transmission accuracy, fitting the components into the space available, and obtaining minimum weight, go into the selection of signal transmission elements for a given aircraft. Pertinent requirements specified elsewhere in this specification ranked in an order of most to least important include:

Suitable system separation and clearance which precludes contact with structure and other equipment, piping, wiring, and controls under all operating extremes is needed. (3.2.3.1.2)

Single failure points where failure is not extremely remote must be avoided. (3.1.3)

Protection from adverse natural and induced environments including lightning, static electricity, and mechanical damage is needed. (3.1.9)

Suitable access for maintenance must be provided and interference with access to other systems, equipment and adjustment devices must be avoided. (3.1.10.3)

Control elements routing should be determined early in the design of an aircraft before "freezing" the location of equipment which could compromise the control routing.

3.2.3.1.2 System separation, protection, and clearance. Where redundant cable, pushrod, or electrical wiring are provided, they shall be separated as required to meet the invulnerability requirements of 3.1.9. Advantage shall be taken of the shielding afforded by heavy structural members, existing armor plate, or other equipment for the protection of important components of the control systems. Clearance between flight control system components and structure or other components shall be provided as necessary to insure that no probable combination of temperature effects, air loads, structural deflections, vibrations, buildup of manufacturing tolerances, or wear, can cause binding or jamming of any portion of the control system. In locally congested areas only, the following minimum clearances may be used after all adverse effects are accounted for:

- a. 1/8-inch between static elements except those within an LRU where closer clearances can be maintained or where contact cannot be detrimental.
- b. 1/8-inch between elements which move in relation to each other and which are connected to or are guided by the same structural or equipment element(s) except those within an LRU where closer clearances can be maintained or where contact cannot be detrimental.
- c. 1/4-inch between elements which move in relation to each other and which are connected to or are guided by different structural or equipment elements.
- d. 1/2-inch between elements and aircraft structure and equipment to which the elements are not attached.

DISCUSSION

The minimum clearances specified above are based upon experience and are listed in the descending order shown based upon the relative probability that the elements will retain their selected positions from aircraft to aircraft. Every effort should be made to avoid the minimum spacings, however; and it should be noted that the minimums listed are the clearances which must be provided after all of the adverse effects (e.g., loads, deflections, vibrations, tolerances, wear, etc.) are accounted for.

As a general objective, control elements should clear items of equipment, structure, electric wire runs and hydraulic and pneumatic lines by 2.0 inches, where possible.

3.2.3.1.3 Fouling prevention. All elements of the flight control system shall be designed and suitably protected to resist jamming by foreign objects.

DISCUSSION

This is a most important requirement. Lives have been lost because foreign objects have jammed controls and caused crashes, unplanned ejections, and other unsafe events. There have been several instances of control jams because of tools, screws, bolts, nut strips, and other objects binding flight control mechanisms. Many such events are documented in Reference 46, including one where an aircraft loss was attributed to a jammed pitch/roll mixer by a tube of fuel tank sealant found in the wreckage.

Mechanisms and installations should be designed to preclude jamming by foreign objects. Compact installations of parallel rods and adjacent bell-cranks may have an orderly appearance but present many opportunities for jamming. Clearances between control paths should be determined by the dimensions of the tools and related items most likely to be used in maintaining and inspecting the area. Many cases of jamming by flashlights and screwdrivers have been identified. Moving elements of control systems should be located near the top surface of their enclosures. The supporting elements should be designed so that they cannot trap a tool or other foreign object. Protection provisions should also consider the effects of inverted flight in fighter/attack type aircraft and zero or negative "g" flight in all aircraft as may be introduced intentionally or caused by turbulence.

In areas where a great amount of maintenance is required, a permanently attached cover should be installed on pulley brackets and complex mechanisms to prevent foreign objects such as rags, nuts, bolts, etc., from lodging between cable and pulley groove and in linkage so as to jam the control system. In all locations, vertical or near vertical pulleys should be equipped with guards. In unpressurized sections, the design of mechanisms including pulley, sector, and drum support structure must be such as to prevent slush and ice accumulation from jamming the control system.

These recommendations should be strongly considered even if they require additional space for control runs. In a fly-by-wire system, the mechanical portion would be much simpler and include fewer points which could be jammed. It would be easier to reduce mechanical density, include proper inspection panels, and take other steps to reduce opportunities for tool and other foreign object jamming.

3.2.3.1.4 Rigging provisions. The number of rigging positions shall be kept to a practical minimum. They shall be readily accessible and located where space for the rigging function is available. Installed rigging pins shall be highly visible from the ground or include streamers as specified in 3.1.10.4. Control surface actuator outputs shall not be rig pinned.

DISCUSSION

The minimization of rigging errors justifies the additional engineering effort and tooling precision which may be required to achieve adequate adjustment of the signal transmission system with a minimum number of rig positions. The use of streamers is important to minimize the possibility of clearing an aircraft for flight before the rig pins are removed.

3.2.3.2 Mechanical signal transmission

3.2.3.2.1 Load capability. Elements of mechanical signal transmission systems subjected to loads generated by the pilot(s) shall be capable of withstanding the loads due to pilot's input limits specified in MIL-A-8865, Section 3.7, Flight Control System Loads, taken as limit loads, unless higher loads can be imposed such as by a powered actuation system or loads resulting from aerodynamic forces. Where higher loads are thusly imposed, they shall be met with the same margins and circumstances as specified in MIL-A-8865.

Contrails

3.2.3.2.2 Strength to clear or override jammed hydraulic valves. All mechanical elements which transmit input commands to metering valves of hydraulic servoactuators shall have strength to withstand higher loads, above those for normal valve stroking, required to clear foreign material that may occur in projected usage.

3.2.3.2.3 Power control override provisions. Provisions shall be made to permit the pilot(s) to clear or override metering valve jams unless there is sufficient aerodynamic control power from the remaining operative surfaces to override control moments generated by the jammed surface in its most adverse position.

DISCUSSION

Specific values for valve jam-clearing forces depend upon the specific valve designs and the system design approach. On many hydraulic metering valves, a 200-pound force will be sufficient to shear all chips or other foreign material which could jam a valve. On others, especially those with tapered metering slots where a chip might become wedged, more force may be required. In systems where detented linkage is used to allow override of a jammed valve, the maximum detent breakout force, considering all adverse tolerances, must be considered.

An alternate to this requirement is to use a dual-concentric-spool valve, such as used on a number of commercial jet airliners, which allow continued functioning in the event of a solid jam of one spool in a mid-position and neutralization of a hardover.

3.2.3.2.4 Control cable installations. Control Cable installations shall be designed to accommodate easy servicing and rigging, and the number of adjustments required shall be kept to the practical minimum.

3.2.3.2.4.1 Control cable. Cable used for the actuation of flight controls shall be the most suitable of the following types for each application. Use of carbon steel or other type cable not listed below requires procuring activity approval.

a. Flexible nylon-coated corrosion-resisting steel wire rope in accordance with MIL-W-83420.

b. Preformed flexible corrosion-resisting steel wire rope in accordance with MIL-W-83420.

c. Preformed flexible corrosion-resisting nonmagnetic steel cable in accordance with MIL-C-18375.

DISCUSSION

Stainless steel cable has been required for new USAF aircraft designs since the issuance of MIL-F-9490C in 1964. Prior to that time, carbon-steel cable per MIL-W-83420 was also allowed and is still being designed into commercial jet aircraft, including many purchased for USAF use, where corrosion resistance is not as significant as for many military aircraft.

Contrails

In addition to its corrosion resistance, tests such as reported in Reference 74 have shown that the fatigue life of stainless steel cable is superior to carbon steel cable (either galvanized or tin coated), especially at low temperature (-65°F to which many cables are exposed in flight). Other tests also indicate its superiority at higher temperatures, especially in corrosive (salt spray) atmosphere.

Stainless steel cable is not immune to failure in service, however, and there has been a history of control cable failures in high vibration areas caused by excessive wear on the outer wires where the cables make contact with the fairleads. At one time, such failures in fuselage-mounted cable runs in F-5 and T-38 aircraft became such a serious problem that cable replacements were required after as low as 40 hours service.

This experience led to the evaluation of standard stainless steel cable jacketed with extruded plastic materials. In the test program documented in Reference 75, cable jacketed with nylon proved superior to polyolefin material and was adopted for standardization. Its use on the F-5 and T-38 aircraft has completely solved the failure problem; and, of 10,000 installations, only two removals (due to overheat near the engine) were required.

Use of nylon jacketed cable (now specified by MIL-W-83420) has also resolved a similar problem on C-141A aircraft. Replacement of bare stainless steel aileron and spoiler control system cables, subjected to aerodynamic induced vibration in the wing, has been required in as few as 400 flight hours due to extreme work hardening and wear adjacent to the roller fairleads. In most cases, 1,500 hours was the maximum life for the bare cable; but, it now appears that adoption of the jacketed cable has eliminated this problem.

Similar experience has been had with certain wing-mounted carbon steel cables on 707 airliners. They are now furnished to the airlines, and the USAF AWACS fleet, with nylon-jacketed carbon steel cable in the lateral control system. Bare carbon steel is still used, however, and provides acceptable service life.

In the sizes most commonly used for flight control applications, 1/8 and 3/32-inch nominal diameter, available coating thicknesses (per MIL-W-83420) are as follows:

<u>Nominal Cable Diameter</u>	<u>Nylon Wall Thickness</u>	<u>Nylon Jacket Diameter</u>
3/32	.016	1/8
3/32	.031	5/32
1/8	.031	3/16

The .031 thickness wears better, but cable with .016 jacket has lower friction. With either thickness, friction will be higher than with uncoated cable. See MIL-W-83420 for the jacket diameters and thicknesses for other sizes. The increase in diameter due to the jacket must be considered in the design of cable grooves on drums and sectors, and may require the use of different pulleys than used for unjacketed cable.

Contrails

The requirement that approval must be obtained before using carbon steel and other type cable is not intended to prohibit their use; but, rather, to ensure that there are sound technical and/or economic reasons for selection, and they will not be subject to failure due to excessive wear, fatigue, or corrosive environments.

One reason for use of another type is to reduce cable stretch under load. The standard 7 x 7 and 7 x 19 construction carbon-steel cable per MIL-W-83420 has a modulus of elasticity roughly 30 percent greater than for standard construction stainless steel. Where greater stiffness is required, special 1 x 19 construction carbon-steel cable and aluminum clad standard carbon steel and stainless steel cable can be considered.

At one time, there were few vendors equipped to make acceptable stainless steel cable, and the price was considerably greater than for carbon steel. This situation has improved, however, and a realistic comparison of initial and replacement costs should be made before assuming which will be most cost effective.

3.2.3.2.4.2 Cable size. Cable shall be sized to meet the load requirements of the system with ample safety factors to compensate for wear and deterioration where pulleys, fairleads, etc., are encountered. Cable size shall also be adequate in regard to permissible cable stretch, pulley friction values, and other variables which affect system performance. Where substantial loads are carried, cables shall be sized so that limit loads do not exceed 67 percent of the rated breaking strength of the cable and do not exceed the maximum cable limit loads allowed for their pulleys.

DISCUSSION

All cables must have a rated breaking strength of at least 1.5 times design limit load. In addition, the size selected should be such that maximum limit load does not exceed the limitations specified for the selected pulleys. See AFSC Design Handbook DH 2-1, DN 3B1, Subnote 1.1.2(1), "Standard Pulleys," for limitations specified for cable used with MS20219, MS20220, and MS20221 pulleys.

3.2.3.2.4.3 Cable attachments. The minimum practical number of interconnections shall be used which allow all cable segments to be connected manually. Cable disconnects shall be located and designed so that it is physically impossible to misconnect in any manner, either cables in the same system or the cables of different systems. Cable disconnects and turnbuckles shall be so located that they will not hang up or interfere with adjacent structure or equipment or on each other and will not snag on cables, wires, or tubing. Corrosion-resistant steel MS swage-type cable fittings in accordance with MIL-T-781, swaged to form cables assemblies in accordance with MIL-T-6117, shall be used wherever possible. Thimble ends per MIL-T-5677, attached to cable by splicing and wrapping in accordance with MIL-S-5676, may be used in applications where additional joints are needed to prevent bending fatigue failures. Turnbuckles used in flight control cables systems shall be in accordance with MIL-T-8878. Turnbuckle and fittings shall be designed so that they are not subject to bending forces which can cause fatigue failures. Turnbuckle terminals shall not have more than three threads exposed at either end. All turnbuckle assemblies shall be properly safetied in accordance with MS33736.

Contrails

DISCUSSION

The applicable terminals in accordance with MIL-T-781 are controlled by the following standards:

MS20658, Terminal, Wire Rope, Swaging, Fork End.
MS20663, Ball End, Wire Rope, Swaging, Double Shank.
MS20664, Ball End, Wire Rope, Swaging, Single Shank.
MS20667, Terminal, Wire Rope, Swaging, Fork End.
MS20668, Terminal, Wire Rope, Swaging, Eye End.
MS21259, Terminal, Wire Rope, Stud.
MS21260, Terminal, Wire Rope, Stud.

These standards call out both cadmium-plated carbon steel and corrosion-resistant steel, but only the latter have been qualified.

The difference in the MS20658 and MS20667 fork types is that the former are sized to accommodate an MS27640 heavy-duty ball bearing between the tines, whereas the latter are sized to accommodate the MS20668 eye ends. The difference in the MS21259 and MS21260 stud types is that the latter has a shorter length of thread on the threaded end and also comes in both a short and a long threaded end.

Note that there are two types of terminals as follows:

Type I: Sleeve (or shank) terminals which are the regular terminals for general use in aircraft control cable installations.

Type II: Ball-end terminals for use in ordnance and glider control installations and in attaching cables to quadrants, drums, etc., in cable control systems on powered aircraft.

A typical thimble-end connection is shown on MS33736 and may be used to prevent bending fatigue failures as shown in AFSC Design Handbook DH 2-1, DN 3B1, Subnote 1.2(1), "Fatigue Failure Turnbuckle."

Components of turnbuckles in accordance with MIL-T-8878 are controlled by the following standards:

MS21251, Turnbuckle Body, Clip Locking.
MS21252, Clevis End, Turnbuckle, Clip Locking.
MS21253, Clevis End, Turnbuckle, Clip Locking (for Bearing).
MS21254, Eye End, Turnbuckles, Clip Locking (for Pin).
MS21255, Eye End, Turnbuckle, Clip Locking (for Wire Rope)
MS21256, Clip, Locking, Turnbuckle.

MS33736 specifies methods of safetying turnbuckle components with the MS21256 locking clips.

3.2.3.2.4.4 Cable routing. Control cables shall be arranged in parallel runs, and be accessible to inspection for their entire length. Cable runs located in aeroelastic structure, such as aircraft wings, shall be routed so as to minimize any induced control action, caused by structural flexure. Spacing between adjacent cables shall prevent cables, turnbuckles, and fittings from chafing during all operating conditions including vibration. Slack return cables shall not snag on each other or any other equipment or structure when the controlling cables are loaded to design limit loads at the adverse extremes of temperature, structural deflection, and other operating conditions. Cables shall not be subjected to critical bends at the junction with cable terminals or other attaching points such as on drums and sectors.

DISCUSSION

A minimum number of pulleys and brackets is highly desirable, and consideration should be given to their simplification. Unsupported spans of 150 to 200 inches have operated very satisfactorily; however, idler pulleys should be used in long straight runs to minimize friction over fairleads and grommets with normal structural deflections. Simple brackets may usually be designed if the cable runs are kept parallel to at least one axis of the airplane or parallel to the supporting surface. A fan type cable run usually results in complicated and/or inaccessible brackets.

The main flight control cables in the wing should be run along the wing neutral axis, and all other cables should be as near to the neutral axis as possible. Runs from any one control element should be located on the same side and at the same distance from the neutral axis to eliminate any induced control action caused by wing flexure. To maintain rigging and control clearances, idlers should be used to restrict cable movement away from the wing neutral axis.

It is not desirable to route control cable around movable equipment and hatches. Each new aircraft model should be thoroughly inspected to determine that all removable or hinged covers on equipment, or rotating or swinging items of equipment, do not interfere with or rub on the control cables.

When using the minimum local spacings allowed per 3.2.3.1.2, the cables should be supported more frequently than normal and turnbuckles placed where more clearance is available. The effect of return cable slack caused by the application of design loads on the controlling side, and due to temperature and other effects, must be carefully considered. The adequacy of guards, fairleads, and rub strips should be confirmed during proof and operational tests on a production aircraft. Reconfirmation should be done at each major revision or model change.

3.2.3.2.4.5 Cable sheaves. Cable drums, sectors, and pulleys of adequate capacity and diameter for their function and to meet aircraft life requirements shall be provided. They shall be large enough for the cable wrap angle such that the cable strands are not overstressed. The diameter and number of grooves on cable drums, and the radius and angle of control cable sectors shall be adequate for the required cable travel. Overtravel allowance shall not be less than 5 percent of full travel in either direction and at least 10 degrees. When cable wrap varies with cable travel, the initial

Contrails

wrap with the sheave in the neutral position shall be at least 115 percent of the full cable travel in either direction. If overtravel exceeds the minimum required, cable wrap shall be increased a corresponding amount. All cable grooves on drums and sectors, machined or die cast, shall have root radii properly sized for the cable size used thereon. Specific approval shall be obtained before using plain pulleys in essential applications. Antifriction pulleys used in flight control systems shall be MS standards in accordance with MIL-P-7034, and the design limit load shall not exceed the allowable limit load specified for the applicable standard.

DISCUSSION

Tests have been conducted to show the reduction in bending life as the sheave to cable ratio is reduced. The table below shows the approximate manner in which relative laboratory bending life is reduced as the sheave to rope ratio decreases.

<u>Sheave to Rope Ratio</u>	<u>Relative Laboratory Bending Life</u>
30	100
28	86
26	72
24	59
22	48
20	38
18	29
16	21
14	15
12	11
10	8
8	6
6	4

Source: Roebling Wire Rope Handbook, 1966, Page 57.

This table was developed by running actual tests on cable. It shows that by reducing the sheave diameter by one half, relative cable life is reduced by 70 to 80 percent.

There are different formulas for calculating bending stresses in the wires of cable when it is bent around a sheave during operation. Using the formula:

$$f = .67 \frac{Ed}{D}$$

f = Bending stress -- psi
E = Modulus of elasticity of wire - psi
d = Diameter of outside wire - inches
D = Pulley root diameter - inches

the bending stress can be calculated. This formula is a median of eight different ones advanced for the solution of the problem. The stress produced by bending can be compared to the stress produced by a straight tensile load.

Contrails

The following comparisons for the MS pulleys for 1/8 through 3/16 inch aircraft cable demonstrate how the smaller pulleys greatly reduce cable life and increase bending stress.

CABLE	PULLEY	ROOT DIAM. (IN.)	SHEAVE TO CABLE RATIO	BENDING STRESS (psi)	EQUIV. TENSILE LOAD (LB)	RELATIVE LIFE
1/8" 7x19	MS20220-1	1.255	10	128,600	1055	8
1/8" 7x19	-2	2.505	20	64,400	528	38
1/8" 7x19	-3	3.755	30	43,000	352	100
1/8" 7x19	-4	5.005	40	32,200	264	-
5/32" 7x19	MS20220-1	1.255	7.5	158,400	1965	5
5/32" 7x19	-2	2.505	15	79,300	983	18
5/32" 7x19	-3	3.755	22.5	53,000	657	51
5/32" 7x19	-4	5.005	30	39,700	492	100
3/16" 7x19	MS20220-1	1.255	6.5	188,500	3280	4
3/16" 7x19	-2	2.505	13	94,500	1645	13
3/16" 7x19	-3	3.755	22.5	63,000	1100	33
3/16" 7x19	-4	5.005	25	47,200	820	65

This comparison shows the importance of using the largest turn radius possible. Although the bending stress formula used shows only a linear relationship to the root diameter, the relative life from the first table shows how much the higher stress reduces cable life.

Because of the many other factors involved, it is impossible to establish firm criteria for the proper cable-pulley ratio. Final determination has to be based on expected load, safety factor desired, and required life. Adequate testing should be conducted prior to final sheave design and pulley selection.

The importance of groove radius is demonstrated by the results of tests run on 3/16 in, 7 x 19 preformed stainless steel cable, summarized in Figure 13D. In each case, the cable was deflected 90 degrees around the sheave under a load of 800 pounds with oscillations of 1 inch amplitude. For each of the three pulley sizes, the best cable life resulted with a groove radius of one-half the cable diameter. This allows for maximum support of the cable by the pulley and prevents the cable from flattening or becoming distorted. Care must be taken, however, to allow adequate clearance for the cable in order to prevent wedging and allow the cable to rotate freely. One formula used successfully for a great number of applications is:

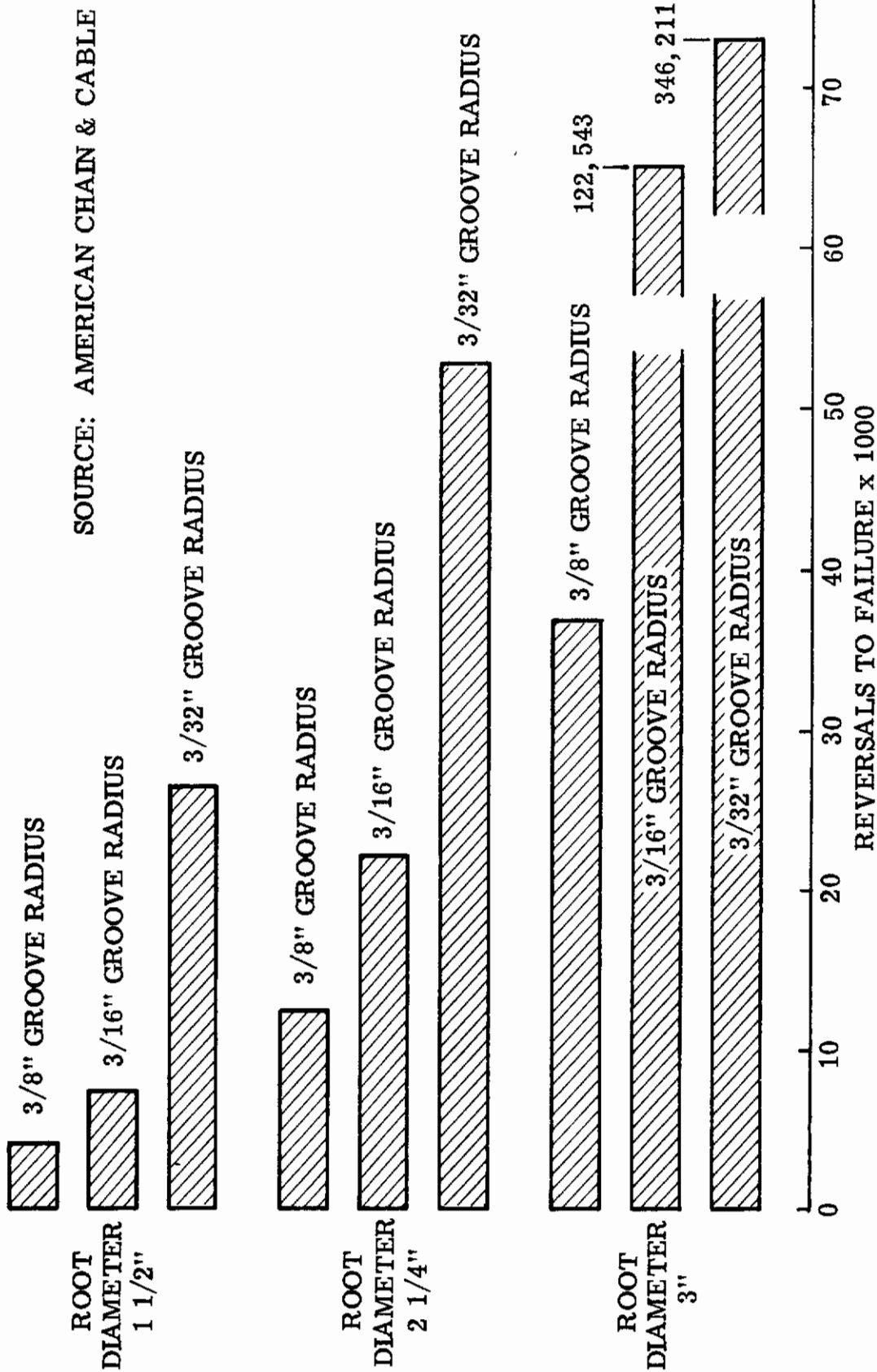

Figure 13D. Effects of pulley dimension on cable life 3/16" 7x19 preformed stainless steel cable

Contrails

$$R_R = C/2 \times 1.15 \text{ where:}$$

R_R = root or bottom radius

C = cable diameter.

Antifriction pulleys are required to keep cable system friction within acceptable limits. However, careful attention to the number of pulleys, wrap angles, and rigging load is required, especially if friction is critical. In long, straight runs, however, idler pulleys should be used to minimize friction over fairleads and grommets with normal structural deflections.

The approved antifriction pulleys in accordance with MIL-P-7034 are controlled by the following standards:

MS20219, Pulley, Groove, Secondary Control, Aircraft
MS20220, Pulley, Groove, Flight Control, Aircraft
MS20221, Pulley, Groove, Heavy Duty, Control, Aircraft
MS24566, Pulley-Control, Antifriction Bearing

Their allowable loads are listed on the standard drawings, and are summarized in one table in AFSC Design Handbook DH 2-1, DN 3B1, Subnote 1.1.2(1), "Standard Pulleys."

It should be noted that these pulleys are sized in increments for use with either two or three cable sizes. Therefore, only the largest cables in each size range will have an optimum fit in the groove. This is a compromise to keep the number of sizes which must be stocked within a reasonable limit, but does compromise optimum life and friction somewhat. The flattening of the cable in an oversized groove not only reduces life as shown in Figure 13D, but also increases friction.

3.2.3.2.4.6 Cable and pulley alignment. Fixed-mounted pulleys shall be aligned with their cables within 2 degrees as specified in AFSC Design Handbook DH 2-1, DN 3B1, Subnote 1.1.3(1), Cable Pull. Where a control cable has an angular motion with respect to the plane of the pulleys, the maximum misalignment resulting from this motion must not exceed 2 degrees, and the cable shall not contact the pulley (or quadrant) flange for the total cable travel.

DISCUSSION

Accurate alignment is required to prevent cables from coming out of their pulleys. A design misalignment limit of 0.5 degrees is usually used to ensure the 2-degree limit on the manufactured product. Pulleys should be mounted in vertical planes; however, in some situations, it may be necessary to use cable guide tubes or closely mounted fairleads to limit misalignment due to catenary effect or slackening of the cable.

Contrails

3.2.3.2.4.7 Pulley-bracket spacers. Loose spacers between pulleys, bearings, and pulley brackets shall not be used.

DISCUSSION

Spotwelded, riveted, or other fixed spacers, flanged bushings, or dimpled brackets should be used in lieu of loose spacers.

3.2.3.2.4.8 Sheave guards. Guards shall be installed at all sheaves (pulleys, sectors, drums, etc.) as necessary to prevent the cable from jumping out of the groove of the sheave. Guards shall be installed at the approximate point of tangency of the cable to the sheave. Where the cable wrap exceeds 90 degrees, one or more intermediate guards shall be installed. All guards shall be supported in a way which precludes binding of the sheave due to relative deflections in the aircraft structure. Additional guards shall be installed on sectors as necessary to ensure retention of the cable end in its attachment under slack cable conditions. The design of the rubbing edges of the guard and the selection of materials shall be such as to minimize cable wear and prevent jamming even when the cable is slack.

DISCUSSION

The number of guards required varies with the angle of cable wrap and cable flexibility. Cable installation and replacement requirements will usually determine the type of guards best for each sheave. In complex bracket assemblies, removable guards (pins, bolts, and spacers) are usually preferred. In simple brackets, fixed guards (rivets and spacers) may be considered provided the pulley may be easily removed.

3.2.3.2.4.9 Sheave spacing. In any given cable run, no portion of the cable shall ever pass over more than one sheave.

DISCUSSION

This is to reduce wear and friction. Cable tends to twist over each pulley. If the twist from one pulley rides on to another pulley, it will cause increased wear and friction.

3.2.3.2.4.10 Cable tension. Cable rig loads shall insure positive cable tension in control and return legs of closed-loop cable installations under all operating conditions including airframe deflection and differential expansion and contraction between the cable and airframe structure throughout the designed operating temperature range. The cable return leg may be allowed to go slack when the control leg is loaded above the normal operating load, providing it cannot snag, when the control leg is loaded at any load up to limit load, and that there is no hazardous loss of system performance. Cable tension regulators shall be provided only if positive cable tension cannot be maintained in both legs, with reasonable rigging loads.

DISCUSSION

Closed cable installations should never go slack under normal operating loads, or system deadband and loss of response will occur. Limit loads are

Contrails

normally developed only under adverse conditions such as sticking or jammed control valves or linkages, however; and, it is usually permissible for the return leg to go slack under such occurrences.

Closed cable installations are rigged to a predetermined load in order to decrease the deflection between the location of the input force and the location of the output force. The rigging load must be greater than half the maximum normal operating load so that the return leg does not go slack under the range of normal operating load.

With a rigging load equal to half the maximum normal operation load, the cable deflection throughout the normal operating load range will be approximately half the deflection of cable without rigging load. See Figure 14D. Increasing the rigging load reduces deflection further, but increases friction and may overload pulleys.

Because of differing coefficients of thermal expansion between the cable and the airframe, cable loads can vary through a wide range due to temperature changes. As ambient temperature increases, rigging loads of closed systems can increase to the point where friction has a detrimental effect on resolution and stability of the system. As ambient temperature decreases, the rigging load could be so low, or lost completely, that a "spongy" or inaccurate response of the control surfaces will result.

Cable tension regulators are often installed in quadrant assemblies of a control installation to take up the slack or allow for contraction of the cables without appreciable variation of the rigging load during temperature changes throughout the design range.

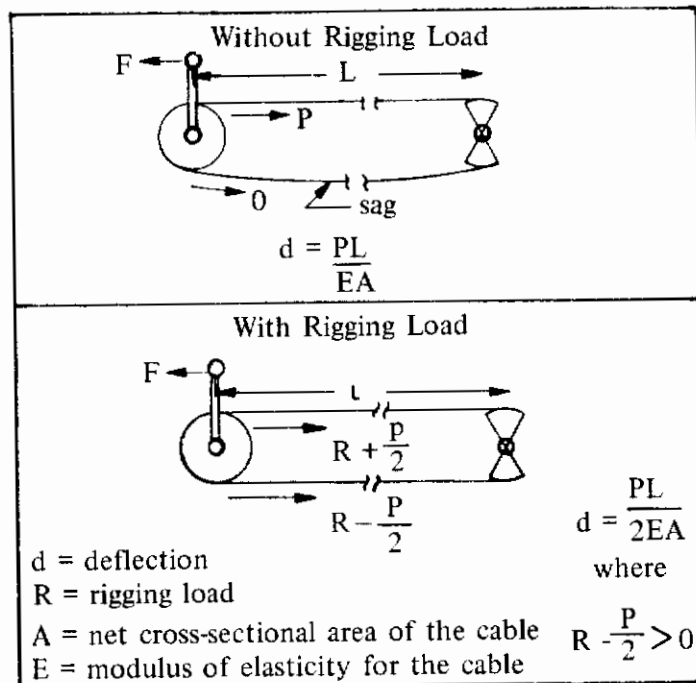

Figure 14D. Rigging Load and Operating Deflection

3.2.3.2.4.11 Cable tension regulators. When used, tension regulators shall maintain required tension at all times. Integral calibration shall be provided to show proper cable tension without the use of external tensionmeters or other equipment.

DISCUSSION

The advantages of tension regulators should be carefully weighed against the disadvantages of additional weight, complexity, cost, and the possibility that a failure may introduce dangerous control transients or cause the cable to go completely slack. A better approach is often to design a "soft" system with cables small enough to stretch to allow for temperature changes but still tight enough for operation at minimum designed temperature.

3.2.3.2.4.12 Fairleads and rubbing strips. Fairleads shall not cause any angular change greater than 3 degrees in the direction of the cable under all conditions including those due to structural deflections in flight. Fairleads shall be split to permit easy removal unless the size of the hole is sufficient to permit the cable with swage terminals to be threaded through.

DISCUSSION

Fairleads and rubbing strips may be needed to keep cables from chafing, snagging, and slapping against each other and adjacent parts of the aircraft. The necessity for fairleads can be reduced by keeping cable runs away from structure as much as possible. Rub strips may often be installed if there is a possibility of the cable hitting structure or equipment.

Where space permits, the fairleads should clear the primary flight control cables by a minimum of 1/4 inch. The cables may rest against the lower edge of the hole in fairleads on long, straight cable runs where the cables would normally sag due to their own weight even though properly rigged.

Grommet Type Fairleads

A grommet type fairlead should be used where cable passes through structure unless a pressure seal is required. The fairlead holes should be as large as possible and a tight fairlead should not be used unless absolutely necessary. If a tight fairlead is required, the installation must be adjustable to correct for shop errors. Holes in a tight fairlead should be approximately .05 larger than the nominal cable diameter.

Wing Fairleads

Wing fairleads should be slotted to allow the cable to rise and fall with the wing deflected under 1/2 the design load factor. If this is not practicable, fairlead pulleys should be used.

3.2.3.2.4.13 Pressure seals. Pressure seals shall meet compartment sealing requirements within cable installation friction requirements. They shall be designed to preclude jamming the control system.

DISCUSSION

Types which have been successfully used in many applications include:

The Finned-Type shown following which has been used to seal pressurized compartments in many applications where minimum friction is required. They may be installed or replaced after cables are rigged, but must be installed with the small end to the high pressure side of the bulkhead, as they will not seal if reversed.

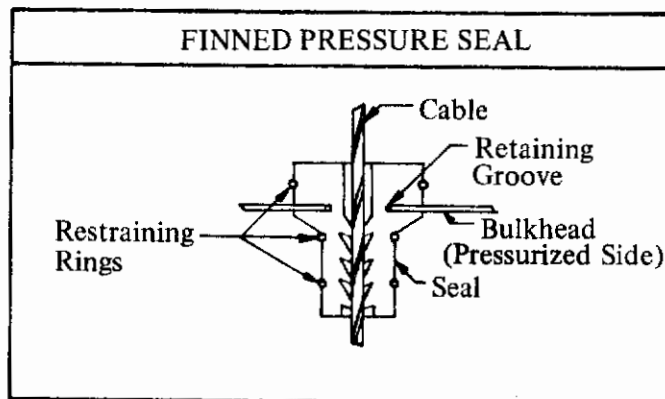

The Eyeball-Type shown below which has an angular self-aligning feature which can reduce wear and subsequent leakage in cable installations subject to misalignment.

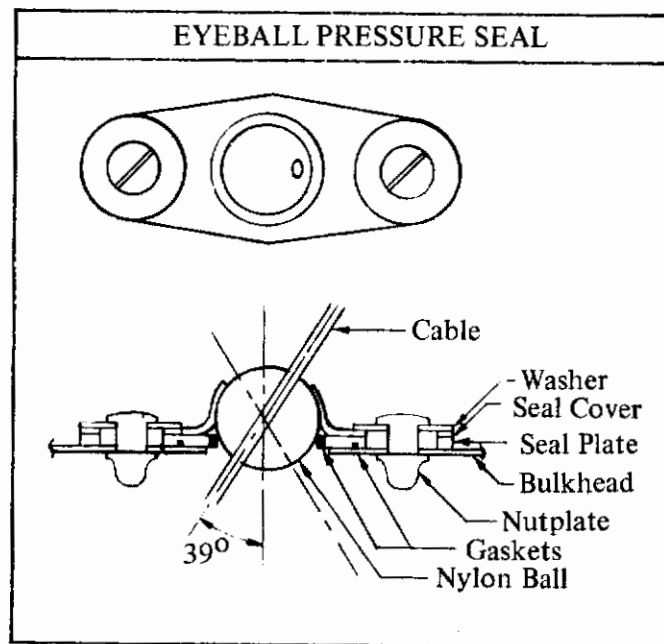

Contrails

3.2.3.2.5 Push-pull rod installations. Push-pull rod installations shall be designed to preclude binding or separating from the mating linkage, and shall permit servicing and rigging.

DISCUSSION

Push-pull rod installations are often determined to be more suitable than control cables or other signal transmission means, either as a total concept or for selected locations within a control cable installation. Push-pull rod installations include the rod assemblies, with fixed and/or adjustable terminals, levers, and bellcranks, and guides or other supports as necessary to prevent fouling.

3.2.3.2.5.1 Push-pull rod assemblies. Push-pull rod assemblies shall be designed and installed such that inadvertent detachment of adjustable terminals is impossible, and such that any change in length due to loosening of the terminals cannot result in an unsafe condition. On any single rod assembly, adjustment shall be possible at one end only. The fixed end of each rod shall be attached to its mating linkage element in a manner which precludes rotation of the installed assembly. The adjustable end shall be of the clevis type or join a clevis type in such a manner that it is also prevented from rotating. When an unsymmetrical rod is used, such as one with a cutaway portion to allow for relative motion of an attached link, the rod end terminals and mating linkage elements shall positively prevent incorrect installation of the rod. Push-pull rods shall have a minimum wall thickness of 0.035 inches and shall be capable of withstanding loads of 1.5 times limit loads in both tension and compression without failure, buckling, or any other form of permanent deformation. All joints shall be made in a manner which precludes loosening and fatigue failure. All closed cavities in rod assemblies installed in unpressurized spaces shall be provided with drain holes adequate to drain ingested water unless cavities are air tight. All push-pull rod terminals shall incorporate antifriction bearings per 3.2.7.2.1.1 or self-lubricating spherical bearings as specified in 3.2.7.2.1.2. All terminal pins shall be retained as specified in 3.2.8.3.2.2. Loose washers or other loose spacers shall not be used to maintain terminal spacing in the connecting linkage.

DISCUSSION

Rotation of a single-adjustable-end rod can be prevented by mating a fixed clevis terminal on the rod with a nonadjustable linkage lug end, or conversely by mating a fixed lug end on the rod with a nonadjustable clevis on the linkage element.

Rods requiring adjustment at both ends are not permitted. If fine adjustments of rod length are necessary, it may be allowed through deviation providing the nonseparation and adverse-length requirements are met. A turn-buckle approach, i.e., with right-hand threaded terminals on one end and left-hand threaded terminals on the other, should not be used. If very fine adjustment is needed, terminals with differing thread pitch (one end finer than the other) can be used. Where dual-end adjustment is authorized, the rod should be designed so that, if the terminal connections inadvertently loosen, either end will bottom on the rod prior to the terminal at the opposite end becoming detached.

Contrails

Push-pull rods should not be used to carry heavy compressive loads; but where both compression and tension loads exist, the heaviest load should put the rod in tension. The 0.035-inch minimum wall requirement is an arbitrary limit which has been deemed necessary to prevent failures due to handling and other maintenance even though, in some cases, strength requirements will be exceeded.

Drain holes are required in all hollow rods with loose fitting ends or with ends attached with a threaded joint which will allow moisture to enter the rod cavity directly or entrained in vapors which can subsequently condense. In addition to the possibilities of corrosion, and the addition of weight to the rod (which might even introduce unwanted control moments in the linkage), rod failures have occurred due to expansion of the water upon freezing. Welded joints and ends riveted after assembly with wet epoxy primer are generally considered sufficiently air tight. Where drain holes are used, they must be large enough to drain collected moisture before the freezeover, and not so large that they unduly weaken the rod.

Hollow nonadjustable rod ends should not be attached with rivets or other fasteners in a manner where they are subject to bending and fatigue failure. See AFSC Design Handbook DH 2-1, DN 3B1, Subnote 2.2(2), "Example of Why Shear Bolts Are Preferred When Installing Rod Ends." An alternate is to use a riveted joint with a plastic or phenolic filler plug in the hollow rod end.

Regarding lateral spacing of the terminal in its connecting linkage, see AFSC Design Handbook DH 2-1, DN 3B1 Subnote 2.2(1), "Benefit of Bushings for Rod End Installation." The use of bushings will prevent loose joints due to neglect to install loose spacers, and will be helpful in preventing stress failures in the clevis end.

3.2.3.2.5.2 Levers and bellcranks. Applicable requirements in AFSC Design Handbook DH 1-6; System Safety, Section 3J; Flight Control Systems, Design Note 3J2; Mechanical Flight Controls; Pulleys, Brackets and Bellcranks, and Design Note 3JX; Safety Design Check list, shall be met. Bearings shall have adequate self-aligning capability if necessary to prevent excessive deflection loads on levers and bellcranks, and, their installations shall be designed for easy replacement so that the parent part may be reused. Levers and bellcranks designed with dual load paths having the two sections positively joined by permanent fasteners, such as rivets, shall be bonded with adhesive.

3.2.3.2.5.3 Push-pull rod supports. Where long sections of push-pull rods are utilized in applications where jamming is not extremely remote, guides shall be installed at intervals to preclude fouling in the event of rod failure.

3.2.3.2.5.4 Push-pull rod clearance. Clearance between push-pull rods, and between rods and aircraft equipment and structure, shall be as specified in 3.2.3.1.2 except that it shall also be sufficient to permit removal of adjacent LRU's without disconnecting the rods.

Controls

3.2.3.2.6 Control chain. Where used, control chains shall be of standard aircraft quality and conform to MIL-STD-421. Connecting links shall be retained with standard nonhardened cotter pins. Spring clips shall not be used.

DISCUSSION

In many cases, where rotational signals which must make a multiplicity of turns and be transmitted to another shaft located too remotely for connection through gearing, chain drives will prove to be the best solution.

The requirement to bond joined sections of dual load path levers and bellcranks with adhesive is meant to prevent entrance of moisture between the fayed surfaces, and jamming due to separation of loose pieces.

3.2.3.2.7 Push-pull flexible controls. Push-pull flexible controls may be used for transmitting control signals in noncritical applications, but specific approval from the procuring activity must be obtained before use in essential and flight phase essential applications. Where used, they shall conform to MIL-C-7958. Installations shall avoid an excessive number of bends to keep friction forces within acceptable values and minimize the possibility of jamming, and the routing shall preclude damage due to personnel using them as steps and handholds. Conduits shall be supported at frequent intervals, but not so tightly that the control is restrained axially.

DISCUSSION

The requirement that specific approval must be obtained before use of flexible controls in essential and flight phase essential applications is not intended to prohibit their use, but rather to ensure that the contractor has fully investigated their capability to perform satisfactorily in the intended application and exercises proper care in the installation design.

Sliding-friction flexible controls were the first type used, and MIL-C-7958 is oriented to that type. However, because of their higher efficiency, the ball-bearing type has come into use for a number of recent applications. These include engine controls, wing sweep and flap controls, and wheel brake and landing gear controls on the F-111 and rudder control on the F-15.

Installation of the ball-bearing type generally requires more care than for sliding friction controls. With the latter, care must be taken in the installation design to limit the number of bends so that friction forces do not become excessive; and, in the actual installation, they must not be forced into other than a natural curve. The ball-bearing types are more sensitive to installation error. All bends must be kept in a single plane or the control helixed into other bend planes at a controlled rate (within a limited rotational arc per unit length) to prevent binding or damage. They must also be supported at frequent intervals, but not so tightly that the conduit is restrained axially or pinched where motion of the internal components may be impaired. Routing should preclude personnel using them as steps and handholds per 3.2.3.1.1.

Contrails

3.2.3.3 Electrical signal transmission. The following requirements apply to all essential and flight phase essential signal paths. Except for power sources, such systems shall be independent of failure modes associated with any other electrical system. Cross connections between redundant electrical signal paths shall be eliminated, or minimized and electrically isolated. Wire runs and components in redundant control paths shall be physically separated and electrical shielding shall be installed, as necessary, to meet failure immunity and invulnerability requirements. All interconnecting wiring shall be prefabricated, jacketed cable assemblies. The outer jackets shall be identifiable by a unique color or other means. Wiring installation shall be in accordance with MIL-W-5088.

DISCUSSION

Requirements for electrical power sources are discussed in detail in 3.2.5.4. Failure immunity requirements which permit loss of only one redundant channel due to any single failure, not extremely remote, are discussed in 3.1.3. Identifying each channel supplying essential and flight phase essential systems will serve to prevent damage from careless maintenance.

Wiring associated with redundant systems must be adequately separated and/or protected from hazards such as:

- Wire bundle fire
- Equipment or junction box fire
- Connector shorting or decoupling
- Fuel Fire
- Engine case burn through
- Turbine burst fragments (including turbofans and starter turbines)
- Battery chemical leakage
- Abrasion from rocks, ice, and mud
- Burst hot air ducting
- Lightning currents from plausible failures of lightning protection

Various systems of bundle routing, raceway selection or wire protection may be developed. For circuits which are to be separated from one another for reasons other than EMI, adequate separation can normally be achieved by:

Physical separation by either routing in separate bundles or raceways, by maintaining a safe clearance from other wires, or by enclosing the critical wire in suitable sleeving or tape.

Never routing through the same connector.

Not routing through the same junction box.

Contrails

Not routing through areas where excessive environmental conditions or mechanical failures can adversely affect any redundant system wiring, e.g., turbine burst envelopes, hot air from a burst pneumatic duct, etc.

Within the AFCS, a critical wire may be defined as any wire which, when grounded, opened, shorted to an energized power source or an adjacent signal-carrying wire will induce one of the following:

Bypass a monitoring function.

Create a simultaneous fault in any two identical control channels or any two identical sensors.

Cause any two identical control channels to receive a single-source input signal.

Inhibit the commanded disengagement of a control channel or its hydraulic servo package.

In fail-operational autopilot packaging particular care must be exercised to ensure that system isolation is not jeopardized at the mode select panel, the automatic test unit, and the accessory boxes. In these areas, cables should be routed with suitable physical separation or shield protection to separate connectors. In addition, automatic control and flight director signals should be isolated from each other such that failure in one, downstream of the last common tie, does not have an adverse effect upon the other.

3.2.3.3.1 Electrical flight control (EFC) interconnections. EFC(6.6) wiring in individual channels shall be routed, isolated and protected to minimize the applicable threats to redundancy. Channel loss due to any foreseeable hazard, not extremely remote, shall be limited to a maximum of a single channel. The adequacy of the separation, isolation and protection attainable in any given location for any given hazard shall be evaluated for each aircraft design. Additional protection shall be provided for the EFC wiring where analysis shows that any single hazardous event, not extremely remote, could cause the loss of more than one EFC channel. Primary structural components shall be used to afford this protection where possible. Where it is approved by the procuring activity to route the EFC wiring through wheel wells or other areas subjected, during flight, to the slipstream or impingement of runway fluids, gravel, etc., the wiring shall be protected by enclosures and routed directly through without unnecessary termination or junctions. Where terminations or junctions to equipment in these areas are required, they shall be protected from such impingements. This shall also be done in areas where a high level of maintenance is likely to be required on other systems and equipment.

DISCUSSION

These requirements are based on the Reference 76 handbook which was generated under an AFFDL contract. The handbook recommendations were based on Apollo techniques and hardware, proposed technical and hardware for the American SST and on information from the Air Force Survivable Flight Control System Program.

Contrails

These channel separation and routing requirements are in addition to the overall reliability and vulnerability requirements stated in 3.1.7 and 3.1.9, and amplify the failure immunity requirements of 3.1.3. The general reliability and vulnerability requirements may lead to even more stringent inter-connection requirements than the minimum requirements stated here.

Hazards which should be considered as foreseeable hazards in most applications include:

- Combat damage
- Localized fire
- Turbine burst
- Tire burst
- Collision
- EMI
- Lightning
- Static electricity
- Chemical Damage

Isolation is needed to assure that no single failure(s), not extremely remote, of other systems (including wiring failures in other systems) do not cause failures in the EFC wiring. Isolation may also be needed to minimize electromagnetic interference and electromagnetic pulse pickup. As specified, each situation must be analyzed and where attainable isolation or channel separation is inadequate, protective measures must be taken.

3.2.3.3.1.1 Cable assembly design and construction. The outer jacketing for EFC wiring shall not create stresses on the wire and connector terminations and shall not stress the wires in a manner which opens the connector grommet seals. During design of the cable assemblies, particular attention shall be paid to the requirements of the circuits within the cable and adequate EMI and EMP control methods, e.g., shielding, twisting, etc., shall be incorporated into the design. Where shielded wires are used provisions shall be made for carrying the shields through the connectors where single point grounding is necessary. A signal return wire shall be provided for each signal level circuit in the cables. All cable assemblies shall be constructed in an area with temperature and humidity controls and positive pressure ventilation and shall be cleaned (all wire cuttings, etc., removed) and inspected after layup and prior to jacketing to assure that no potentially damaging particles have been included, particularly at the entrance to the grommet seal. All cable assemblies shall be constructed, tested and inspected by specially trained and certified personnel. Terminal boards shall not be used in EFC wiring. Splices shall be qualified, permanent-type splices.

Contrails

3.2.3.3.1.2 Wire terminations. Crimp type wire terminations (spade, lug or connector) shall be used on all EFC cables. Soldered and potted connections shall not be used. With the terminal installed on the wire, the wire shall be visible for inspection at both ends of the crimp barrel. The length of wire visible between the insulation and barrel shall not exceed 1/16 inch.

3.2.3.3.1.3 Inspection and replacement. The EFC wiring shall be installed so that it can be inspected for damage and replaced as necessary. The installation shall provide for visual inspection in critical areas such as hazardous environment areas or areas where a high level of maintenance is required on system or equipment in close proximity.

3.2.3.3.2 Multiplexing. Multiplexed signal transmission circuits shall be the digital time-division-multiplexing type utilizing a twisted shielded pair cable as the transmission media for the multiplex bus. The multiplex data bus line and its interface electronics, multiplex terminal unit shall meet MIL-STD-1553.

DISCUSSION

MIL-STD-1553 deals with twisted shielded pair multiplex bus. It covers the data bus characteristics, the interface between the data and the remote terminal, and the interface between the principal parts of the remote terminal. The interface between the remote terminal and the subsystem is not part of the standard.

Reference 77 describes trade studies supporting the selection of a fly-by-wire multiplexing concept. Arguments for selecting the preferred multiplex concept are presented and several potential alternatives are described. Reference 78 describes bench testing of the breadboard demonstrator developed. Reference 79 describes the design, qualification testing and flight testing of flight-worthy multiplexing hardware in an NC-131H Inflight Simulator Airplane.

Reference 80 answers the question: "Why Multiplex Data in an Aircraft Electrical System?" This reference predicts equal or improved performance in the following areas due to use of multiplexing in aircraft systems:

Weight

Redundancy/Reliability

Growth and Flexibility

Maintainability

Cost

3.2.4 Signal computation.

DISCUSSION

With the increased use of computers in flight control systems, a need for specification requirements has developed. General design requirements pertaining to control signal computation subsystems have been compiled in this section. Prior to procurement of the flight control system computation equipment, the contractor should establish the type of computer to be used for each flight control function and its relationship with other computers used on the aircraft. The relative figures of merit of analog and digital types, central versus dedicated or federated (semidicated) types, and in combining functions such as in a multipurpose air data computer, or in an integrated automatic guidance and control system should be established with careful attention to factors such as mission environment and the various threats and hazards.

3.2.4.1 General requirements.

3.2.4.1.1 Transient power effects. Flight control computers shall not suffer adverse effects, which result in operation below FCS Operational State I, due to power source variations within the limits specified for the applicable power system. In the event of power source interruption, no adverse effects shall result which limit operation or performance of flight control computers upon resumption of normal quality power.

3.2.4.1.2 Interchangeability. The requirements of 3.2.7.1.2 shall be met, and tolerances shall be such that interchange of any computer component, module, or LRU with any other part bearing the same part number shall require only minimum resetting of parameters or readjustment of other components in order to maintain overall tolerances.

DISCUSSION

The designer should ensure that multiple power systems per 3.2.5 as necessary to meet the reliability and invulnerability requirements specified in 3.1.7 and 3.1.9, respectively, are provided. It should be noted that mechanical computation means as specified herein include those means powered mechanically from the pilot or from the operation of or feedback from an actuated system or by fluid power from a hydraulic or pneumatic power source.

One means of preventing voltage variations from changing the correlation between commanded and actual values in FCS is to base both reference and command signals on the same voltage source as the corresponding feedback signal.

3.2.4.1.3 Computer signals.

3.2.4.1.3.1 Signal transmissions. Signal transmissions between computer components and modules shall be done by using direct mechanical, hydraulic, pneumatic, or electrical connections, as required. Use of light transmission technology or other nonconventional transmission paths requires specific approval of the procuring activity.

3.2.4.1.3.2 Signal path protection. Where redundant computing paths are provided they shall be isolated or separated when required to meet the invulnerability requirements of 3.1.9.

DISCUSSION

The use of fiber optics or other nonconventional signal paths may be considered in future computation equipment; and, the requirement that specific approval must be obtained is not intended to prohibit their use but rather to ensure that the contractor has fully investigated their capability to perform the essential functions reliably and can present substantiating evidence for approval before committing designs. Environmental conditions, loads, and life cycle requirements should be consistently applied to all computer components that interface. In addition, separation must be provided so that a failure at an interface will not cause the loss of more than one computing system. Isolation and separation of redundant computing paths must be consistent with the overall redundancy concept.

3.2.4.2 Mechanical signal computation.

3.2.4.2.1 Element loads. Mechanical computer signal transmission elements subjected to the pilots' input force shall be capable of withstanding the loads specified in 3.2.3.2.1.

DISCUSSION

Mechanical computation equipment includes mechanisms and hydraulic and pneumatic components for scheduling, comparing, summing, computing, and gain changing as required for input/output, mode control, and signal conversion and transmission. Most of these computation elements are subjected to the same loads applied to other signal transmission components.

3.2.4.2.2 Geared mechanisms. All geared mechanisms used in mechanical computer components shall meet the requirements of MIL-G-6641.

DISCUSSION

Mechanical computer geared elements shall be designed so that backlash, friction, and inertia are minimized as necessary to provide adequate sensitivity between the input and output of the computer.

3.2.4.2.3 Hydraulic elements. Hydraulic computing elements shall be designed in accordance with MIL-C-5503, MIL-H-8775, MIL-G-8890 or ARP 1281 as applicable. Specification MIL-V-27162 shall be used as a general guide for the design of control valves used in hydraulic computing components.

DISCUSSION

Requirements for hydraulic elements of mechanical computers that are integrated into the flight control system must be consistent with the requirements for other hydraulic elements in the system.

The performance characteristics of valves used in computers must be adequate for the computer to achieve its required performance having taken into consideration the effect of valve gain and friction on valve stability

and hysteresis. Vibration of the computer unit during performance testing as a means of meeting design requirements will not be allowed unless the amplitude and frequency of vibration is equivalent to the installed vibration environment in the aircraft.

3.2.4.2.4 Pneumatic elements. All pneumatic computing elements shall be designed in accordance with MIL-P-8564 and AFSC Design Handbook DH 1-6, Section 3G, Pressurization and Pneumatic Systems, as applicable.

DISCUSSION

Requirements for pneumatic elements of mechanical computers that are integrated into the flight control system must be consistent with the requirements for other pneumatic elements in the system.

A dynamic and steady-state analysis should be accomplished on mechanical computer systems to define the effect on stability and/or steady-state variations caused by manufacturing tolerances, wear, and environmental conditions.

Most real systems are nonlinear to some extent, but the usual region of operation is nearly linear. The purpose of this analysis is to study the effects of nonlinearities and parameter variations inherent in the system, such as friction, stiction, backlash, saturation, tolerances, wear, and changes due to environment, which can be considered and the system designed so that any adverse effects are unimportant or are compensated for.

Due to the failure immunity requirements stated herein, mechanical computers must be designed such that the airplane is capable of continued normal flight and landing after any single failure in the computer system whose failure probability is greater than extremely remote.

Requirements for mechanical computers that are integrated into the flight control systems must be consistent with the other basic system requirements. Consideration must be given to the prevention of jamming mechanical computers by foreign objects, such as rags, bolts, and nuts. This may be accomplished by, but not limited to, adequate clearance between parts, the provision of shear outs and funk struts, or by permanently attached covers as the design dictates.

3.2.4.3 Electrical signal computations.

DISCUSSION

All electrical signal computations for the flight control system may be categorized as being performed by either an analog or a digital computer, and as such, are subject to the following requirements. Signal computations include simple summation and amplification as well as the solution of complex automatic flight control equations. Analog computer equipment includes hardware components required for input/output, mode control, signal processing, and control and signal transmission. Digital computation equipment includes hardware and associated software for data processing, program storage, input/output, control, and signal transmission.

Contrails

3.2.4.3.1 Analog computation. Redundant electrical signal paths within a computer shall be isolated as required by failure immunity and invulnerability requirement specified herein. For failures which may cause a hazardous deviation in the aircraft flight path, the computer shall have provisions for rapidly disabling its command outputs or servos unless other fail-safe provisions exist.

DISCUSSION

The failure immunity requirements of 3.1.3 and the associated reliability and invulnerability requirements stated herein require isolation and separation of redundant channels. This isolation should exist in computer elements as well as in signal transmission lines. The designer should take care that nonlinearities and variations in computer component characteristics due to tolerances, wear, aging, and environmental conditions do not result in failure to meet or maintain performance or stability requirements established for the computer. Careful design will be required to satisfy the stability margin requirements specified herein at the system level.

3.2.4.3.2 Digital computation. At the time of aircraft acceptance by the procuring activity, the total time used in flight control computations for worst case conditions shall not exceed 75 percent of the available computation time allocated for flight control use. Resident and bulk storage shall be sized such that at least 25 percent of each type is available for growth at the time of aircraft acceptance. Computation and sample rate shall be established at a level which ensures that the digital computation process will not introduce unacceptable phase shift, round off error, nonlinear characteristics, and frequency foldover or aliasing into the system response.

3.2.4.3.2.1 Memory protection. Memory protection features shall be provided to avoid inadvertent alteration of memory contents. Memory protection shall be such that neither electrical power source transients within the limits specified nor EMI as specified in 3.2.5.4.1 shall cause loss of program memory, memory scramble, erroneous commands, or loss of ability for continued operation. The transients shall be as specified in MIL-STD-704 for Category C utilization equipment. For applications where system failures could be hazardous to safety of flight, the levels for normal, abnormal, and emergency electric system operation shall apply. For applications which are not critical to safety of flight, the levels for normal operation shall apply. These transient requirements shall apply to cases when all or only one of the redundant power sources are operating.

3.2.4.3.2.2 Program scaling. Parameter scaling, word size, input limiting, and overflow protection shall ensure correct processing and continuous safe operation for all possible combinations of maneuvering demand and gust or other plausible disturbance within the service envelope of the system. Any condition capable of producing an overflow in an essential or flight phase essential function shall be precluded by hardware overflow detection and software or firmware that provides for data recovery and continuous safe operation following an overflow. Scaling shall provide satisfactory resolution to prevent the granularity due to digitizing processes from introducing, into the system response, unacceptable levels of nonlinear characteristics or instabilities.

3.2.4.3.2.3 Software support. For programmable computers a software support package shall be provided to aid in generation and validation of new programs. This support package shall be designed to be executable, either on the airborne computing system for which it was designed or on a large scale digital computer specified by the procuring agency. The support package shall include the necessary software and appropriate peripheral devices in accordance with the contractor data requirements list (DD 1423).

DISCUSSION

One of the more important advantages of digital computation compared with the alternative analog mechanization is the ability to modify and add to the functional capability of the original system with minor impact on cost. This flexibility to accept changing requirements and the more universal application of digital computers requires that the delivered equipment have spare memory capacity and spare computation time available for later use. Reference 12 describes digital vs. analog trades made in a recent development. Conclusions resulting from these trades are presented for the AFCS and the MFCS.

Airborne digital computers are required to accept electrical power supplies having degraded characteristics compared with normal power specifications for ground based computers. Considerable care is required to ensure that the transients to be expected in airborne electrical power generation do not cause loss of program memory. No special requirements should be placed upon the aircraft electrical power system because digital computation techniques are being used.

Fixed point processor hardware is expected to be used for airborne flight control applications because of the reduced cost of this mechanization. This implies that the potential exists for exceeding the word size and causing overflow during arithmetic operations. The computed output in this event can go from large signal in one direction to a maximum hardover in the opposite direction. The program scaling requirement is to design to ensure that the software/hardware design is adequate in this regard.

In the process of providing overflow protection through parameter scaling and word sizing there is an inherent tradeoff between resolution and signal limiting. The effort to prevent overflow through scaling must not degrade the resolution to a level which causes unacceptable limit cycle, dead band, or hysteresis characteristics in the system response.

Scaling shall provide satisfactory resolution to prevent the granularity due to the digitizing process from being apparent to the pilot and providing the source of additional excitation energy for structural elastic modes. Further, scaling shall provide satisfactory resolution and update rate in the signal to the servovalve to prevent the granularity due to the digitizing process from exciting the servovalve in an unstable mode. (Reference 79).

Software and software support packages are needed to ensure that the procuring activity has complete control over maintenance of the delivered

Contrails

equipment and the ability to make modifications as required. Where general purpose computers are used, the following programs should be provided: assembler (or computer), linkage editor or loader, simulator or other debugging aids.

Program documentation must be included as a part of the FCS Analysis Report (4.4.3.1). Program documentation included therein should include:

A master program tape.

A source deck corresponding to the master tape.

Listings of the program.

Flow charts illustrating the program organization, timing and logic.

Input-Output data specifications.

The need for peripheral device is determined by the software used. Typical devices include card and paper tape readers, magnetic tape, disc files, high speed printers, teletypewriters, and magnetic tape output.

3.2.5 Control power.

3.2.5.1 Power capacity. Sufficient electrical, hydraulic, and pneumatic power capacity shall be provided in all flight phases and with all corresponding engine speed settings such that the probability of losing the capability to maintain at least FCS Operational State III airplane performance shall be not greater than extremely remote when considering the combined probability of system and component failure and the cumulative exceedance probability of turbulence. Hydraulic power shall be used to actuate powered essential and flight phase essential MFCS.

DISCUSSION

The trend toward neutral or negative aerodynamic stability, with increased reliance on artificial stabilization in high performance aircraft, increases surface actuation rate demands. This in turn increases the size, weight, and cost of the power systems. Therefore, it is very important that a careful analysis of requirements be made as early as possible in the aircraft development phase since these requirements impact the procurement of many long lead items such as hydraulic pumps, control valves, reservoirs, tubing, and the prime movers such as engine power takeoffs and APU's.

In many cases, the power requirements can only be optimized by determining control rate requirements on a realistic flight simulator "flown" by typical service pilots. The simulation should include turbulence intensity levels, as specified in 3.1.3.7. To determine control surface rates and power requirements under system partial failure conditions, reduced turbulence intensities (such that the combined probability of turbulence and of each selected failure condition equal the maximum allowable failure rate for the specified flight-safety reliability requirement) should be used.

Controls

The intent of the requirement to use hydraulic power for MFCS is not to prohibit use of aerodynamically boosted (control tab) controls. Use of electrical or pneumatic power, except for noncritical applications, will require approval of the procuring activity.

3.2.5.2 Priority. Essential and flight phase essential flight controls shall be given priority over noncritical controls and other actuated functions during simultaneous demand operation. However, no specific priority provisions, such as hydraulic priority valves, are required unless there is a likelihood of simultaneous demands which could prevent one or more essential or flight phase essential actuation systems from meeting their performance requirements. Where provided, priority controls shall be highly resistant to deterioration, binding, or failure while dormant under normal aircraft operations so that they will function as required when conditions dictate. If flight safety can be endangered by failure of such controls, ground checkout means for ready determination of their operability shall be provided and procedures specified.

DISCUSSION

With the use of fully powered flight control systems powered by hydraulic or electric systems that also supply other loads, care must be taken to ensure that power demands of those other functions do not deprive essential flight control actuation subsystems of sufficient power to perform their functions. In many cases, the power demands for landing gear retraction and extension are greater than required for flight control; and, during landing gear operation by hydraulic systems which also supply utility functions (such as where the dedicated hydraulic system has failed), provisions must be made to prevent disruption of flow to the essential flight controls.

3.2.5.3 Hydraulic power subsystems. All hydraulic power generated and distribution systems normally used for flight control shall be designed in accordance with MIL-H-5440 and MIL-H-8891 as applicable. The FCS shall operate in accordance with this specification when supplied with such hydraulic power. Applicable requirements in AFSC Design Handbook DH 1-6, Systems Safety, Section 3F, Hydraulic Systems, shall also be met.

DISCUSSION

Hydraulic power for use with fully-powered essential and flight phase essential MFCS, is specified on the basis of proven performance and ability to provide high force outputs with minimum weight. Use of electrical-mechanical actuation or pneumatic power will require justification and specific approval by the procuring activity. Development work directed toward use of liquid metal as hydraulic fluid is described in Reference 81, and may be further pursued in the future.

Requirements stated herein which may determine hydraulic capacity include: MFCS and AFCS performance (3.1.1 and 3.1.2), failure immunity and safety (3.1.3.2) and operation in turbulence (3.1.3.7).

Redundancy is specified by 3.1.3.1 at the system level. However, it must be recognized that hydraulic system failures can be a major cause of flight control system failure, and the MIL-H-5440 requirement to keep at least one system free of any noncritical system functions has been in effect for many years. There are many aircraft, however, which require two or more power sources for actuation of utility or noncritical flight control functions. In the past, these have often been actuated by an alternate power means, such as a stored-gas-high-pressure pneumatic system for emergency landing gear extension, or an electric motor for emergency flap extension. However, as such loads become higher, such as due to increased aircraft size or speed, there is more incentive to operate hydraulically. Therefore, if it is clearly shown that significant penalties can be avoided by utilizing the "dedicated" hydraulic system as an alternate source of power for the utility or noncritical flight control function, the procuring activity may entertain a request for deviation to the MIL-H-5440 requirement if a reliable isolation shutoff valve can be provided.

3.2.5.4 Electrical power subsystems. All electrical power generation and distribution subsystems used for flight control shall provide electrical power in accordance with MIL-STD-704. The FCS shall operate in accordance with this specification when supplied with power in accordance with MIL-STD-704. Applicable requirements in the following AFSC design handbooks shall be met:

- a. DH 1-4: Electromagnetic Compatibility.
- b. DH 1-6: System Safety.
- c. DH 2-1: Airframe.
- d. DH 2-2: Crew Stations and Passenger Accommodations.

Electrical systems which provide power to essential or flight phase essential controls, shall insure uninterruptible, isolated redundant power of adequate quality to meet FCS requirements after any malfunction not considered extremely remote. Such electrical systems shall, except for basic power source, be independent of failure modes associated with any other electrical system. Essential and flight phase essential FCS shall be automatically provided alternate sources of power where interruption could result in operation below FCS Operational State III. A protected alternate source of power shall be provided for all essential or flight phase essential control signal transmission paths sufficient to continuously maintain at least FCS Operational State III performance in the event of loss of all electrical power supplied from engine-driven generators. Control systems employing both ac and dc power inputs shall normally have interlocks incorporated to disconnect both power inputs should either type of power be lost. However, if the loss of either power source can be shown to be equivalent to loss of both or FCS Operational State III or better is maintained with either power source, interlocks are not required.

3.2.5.4.1 Electromagnetic interference limits. The FCS shall operate within the limits of MIL-E-6051 and MIL-STD-461 environment. Electro-magnetic interference created by the systems and components during normal operation shall be within the limits of MIL-E-6051 and MIL-STD-461, respectively. Failure modes of all onboard systems and equipment, including flight controls, wherein these limits may be exceeded shall be identified in addition to sources of conducted EMI that may be detrimental to FCS operation. Additionally, the estimated magnitude of EMI generated by these failure modes shall be provided for the assessment of the safety of the EFCS.

3.2.5.4.2 Overload protection. Overload protection of the primary power wiring to the system or component shall be provided by the airplane contractor. Installation requirements of the system or component specification shall specify the values of starting current versus time, surge currents if applicable, normal operating current, and recommended protective provisions. Additional protection as necessary shall be provided within the system or component. Such circuit protection shall not be provided in signal circuits or other circuits where opening of the protective devices will result in unsafe motion of the aircraft.

3.2.5.4.3 Phase separation and polarity reversal protection. In systems affecting flight safety, phase reversal and polarity reversal shall be prevented as far as practical by keying, physical restraints or other positive means.

DISCUSSION

Electrically powered controls which can be considered essential to safe flight include AFCS autoland controls, certain command augmentation and stability augmentation systems, and all Electrical Flight Control (fly-by-wire) systems. In order to meet flight-safety requirements, these systems are redundant so that the critical control function will be maintained even when failures occur. Their electrical power sources in the FCS and from the aircraft must be equally dependable and redundant.

The requirement for redundancy has the greatest impact on the design of generating system configurations. A single fault on any part of a paralleled multichannel generating system will result in loss of power to all airplane systems until the fault is cleared. During certain extreme cases, this could take up to 3 or 4 seconds and could occur during a critical period such as the final moments of an automatic landing. Electrical isolation of the generating systems would prevent a single fault from affecting more than one channel of flight-critical equipment.

The degree of isolation and the number of isolated channels that may be required will be dependent on the specific requirements for the airplane in question. In general, an independent source of electrical power will be required for each redundant channel of essential or flight phase essential control systems.

Isolated Versus Parallel Operation of Generators

Parallel operation of multichannel (three or more) generating systems may offer considerable performance and economic advantages over a system composed of isolated channels. However, parallel operation includes the possibility of a single fault causing trips of more than one channel or an overload momentarily affecting and degrading power to all airplane loads. Also, the load division circuitry required for parallel operation adds complexity to the generating system and increases the chances for malfunctions which could cause the temporary loss of one or more generating channels.

Essential and flight phase essential control systems are provided in varying degrees of redundancy, and this imposes the requirement that power sources to these systems be equally reliable. A parallel system, if composed of three or four generating channels, will be a highly reliable source, but it is vulnerable to several single failure modes (failure of current transformer shorting contacts, excitation loss, open current transformer loop, main bus or load circuit faults, synch bus faults), which can transiently interrupt or seriously degrade the quality of power on all main buses simultaneously. Abnormal power quality will be supplied to all loads for a time ranging from 0.020 to 3.0 seconds. This time is dependent on the specific type of failure and the delays associated with the protective circuitry. It should be noted, however, that simultaneous failures will be normally of very short duration and will be automatically cleared from all but the faulted bus. In the unlikely event that multiple failures result in an inability of the system to automatically clear a fault, proper crew action can restore power to the unfaulted buses. Past experience shows that nuisance trips can occur which may result in overloading of the remaining channels and a brief "all power lost" situation.

The required reliability of power sources may be provided most simply by isolating redundant generating channels and, in effect, providing two, three, or four generating channels with no interconnecting ties between buses. This isolation ensures that a fault on one channel cannot affect the others. However, isolation also means that system overload capabilities are decreased from those of a parallel system of equal rating; and, isolation may impose weight penalties on the airplane design if sufficient generating system capacity with provisions for future growth and overload capability is to be obtained. The degree to which power sources must be isolated is peculiar to each design and application.

Redundant Power Sources

The concept of isolation, as mentioned in the paragraph above, provides redundancy equal to the number of generating channels. The redundancy of power sources, however, is expected to be equal to the number of redundant channels of flight-critical equipment. Autoland systems are being proposed in triple redundant, fail-operative versions. If this system was installed in a two-engine airplane (two isolated generating channels) a third power source should be provided. A battery-inverter standby system may be considered as a redundant source, but its capacity

severely limits the loads which can be operated from it. A third isolated generating channel, operating continuously, would be required to satisfy the redundancy definition, and its capacity must be adequate for one set of load equipment. Monopropellant emergency power turbine generators are now being installed in several fighter aircraft for an independent backup power source.

A combination of parallel and isolated operation can also be considered (for example, a four channel system operating with channels one and two paralleled and channels three and four parralleled, but one and two are isolated from three and four). These four channels are essentially two isolated sources, and if more redundancy is required, additional isolated sources would be required.

Power Limiting Devices

As mentioned above, the degree of isolation of isolated generating system channels can be compromised by a switchable bus. A transfer bus (to which essential loads are connected) is generally arranged so that loss of power to it would cause it to be transferred to the alternate source of power. This switching capability may well compromise the integrity of both of these power sources in that a fault in the critical load equipment (or on its bus) could be applied to one bus and then the other after switching. For this reason, a transfer bus scheme should not be considered for an airplane with essential electrical control systems unless a device is included in series with the transfer bus that eliminates the possibility of a single fault causing unacceptable disturbances to more than one power source.

The development of a practical and reliable power (or current) limiting device for this purpose would simplify power system design for critical loads. Some of the basic requirements of a power limited device are as follows:

Sized to coordinate with the largest thermal circuit breaker connected to the priority bus.

Sized to carry the maximum startup load connected.

Capable of dissipating the electrical losses incurred during maximum load and faulted operation.

Self-cooling--no cooling air would be supplied.

Reliability must be of exceptionally high order.

Failures must be passive, i.e., must not fault the main bus due to component failure of the device.

Waveform deterioration during limiting mode must not be severe enough to cause damage to any of the connected loads.

3.2.5.5 Pneumatic power subsystems. Pneumatic power using ram-air, engine bleed air, stored gas, mechanically compressed air, or generated gas may be used for noncritical flight control functions and for driving hydraulic pumps and electric generators. High pressure pneumatic systems used for FCS functions shall conform to MIL-P-5518, the applicable requirements in AFSC Design Handbook DH 1-6: System Safety, Section 3G: Pressurization and Pneumatic Systems, and the applicable requirements under 3.2.5.1, Hydraulic Power Subsystems, herein. Engine bleed air systems shall conform to MIL-E-38453.

DISCUSSION

This requirement was expanded to include ram-air and engine bleed air sources in recognition that low-pressure pneumatic sources are readily available on jet aircraft and have been and will continue to be considered and used for powering noncritical flight control functions. Neither high-pressure nor low-pressure pneumatic sources appear feasible for powering essential or flight phase essential functions, other than hydraulic pumps and electric generators, at this time.

This requirement is not meant to apply to boundary layer control as may be used for short field takeoff and landing applications.

3.2.6 Actuation

3.2.6.1 Load capability

3.2.6.1.1 Load capability of elements subjected to pilot loads. Elements of actuation systems subjected to loads generated by the pilot(s) shall be capable of withstanding the loads due to the pilot's input limits specified in MIL-A-8865, Section 3.7, Flight Control System Loads, taken as limit loads, unless higher loads can be imposed such as by a powered actuation system or loads resulting from aerodynamic forces. Control signal boost actuator outputs may be load limited by spring cartridges.

3.2.6.1.2 Load capability of elements driven by power actuators. Elements subjected to loads generated by a powered actuation system, including all parts of the actuator shall be capable of withstanding the maximum output of the actuation system, including loads due to bottoming, or the maximum blowback load, as controlled by pressure relief valves or other load limiting provisions, whichever is greater, as the limit load. Ultimate load capability shall be 1.5 times limit load. In dual load path design, each path shall be capable of sustaining load as specified in 3.1.11.1.2 without failure.

DISCUSSION

These requirements have been included to clearly define the load capability requirements for both the signal input and the output force elements of actuation subsystems and apply to control signal boost actuators as well as to surface positioning actuators.

3.2.6.2 Mechanical force transmitting actuation. For control cable actuation, the requirements specified in 3.2.3.2.4 and subparagraphs apply. For push-pull rod actuation, the requirements specified in 3.2.3.2.5 and subparagraphs apply.

3.2.6.2.1 Force transmitting powerscrews. Powerscrews with rotary input and linear output motion may be used to actuate relatively low-duty-cycle flight control surfaces, such as wing flaps and trimmable stabilizers, but specific approval from the procuring activity shall be obtained before use in high-duty-cycle applications. Nonjamming mechanical stops shall be provided at both ends of the screw to limit travel of the nut; and, they shall be designed to withstand all possible loads, including possible impact loading, without failure. Provisions shall be incorporated into the nut to minimize entry of sand, dust, and other contaminants; to retain its lubricant; and to preclude the entry or retention of water. However, positive sealing is not required if the screw is installed such that it is protected from such contamination or is inherently resistant to wear and jamming by contamination.

3.2.6.2.1.1 Threaded powerscrews. Standard thread forms only shall be used, and the thread roots shall be rounded as necessary to preclude stress cracking. Lubrication provisions shall be adequate for controlling efficiency, wear, and heating to acceptable values. Where in service lubrication is necessary, lube fittings in accordance with 3.2.7.2.5 shall be provided. If the design is dependent on inherent friction to maintain irreversibility, this characteristic must be adequate under all expected operating conditions, including the full range of loads, both steady loads and reversing or variable-magnitude loads which may be encountered due to control surface buffeting or buzz, temperatures, and environmental vibration over the full service life of the unit.

3.2.6.2.1.2 Ballscrews. An adequate number of balls and ball circuits shall be provided to keep individual ball loading within allowable nonbrinelling limits. On units used in essential and flight phase essential applications, at least two separate independent ball circuits and a secondary load path with load capability per 3.1.11.1.2 shall be incorporated.

DISCUSSION

Force transmitting powerscrews have been used for a long time for non-critical flight control applications (e.g., landing gear actuation on B-17, B-29, B-50, and B-47 airplanes, and flaps and stabilizer trim on B-52, KC-135, and many commercial airliners), but as yet not for actuation of essential control surfaces. The requirement that specific approval must be obtained before using powerscrews for high-duty-cycle applications is not intended to prohibit their use, but rather, to ensure that the contractor has fully investigated their capability to perform reliably under required conditions and can present substantiating evidence for approval before committing the design. Trim actuators including those commanded by AFCS, are usually considered in the low-duty-cycle category. A nonjamming stop is one which does not prevent actuation of the nut by the normal means.

One detail point to note here is that highly loaded threaded powerscrews develop considerable friction, and the design and lubrication provisions must be thoroughly evaluated by analysis and supplemented by rigorous testing under realistic operating conditions. Lubrication provisions must be adequate for controlling efficiency, wear, and heating to acceptable values.

A prime example is the F-111 Acme threaded powerscrew used for variable wingsweep actuation. An extensive trial and error development program, in which a great number of material combinations were evaluated, was required to produce the grease-lubricated teflon and fiberglass cloth lined screw nut design which eventually met the design requirements.

3.2.6.3 Mechanical torque transmitting actuation. Specific approval from the procuring activity must be obtained before use of such provisions in essential and flight phase essential applications. Backlash accumulation shall not prevent the system from performing its required function throughout the service life of the airplane.

3.2.6.3.1 Torque tube systems. Torque tubes which are exposed to possible misuse, such as support for maintenance personnel, shall be shielded from such misuse or shall be of adequate stiffness to prevent damage to the installation. Each torque tube, in a linked run of tubes shall be removable and reinstallable in the aircraft without disturbing the support, component, or other interfacing system element at either end of the torque tube. Guards which are capable of containing a broken torque tube against thrashing shall be installed in appropriate locations to prevent damage to wiring, tubing, and other equipment. The rated operating speed of a torque tube system shall be no greater than 75 percent of the critical speed.

3.2.6.3.1.1 Torque tubes. Torque tubes shall have a minimum wall thickness of 0.035 inch and shall be seamless, except that steel tubes, seam welded by the electrical resistance method, may be used.

3.2.6.3.1.2 Universal joints. Universal joints shall be in accordance with MIL-J-6193 or MIL-U-3963, as specified in AFSC Design Handbook DH 1-2, General Design Factors, Section 4C, Universal Joints, and shall not be used for angularities greater than specified therein or recommended for the specific component by the manufacturer.

3.2.6.3.1.3 Slip joints. Adequate engagement shall be provided to insure that disengagement will not occur under all expected operating conditions, or due to buildup of adverse manufacturing and installation tolerances.

DISCUSSION

Torque tubes systems have been used on many aircraft, primarily for actuation of trailing edge flaps, and the foregoing requirements have become well established. The requirement that specific approval is required before using torque transmissions in essential applications is not intended to prohibit their use, but rather to ensure that the contractor has fully investigated all components, e.g.,; gear boxes, powerscrews, rotary actuators, etc., to ensure they can perform reliably under all operating conditions.

All torque tubes should be mounted on antifriction bearings with supported couplers (jackshafts mounted to structure on antifriction bearings) spaced at close enough intervals and with sufficient misalignment capability (within the couplers) to prevent undesirable bending or whipping of the tubes. In addition, the prevention of spark generation in fuel system areas should be given careful consideration in the detail design.

A minimum of parts, joints, and related components should be used to accomplish the required purpose; however, it must be possible to remove the torque tube sections from the airplane and replace them readily.

3.2.6.3.2 Gearing. All gear boxes used in actuating systems shall meet the requirements specified in MIL-G-6641.

3.2.6.3.3 Flexible shafting. Flexible shafting may be used providing that minimum bend radii, rated rotational speed, and rated torque are not exceeded, and that extreme temperatures and other operational variations and environments do not cause binding. Flexible shafts shall be installed with the fewest possible bends and shall be securely fastened to supporting structure at close intervals.

3.2.6.3.4 Helical splines. Involute helical splines shall use only the ASA standard tooth forms Numbers 1 through 5. Ballsplines shall meet the requirements specified in 3.2.6.2.1.2 for ballscrews.

DISCUSSION

Helical splines (also known as Yankee screw drivers) have not yet been used in flight control actuation systems but are getting more and more attention as the needs to design mechanisms which can transmit high torque (or translate linear force to torque) in thin airfoil sections increase. When used, lubrication provisions must be adequate for controlling efficiency, wear, and heating to acceptable values. If the design is dependent on inherent friction to maintain irreversibility, this characteristic must be adequate under all expected operating conditions including the full range of loads, temperatures, and environmental vibration over the full service life of the unit, both steady loads and reversing or variable-magnitude loads which may be encountered due to control surface loads, buffeting, or buzz.

3.2.6.3.5 Rotary mechanical actuators. Rotary mechanical actuators used with a through shaft which attaches to torque tubes at both ends, thus serving as a portion of the torque distribution system, shall be capable of reacting full system torque in both the forward direction (due to a jam anywhere in the system) or in the backdriving direction (due to overrunning load), unless provided with a torque limiter and no-back brake or other devices which would preclude such loading.

3.2.6.3.6 Torque limiters. Where used, torque limiters designed to slip or lock to adjacent structure shall be properly located in the transmission system to prevent drive loads in excess of control surface limit load from being transmitted past the limiter in the event of overload or jamming.

Contrails

The rate of application of the limiter(s) and the spring rate of the transmission system shall be matched so that the stress in any member due to sudden application does not exceed its yield strength.

3.2.6.3.7 No-Back brakes. No-back brakes shall prevent back driving (or feedback) forces imposed on the output of an actuating mechanism from being converted to torques which can cause the input shaft to rotate. In no-back brakes of the dissipative type, provisions shall be included to distribute heat generated by the brake so that temperature limitations are not exceeded.

DISCUSSION

Rotary mechanical actuators (often referred to as power hinges) with torque limiters and no-back brakes have been used in some relatively recent applications e.g., wing tip fold actuation on the RS-70, weapon bay door actuation on the F-111, and leading edge flap actuation on the Boeing 747) but, prior to their selection for actuation of the B-1 rudder, have not been used for actuation of a primary control surface.

As an alternate to a no-back brake, a mechanically irreversible actuator may be used providing it can react rated static limit load applied to the output coupling with the input coupling disconnected, without being back-driven while being subject to any vibration condition within the required vibration envelop or spectrum. Where torque limiters are used, it is desirable that they release upon removal of the downstream jamming load without a requirement for change in the upstream torque value or direction.

3.2.6.4 Hydraulic actuation. Hydraulic actuation components shall be designed in accordance with MIL-H-8775 or MIL-H-8890, and specific component specifications as applicable. If hydraulic bypass provisions are necessary to prevent fluid lock or excessive friction load or damping, bypassing and resetting shall occur automatically when system pressure drops below or returns to the minimum acceptable value for actuation. In actuation systems designed for manual control following hydraulic failure, provisions shall be made to permit bypassing of the hydraulic systems for checkout purposes and to permit pilot training with the emergency manual system.

3.2.6.4.1 Hydraulic servoactuators. Hydraulic servoactuators shall be designed in accordance with ARP 1281. Electrohydraulic servovalves shall be designed in accordance with MIL-V-27162. If electrical-input hydraulic servovalves having mechanical feedback of actuator position are used, the applicable requirements of ARP 988 shall be met.

DISCUSSION

The availability of ARP 1281 by the SAE allows the deletion of a number of detail design requirements for hydraulic servoactuators from this specification. It is prepared in the format of a MIL specification, and is planned to be released as such following proper coordination.

Contrails

MIL-V-27162 for electrohydraulic servovalves has recently been updated incorporating application requirements in ARP 490. Electrohydraulic servovalves with mechanical feedback of actuator position are not generally used, and ARP 988 is considered adequate at this time. One application where they were used, which was used as the primary model for the requirements in that document, was in the spoiler servoactuators on the F-111.

Actuator Stability

ARP 1281 specifies that the detail specification shall indicate required servoactuator and mounting structure spring rate, structural mounting arrangement of mechanical input member, and stability requirements. To determine the absolute stability of an actuation system, the open-loop transfer functions may be written, and Nyquist's stability criterion applied. However, the basic requirements for stability are satisfied whenever the actuator's dynamic stiffness is greater than its static stiffness. Limit-cycle type instabilities can also arise as a result of adverse distribution of nonlinearities in the system due to wear of components, friction, and erosion of the control valve.

The actuator's dynamic stiffness, which is discussed following 3.1.11.2, must be higher than its static stiffness in order to produce a stable system (unless complex frequency-dependent pressure gain control is employed). Overall stiffness, is basically determined by flutter resistance requirements rather than actuator stability or dynamic response requirements. The spring rate of the actuator and backup structure should be as high as possible but not to the extent that weight penalties are introduced after the flutter stiffness requirements are met.

With the advent of so-called irreversible flight controls, the philosophy has often been to design the stiffest system possible. Normally, this has also meant the highest possible static stiffness, which has often resulted in a number of stability problems.

The proper approach to the stiffness design is to first of all determine what is the lowest permissible static stiffness for the system at hand. The main considerations are: flutter resistance, required surface position resolution, the allowable change in gearing between the control surface and the pilot's controls with hinge moment changes, and the allowable control surface deflection with no input command which will not appreciably change the characteristics of the "free" airplane response.

The automatic flight control systems are usually not critical with respect to loss of servopositioning effectiveness caused by low static stiffness. The reason is that the autopilot systems normally have "q" programs which lower the loop gains with increasing airspeed. Low static stiffness will merely add to the intentional "q" program and may consequently be compensated for during design testing.

If a particular surface actuation system requires a high static stiffness approaching or exceeding the dynamic stiffness requirement, then either the dynamic stiffness must be increased or a mechanical or electrohydraulic compensating network must be provided.

3.2.6.4.2 Motor-pump-servoactuator (MPS) packages. This is defined as an integrated servoactuator package which incorporates an electric motor driving a hydraulic pump, a hydraulic fluid reservoir, a servoactuator, and necessary accessories packaged in a single, self-contained LRU. Individual components within the integrated package shall be designed in accordance with the applicable requirements of the corresponding component specifications. Essential or flight phase essential applications require specific approval from the procuring activity.

DISCUSSION

Such integrated packages have been used for a number of years for surface control on British aircraft starting with the Boulton Paul delta research aircraft, P111 and P120 the Saunders Roe "Princess," the Vickers "Valient," the Hawker Siddeley "Vulcan" the BAC "VC-10," and the Short "Belfast." In these applications, they are used as the primary control without connection to the main hydraulic system.

Development has continued in this country on the AFFDL ADP 680-J program where limited-authority units are being considered as backup to the main power servos to provide survivability capability. See References 49, 65 and 66.

3.2.6.4.3 Actuating cylinders. Actuating cylinders without control valves and feedback provisions in the same LRU shall be designed in accordance with MIL-C-5503, except that the life cycling requirements shall be modified to reflect the specific usage. (See 3.1.12)

DISCUSSION

MIL-C-5503 has been in use for many years and is still considered adequate for nonservoactuator type actuating cylinders, except for the endurance requirements. Endurance requirements (in MIL-C-5503C) are specified for utility system cylinders and for flight control cylinders, both manually controlled (2,000,000 cycles) and automatically controlled (5,000,000 cycles) with packing changes permitted after each 500,000 cycles of operation.

Such requirements are strictly arbitrary and do not reflect needs for any specific application. In many cases, especially large Class III aircraft (per MIL-F-8785) and helicopters, endurance requirements may be considerably greater. Also, with the use of plastic or metal dynamic seals (or combinations thereof) much higher seal life than is possible with O-rings is obtainable. Allowing changes at 500,000-cycle intervals may impose a burdensome maintenance penalty.

3.2.6.4.4 Force synchronization of multiple connected hydraulic servo-actuators. In essential and flight phase essential flight control actuator installations employing multiple connected servoactuators, the actuators shall be synchronized as necessary to assure specified performance and fatigue life as specified in 3.1.11.3 in the structure between actuators without undue structural weight penalties.

DISCUSSION

Because of the need for higher reliability in the actuation subsystems of certain high performance aircraft to both maintain control of and prevent flutter of essential aerodynamic surfaces, multiple side-by-side arrangements of three or four servoactuators, rather than dual-system tandem actuators, are being considered. Gross missynchronization can lead either to significant reductions in the fatigue life of the actuators and their support structure or overdesign weight penalties to obtain the desired life.

3.2.6.4.5 Hydraulic motors. Hydraulic motors may be used to actuate relatively low-duty-cycle, noncritical flight control surfaces, such as wing flaps, but specific approval from the procuring activity must be obtained before use in high duty cycle noncritical applications or in any essential or flight phase essential application. They shall be designed in accordance with MIL-M-7997.

DISCUSSION

The requirements that specific approval must be obtained before using hydraulic motors in systems controlling high duty cycle or essential functions is not intended to prohibit their use, but rather, to ensure that the contractor has fully investigated their capability to perform the essential functions reliably and can present substantiating evidence for approval before committing designs. One problem that has been encountered in previous designs has been a relatively high rate of wear in the gear reduction train leading to excessive backlash and deterioration in system stiffness.

3.2.6.5 Electromechanical actuation. Electric power may be used to actuate relatively low-duty-cycle, noncritical flight control functions, such as for trim and in the AFCS, but specific approval from the procuring activity must be obtained before use in essential and flight phase essential applications. Electromechanical actuation components shall be designed in accordance with MIL-E-7080, and specific component specifications as applicable, and the following. Performance requirements shall be adequate for intended application.

3.2.6.6 Pneumatic actuation. Pneumatic power may be used to actuate relatively low-duty-cycle, noncritical flight control surfaces, such as wing flaps, but specific approval from the procuring activity must be obtained before use in essential and flight phase essential applications.

3.2.6.6.1 High-pressure pneumatic actuation. High-pressure pneumatic actuation components shall be designed in accordance with MIL-P-8564.

3.2.6.6.2 Pneumatic drive turbines. Pneumatic drive turbines shall be designed in accordance with MIL-D-7602 when used for FCS purposes.

DISCUSSION

Reference 82 describes a unique low pressure pneumatic, high torque rotary actuation technique applicable to aircraft primary or standby flight control.

3.2.6.7 Interfaces between actuation systems, support structure, and control surfaces

3.2.6.7.1 Control surface stops. Surface stops shall be provided each flight control surface to positively limit its range of motion. Stops shall be located so that wear, slackness, or takeup adjustments will not adversely affect the control characteristics of the airplane because of a change in the range of surface travel. Each stop shall be able to withstand any loads corresponding to the design conditions for the control system. Where power control actuators are attached directly to the control surface, stops shall be provided within the actuator. Such actuators shall not only be designed for maximum impact loads, but for the cumulative fatigue damage due to load cycling predicted during flight and due to bottoming during ground checkout and taxiing. Where control valve command input stops are provided, the actuators shall be designed for maximum impact stop loads, and not for fatigue damage due to bottoming, except as normally encountered with the input stops and feedback provisions functioning.

3.2.6.7.1.1 Adjustable stops. All adjustable stops shall be positively locked or safety wired in the adjusted position. Jam nuts (plain or self-locking type) are not considered adequate as locking devices for this application.

DISCUSSION

Control surface stops are required to prevent exceeding allowable travel limits such as dictated by: aircraft controllability requirements, prevention of damage to the control surface or its primary surface, and/or personnel safety considerations when the airplane is on the ground. Where control valve command input stops are provided, the actuator must still withstand bottoming loads in the event of: misrigging, failure of the valve stops or input links, failure or malfunction of feedback provisions, loss of hydraulic pressure where other actuators or aerodynamic forces can bottom the actuator, and when the system is depressurized normally after each flight. Where a power control actuator is located remotely from the surface, the actuator may be used as the primary surface stop, providing the connecting linkage has an extremely remote failure probability.

3.2.6.7.2 Control surface ground gust protection. All flight control surfaces shall have provisions to prevent damage from ground wind loads as specified in MIL-A-8865. However, no separate provisions are required if the damping characteristics of installed flight control actuators suffice for gust protection.

3.2.6.7.2.1 Control surface locks. Where control surface locks are used, the lock system shall be internal within the airplane. External locks may be used for helicopter rotors. The locks shall either engage the surfaces directly or lock the controls as near to each surface as practicable and shall be spring loaded to the unlocked position. Control surface locks shall be designed to preclude attempting takeoff with controls locked.

3.2.6.7.2.2 Protection against inflight engagement of control surface locks. Control surface ground gust locks and their controls shall be designed to preclude their becoming engaged during flight.

3.2.6.7.3 Control surface flutter and buzz prevention. All flight control surface actuation systems controlling surfaces which are not dynamically balanced shall be effectively irreversible or provided with sufficient damping to prevent flutter, buzz, or other related dynamic instabilities for all operating modes and meet the requirements of MIL-A-8870. No active powered compensation technique or mechanization designed to artificially increase effective stiffness, damping, or natural frequency shall be used without prior approval of the procuring activity.

DISCUSSION

The control surfaces of any airplane which can be nosed over or up by high winds when the control surface is displaced from the neutral position should be locked in the neutral position. Servo tab and spring tab type surfaces need not have locks or snubbers installed if it can be shown that the connecting springs and linkages are sufficient to prevent gust damage to any of the components.

Specific things which can cause inadvertent engagement of gust locks include inadvertent operation of cockpit control lever, relative deflections between the lock control system and the aircraft, component failure, combat damage, etc.

See discussion following 3.1.11.2, Stiffness, for some of the most pertinent requirements specified in MIL-A-8870. When detailed flutter analyses and wind tunnel tests are not yet available, the following general guidelines may be used:

For the prevention of flutter, each control surface including its actuation system should have a minimum natural rotational frequency about the control surface hinge line of 1.5 times the natural torsional frequency of the main structure to which it is attached. This should provide sufficient separation of natural frequencies to prevent oscillations of the control surface and main surface or structure from coalescing and causing flutter.

For the prevention of transonic buzz instability, experimental data indicates that the system will be sufficiently stiff if its natural rotational frequency

$$\omega_n \geq \frac{.21a}{b} \text{ rad/sec where,}$$

a = speed of sound in ft/sec

b = semichord of hinged surface at the 3/4 span in feet.

Transonic buzz was first encountered on jet airplanes and has to be considered on all aircraft which fly at high subsonic or transonic speeds. It is still

not well understood, but experimental data taken at the Wright Air Development Center in the 1950's led to the development of the equation noted above.

Required actuation system stiffness

With the required natural rotational frequency identified, the required actuation subsystem spring rate ($K_{req'd}$) can be determined from the following equation:

$$K_{req'd} \geq \frac{\omega_n^2 I}{l^2 g} \text{ lb/in. where}$$

ω_n = required natural rotational frequency in rad/sec.

I = moment of inertia of the control surface about its hinge line in lb-in.²

l = minimum actuation lever arm in inches.

g = gravitational constant: 386 in./sec².

Actuation system stiffness determination

To meet the fail-safe stability requirement, it is usually necessary to provide the required spring rate with only one actuator per control surface operating even though multiple actuators are installed. The actual effective spring rate of a flight control surface actuation subsystem (K_{eff}) is the total spring rate of the supporting structure from the actuator to the hinge line (K_{S1}), the spring rate of the actuator (K_{act}), and the spring rate of the surface structure (K_{S2}) summed in series as shown below:

$$\frac{1}{K_{eff}(j\omega)} = \frac{1}{K_{S1}} + \frac{1}{K_{act}(j\omega)} + \frac{1}{K_{S2}}$$

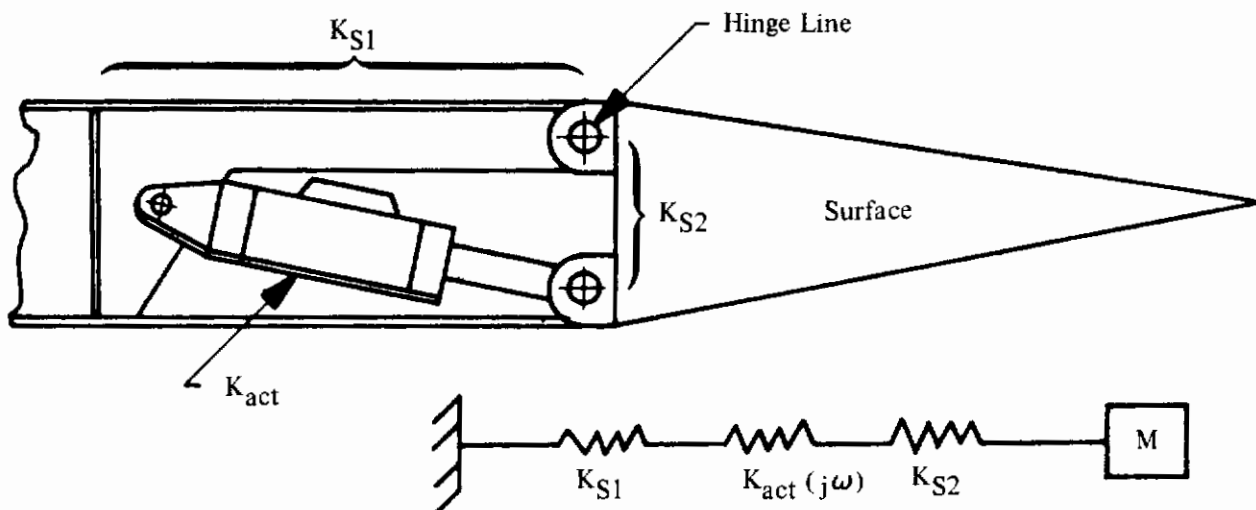

Figure 15D. Actuator stiffness determination

Frequency relationship

The frequency dependence of the net stiffness of a typical hydraulic flight control servoactuator is shown below:

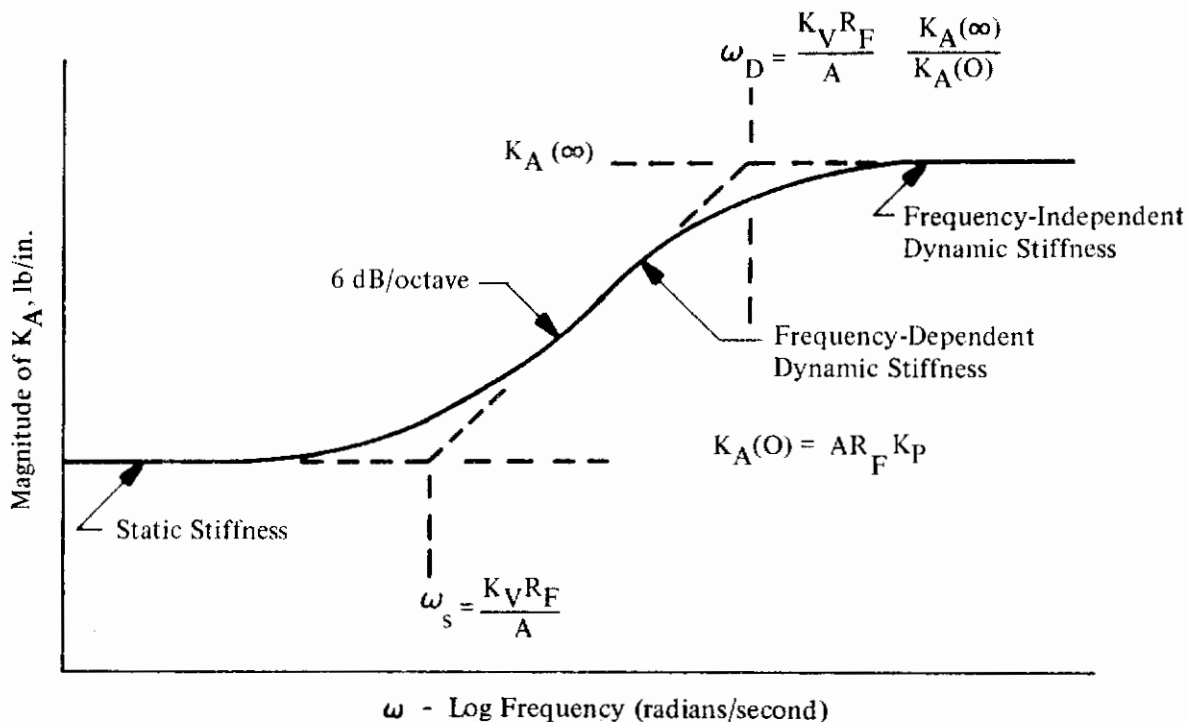

Figure 16D. Actuator stiffness vs. frequency

Static stiffness is the actuation system stiffness at zero frequency. The stiffness is essentially constant at all frequencies up to the static stiffness corner frequency, ω_s , which can be calculated as follows:

$$\omega_s = \frac{K_V R_F}{A} \text{ rad/sec, where}$$

$$K_V = \text{No-load valve gain, in.}^3/\text{sec/in.}$$

$$R_F = \text{the feedback ratio, in./in. (ratio of valve displacement to piston rod displacement).}$$

$$A = \text{effective area of the actuator piston, in.}^2.$$

Static stiffness $K_A(0)$, is generally governed by three factors as follows:

$$K_A(0) = A R_F K_P$$

$$K_P = \text{the effective pressure gain, psi/in., including actuator leakage and structural feedback effects. (Any other pressure gain reducing factors, such as pressure feedback, must also be included.)}$$

Contrails

Dynamic stiffness is determined by the solution of complete transfer functions, and becomes constant at all frequencies above the frequency-independent dynamic stiffness lower limit, ω_D , which can be determined as follows:

$$\omega_D = \frac{K_V R_F}{A} \left[\frac{K_A(\infty)}{K_A(0)} \right]$$

The frequency-independent dynamic stiffness, $K_A(\infty)$, of the actuator is made up of a number of incremental springs. For conventional linear actuators, the primary springs are due to the actuator structure ($K_{act\ str}$), i.e.: the cylinder barrel, piston rod, and end caps, the bearings (K_{brg}), and the fluid compliance (K_{fluid}), which are also summed in series as follows:

$$\frac{1}{K_A(\infty)} = \frac{1}{K_{act\ str}} + \frac{1}{K_{brg}} + \frac{1}{K_{fluid}} \text{ where,}$$
$$K_{fluid} = \frac{4 \beta \eta A}{X_t}, \text{ where } \beta = \text{fluid bulk modulus, psi}$$
$$\eta = \text{volumetric efficiency}$$
$$A = \text{effective area, in.}^2$$
$$X_t = \text{total stroke, in.}$$

In calculating the fluid spring, a realistic value for bulk modulus should be used. Most available data represents well-bled fluid with very little entrained air. For normal situations, the value used should be reduced to 80 percent of the ideal; and, the tangent modulus (at the normal actuator pressure) rather than the secant modulus should be used. If the moving parts of the actuator(s) are heavy in relation to the surface weight, they must be appropriately accounted for.

Stiffness improvement methods

On stiffness-critical actuating systems, the structural springs may often be more rigid than the fluid spring, and as a result, the fluid compliance may have a great effect on the overall stiffness of the system. However, increasing fluid stiffness by increasing actuator piston area introduces weight penalties in two ways. It increases the size and weight of the actuator, and it increases the flow demand on the hydraulic system which, in turn, can increase the size and weight of hydraulic pumps, fluid lines, reservoirs, and other components, plus weight of all structure which must withstand actuation loads. It may be much more economical (of weight) to stiffen the structural springs once the need is recognized.

Controls

In situations where large weight penalties would be incurred to meet the frequency requirements by stiffening existing structure and components, other improvement methods such as the following can be considered:

Utilizing inactive actuators. Where multiple actuators are used to satisfy reliability requirements (which is the normal practice for essential controls), they can be designed to contribute stiffness and damping to the system even though hydraulic supply pressure is lost through hydraulic system failure. This could be accomplished by pressure activated valving. When pressure is lost, a spring loaded valve connects the input and output of the control valve to a compensator at return line pressure. The servo no longer supplies power to the system but does provide stiffness when the metering valve is closed and damping when the valve is open. This concept adds some complexity, but the weight addition could be considerably less than for stiffening existing structure and actuators.

Adding an additional actuator. The concept here is to design an actuation system with one more channel than is required for redundancy. Thus, stiffness may be satisfied with two channels instead of one. For example, in a surface control system that requires three redundant channels, each channel must satisfy the maximum hinge moment and minimum stiffness for the situation when the other two have failed. However, if four channels are used, the maximum hinge moment can be satisfied with two actuators instead of one, and as a result, each actuator will be exactly half the size of those in the three-channel design. With smaller actuators, each channel will be more compliant. However, stiffness now can be satisfied with two parallel actuation channels, and the result is a system that is more rigid than the three-channel system. A scheme of this type to improve stiffness may also have a weight advantage.

Adding an independent damper. Several types can be considered. One is a quasi-servo damper channel similar to the active servoactuators. When the spool valve is closed, this damper provides an additional load path with the stiffness characteristics of the active channels. When the valve is open, in response from the pilot or AFCS, the quasi-servo acts as a viscous damper.

Pure viscous fluid dampers are also used, and there are several linear or rotary types which may be considered. They can be installed parallel to the actuation channels or at any convenient location on a surface such as on the hinge line. They absorb energy from high-frequency, high-amplitude vibrations and dissipate it as heat. If a damped surface experiences considerable activity, throughout a flight, the damper may absorb energy faster than can be radiated and create a high temperature problem.

Adding an actuation stiffness compensation network. The basic actuator stiffness can be modified by introducing hydromechanical or electrical compensating networks within the actuator loop. In the most general case, this can be done by sensing load pressure, passing this signal through a bandpass filter, and feeding this signal as positive or negative feedback to the control valve.

3.2.7 Component design

3.2.7.1 Common requirements

3.2.7.1.1 Standardization. Where practical, contractor designed equipment which has been approved for use in some models of aircraft shall also be used in later model airplanes if the installation and requirements are similar. Tolerances shall be such that interchange of any LRU with any other part bearing the same part number shall not require resetting of parameters or readjustment of other components in order to maintain overall tolerances and performance.

3.2.7.1.2 Interchangeability. Like assemblies, subassemblies, and replaceable parts shall meet the requirements of MIL-I-8500 regardless of manufacturer or supplier. Items which are not functionally interchangeable shall not be physically interchangeable unless specifically approved by the procuring activity.

3.2.7.1.3 Selection of specifications and standards. Specifications and standards for necessary commodities and services not specified herein shall be selected in accordance with MIL-STD-143.

3.2.7.1.4 Identification of product. Equipment components, assemblies, and parts of flight control systems shall be identified in accordance with MIL-STD-130.

3.2.7.1.5 Inspection seals. Corrosion resistant metallic seals shall be provided at all strategic locations to indicate assembly inspection and any unauthorized disassembly.

3.2.7.1.6 Moisture pockets. All components shall avoid housing designs which result in pockets, wells, traps, and the like into which water, condensed moisture, or other liquids can drain or collect. If such designs are unavoidable, provisions for draining shall be incorporated.

DISCUSSION

The standardization requirements are in keeping with standard Air Force policy regarding the minimization of supply problems and cost, both for equipment and for test and qualification. The use of tried and proven equipment should result in higher reliability than with new designs, especially during the early years of operation. The use of standard parts is also in these interests.

All flight control components must be adequately identified to preclude misuse, and strict adherence to inspection sealing must be held. The consequences of maintenance errors or omissions can be catastrophic.

Close attention must be given to the avoidance of moisture collections. Many of the flight control components are exposed to subfreezing temperatures, and can suffer serious performance degradation due to accumulations of slush and ice.

Contrails

3.2.7.2 Mechanical components. Mechanical components not covered by design requirements specified elsewhere within this specification shall be designed in accordance with applicable requirements in; Government and Industry specifications, in the order of precedence specified in MIL-STD-143; in AFSC Design Handbooks DH 2-1, DN 3B1, Mechanical Flight Controls; and DH 1-2, General Design Factors; and the following:

3.2.7.2.1 Bearings. Flight control system bearings shall be selected in accordance with AFSC Design Handbook DH 2-1, Chapter 6, Airframe Bearings, and the following.

3.2.7.2.1.1 Antifriction bearings. Approved type ball bearings in accordance with MIL-B-6038, MIL-B-6039, and MIL-B-7949 shall be used throughout the flight control system, except as indicated in the following paragraphs. Bearing installation shall be arranged in such a manner that failure of the rollers or balls will not result in a complete separation of the control. Where direct axial application of control forces to a bearing cannot be avoided, a fail-safe feature shall be provided.

3.2.7.2.1.2 Spherical bearings. Where space or other design limitations preclude the use of antifriction bearings, spherical-type, self-lubricating plain bearings in accordance with MIL-B-81820, or spherical or special-type all-metal bearing in accordance with MIL-B-8976 with adequate and accessible provisions for lubrication, may be used.

3.2.7.2.1.3 Sintered bearings. Sintered type, or oil impregnated bearings shall not be used in those parts of the flight control systems which have slow moving or oscillating motions. Fast moving rotating applications, such as in qualified motors and actuators, are permissible. Bearings shall conform to MIL-B-5687.

3.2.7.2.2 Controls and knobs. Aircrew controls shall be shaped and located per the requirements of AFSC Design Handbook DH 2-2. Control knobs shall be designed and spaced per the requirements of AFSC Design Handbook DH 2-2 and MIL-K-25049.

3.2.7.2.3 Dampers. Each damper shall be completely defined by a detail specification. Control stick dampers shall be designed so that they can be overpowered by the pilot in the event of failure or malfunction. Damping requirements for surface dampers shall be based upon the anticipated flutter frequency, but the endurance requirements shall be based upon the same criteria established for the surface control actuators. Detail design of hydraulic dampers shall conform to the applicable requirements of MIL-C-5503. All joints, connections, and bearings shall be designed to prevent the degree of wear which can cause unacceptable freeplay.

3.2.7.2.4 Structural fittings. All structural fittings used in flight control systems shall comply with the design requirements specified in AFSC Design Handbook DH 1-2, Design Note DN 4B1, Design Requirements, and where applicable, the design considerations specified in Design Note DN 4B2, Forgings and Castings.

3.2.7.2.5 Lubrication. Where applicable, lubrication fittings in accordance with MIL-F-3541, MS15002-1 and -2, or NAS 516 shall be installed to provide for lubrication in accordance with MIL-STD-838. NAS 516 fittings are restricted to nonstressed areas only.

DISCUSSION

Where design limitations preclude use of ball bearings, the use of prelubricated, shielded roller or needle bearings such as those of MIL-B-3990 and FF-B-185 will require procuring activity approval.

Note that general hydraulic component design requirements are specified in 3.2.6.5 by reference to MIL-H-8775 and MIL-H-8890 and that general high-pressure pneumatic component design requirements are specified in 3.2.6.7.1 by reference to MIL-P-8564.

3.2.7.3 Electrical and electronic components. Electrical and electronic components not covered by design requirements specified elsewhere within this specification shall be designed in accordance with MIL-E-5400, MIL-E-7080, MIL-STD-454, MIL-STD-461, MIL-W-5088, MIL-M-7969, MIL-M-8609, and the following:

3.2.7.3.1 Dielectric strength. Leakage current shall not exceed 10 milliamps when a dielectric stress voltage of 1200 volts, 60 Hz, is applied for 1 minute between insulated circuits and between circuits and case; and there shall be no insulation breakdown. When 500 V DC is applied between isolated circuits and the case or connector shell for a period of 10 seconds, the resistance shall be at least 50 megohms. When a component or connector has a lower design voltage limitation, the test shall be run at an appropriate lower voltage as defined by the component specification.

3.2.7.3.2 Microelectronics. When used, microelectronic devices shall conform to the provisions of MIL-M-38510.

3.2.7.3.3 Burn-In. All electronic LRUs shall receive a minimum of 50 hours burn-in operation and testing prior to assembly, or after assembly if such is more meaningful, prior to installation. Performance after burn-in shall be within specified tolerances.

3.2.7.3.4 Switches. The design of special electric/mechanical switches, other than toggle switches, shall be subject to the approval of the procuring activity.

3.2.7.3.5 Thermal design of electrical and electronic equipment. Wherever feasible, components shall be designed with heat-dissipating efficiency adequate to allow simple conductive, radiation, and free convection cooling utilizing the ambient heat sink to maintain the components within their permissible operating temperature limits. Operation under specified conditions shall not result in damage or impairment of component performance.

3.2.7.3.6 Potentiometers. Resistive variable voltage dividers shall not be used in dynamic motion applications such as sensor outputs or feedback output devices without specific approval by the procuring agency.

DISCUSSION

When selecting switches, the invulnerability to flight crew error requirements of 3.1.9.6 must be considered, such as recognizing that the selected positions of push button switches are not apparent.

The following recommendations should also be considered:

In the design of AFCS components, the minimum feasible number of parts should be used and their size and weight minimized consistent with other requirements specified.

Modules or subassemblies should not be smaller than that required to perform a single function. (As an example, an amplifier or power supply.)

Modules intended for field replacement should be so constructed that electronic parts or connector pins are not exposed outside the frame of the module.

Possible requirements for complex test equipment and test procedures should be considered prior to adopting a modular design to ensure that the requirements of 3.1.10.2 can be met.

Solid state devices are preferred over electron tubes and the latter should be used only when they are the only means to meet the requirements for a specific application.

The use of microelectronic technology should be considered on the design of all systems/equipment. An objective appraisal of all factors concerning the system/equipment design should be made with the view of maximizing reliability and minimizing total cost of ownership, weight, and space within the envelope of the other performance parameters of the design.

The separation of thermal design requirements, specified in this section, and cooling requirements, specified in Paragraph 3.2.9.3.3, is to emphasize that both the component design and its installation must be considered in achieving resistance to thermal failure. The preferential list of design techniques to maintain heat rise within operable limits as specified in MIL-F-9490C are listed here for reference.

The use of thermal characteristics of finishes, induced draft, and ventilation by means of baffles, internal vents and louvers, and packaging in heat dissipating fluids.

Air vents with adequate protection against climatic and environmental service conditions to all exposed parts.

Forced cooling, if above means are still insufficient, or if a significant reduction in overall size, weight, or failure rate can be realized. Fans or blowers employed shall operate from the aircraft's AC power supply.

Contrails

If heat dissipation requirements are such that the use of heat exchangers, liquid, air blast, or evaporative coolants must be resorted to, or must be provided in the aircraft installation, prior approval of the procuring activity is required.

3.2.8 Component fabrication. The selection and treatment of materials processing, and assembly, may be in accordance with established contractor techniques, in lieu of the following requirements, upon approval by the procuring activity.

3.2.8.1 Materials. When Government specifications exist for the type material being used, the materials shall conform to these specifications. Nonspecification materials may be used if it is shown that they are more suitable for the purpose than specification materials. These materials shall have no adverse effect upon the health of personnel when used for their intended purposes. This requirement shall be met for all probable failure modes and in the required environments.

3.2.8.1.1 Metals. Metals used in flight control system components shall be selected in accordance with the criteria and requirements specified in AFSC Design Handbook DH 1-2, Design Note DN 7A1, Metals.

3.2.8.1.2 Nonmetallic materials. Nonmetallic materials shall conform to the requirements specified in AFSC Design Handbook DH 1-2, Design Note DN 7A2, Nonmetals.

3.2.8.1.3 Electric wire and cable. Electrical wire cables containing up to seven conductors shall be constructed in accordance with MIL-C-27500. Airframe wire bundles may be constructed in accordance with contractor developed techniques provided such construction is approved by the procuring activity.

3.2.8.2 Processes

3.2.8.2.1 Construction processes. Heat treating, adhesive bondings, welding, brazing, soldering, plating, drilling, and grinding of high strength steels, materials inspection, castings, forgings, sandwich assemblies, and stress corrosion factors used in the fabrication of flight control system components shall comply with the requirements specified in AFSC Design Handbook DH 1-2, Design Note DN7B1, Construction.

3.2.8.2.2 Corrosion protection. All flight control system component parts, except those inherently resistant to corrosion in the operational environments, shall be finished per AFSC Design Handbook DH 1-2, Design Note DN7B2, Corrosion.

3.2.8.2.3 Fabrication of electrical and electronic components. The applicable requirements in AFSC Design Handbook DH 1-6 Design Note DN3H1, Electrical/Electronic Safety Design Considerations, relating to the fabrication of electrical and electronic components shall be met.

DISCUSSION

High quality materials and workmanship remain the key to the fabrication of dependable components. Use of proven and controlled processes, such as specified above, are most important in reproducible quality manufacturing. Special processes should be clearly specified on the detail drawings and the fabrication instructions.

3.2.8.3 Assembling

3.2.8.3.1 Mechanical joining. Individual parts may be mechanically joined with removable fasteners, or by riveted or threaded connections, or by qualified methods for permanent joining.

3.2.8.3.1.1 Joining with removable fasteners. All removable fasteners shall be selected and used in accordance with the applicable requirements specified in AFSC Design Handbook DH 1-2, Design Notes 4A1, General Requirements; 4A3, Bolts, Nuts, and Washers; 4A4, Screws; 4A5, Pins; and 4A6, Other Fasteners except as follows:

a. Bolts smaller than 1/4 inch in diameter shall not be used to make single-bolt connections or connections essential to proper functioning of the component.

b. Each removable bolt, screw, nut, pin, or other removable fastener, the loss of which would degrade operation below FCS Operational State III, shall incorporate two separate locking or retention devices either of which must be capable of preventing loss of the fastener by itself and retain it in its proper installation with the other locking or retention device missing, failed, or malfunctioning. Where self-retaining bolts are used, their selection and installation shall be within the limitations of MS33602, and only one type shall be used in any given system.

c. No self-locking nut may be used on any bolt subject to rotation in operation unless a nonfriction locking device is used in addition to self-locking device.

d. Lockbolts listed in AFSC Handbook DH 1-2, Design Note 4A5, Swaged-Collar-Headed Straight Pins and Collars, may be used for fastening applications not requiring removal on the aircraft.

3.2.8.3.1.2 Joining with rivets. Rivets for all riveted joints shall be selected and used in accordance with the requirements specified in AFSC Design Handbook DH 1-2, Design Note 4A2, Rivets.

3.2.8.3.1.3 Threaded joints. All threaded joints shall be provided with adequate wrenching and holding provisions for assembly and disassembly of the joint before and after service use. Internal screw threads and external rolled threads shall be in accordance with the thread form requirements of MIL-S-8879. Pipe threads shall not be used.

3.2.8.3.2 Joint retention. All adjoining parts shall be secured in a manner that will preclude loosening when subjected to internal or external loads or vibration.

Contrails

3.2.8.3.2.1 Retention of threaded joints. All threaded joints which carry critical loads shall be positively locked in the assembled position so that load reversal at the threads is prevented. The use of jam locknuts alone is not a positive locking means unless lockwired or otherwise restrained.

3.2.8.3.2.2 Retention of removable fasteners. Unless restrained from moving by the attachment of adjoining parts, all removable fasteners shall be positively locked in place. Self-locking externally threaded fasteners shall not be used except within the limitations specified in MS15981, and self-locking nuts shall not be used except within the limitations specified in MS33588. All other types shall incorporate positive locking means or be safetied with cotter pins in accordance with MS24665, where temperature and strength permit, or be safety wired. Cotter pins and safety wiring shall be installed in accordance with MS33540.

3.2.8.3.2.3 Use of retainer rings. Retainer rings shall not be used to retain loaded parts unless the rings are positively confined by a means other than depending on internal pressure or external loads. They shall not allow freeplay which could result in structurally destructive action or fatigue failure of the retained parts or failure of gaskets or packings. Where used, retainer rings shall be commercially available types which can be installed and removed with standard tools.

DISCUSSION

It is common practice to secure fasteners (i.e., bolts, screws, nuts, pins, etc.) with a single locking device. Service experience has shown, however, that due to maintenance, manufacturing, or design errors, a single locking device is not adequate for critical applications. Due to a number of instances of loss of fastener integrity, it is considered necessary to require two separate locking devices on all removable fasteners in any installation in which loss of a fastener could jeopardize flight safety.

One acceptable practice is the use of self-retaining bolts with cotter-pinned castellated nuts installed as shown on MS33602. Other fasteners are also acceptable providing they meet the requirements in the referenced AFSC Design Handbook including retention of their locking and/or retention capabilities in all environmental conditions associated with their particular installation.

Where lockbolts are used, it should be recognized that they are single locking only, not close tolerance, and can be used only in joints in which clampup is allowed.

Jam nuts may be used without lockwire or other retention in applications which serve only to preload threaded joints, wherein inspection intervals are such as to preclude unacceptable fatigue cycles and where backlash is acceptable. Where they are used to prevent joint disconnection, they must be positively retained.

3.2.8.3.3 Assembly of electronic components

3.2.8.3.3.1 Electrical and electronic part mounting. Electronic parts shall be mounted so that ease of producibility and maintainability is

Contrails

assured. Whenever feasible, parts such as resistors, capacitors, etc., shall be mounted in an even, regular, row-type arrangement. These parts shall be mounted on a base so that the leads do not cross other leads or connections. Heavy electronic parts and assemblies shall be solidly mounted so that adverse affects when subjected to vibration and shock will be minimized.

3.2.8.3.3.2 Shielding and bonding on finished surfaces. Nonconductive oxides or other nonconductive finishes shall be removed from the actual contact area of all surfaces required to act as a path for electric current and from local areas to provide continuity of electrical shielding or bonding. All mating surfaces shall be clean and shall be carefully fitted, as necessary, to minimize radio frequency impedance at joints, seams, and mating surfaces. The resultant exposed areas, after assembly at such joints or spots, shall be kept to a minimum.

3.2.8.3.3.3 Isolation of redundant circuits. Redundant circuits shall be isolated from each other to preclude failure of one portion of the circuit from affecting any other circuit.

3.2.8.3.3.4 Electrical connector installation. The number of electrical connectors shall be kept to a minimum within the required limitations for separation of redundant circuits. Connectors shall be mounted to preclude nuisance warning indications and intermittent operation when subjected to applicable temperature differentials, vibration, and shock. They shall be polarized so that it is impossible to mismatch them on a particular piece of equipment.

3.2.8.3.3.5 Cleaning of electrical assemblies. All electrical assemblies shall be thoroughly cleaned of loose, spattered, or excess solder, metal chips, or other foreign material after assembly. Burrs and sharp edges and resin flash shall be removed.

DISCUSSION

Isolation of redundant circuits is mandatory to obtain the advantages promised by using multiple signal paths. Generally, redundant channels of the same control axis and electronic comparison model signals should not utilize common or adjacent:

- Connectors
- Cables or cable runways
- Circuit cards

unless the design can be shown by demonstration or analysis to meet the appropriate isolation/separation requirements.

A high percentage of electronic equipment failures are due to the improper choice and/or assembly of electrical connectors, and special attention to their selection and application is important.

The invulnerability requirements of 3.1.9 require wiring to be routed with sufficient slack to prevent thermal contraction or expansion, vibration, and flexure from causing damage' to the wire terminations and to minimize

noise pickup. They must also be routed away from hot parts, such as resistors. Electrical shielding generally must be installed on wire and cable to minimize electrostatic and magnetic coupling.

3.2.9 Component installation

3.2.9.1 Basic requirements. Flight control system components shall be installed in compliance with the applicable requirements specified in AFSC Design Handbook DH 1-6, Section 3J, Flight Control Systems, including Design Note 3JX, Safety Design Check List, and as specified herein.

3.2.9.2 Locating components. System components shall be located to provide direct routing of the control system signal and power transmission elements (cables, rods, lines, wires, etc.) in accordance with Design Note 3J1, Routing and Separation, only to the extent that the components and transmission elements are not exposed to undue hazards.

3.2.9.3 Installation in fuel system areas. All component installations in fuel system areas shall preclude the generation of sparks both during normal operations and possible abnormal and failure conditions.

3.2.9.4 Electrical and electronic component installation. In addition to the requirements specified in AFSC Design Handbook DH 1-6, Section 3J, the applicable requirements in Design Notes DN 3H1, Electrical/Electronic Safety Design Considerations and DN 3H2, Installation Safety Objectives, shall be met.

3.2.9.5 Electrical and electronic equipment cooling. If cooling augmentation is required, the installation of flight control electrical and electronic equipment cooling shall be integrated with the cooling provisions for other electrical and electronic equipment. The requirements specified in AFSC Design Handbook DH 1-6, DN 3H1, Temperature shall be met.

DISCUSSION

The foregoing requirements are in addition to those specified elsewhere in the specification, primarily in 3.2.1 through 3.2.6. The following recommendations regarding electrical and electronic equipment cooling should also be considered:

Forced air cooling should be used only when natural cooling does not provide sufficient cooling or when a significant reduction in overall size and weight can be realized. Exhaust and recirculating fans, blowers, and pumps should be driven by brushless motors operating from the available AC power sources.

For equipment thermally designed for use with external source supplied cooling air, which may contain entrained water or other contaminants detrimental to the equipment, precautionary measures should be taken to avoid direct impingement on internal parts and circuitry by channeling or use of heat exchangers. If this is impractical, the water and contaminants should be removed from the cooling air by suitable removal devices.

Contrails

Other cooling methods such as liquid, evaporative coolants, and use of vapor cycle refrigerants should not be used, except when natural or forced air cooling methods are unsuitable.

3.3 Rotary wing performance and design. *All requirements of this specification shall be satisfied by rotary wing aircraft except where specifically noted to apply to other types of aircraft, for example, 3.2.1.1, Pilot Controls for CTOL Aircraft, or where modified by requirements denoted by an asterisk specifically for rotary wing aircraft. Special rotary wing performance and design requirements are as follows.

3.3.1 Special manual FCS performance requirements. *Rotary wing aircraft shall meet the flying qualities requirements specified in MIL-F-83300.

3.3.2 Special automatic FCS performance requirements. *The attitude and heading hold accuracies specified in the following paragraph apply under conditions of fixed collective pitch control only. Allowable magnitudes and settling times of perturbations induced by variations in collective pitch control shall be as specified by the procuring activity.

3.3.2.1 Attitude hold (pitch, roll, and yaw). *During the attitude hold mode, the attitude, in calm air, shall be maintained within ± 1 degree of the reference attitude. The dynamic requirements of 3.1.2.1 shall be met.

3.3.2.2 Heading hold and heading select. *The automatic flight control shall maintain heading within ± 1 degree of commanded heading in forward flight at speeds above 40 knots indicated. The aircraft shall not overshoot the selected reading by more than 2.5 degrees at speeds above 60 knots. The roll rate shall not exceed 5.0 degrees per second and roll acceleration shall not exceed 3.0 degrees per second for MIL-F-83300 Class II and III aircraft or double these values for MIL-F-83300 Class I and IV aircraft.

3.3.2.3 Altitude hold.*

3.3.2.3.1 Barometric altitude stabilization. *The requirements of 3.1.2.5 shall be met when the helicopter is outside the ground effect as defined for the specific helicopter.

3.3.2.3.2 Stabilization of altitude above the terrain. *The operational range of the absolute altitude control mode shall be as specified in the applicable system specification. Within this range, the helicopter shall be controlled to the indicated absolute altitude with an accuracy, in calm air while over flat terrain, of ± 7 feet \pm sensor error.

DISCUSSION

The accuracy requirements of the altitude hold modes are unchanged from those specified in MIL-F-9490C. The dynamic requirements for the barometric altitude hold mode are discussed after 3.1.2.1.

3.3.2.4 Hover hold. *For MIL-F-83300 Class II helicopters, position shall be maintained with a drift of less than 20 feet plus sensor error over a 2 minute period. Altitude shall be maintained in ground effect within ± 5

feet over a 5 minute period. Where special mission requirements dictate, the contractor shall establish further requirements, subject to procuring activity approval.

3.3.2.5 Vernier control for hovering. *Vernier control shall be provided for accurate positioning of the aircraft during hovering, unless control commensurate with minimum accuracy requirements can be obtained with the regular controls.

DISCUSSION

The hover hold and vernier control for hovering are designed to provide the capability for accurate positioning of the aircraft and to minimize the pilot's workload for tasks such as precision placement of externally carried cargo. The performance specified applies only to MIL-F-83300 Class II helicopters and requirements may vary considerably for other applications, or for special mission requirements within a given class of helicopter.

No single value can be given for vertical or horizontal hold accuracy for all aircraft in the hover-hold mode. The requirements for precision hover accuracy for placement of cargo, for example, posed for the heavy lift helicopter would place unnecessary restriction on the design of the FCS for aircraft not requiring this high degree of accuracy. In addition, requirements for some Navy applications specify a hover requirement relative to water velocity, for sonar use, rather than fixed in space.

Hover hold mode position accuracy is primarily dependent on accuracy of the sensors used for reference. For example, if doppler velocity were integrated to obtain position error, doppler drift would have to be less than 0.10 knot to hold position within twenty feet for two minutes. Various references may be used such as integrated doppler velocity, inertial velocity reference or visual reference.

3.3.2.6 Groundspeed hold. *Where groundspeed hold is a system requirement, provisions shall be made to insert groundspeed signals to the cyclic pitch and roll controls. After engagement of the groundspeed hold mode, the ground speed existing at the time of engagement shall be held in steady flight in calm air within +3 knots.

DISCUSSION

This requirement has been modified from that specified in MIL-F-9490C to reflect a more realistic system tolerance. The tolerance of +3 knots is applied to the sensed groundspeed at the time of engagement and does not include any sensor error. Reference to radar groundspeed signal has been deleted since other signal source may be used.

3.3.3 Special design requirements*

3.3.3.1 Manual FCS design*

3.3.3.1.1 Control feedback. *The control device motion and force required to accomplish stability and control augmentation shall not be reflected at

Controls

the aircraft's cockpit control. Force feedback shall be considered as not reflected at the controls if the magnitude is less than half the breakout force of the control with lowest breakout force. If other control device motions are not to be reflected at the cockpit controls, the proposed system shall be approved by the procuring activity. Full freedom of operation of cockpit controls shall be possible at all times stability augmentation is in use. Provisions shall be made in cockpit control motions so that recovery from an augmentation actuation hardover is possible under all flight conditions. The cockpit control position may shift under this condition.

DISCUSSION

It is desirable that control force not be fed back to the pilot's controls from the stability and control augmentation systems when he normally controls the aircraft manually. Depending upon the mechanization, however, even with series actuators, some force may be fed back, but it should be minimized.

3.3.3.1.2 Feel augmentation. *The pilot and copilot shall have the capability of overriding the feel system at all times. Upon failure of the feel augmentation system the control feel shall revert to a breakout force and a force gradient versus deflection required by MIL-F-83300.

DISCUSSION

The purpose of the limitations on transients and failure mode motions specified herein is to ensure that the short term response of the airplane does not get out of hand before the pilot can react. Values specified herein for maximum acceptable transients are those which appear in MIL-H-8501A. This specification requires three seconds "transient" time rather than two seconds as for CTOL aircraft.

3.3.3.2 AFCS design. *Integration of the automatic flight control system with the manual flight control system shall not cause the control feel to depart from that specified in MIL-F-83300. Subsystems that trim control forces to zero shall not introduce control transients that degrade flying qualities.

3.3.3.3 Swashplate power actuators*

3.3.3.3.1 Redundancy. *Swashplate power actuators which are essential to flight of the aircraft shall be redundant. Where redundant actuators are used, the control valves shall also be redundant.

3.3.3.3.2 Jamming. *The swashplate power actuator in aircraft subject to combat damage shall be jamproof. The threat shall be specified by the procuring activity.

3.3.3.3.3 Frequency response. *The swashplate power actuator frequency response shall be adequate to meet the flying qualities requirements of MIL-F-83300 when operated in series with the direct linkage and rotating controls.

3.3.3.4 Actuation stiffness. *The stiffness of the swashplate support, in conjunction with rotor blade torsional stiffness, shall be adequate to minimize control loads and shaking forces generated by the rotor.

DISCUSSION

Loss of swashplate control in a helicopter results in loss of collective control (thrust) and loss of vehicle attitude control, (catastrophic). Thus, particular attention to safety considerations is necessary throughout the design stage of the swashplate and its actuators. Emphasis is necessary on design to prevent malfunctions from occurring and to insure that control can be maintained in the event malfunction does occur. Where power actuation of the swashplate is necessary because of high pitch link loads the actuators and valves shall be redundant to prevent loss of control from single malfunction.

Stiffness of the swashplate and its supports is critical in rotary wing aircraft since the oscillatory link loads are transmitted from the rotor to the swashplate.

3.3.3.5 Fatigue life design. *Components shall be designed to a minimum safelife of 3600 hours, except for seals. Seals shall be designed for a minimum life of 1200 hours. Fatigue lives shall be substantiated by component bench testing and flight strain survey. Fatigue lives shall be determined using actual bench test strengths and measured flight loads.

3.3.3.5.1 Fail-safe. *Components subject to fatigue loads shall not only be designed to safe-life but also shall be designed fail-safe. Fail-safe design shall be achieved through either a redundant load path, a failure warning system, or a damage tolerant/free design.

3.3.3.5.2 Display. *Subsystems that continuously display on cockpit indicators the fatigue loading of rotor or dynamic system components shall be redundant if an erroneous display due to a subsystem failure could result in advertent accumulation of fatigue damage.

DISCUSSION

Certain critical components of rotary wing aircraft flight control systems operate normally under relatively high oscillatory load conditions. These components which are exposed to fatigue loads shall be designed to be fail-safe in addition to being designed to safe-life. This is necessary because of the desire not to "over-design" the components to keep weight down, difficulty of assessing the impact on fatigue of vehicle maneuvering at elevated load factors and the flight safety impact of malfunctions of these components.

Failures within the rotating systems of helicopters are critical with regard to flight safety, in fact, usually catastrophic. Systems have been devised to measure the fatigue loading in the rotor or dynamic system components and indicate to the pilot the degree of loading. These systems permit operation of the aircraft continuously at conditions wherein loads generated

Contrails

in the components approach the design loads. Components subjected to relatively high frequency oscillatory loads such as swashplate, swashplate actuators pitch links, etc., may be instrumented in this manner. Fatigue damage may accumulate rapidly in these components if they are operated under excessive loads. Thus, in the interests of safety, since erroneous displays due to measuring or indicating systems could result in operation under excessive loads, the systems should be redundant, or provide adequate self-test.

3.3.3.6 Built-in test. *Rotary wing aircraft with powered control systems shall have provisions for checking single system operation of the redundant flight control systems during flight and during ground operation in accordance with MIL-T-5522. This requirement does not apply to single power systems using manual reversion for emergency operation.

*Special rotary wing aircraft requirements.

4.0 QUALITY ASSURANCE

4.1 General requirements

4.1.1 Methods for demonstration of compliance. Flight control system compliance with each of the applicable design requirements of this specification or the FCS specification defined by 4.4.2 shall be verified using one or more of the following methods. Except where a specific method is required, selection of the method of proof shall be made by the contractor subject to concurrence of the procuring activity.

DISCUSSION

The basic philosophy used for setting compliance demonstration requirements allows judgment for selecting verification methods based on the unique needs of each design requirement and each procurement. The contractor is best qualified to propose verification methods based on his detailed knowledge of system design. Cost effective and practical compliance demonstration procedures can only be established by integrating this contractor knowledge with procuring activity desires.

4.1.1.1 Analysis. Compliance with requirements in cases where testing or inspection would be hazardous or otherwise impractical may be verified through analyses. These analyses may be linear or nonlinear and may include piloted and nonpiloted simulations, as defined by the FCS development plan.

DISCUSSION

Several of the requirements included in 3.0 can only be verified by analysis. Preliminary compliance demonstration for many more of the requirements of 3.0 may also be provided through analysis. The FCS development plan (4.4.1) should reflect the contractor's plans for preliminary and final compliance demonstration.

Requirements which will likely be demonstrated through analysis include:

Reliability and failure immunity

Invulnerability

Maintainability

Operation in turbulence

Gain margins at high frequencies and phase margins at all frequencies.

The following analyses will likely be performed in a typical procurement:

Reliability and failure mode and effects analyses. Reliability and failure mode and analyses will normally be performed to analytically demonstrate that the FCS satisfied the requirements of 3.1.6 and 3.1.7. When required by the procuring activity, the Reliability Program Plan, defined by

Contracts

MIL-STD-785, will be used to perform these analyses. Reference 83 describes the Tabular System Reliability Analysis, (TASRA) reliability prediction approach which was developed through a series of AFFDL research projects. The contractor should consider use of TASRA for reliability analyses.

Vulnerability analysis. An analysis will normally be performed to analytically demonstrate that the FCS meets the invulnerability requirements of 3.1.9. The contractor will normally establish and submit to the procuring activity a Vulnerability Analysis Plan as part of the FCS development plan which defined analytical procedures to be used for the vulnerability analysis.

Maintainability analysis. An FCS maintainability analysis will normally be accomplished as an integral part of the overall system analysis. This analysis and the associated Maintainability Program Plan, prepared in accordance with MIL-STD-470, and included as part of the FCS development plan, will normally be used to analytically demonstrate that the requirements of 3.1.10 are satisfied.

System-safety analysis. Hazards analysis will normally be accomplished as an integral part of the overall system analysis. These analyses and the associated System Safety Program Plan, included as part of the FCS development plan, will normally analytically demonstrate that the requirements of such paragraphs as 3.1.3.2., 3.1.9 and 3.1.10 are satisfied. When required by the procuring activity, MIL-STD-882 will be used to define the analytical procedures to be used for the safety analysis. When required by the procuring activity, a System Safety Program Plan (SSPP) in accordance with MIL-STD-882 may be prepared. If a comprehensive system safety program is not justified in a specific procurement, a safety program meeting the minimum acceptable safety program requirements of MIL-STD-882 may be prepared by the contractor subject to the approval of the procuring activity.

Operation in turbulence analysis. An analysis or simulation will normally be performed to analytically demonstrate that the turbulence penetration requirements of 3.1.3.7 are satisfied.

Stability Analysis. A stability analysis will normally be required to predict gain and phase margins at frequencies and flight conditions where testing is impractical. Gain margins cannot be tested, for example, at or near $1.15 V_L$.

4.1.1.2 Inspection. Compliance with requirements associated with referenced component specifications, the physical arrangement of parts, or the physical relationship of parts shall be verified by inspection of documentation or inspection of the physical installation. Documentation may include documents showing the qualification status of components which have been qualified to the requirements specifications, or drawings showing clearances or other physical relationships. The FCS development plan shall define those requirements to be verified through inspection. Unless otherwise specified in the contract or purchase order, the supplier is responsible for the performance of all inspection requirements as specified herein. Except as otherwise specified in the contract or order, the supplier may use his own or any other

facilities suitable for the performance of the inspection requirements specified herein. The Government reserves the right to perform any of the inspections set forth in the specification where such inspections are deemed necessary to assure supplies and services conform to prescribed requirements.

DISCUSSION

Many of the requirements in Section 3.0 are that components or subsystems, comply with component or subsystem specifications which may be military specifications or contractor prepared specifications. Other requirements are stated in terms of physical arrangement or physical clearances.

In the case of demonstration of compliance with other specifications, tests may be conducted on the component or subsystem specifically for the purpose. However, these tests are requirements of the component or subsystem specification rather than MIL-F-9490. Compliance with MIL-F-9490 requirements can be verified by inspection of the qualification status of component or subsystem.

In the case of requirements involving physical relationships, physical inspection will provide the desired proof.

4.1.1.3 Test. To the maximum extent feasible, compliance with the quantitative requirements of the FCS specification shall be demonstrated by tests. Tests shall include the laboratory, airplane ground and flight tests defined in the FCS development plan.

DISCUSSION

Verification by test is the preferred method for demonstrating compliance with requirements. Due to safety or cost considerations, many requirements cannot be demonstrated during flight testing. In some cases analytically predicted trends are validated during flight at a critical or representative set of flight conditions and analysis trends are used to extrapolate these validated analysis trends to show compliance at all flight conditions not specifically tested.

Verification by ground or operational mockup testing is generally preferred where flight testing is not feasible. However, as stated in 4.1.1 the specific method to be used for compliance demonstration is intended to be selected by the contractor.

4.2 Analysis requirements. Where compliance with specification requirements through analytical predictions is used, the contractor shall define the major assumptions and approximations used and verify that the modeling and analysis procedures used are conservative. Verification shall normally require prior use and validation through comparison with flight, wind tunnel or ground testing data. In all cases the contractor shall establish tolerances on

analytical predictions used to demonstrate compliance with specification requirements. These tolerances shall reflect anticipated variations in system or component characteristics such as:

- a. Parameters that change with temperature, atmospheric pressure and other environmental factors.
- b. Parameters that change with failures or manufacturing tolerances.
- c. Parameters that critically affect system performance or stability.
- d. Parameters that are not accurately known (if they are significant).
- e. Parameters that change as a result of aging or wear.

4.2.1 Piloted simulations. Piloted simulations shall be performed during FCS development. As a minimum, the following simulations shall be accomplished:

- a. Piloted simulations using computer simulation of the FCS prior to hardware availability.
- b. Piloted simulations using actual FCS hardware prior to first flight.

4.3 Test requirements.

4.3.1 General test requirements

4.3.1.1 Test witness. Before conducting a required test, the contractor shall notify an authorized procurement activity representative. An orientation briefing on specific test goals and procedures shall be given procuring activity observers prior to any required test sequence to be monitored by an observer.

4.3.1.2 Acceptance tests. Appropriate FCS acceptance tests will be defined by the procurement detailed specification.

4.3.1.3 Instrumentation. Accuracy of instruments and test equipment used to control or monitor test parameters shall have been verified since its last use prior to initiation of the sequence of design verification tests. All instruments and test equipment used in conducting design verification tests shall:

- a. Conform to laboratory standards whose calibration is traceable to the prime standards at the U. S. Bureau of Standards.
- b. Be accurate to within one third the tolerance for the variable to be measured.
- c. Be suitable for measuring the test parameter(s).
- d. Be verified no less frequently than every 12 months.

4.3.1.4 Test conditions. The contractor shall establish operational test conditions which accurately represent system in-service usage throughout the applicable flight phases and flight envelopes defined in accordance with MIL-F-8785 or MIL-F-83300.

4.3.2 Laboratory tests

4.3.2.1 Component tests. All components shall be qualified to the applicable component specification by individual tests, by proof of similarity to qualified components which are qualified under conditions applicable to the specified operating conditions, by testing in system design verification tests, or suitable combinations of these methods. Component qualification requirements shall be based upon their use in the specific vehicle and its associated environment. Environmental test methods and procedures shall be selected from MIL-STD-461, or MIL-STD-810. The contractor shall generate additional methods and procedures where MIL-STD-461 or MIL-STD-810 are inadequate for the planned aircraft usage. Wear life 3.1.12 shall be demonstrated at the component level except where system wear life is more meaningful due to component interaction.

DISCUSSION

Component test requirements are generally defined by the component specifications referenced herein and test methods and procedures to be used are generally defined in MIL-STD-810. For individual procurements these requirements and methods may be inadequate for either the environment to be experienced or for the unique implementation used. Special or additional tests or methods should be developed by the contractor and included in the FCS development plan or specification. Among component tests normally performed are:

Dielectric strength tests. Each circuit of electrical and electronic components should be subjected to a test equivalent to the application of a root mean square test voltage of three times the maximum (but not less than 500 v.) surge d.c. or three times the maximum surge peak a.c. voltage to which the circuit will be subjected under service conditions. The test voltage should be of commercial frequency and should be applied between ungrounded terminals and ground, and between terminals insulated from each other, for a period of one minute. Test should be accomplished at normal ground barometric pressure and no breakdown of insulation or air gap should occur. Circuits containing capacitors or other similar electronic parts which may be subject to damage by application of above voltages should be subjected to twice the surge peak operating voltage for the specified period. If the maximum peak operating voltage is greater than 700 v., the rms value of the test voltage should be 1.5 times greater than the maximum peak operating voltage. Electrical and electronic components should also be tested for resistance to air gap breakdown at the maximum altitude specified in the altitude test.

Electromagnetic interference limits. The flight control system and components, both should be assembled and arranged in a manner as specified in the system or component specification, with interconnecting cables and supporting brackets representative of an actual installation. Provisions

should also be made for inverting all components with respect to the ground plane, or positioning in such a manner as to permit measurements from the bottom of all components. Measurement of radiated and conducted interference limits should be made in accordance with MIL-STD-461 with the system switches, controls and components operated as in actual service.

Sand and dust. Each component, with simulated external connections attached, should be subjected to individual tests before and after exposure. Any dust film or dust penetration should not result in a deterioration of the performance of the component.

Fungus. Equipment which has parts of organic material or other materials which may grow fungus, should be subjected to a fungus resistance test. The component should be subjected to individual tests before and after exposure. Any fungus present should not result in a deterioration of the performance or service life of the component.

Extreme temperature tests. Dynamic operation using expected high and low temperature and temperature shock should be verified on all components subject to binding or malfunction resulting from:

- (1) Differential expansion or contraction of mating parts
- (2) Deterioration of lubricant
- (3) Deterioration of hydraulic fluid
- (4) Deterioration of any type seal device
- (5) Deterioration of electrical part
- (6) Altered hydraulic or electrical characteristics
- (7) Change in performance function

The component should be subjected to individual tests before, during and after exposure. From these tests and a visual examination there should be no evidence of damage or deterioration which will prevent the component from meeting its operational requirements.

Humidity and corrosion and icing. Components subject to failure due to corrosion, entrance of moisture, or formation of ice should be given humidity tests and salt spray tests. In addition, if ice formation might be detrimental to the equipment, an icing test should be conducted as follows:

- (1) Cool test items to -12 degrees C (10.4 degrees F) or lower.
- (2) Reduce ambient air pressure to simulate 40,000 feet pressure altitude and maintain for at least 15 minutes.
- (3) Increase ambient air pressure to ground level by introducing warm moist air at a temperature of at least 49 degrees C (120 degrees F) and a relative humidity of 95 (+5) percent. Continue circulating warm moist air until the test item temperature is at least 5 degrees C (41 degrees F). Item 1, 2, and 3 constitute one cycle of testing. Twenty-five

Contrails

cycles should be performed to determine acceptability. Following each five cycles, the test item shall be functionally checked while at a -12 degree C (10.4 degrees F) temperature. At the conclusion of the 25 cycles, and following the functional check, the equipment should be examined for evidence of internal moisture, corrosion, or other defects.

Altitude. Electrical equipment and other flight control system items which may be adversely affected by high-altitude operation should be tested. A percentage of the total life test cycles, consistent with service requirements of the component, but not less than 25 percent, should be conducted at the high-altitude condition.

Vibration, shock and acceleration. All equipment subject to failure or malfunction due to vibration, shock, or high accelerations should be tested.

Combined temperature - altitude tests. Components and systems subject to leakage or which may experience cooling problems, should be subjected to combined temperature - altitude tests.

Component life testing. Components which are subject to wear, fatigue, or other deterioration due to usage, should be life tested under realistic environmental conditions for a number of cycles representative of the desired life expectancy of the component. In most cases, life test requirements are defined in Government specifications, but should be revised to reflect actual expected usage. Hydraulic components should be tested while using hydraulic fluid at a typical fleet environment fluid cleanliness level.

System life testing. The mechanical portions of the complete FCS, such as pulleys, cable rods, torque tubes, control sticks or wheels, etc., should be tested as a complete system. It is considered that the best way to do this is in a complete system mockup in which loads, relative distances and locations, and other characteristics are realistic.

Miscellaneous tests. Equipment which is located so that it is subjected to rain, sunshine, and sand and dust shall be tested accordingly. Components failing a service condition test should not be resubmitted for test without furnishing complete information on the corrective action taken subsequent to the failure. This information should be furnished to the procuring activity or in the test report, depending upon location of testing. Depending upon the nature of the failure encountered and corrective action required and at the option of the procuring activity, the rework or modifications accomplished should also be incorporated into the other test samples. Where rework or modification may be considered as sufficient to affect performance under the other service condition tests already completed, at the option of the procuring activity, these tests should be repeated in the specified order.

Components to be used under a particular category of service application, which have previously been subjected to and accepted under the requirements of a lower, or less severe category application, either as an individual component or as a component of the same or a different system, should be subjected to a rerun of those service condition tests which vary with category of service application.

4.3.2.2 Functional mockup and simulator tests. Where one of the first airplanes in a new series of aircraft will not be available for extensive testing of the FCS prior to flight of that model, an operational mockup which functionally, statically and dynamically duplicates the flight control system shall be constructed. For essential and flight phase essential flight controls, an accurate electrical representation shall also be provided. Production configuration components shall be used for all flight control system parts, and the hydraulic system shall be compatible with MIL-H-5440 test requirements. Primary aircraft structure need not be duplicated; however, production configuration mounting brackets shall be used and shall be attached to structure which simulates actual mounting compliance. Mechanical components of the FCS shall be duplicated dimensionally. Inertia and compliance of flight control surfaces shall be duplicated or accurately simulated. The operational mockup shall be coupled with a computer simulation of aircraft characteristics and external inputs to the flight control system. The following minimum testing shall be conducted on the operational mockup, or other appropriate test facility when approved by the procuring activity.

a. Power supply variation tests to demonstrate satisfactory operation over the range of allowable variations specified in the applicable control power specifications referenced in 3.2.5.

b. System fatigue tests (where system installation geometry or dynamic characteristics are critical to fatigue life) in accordance with MIL-A-8867 to demonstrate compliance with the requirements of 3.1.11.3. The duty cycle required shall be established by the contractor as representative of flight and ground usage.

c. Stability margin tests to verify those requirements of 3.1.3.6 which can be verified by test using an aircraft simulation or the operational mockup, but which cannot be economically or safely demonstrated in flight.

d. Tests to determine the effects of single and multiple failures on performance, safety, mission completion reliability, and the development of emergency procedures to counteract the effects of failures.

e. Miscellaneous tests to demonstrate FCS performance, and compatibility among FCS systems and with interfacing systems.

f. System wear life 3.1.12 where component wear life is interactive.

DISCUSSION

The operational mockup is a tool used for validation of the flight control system design prior to first flight and is also a useful tool in flight control development. The more nearly this tool functionally resembles the flight vehicle installation, the greater the confidence level in the test results. Ideally, an airframe with a flight control system installed and with aircraft flight dynamics simulated would be the mockup. Use of an airframe for the operational mockup, such as described in Reference 12, is becoming more popular--especially where the FCS airframe interaction is expected to be complex.

Contrails

Inclusion or exclusion of means for simulation of control surface aerodynamic hinge moments is dependent upon specific usage and should be justified by the contractor. Where aircraft structural compliance is simulated in lieu of airframe parts, verification should be established by the contractor through a detailed analysis of compliance.

The specified tests may be performed individually or, where feasible, a single test may satisfy multiple requirements. For example, structural strength and rigidity may be verified during performance (response) test and fatigue requirements may be verified as a part of endurance testing. Note that the specified minimum tests may be performed on alternate test facilities when approved. Separate component life/loading testing, for example, may be justifiable in some cases.

When performing power supply variation tests, each component should be tested individually or assembled, or both, into a system in a manner as specified in the component or system specification. Rated electrical, hydraulics and other required power sources should be applied and all calibration settings placed at maximum rated positions. After completion of the warmup period, the power sources should be varied and modulated, throughout their specified limits. No steady state or transient modulation changes in the power source, within permissible limits, should cause a variation or modulation in the system's performance which may result in undesirable or unsatisfactory operation. With rated power applied, the system's switches, controls and components should be operated as in actual service. Observation of the rated power source should note no variation or modulation of the power source beyond permissible operational limits when the system is operated against load conditions varying from no load to full load conditions.

Fatigue tests may be accomplished by cycling loads on components fixed in one or both hardover positions or in an intermediate position such as by hydraulic pressure impulse testing. It should also be noted that, for fatigue testing, the "appropriate alternate test facility" could be the aircraft fatigue test rig. See MIL-A-8866 for discussion of fatigue scatter factors and MIL-A-8867 for fatigue test requirements. Note that required fatigue tests include all linkages, controls, etc.

Subsystem math models used to analytically predict stability margins for feedback systems should be verified on the operational mockup to the extent practical. This practice is encouraged since the FCS hardware such as sensors, electronics and actuators included on the operational mockup eliminate error included in the analytical predictions due to nonlinearities and other math modeling problems associated with these components. Where significant differences between the analytical predictions and the operational mockup margins are observed further frequency response or other tests should be performed to identify the components which are improperly modeled. Once these components are identified, the corresponding math models can be corrected and analytical margin predictions refined.

One of the major uses of an operational mockup is evaluation of failure effects within the FCS. The contractor should also include performance oriented tests or simulations to verify predicted performance and to evaluate system compatibility.

For essential and flight phase essential controls, the following mockup tests of AFCS BIT and failure reversion capability should be considered:

Overtemperature test of AFCS computers, panels, and sensors to evaluate the BIT capability of detecting failures induced by progressive overheating.

Wire hardness failures (shorts between wires and ground and open circuits) to evaluate BIT capability to detect wiring damage/failures.

The main objective of these tests is not necessarily to make individual components less vulnerable to hazards or enemy action. Rather, the primary objective is to ensure that true redundancy exists by verifying that individual failures in each channel (1) are detected, (2) are remedied, and (3) are not the cause of multichannel failures.

4.3.2.3 Safety-of-flight tests. Prior to first flight, sufficient testing shall be accomplished to ensure that the aircraft is safe for flight. These shall be defined in the FCS development plan and shall include, but not be limited to, the following:

4.3.2.3.1 Component safety-of-flight tests. All system components shall successfully demonstrate satisfactory performance and satisfactory operation under the environmental extremes expected in the flight test program. Certification that a component is safe for flight because of prior qualification and use on another aircraft may be allowed provided that the component design is identical to the previously qualified part in all significant respects and that its capability to operate under all conditions specified for its new application has been proven.

4.3.2.3.2 System safety-of-flight tests. The complete system shall successfully pass all of the operational mockup tests specified in 4.3.2.2 prior to first flight except that only 20 percent of the required fatigue life demonstration need be completed.

4.3.3 Aircraft ground tests. Prior to first flight the following minimum testing shall be performed.

a. Gain margin tests to demonstrate the zero airspeed 6 dB stability margin requirements of 3.1.3.6 for feedback systems depending on aerodynamics for loop closure and to demonstrate stability margins for nonaerodynamic loops. Primary and secondary structure shall be excited, with special attention given to areas where feedback sensors are located with loop gains increased to verify the zero airspeed requirement.

b. Functional, dynamic and static tests to demonstrate that all FCS equipment items are properly installed and that steady state responses meet FCS specification requirements. These tests shall include integrated FCS and test instrumentation as installed on the prototype airplane. Compliance with the applicable residual oscillation requirements of 3.1.3.8 shall be demonstrated.

Contrails

c. Electromagnetic interference (EMI) tests to demonstrate compliance with the requirements of 3.2.5.4.1. Measurement of interference limits shall be made in accordance with MIL-STD-461 and MIL-E-6051.

d. An integrity test to insure soundness of components and connections, adequate clearances, and proper operation in accordance with MIL-A-8867.

DISCUSSION

The intent of paragraph 4.3.3.a is to insure that no structural coupling exists between the aircraft structure and the flight control system (structural resonance). This phenomena occurs when there is sufficient gain in the flight control system such that structural modes sensed by the FCS sensors are reinforced through the loop closures in the FCS, i.e., a 180 degree phase lag exists at the particular structural mode frequency between the sensor and the flight control surface. This results in a sustained oscillation at the structural frequency. The problem can be eliminated by (1) locating sensors in the vehicle so as to minimize the effects of either structural mode slopes or accelerations sensed by rate or acceleration sensors respectively in the structure (phase stabilization), (2) designing electrical filters to reduce the gain at these frequencies (gain stabilization), (3) reducing the total system gains, or (4) various combinations of the above. Structural coupling problems can also arise due to local instabilities within the actuator mounting structure or mechanical linkage, and will be discussed in closed-loop limit cycle tests. The first two solutions are usually pursued more vigorously than the latter. The third approach can compromise aerodynamic performance that the closed-loop FCS is expected to enhance.

Data on structural characteristics at the various sensor locations are usually obtained from flutter analysis or analytical structural analysis. It is very desirable to record flight control sensor outputs during ground vibration or flutter tests. These characteristics are a function of the structural stiffness and inertia, hence they vary with fuel loads, stores, and configuration changes, such as gear and flap position, or wing sweep. In general, system design considerations and ground test requirements for eliminating structural resonance can be treated for two classes of aircraft. These classes are large aircraft with structural mode frequencies starting in the 2 - 5 Hz region, and small aircraft with structural mode frequencies starting in the 8 - 12 Hz region. Several examples of how this problem has been addressed in both large and small aircraft will be discussed.

The intent of paragraph 4.3.3.b is to insure that the nonlinearities existing in the closed loop flight control system do not cause perceptible limit cycle oscillations to occur in flight. The phenomena occurs when the phase margin of the flight control system reaches zero degrees (180 degrees of phase lag in the system), and sufficient threshold is available for the closed-loop system to react to this amount of phase lag between the sensors and the control surfaces. The problem can be alleviated by phase compensation in the mechanical and/or electrical portions of the systems. The purpose of introducing lead compensation in the system is so that a sufficiently

Contrails

high gain can be maintained to produce the desired performance. Additionally, statically unstable vehicles require a minimum gain level to insure vehicle stability.

The system gain level and frequency of the oscillations can be roughly estimated by performing a root locus or similar closed-loop analysis using both rigid and flexible inputs for the control derivatives. This analysis should be performed at the maximum closed-loop total loop gain that would be realized in flight. The reason for conducting both rigid and flexible control power analysis is that the actual control power of the surface will fall between the two values at the limit cycle frequency. Once these gain and phase margins have been established, the results should then be checked on the aircraft or equivalent flight control simulator (iron bird), using the actual hardware that the aircraft will use, with the exception of the gyroscopes and accelerometers, which are usually easier to model than to "torque" the actual hardware. These gain margin checks should be conducted using the results of the ground vibration tests for the flexible model of the airframe and the structural filtering used in the control loops. The desirability of using the structural data becomes more critical for the larger aircraft because the limit cycle frequencies usually occur in the same regions as structural frequencies. The gain and phase compensation networks then become more critical for the larger aircraft with lower frequency structural modes. Two general classes of limit cycle can exist in the flight control system, and each can be investigated on the aircraft or on the iron bird simulator. The first is a low amplitude oscillation that occurs as a result of nonlinearities about the null position such as hysteresis. It has been the subject of much documentation such as references (48) lifting bodies, (7) TWEAD I, and (87) TWEAD II. The second limit cycle occurs as a result of system saturation such as actuator rate limiting and is extremely important when investigating the characteristics of statically unstable vehicles and the unique control laws required for stabilization throughout the flight envelope.

A typical plot of what can be expected from these tests is shown below in Figure 17D. The plot shows the limit cycle amplitude (δ_a is stabilizer deflection; $K_q \Delta q$ is control system gain times pitch rate amplitude) and frequency plotted as a function of total loop gain (K_q is the control system gain; M_{δ_e} the aerodynamic gain). Ideally, with a linear control system, no limit cycle would occur until the loop gain equalled the gain necessary for critical stability, i.e., the 180° phase lag point on a frequency response plot or the crossing of the $j\omega$ axis on a root locus diagram. However, due to nonlinearities at low amplitude, the phase lag is excessive causing a divergent oscillation until the amplitude of oscillation reaches the point where the effect of the nonlinearities is reduced and a stable limit cycle occurs as shown on the lower portion of the curve. Increasing the value of the loop gain increases the amplitude of the stable limit cycle and the corresponding frequency of oscillation. As the linear stability limit is approached, the amplitude of oscillation rapidly increases forming a knee in the amplitude plot and the frequency falls off. The zero amplitude line and the linear stability limit line represent the limiting case for a completely linear system. For very large inputs such as sharp stick raps sufficient to cause rate limiting, system saturation will produce additional phase lag in the control loop causing large amplitude, lower frequency, sustained oscillations to occur. Typically, the large amplitude

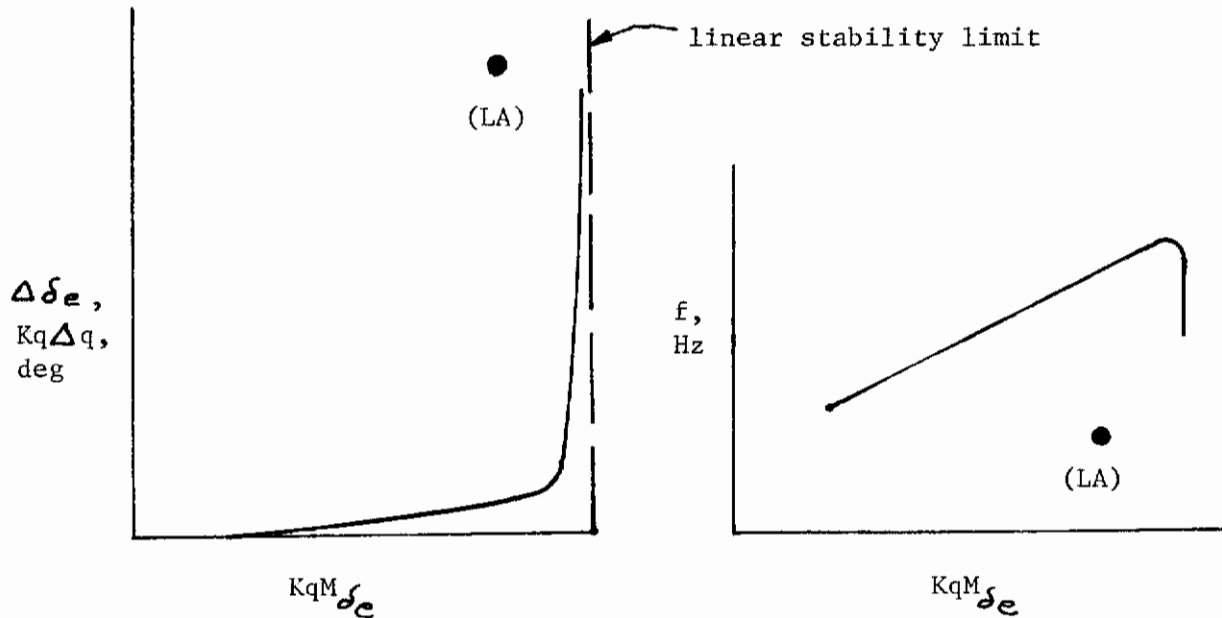

Figure 17D. Typical limit cycle ground test characteristics

saturation points, as shown by the (LA) point in the figure, usually occur at a significantly lower gain than the small amplitude divergent points. Although a large amplitude input is required to saturate the system at the lower gain values, the input magnitude required to saturate the system gradually decreases as the gain increases. Thus in the gain range between the large amplitude saturation point and the small amplitude limit cycle divergent point, a moderate size input could be sufficient to saturate the system. These large amplitude, saturation type instabilities should be taken into consideration when establishing flight boundaries. This phenomena has been addressed in depth in the (A-7 DFCS) Digital Multimode Flight Control System program and the results will be included in the Final Technical Report for that program.

Examples:

Several recent flight control programs, both developmental and production, have addressed the phenomena of limit cycle and structural resonance. Problems encountered and solutions will be briefly touched upon in an attempt to shed light on understanding how to deal with the problems successfully.

Lifting Bodies - X-24A, M2F2, HL-10

Structural resonance and limit cycle tests were conducted on these vehicles prior to first flight at NASA Flight Research Center (RFC). Ground testing techniques and data results are given in reference 48. A six db margin was used on these tests. A first order aerodynamic model was used for the limit cycle testing. A rather interesting observation is the phase lag contribution of various components of the flight control elements as determined by recording various points while conducting limit cycle tests. This data is shown in figure 18D.

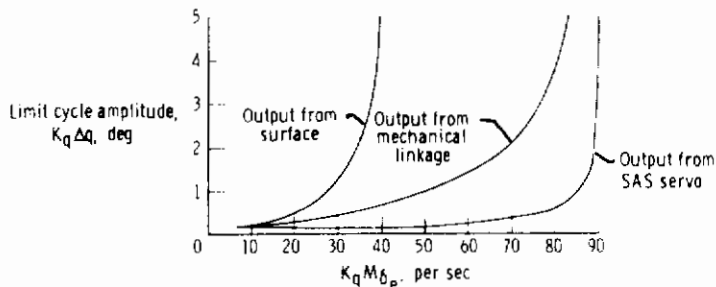

Figure 18D. Typical limit cycle ground test characteristics of the pitch SAS of the HL-10 lifting body at various points within the system

TWeaD I (F-4C)

Several problems were encountered with both limit cycle and structural resonance in flight. Reference 7 documents the problems that were experienced and their solutions. The ground structured resonance tests were performed after structural resonance was encountered in flight. The gyros were relocated and several modifications were made to the structural filters in the forward paths of the CAS. A six db gain margin was the criteria that was used in the on-aircraft ground tests (no iron bird was available). Once the proper filter configuration was found, no further problems were encountered. Limit cycle problems were also encountered in flight. These problems were present throughout the program, and were due to improper operation of the adaptive pitch gain changer. The on aircraft ground limit cycle tests were conducted by simulating the gyroscope and using the first order approximation for airframe dynamics.

TWeaD II - (YF-4C)

This was a high, fixed gain system that required extensive ground development and evaluation testing to alleviate limit cycle and structural resonance problems. A complete description of tests that were conducted and the results are discussed in detail in reference 87. Some significant test results are noted. A double notch filter was required in the pitch axis to allow a sufficient fixed gain to be maintained. Placing lead compensation in the forward path to eliminate limit cycle allowed the maximum fixed gain

Contrails

to be increased by a factor of five. All store loads flown were ground tested for structural resonance and a six db gain margin was maintained. The roll and yaw axes were cross-coupled, but first order decoupled aerodynamic transfer functions were used to conduct ground roll and yaw limit cycle tests. In-flight limit cycle tests were conducted in all three axes to validate the ground tests. These tests were performed to determine if any lateral-directional cross-coupling was present that would not show up in the decoupled ground tests. Frequency response tests on the structural filters showed that the transfer functions varied with input amplitude, indicating non-linearities in the electronics did exist although no problems were encountered in-flight.

B-52 Controlled Configured Vehicles (CCV)

The extensive on-aircraft ground tests of the Ride Control System (RCS) and yaw damper implementation accomplished prior to beginning the series of B-52 CCV flight tests are described in reference 44. A block diagram showing the mechanization of these ground tests is presented in Figure 19D. As originally designed, the RCS did not satisfy the six db gain margin requirement on the ground, due to excessive high frequency (40 to 50 Hz) feedback gain. This problem was easily corrected by adding a high frequency attenuation roll off filter to the onboard analog computers.

C-5A

System performance tests including SAS control characteristic tests were performed on the iron bird. Ground vibration and frequency response tests were conducted on the aircraft.

Iron bird system stability evaluations resulted in detecting unacceptable low damping in the aileron-spoiler system. Excessive slop in the aileron servo attach points on the iron bird and the means of simulating surface inertias were suspected of loading the servos differently than actual air loads. For these reasons, no modifications to the servo system were incorporated prior to gaining experience on the aircraft. The rudder servo assembly also exhibited low damping characteristics when sharp pedal commands were given. This was traced to lack of structural stiffness of the lower rudder actuator backup structure. The backup structure on both the iron bird and aircraft was stiffened to eliminate the problem.

The only structural coupling problem encountered in the aircraft ground vibration tests was in the pitch control system. This instability was due to a coupling between the inboard elevator rotational frequency, the pitch augmentation computer mounting rack frequency and the 17 Hz symmetrical aircraft modes. The problem was corrected by stiffening the mounting rack and changing the pitch SAS body bending filters. Because of test schedule commitments, ground frequency response testing was not conducted on the first production ship until after flight 8. Testing was initiated due to detecting aileron servo system instability during step input commands of the BITE test sequence. The frequency response data verified the low damping exhibited by the aileron servos. The source of the stability problem was found to be positive structural feedback as a result of a basic incompatibility between follow-up geometry and the structural deflection of the aileron hinge line. A negative structural feedback linkage was designed which solved the problem.

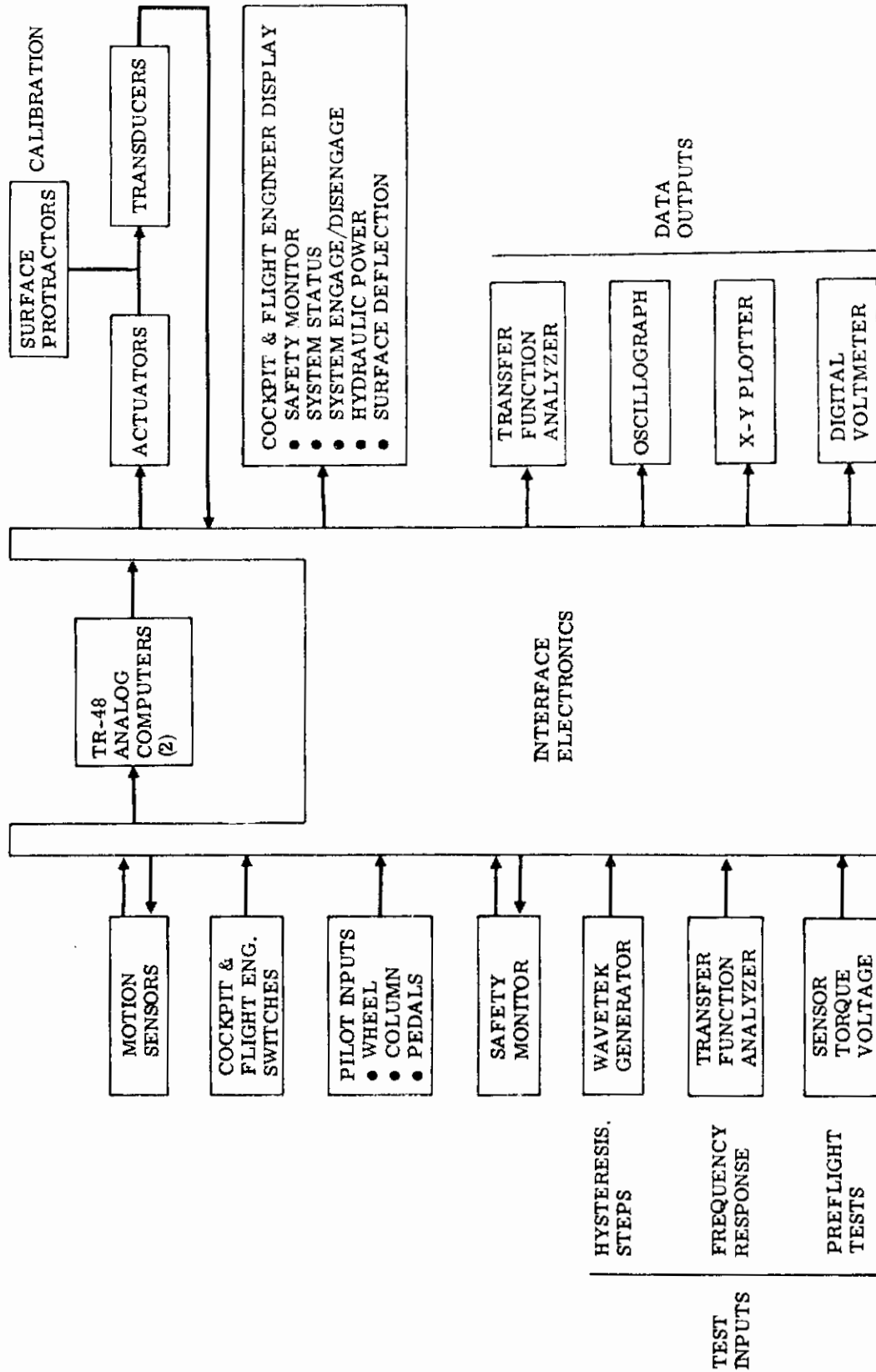

Figure 19D. B-52D CCV ground test mechanization

C-5A Active Lift Distribution Control System (ALDCS)

System functional performance tests and frequency response tests were conducted on the iron bird. Aircraft ground testing of the ALDCS prior to first flight included ground vibration tests and a comprehensive ground frequency response test program including gain variations to verify the six db gain margin stability criteria. The prototype development program was highly successful, resulting in no significant design modifications as a result of ground or flight test.

F-15

Structural Coupling Effects. Structural bending modes can couple through the CAS feedback to cause high frequency structural oscillations. To reduce the probability of this from occurring, special techniques were used. There are three vibrational modes in both the longitudinal and directional axes. These mode shapes vary slightly with fuel state. The effect of first bending mode is reduced by location of the acceleration and rate sensors. The accelerometers are located close to the vibrational mode of the first bending mode and the rate gyros are located at the antinode. The effects of the second bending modes were reduced by the addition of second order "notch" filters in the computation network. It was assumed that the third bending mode was of a small enough magnitude that it would not couple with the control system, so no compensation was added.

Longitudinal Structural Coupling. During set up of iron bird testing, it was discovered that the stabilator actuators and its backup structure coupled with the flight control system at the actuator's natural frequency (natural frequency is approximately 27 Hertz which is close to one of the longitudinal bending modes). To eliminate this mode, a 40 radians per second first order lag was added in series to the notch filter, and the loop gain was reduced by 2/3. This eliminated the oscillation but degraded the longitudinal short period damping in the low altitude high speed part of the flight envelope. During initial flight testing, it was decided that this degradation was unacceptable and had to be improved. A new structural filter was designed that provides the same or better phase margin at the longitudinal short period control frequencies, and the same or greater attenuation at the 27 Hz structural mode frequency, as the original notch filter cascaded with the 40 radian lag filter. The original notch filter was conceived in anticipation of a need to attenuate signals at the first vertical bending mode. Sensor location, however, adequately isolates system response from that mode, so that filtering in the 8 Hz region proved unnecessary. This filter is a double lag with a break frequency of 60 radians per second and solved the structural coupling problem. Flight test results have shown that this filter successfully eliminated any structural oscillations and retained the original short period damping capability of the CAS system.

Directional Structural Coupling. During initial ground tests on the aircraft, it was determined that a structural feedback vibration could be excited at 29.0 Hertz (third bending mode) with abrupt inputs, like lowering the gear. The structural filter was modified to move the notch to 29 Hertz and to provide an additional 27.75 radian per second lag. This gave about 30 db attenuation at this structural frequency (29 Hertz) and cured this problem.

Contrails

As the low altitude high speed part of the flight envelope was being opened up it was discovered that with the "new" filter the first bending mode (7 Hertz) was excited. As a result of this, a third filter was developed which changed the notch from 29 Hz to 7 Hz and changed the lag from 27.75 to 59.4 radians per second. This had the effect of attenuating the signal by 15 db at the first bending mode, while retaining 10 db attenuation at the third bending mode. Neither of these changes had any effect on the Dutch roll damping mode. They have been flown successfully over the entire flight envelope.

F-4 SFCS

Stability tests were conducted on the SFCS Phase IIA secondary and primary actuator configuration installed in the iron bird. Limit cycle oscillations occurred at 16 Hz which were stabilized by increasing the stiffness of the fixture between the primary and secondary actuation as well as adding a stiffener to the bulkhead behind the secondary actuator. This prompted similar testing on the aircraft. Structural resonance, frequency response, and limit cycling testing was conducted. No limit cycles were detected in the lateral and directional axes for loop gains up to 12 db above nominal. The limit cycle amplitude increased to one degree peak-to-peak stabilator deflection for Phase IIA testing and 0.3 degree for Phase IIB testing as the pitch loop gain was increased to 11 db above nominal.

During flight, a limit cycle oscillation occurred in the pitch axis at 23 Hz during right sideslips in the Power Approach (PA) configuration (full trailing edge flaps with gear down) at 170 knots and 10 K feet altitude with the control system in medium gain. A review of the F-4 airframe dynamics indicated that the stabilator and extended flaps both had a rotation mode frequency of 23 Hz. The presence of the flap rotation mode of 23 Hz was thought to be significant by virtue of the gyro location in the left hand wing root just forward of the flap. A notch filter centered at 23 Hz was added in the forward path of the longitudinal flight control system that eliminated the problem. However, excessive stabilator actuator oscillatory loads were observed during high angle-of-attack maneuvers that resulted in moderate and heavy buffet. A deeper notch filter centered at 23 Hz was installed to eliminate the problem.

YF-17

Frequency response and limit cycle tests were successfully accomplished on the iron bird full scale flight controls test stand. Structural resonance and limit cycle testing was conducted on the aircraft in accordance with the procedures described in NASA TN D-6867 (Reference 48). Adequate stability margins were demonstrated for the pitch and yaw axes. The pitch axis was stabilized with a 9.5 Hz notch filter and reducing the bandwidth of the secondary actuator from 100 to 50 radians/sec. The yaw axis, per se, did not require any structural filter. However, an 8 Hz notch filter was incorporated to reduce coupling between the 8.6 Hz lateral fuselage bending mode and yaw rate feedback that tended to reduce damping. In the roll axis, ground structural resonance tests indicated an adequate gain margin. However, continuing analysis of structural dynamics/control system compatibility checks, using flutter analysis with active controls represented predicted that a

Contrails

potential instability existed under certain flight conditions due to an interaction between the approximately 7 Hz wing bending moment and the roll augmentation system. Furthermore, the limit cycle gain margin was judged insufficient, particularly with wingtip missiles off, considering that the large aeroelastic correction for the roll control derivative might not be fully applicable. For these reasons, a cautious in-flight evaluation was decided upon. At 0.8 Mach, 15 K altitude, with the 20 Hz notch filter and the roll gain set at 30% of normal, very lightly damped wingtip oscillations at 7 Hz occurred. The roll notch filter was changed from 20 Hz to a staggered 7 Hz/8.5 Hz notch, and a 20 Hz lead term was removed from the feedback compensation. The latter, in effect was equivalent to adding a 20 Hz lag filter and was intended to stabilize the 19 Hz mode. The modified filters gave fully satisfactory results. The subject of interaction between the control augmentation system and airframe dynamics on the YF-17 is addressed in Reference 86.

A summary of the flight control system ground test experience discussed in previous paragraphs is presented in Table IID.

As can be seen, various ground testing methods can be used for evaluating stability margins. Test methods should be proposed by the contractor based on the characteristics of the system. The important consideration is that the requirements for ground stability and limit cycles are satisfied, and that flight safety is assured for the following flight tests. These flight tests are, of course, the logical means for demonstrating performance.

TABLE IID
FLIGHT CONTROL SYSTEM GROUND TEST EXPERIENCE

AIRCRAFT	FREQUENCY RESPONSE	STRUCTURAL RESONANCE	LIMIT CYCLE	REMARKS
Lifting Bodies	X	X	X	No iron bird simulator available. No inflight problems. See text and Ref 48.
F-4C TWead I	X	X	X	No iron bird available. See text and Ref 7 for in-flight problems.
F-4C TWead II	X	X	X	No iron bird available. See text and Ref 87 for in-flight problems.
C-5A	⊗	⊗		See text for pitch limit cycle problem detected after flight 8.
C-5A ALDCS	⊗	⊗	○	No in-flight problems. See text.
F-15	⊗	⊗		In-flight, inadequate pitch damping and 7 Hz structural coupling in roll. See text.
YF-4E SFCS	⊗	⊗	⊗	In-flight pitch axis limit cycle in PA mode and high angle of attack. See text.
YF-17	⊗	⊗	⊗	In-flight limit cycle in roll axis. See text and Ref 86.
B-52 CCV	X	X		No iron bird available. No in-flight problems. See text and Ref 44.

CODE: ○ Iron Bird Simulator
 X Test Aircraft
 ⊗ Both Iron bird and Test Aircraft

4.3.4 Flight tests. Flight tests shall be conducted, as defined in the FCS development plan, to demonstrate compliance with requirements where compliance cannot reasonably be demonstrated by other tests or analyses. The design and test condition guidelines tabulated in MIL-F-8785 shall be considered in establishing the flight test plan. Flight test data shall be used to verify the analytical trends predicted and shall be compared to the performance and design requirements of the FCS specification. Comparable data trends shall be required for verification where analytical data is used to extend or extrapolate flight test data to show compliance. In addition, tests shall be conducted to assure that the flight control system, in all operational states, does not violate the flutter requirements of MIL-A-8870.

DISCUSSION

Table XV of MIL-F-8785B gives general guidelines for flight test conditions to be used for evaluation of handling qualities. Flight tests for demonstration of compliance with this specification (MIL-F-9490) will be concurrent with those required by MIL-F-8785. Test data requirements may be identical or tandem.

Gain margins are required by 3.1.3.6 for airspeeds from 0 to $1.15 V_L$. During flight test gain margin predictions should be verified for all flight speeds up to V_L in critical flight configurations. Verification will normally require comparable trends between flight test data and analytical predictions. Complete flight test checks of gain margins would be costly and are not recommended. Sufficient gain margin flight test data points should be generated to validate the analytical trends used to predict margins.

4.4 Documentation. FCS data submittal and approval requirements for each specific model aircraft shall be in accordance with the contract requirements. The data shall be furnished in accordance with appropriate line items of the Contractor Data Requirements List (DD Form 1423). Typical information and data items are listed in this section.

4.4.1 Flight control system development plan. A flight control system development plan shall be prepared by the contractor for approval by the procuring activity. This plan shall be revised and updated at intervals as specified by the procuring activity until it is mutually agreed that no further revision is required. The plan shall include a minimum of:

a. A detailed milestone chart showing the interrelationship between phases of development work to be accomplished. Design reviews shall be identified and scheduled and an outline of the progressive design verification process to be used by the contractor shall be included. Starting and completion dates for all work items and due dates for all reports shall be identified.

b. A FCS synthesis and analysis plan describing the general approach and analytical procedures to be used. Analyses planned to generate requirements for the FCS specification shall be described.

Contracts

c. A verification plan defining the means selected by the contractor for verifying that the design meets each of the requirements of the FCS specification. Verification means shall be specifically correlated with each specification requirement.

d. Flight safety, reliability, maintainability and vulnerability analysis plans to include a description of the analytical or other means selected by the contractor for design verification in these areas.

e. A functional mockup test plan, including the test procedures to be used and a listing of requirements to be satisfied by each test.

f. A ground test plan and ground test procedures defining the ground tests and functional checks to be performed prior to flight.

g. A flight test plan and detailed flight test procedures. Each procedure shall be correlated with one or more requirements of the FCS specification.

DISCUSSION

This series of plans is meant to make available the contractor's planning and intended development process to the procuring activity early in the development. The verification plan is a key means whereby the contractor interfaces with the procuring agency. As a part of the verification plan, a description and tabulation of means to be used to verify each of the requirements of the flight control system specification of 4.4.2 must be submitted. Table IIID is a tabulation of typical verification means.

The verification means of Table IIID indicate the typical means to be used to verify requirements. The contractor will be required to prepare detail descriptions of the planned verification for each requirement contained within the FCS specification of 4.4.2. In different procurements, different verification means may be used to verify the same requirement. Only through interaction between the contractor and the procuring activity can practical verification means be established for unique requirements in each procurement. By updating the FCS development plan and the included verification plan at intervals, this interaction should occur and practical verification means should be identified.

4.4.2 Flight control system specification. The contractor shall prepare a flight control system specification incorporating:

a. Applicable general system, implementation, and test requirements of this specification.

b. Special requirements of the procurement air vehicle detail specification.

c. Special requirements determined by the contractor, as required by the general specification.

A preliminary FCS specification shall be prepared within 90 days of contract award and progressively updated as requirements are finalized.

TABLE IIID
TYPICAL VERIFICATION MEANS

REQUIREMENT	ANALYSIS	SIMULATION	INSPECTION	BENCH TEST	GROUND TEST	FLIGHT TEST
3.1.1	X	X				X
3.1.2	X	X				X
3.1.3	X	X		X	X	X
3.1.4	X	X		X	X	X
3.1.5	X	X		X	X	X
3.1.6	X			X		
3.1.7	X					
3.1.8	X	X		X	X	
3.1.9	X	X	X	X	X	
3.1.10	X		X	X	X	
3.1.11	X			X	X	
3.2.1		X	X	X	X	X
3.2.2	X		X		X	
3.2.3			X	X	X	
3.2.4	X		X	X	X	
3.2.5	X	X	X	X	X	
3.2.6	X		X	X	X	
3.2.7			X	X		
3.2.8			X			
3.2.9			X			
3.3	X	X	X	X	X	X

4.4.3 Design and test data requirements. If applicable design data are available the contractor shall, in lieu of preparing new design data, use these available data supplemented by sufficient information to substantiate their applicability.

4.4.3.1 FCS analysis report. A report describing FCS analysis shall be prepared using an outline prepared by the contractor, subject to procuring activity approval. This report shall be initially prepared immediately following the preliminary FCS analysis and synthesis and periodically updated throughout the development period. The final update shall include as a minimum:

a. Design requirements and criteria used during the FCS analysis and synthesis.

b. Block diagrams of the FCS. These diagrams shall include transfer or describing functions and indicate normal control paths, redundancy, manual overrides, emergency provisions, location and type of sensors and control device used.

c. A general description of the FCS. The various modes of operation shall be described and the theory of operation discussed.

d. Discussions of unusual or difficult design features and problems.

e. A description of the stability and performance of the FCS and a comparison of system characteristics with the requirements of the FCS specification. Data shall be presented for both linear, small perturbation analyses and for nonlinear simulations or analyses which consider nonlinearities such as actuator rate, electronic amplifier saturation, and actuator position limits. Where analytical predictions are used to satisfy specification requirements, the assumptions, analytical approximations and the tolerances placed on these analytical predictions by the contractor shall be documented and justified.

f. Results of the FCS flight safety, reliability, maintainability and vulnerability analyses. The reliability analysis results shall include a detailed listing of possible failure modes. The approach and sources of data used shall be discussed and the results compared to and correlated with requirements of the FCS specification. Analytical methods used shall be documented and justified by the contractor.

g. A general control system layout or series of layouts showing control surfaces, actuation systems, feel systems, pilot's controls and control panel organization. Means of providing redundancy and emergency provisions shall be illustrated. Layouts shall include wiring schematics for all electrical and electronic portions of the FCS and attendant electrical, hydraulic, and pneumatic power inputs to the FCS.

h. A description of piloted simulations performed, as required by 4.2.1. Where piloted simulation data is used to verify specification requirements, the simulator and flight configurations simulated shall be described and the data compared to and correlated with the requirements of the FCS specification.

i. Mathematical models of the FCS, the unaugmented airplane and other data required to allow the procuring activity to independently simulate the FCS at any point during or following the aircraft development process. Mathematical models, block diagrams, stability and performance data and layouts shall be updated following flight tests to incorporate modifications made during testing.

4.4.3.2 FCS qualification and inspection report. The contractor shall document results of inspections used to demonstrate compliance with requirements of the FCS specification. Where inspection of component qualification status documentation is used to verify compliance with the FCS specification, the contractor prepared component specification shall be submitted as a part of the FCS inspection report.

4.4.3.3 FCS test report. A report describing and correlating tests performed and data generated to verify requirements of the FCS specifications shall be prepared by the contractor. This report may be prepared in volumes and shall include a minimum of:

Contrails

a. A detailed description of the operational mockup including part numbers and the test conditions under which data was generated and a comparison of the FCS specification. Inclusion or exclusion of control surface aerodynamic hinge moments, simulation of aircraft structural compliance in lieu of airframe parts or use of other approximations in operational mockup construction shall be justified. All discrepancies or corrective actions arising from operational mockup testing shall be reported.

b. A description of the airplane ground tests performed and data generated and a discussion of any system adjustments or modifications required to satisfy requirements of the FCS specification.

c. A comparison of flight test data with requirements of the FCS specification and a description of the airplane configurations and flight conditions tested. Modifications to the FCS made during the flight test phase to meet FCS specification requirements shall be documented and justified.

DISCUSSION

The documentation defined in the preceding paragraphs is considered required for a major production aircraft development. For other programs, such as advanced developments, prototype aircraft, experimental aircraft and off-the-shelf aircraft buys, the procuring activity may waive much of this documentation or may be satisfied with alternate pertinent documentation.

In procurements requiring development of an automatic landing system, extensive documentation is normally required describing the all weather landing system. A typical set of documentation includes:

All weather landing system description. The system description should describe in detail the all weather landing system with particular emphasis on the redundancy and monitoring techniques used. Interface with other airplane systems should be discussed.

All weather landing failure analysis. The failure analysis documentation should:

(1) State all significant failure effects and the probability of a hazard due to each and combinations of these failures.

(2) List all predictable failures and errors which can result in significant effects.

(3) Describe precautions taken to reduce probability of serious failures; e.g., separation of wiring bundles and power from different generator sources.

(4) Record estimates of the probability of a failure or combination of failures to show that this probability is acceptable in terms of the probability of a hazard due to the failure. Sources and criteria used as a basis for the estimates of these probabilities should be indicated. The

frequency and scope of system checks required and effects of frequency of check on probabilities of undetected and dormant failures should be presented.

(5) State the procedures taken to ensure high reliability of maintenance action where this action is a critical feature in the safety assessment.

(6) Describe the method used to evaluate crew response required to counteract failures. Delay times to recognition of a warning or failure and to subsequent corrective action should be included.

All weather landing performance analysis. The all weather landing system simulation should be described. A detailed account of the calculation of normal dispersion should be included, together with an assessment of the risk of a hazard due to use of the system. In addition, results of the flight test documentation program, showing the normal performance under failure-free conditions and the effects of significant failures should be included. Correlation of flight test results to simulator and/or analysis results should be discussed.

All weather landing safety assessment. The safety assessment documentation should summarize procedures developed and analyses completed which show that the system meets all safety requirements. It should also show that the stated procedures are suitable for use by crews of representative ability and should ensure safe operation under normal and failure conditions.

All weather landing operational and maintenance procedures. All operational and maintenance procedures required to attain the specified performance and safety should be detailed. The operational procedures should include the nature and frequency of any inflight tests of the system, and the corrective action required following a failure or warning. The maintenance procedures documentation should identify the nature and frequency of periodic tests of the individual units of the system to detect dormant failures or out-of-tolerance components within the system. Specific instructions for maintenance or troubleshooting to clear faults should be given to ensure that the airplane is dispatched with a safe operational system. The maintenance procedures should also specify the type and calibration status of equipment to be used by maintenance crews.

5.0 PREPARATION FOR DELIVERY

5.1 Packaging requirements. In the event of direct purchases by or shipments to the Government, the packaging shall be in accordance with the contract or the approved component or subsystem specification, as applicable. Components shall be delivered complete, tested, and ready for installation.

6.0 NOTES

6.1 Intended use. This is a general requirements specification applicable to flight control systems and is based upon service experience to date. Deviations to the requirements of the specification may be granted following presentation and approval of substantiating data.

6.2 Procedure for requesting deviations. The requirements of MIL-STD-480 shall be met. Substantiating data shall be in the form of test, simulation or analytical data generated by the contractor during design tradeoffs.

6.3 Reordered equipment or second source procurement. Where models or drawings of components of systems are furnished by the procuring activity on a contract to facilitate interchangeable construction, or where procurement is for equipment to provide interchangeable use with equipment previously procured, and the requirements for interchangeability contradict the current requirements of one or more MIL specifications, the contract requirements for interchangeability govern.

6.4 User's guide. A background information and user's guide, AFFDL-TR-74-116, provides explanations of and justification for the requirements of this general specification.

6.5 Abbreviations

AFCS	-	Automatic Flight Control System
BIT	-	Built-in-Test
CDRL	-	Contractual Data Requirements List
C.G.	-	Center of Gravity
CTOL	-	Conventional Takeoff and Landing
EFCS	-	Electrical Flight Control System
EMI	-	Electromagnetic Interference
EMP	-	Electromagnetic Pulse
FCS	-	Flight Control System
g	-	Gravitational Constant
LRU	-	Line Replaceable Unit
MFCS	-	Manual Flight Control System
MPS	-	Motor-Pump-Servoactuator Package
TAS	-	True Airspeed
VOR	-	Very High Frequency Omnidirectional Range
V/STOL	-	Vertical/Short Takeoff and Landing

6.6 Definitions

Airspeeds. Airspeeds referenced within this specification are as defined in either MIL-F-8785 or MIL-A-8860. MIL-F-8785 defines airspeeds associated with flying qualities and MIL-A-8860 defines airspeeds related to loading and flutter.

Contrails

Alert height. A height (100 feet or less above the highest elevation in the touchdown zone), based upon the characteristics of the aircraft and the particular airborne Category III system above which a Category III approach would be discontinued and a missed approach executed if a failure occurred in one of the required redundant operational systems in the aircraft or in the ground equipment.

All weather landing system. An all weather landing system includes specifically all the elements of airborne equipment and more generally includes the ground-based equipment necessary for completion of the all weather landing. All weather landings comprise the operations and procedures required to conduct approaches and landings during Category II and III visibility conditions defined by the International Civil Aviation Organization.

Automatic flight control system. See 1.2.1.2

Automatic landing system. A landing system which provides automatic flight control to touchdown or to touchdown and beyond.

Built-in test (BIT). Integral onboard testing devices which enable rapid isolation on the ground of a faulty Line Replaceable Unit (LRU) (either manual or automatic), without removing the LRU from the aircraft. Usually a warning of malfunction is given by an external device on the LRU.

Category I operations. An instrument approach procedure which provides for approaches to a decision height (DH) of not less than 200 feet and visibility of not less than 1/2 mile or RVR (Runway Visual Range) 2500 feet (RVR 1800 feet with operative touchdown zone and runway centerline lights).

Category II operations. An instrument approach procedure which provides approaches to minima of less than DH 200 feet/RVR 2400 feet to as low as DH 100 feet/RVR 1200 feet.

Category IIIa operations. Operations with no decision height limitation, to and along the surface of the runway with external visual reference during the final phase of the landing and with runway visual range not less than 700 feet.

Category IIIb operations. Operations with no decision height, to and along the surface of the runway with runway visual range not less than 150 feet and with reliance on the system for part or all of the rollout along the runway and with external visual reference for guidance along the taxiway.

Category IIIc operations. Operation with no decision height, to and along the surface of the runway and taxiways without reliance on external visual reference.

Channel. The term describing a single signal or control path within a device or system that may contain many paths. A channel is an entity within itself and contains elements individual to that channel. A model may be used as a reference channel in a detection-correction system.

Classes. Airplane classes are defined using the MIL-F-8785 definitions for the following classes.

Contrails

Class I	Small, light airplanes such as Light Utility Primary trainer Light observation
Class II	Medium weight, low-to-medium maneuverability airplanes such as Heavy utility/search and rescue Light or medium transport/cargo/tanker Early warning/electronic countermeasures/ airborne command, control, or communi- cations relay Antisubmarine Assault transport Reconnaissance Tactical bomber Heavy attack Trainer for Class II
Class III	Large, heavy, low-to-medium maneuverability air- planes such as Heavy transport/cargo/tanker Heavy bomber Patrol/early warning/electronic counter- measures/airborne command, control, or communications relay Trainer for Class III
Class IV	High-maneuverability airplanes such as Fighter/interceptor Attack Tactical reconnaissance Observation Trainer for Class IV

Where MIL-F-83300 applies, the corresponding MIL-F-83300, Class I, II, or III or IV applies.

Comparison monitor. A device which compares signals and warning outputs from two or more sources and provides its own signal to indicate that the two or more outputs are within or outside specified tolerances.

Control wheel (stick) steering. An AFCS mode which permits pilot manual control inputs to be introduced into the system through the wheel or stick when the AFCS is engaged and controlling the airplane.

Damping ratio. The equivalent second order viscous damping ratio. The critical damping ratio is defined as unity.

Decision height. Decision height, with respect to operation of aircraft means the height at which a decision must be made during an ILS (Instrument Landing System) or PAR (Precision Approach Radar) instrument approach to either continue the approach or to execute a missed approach.

This height is expressed in feet above runway datum altitude and for Category II ILS operations, the height is additionally expressed as a radio altimeter reading.

Dual load path. A type of passive paralleling wherein two separate load carrying paths exist. Each load path is capable of carrying sufficient load such that failure of either member will not jeopardize system performance.

Electrical flight control system (EFCS). A flight control system wherein one or more axes of vehicle control is, at one point or another, completely electrical. Non-electrical backup or other reversion means may exist. Electrical flight control is commonly referred to as fly-by-wire, especially where the application is either manual or essential.

Essential FCS. See 1.2.3.1

Extremely remote. The probability of an event occurring which, although theoretically possible, is not expected in the life of an individual aircraft. For the purpose of this specification, the extremely remote probability for a specific aircraft is defined as numerically equal to the maximum aircraft loss rate due to relevant FCS material failures specified in 3.1.7.

Failure. The inability of an item to perform within previously specified limits.

Failure rate. The number of failures of an item per unit measure of life (flights, time, cycles, events, miles, etc.) as applicable for the item.

FCS operational states. See 1.2.2

Firmware. A set of binary machine language instructions stored in read-only memory in a computer for the purpose of providing a step-by-step control of the processor.

Flight control system. See 1.1

Flight director subsystem. A subsystem which provides the pilot a display of actual and desired flight parameters. When operating in a flight director mode, the pilot's task is to minimize the difference between the displayed actual and desired values through control actions.

Flight envelopes. Flight envelopes referred within this specification are defined in MIL-F-8785 and MIL-F-83300.

Flight phase essential FCS. See 1.2.3.2

Fully-powered control system. See power-operated control

Inflight monitoring. Continuous automatic monitoring of system performance, normally performed inflight as a safety check.

Manual flight control system. See 1.2.1.1

Contrails

Nonaerodynamic loops. Inner feedback loops within an FCS which do not rely on aerodynamics for loop closure. Examples include AFCS servo loops and actuator feedback loops.

Noncritical FCS. See 1.2.3.3

Power-boasted control. A reversible control wherein pilot effort is exerted through mechanical linkages and is boosted, directly in proportion to the input, by a power source.

Power-operated control. An irreversible control wherein the pilot, through mechanical linkages or other means, actuates a power control package to control an aerodynamic surface or other device.

Random failure. Any failure whose occurrence is unpredictable in an absolute sense which is predictable only in a probabilistic or statistical sense. Random failures are those which cannot be attributed to wearout, defective design, or abnormal stress, and can occur at any time within the equipment's useful life.

Redundancy. A design approach such that two or more independent failures, rather than a single failure, are required to produce a given undesirable condition. Redundancy may take the form:

- a. Providing two or more components, subsystems, or channels, each capable of performing the given functions.
- b. Monitoring devices to detect failures and accomplish annunciation and automatic disconnect or automatic switching.
- c. Combination of the two above features.

Relevant failure. Any random or normal wearout failure occurring in service prior to end of specified service life when the equipment is properly operated within design load and environmental limits. A normal wearout failure is relatively improbable on a new part, but undergoes a relatively rapid rise in probability of occurrence after an extended period of service (operating hours or calendar time). Wearout is typical of seals, bearings, motor brushes, fatigue-critical structure, etc. A realistic system reliability computation must include proper allowance for such failures wherever they are not avoided by scheduled replacement/overhaul procedures in service.

Reversion. The capability to revert to a backup or alternate control from the normal control means. The alternate control may use mechanical or electrical signal transmission and powered actuation.

Software. A set of instructions intended to be stored in programmable memory of a computer for the purpose of providing step-by-step control to the processor. This includes source program instructions requiring assembly or compilation as well as binary machine language instructions.

Turbulence cumulative exceedance probability. The cumulative probability of experiencing turbulence at an intensity equal to or exceeding a given level. This probability accounts for both the probability of encountering turbulence and the distribution of the RMS intensity of the turbulence, if encountered.

Variable geometry control system. Those components and subsystems which transmit control commands from the pilot(s) and which produce forces and moments to change the aerodynamic configuration of the aircraft. Variable geometry controls include those for changing wing sweep angle and wing incidence angle, folding wing tips, deploying canard surfaces, and varying the angle of the nose of the aircraft with the body.

6.7 Use of limited coordination specifications. Limited coordination Military Specifications may be used when such are in effect on the date of invitation for bid or request for proposal. These specifications carry prefixes, such as MIL-A-008860A (USAF) in lieu of MIL-F-8860 (ASG).

6.8 Identification changes. Asterisks are not used in this revision to identify changes with respect to the previous issue, due to the extensiveness of the changes.

REFERENCES

1. Chalk, C., Neal, T., Harris, T., Pritchard, F., and Woodcock, R., "Background Information and User Guide for MIL-F-8785B (ASG), "Military Specification – Flying Qualities of Piloted Airplanes", AFFDL-TR-69-72, August 1969.
2. Anderson, R., "A New Approach to the Specification and Evaluation of Flying Qualities," AFFDL-TR-69-120, June 1970.
3. Morton, D., Hoode, J., Minnick, G., Hartman, W., Hackford, R., and Nickerson, T., "Analysis of Piloted Weapon Delivery," AFFDL-TR-72-105, 1973.
4. Franco, D., "Inflight Investigation of the Effects of Higher-Order Control System Dynamics of Longitudinal Handling Qualities," AFFDL-TR-68-90, August 1968.
5. Quinlivan, R., "Multimode Flight Control Definition Study for Precision Weapon Delivery," AFFDL-TR-71-39, June 1971.
6. Hendrick, Bailey, Edinger, et al, "Design Criteria for High Authority Closed-Loop Primary Flight Control Systems," AFFDL-TR-71-78, August 1972.
7. Rickard, R., and Gentry, J., "Development Testing of a High Gain Adaptive Control Augmentation System Installed in an F-4C Aircraft," FTC-TR-TD-70-4, September 1970.
8. Rickard, R., and Powell, C., "Stability and Control Evaluation of an F-4C Aircraft with a High-Gain Adaptive Control Augmentation System," FTC-TR-71-17, June 1971.
9. Stapleford, R., McRuer, D., Hoh, R., Johnston, D., and Heffley, R., "Outsmarting MIL-F-8785B (ASG), The Military Flying Qualities Specification," STI-TR-190-1, AD887637.
10. Anderson, C., and Walker, J., "A Stall Inhibitor System for the F-111," NAECON Paper, NAECON 1972 Record, pp. 222-226.
11. Robinson, A., "A Survey of Theoretical Dynamic Analysis Methods for Automatic Flight Control Design," AFFDL-TR-67-147, March 1968.
12. Tomlinson, L., "SST Longitudinal Control System Design and Design Processes – Hardened Stability Augmentation System," FAA-SS-73-1, June 1973.
13. ARINC Report No. 417, "Guidance Material for the Design of an Air Transport Automatic Flight Control System," April 1971.
14. Hall, J. C., "Automatic Aircraft Landing Systems," Presented at the IEEE International Convention and Exposition, 20-23 March 1972.
15. Litchford, G. B., "Analysis of Cumulative Errors Associated with Category II and III Operations with Requirements for Additional Research," NASA CR-1188, September 1968.

16. Johnson, W. and McRuer, B., "Development of a Category II Approach System Model," NASA CR-2022, May 1972.
17. Newman, F. and Foster J., "Investigation of a Digital Automatic Aircraft Landing System in Turbulence," NASA TN-D-6066, October 1970.
18. FTC-TR-67-30, "Air Force Evaluation of the B-52G and H Prototype Stability Augmentation and Flight Control System," February 1968.
19. Dempster, J., Roger, K., "Evaluation of B-52 Structural Response to Random Turbulence with Stability Augmentation Systems," Journal of Aircraft, Nov-Dec, 1967.
20. Rustenburg, J. W., "Development of Tracking Error Frequency Response Functions and Aircraft Ride Quality Design Criteria for Vertical and Lateral Vibration," ASD-TR-70-18, January 1971.
21. Rustenburg, J. W., "Ride Quality Design Criteria for Aircraft with Active Mode Control Systems," ASD-TR-72-64, October 1972.
22. International Organization for Standardization (ISO), "Guide for the Evaluation of Human Exposure to Whole Body Vibration," Draft International Standard ISO/DIS 2631, 1972.
23. Townsend, J., "Gust Alleviation and Mode Suppression System Design Criteria," Boeing D3-7600-14, December 1969.
24. Holloway, R., and Brumaghim, S., "Tests and Analyses Applicable to Passenger Ride Quality of Large Transport Aircraft," Included within NASA TM-X-2620, October 1972.
25. Gordon, C. and Dodson, R., "STOL Ride Control Feasibility Study – Technical Report", NASA CR-2276, July 1973.
26. Aerospace Medical Research Laboratory Memo, Lt. Colonel Sturges to T. D. Lewis, Subject: Recommended Weighting Functions for Human Response to Vibration, dated 8 July 1974.
27. Hoblet, F. M., "Effect of Yaw Damper on Lateral Gust Loads in Design of the L-1011 Transport", Presented at the 37th Meeting of the AGARD Structures and Materials Panel, October 1973.
28. Wykes, J., Mori, A., and Borland, C., "B-1 Structural Mode Control System," AIAA Paper No. 72-772, presented at the 4th Aircraft Design, Flight Test and Operations Meeting, August 7-9, 1972.
29. Wykes, J., Mori, A., "An Analysis of Flexible Aircraft Structural Mode Control," AFFDL-TR-65-190, June 1966.
30. Wykes, J., and McKnight, R., "Progress Report on a Gust Alleviation and Structural Dynamic Stability Augmentation System (GASDSAS) Design Study," AIAA Paper No. 66-999, November 29 – December 2, 1966.

Contrails

31. Wykes, J., "Structural Dynamic Stability Augmentation and Gust Alleviation of Flexible Aircraft". AIAA Paper No. 68-1067, October 21-24, 1968.
32. Wykes, J., and Kordes, E., "Analytical Design and Flight Tests of a Model Suppression System on the XB-70 Airplane," Proceedings of AGARD 34th Flight Mechanics Panel Meeting, Marseilles, France, April 21-24, 1969.
33. Mori, A., "B-1 Structural Mode Control System Design Considerations," Proceedings of National Aerospace Electronics Conference, May 15-17, 1972.
34. Edinger, L., Schenk, F., and Curtis, A., "Study of Load Alleviation and Mode Suppression (LAMS) on the YF-12A Airplane," NASA CR-2158, December 1971.
35. Townsend, J. L., et al, "Feasibility of an Active Flutter Control Demonstration," Boeing Document D3-8440, December 1970.
36. Nissim, E., "Flutter Suppression Using Active Controls Based on the Concept of Aerodynamic Energy," NASA TN D-6199, 1971.
37. McIntosh, S. C., "A Study of the Application of Model Suppression to Flutter Control", Stanford University SUDAAR No. 450, January 1973.
38. Theisen, J., and Robinette, W., "Servo Control of Flutter," AIAA Structural Dynamics and Aerolastic Specialist Conference Proceedings," April 1969, pp. 228-240.
39. Thompson, G. O., "Active Flutter Suppression – An Emerging Technology," Journal of Aircraft, Vol. 9, No. 3, pp. 230-235, March 1972.
40. Triplett, W. E., "A Feasibility Study of Active Wing/Store Flutter Control," Journal of Aircraft, Vol. 9, No. 6, page 438, June 1972.
41. Townsend, J., and Waltman, W., "Pivoting Wing Ride Smoothing/Flutter SAS Analysis," Boeing Document D3-8597, May 1971.
42. Moon, F., and Dowell, E., "The Control of Flutter Instability in a Continuous Elastic System Using Feedback," AIAA/ASME 11th Structures, Structural Dynamics and Materials Conference, Denver, April 1970.
43. Rainey, A., Ruhlin, C., and Sandford, M., "Active Control of Aerolastic Response," Paper presented at the AGARD Flight Mechanics Panel Symposium on Stability and Control, April 1972.
44. McKenzie, J. R., "B-52 Control Configured Vehicles Ride Control Analysis and Flight Test," AIAA Paper No. 73-782, Presented at the AIAA 5th Aircraft Design Flight Test and Operations Meeting, August 6-8, 1973.
45. Bergman, G. and DeBacker, G., "Terrain Following Criteria," AFFDL-TR-73-135, April, 1974.

Contrails

46. Bielka, Kavalok, Johnston and Reel, "Aircraft Flight Control Systems Field Experience," AFFDL-TR-72-33, May 1972.
47. Larson, Helfinstine, Ackerman and Neimczyk, "Flight Control Reliability Experience on Naval Tactical Aircraft," Presented to SAE Aerospace Control and Guidance Systems Committee, September 1972.
48. Painter, W. D. and Sitterle, G. J., "Ground and Flight Test Methods for Determining Limit Cycle and Structural Resonance Characteristics of Aircraft Stability Augmentation Systems," NASA TN-D-6867, June 1972.
49. Hooker, D. S., et al, "Survivable Flight Control System Final Report", AFFDL-TR-73-105, December 1973.
50. Poyneer, R. and Stockdale, C., "Control Configured Vehicle Ride Control System (CCV-RCS)", AFFDL-TR-73-83, July 1973.
51. Perry, D., and Burham, J., "A Flight Simulation Study of Difficulties in Piloting Large Jet Transport Aircraft through Severe Atmospheric Disturbances," C.P. No. 906 (AD No. 813961), 1967.
52. Houbolt, J. C., "Atmospheric Turbulence," AIAA Paper No. 72-219, Presented at the 10th Aerospace Sciences Meeting, San Diego, California, January 17-19, 1972.
53. Gilbert, W. P., "Analytical Study of Effects of Autopilot Operation on Motions of a Subconic Jet-Transport Airplane in Severe Turbulence," NASA TN D-5818, May 1970.
54. Onstott, E. and Salmon, E., "Airplane Flying Characteristics in Turbulence," AFFDL-TR-70-143, February 1971.
55. Porter, R. F., "A Proposed Criterion for Aircraft Flight in Turbulence," NASA CR-124834, 1971.
56. Rosenfeld, M., and Matero, L., "Flight Control Diagnostics for High Performance Aircraft," Grumman Report No. ADR07-05-69.1 (AD No. 878939), March 1969.
57. Hooker, D., Kisslinger, R., Smith G., Smyth, M., "Survivable Flight Control System Interim Report No. 1 - Studies, Analysis and Approach," AFFDL-TR-71-20, May 1971.
58. Bird, D. K., "Flight Control System Mechanization," NAECON paper, NAECON '72 Record, pp 212-219.
59. Tomlinson, L. R., "Problems and Solutions Related to the Design of a Control Augmentation System for a Longitudinal Unstable Supersonic Transport," AIAA Paper No. 72-871, Presented at the AIAA Guidance and Control Conference, Stanford, California, August 14-16, 1972.
60. Emfinger, J. and Flannigan, J., "Fly-By-Wire Technology," AIAA Paper No. 72-882, Presented at the AIAA Guidance and Control Conference, Stanford, California, August 14-16, 1972.

Contrails

61. Deets, D. and Szalai, K., "Design and Flight Experience with a Digital Fly-By-Wire Control System Using Apollo Guidance System Hardware on a F-8 Aircraft," AIAA Paper No. 72-881, Presented at the AIAA Guidance and Control Conference, Stanford, California, August 14-16, 1972.
62. Kisslinger, R. and Lorenzette, R., "The Fly-By-Wire Approach to Aircraft Flying Qualities," NAECON Paper from the 1972 NAECON Record, pp 205-210.
63. Campbell, J. E., "Unique Features of the B-1 Flight Control Systems," AIAA Paper No. 72-872, August 1972.
64. Lorenzetti, C., Kisslinger, R., Smyth, M., "Survivable Flight Control System Program - Simplex Actuator Package," AFFDL Technical Memo FG/ADPO-70-135, January 1971.
65. Amies, Gerald E., "Survivable Flight Control System Interim Report No. 1 - Supplement for Hydraulic Power and Actuation Studies," AFFDL-TR-71-20, May 1971.
66. Stalcup, D., Coppola, P., Rinde, J., "Research and Development of a Servo Actuator Package for a Tactical Fighter Aircraft," AFFDL-TR-69-129, June 1970.
67. Yore, E. E., "Requirements for Minimum Backup Flight Control Systems," AFFDL-TR-70-48, October 1970.
68. Blatt, P. and Hall, J., "Concepts for Standby Emergency FCS," Unnumbered AFFDL Interim Technical Report, February 1968.
69. Jenny, G. D., "Test and Development of Flight Control Actuation System Components for Military Aircraft," AFFDL-TR-71-76, July 1971.
70. "Hydraulic System Survivability" SAE Aerospace Information Report, AIR 1083, October 1, 1969.
71. Rhoads, D. W., "In-Flight Evaluation of Four Cockpit Controller Configurations in a Variable Stability Airplane," AFFDL-TR-70-95, September 1970.
72. McMaster, J. and Schenk, F., "The Development of the F-12 Series Aircraft Manual and Automatic Flight Control System" AIAA Paper No. 73-822, Presented at the 5th Aircraft Design, Flight Test and Operations Meeting, August 6-8, 1973.
73. "Design and Evaluation of Primary Hand Controllers for Fighter Aircraft," AFFDL-TR-71-16, 1971.
74. Smith, P. L., "Breaking Strength and Endurance Testing of Aircraft Control Cables," SEG-TR-67-19, May 1967.
75. Smith, P. L., "Evaluation of Nylon and Polyolefin Jacketed Aircraft Control Cables," ASD-TR-68-30, August 1968.

Contrails

76. Anonymous, "Electrical Interconnections for Fly-By-Wire Flight Control Systems," AFFDL-TR-70-134, October 1970.
77. Mrazek, J., Roberts, R. and Doggett, D., "Research into the Definition and Demonstration of an Optimum Solid State Switching and Multiplexing System for use in a Fly-By-Wire Flight Control System" AFFDL-TR-70-80, June 1970.
78. Goldstein, S., Schreadley, H. and Bazill, D., "Test and Development of Flight Control Actuation System Components for Military Aircraft," AFFDL-TR-72-13, April 1972.
79. Mrazek, J., and Roberts, R., "Design, Development, and Flight Test of Multiplexing Hardware for use in a Fly-By-Wire Flight Control System," AFFDL-TR-73-43, April 1973.
80. King, O. and Ramsey, W., "Aircraft Electrical System Multiplexing," SAE paper presented at the National Air Transport Meeting, April 20, 1970.
81. Kumpitsch, R. and Sturges, D., "Liquid Metal Actuator Package Design Study for a Fly-By-Wire FCS," AFFDL-TR-20-121, February 1971.
82. Verge, K., and Read, R., "Testing of a Pneumatic Servomechanism," AFFDL-TR-71-146, February 1972.
83. Thatcher, R. K., et al, "Development of Unified Reliability Prediction Techniques for Flight Control Systems," AFFDL-TR-70-81, June 1970.
84. Peterson, B., Krier, G., and Jarvis, C., "Development and Flight Test of a Digital Fly-By-Wire F-8 Airplane," Paper presented at the Society of Experimental Test Pilots Symposium, September 28-30, 1972.
85. SAE, "Aerospace Recommended Practice Lightning Effects Tests on Aerospace Vehicles and Hardware, Final Draft", SAE Committee AE4, Special Task F, May 1974.
86. Arthurs, F., et al, "Interaction Between Control Augmentation System and Airframe Dynamics on YF-17," AIAA Paper No. 75-824, Presented at AIAA Symposium, Denver, Colorado, 29 May 1975.
87. Carleton, D., Lawyer, R., and Powell, C., "Development and Evaluation of Twead II Flight Control Augmentation System," FTC-TD-72-1, November 1972.

APPENDIX A

DERIVATION OF RELIABILITY REQUIREMENTS
FROM ACTUAL FIELD SAFETY EXPERIENCE DATA

A broad cross-section (over ten years) of pertinent aircraft accident and loss experience was obtained on typical large multiengine aircraft, fighter aircraft, and helicopters from the Air Force Safety and Inspection Center, Norton Air Force Base, California. Safety experience for the B-52, C-135 and C-141 was examined to establish typical flight safety reliability requirements for MIL-F-8785 Class III aircraft. The F-4 was selected as typical of MIL-F-8785 Class I, II and IV aircraft and the H-1, H-3, H-43, and H-53 experience is summarized as typical for helicopters. The following summarizes pertinent flight safety experience on the above listed aircraft for the period January 1962 through May 1973. Experience on aircraft introduced after January 1962 is from year of introduction through May 1973.

B-52 Experience 1962 - May 1973

Major Accident Rate = 1.100/100,000 flight hours
8.583/100,000 flights

Major Accidents Material Failure		<u>Total Acc.</u>	<u>Aircraft Destroyed</u>
Primary Cause -	100,000 FH	0.275	0.175
	100,000 Flights	2.145	1.365
By System			
Airframe -	100,000 FH	0.125	0.100
	100,000 Flights	0.975	0.780
Brakes -	100,000 FH	0.050	0.050
	100,000 Flights	0.390	0.390
Pneumatic	100,000 FH	0.025	0.025
	100,000 Flights	0.195	0.195
Engine	100,000 FH	0.025	-
	100,000 Flights	0.195	-
Flight Control	100,000 FH	0.025	-
	100,000 Flights	0.195	-
Landing Gear	100,000 FH	0.025	-
	100,000 Flights	0.195	-

B-52 experience covered 3,998,611 flight hours and approximately 512,642 flights.

C-141 Experience 1964 - May 1973

Major Accident Rate = 0.189/100,000 flight hours
1.439/100,000 flights

		<u>Total Acc.</u>	<u>Aircraft Destroyed</u>
Major Accidents Material Failure			
Primary Cause -	100,000 FH	0.108	-
	100,000 Flights	0.822	-
By System			
Airframe -	100,000 FH	0.054	-
	100,000 Flights	0.411	-
Hydraulics	100,000 FH	0.027	-
	100,000 Flights	0.206	-
Brakes	100,000 FH	0.027	-
	100,000 Flights	0.206	-

C-141 experience covered 3,698,192 flight hours and approximately 486,604 flights.

C-135 Experience 1962 - May 1973

Major Accident Rate = 0.923/100,000 Flight Hours
5.075/100,000 Flights

		<u>Total Acc.</u>	<u>Aircraft Destroyed</u>
Major Accidents Material Failure			
Primary Cause -	100,000 FH	0.154	0.066
	100,000 Flights	0.846	0.363
By System			
Airframe -	100,000 FH	0.022	0.022
	100,000 Flights	0.121	0.121
Landing Gear -	100,000 FH	0.044	-
	100,000 Flights	0.242	-
Engine -	100,000 FH	0.066	0.022
	100,000 Flights	0.363	0.121

Contrails

		<u>Total Acc.</u>	<u>Aircraft Destroyed</u>
Fuel -	100,000 FH	0.022	0.022
	100,000 Flights	0.121	0.121

C-135 experience covered 4,552,143 flight hours and approximately 827,662 flights.

B-52/C-135/C-141 Combined Experience 1962 - May 1973

Major Accident Rate = 0.759/100,000 Flight Hours
5.091/100,000 Flights

		<u>Total Acc.</u>	<u>Aircraft Destroyed</u>
Major Accidents Material Failure			
Primary Cause -	100,000 FH	0.180	0.082
	100,000 Flights	1.204	0.547
By System			
Airframe -	100,000 FH	0.065	0.041
	100,000 Flights	0.438	0.274
Brakes -	100,000 FH	0.024	0.016
	100,000 Flights	0.164	0.109
Engine -	100,000 FH	0.032	0.008
	100,000 Flights	0.219	0.055
Landing Gear	100,000 FH	0.024	-
	100,000 Flights	0.164	-
Fuel -	100,000 FH	0.008	0.008
	100,000 Flights	0.055	0.055
Pneumatic	100,000 FH	0.008	0.008
	100,000 Flights	0.055	0.055
Flight Control	100,000 FH	0.008	-
	100,000 Flights	0.055	-
Hydraulics -	100,000 FH	0.008	-
	100,000 Flights	0.055	-

The combined B-52/C-135/C-141 experience covered 12,248,946 flight hours and approximately 1,826,908 flights.

Contrails

F-4 Experience - 1964 - May 1973

Major Accident Rate = 7.748/100,000 Flight Hours
12.398/100,000 Flights

		<u>Total</u>	<u>Aircraft Destroyed</u>
Major Accidents Material Failure			
Primary Cause -	100,000 FH	1.974	1.486
	100,000 Flights	3.158	2.378
By System			
Airframe -	100,000 FH	0.049	0.024
	100,000 Flights	0.078	0.039
Landing Gear -	100,000 FH	0.292	0.049
	100,000 Flights	0.468	0.078
Flight Controls -	100,000 FH	0.341	0.341
	100,000 Flights	0.546	0.546
Fuel -	100,000 FH	0.170	0.170
	100,000 Flights	0.273	0.273
Electrical -	100,000 FH	0.073	0.073
	100,000 Flights	0.117	0.117
Hydraulic	100,000 FH	0.219	0.219
	100,000 Flights	0.351	0.351
Ordnance -	100,000 FH	0.073	0.049
	100,000 Flights	0.117	0.078
Instruments -	100,000 FH	0.024	0.024
	100,000 Flights	0.039	0.039
Brakes -	100,000 FH	0.122	0.049
	100,000 Flights	0.195	0.078
Pneumatic -	100,000 FH	0.073	0.024
	100,000 Flights	0.117	0.039
Powerplant Components -	100,000 FH	0.049	0.049
	100,000 Flights	0.078	0.078
Engine -	100,000 FH	0.439	0.390
	100,000 Flights	0.702	0.624

Contrails

		<u>Total Acc.</u>	<u>Aircraft Destroyed</u>
Miscellaneous	100,000 FH	0.049	0.024
	100,000 Flights	0.078	0.039

F-4 experience covered 4,103,851 flight hours and approximately 2,564,907 flights.

H-1 Experience 1962 - May 1973

Major Accident Rate = 5.862/100,000 Flight Hours
8.091/100,000 Flights

		<u>Total</u>	<u>Aircraft Destroyed</u>
Major Accidents Material Failure			
Primary Cause -	100,000 FH	1.832	1.832
	100,000 Flights	2.528	2.528
By System			
Flight Control -	100,000 FH	0.183	0.183
	100,000 Flights	0.253	0.253
Hydraulics -	100,000 FH	0.183	0.183
	100,000 Flights	0.253	0.253
Powerplant Components -	100,000 FH	1.099	1.099
	100,000 Flights	1.517	1.517
Engine -	100,000 FH	0.366	0.366
	100,000 Flights	0.505	0.505

H-1 experience covered 545,796 flight hours and approximately 395,504 flights.

H-3 Experience - 1963 - May 1973

Major Accident Rate = 5.637/100,000 Flight Hours
10.203/100,000 Flights

		<u>Total Acc.</u>	<u>Aircraft Destroyed</u>
Major Accidents Material Failure			
Primary Cause -	100,000 FH	0.752	0.511
	100,000 Flights	1.360	0.925
By System			
Powerplant	100,000 FH	0.752	0.511
Components -	100,000 Flights	1.360	0.925

H-3 experience covered 266,075 flight hours and approximately 147,002 flights.

H-43 Experience - 1962 - May 1973

Major Accident Rate = 7.231/100,000 Flight Hours
7.158/100,000 Flights

		<u>Total Acc.</u>	<u>Aircraft Destroyed</u>
Major Accidents Material Failure			
Primary Cause -	100,000 FH	1.534	0.657
	100,000 Flights	1.518	0.650
By System			
Flight Controls -	100,000 FH	0.219	0.219
	100,000 Flights	0.216	0.216
Engine -	100,000 FH	1.314	0.438
	100,000 Flights	1.301	0.434

H-43 experience includes 456,362 flight hours and approximately 460,971 flights.

H-53 Experience - 1966 - May 1973

Major Accident Rate = 3.644/100,000 Flight Hours
8.091/100,000 Flights

		<u>Total Acc.</u>	<u>Aircraft Destroyed</u>
Major Accidents Material Failure			
Primary Cause -	100,000 FH	0	0
	100,000 Flights	0	0

H-53 experience included 82,316 flight hours and approximately 37,079 flights.

H-1/H-3/H-43/H-53 Combined Experience 1962 - May 1973

Major Accident Rate = 6.145/100,000 Flight Hours
7.976/100,000 Flights

		<u>Total Acc.</u>	<u>Aircraft Destroyed</u>
Major Accidents Material Failure			
Primary Cause -	100,000 FH	1.407	1.037
	100,000 Flights	1.826	1.345
By System			
Engine -	100,000 FH	0.592	0.296
	100,000 Flights	0.769	0.384
Powerplant Components -	100,000 FH	0.592	0.518
	100,000 Flights	0.769	0.672
Flight Controls -	100,000 FH	0.148	0.148
	100,000 Flights	0.192	0.192
Hydraulics -	100,000 FH	0.074	0.074
	100,000 Flights	0.096	0.096

The combined helicopter experience includes 1,350,549 hours and approximately 1,040,566 flights.

Although the F-111 is not considered typical of USAF fighter operations, the experience is included here for information. The rates are not considered in Figures A-1 through A-3 but are shown individually in Figure A6.

F-111 Experience 1965 - May 1973

Major Accident Rate = 13.391/100,000 Flight Hours
36.825/100,000 Flights

		<u>Total Acc.</u>	<u>Aircraft Destroyed</u>
Total Major Accidents Material Failure			
Primary Cause -	100,000 FH	6.003	3.694
	100,000 Flights	16.508	10.159
By System			
Flight Controls -	100,000 FH	1.847	1.385
	100,000 Flights	5.079	3.809
Airframe -	100,000 FH	1.385	0.924
	100,000 Flights	3.809	2.539
Air Cond.	100,000 FH	0.924	--
Pressurization -	100,000 Flights	2.539	--
Landing Gear -	100,000 FH	0.462	0.462
	100,000 Flights	1.270	1.270
Engine -	100,000 FH	0.462	--
	100,000 Flights	1.270	--
Fuel -	100,000 FH	0.462	0.462
	100,000 Flights	1.270	1.270
Ordnance -	100,000 FH	0.462	0.462
	100,000 Flights	1.270	1.270

Figure A1 depicts the accident rates in terms of 100,000 flight hours, and illustrates how the accident experience on the aircraft measured falls into three distinct safety levels.

Figure A2 portrays the same information measured in terms of number of flights, rather than flight hours. Helicopter and large aircraft experience is more closely aligned when measured in number of flights.

Figures A3, A4, and A5 illustrate the potential and actual aircraft loss rates due to material failure in individual aircraft systems.

For the purpose of this report, aircraft systems are as defined in Air Force Inspection and Safety Center Manual 127-1 (AFISCM 127-1) dated 1 January 1972. Flight control system includes the flight control surfaces, control and actuation, electro-hydro-mechanical components, automatic flight control, but not the power source systems, or portions thereof.

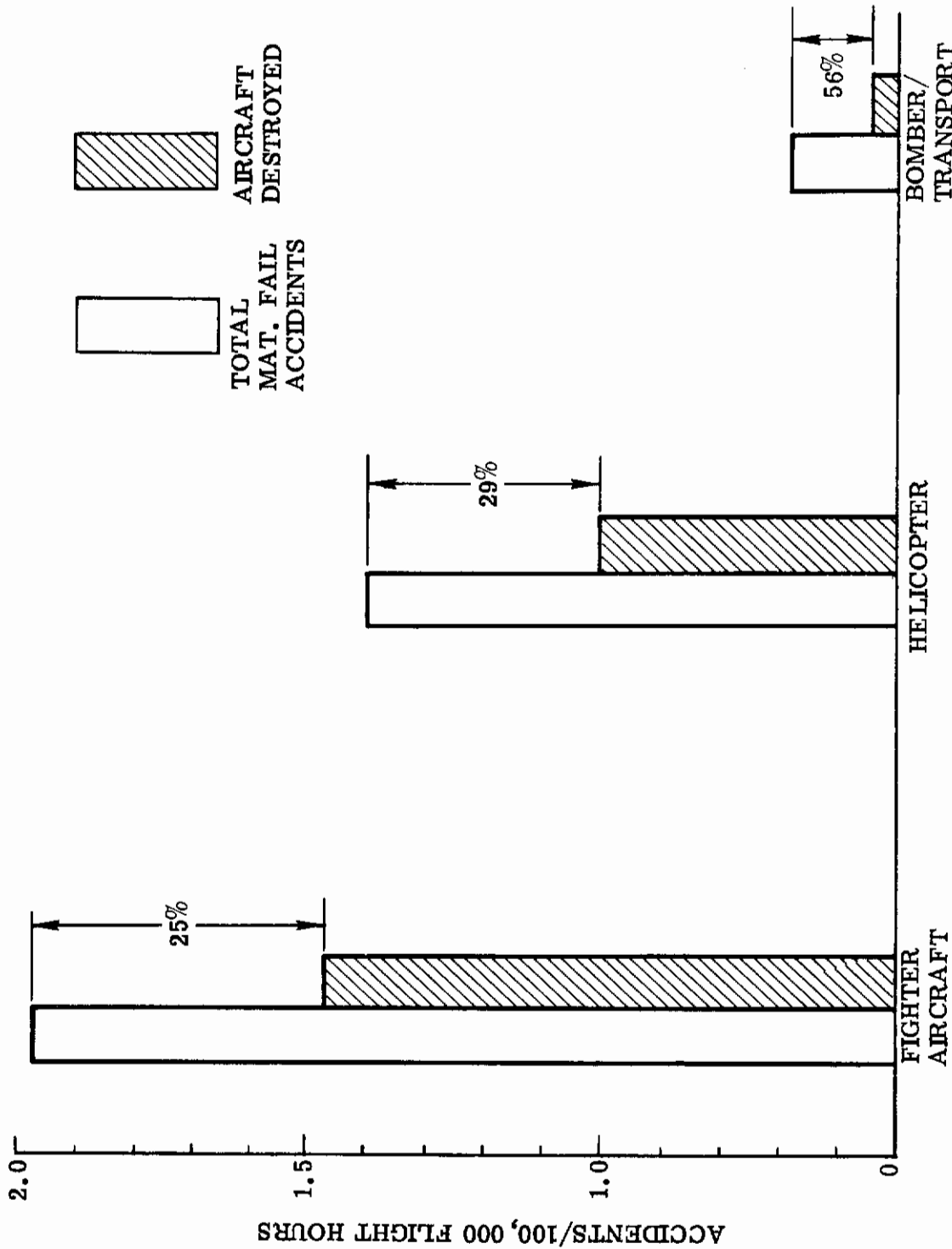
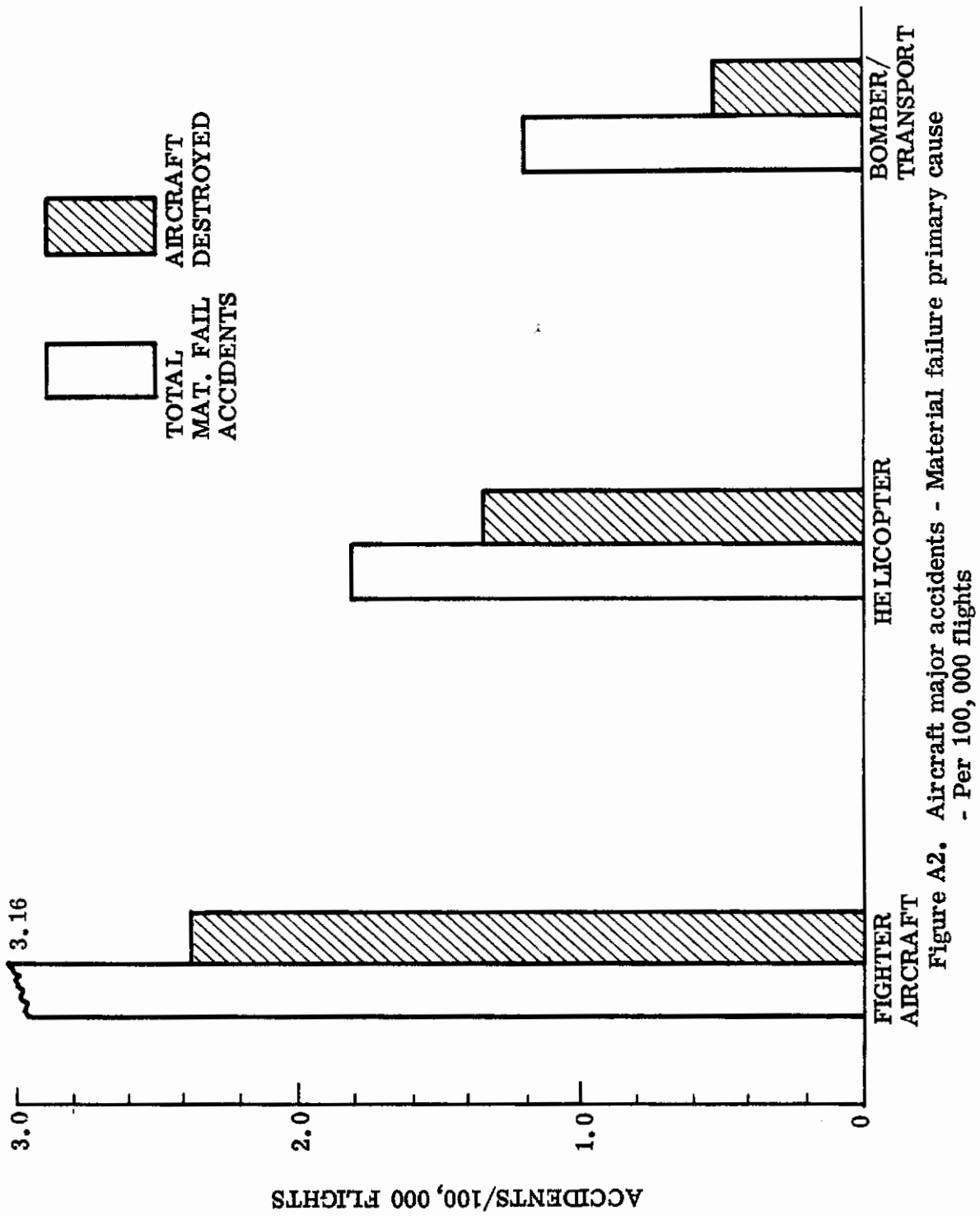

Figure A1. Aircraft major accidents - Material failure primary cause - Per 100,000 hours



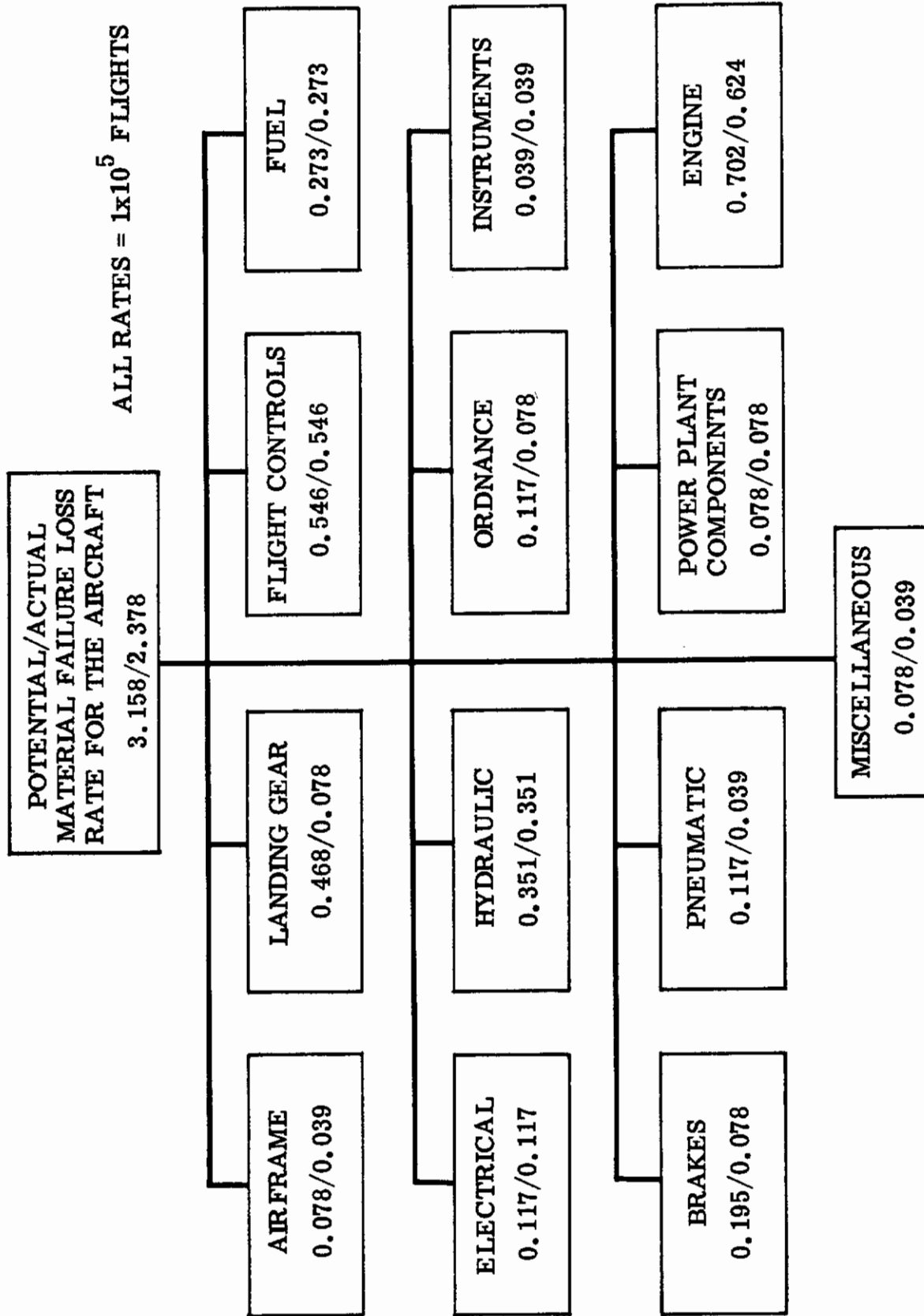

Figure A3. Potential and actual material failure aircraft loss rates (fighter aircraft)

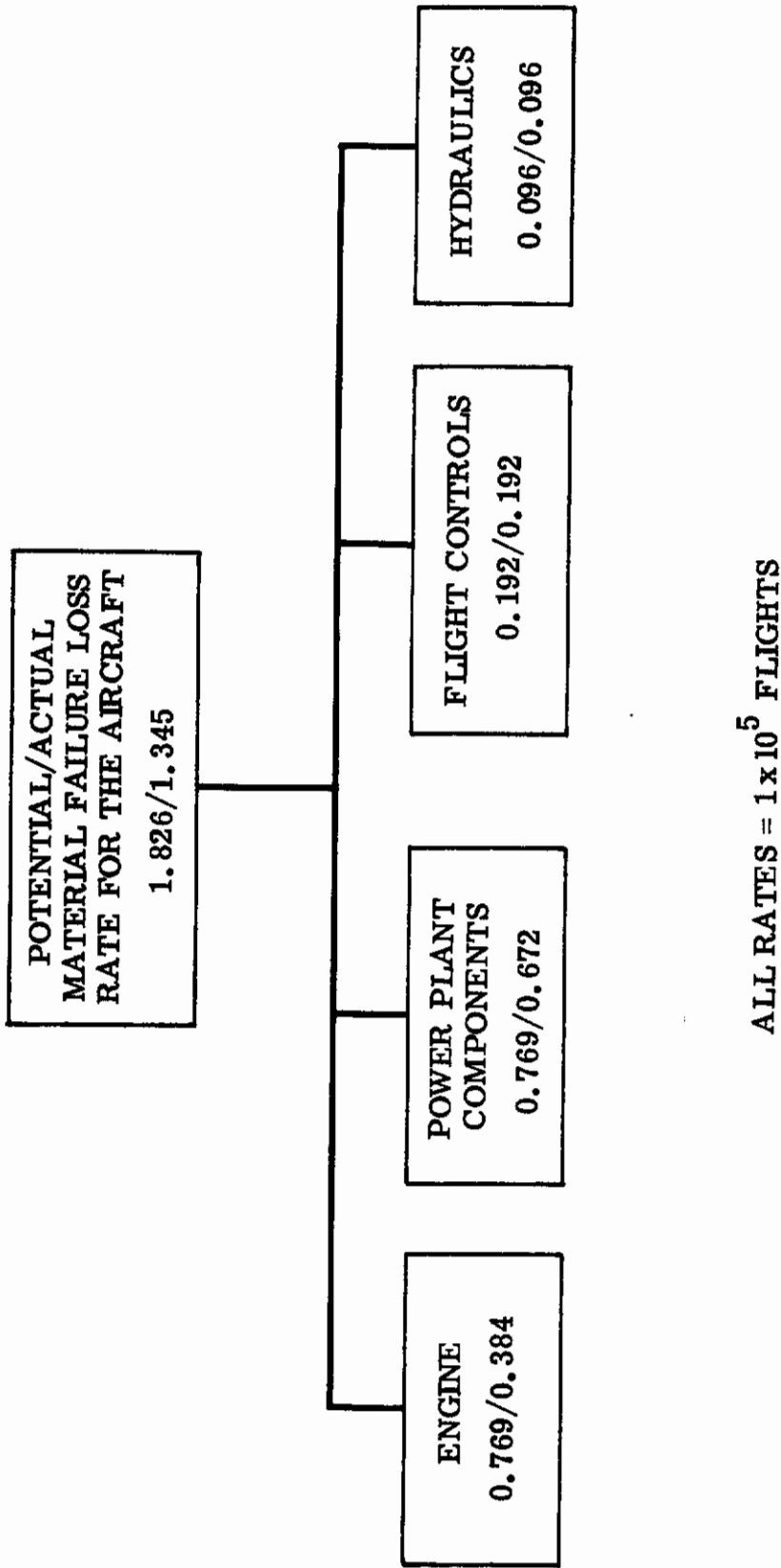
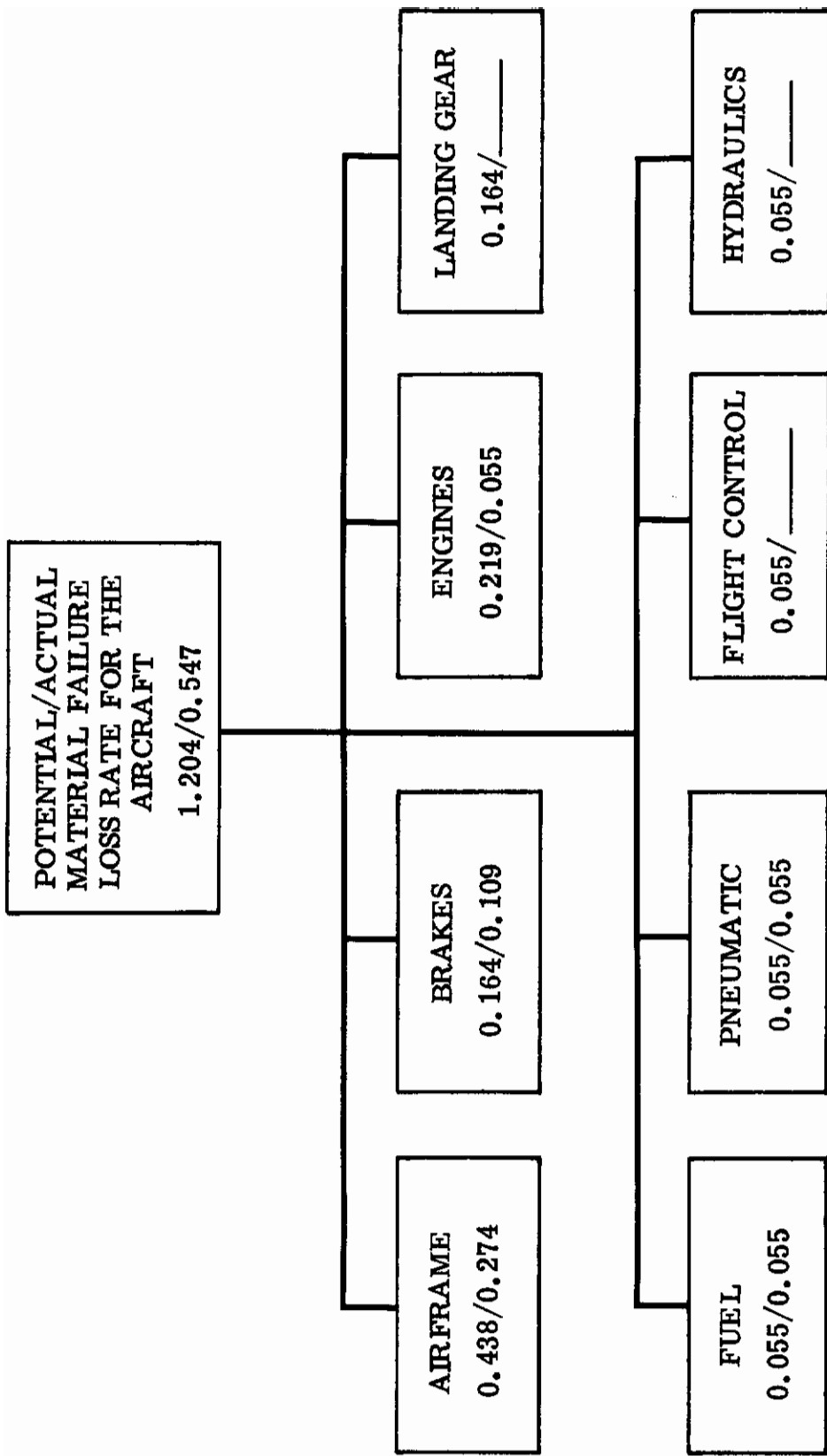

Figure A4. Potential and actual material failure aircraft loss rates (helicopter aircraft)



ALL RATES = 1×10^5 FLIGHTS

Figure A5. Potential and actual material failure aircraft loss rates (bomber/transport aircraft)

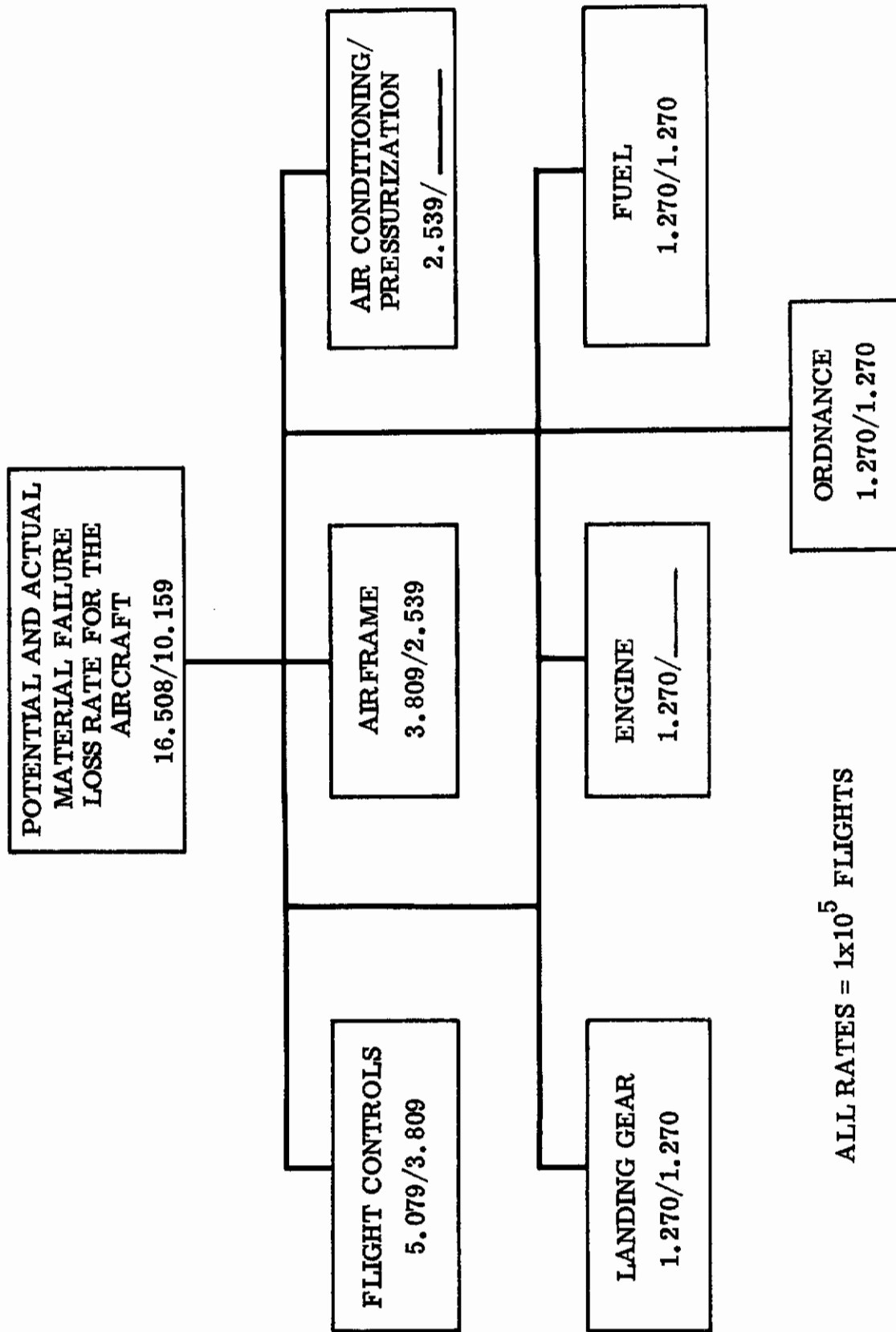

Figure A6. Potential and actual material failure aircraft loss rates (F-111 aircraft)

APPENDIX B

METHODS OF DETERMINING COMPONENT OR SUBSYSTEM RELIABILITY INCREASES REQUIRED TO COMPENSATE FOR BLIND REDUNDANCIES

In the DISCUSSION of Paragraph 3.1.7.1, Reliability - Flight Safety, it was noted that it will not always be possible to determine that all subsystems and components are failure-free and operable before each flight. Therefore, since the basic reliability requirements, $Q(t)_{F.S.}$, are stated in terms of the probability of aircraft loss due to FCS failure during single flights of specified duration, it is necessary to properly compensate for such blind redundancies.

SOLUTIONS OF ELEMENTARY BLIND REDUNDANCIES

Redundant subsystems are usually analyzed on the assumption that all elements are unfailed at the start of a mission; hence subsystem failure generally involves the occurrence of two or more independent failures during the same mission.

In many practical cases, there are one or more elements that are not checked between missions and whose failure is not ordinarily detectable in flight unless other elements also fail. In such cases, of course, the usual assumption that all elements are unfailed at the start of the mission would lead to erroneous subsystem reliability predictions.

The two simplest cases are solved as outlined below.

Case I - Single-Blind Redundancy

Assume two components A and B in parallel. Failure of A alone is not ordinarily noticeable, and it is not considered feasible to check the true condition of A between flights. Component A is, however, checked in a scheduled inspection at intervals of T_I flight hours.

Failure of Component B is readily noticeable, and it will receive maintenance before the next flight if failure is observed.

Consider one inspection interval of T_I hours, during which time the aircraft flies n missions of T_M hours each. The subsystem fails if B fails and A fails either during the same mission or during any earlier mission during the given inspection interval T_I . The resulting average mission reliability is derived as shown in Table B1.

TABLE B1
SOLUTION OF SINGLE-BLIND REDUNDANCY

Components A and B in parallel. Component A has constant hourly failure rate X_A , and its condition is checked only at intervals of T_I hours. Component B has constant hourly failure rate X_B , and its condition is checked each mission. Mission duration is T_M hours. $T_I/T_M = n =$ number of missions flown during one T_I inspection interval.

	CLASSICAL METHOD (Component unreliability taken as $1 - e^{-XT}$)	APPROXIMATE METHOD (Component unreliability taken as XT)
Probability A fails during T_M	$1 - e^{-X_A T_M}$	$X_A T_M$
Probability B fails during T_M	$1 - e^{-X_B T_M}$	$X_B T_M$
Probability A and B both fail during first mission of interval T_I	$(1 - e^{-X_A T_M})(1 - e^{-X_B T_M})$	$X_A X_B T_M^2$
Probability subsystem fails on the Kth mission, due to failure of A at any time during the first K missions combined with failure of B during the Kth mission.	$(1 - e^{-K X_A T_M})(1 - e^{-X_B T_M})$	$K X_A X_B T_M^2$
Total probability of subsystem failure during the interval $T_I = n T_M$	$\sum_{K=1}^n (1 - e^{-K X_A T_M})(1 - e^{-X_B T_M})$	$\sum_{K=1}^n K X_A X_B T_M^2$ $= (1+2+\dots+n)(X_A X_B T_M^2)$ $= \frac{(n)(n+1)}{2} X_A X_B T_M^2$
Average probability of subsystem failure during one of the above n missions: $Q(t)_{SYS}$	$\frac{1}{n} \sum_{K=1}^n (1 - e^{-K X_A T_M})(1 - e^{-X_B T_M})$	$\frac{1}{n} \frac{(n)(n+1)}{2} X_A X_B T_M^2$ $= \frac{(n+1)}{2} X_A X_B T_M^2$ $= \frac{(n+1)}{2n} X_A X_B T_M T_I$

Case II - Double-Blind Redundancy

In this case, neither component is checked except at scheduled inspection intervals of T_I flight hours. The subsystem fails if both A and B fail during the interval T_I . The resulting average mission reliability is derived as shown in Table B2 .

TABLE B2

SOLUTION OF DOUBLE-BLIND REDUNDANCY

Components A and B in parallel, with constant hourly failure rates X_A and X_B , respectively. Failure of either component alone is not noticeable. Components not checked in preflight. Both components are checked at intervals of T_I hours. Mission duration is T_M hours. $T_I/T_M = n =$ number of missions flown during one T_I inspection interval.

	CLASSICAL METHOD (Component unreliability taken as $1 - e^{-XT}$)	APPROXIMATE METHOD (Component unreliability taken as XT)
Probability A fails during T_I	$1 - e^{-X_B T_I}$	$X_A T_I$
Probability B fails during T_I	$1 - e^{-X_B T_I}$	$X_B T_I$
Probability A and B both fail during T_I	$(1 - e^{-X_A T_I}) (1 - e^{-X_B T_I})$	$X_A X_B T_I^2$
Average mission unreliability $Q(t)_{SYS}$	$\frac{1}{n} (1 - e^{-X_A T_I}) (1 - e^{-X_B T_I})$	$\frac{1}{n} X_A X_B T_I^2$ $= X_A X_B T_M T_I$

In the typical practical case, the difference between the "Classical" and "Approximate" methods per Tables B1 and B2 is trivial. If any of the XT products are fairly large (say, 0.10 or more), the difference between the two solutions may become significant. The two methods provide an upper bound and a lower bound, between which the true answer lies. The "Classical" method is slightly unconservative, as it neglects the probability of two or more subsystem failures during the same T_I inspection interval. The "Approximate" method is slightly conservative. A completely precise and rigorous approach yields such a cumbersome solution that it is impracticable.

It is apparent from the "Approximate method" columns of Table B1 and Table B2 that the single-blind redundancy yields approximately half the subsystem unreliability of the double-blind redundancy. The factor $\frac{n+1}{2n}$ approaches 0.5 for large values of n .

TYPICAL EXAMPLES

For a typical example of the three possible cases of no-blind redundancy, single-blind redundancy, and double-blind redundancy in a simple, two-element subsystem, consider the following:

- a. An actuating subsystem with two actuators: one hydraulic and one emergency pneumatic.
- b. The maximum allowable failure rate for the subsystem is $Q(t)_{SYS} = 9.0 \times 10^{-8}$ failures/flight, considering,

- c. An average flight duration of $T_M = 1.5$ hours.
- d. A hydraulic actuator with a known failure rate of $X_H = 2.0 \times 10^{-4}$ failures/hour is used.

The reliability requirement for the pneumatic actuator, X_P , is solved for the three cases.

Case I, No-Blind Redundancy

Both actuators are checked prior to each flight:

$$Q(t_m)_P = \frac{Q(t_m)_{SYS}}{Q(t_m)_H} = \frac{9.0 \times 10^{-8}}{2.0 \times 10^{-4} \times 1.5} = 3.0 \times 10^{-4} \text{ failures/flight}$$

then X_P must be $\frac{3.0 \times 10^{-4}}{1.5} = 2.0 \times 10^{-4}$ failures/hour.

Case II, Single-Blind Redundancy

The hydraulic actuator is checked before each flight, but the pneumatic actuator is checked only once a month; an inspection interval of $T_I = 30$ flight hours during which time the aircraft flies $n = 20$ missions of $T_M = 1.5$ hours each.

Referring to Table B1, $Q(t)_{SYS} = \binom{n+1}{2n} X_A \cdot X_B \cdot T_M \cdot T_I$

$$X_A = \binom{2n}{n+1} \frac{Q(t)_{SYS}}{X_B \cdot T_M \cdot T_I}, \text{ and for this problem:}$$

$$X_P = \binom{2n}{n+1} \frac{Q(t)_{SYS}}{X_H \cdot T_M \cdot T_I} = \frac{40}{21} \cdot \frac{9.0 \times 10^{-8}}{2.0 \times 10^{-4} \cdot 1.5 \cdot 30}$$

X_P must be 1.9×10^{-5} failures/hr.

Case III, Double-Blind Redundancy

Both actuators are checked only once a month: an inspection interval of $T_I = 30$ flight hours during which time the aircraft flies $n = 20$ missions of $T_M = 1.5$ hours each.

Referring to Table B2, $Q(t)_{SYS} = X_A X_B T_M T_I$

$$X_P = X_H \frac{Q(t)_{SYS}}{T_M \cdot T_I} = \frac{9.0 \times 10^{-8}}{2.0 \times 10^{-4} \cdot 1.5 \cdot 30}$$

X_P must be 1.0×10^{-5} failures/hour.