

**DETERMINATION OF THE INDIGENOUS MICROFLORA
OF MEN IN CONTROLLED ENVIRONMENTS**

*PHYLLIS E. RIELY
DONNA GEIB
DIANE SHORENSTEIN*

**Distribution of this document
is unlimited**

FOREWORD

This is the final report of a study conducted both at the Aerospace Medical Research Laboratories, Wright-Patterson Air Force Base, and in the Life Sciences Division of the Paul Moore Research and Development Center of Fairchild Hiller Corporation (Republic Aviation Division) at Farmingdale, L.I., New York, under Air Force Contract AF33(615)-1814. The study was initiated in support of Project No. 7164, "Biomedical Criteria for Aerospace Flight," Task No. 716405, "Aerospace Nutrition," by the Air Force technical monitor, Dr. Sheldon London, Physiology Division of the Biomedical Laboratory. The basic study in nutrition was funded by the National Aeronautics and Space Administration, Manned Spacecraft Center, Houston, Texas under NASA Defense Purchase Request R-85.

This study was begun under the direction of Dr. Lorraine S. Gall, who participated in the major portion of the study and was completed under the direction of Mrs. Phyllis E. Riely. Field investigation was carried out by Phyllis Riely, Donna Geib, Diane Shorenstein, Betsy Moss, and Sandra Jones. The authors wish to acknowledge the invaluable assistance of Shirley Dunwoody, Fay Ames, Mae Court, Charlotte Titus, Jacquelyn Miller, Charles Huhtanen, and Dr. Helen Osburg. The identification of Streptococci sp. was carried out by Mr. Arselus West, Microbiologist, of the Biospecialties Branch, AMRL, Wright-Patterson Air Force Base. The information on staphylococcal distribution and coagulase activity was carried out under separate contract (AF33(657)-11716) by Mr. Joseph Rack and Mrs. Bonnie Horstman of Miami Valley Hospital Research Department.

This technical report has been reviewed and is approved.

WAYNE H. McCANDLESS
Technical Director
Biomedical Laboratory
Aerospace Medical Research Laboratories

ABSTRACT

The objective of this study was to collect, under controlled conditions simulating space travel, microbiological data from 13 body areas of 20 subjects and their specialized environment. These data were evaluated to establish biomedical criteria for personal hygiene and sanitation for aerospace missions, and to suggest possible indices of the deterioration of environmental conditions. Data derived in the study provided information on microbial dynamics, the effects of confinement stress on the microbiological populations of individuals, and information on bacterial levels in the closed environment. The study strengthened the evidence that, in general, man can go without bathing for 6 weeks without significant deterioration of the dermis. It pointed out the importance of sampling the groin and glans penis as "indicator" areas which quickly signal deterioration in hygienic standards. The specific buildup of both corynebacteria and micrococccaceae species in almost all sampled body sites was significant. Another objective of this program was to study the effects of the various space-type diets on the fecal flora of the subjects. The data revealed that although the obligately anaerobic character of the feces remained unchanged, the types of anaerobes recovered differed markedly from those found to be predominant in the "normal" population. The shift in the types of anaerobic bacteria is discussed from the viewpoints of vitamin production, lactic acid production, and deaminating and decarboxylating activities.

Contrails
TABLE OF CONTENTS

<u>Section</u>	<u>Title</u>	<u>Page</u>
I	INTRODUCTION	1
II	MATERIALS AND METHODS	9
	A. Collection of Samples	9
	1. Body Areas	9
	2. Feces	10
	3. Environmental Areas	10
	B. Primary Culturing	10
	1. Primary Culturing of Body Areas (Other Than Feces)	10
	2. Primary Culturing of Feces	13
	3. Primary Culturing of Environmental Areas	15
	C. Secondary Culturing	15
	1. Aerobic	15
	2. Anaerobic	17
III	EXPERIMENTAL RESULTS	22
IV	CONCLUSIONS	35
	A. Background/Interpretation	35
	1. Bacterial Buildup on Man	35
	2. Unnecessary Sampling Areas	35
	3. "Indicator" Areas	35
	4. Effect of Space Suits	36
	5. Effects of pHiso-Hex [®] on Microflora	36
	6. "Indicator" Microorganisms	37
	7. Environmental Sampling	37
	8. Microbial Profile	37
	9. Effect of Diet on Fecal Flora	37
	a. Vitamin Production	38
	b. Ammonia Production	39
	c. Decarboxylation of Amino Acids	40
V	RECOMMENDATIONS	41
APPENDIX I	- Graphic Comparison Between Corynebacteria and Staphylococci in Related Body Areas	43
APPENDIX II	- Tabulation of Results	58
REFERENCES	373

LIST OF TABLES

<u>Table No.</u>		<u>Page</u>
1	Schedule of Samples from the Body Areas and the Environment	59
2	List of Primary Culture Media for each Body Area . .	64
3	Screen Test for Predominating Obligate and Facultative Anaerobic Fecal Bacteria	65
4	Personal Hygiene Protocol	73
5	Frequency of Area Sampling	74
6	Total Bacterial Plate Counts for Room Areas (Exposed 30 Minutes)	75
7	Total Bacterial Counts by Body Area for each Culturing Period	80
8	Aerobic Bacterial Count from Axilla and Groin	100
9	Occurrence of Streptococci	105
10	Recovery of Micrococcaceae	114
11	Occurrence of Neisseria	134
12	Occurrence of Enterobacteriaceae in Body Areas . .	138
13	Recovery of Enterobacteriaceae from Feces	140
14	Occurrence of <u>E. coli</u> in the Feces	145
15	Patterns for Unidentified Corynebacteria	146
16	Occurrence of Gram Positive Rods by Body Area . .	147
17	Occurrence of Gram Positive Rods by Sampling Period .	167
18	Incidence of Corynebacteria and Staphylococci in Selected Body Areas	187
19	Occurrence of Other Aerobes	207
20	Chromogenic Colony Recovery from Actino Plates . .	227

Contrails

LIST OF TABLES (continued)

<u>Table No.</u>		<u>Page</u>
21	Occurrence of Fungi	232
22	Recovery of PPLO	233
23	Dilutions from which Anaerobic Blood Plates Were Made .	236
24	Occurrence of Micrococcaceae	240
25	Microscopic Identification of Aerobic Dilution Series . .	242
26	Recovery of Micrococcaceae from Room Areas	244
27	Bacteriological Results of Environmental Monitoring . . .	249
28	Occurrence of Various Microorganisms on Axilla	252
29	Occurrence of Various Microorganisms on Anal Area	253
30	Occurrence of Various Microorganisms in Umbilicus	254
31	Occurrence of Various Microorganisms on Eye	255
32	Occurrence of Various Microorganisms on Scalp	256
33	Occurrence of Various Microorganisms on Ear	257
34	Occurrence of Various Microorganisms on Toes	258
35	Nutrient Composition of the Diet	259
36	Aerobic Microbial Profile of Subjects	260
37	Physiological Characteristics of the Predominating Fecal Anaerobes	281
38	Lipase Production by Anaerobic Type Cultures	283
39	B Vitamin Production or use by the Type Cultures	284
40	Optimal Temperature and pH Range for Growth of Eighteen Anaerobic Type Cultures	285
41	Physiological Characteristics of Type Cultures	286

Contrails

LIST OF TABLES (concluded)

<u>Table No.</u>		<u>Page</u>
42	Colony Counts - Aerobic Dilution Pour Plates from Feces	287
43	Growth Height by Tube Number	292
44	Occurrence of Strict vs Facultative Anaerobes in Feces .	297
45	Distribution of Fecal Anaerobes	302
46	Total Distribution of Fecal Anaerobes by Subject . . .	322
47	Total Distribution of Fecal Anaerobes by Sampling Period .	327
48	Total Distribution of Fecal Anaerobes by Experiment . .	332
49	Distribution of Eighteen Type Cultures in Three Separate Groups and Total Rank According to Total Occurrence .	333
50	B Vitamin Production or Use by the Type Cultures . . .	334
51	Amino Acid Decarboxylase Screening Tests	335
52	Effect of Predominating Fecal Anaerobes on Germfree Rats	336
53	Sensitivity of Eighteen Anaerobic Type Cultures to Various Antibiotics	337
54	Anaerobic Microbial Profile of Subjects	339
55	Morphological Types of Organisms Recovered from the Anaerobic Series	359
56	Distribution of Organisms on Slides of Anaerobic Throat, Mouth, Gingival Series	361
57	Microorganisms Commonly Found on Healthy Human Body Surfaces	366
58	Distribution of Microorganisms in Various Cutaneous Habitats	370
59	Distribution of Indigenous Microorganisms in Man . . .	371

LIST OF ILLUSTRATIONS

<u>Figure No.</u>		<u>Page</u>
1	Aerobic or Anaerobic Cultural Series for all Body Areas	12
2	Anaerobic Dilution Series (Feces)	14
3	Axilla - Experiment V (Averaged)	44
4	Groin - Experiment V (Averaged)	49
5	Glans Penis - Experiment VI (Averaged)	54

SECTION I INTRODUCTION

The microflora indigenous to the human or found in his environment plays an important role in his health and well-being. This relationship becomes even more important when the human is subjected to conditions associated with space flight and exploration, not only because these conditions bring the space traveler into close contact with the microflora in his environment, but also because certain space conditions may alter the balance of these microorganisms. Personal hygiene is one important means of controlling the population of microorganisms associated with man, and a thorough knowledge of the indigenous microflora, both of the human and of his environment, in the space capsule is of prime importance in establishing biomedical criteria for personal hygiene and sanitation during space travel.

Many areas of the indigenous flora of the healthy adult male are poorly defined, and the complex interaction between members of this flora and their position in the total economy of the man is poorly understood. In order to define the effects of space simulation on this flora, baseline data were considered essential. To obtain these data, 14 body areas of 20 men were cultured to determine their microbiological flora. The culturing technique was designed to recover the maximum numbers of differing organisms and to assess the temporary predominance of any particular group. Numbers were assigned to the relative frequency of varying groups of microorganisms in an effort to determine any gross change in the total predominants as a result of the conditions of the experiment. This numerical treatment of a biological system is not used as an attempt to quantify the microbial population, but as a guideline to indicate any shifts which may occur in any particular population of any body area at a particular sampling period.

A wide variety of culturing media was employed in an effort to isolate many microorganisms which could not be successfully cultured when a limited number of media were employed. Much of the work carried on by various researchers has dealt with the pathogenic or pseudopathogenic members of the flora, and less emphasis has been placed on the normally occurring nonpathogenic types.

Contrails

The indigenous microflora of the human body maintains elements of an orderly pattern that is not dictated by chance, but seems to depend on an interaction between the host and the microflora itself. Although there tends to be an indigenous flora common to the human body, this microflora varies from one area of the body to another and may also show minor shifts, depending upon the activity of the subject as well as upon the microorganisms present. A determination of the microflora in the environment of the space traveler will allow an evaluation of the extent to which the indigenous microorganisms of the human spread to his environment, particularly under conditions of space travel.

In this study of biomedical criteria for personal hygiene, it was difficult to assess the effects of any change in the indigenous flora because the experiments were of a limited duration and character. However, any buildup of microorganisms on the body which greatly exceeded a baseline numerical analysis will be noted and discussed.

Microorganisms are usually grown in noncontinuous culture media. Under these conditions bacterial viability, growth rate, and metabolic activity are rapidly altered by the accumulation of the metabolic end-products of the medium as well as changes in the nutrient content, redox potential and pH of the medium. This must be considered in any evaluation of in vitro results, since in the intestine proper, a continuous flow culture exists.

Fecal cultures reflect those organisms present in the stool, and it is essential to consider that viable bacterial populations in the stool are not necessarily completely representative of what is present in the intestine and that the enumeration and characterization of these organisms depend on observations based on their growth on artificial media. Since conditions within the intestine are recognizably different, it is entirely possible for species present in the intestine in small numbers to overgrow the predominant organisms unless proper culturing techniques of dilution with appropriate media are instituted promptly.

The changes in the fecal flora will be discussed; however, the interpretation of these changes will be suggested, rather than absolute, due to the limited time span of the experiment. This is essential since, for example, it will be very

Contrails

difficult to assess the change in vitamin production or utilization by varying members of the intestinal ecosystem. The effects of the interaction between the host and biota and the differing groups of this biota may not be obvious as it will be difficult to evaluate their positive or detrimental activity. In addition, many of these effects may be difficult to recognize since they have never been clearly defined. The relationship of the indigenous biota to the nutrition of the host under normal conditions is considered to be a prime physiological factor in the ability of the host to remain in nutrient balance. In addition, antibodies are formed by the host against certain of the minority members of the indigenous flora, but these antibodies are not strong enough to protect the host when large segments of the flora are changed by the administration of antibiotics. Many recent studies have indicated that a specific agent (which has not been isolated) is produced by some member of the normal flora and is essential in maintaining the equilibrium which is normally present⁽¹⁾. A radical shift in the proportions of carbohydrate to protein to fat will change the relative prevalence of the many members of the flora. This is an unfavorable physiological state for the host since many groups of organisms; i. e., enterococci and slow lactose fermentors of the Enterobacteriaceae group will rapidly become prevalent under the different dietary regimens.

The number of lactobacilli are increased by feeding large quantities of lactose. In addition, it is well documented that the feeding of diets high in meat protein, gluten, or casein results in a decrease in bacteroides or a concomitant increase in coliform organisms and enterococci. High butterfat content in the diet seems to inhibit the growth of E. coli and Proteus vulgaris⁽²⁾.

Many animal studies have shown that the microbiota drastically influenced the rate of growth, utilization of nutrients, and resistance to infection and stress⁽³⁾. Other recent animal studies have shown that some types of microflora seem to have undergone an evolutionary adaptation with their host and contributed to the effective functioning of his gut⁽⁴⁾. Other microorganisms seem to possess an ability to produce infection and hence elicit a protective response in the host which keeps them in check, unless the resistance of the host is lowered or the major predominant microflora are eliminated by antibiotics. In addition, a third segment of the flora is that acquired accidentally either by contact or through the diet.

Contrails

This segment of the flora can be either pathogenic or harmless, dependent upon the physiological state of the host at the time of contact. Those biochemical activities which have been defined, vitamin production or consumption, the ability to synthesize biologically active substances such as amino acids, bile, and the by-products of these microbial interactions are all important to the physiological status of the host.

An association between the presence of proteins in the gut, intestinal bacteria, elevated blood ammonia levels, and hepatic coma is now widely accepted, although the precise role of ammonia in hepatic coma is not defined. The importance of the colonic microorganisms in the pathogenesis of the portal system has been emphasized by recent advances in the modes of treatment of colonic infection⁽⁵⁾. The ammonia production is dependent not only on the numbers and kinds of organisms present, but also on the nature and quality of the nitrogenous substrate that reaches the bacteria in the lower intestine.

The current knowledge of enteric bacterial populations is being investigated to delineate the normal variation in the quantity or quality of this enteric flora. At the present time, the mechanism by which bacteria residing in the intestine impair proliferation is not clear, and their activity seems to be greater than the production of colicines or antibiotics would account for. It is necessary to consider the competition for nutrients in the gut, since changes in the nutrients offered to the "normal" flora result in a shift in the predominating flora. This may be the result of the competition for fermentable nutrients in a relatively reduced environment and is a result of microbial interaction.

Even less is known about the effect of those microorganisms indigenous to the skin of man. The study of these microorganisms has mainly been directed toward evaluating their presence in disease states, and little is known of the protective or destructive mechanisms of this flora. For this reason, primary emphasis has been placed on defining those groups of microorganisms indigenous to the outer layers of the skin in areas which may be influenced by the mode of personal hygiene employed. Changes in the relative predominance of these varied groups of microorganisms will be noted and interpreted, as will the effects of space suits, increased temperature, increased humidity, and the effect of confinement.

Contrails

This research program has been designed to obtain microbiological data pertaining to the following areas: scalp, ear, eye, nose, buccal or gingival area, throat, axilla, umbilicus, forearm, groin, glans penis, anal fold, and toes, as well as the feces. Each area must be considered separately, since there are conditions peculiar to each site which will influence both the kinds and numbers of bacteria occurring. In addition, there may be a certain interchange of microorganisms from one part of the body to another where their indigenous character may be questionable. Thus any one of the areas of the body may harbor not only their own peculiar indigenous flora, but also "transient" flora which is primarily considered to be characteristic of another area of the body.

The eye, ear, nose, and throat are located in rather close proximity, but each has a number of conditions peculiar to the individual areas which will influence the microflora. Two factors which influence the microbial flora of the eye are an antiseptic secretion from the tear duct as well as the mechanical action of the lids. In addition, the normal microflora of the eye produces antibiotics. The ear secretes a waxy material which offers peculiar nutrients favorable to certain bacteria such as members of mycobacteria and fungi. The nose presents certain special conditions in the form of nasal secretions and protective hairs which help to screen out prodigious numbers of microorganisms so that only a few of the up to 14,000 microorganisms that enter the nose each hour survive⁽⁶⁾. The biota of the throat has had more recognition than most other parts of the body, but this attention has been specialized according to the particular interest of the individual worker to the detriment of defining the overall biota. The throat has certain specialized areas, including the tonsillar crypts, which offer many locations for harboring microorganisms and which present the anaerobes with a very favorable condition for growth.

Although the skin covering the whole body has similar characteristics, several areas present their own peculiar conditions. For example, the axillary region contains many hair follicles and is also a region of maximum perspiration. The umbilicus also harbors a rich microflora because it is recessed and has folds and creases. The groin, because of the close apposition of skin areas, is particularly subject to a breakdown of the primary layer of skin and ensuing local inflammation and infection. Its locale is such that not only skin organisms but also those

Contrails

of fecal origin may be found. The anal fold is, of course, particularly subject to contamination from the fecal organisms, and the numerous fissures (which may be influenced by the amount of bulk in the diet) offer an excellent habitat for the microorganisms, including some of the obligate anaerobes which predominate in the feces. Other specialized areas which must be considered are the scalp and the toes. The numerous hair follicles on the scalp and the unique protection afforded by the hair seem to favor fungal growth as well as certain other types of bacteria. The moisture found between the toes offers ideal conditions for certain types of fungi. An important area to consider is the glans penis since the hygienic measures possible in spacecraft, of necessity, are limited. Communal sharing of sanitary facilities might easily lead to spread of infection. Among the skin areas considered here, all were essentially protected sites. It is important to consider an exposed area such as the forearm since environmental contamination could most easily be demonstrated in such an area.

The intestinal tract presents entirely different conditions for bacterial growth from any of the sites of the human body already discussed. The intestinal tract is essentially an anaerobic area in which fragments of undigested food and body secretions are accumulated. The microflora of the feces reflects these specialized conditions and is predominantly anaerobic.

The indigenous microflora of the environment surrounding the subject also will vary from site to site. Certain types of microorganisms will collect more frequently in areas where dirt and dust accumulate, whereas other microorganisms associated with the human body will tend to be found in the experimental areas of heaviest human occupation. Some types of microflora such as fungi thrive in damp situations, whereas many spore-forming microorganisms may survive in areas so dry or hot that nonspore formers would be largely eliminated. These probable differences in the microbial types were considered in the choice of the representative areas of the environment which were sampled.

"Normal" variations in microbial populations must be determined prior to any attempt to assess the importance of relative shifts in any segment of this population. During a normal day, changes in the activities of the subjects will influence the quantity of perspiration secreted, the pH of this fluid, and the temperature of

the body itself. The elapsed time between hygienic procedures and the actual taking of the sample is an important consideration in the interpretation of the results. The amount of activity associated with the daily schedule of the subjects will influence the numbers and kinds of microorganisms recovered in the environment. The relative humidity and temperature of the atmosphere in the space simulator are contributing factors to the microbial population of the environment as is any shift in the gaseous environment.

The experimental design required the establishment of a strict experimental protocol in order to define the bacterial and fungal flora. This included the isolation of the subjects from other individuals and from the environment external to the room. In addition, any break in the isolation procedure was monitored and necessitated the use of procedures normally associated with hospital operating room technique; e.g., the donning of sterile garments by the personnel involved.

Of prime importance to the successful culturing of the varied body areas and environment is the adequacy of the sample procured. Bacteriological sampling by subjects living under simulated space system conditions required close supervision to ensure that the samples were truly representative of the area and that they were handled according to established procedures including immediate culturing. Of equal importance is the adequacy of the culturing schema which was devised to consider both aerobic and anaerobic bacteria and included many differential media in order to obtain the maximum information within the framework of the cultural workload.

During certain periods of the experiments, subjects were confined to the Aerospace Medical Research Laboratories Life Support System Evaluator which is an 1100 cu. ft. man-rated chamber in which humidity, temperature, and partial pressure of gaseous constituents can be controlled. This facility is used to simulate various space mission profiles. The taking of samples by the subjects while in the Evaluator presented several significant problems. It was essential that the media (particularly the anaerobic) were transferred into the chamber immediately prior to the culturing period. The use of proper technique in swabbing and in adding the swab to the broth was important in the accuracy of the results. It was essential to instruct the subjects in the technique of swabbing in the various areas and in the addition of the swab to the culture tube.

Contrails

A review of the literature pertinent to all phases of this study has been completed and two texts are preeminent: Microorganisms Indigenous to Man by Theodor Rosebury⁽⁷⁾ and The Ecology of the Human Skin by Mary J. Marples⁽⁸⁾. Both of these authors have assembled tables dealing with the "normal" flora and based on the work of many authors. These tables are included in Appendix II in order that the results from this study may be compared with the "normal" flora shown in these tables. Comparisons will be made with other authors' studies in specific instances where additional information will strengthen this study.

Many studies have been conducted on people who were institutionalized for various reasons and the results may be a reflection of the health and well-being of the subjects. Our study was concerned with microbiological data obtained from healthy young men. In addition, the microflora of these same men was sampled a significant number of times during a six-week period of confinement. The data from the early sampling periods will be a reflection of the "normal" baseline flora of the subjects; and following entry into the Evaluator, will reflect the effects of confinement, stress, and space-type diets upon this flora.

SECTION II

MATERIALS AND METHODS

A. COLLECTION OF SAMPLES

The procedure for the collection of samples from the body areas, feces, environmental and miscellaneous areas are described for each class of samples.

1. Body Areas

Two swabs from each body area were collected by subjects in either the controlled activity facility or Evaluator at 8-10:00 a. m. on specified days (Table 1). One swab was placed in 10 ml of Gall's broth plus cysteine for anaerobic culturing and one was placed in 10 ml of heart infusion broth for aerobic culturing. Collection was made by swabbing a 1 by 1/2-inch area as follows:

- a. Eye: Evert lower eyelid and swab conjunctiva gently, following contour of eyelid with swab.
- b. Groin: Swab from front toward rear.
- c. Axilla: Swab with care to get specimen from skin below hair area.
- d. Throat: While depressing tongue, swab tonsillar area.
- e. Mouth Area: Swab gingival margin adjacent to the last upper right molar.
- f. Glans Penis: Swab specified area of skin of glans, or between glans and foreskin.
- g. Ear: While pushing earlobe down and toward neck, gently swab external auditory canal with a circular motion.
- h. Nose: While pushing the fleshy tip of the nose upwards, gently insert swab and rotate.
- i. Umbilicus: Gently expose deeper folds of umbilicus by pulling upwards on surrounding abdominal tissue in order to swab all areas.
- j. Anal Fold: Gently roll swab over area immediately adjacent to external anal sphincter.
- k. Toes: Swab area between toes.
- l. Scalp: Swab with a scraping motion within the area of hair growth.

- m. Tongue: Roll swab from left to right on posterior portion of tongue.
- n. Gingival (Experiment IX only): Dental instruments were employed to obtain samples from the appropriate areas.

For purposes of approximate quantitation each swab was considered to contain about 0.01 gm of sample.

2. Feces

Fecal samples were eliminated into plastic containers and were cultured within 15 minutes of elimination.

3. Environmental Areas

Aerobic cultures were made from several room areas, using two procedures:

- a. Sedimentation plates of blood, MacConkey's, actinomyces agar, and phytone yeast were made from the following room areas as indicated on Table 1 by exposing the plates for 30 minutes.
 - Tables, fore (eating) and aft (games, etc.)
 - Bed
 - Floor, personal hygiene area
- b. The following areas were swabbed. These swabs were placed in 10 ml broth and incubated aerobically.
 - Communications equipment
 - Refrigerator door handle
 - Bed post
 - Transfer lock handle

B. PRIMARY CULTURING

1. Primary Culturing of Body Areas (other than feces)

a. Aerobic

The aerobic swab collected by each subject for each body area was emulsified in the 10 ml of broth into which it had been placed when collected. Tenfold serial dilutions in 4 to 6 tubes of trypticase soy broth were made depending upon the numbers of organisms expected to be present in the sample based on

Contrails

previous experience. The exact procedure for culturing is shown in Figure 1. The trypticase soy broth series was incubated aerobically and observed for growth at 24 and 48 hours. All cultures showing growth were smeared. Aerobic plates were made on the media listed in Table 2 for each of the body areas by spreading 0.1 ml of broth from the most suitable dilution on the plate using a glass spreader. An additional blood agar plate was made in the same manner from the initial dilution. The aerobic count was obtained from a blood plate according to standard method techniques.

b. Anaerobic

The anaerobic swab from each body area (collected by each subject in either the Evaluator or controlled activity facility) was emulsified in 10 ml of broth. The sample was then serially diluted by tenfold dilutions depending upon the numbers of organisms expected to be found in that particular sample. The procedure, which is essentially the same as the aerobic method, is depicted in Figure 1. The cultures were then placed in an anaerobic jar, incubated at 37°C in an atmosphere of 10% CO₂, and observed after 24 and 48 hours for growth. Agar shakes in Gall's agar, as well as slides, were made from the top dilutions showing growth. The agar shakes were then transported from the site of primary culturing to Republic Aviation Division's laboratories where the cultures were identified. In addition to the serial dilutions, anaerobic Brewer plates were made with 1.0 ml of the appropriate dilution from the throat, mouth, and glans penis samples using Gall's agar with cysteine. In Experiment IX, two additional areas (the gingiva and anal fold) were added. A blood agar plate and, where indicated, a chocolate agar plate were inoculated with 0.1 ml from the second dilution tube and spread over the surface of the plate with a sterile, bent-glass rod. A pour plate of Rogosa's agar, when indicated by the body area, was inoculated with 1.0 ml from the third dilution tube. These plates were incubated in the 10% CO₂ anaerobic jar. Deep blood agar shakes were made only from the mouth and gingival samples by placing 1.0 ml of blood into a cooled Gall's agar shake and inoculating with 0.2 ml from the third dilution tube.

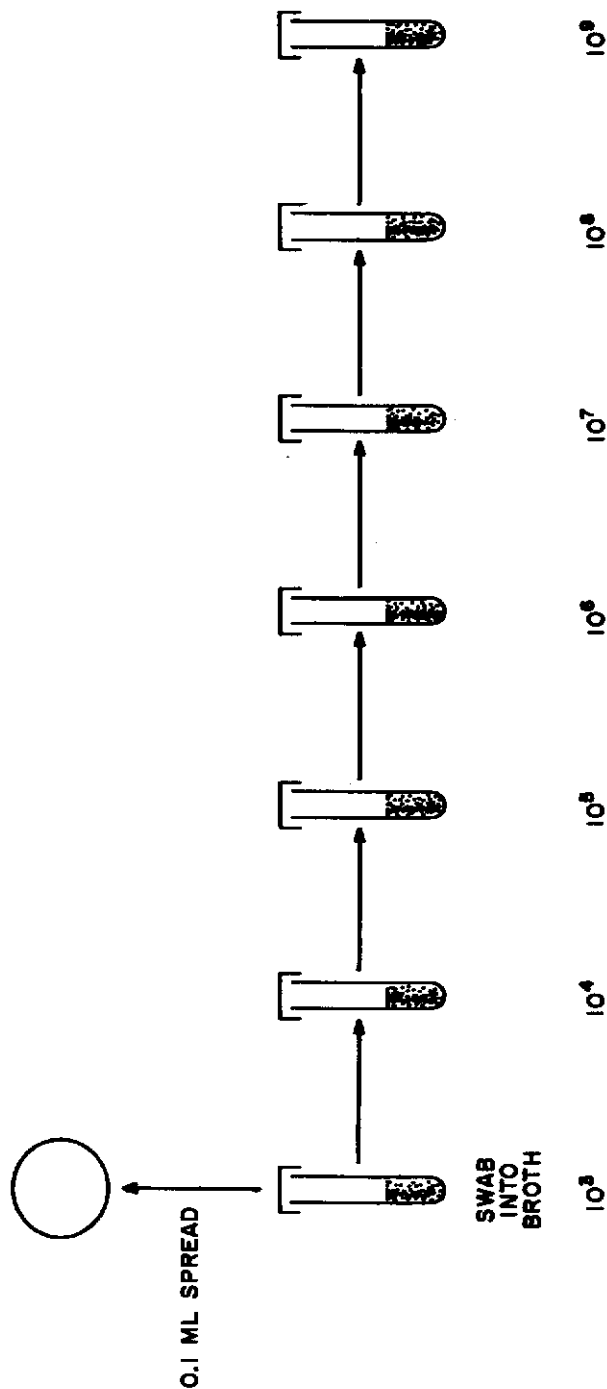

Platings are dependent upon prior counts and change during the run. The counts resulting from these varied dilutions are changed and recorded as would appear on 10^4 .

FIGURE 1. AEROBIC OR ANAEROBIC CULTURAL SERIES FOR ALL BODY AREAS

2. Primary Culturing of Feces

a. Aerobic

The aerobic plates from the fecal sample were taken from the anaerobic broth series. One-tenth ml from the third dilution tube was used as the inoculum for all aerobic plates, as well as the anaerobic blood plate. This was spread with a sterile bent glass rod upon the surface of the media. One-tenth ml from this dilution tube was also used as inoculum for a pour plate for the aerobic count. One ml from the third dilution tube was used as inoculum for the Rogosa's pour plate.

b. Anaerobic

The anaerobic broth series for the primary culture of the fecal sample was essentially the same as that used previously by Gall, et al⁽⁹⁾ for culturing rumen anaerobes, and which has been recently successfully adapted in the Republic laboratories to the culture of human feces⁽¹⁰⁾. This is a technique that can be adapted easily for work under field conditions. Figure 2 gives a schematic representation of the primary culturing technique, which is modified to culture from a standard loopful (0.01 gram) of freshly eliminated fecal material. Samples were cultured within 15 minutes of elimination.

The fecal material on the standard loop was placed directly into a tube containing 10 ml of Gall's broth prepared by addition of 0.1 ml of a cysteine sodium bicarbonate solution. This tube was considered to represent roughly a 10^{-3} dilution to the fecal contents. Serial dilutions were made into 11 additional tubes containing 9 ml of Gall's broth prepared as above by transferring 0.1 ml from the inoculated tube into the next tube, etc. The top 10 tubes were incubated anaerobically in an anaerobic jar containing a 10% CO_2 atmosphere until growth occurred. Observations for growth were made at 24 and 48 hours and at appropriate intervals thereafter. Growth usually appeared within 48 hours. These ten tubes were considered to approximate a dilution of the sample from 10^{-4} to 10^{-13} . No dilution blanks were used, as each tube containing broth acts as a dilution blank for the next tube in the series. From tubes 5 and 6 pour plates were made into anaerobic Brewer dishes using Gall's medium with cysteine bicarbonate solution added.

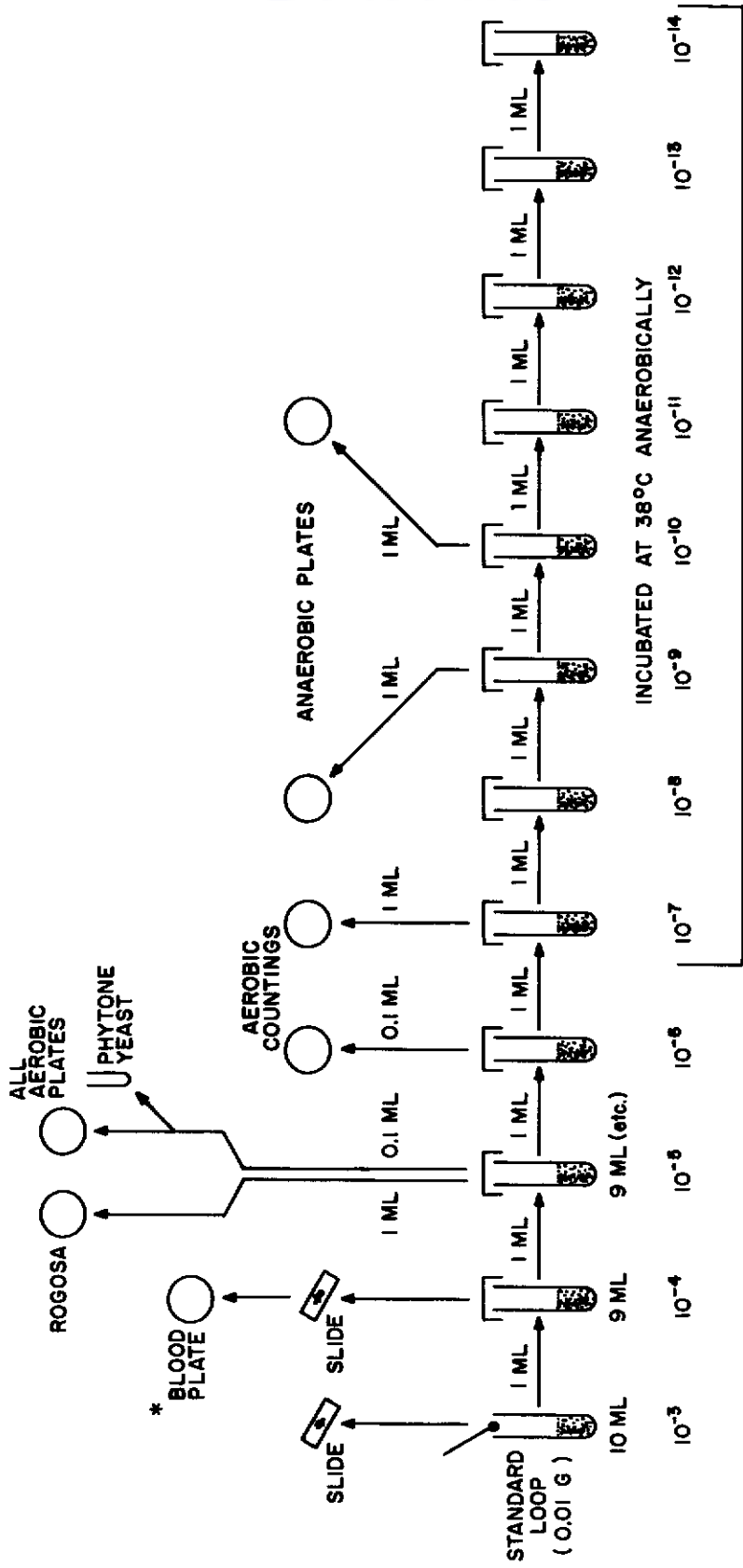

* For additional identifications

FIGURE 2. ANAEROBIC DILUTION SERIES (FECES)

Contrails

The top three tubes showing growth were subcultured into agar shakes using Gall's medium to observe the anaerobic or aerobic character of the microorganisms and to preserve the cultures for transport, purification, and further study. Each culture was stained by Hucker's modification of the Gram stain and the slide was observed microscopically.

In addition, blood plates were made from the 10^{-3} and 10^{-4} dilution of the fecal sample by the same technique as the aerobic plates from the other body areas and were incubated at 37°C in the same manner as the anaerobic broth series; i. e., in 10% CO_2 atmosphere in an anaerobic jar. Growth was recorded after 24 hours and the plates were treated in the same manner as the anaerobic blood plates described below.

3. Primary Culturing of Environmental Areas

The sedimentation plates made from the several room areas listed on p 10 were exposed for 30 minutes, incubated at 37°C , and observed for growth at the end of 24 hours. The swab cultures taken from the environmental areas were placed in broth and inoculated aerobically at 37°C . Smears were made of all broths that grew.

C. SECONDARY CULTURING

1. Aerobic

All the cultures from the Petri dishes incubated aerobically and under CO_2 from all body areas, feces, environmental areas and miscellaneous items were returned to the Republic Aviation Division's laboratories where selected colonies were picked into broth. Cultures picked from the anaerobically incubated plates were incubated in the CO_2 incubator while all other colonies from the anaerobic plates were processed by the usual aerobic methods. The cultures were smeared, stained, observed microscopically, separated according to morphological types, and processed according to the schema, if applicable.

Contrails

- a. **Staphylococci* and Micrococci**
 - Mannitol salt agar
 - All positives confirmed with coagulase test
 - Phage typing on selected cultures

- b. **Streptococci****
 - Alpha hemolysis
 - Beta hemolysis
 - Gamma hemolysis
 - Differential sugars
 - Typing
 - Temperature
 - Salt tolerance

- c. **Pneumococci**
 - Pneumococcus broth - bile solubility

- d. **Haemophilus**
 - Isolated strains identified with typing antisera

- e. **Neisseria**
 - Sugar screen test
 - Oxidase test

- f. **Lactobacillus**
 - Culture and morphology in Rogosa's medium
 - pH in glucose broth
 - Ecology

- g. **Gram Positive Rods**
 - Loeffler's
 - Morphology
 - Gelatin
 - Sugar screen
 - Hydrolysis of starch
 - Detection of hyphae (Actinomycetales)
 - Tellurite
 - Catalase
 - Hemolysis on sheep blood
 - CO₂ requirement
 - Litmus milk

* The identification of the staphylococci was carried out under separate contract by personnel from the Miami Valley Hospital Research Department, Dayton, Ohio. The results of the work are included in overall summary and tables.

** Work performed by A. West, Research Microbiologist, Aerospace Medical Research Laboratories, Wright-Patterson Air Force Base, Ohio.

- h. **Gram Negative Rods**
 - TSI
 - Indol
 - Methyl red
 - Voges-Proskauer
 - Simmon's citrate
 - Urease
 - Nitrate
 - Motility
 - Gelatin
 - KCN
 - Phenylalanine
 - Cytochrome oxidase (on all alkaline over alkaline TSI's)
 - Typing antisera (shigella, salmonella, E. coli, klebsiella)
- i. **PPLO**
 - Dienes' stained agar technique
- j. **Fungi**
 - Phytone yeast media
 - Wet mount
 - Lactophenol cotton blue
 - Corn meal agar
 - Fermentation series when indicated
- k. **Actinomycetales**
 - Actinomyces media
 - Morphology in culture, smears and wet mounts
 - Biochemical series
- l. **Spirochaetes**
 - Blood broth (morphology)
 - Darkfield when indicated
 - Vincent's stain
- m. **Protozoa**
 - Identification by selective stains

2. Anaerobic

a. **Body Areas Other Than Feces**

The agar shakes made from the dilution series and the colonies picked from the Brewer plate (when made) were separated into two groups depending upon the degree of anaerobiosis. The obligate anaerobes were processed in the same way as the fecal anaerobes described on p 18 with the exception that many of

the cultures, particularly from the mouth, gingiva, throat, and glans penis, were identified from Bergey's manual⁽¹¹⁾. The facultative anaerobes were grouped according to morphology and were processed as described in this section under C.1. A morphological and biochemical key was established consisting of the results of the screen tests from the most frequently occurring fecal anaerobic cultures and was designed to group similar bacteria. Each different screen test pattern was assigned an FA, FN, or GD number. The FA and GD types were used to designate obligate anaerobes and the FN types to designate facultative anaerobes (see Table 3).

b. Feces

The agar shakes from the top three tubes of the cultural series were processed in the following manner. The agar shake cultures were transferred to Gall's broth plus cysteine and incubated anaerobically until growth occurred. Gram stains were made and, if the cultures were pure, they were immediately screen tested as described below. Cultures showing two or more distinct morphological types of bacteria were purified by plating using the following anaerobic technique. A needle of the impure broth culture was spread on a bed of Gall's agar which was then covered with a layer of Gall's agar with added cysteine. The plates were incubated anaerobically in a Torbal jar with hydrogen and 10% CO₂ and discrete colonies were picked. Selected colonies on the anaerobic Brewer dishes originating from tubes 5 and 6 were picked and treated like the subcultures from the agar shakes as described above. The physiological studies of the pure cultures isolated from the feces included the following screen tests:

- (1) Gram stain to observe morphology
- (2) Final pH in 0.1% glucose broth
- (3) Fermentation of the following sugars in Gall's media with glucose omitted (glucose, sucrose, lactose, dextrin - sugars added at 0.1% level aseptically after autoclaving)
- (4) Growth in Gall's broth with no carbohydrate added
- (5) Liquefaction of 12% gelatin in Gall's medium minus carbohydrate
- (6) Growth and reaction in litmus milk (to which 0.05% bovine albumin and 0.1% of peptone have been added)
- (7) Growth in agar shake containing Gall's medium

Contrails

All media contained bicarbonate and all media except the agar shake contained cysteine to produce an Eh of about -200 mv. The results of the screen tests on each anaerobic culture were compared with a "key".

GALL'S MEDIUM

Purpose: Anaerobic culturing

Formula:

Peptone C (Albimi)	1%
Peptone S (Albimi)	1%
Beef Extract (Difco)	1%
Yeast Extract (Difco)	1%
K ₂ HPO ₄	0.1%
KH ₂ PO ₄	0.1%
Glucose	0.1%

Technique: Make up to 100 ml with distilled water and tube in 9 ml amounts (pipetted for exactness of dilution) and sterilize exactly 10 minutes by autoclaving. Immediately before use, add aseptically 1 drop of sterile 10% NaHCO₃ and 2 drops of 10% cysteine-bicarbonate solution*. This gives a pH of approximately 6.8 and an Eh of approximately -200 mv. Add 1.5% agar to the above when agar is needed for shakes and plates. This is done when originally making the medium. In agar omit cysteine except where noted otherwise. To all broth and agar media add 0.05% of bovine serum.

* 10% cysteine-bicarbonate solution. 20 gms Cysteine Hydrochloride, 100 ml 1N NaOH, 7% NaHCO₃. Add the cysteine hydrochloride to the NaOH, giving an approximate pH of 7.0. More or less NaOH will be needed depending on the particular batch of cysteine hydrochloride. To 4 ml of this solution (15% cysteine) in a test tube, add 2 ml of 7% NaHCO₃. Seal with melted vaspar. Autoclave at 15 lb. for 10 minutes.

Contrails

GALL'S GELATIN (i. e. 12%)

Purpose: The use of gelatin in culture media for studies of gelatinolysis (elaboration of gelatinolytic enzymes) by bacteria.

Formula:

Bacto tryptone	10 g
Bacto peptone	10 g
Bacto yeast extract	10 g
Bacto beef extract	10 g
Monobasic potassium phosphate	1 g
Dibasic potassium phosphate	1 g
Serum	1 cc
Gelatin	120 g

SECTION III

EXPERIMENTAL RESULTS

The design of the sample schedule was based on the requirements of the original study⁽¹²⁾. However, the five experiments differed in certain respects. Table 1* lists the test conditions of each particular experiment, as well as the dates on which various body areas were sampled and fecal specimens were obtained. The table also lists the dates of the environmental area samplings. Another variable in the experimental procedure was the wearing of space suits by four subjects. Suited subjects are shown on Table 1 for Exp. VII and VIII. The only experiment in which temperature was varied was Exp. IX, during which a temperature of 90°F was maintained for two of the six-week periods as shown in the table. The periods when liquid diets were offered to the subjects are shown on the table for Exp. VII and VIII.

The personal hygiene protocol enforced during all of the experiments is shown in Table 4. This table also indicates whether or not the subjects bathed, and whether they used soap or detergent. The oral hygiene enforced on each particular experiment is shown on this table, as is the type of clothing worn during each period.

The sampling of each body area was carried out by techniques which were described in Section II. The frequency of the sampling, which varied slightly between experiments, is shown in Table 5.

Each subject performed the required sampling in accordance with instructions. Immediately following the swabbing of the body areas, the swabs were placed in aerobic and anaerobic broth for transfer from the chamber for further processing. The processing of each swab followed a definite schema for plating. The primary culture media used for each body area are listed in Table 2.

* All tables appear in Appendix II

Contrails

Figures 1 and 2 depict the aerobic and anaerobic broth dilution series which are set up prior to the plating on primary isolation media.

The numerical counts shown in Table 6 are representative of bacterial colonies appearing on blood plates following 24 hours of incubation. These environmental plates had been exposed to the atmosphere for 30 minutes within either the controlled activity facility or the simulator, and probably represent a true picture of the numbers of bacteria present at any particular sampling period in that area. These counts, which seemed to be a reflection of the bacteria carried by the subjects, built up to a particular level and plateaued, as did the counts of the individuals. Prior to the entry of the subjects into either the controlled activity facility or the Evaluator, an attempt was made to reduce the residual count by the use of an antibacterial agent, BAC. This product was used as a spray and as an additive to scrub water. This method of treatment proved extremely successful, and the preentry counts ranged from 0 to less than 10 in every instance.

The variation in the number of organisms isolated from the skin of the same individual at different times (Table 7) was not as great as the literature indicated, particularly when the samples were taken in the same manner from subjects experiencing the same environmental conditions. Individual variation included the ability to support a larger and denser bacterial population. This cutaneous population was only temporarily affected by sweating or washing. The effect of any radical change in heat or moisture upon the cutaneous flora has not been thoroughly studied.

The analyses of the numerical data collected from the 20 subjects revealed that the buildup of the numbers of the bacteria present in the various cutaneous areas sampled reached a certain numerical level at about the tenth sampling period (approximately 3-4 weeks). The count remained at this level for the next two sampling periods and then underwent a small decrease in total numbers. This would seem to indicate that in any given area when the bacteria reached a certain level, the food supply could no longer support additional population.

The environmental effect on the skin of wearing the space suit was not as great as might be supposed. No significant difference in the numbers or kinds of

bacteria was noted on suited subjects. The assumption that the more constant temperature maintained on these skin surfaces, together with a higher relative humidity and a reduced air flow, should have been favorable to certain strains, was not substantiated by the appearance of higher bacterial counts.

The axilla and groin were two of the areas showing a marked buildup and, for this reason, are shown separately in Table 8 so that a comparison may be made between the two areas on the four subjects. These particular numbers also point up the individual variation existing between the subjects.

A further clarification of the numbers presented in Table 8 was attempted by separating the counts attributable to staphylococci and corynebacteria and plotting them against each other in order to depict graphically the relationship between these strains at the various sampling periods (Appendix I). Except for Exp. V, the corynebacteria built up to significant levels during all runs and were recovered to a greater extent than were staphylococci. No significant difference was noted during the imposition of 90°F temperature during Exp. IX or was any significant difference noted during the wearing of space suits by Subjects 26, 27, 29, and 31.

The results of these tests are not in agreement with most reports with respect to the numerical proportionate appearance of corynebacteria and staphylococci; however, the results do agree with those of Shehadeh and Kligman⁽¹³⁾.

Table 9 is presented to identify the streptococci recovered at the varying sampling periods. The prevalence of Streptococcus salivarius and Streptococcus mitis in the mouth and throat of the subjects was not unexpected; however, that significant number of strains of Streptococcus faecalis were recovered from the mouth and throat prove the indigenous character of Streptococcus faecalis in the upper alimentary tract. A sporadic occurrence of other strains was felt to be insignificant and not a reflection of their position as possible members of the indigenous microflora.

The staphylococci were studied by Miami Valley Hospital Research Department, Dayton, Ohio under separate contract with the Aerospace Medical Research Laboratories⁽¹⁴⁾. Table 10 is based on information received from the Miami Valley Hospital Research Department. The identification of coagulase activity was carried

out by a plate method rather than the conventional tube method. A significant number of coagulase positive strains was recovered from the individual subjects. These strains are considered important because of their potential pathogenicity. Subject 17 carried a positive strain in both the throat and groin. Subject 21 showed a coagulase positive strain occurring on the glans penis, in the ear and nose, as well as on the groin and axilla. Subject 24 had much the same pattern with the exception of the ear. In Subjects 25, 26, and 32 positive strains appeared on the axilla, groin, and glans penis. While Subjects 27 and 28 did not carry a significant number of positive cultures on the axilla, they carried coagulase positive strains of staphylococci on the groin and glans penis as did Subjects 29, 30, 31, 34, and 35. The other subjects showed sporadic isolation of coagulase positive strains.

Neisseria were prevalent at varying times during the five experiments (Table 11). In particular, during Exps. VIII and IX a heavy incidence of neisseria was found in the mouth and throat of Subjects 25 through 36. Sporadic occurrences of neisseria were noted on Subjects 17 through 24. It is possible that neisseria was transferred from subject to subject, but the data present no clear-cut picture.

The occurrence of Enterobacteriaceae from body areas (other than feces) shows the limited distribution of these bacteria (Table 12). Their occurrence in the axilla was sporadic and limited to a few subjects, but agrees with the literature, particularly in respect to the appearance of aerobacter. The occurrence in the eye is felt not to depict the indigenous flora, but to represent a chance contamination of the eye. The appearance of these bacteria on the glans penis and anal area reflect the current level of personal hygiene. The recovery of Enterobacteriaceae from the feces (Table 13) agreed with the data presented in the literature with the exception of isolation of Alkalescens dispar from the feces of Subjects 22 and 26.

The occurrence of E. coli in the feces and the identification of those strains which are typable are shown on Table 14. The high percentage of typable strains (roughly 50%) greatly exceeds the percentage reported in the literature. Various authors have estimated from 2.5% to 10% of the strains carried by the "normal" population are typable. In addition, a number of the typable strains found in this study are among those considered potentially pathogenic by various authors. It is possible that everyone carries these strains in relatively small numbers and

when the balance of the "normal" flora is disturbed by diet or disease, these minority strains can become prevalent and appear to be members of the pre-dominant flora.

In addition, odd patterns appeared. The biochemical reactions of one repeatedly isolated group of organisms fell between the shigella and E. coli reactions. This group of organisms has been referred to as Pattern S-C. The isolation of typable strains appeared to be greatest during Experiments VIII and IX and may be a reflection of the particular diet used during these two experiments.

One of the most interesting groups of organisms isolated repeatedly were members of the Corynebacteriaceae. Great difficulty was experienced in species identification of these varied groups. This is in accordance with the literature. For example, Pollack et al⁽¹⁵⁾ isolated 52 diphtheroid strains from the human skin, five of which were oleic acid requiring. These lipophilic diphtheroids have been identified as Corynebacterium xerosis by Pillsbury et al⁽¹⁶⁾. Marples et al⁽¹⁷⁾ also found diphtheroids in the interdigital skin of the foot in 38.2% of 175 adult subjects, and reached the conclusion that "Aerobic diphtheroids do not appear to produce any overt changes in the skin and must be regarded as normal residents of the substrate." When species identification of corynebacteria was impossible, biochemical patterns were used for grouping and are shown in Table 15.

The distribution of corynebacterium on the body areas showed marked variations among the subjects. Some subjects carried specific strains in each body area, while others had a sporadic occurrence of different strains in different body areas. More specifically, Subject 24 carried C. acnes in most body areas with only a sporadic isolation of C. pseudodiphtheriticum. Conversely, Subject 25 carried pattern A in the ear, C. striatum in the nose and glans penis, C. pseudodiphtheriticum in the mouth and throat, and pattern A in the groin and anal area. There was no consistency in the strain isolation. Subject 21 carried C. acnes frequently as well as C. pseudodiphtheriticum, but there was no indication of any prevalent strain in any of the sampled areas. Subject 22 carried C. acnes and C. pseudodiphtheriticum as did Subject 21 but, in addition, cultures of C. striatum, C. xerosis, as well as pattern A, were isolated sporadically. Subject 23 had much

Contrails

the same pattern as Subject 24, with C. acnes predominating. However, Subject 26 exhibited the pattern of strain specificity for body area. Pattern S+ was isolated consistently from the groin and glans penis and C. pseudodiphtheriticum was isolated from the mouth, pattern A from the ear, nose, and axilla, and an unidentified strain in the throat and nose. Subject 27 was also species specific and carried C. pseudodiphtheriticum in the nose and throat, pattern S+ in the axilla and glans penis, C. striatum from the groin, and pattern A consistently in the eye and occasionally in the axilla and groin. Subject 28 carried pattern S+ in the throat and glans penis, C. pseudodiphtheriticum in the mouth, and pattern A in the axilla. For Subject 29, the isolation was again sporadic. Subject 32 carried pattern S+ (as described in Table 15) and C. pseudodiphtheriticum in the nose. Subject 30 carried pattern S+ in the axilla, groin, and glans penis. Subject 31 carried pattern S+ in the groin and glans penis with many seemingly random isolations of other species. Subjects 17 and 18 carried C. striatum in the groin. Subject 34 had both pattern A and S+ in the nose and C. striatum and pattern A in the axilla, groin, and glans penis. Subject 35 had C. striatum in the groin and anal area, while Subject 36 had C. striatum and S+ pattern in the anal area, as well as in the axilla and groin.

The analysis of the appearance of the strains of corynebacteria by subject was complicated and seemed to represent individual variation, rather than being a result of the experimental conditions. Analysis of the Corynebacteria species by body area rather than by subject was also carried out. Only 8 of the 20 subjects carried corynebacteria in the feces, and the two species C. striatum and C. acnes accounted for these isolations. In the groin, a more diversified distribution occurred, as indicated by the recovery of the following members of corynebacteria: C. striatum, C. xerosis, C. pseudodiphtheriticum, C. acnes, and pattern A, as well as striatum S+. There did not appear to be any conformity in either this particular body area or the axilla as far as species specificity, although pattern A, C. striatum and its associated pattern S+ accounted for most of the isolations in the axilla. The data indicate that there is a correlation between the presence of C. striatum and pattern A. On the glans penis, the strain specificity per man was more marked, with S+ being most frequently isolated followed by C. striatum. Pattern A occurred in significant number in two individuals. The

Contrails

consistent absence of any strain of corynebacteria in the anal area in 15 subjects is significant. Experimental conditions seemed to affect only the total numbers of corynebacteria. The distribution of these varied strains is shown in Table 16 by body area, Table 17 by sampling period, and in Table 18 by specialized body areas. Figures 3, 4 and 5 show the graphic distribution of corynebacteria plotted against the occurrences of staphylococci (Appendix I).

The distribution of Lactobacillus species is also shown in Table 16. Lactobacilli were consistently recovered from the throat and feces in Subjects 17, 18, 19, 20, 21, and 27. The recovery in the other subjects was sporadic and notable by its lack of consistency. In addition, lactobacillus was isolated from the nose, ear, and (surprisingly) on the glans penis in Subjects 22, 23, and 24.

The recovery of miscellaneous aerobes which are considered to be indigenous, but not predominant, is documented in Table 19. Of interest, is the recovery of haemophilus in the feces of Subject 24 on four occasions. Bacteria of the Moraxella-Mima group were recovered sporadically from a few subjects and at a much lower incidence than anticipated.

During Experiment V, a significant number of colonies appeared on various media and the identification of these isolates was difficult. For this reason, actino medium was added to the list of culturing media on subsequent runs. The bacteria isolated from this medium are listed in Table 20. Many of the isolates seemed to be members of the proactinomyces or nocardia groups, and the classification developed by Krassilnikov⁽¹⁸⁾ was used as a basis for tentative identification. The principal isolates from the skin are probably Proactinomyces goensis and Proactinomyces spitzii, while Proactinomyces interproximales was recovered from the mucous membranes. Miscellaneous isolates fall under the grouping of Proactinomyces albus. A detailed study of these cultures was not within the scope of this effort. The heavy incidence of these cultures in the earlier sampling periods may have been related to the removal of all bacteria from the environment by the use of a BAC spray. The "normal" bacterial balance between the subjects and their closed environment could be considered tenuous, and any factor which contributed to the elimination of large numbers of normally occurring microorganisms may well have allowed the sudden influx of other bacteria whose influence and effects are not well defined.

Contrails

Fungi were isolated by using a specialized medium (phytone yeast agar). The cultures were incubated both at room temperature and at 37°C. The number of diverse cultures was so great that it was considered necessary to differentiate between the pathogenic and the nonpathogenic species, particularly in the genus Candida. Candida albicans was recovered from more than 50% of the subjects and occurred most often in the mouth, throat, and feces. This incidence of recovery is sufficiently greater than that reported in the literature to indicate that it represents a true finding and one which requires interpretation in view of the limited oral hygiene and the particular space diet employed. Two other species of Candida (C. parapsilosis and C. guilliermondi) were recovered frequently. Subject 36 carried Candida albicans on the glans penis on seven occasions. The incidence of Trichophyton rubrum and Rhodotorula sp. is in agreement with that found in the literature. Many species of Aspergillus are widespread in the environment and are considered to be laboratory contaminants. Their pathogenicity for human beings has not been defined; however, the frequency of isolation of Aspergillus species from the subjects on Experiment IX would indicate that these men were carriers of Aspergillus in the nose for a short period of time. Subjects 23, 26, and 27 had numerous isolations of Trichosporum species from the groin and glans penis. Sporadic and frequent isolations of the Penicillium species occurred but no particular significance is attached to these cultures. Among the miscellaneous fungi appearing are: Cladosporium sp., Helminthosporium sp., Scopulariopsis sp., Syncephalastrum sp., mycelia sterila, as well as Phoma sp. and Trichophyton mentagrophytes. Two of the subjects (numbers 27 and 36) carried a much greater number and variety of mycological flora than did the other eighteen subjects. One of these subjects was a negro, the other, a highly nervous individual who perspired profusely. The pH of the skin of these men was not determined, but it could have been a contributory factor to the presence of the various fungi as could the amount of sweat, since the perspiration could be expected to provide a greater source of nutrients for fungi and bacteria than the skin of a subject whose sweat production was minimal (Table 21).

The isolation of pleuropneumonia-like organisms (PPLO) from many body areas of all the subjects at repeated intervals is documented in Table 22. The current opinion of many researchers is that many strains of PPLO are saprophytic

Contrails

and their isolation should not be considered significant. The PPLO may be "opportunists" and invade in combination with disease-producing bacteria. Their pathogenic position in nongonococcal urethritis is well documented. For this reason, their frequent isolation from the glans penis was felt to have possible significance and additional emphasis should be placed on studying their occurrence in this area, and its possible significance, as well as on the further identification of the specific strain of PPLO present.

Table 23 lists the dilutions from which the anaerobic blood plates were taken and illustrates the varied tailoring of the sample procedure used to obtain the most meaningful results. It was necessary to modify the procedure for each sample, as in a too heavily inoculated blood plate, the cultures overgrew, and identification of the varied flora became impossible.

During Experiment V, cocci (isolated from the blood plates) belonging to the micrococcae rather than the staphylococci group of micrococcaceae were studied in detail and identification of selected strains from the nose, axilla, groin, and anal area were made. In subsequent experiments, these cultures were disregarded, since they were studied under separate contract by members of the Miami Valley Hospital Research Department (Table 24).

The microscopic identification based on slide observation of the aerobic dilution series is shown in Table 25 and merely confirms the identifications obtained in the conventional manner.

The recovery of micrococcaceae from room areas is shown in Table 26 and is based on information received from the Miami Hospital Research Department and indicates that a substantial number of the colonies recovered consisted of strains showing positive coagulase activity. Since phage typing of these cultures is not available, it is impossible to say whether they show the spread of potentially pathogenic staphylococci between men and their environment.

The environmental sampling based on exposure plates (Table 27) was remarkable by the recovery of a relatively few strains which were potentially pathogenic. Most of these strains occurred on the floor in the vicinity of the personal hygiene area and were a result of the standards of hygiene enforced, or the personal habits of the subjects.

Tables 28 through 34 show the occurrence of the various microorganisms in particular body areas and allow meaningful comparisons to be made with those reported in the literature. Of particular interest are the tables showing the occurrence of various microorganisms on the anal area and axilla, as well as the toes. The consistent recovery of both staphylococci and corynebacterium re-emphasizes their position as the predominant organisms in most body areas. The occurrence of fungi in these areas is higher than the literature indicates, but in most instances caused no serious problems.

Table 35 illustrates the nutrient composition of the diets offered the subjects which differed between experiments. The diets for Experiments V and VI have approximately the same number of total calories and protein. The Experiment V diet had slightly more fat than was found in the diet used on Experiment VI. The fresh and liquid diets used in Experiments VII and VIII were very closely matched and it is felt that the most significant difference between the two was in the lower calcium load imposed by the diet used in Experiment VIII. Experiment IX had a significantly higher proportion of total calories in the form of carbohydrates than did the other four experiments. While the protein in Experiment IX was lower than Experiments V and VI, it was substantially higher than Experiments VII and VIII.

Because of the importance of the "indigenous microbiota", microbial profiles of all 20 subjects showing each body area sampled at each sampling period are shown in Table 36. This table documents the recovery (by culture procedure) of all aerobic organisms. In addition, individual variations in the flora of any particular body area can easily be identified, and possible transference can be studied. The microbial profile of each subject must be considered as an entity, since the interrelationship of the microbial populations of body areas is important.

The composition and role of the anaerobic fecal flora in the body of the young healthy adult male has never been completely delineated. For this reason, the predominating anaerobic flora has been grouped and identified by the schema of Gall et al (NASw-738)⁽¹⁹⁾. This artificial schema is based upon certain morphological and physiological characteristics. Table 3 shows the biochemical reactions and morphology of these cultures. This table includes the obligate

Contrails

anaerobes FA-1 through 18; the G. D. series 1 through 7, which are also obligate anaerobes; as well as the FN series 1 through 5, which are facultative anaerobes, as are CN-1 and 2. In addition, the PS-1, 2, and 3 facultative anaerobic cocci are also included. This method of grouping has been used in order to compare the results obtained under the simulated space conditions of this experiment with the baseline "normal" established under the investigations carried out for NASA by the Republic Aviation Division of Fairchild Hiller Corporation⁽¹⁹⁾. In addition, comparisons were made with two other studies; one carried out for the Aerospace Medical Research Laboratories⁽²⁰⁾, the other a NASA-sponsored study which was carried out at the Air Crew Equipment Laboratory (Philadelphia)⁽²¹⁾. To understand the physiological characteristics of these anaerobic cultures, Table 37, which is reproduced from the NASA study, shows a summary of the physiological characteristics. Additional information on the activities of these cultures is shown on Tables 38, 39, and 40. Table 41 shows an artificial grouping of these anaerobes by activity including lactic acid production, ammonia conversion, decarboxylation, and deaminating activity. This background material is discussed in detail in Section IV under the interpretation of the shift in the predominating types of anaerobic bacteria.

The obligate anaerobic character of the feces was prevalent throughout all experiments. The anaerobes outnumbered the aerobes by 10,000 times on an average. This is substantiated by the enumeration of the aerobic organisms made from the aerobic plate counts which are shown in Table 42. In contrast to these aerobic organisms, which occur in millions per gram, the anaerobic organisms were present in billions per gram. The height of the anaerobic growth in the broth series is shown in Table 43. These data show that the numbers of anaerobic organisms present in the feces seldom fall below the one hundred billionth dilution of the sample and often exceeded it.

The comparative data reaffirms the predominance of the anaerobic bacteria in the fecal flora. To show more clearly the degree of anaerobiosis present in the predominating fecal organisms, the facultative anaerobes are listed separately from the obligate anaerobes. This information is presented in Table 44 which shows the numbers of obligate anaerobes versus facultative anaerobes isolated in the top three dilutions of the anaerobic series of each man for each culturing period.

Subjects 27 and 31 carried the highest percentage of facultative organisms and represent individual variations within the group.

The distribution of the types of anaerobes found in fecal samples of the 20 subjects is shown in Table 45. The information in this table allows a comparison between runs. The information in Table 46 allows a comparison to be made between individuals on the same run. Table 47 shows the total distribution of anaerobes by sampling period. Table 48 allows the data obtained from each run to be compared. The results obtained on the "Normal Predominating Fecal Flora" (NASw-738⁽¹⁹⁾) are shown in Table 49.

The recovery of the fecal anaerobes of the varying FA types from each experiment is depicted in Table 48. Experiments VII and VIII should have produced the same type of reaction since the diets were so closely correlated. However, significant differences occurred in the number of FA-5's present and the numbers of FA-9, 10, 12, 15, and 18, as well as G.D. 3 and 6. In Experiments V and VI, the differences seem to lie in the appearance of FA-6, 7, 9, and 18. Experiment IX, in which the diet did not closely approximate any of the others, gave results fairly consistent with Experiment VII with the exception of the prevalence of FA-12 and the scarcity of FA-15 and 18, while G.D. 1 and 5 increased markedly.

Vitamin production or utilization by the type cultures is one of their significant contributions to the ecology of the gut flora, and although the relationship between the host and the bacterial source of the vitamins has not been clarified, the vitamin production by the predominating anaerobes is summarized in Table 50.

Another defined area of anaerobic bacteria physiology is the amino acid decarboxylation performed by these predominating anaerobes. This information is summarized in Table 51.

Work was performed on germfree rats to evaluate the function of the predominating anaerobes in the body and these data are summarized in Table 52. A further study directed toward the control of these anaerobes is based on the sensitivity to various antibiotics. The results of this study are shown in Table 53.

Contrails

In addition to the predominating position of anaerobes in the feces, many anaerobes were recovered from a substantial number of body areas. These are listed both by subject, body area, and sampling period in Table 54.

Table 55 shows morphological types of organisms which were present in the anaerobic series. The numerous strains of bacteria which would not transfer to secondary media are identified by morphological types as shown in Table 56.

SECTION IV

CONCLUSIONS

A. BACKGROUND/INTERPRETATION

Interpretation of every detail of the data obtained from samples involving over 50,000 primary cultures and almost 1,000,000 secondary cultures would be a monumental task. For this reason, the conclusions presented herein are based on changes which occurred in a large number of samples or were of sufficient magnitude to be considered significant.

1. Bacterial Buildup on Man

In the analyses of the numerical data collected from the 20 subjects, a general conclusion was reached that the buildup of the numbers of the bacteria present in the various cutaneous areas sampled reached a certain numerical level at about the tenth sampling period; i. e., after approximately 23 days of confinement. This condition lasted for the next two sampling periods, ultimately undergoing a small relative decrease of total numbers. This would seem to indicate that in any given area, when the bacteria reach a certain level, the food supply can no longer support an additional population. The bacterial levels reached did not generally cause any visible dermatological problems.

2. Unnecessary Sampling Areas

The numerical data, which reflected the buildup of bacterial colonies at or on specific body areas, were important in determining the merit of sampling certain body areas. Careful consideration of both the numbers and kinds of bacteria present in or on the scalp, ear, eye, nose, throat, axilla, umbilicus, forearm, and anal area would seem to indicate that those areas can be sampled less frequently or eliminated from the monitoring schedule in future work.

3. "Indicator" Areas

These same numerical data cited above indicate the importance of monitoring the level of cleanliness of the glans penis and the groin by bacterial

sampling. The relationship between gingival health and gingival flora, currently being studied by the Republic Aviation Division of Fairchild Hiller Corporation in conjunction with Aerospace Medical Research Laboratories⁽²²⁾, may show this area to be a third indicator area.

4. Effect of Space Suits

The effect upon the skin of wearing the space suit was not as great as had been supposed. No real difference in numbers or kinds of bacteria were noted on suited subjects. The assumption that the suit conditions of constant temperature, higher relative humidity, and reduced air flow would be favorable to certain strains of bacteria, was not substantiated by higher bacterial counts.

The two body areas which became uncomfortable for some of the suited subjects were the groin and feet. When the subject had a history of athlete's foot, the wearing of a space suit contributed to an exacerbation of the old infection, usually resulting in T. rubrum causing discomfort. Itching that developed in the groin area was attributed to T. rubrum and members of the Candida species. In suited subjects, monitoring of the microbiological status of the toes could be an essential prophylactic measure.

5. Effects of pHiso-Hex[®] on Microflora

The information graphically portrayed in Figures 3, 4, and 5 (Appendix I) suggests that a preentry scrub with pHiso-Hex[®] as performed in Experiments VI and VII, allowed a relatively greater differential to exist between colonies of staphylococci and corynebacterium than was apparent in Experiments V and VIII, where Ivory[®] soap was used. The antibacterial action of pHiso-Hex[®], particularly against members of the Corynebacteria species, is apparent from these graphs. All the graphs have three peak periods depicting growth levels for corynebacterium and for staphylococcus. With the exception of Experiment V, all other experiments reflect a higher postlevel count than entry count. These graphs reaffirm the necessity for monitoring bacterial levels on the glans penis and groin.

6. "Indicator" Microorganisms

Members of Enterobacteriaceae which appeared on the glans penis and groin indicated a deterioration of hygienic standards.

The presence of various fungi on the feet, groin, and glans penis could indicate necessity for instituting certain hygienic procedures.

7. Environmental Sampling

Sampling of the bacterial levels in the personal hygiene area and on the eating table should be part of the program, since the bacterial levels in these two areas were considered to have risen to dangerous levels.

8. Microbial Profile

The microbial profile of these 20 subjects is shown in Table 35. The summary results of Rosebury⁽⁷⁾ are shown in Table 57, Marples⁽⁸⁾ in Table 58 and Burnett⁽²³⁾ in Table 59. A comparison of these was made and revealed interesting differences between the results of the present study and those of earlier investigators. In comparing Rosebury's work (Table 57), the greatest difference appeared to be that he recovered Pityrosporum ovale and mycobacterium from the skin although these organisms were not isolated in the present study. In all other respects, the two studies were in agreement. Marples⁽⁸⁾ listed among the residents of the skin, Pityrosporum ovale and Mycobacterium smegmatis. These two strains were not recovered from the 20 subjects of the present study. In addition, gram negative bacilli and Staphylococcus aureus were considered by Marples to be frequent visitors, but the results of the present study indicate that their occurrence was frequent enough to give them indigenous status, as was the occurrence of C. albicans, neisseria, gaffyka, sarcina, and certain species of streptococci.

Distribution of the indigenous microorganisms in man as presented by Burnett⁽²³⁾ (Table 59) most closely approaches the microbial profiles of this study.

9. Effect of Diet on Fecal Flora

One of the objectives of this experiment was to determine whether a space type diet (fresh or dehydrated) affected the fecal flora of the young adult males who subsisted solely on this type of diet for a 6-week period.

Since the dietary periods delineated in the five runs under consideration are relatively short in term, it is impossible to base conclusions on a cause-effect relationship involving physical symptomology. For this reason, the types of anaerobic bacteria predominating during each experimental period were compared with those predominants isolated in the study performed for NASA⁽¹⁹⁾. This comparison considered the in vitro vitamin production, deamination, and decarboxylation activity of these cultures as well as their lactic acid production. Although the relationship between the host and these strict anaerobes is not completely defined, their possible role in the body was considered to be a reflection of their metabolic activities.

a. Vitamin Production

One of the characteristics of the predominating fecal anaerobes is their ability to synthesize vitamins. The relationship between this ability and the host has not been clearly defined, although as pointed out by Bell et al⁽²⁴⁾, "Vitamin K is also synthesized by the intestinal flora, in some patients deficiency may be precipitated by the use of antibacterial agents." In addition, the same authors reported: "It is likely that bacterial synthesis of vitamins especially those of the B complex, in the lower alimentary tract is responsible for supplying a substantial proportion of the daily requirements of riboflavin, nicotinic acid, biotin, folic acid, and vitamin K." Additional importance is given to the acceptance of the intestinal bacteria as vitamin sources by Morris⁽²⁵⁾. "Many bacteria synthesize vitamins in excess of their requirements and excrete the surplus into the environment. Indeed the excretion of B vitamins by intestinal microorganisms, coupled with autolytic liberation of vitamins from dead cells may furnish such a large fraction of an animal's vitamin supply that it is difficult to render the animal deficient by mere dietary deprivation."

It is significant that the change in the predominating anaerobic bacteria has, in some cases, seemingly resulted in a flora which will produce a smaller amount of the vitamins (Table 50). In particular, the amount of B₁₂ seemed to be significantly decreased in Experiment VII, as did the riboflavin in Experiments V, VII, VIII, and IX. The niacin was significantly lower in Experiments V, VII, VIII, and IX, while pantothenic acid production was diminished in

Experiments V, VII, and VIII. Folic acid was markedly lower in Experiments V, VII, VIII, and IX. The vitamin production of FA-17, FA-18, and the GD series has never been determined, and it is possible that when they are predominant, they at least partially fulfilled the function of the FA number they replaced.

In view of the reduction in intestinal vitamin synthesis during the 6-week period attributable to the space-type diets (Table 35), it is considered essential to focus greater attention on the maintenance of the normal flora for any long-term space mission.

b. Ammonia Production

In any consideration of intestinal bacterial metabolisms, importance should be attached to the production of ammonia by bacterial degradation in the colon. This ammonia production depends not only on the kinds of organisms present in the gut, but also the nature of the substrate that reaches the lower intestine⁽²⁶⁾. At least 25% of the circulating urea is metabolized in the gastrointestinal tract⁽²⁷⁾.

Deamination, which is the result of bacterial action on the substrate, occurs in the intestinal mucosa and is a recognized function of bacterial physiology⁽²⁴⁾.

In fact, Silen et al⁽²⁸⁾ showed that the large intestine is the source of a considerable quantity of ammonia and that the amount of ammonia normally delivered from the intestine to the blood may be reduced by oral administration of neomycin.

A comparison of the ability of the predominating flora in each experiment to form NH_3 would indicate that the predominating flora in Experiment V had a much lower percentage ability to convert substrate to ammonia, as did those predominates on Experiment VII, however, two of the predominates of this experiment have not been studied for NH_3 conversion. This diminution of the ability of the predominating flora to convert the substrate to ammonia could lead to serious consequences on long-term space missions.

c. Decarboxylation of Amino Acids

Enzymatic decarboxylation of amino acids may have significant effects on the human colon ecology, since the decarboxylation product of amino acids may include toxic amines. In addition, potent vasoconstricting compounds may be formed as byproducts of bacterial metabolism. The four amino acids which commonly occur in humans and were used in screening the FA cultures were lysine, histidine, tyrosine, and arginine; their corresponding amines are cadaverine, histamine, tyramine, and agmatine, all of which are vasoconstrictors.

The delicate balance of the concentration of these naturally occurring physiologically active substances (decarboxylators) in the digestive tract may be upset by dietary restriction, resulting in the failure of bacteria to remove toxic amines from the intestine. This is of particular importance in the administration of certain drugs which inhibit the action of intestinal enzymes that inactivate otherwise toxic amines. These drugs include Niamid[®], Morphan[®], Entonyl[®], Parnote[®], and Nardil[®]. Alone, these drugs may be beneficial, but in association with foods high in amines, or in individuals whose intestinal flora is not functioning properly, they may cause serious medical consequences⁽²⁶⁾.

SECTION V

RECOMMENDATIONS

The study pointed out several areas requiring further investigation and areas which merited more specialized research. For example, until the present study, no particular significance had been attributed to the role of the predominating fecal anaerobes in the maintenance of a favorable vitamin balance. Based upon this study, the following major recommendations are made.

1. A complete microbiological screening of potential subjects should be instituted prior to confinement. This screening should include: (a) determination of coagulase positive staphylococci strains from all body areas; (b) determination of possible presence of beta hemolytic streptococci; (c) determination of possible presence of fungi, particularly in the foot or groin area; and (d) the feces should be cultured at least twice to determine the presence of potentially pathogenic members of the Enterobacteriaceae. This screening would serve to ensure the health of the subject by eliminating any carriers of potentially pathogenic organisms prior to the study.
2. Study the effect of various antibacterial agents such as BAC, pHiso-Hex[®], Safeguard[®] soap, on the skin flora of man. Do this by treating one portion of the groin with the agent, and using only water or relatively pure soap on the other portion of the groin. Ivory[®] soap was used during the baseline studies, however, any other comparable soap (i. e., nonperfumed and non-medicated) would be acceptable. Follow both areas microbiologically. This should be done in order to determine whether any particular agent was more desirable than the others tested.
3. Try certain hygienic procedures (i. e., showers two times a day allowing foam to dry on body) for one week prior to entry into the simulator to see if this regimen substantially lowers total counts and for this reason proves advantageous.

Contrails

4. Compare information recovered from a one-plate identification to that recovered from the use of varied media and if one plate could be used rather than four plates, the culturing would be streamlined.
5. Determine the vitamin B production, the deaminating and decarboxylating activities of FA-17, FA-18, and the GD series in order to evaluate their function as members of the predominating anaerobic fecal population (which seems to result from the space type diet). If certain types of diets cause a substantial lowering of production of the B vitamin by bacteria, fortification of the diet may be necessary. If the total deaminating and decarboxylating activities of the predominates are radically changed, animal work should be performed to more fully evaluate the effects of this shift in flora.
6. The identification of bacteria at the present time is a relatively long process usually requiring the services of expert personnel. To monitor critical body areas and environmental sites in space missions, a methodology must be developed which will allow identification of the original culture by personnel not highly trained in microbiology.
7. The predominating organisms found on the dermis are members of the corynebacteria. The identification of many strains has been impossible and additional research should support both their identification and the study of strain characteristics in order to evaluate the presence of various strains on or in particular body areas. It may develop that certain strains have antibacterial properties against transient microorganisms; if this is true no hygienic procedure should be used that will curtail the growth level of these normal inhabitants.
8. Determine in vitro antagonistic properties of predominating anaerobes against potentially pathogenic members of Enterobacteriaceae. In the delicately balanced fecal flora, certain pathogens seem to be held in check by undetermined factors produced by other bacteria. Since the anaerobes are present in the most significant numbers, it is logical to determine their in vitro antagonistic properties.

APPENDIX I

GRAPHIC COMPARISON BETWEEN CORYNEBACTERIA AND STAPHYLOCOCCI



Contrails

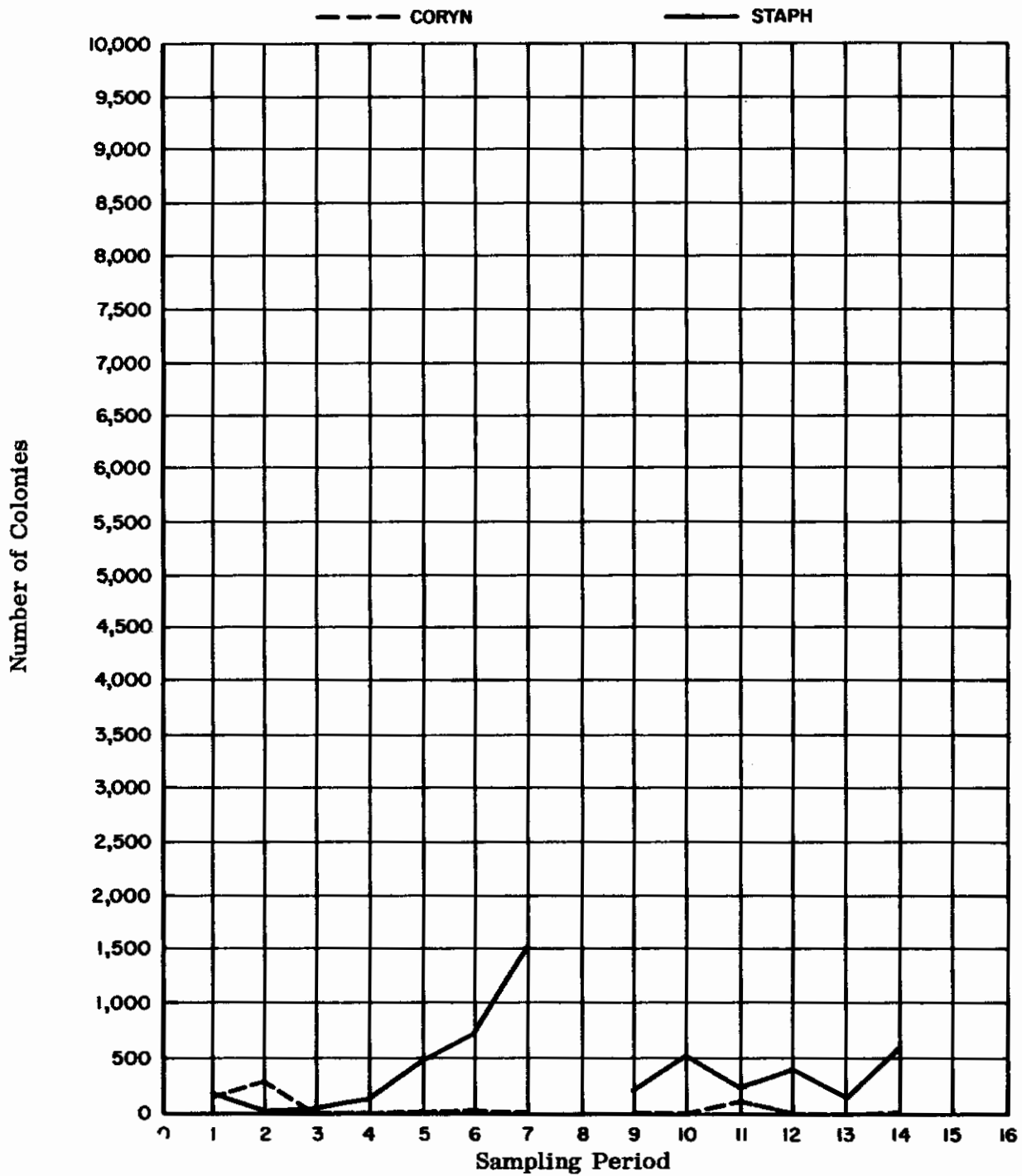

FIGURE 3. AXILLA - EXPERIMENT V (Averaged)

Contrails

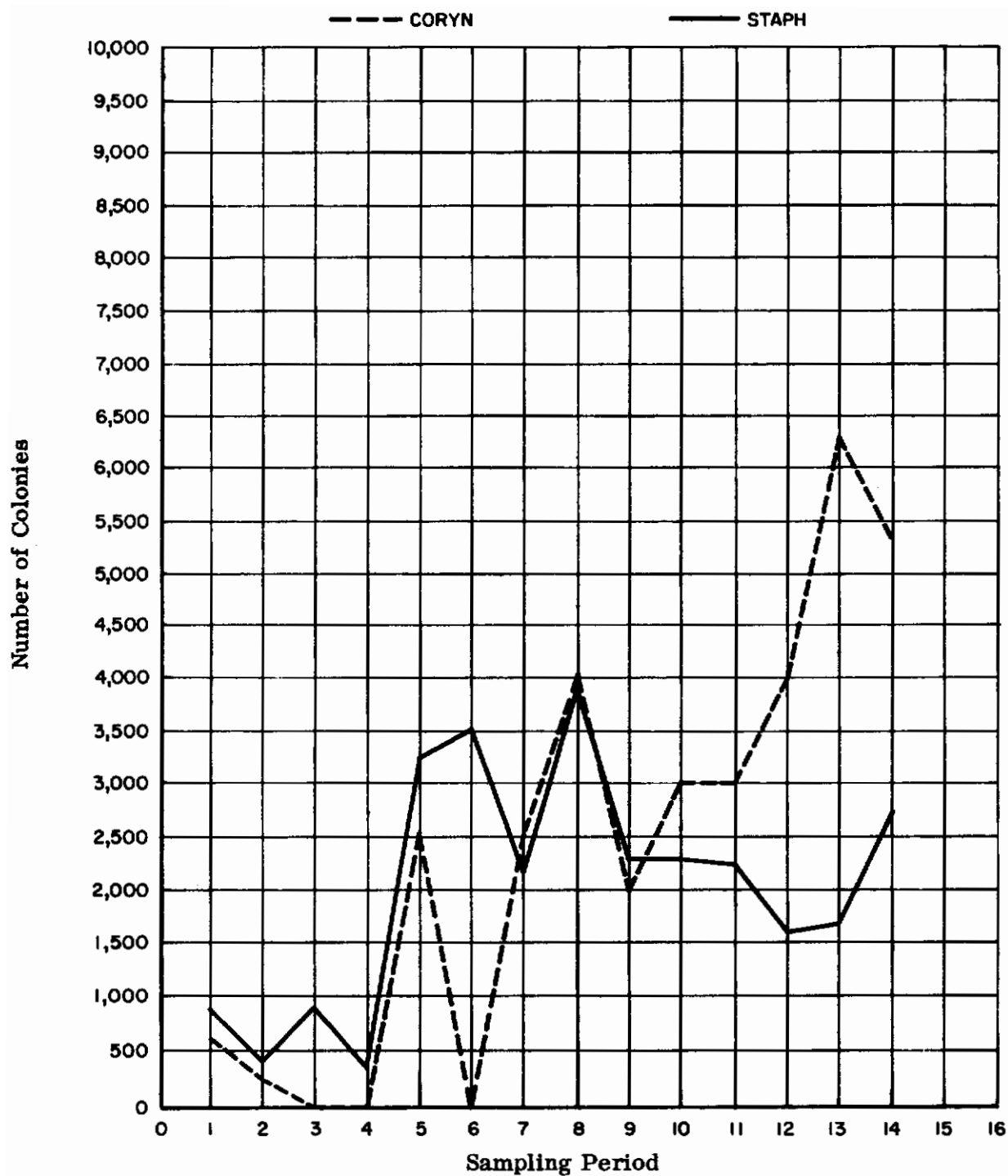

FIGURE 3 --- Continued
EXPERIMENT VI

Contrails

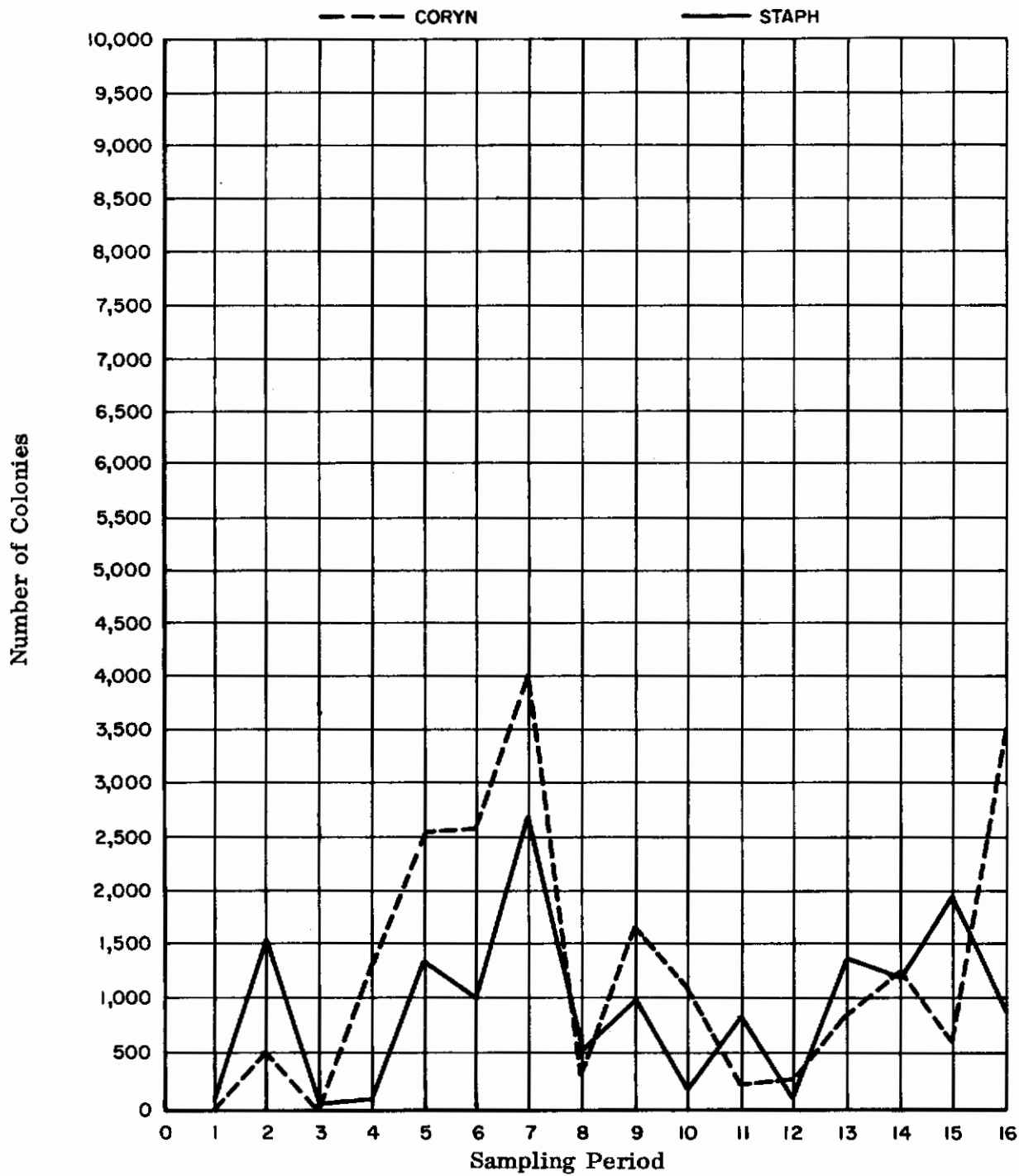

FIGURE 3 --- Continued
EXPERIMENT VII

Contrails

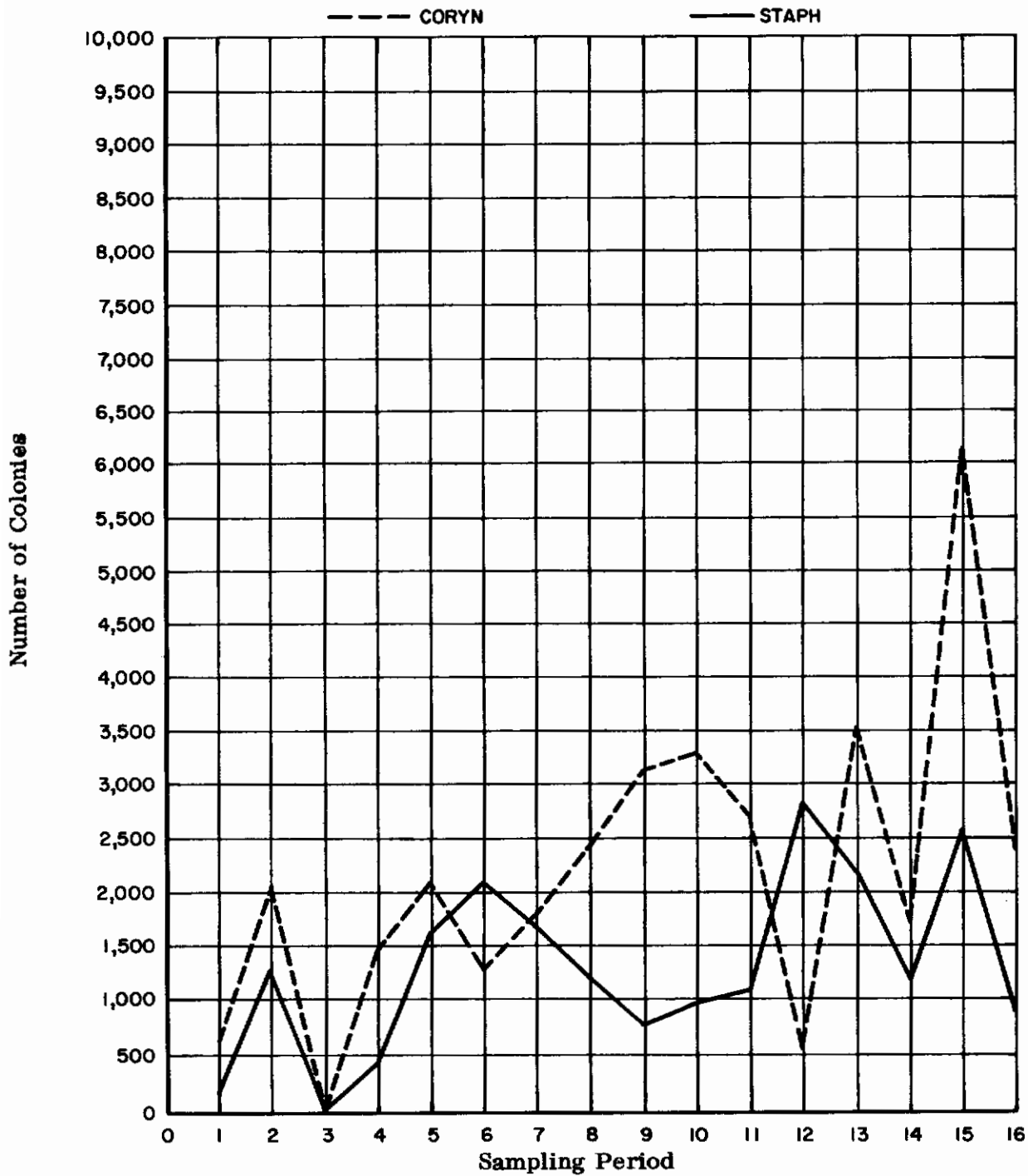
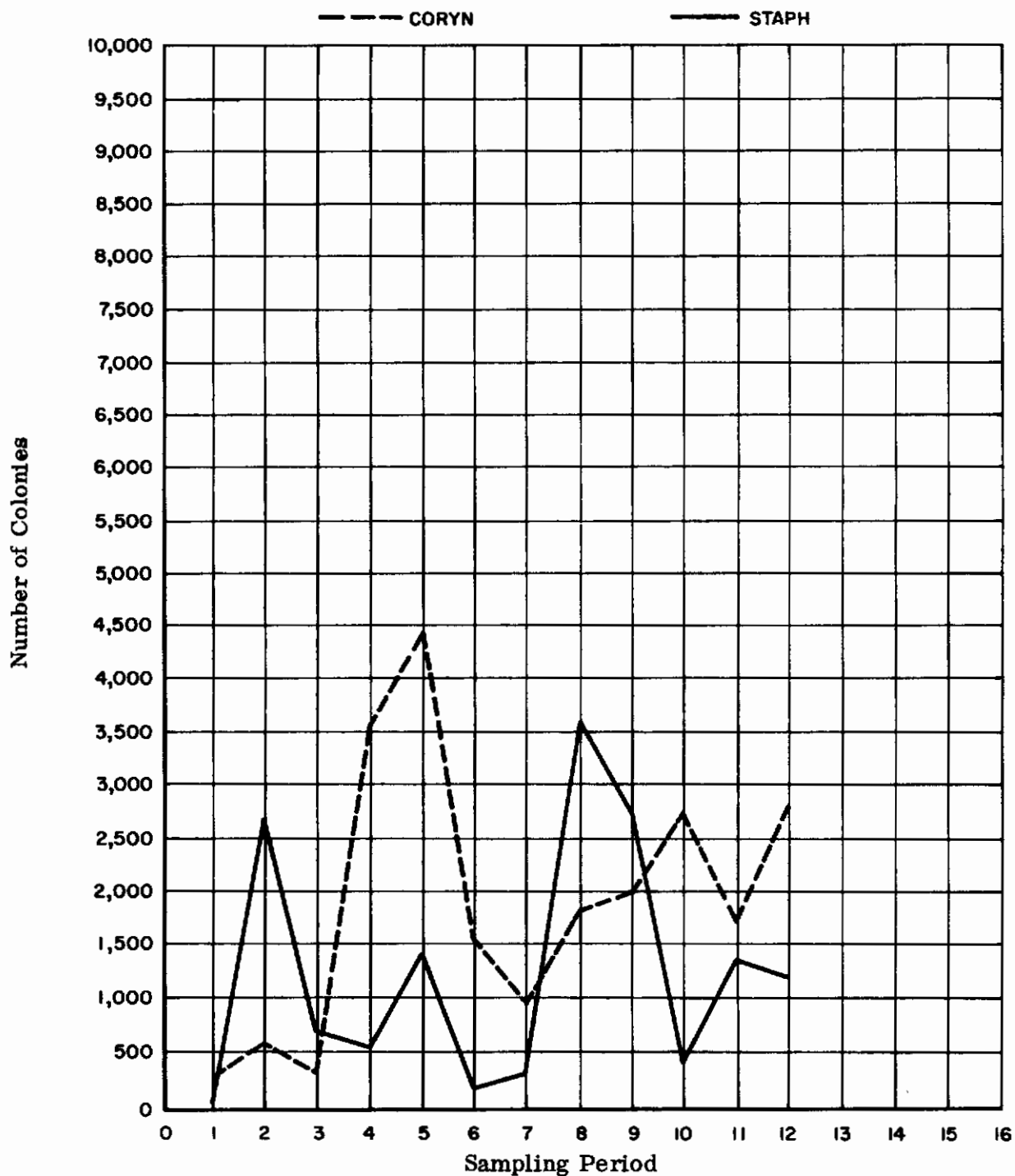

FIGURE 3 --- Continued
EXPERIMENT VIII

Contrails



Temperature sampling period 4, 5, 8 and 9 = 90°

**FIGURE 3 --- Concluded
EXPERIMENT IX**

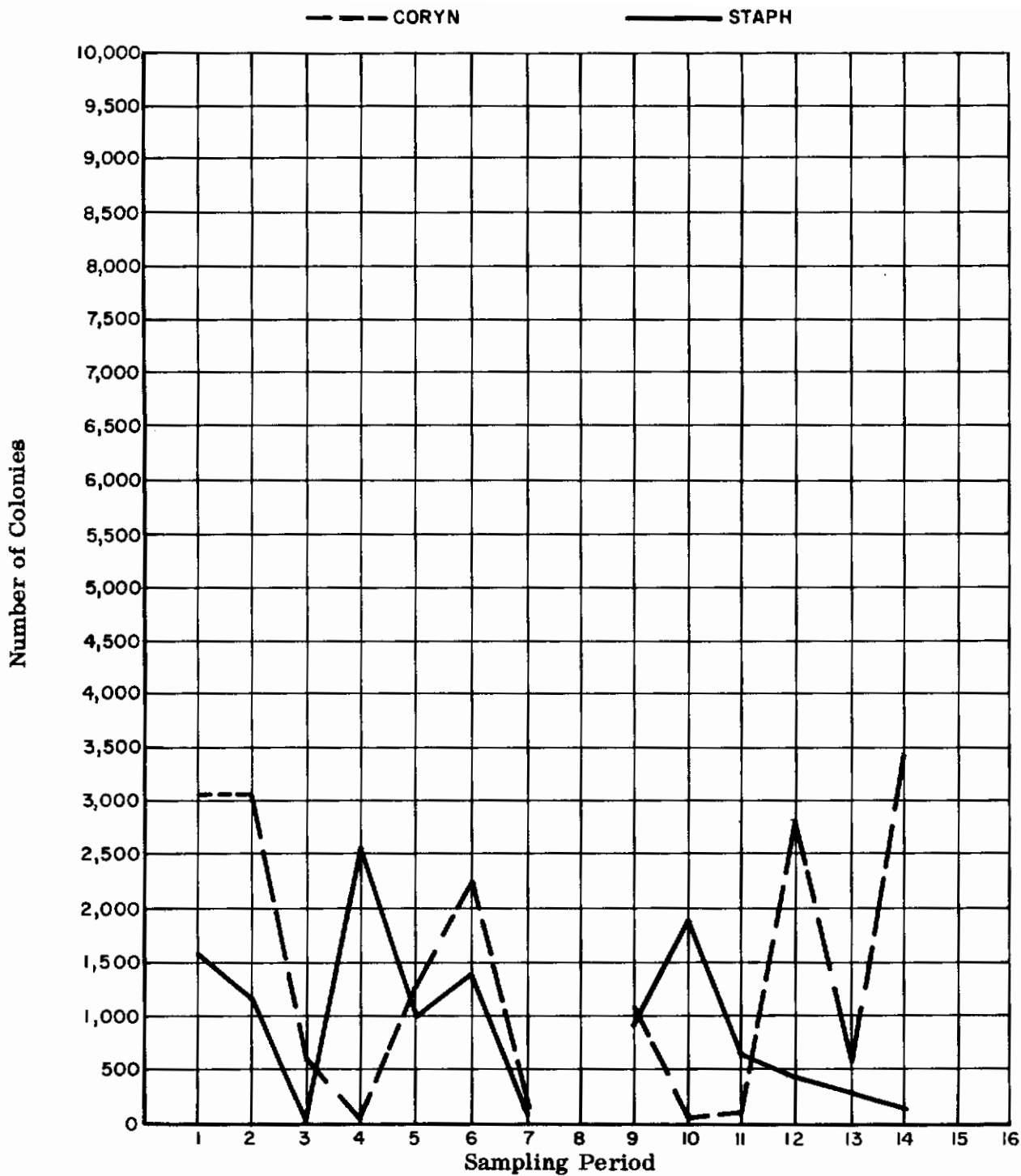

FIGURE 4. GROIN - EXPERIMENT V (Averaged)

Contrails

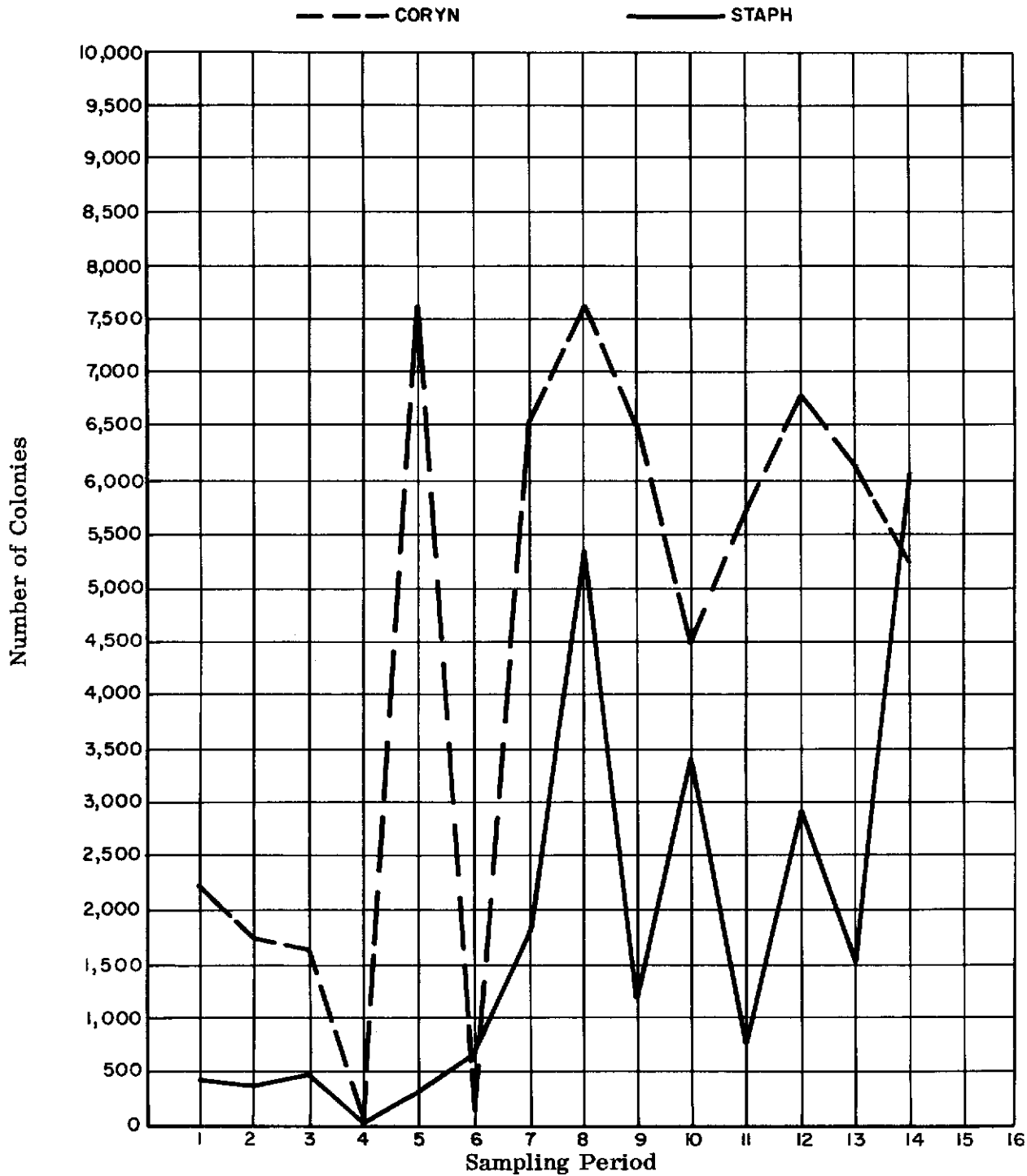

FIGURE 4 --- Continued
EXPERIMENT VI

Contrails

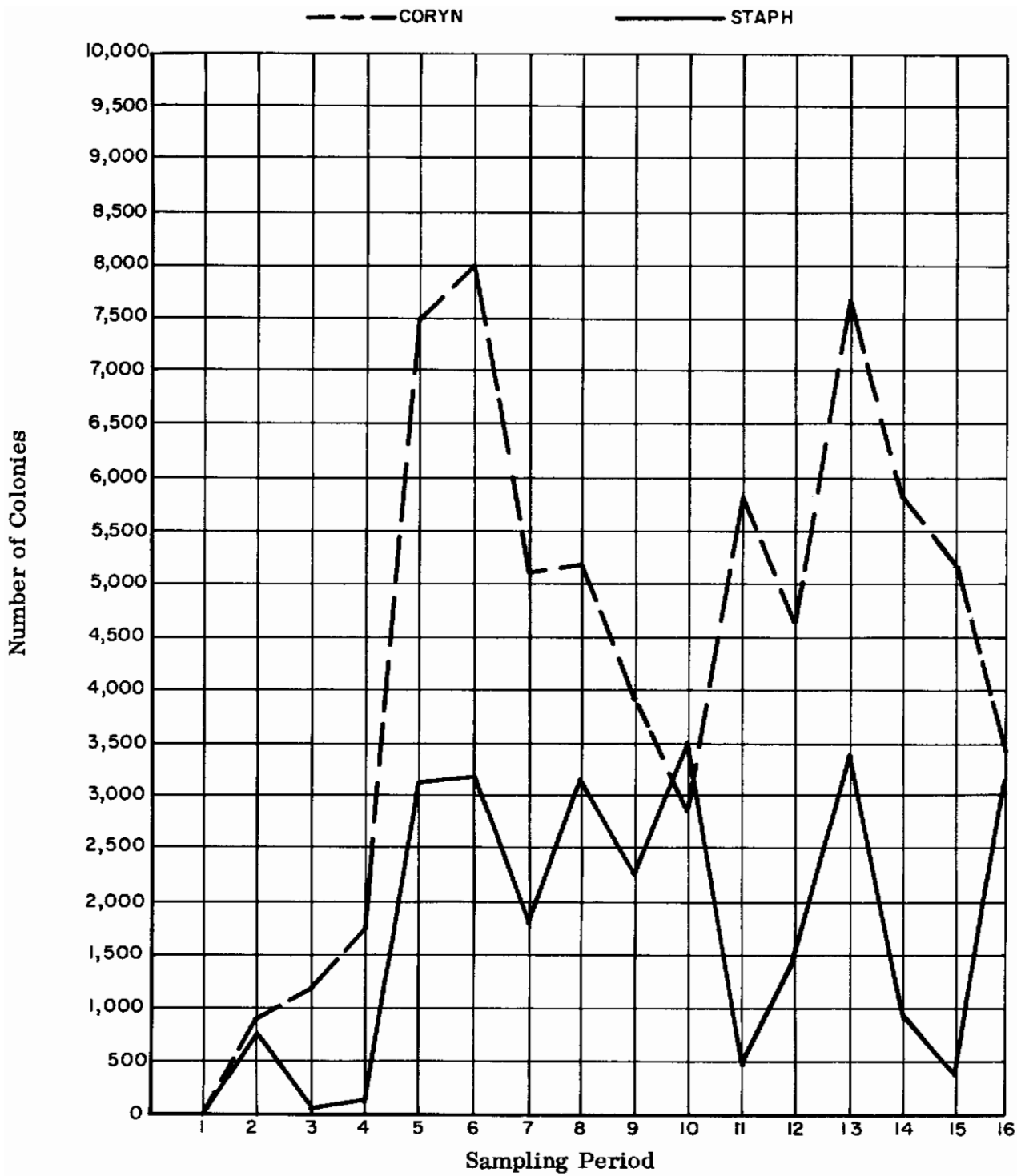

FIGURE 4 --- Continued
EXPERIMENT VII

Contrails

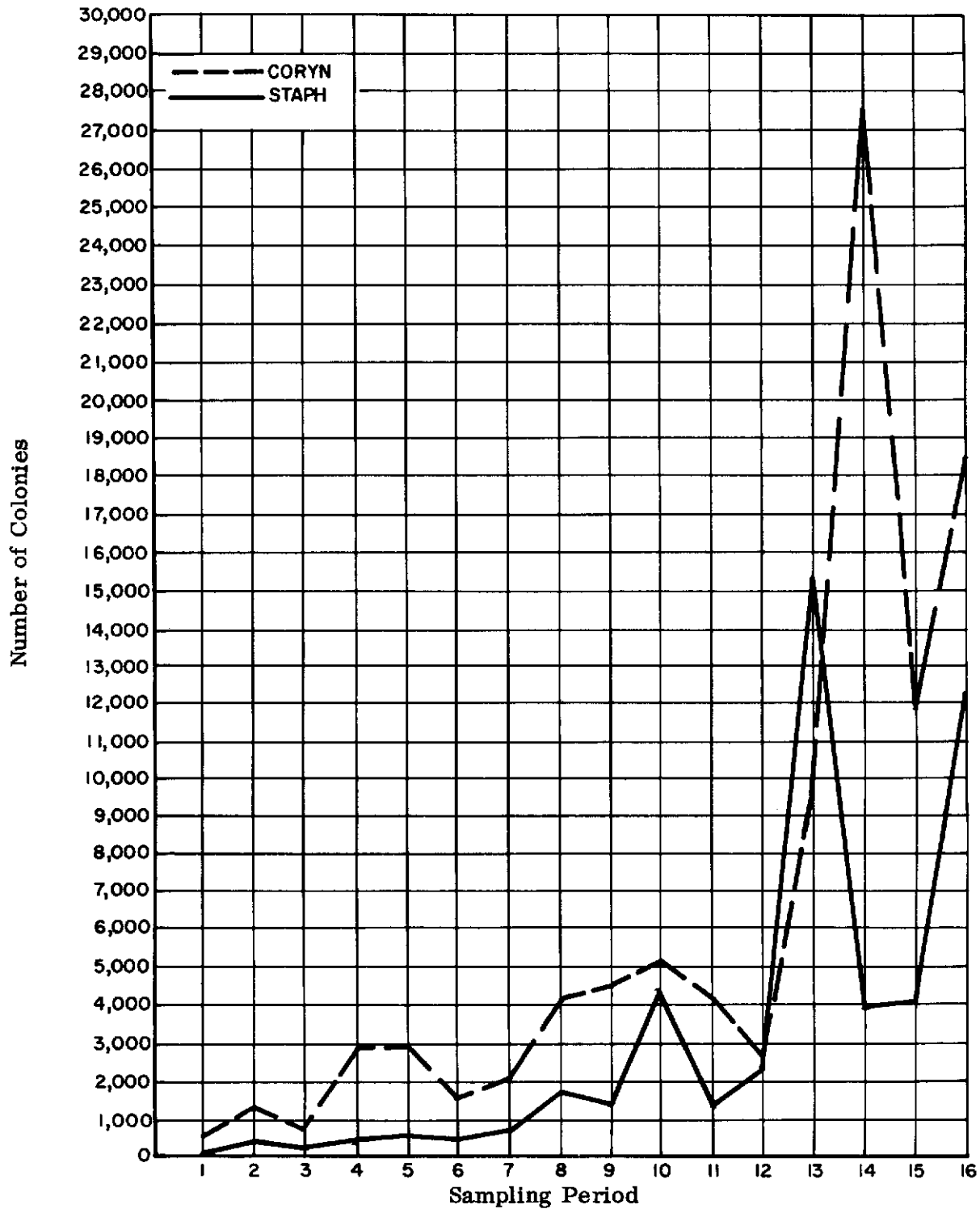
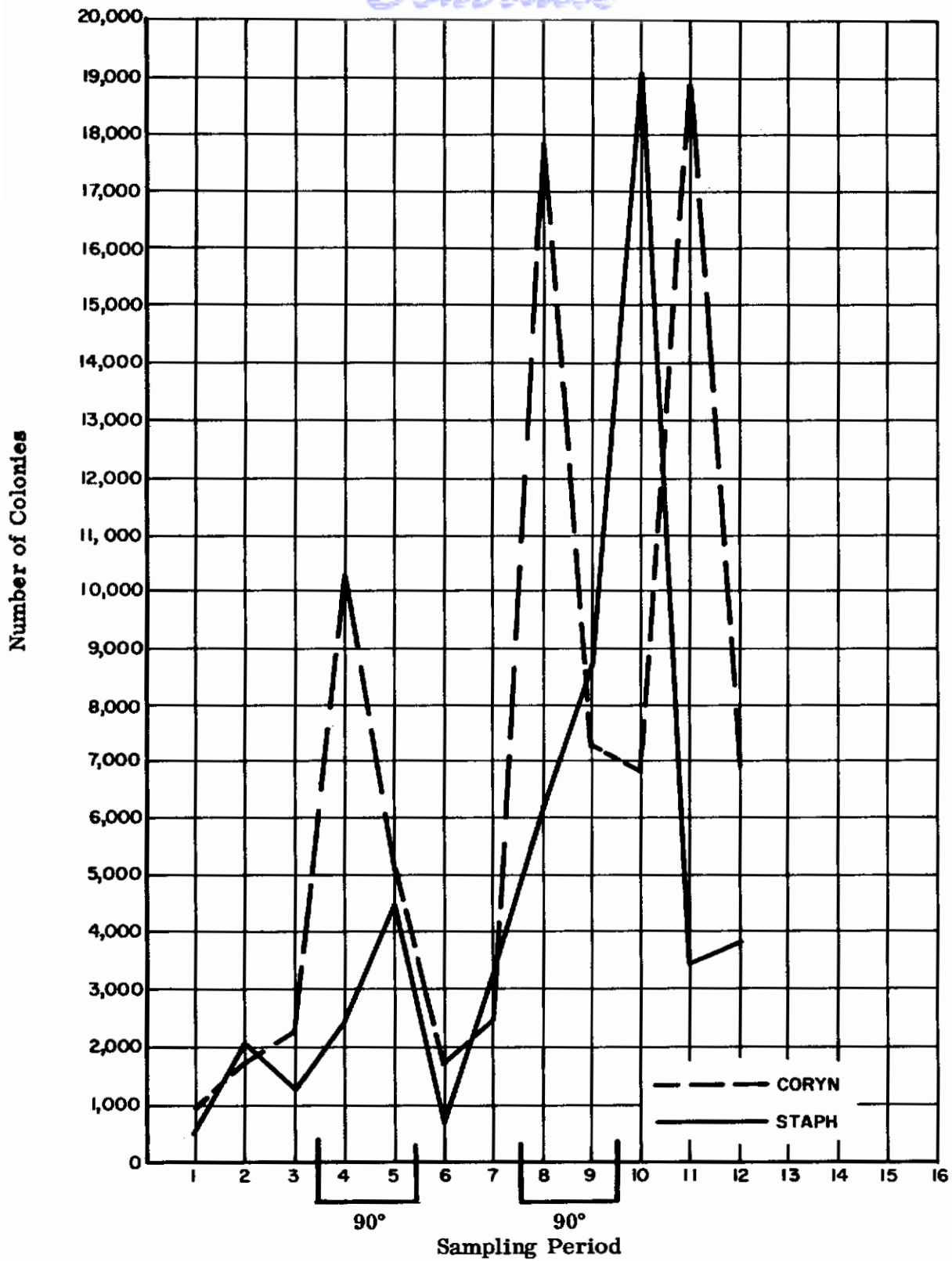

FIGURE 4 --- Continued
EXPERIMENT VIII

Contrails



**FIGURE 4 --- Concluded
EXPERIMENT IX**

Contrails

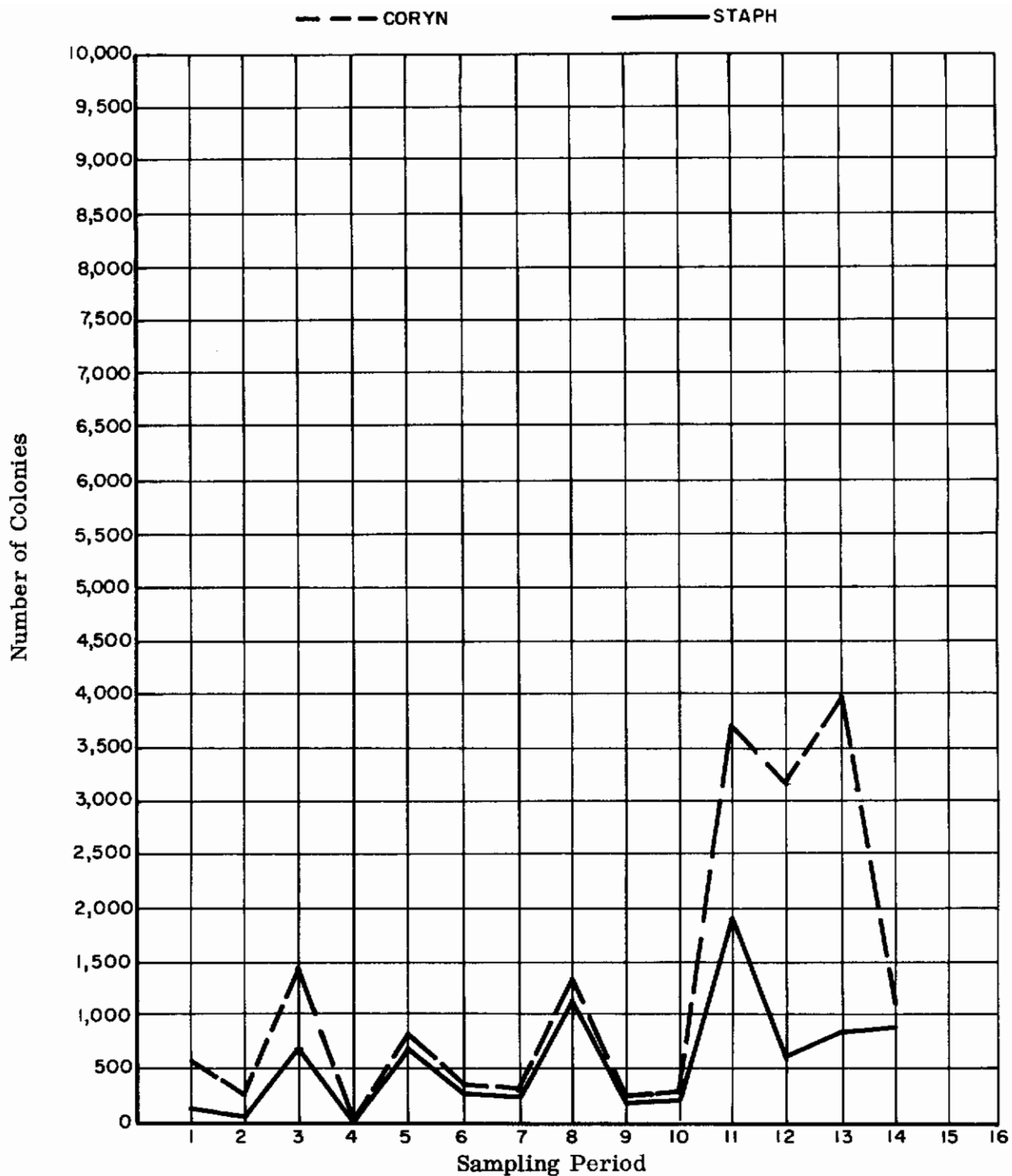

FIGURE 5. GLANS PENIS - EXPERIMENT VI (Averaged)

Contrails

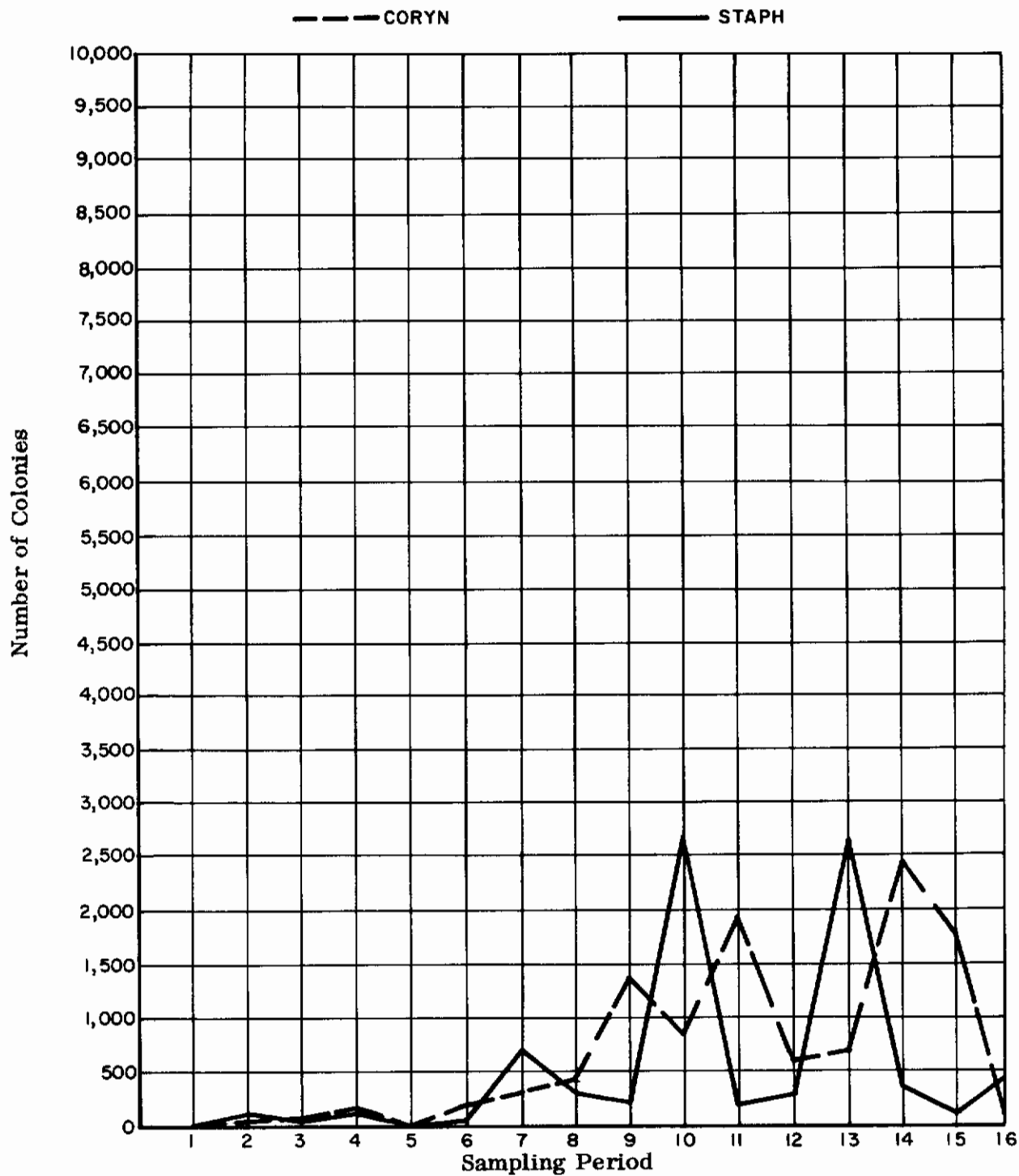
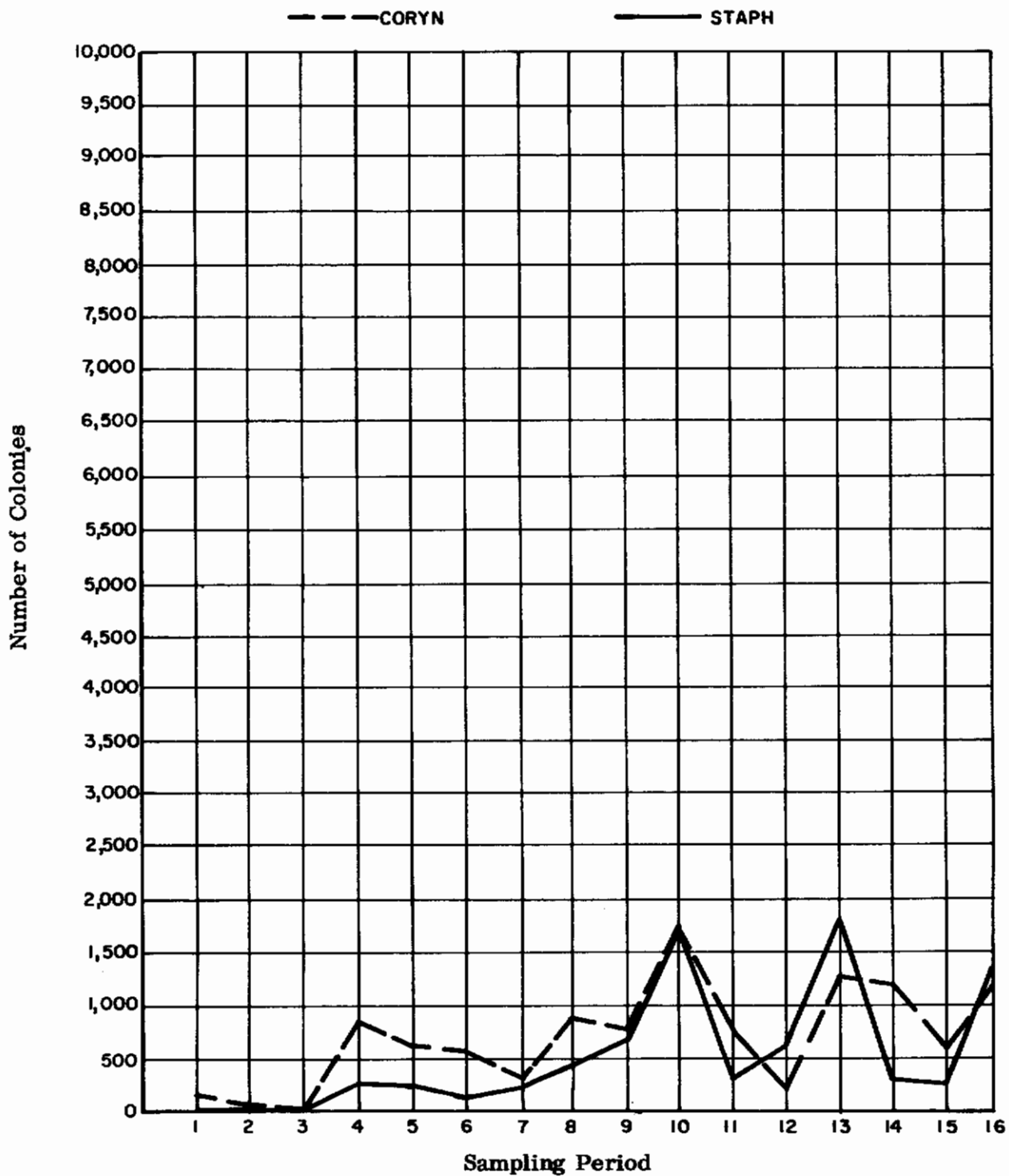
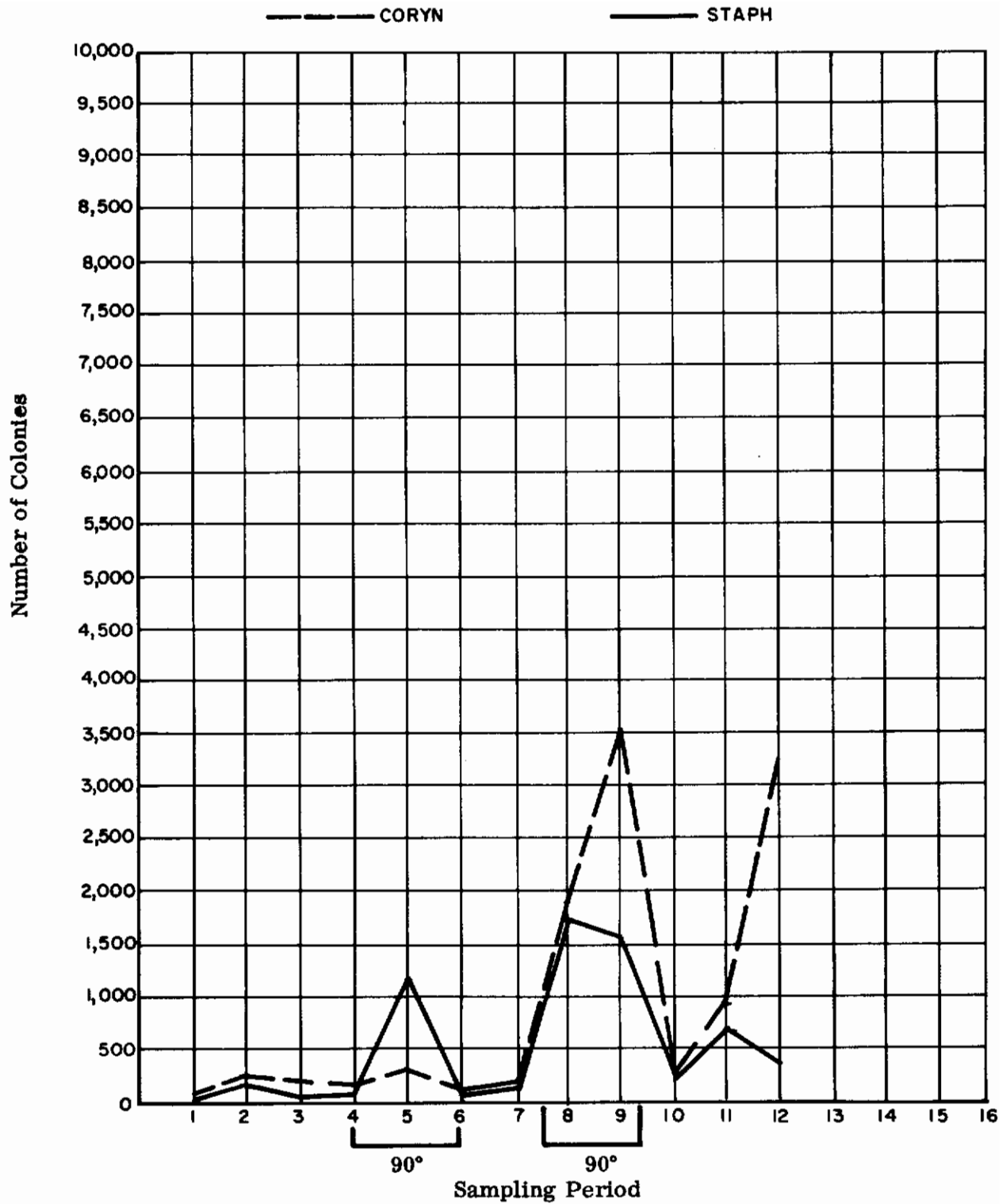

FIGURE 5 --- Continued
EXPERIMENT VII

Contrails



**FIGURE 5 --- Continued
EXPERIMENT VIII**



**FIGURE 5 --- Concluded
EXPERIMENT IX**

APPENDIX II
TABULATION OF RESULTS

TABLE 1. SCHEDULE OF SAMPLES FROM THE BODY AREAS AND THE ENVIRONMENT
EXPERIMENT V

DATE	TEST CONDITION																		CAF																																					
	EVALUATOR																																																							
	M	T	W	T	F	S	S	M	T	W	T	F	S	S	M	T	W	T	F	S	S	M	T	W	T	F	S	S																												
7/20	21	22	23	24	25	26	27	28	29	30	31	1	2	3	4	5	6	7	8	9	10	11	12	13	14	15	16	17	18	19	20	21	22	23	24	25	26	27	28	29	30															
BODY AREAS																																																								
A AREAS	1																																																							
B AREAS	1																																																							
FECES																																																								
SUBJECT 17	1																																																							
SUBJECT 18	1																																																							
SUBJECT 19	1																																																							
SUBJECT 20	1																																																							
ENVIRONMENTAL AREAS	1	2	3	4	5	6-7	8	9	10	11	12	13	14	15	16	17	18	19	20	21	22	23	24	25	26	27	28	29	30																											

A AREAS INCLUDE: EAR, EYE, NOSE, THROAT, AXILLA, UMBILICUS, GROIN, AND ANAL AREA
 B AREAS INCLUDE: SCALP, MOUTH, FOREARM, FOREARM, GLANS PENIS, AND TOES
 ENVIRONMENTAL AREAS INCLUDE: TABLES, FORE AND AFT, FLOOR OF PERSONAL HYGIENE AREAS, AND BED
 CAF = CONTROLLED ACTIVITY FACILITY

TABLE 1 --- Continued
EXPERIMENT VII

DATE	CAF												TEST CONDITION												CAF																						
	EVALUATOR												EVALUATOR												EVALUATOR																						
	T	W	T	F	S	S	M	T	W	T	F	S	T	W	T	F	S	S	M	T	W	T	F	T	W	T	F	S	S	M	T	W	T	F	S												
AREAS	12	13	14	15	16	17	18	19	20	21	22	23	24	25	26	27	28	29	30	31	2/1	2	3	4	5	6	7	8	9	10	11	12	13	14	15	16	17	18	19	20	21	22	23				
BODY AREAS																																															
A AREAS	1						2		3		4			5	6	7				8	9			10				11				12	13		14								16				
B AREAS																				2																									3		
FECES																																															
SUBJECT 25	1																																														
SUBJECT 26																																															
SUBJECT 27	1																																														
SUBJECT 28																																															
ENVIRONMENTAL AREAS	1																																														

A AREAS INCLUDE: EAR, NOSE, THROAT, MOUTH, AXILIA, GROIN, GLANS PENIS
 B AREAS INCLUDE: SCALP, EYE, FOREARM, UMBILICUS, ANAL FOLD, TOES
 ENVIRONMENTAL AREAS INCLUDE: TABLES, FLOOR AND AFT, FLOOR OF PERSONAL HYGIENE AREAS, BED
 SUBJECTS 26 AND 27 WORE SPACE SUITS IN THE EVALUATOR
 SUBJECTS WERE FED A LIQUID DIET FROM FEBRUARY 2 THROUGH 15.

**TABLE 1 --- Concluded
EXPERIMENT IX**

DATE	TEST CONDITION																																											
	CAF													VALIATOR																														
	M	T	W	T	F	S	S	M	T	W	T	F	S	1	2	3	4	5	6	7	8	9	10	11	12	13	14	15	16	17	18	19	20	21	22	23	24	25	26					
7/12																																												
AREAS																																												
BODY AREAS																																												
A AREAS																																												
B AREAS																																												
FECES																																												
SUBJECT 33																																												
SUBJECT 34																																												
SUBJECT 35																																												
SUBJECT 36																																												
ENVIRONMENTAL AREAS																																												
MISCELLANEOUS																																												
ELECTRODE																																												
SWEAT TEST																																												
Subject 33																																												
Subject 34																																												
Subject 35																																												
Subject 36																																												

A AREAS INCLUDE: NOSE, THROAT, GINGIVAL, AXILLA, GROIN, GLANS PENIS, ANAL FOLD, TOES, ROOM AREAS
 B AREAS INCLUDE: SCALP, EAR, EYE, FOREARM, UMBILICUS, ELECTRODE AREAS
 ENVIRONMENTAL ROOM AREAS INCLUDE: TABLES, FLORE AND AFT; FLOOR OF PERSONAL HYGIENE AREAS, AND BED

72°
 90°

TABLE 2. LIST OF PRIMARY CULTURE MEDIA FOR EACH BODY AREA

Aerobic Samples

	Scalp	Ear	Eye	Nose	Mouth	Gingival**	Throat	Axilla	Forearm	Umbilicus	Groin	Glans penis	Anal fold	Feces	Toes	Electrode
Actinomycete Agar (c)	X	X	X	X	X	X	X	X	X	X	X	X	X	X	X	X
2 Blood Agar Plates (d)	X	X	X	X	X	X	X	X	X	X	X	X	X	X	X	X
*PPL0 Agar (c)	X	X	X	X	X	X	X	X	X	X	X	X	X	X	X	X
Phytone Yeast Extract Agar (d)	X	X		X	X		X	X	X	X	X	X	X	X	X	X
Mitis Salivarius Agar (e)				X	X	X	X							X		
MacConkey's Agar (e)											X	X	X	X		

Anaerobic Samples

Blood Agar Plate (d)	X	X	X	X	X	X	X	X	X	X	X	X	X	X	X	X
Chocolate Agar (d)				X	X	X	X					X				
Rogosa's Media (d, e)					X	X	X									
Deep Blood Agar Tubes					X	X	X									
Dilution Series	L-1	L-2	L-1	L-3	L-6	L-5	L-7	L-3	L-1	L-1	L-3	L-3	L-4	L-11 ^(a)	L-3	L-2
Agar Shakes	X	X	X	X	XX	XX	XX	X	X	X	X	X	X	XXX ^(b)	X	X
Brewer Plates					X	X	X					X	X	XX ^(b)		
Counting Plates														X ^(b)		

(c) Difco Laboratories
 (d) Baltimore Biological Laboratory
 (e) Albimi Laboratories, Inc.

* One time per week for body areas
 ** Dental instruments used for obtaining sample
 (a) Gall's Broth
 (b) Gall's Agar

TABLE 3. SCREEN TEST FOR PREDOMINATING OBLIGATE AND FACULTATIVE ANAEROBIC FECAL BACTERIA

Type Culture	Morphology	Agar Shake	Broth	Glucose	Sucrose	Lactose	Dextrin	Blank	Infus Milk	Gelatin	pH
FA-1	slender gram positive rod singly and in chains; distinct rods uniformly spaced	very fine colonies; very anaerobic	heavy turbidity with slime developing	4+	4+	4+	2+	+	delayed ARC* with proteolysis	no liquefaction	7.0
FA-2	slender gram positive rod in chains, with tadpole	diffuse colonies very anaerobic	heavy with slime	4+ with silky turbidity 4+ slime	3+ with silky turbidity 3+ slime	3+ with silky turbidity 3+ slime	± +	± ±	delayed ARC* with proteolysis	no liquefaction	6.4
FA-3	medium to small gram negative elongate pointed rods in pairs	diffuse growth; heavy gas; very anaerobic	heavy with slimy sediment	4+ slimy sediment 4+ black sediment	4+ slimy sediment 4+ black sediment	4+ slimy sediment 4+ black sediment	4+ slimy sediment 4+ black sediment	4+ slimy sediment 4+ black sediment	delayed ARC* with proteolysis and gas	no liquefaction	7.5
FA-4	slender gram positive, sometimes slightly curved rod, singly	small colonies; very anaerobic	moderate turbidity	4+ slime 4+ slime	4+ slime 4+ slime	4+ slime 4+ slime	2+ sediment 2+ sediment	2+ sediment 2+ sediment	ARC* strong; delayed proteolysis	no liquefaction	5.6
FA-5	short, medium slightly curved gram positive rod, singly; often developing clusters	medium colonies, very anaerobic	moderate turbidity	4+ slime 4+ slime	4+ slime 4+ sediment	4+ slime 4+ sediment	4+ slime 4+ slime	± ±	delayed ARC* with proteolysis	no liquefaction	5.5-5.8
FA-6	gram positive medium rods, tending to form clusters some slightly curved	medium colonies, very anaerobic	clear slimy sediment	4+ slime 4+ slime	4+ slime 4+ slime	4+ slime 4+ slime	3+ slime 4+ slime	+ slight slime + slight slime	ARC*	no liquefaction	6.6

Results obtained under NASA Contract NASw-738
* Acid Reduced Curd

TABLE 3 --- Continued

Type Culture	Morphology	Agar Shake	Broth	Glucose	Sucrose	Lactose	Dextrin	Blank	Litmus Milk	Gelatin	pH
FA-7	small gram negative slender rod, tendency towards bipolar staining	fine colonies; very anaerobic	moderate turbidity slime	4+ slime 4+ slime	4+ slime 4+ slime	4+ slime 4+ slime	+ + slime	+ +	ARC* delayed proteolysis	no liquefaction	6.6
FA-8	tiny gram negative slender rods, slightly curved	fine colonies; very anaerobic	clear with sediment	+ 3+	+ 3+	+ 3+	+ 3+	+ 3+	partial reduction orange color	no liquefaction	6.9
FA-9	medium to large pleomorphic gram positive rod in pairs and short chains; chain has characteristic hooked or loop shape - older cultures form heavy gram positive aggregation	hazy; very anaerobic	moderate turbidity	3+ slight slime 3+ moderate slime	3+ slight slime 3+ moderate slime	+ slime 3+ slime	± slime + slight slime	clear with slight slime +	delayed ARC* with ± proteolysis	no liquefaction	7.0
FA-10	very small gram positive rods in chains with a tendency for bipolar staining, some- times slightly pointed	fine colonies, very anaerobic	heavy with floccular sediment	4+ fluffy sediment 4+ sediment	4+ fluffy sediment 4+ sediment	4+ fluffy sediment 4+ sediment	3+ 4+ sediment	+ sediment 4+ sediment	delayed ARC* with proteolysis	no liquefaction	6.7
FA-11	medium short gram positive rods, some slightly curved, older cultures tend toward gram positive aggregation	fine colonies, very anaerobic	heavy turbidity	3+ 3+ sediment	3+ 3+ sediment	3+ sediment 3+ sediment	3+ 3+ sediment	± sediment clear with slight sediment	ARC* with proteolysis	no liquefaction	6.5
FA-12	gram positive tiny pointed rods in chains with many coccoid forms	medium colonies very anaerobic with slight gas	heavy with slime	3+ slime 3+ slime	3+ slime 3+ slime	+ with slime 3+ slime	± slime + slime	± slime ± slime	delayed ARC* with proteolysis	no liquefaction	7.2

TABLE 3 --- Continued

Type Culture	Morphology	Agar Shake	Broth	Glucose	Sucrose	Lactose	Dextrin	Blank	Lithmus Milk	Gelatin	pH
FA-13	small gram negative cocci in masses	fine colonies; heavy gas; very anaerobic	moderate turbidity	3+ gas black slime 3+ black slime	3+ gas black slime 3+ black slime	3+ gas black slime 3+ black slime	3+ gas black slime 3+ black slime	3+ gas black slime 3+ black slime	Reduced	no liquefaction	6.7
FA-14	gram negative rods, long slender with gram positive areas	tiny colonies, very anaerobic with heavy gas	heavy turbidity gas	4+ slight slime gas 4+	4+ slight slime 4+	+	±	±	Reduced, whey caramelization	no liquefaction	6.75
FA-15	short fat gram negative rod, singly and in pairs; some with pointed ends	delayed haze; heavy gas; very anaerobic	heavy with slight slime	4+ slight slime 4+ slight slime	4+ slight slime 4+ slight slime	+	2+ slight slime 4+ slime	±	delayed ARC* with whey	no liquefaction grey sediment	6.7
FA-16	gram positive pleomorphic rods; some curved and some tadpole forms	haze with anaerobic collar	heavy with slime	+ curly slime 3+ slime	+ curly slime 3+ slime	+ curly slime 3+ slime	clear slime + slime	-	ARC*	no liquefaction	6.8
FA-17	large gram positive rod singly and in pairs forming palisades and V's	fine colonies very anaerobic, slight gas, occasionally	slight with finely granular sediment and side growth	clear with finely granular sediment clear with finely granular sediment	clear with finely granular sediment clear with finely granular sediment	clear with finely granular sediment clear with finely granular sediment	clear with finely granular sediment clear with finely granular sediment	clear with finely granular sediment clear with finely granular sediment	ARC* with proteolysis	no liquefaction	6.6
FA-18	gram positive long slender rods, irregular staining	fine colonies, very anaerobic	slight with slime	± moderate slime + moderate slime	± moderate slime + moderate slime	± moderate slime + moderate slime	± moderate slime + moderate slime	± moderate slime + moderate slime	ARC* delayed	no liquefaction	6.3 to 6.6

TABLE 3 --- Continued

Type Culture	Morphology	Agar Shake	Broth	Glucose	Sucrose	Lactose	Dextrin	Blank	Litmus Milk	Gelatin	pH
FN-1	gram positive pointed rods in pairs and short chains	fine colonies facultative anaerobic	heavy with slime	4+ slime 4+ slime	4+ slime 4+ slime	3+ slime 4+ slime	3+ slime 4+ slime	3+ slime 4+ slime	delayed ARC*	no liquefaction	6.7
FN-2	gram positive coccobacillus pairs and chains	medium colonies facultative anaerobic	clear with growth on sides and white sediment	3+ granular sediment 3+ granular sediment	3+ granular sediment 3+ granular sediment	3+ granular sediment 3+ granular sediment	+ granular sediment 3+ granular sediment	± + with sediment	ARC* with proteolysis	no liquefaction	6.5
FN-3	small round cocci in short chains becoming less discrete with age	discrete colonies with heavy gas facultative anaerobic	moderate with white sediment	3+ granular sediment 4+ granular sediment	3+ granular sediment 4+ granular sediment	4+ sediment 4+ granular sediment	3+ 3+ granular sediment	± ±	ARC* with proteolysis	no liquefaction	6.4
FN-4	gram positive elongate cocci in short chains	fine colonies facultative anaerobic	moderate	4+ slime 4+ slime	4+ slime 4+ slime	3+ slime 4+ slime	3+ slime 4+ slime	3+ slime 4+ slime	delayed soft ARC*	no liquefaction	6.5
FN-5	gram positive diplococci in pairs and short chains; pleomorphic	fine colonies; facultative anaerobic	moderate with floccular sediment	3+ floccular sediment 4+ floccular sediment	3+ floccular sediment 4+ floccular sediment	3+ floccular sediment 4+ floccular sediment	3+ floccular sediment 4+ floccular sediment	+ sediment + sediment	ARC* with slight proteolysis	no liquefaction	7.3 to 7.7

TABLE 3 --- Continued

Type Culture	Morphology	Agar Shake	Broth	Glucose	Sucrose	Lactose	Dextrin	Blank	Litmus Milk	Gelatin	pH
GD-1	short gram negative rod in pairs and chains, some pointed	fine colonies, heavy gas, very anaerobic	heavy floccular sediment	4+ with slime 4+ with black slime	4+ with slime 4+ with black slime	4+ with slime 4+ with black slime	2+ with slime 4+ with black slime	1+ with slime 4+ with black slime	delayed ARC+ with proteolysis	black bottom no liquefaction	6.7
GD-2	gram negative short rod in pairs	small colonies, very anaerobic	moderate with floccular slime	4+ with heavy slime 3+ with heavy slime	4+ with heavy slime 3+ with heavy slime	4+ with heavy slime 3+ with heavy slime	4+ with heavy slime 3+ with heavy slime	3+ with floccular + slight floccular slime	ARC+ with proteolysis	no liquefaction	6.2 6.4
GD-3	gram negative pointed rods	tiny colonies, very anaerobic	moderate with moderate black sediment sometimes fluffy	2+ with slime 3+ with slime sometimes dark	2+ with slime 3+ with slime sometimes dark	2+ with slime 3+ with slime	2+ with slime 3+ with slime	2+ with slime 3+ with slime	reduced	no liquefaction	6.8
GD-4	gram negative slender rods in pairs some pleomorphic	tiny colonies heavy gas, very anaerobic	moderate with granular sediment, sometimes dark	4+ with slime and gas 4+ with slime sometimes dark	4+ with slime and gas 4+ with slime sometimes dark	4+ with slime and gas 4+ with slime sometimes dark	4+ with slime and gas 4+ with slime sometimes dark	3+ with slime and gas 3+ with slime sometime dark	delayed ARC+ with slight proteolysis	no liquefaction	6.3 6.4

TABLE 3 --- Continued

Type Culture	Morphology	Agar Shake	Broth	Glucose	Sucrose	Lactose	Dextrin	Blank	Litmus Milk	Gelatin	pH
GD-6 and GD-5a	gram ± medium rods in short chains	small colonies, very anaerobic	clear to moderate with balls of sediment	4+ with granular sediment or slime 4+ with slime or granular sediment sometimes black	4+ with granular sediment or slime 4+ with slime or granular sediment sometimes black	4+ with granular sediment or slime 4+ with slime or granular sediment sometimes black	4+ with granular sediment or slime 4+ with slime or granular sediment sometimes black	2+ with granular sediment 3+ with slime or granular sediment sometimes black	ARC+ with proteolysis	no liquefaction	6.6 GDSa 6.2 to 6.4
GD-6	gram negative short pleomorphic rods in pairs some pointed	tiny colonies, heavy gas, very anaerobic	slight to moderate with silty sediment	3+ with granular sediment 4+ with brown slime	3+ with granular sediment 4+ with brown slime	3+ with granular sediment 4+ with brown slime	3+ with granular sediment 4+ with brown slime	+ with silty sediment 3+ with brown slime	delayed ARC+ with proteolysis	no liquefaction	5.9
GD-7	gram ± short pleomorphic rods in pairs some pointed	tiny colonies, heavy gas, very anaerobic	4+ with dark slime	4+ with slime and heavy gas 4+ with heavy black slime	4+ with slime and heavy gas 4+ with heavy black slime	4+ with slime and heavy gas 4+ with heavy black slime	3+ with heavy slime and gas 4+ with heavy black slime	3+ with heavy slime and gas 4+ with heavy black slime	reduced	no liquefaction black bottom	6.8

TABLE 3 --- Continued

Type Culture	Morphology	Agar Shake	Broth	Glucose	Sucrose	Lactose	Dextrin	Blank	Litmus Milk	Gelatin	pH
PS ₁	gram positive cocci in short chains	tiny colonies with gas, facultative anaerobic	heavy with slime	3+ slime 4+ slime sometimes black	3+ slime 4+ slime sometimes black	3+ slime 4+ slime sometimes black	+ slime 2+ slime sometimes black	+ slime + slime sometimes black	delayed ABC*	no liquefaction	7.5 to 7.8
PS ₂	gram positive cocci in short chains	tiny colonies with gas, facultative anaerobic	moderate with slime	3+ slime 4+ slime	3+ slime 4+ slime	3+ slime 4+ slime	+ slime 4+ slime	+ slime + slime	ARC*; slight proteolysis	no liquefaction	6.8 to 7.0
PS ₃	gram positive cocci in chains	small colonies facultative anaerobic	heavy with floccular sediment	3+ sediment 4+ sediment	3+ sediment 4+ sediment	3+ sediment 4+ sediment	2+ slime 3+ slime	+ slime + slime	delayed ABC*	no liquefaction	6.4 to 6.6

Results obtained under Contract AF33(615)-1814, "Biomedical Criteria for Personal Hygiene".

TABLE 3 --- Concluded

Type Culture	Morphology	Agar Shake	Broth	Glucose	Sucrose	Lactose	Dextrin	Blank	Litmus Milk	Gelatin	pH
CN-1	gram positive rods, some slightly curved, some ovoid in chains	very fine colonies facultative anaerobic	slight with slimy (dark?)	3+ with flocculant granules and side growth 3+ with flocculant granules and side growth	3+ with flocculant granules and side growth 3+ with flocculant granules and side growth	+ with slight slime + with slight slime	3+ with flocculant granules and side growth 3+ with flocculant granules and side growth	+ with slight slime + with slight slime	ARC*	no liquefaction	5.8
CN-2	gram positive rods some in pairs, various sizes	small colonies facultative anaerobic	slight with slimy	1+ with granular slime 1+ with granular slime	1+ with granular slime 1+ with granular slime	1+ with granular slime 1+ with granular slime	1+ with granular slime 1+ with granular slime	1+ with granular slime 1+ with granular slime	reduction	no liquefaction	7.3

Results obtained under Contract AF29(600)-4124, "Study of Bacterial Flora of Alimentary Tract of Chimpanzees."

TABLE 4. PERSONAL HYGIENE PROTOCOL

Experiment V Period 1 2 3 4 5 6	Shaving	Body		Grooming	Nails	Oral Hygiene	Clothing			MA-10 Suit
		Bathing	Wipes				Underwear	Outerwear	Footwear	
"	None	Ivory Soap*	Wet and Dry	None	None	Electric Toothbrush With Water	Long	Air Force Pajamas	White Socks, Low Sneakers	None
"	"	"	"	None	Clipped	"	"	"	"	"
"	"	"	"	Moustache Clipped	None	"	"	"	"	"
"	"	"	"	None	"	"	"	"	"	"
"	"	"	"	None	"	"	"	"	"	"
Experiment VI Period 1 2 3 4 5 6	None	Priso-Hex*	Wet and Dry	None	None	Electric Toothbrush With Water Toothbrush With Rubber Tip	Loose Fitting, Long	Air Force Pajamas	White Socks, Low Sneakers (changed)	None
"	"	"	"	None	Clipped	"	"	"	"	"
"	"	"	"	Moustache Clipped	None	"	"	"	"	"
"	"	"	"	None	"	"	"	"	"	"
"	"	"	"	None	"	"	"	"	"	"
Experiment VII Period 1 2 3 4 5 6	None	Priso-Hex*	2 Kinds Wet Wipes** (old) (new) (new) (new) (old)	None	None	Regular Toothbrush and Water	Loose Fitting, Long (changed)	Air Force Pajamas (changed)	Heavy 100% Cotton Socks and Moccasins (changed)	None
"	"	"	"	None	"	"	"	"	"	"
"	"	"	"	"	"	"	"	"	"	"
"	"	"	"	"	"	"	"	"	"	"
"	"	"	"	"	"	"	"	"	"	"
"	"	"	"	"	"	"	"	"	"	"
Experiment VIII Period 1 2 3 4 5 6	None	Ivory Soap* Sweat Test 1	Dry, Wet With Water	None	None	Regular Toothbrush With 50%*** Ethyl-Dentaline (1 gm)	Loose Fitting, Long (changed)	Air Force Pajamas (changed)	Heavy 100% Cotton Socks and Moccasins (changed)	None
"	"	"	"	"	"	"	"	"	"	"
"	"	"	"	"	"	"	"	"	"	"
"	"	"	"	"	"	"	"	"	"	"
"	"	"	"	"	"	"	"	"	"	"
"	"	"	"	"	"	"	"	"	"	"
Experiment IX Period 1 2 3 4 5 6	None	Ivory Soap* Sweat Test 1	Dry, Wet With Water	None	None	Regular Toothbrush With Dental Floss	Loose Fitting, Long (changed)	Air Force Pajamas (changed)	Heavy 100% Cotton Socks and Moccasins (changed)	None
"	"	"	"	"	"	"	"	"	"	"
"	"	"	"	"	"	"	"	"	"	"
"	"	"	"	"	"	"	"	"	"	"
"	"	"	"	"	"	"	"	"	"	"
"	"	"	"	"	"	"	"	"	"	"

* Controlled Activity Facility
 ** Old Type Wet Wipe: sodium lauryl sulfate
 New Type Wet Wipe: Para-di-ichthy-phenacy-ethoxy ethyl-dimethyl-beanyl ammonium chloride
 *** Exp. VII: Sweat tests performed on Subjects 30 and 31 on April 9 and 10 and May 17 and 18.
 Exp. IX: Sweat tests performed on Subjects 32 and 34 on July 24, 25, and 28 and July 29, 29, and 30.
 Exp. IX: Sweat tests performed on Subjects 35 and 36 on July 16, 20, and 21 and July 26, 27, and 28.

see School of Aviation Medicine, Brooks Air Force Base, San Antonio, Texas

TABLE 5. FREQUENCY OF AREA SAMPLING

Body Area	Experiment Number					Total**
	V*	VI*	VII*	VIII*	IX*	
Scalp	4	4	3	3	3	17
Ear	14	16	16	16	3	65
Eye	14	4	3	3	3	27
Nose	14	16	16	16	12	74
Gingival					12	12
Mouth	4	16	16	16		52
Throat	14	16	16	16	12	74
Axilla	14	16	16	16	12	76
Forearm	4	4	3	3	3	17
Umbilicus	14	4	3	3	3	27
Groin	14	16	16	16	12	76
Glans penis	14	16	16	16	12	64
Anal fold	14	4	3	3	12	36
Feces	10 (2) men 11 (2) men	12 (2) men 14 (2) men	14	14	12+1 [•]	64-66
Toes	4	4	3	3	12	26
Electrode area				2	3+1 [•]	5(6)

Room Areas						
Tables						
Fore	20+1 [•]	16	19	16	13	84
Aft	20	16	19	16	13	84
Floor Personal Hygiene Area	20	16	19	16	13	84
Bed	20	16	19	16	13	84

- 1 extra sample taken
- * Numbers represent one man, for total experiment multiply by 4.
- ** Totals should be multiplied by 20 for the total number of samples taken.

TABLE 6 . TOTAL BACTERIAL PLATE COUNTS FOR ROOM AREAS (EXPOSED 30 MINUTES)

EXPERIMENT V

	Controlled Activity Facility										Pre-Entry Evaluator (Residual Count)	Evaluator				
	Post-Entry											5	6	7	8	9
	Pre-Entry (Residual Count)		1	2	3	4	5	6	7	8						
Tables Fore Aft	3	2	14	32	68	45	1	78	127	144	7	78	127	120	144	
Floor-Personal Hygiene Area	2	2	33	62	83	155	2	69	180	175	5	69	180	220	175	
Bed	3	3	0	56	102	100	0	50	161	118	5	50	161	100	118	
			6	9	32	18	0	98	124	113	7	98	124	104	113	

	Evaluator										Pre-Entry (Residual Count)		Controlled Activity Facility	
	Evaluator										17	18		
	10	11	12	13	14	15	16	17	18					
Tables Fore Aft	250	250	160	125	115	120	32	78	60	1	78	60		
Floor-Personal Hygiene Area	195	175	219	100	126	166	160	89	63	0	89	63		
Bed	253	250	75	N.S.	250	104	97	60	67	0	60	67		
	350	250	135	N.S.	110	200	135	24	41	2	24	41		

N.S. = no sample

TABLE 6 --- Continued
EXPERIMENT VI

	CAF*			Pre-Entry Evaluator (Residual Count)	Evaluator					
	Pre-Treatment	Pre-Entry	Post-Entry		4	5	6	7	8	9
Tables Fore Aft	33 14	0 0	31 25	81 132	29 9	19 39	39 175	61 77	86 104	125 131
Floor-Personal Hygiene Area	49	3	25	253	7	6	37	36	47	77
Bed	15	0	24	101	1	21	30	40	111	115

	Evaluator										Controlled Activity Facility			
	10	11	12	13	14	15	16	17	18	19	20	21	22	23
Tables Fore Aft	171 93	148 133	175 220	136 230	167 93	150 150	205 >250							
Floor-Personal Hygiene Area	31	49	49	44	53	125	222							
Bed	145	106	145	155	127	250	>207							

* CAF = controlled activity facility

Contrails

TABLE 6 --- Continued

EXPERIMENT VII

	CAF*		Pre-Entry Evaluator (Residual Count)	Evaluator						
	Pre-Entry (Residual Count)	Post-Entry		3	4	5	6	7	8	9
		1								
Tables Fore Aft	4 1	10 13	3 3	9 21	19 29	31 21	31 53	96 30	53 41	70 45
Floor-Personal Hygiene Area	4	4	1	15	35	40	38	72	69	45
Bed	3	9	4	8	29	36	13	32	40	27

	Evaluator							Pre-Entry (Residual Count)	CAF	
	10	11	12	13	14	15	16		15	16
Tables Fore Aft	132 114	49 59	64 53	54 76	72 84	82 62	82 62	157 124	119 68	
Floor-Personal Hygiene Area	111	59	55	96	124	6	6	145	263	
Bed	114	47	103	52	55	83	83	79	101	

*CAF = controlled activity facility

TABLE 6 --- Continued

EXPERIMENT VIII

	CAF*		Pre-Entry Evaluator (Residual Count)*	Evaluator								
	Pre-Entry (Residual Count)	Post Entry		3*	4	5	6	7	8	9		
											1	2
Tables Fore Aft	0 0	41 48	67 56	14 4	7 67	5 197	10 82	20 433	35 145	24 297		
Floor-Personal Hygiene Area	2	15	27	36	12	30	51	244	53	120		
Bed	0	35	43	12	55	63	64	123	60	80		

	Evaluator				Pre-Entry (Residual Count)	Controlled Activity Facility	
	10	11	12	14		15	16
Tables Fore Aft	9 390	85 153	55 392	10 220	1 1	60 39	22 137
Floor-Personal Hygiene Area	69	49	122	140	3	55	212
Bed	67	83	114	131	1	82	46

*Taken in chamber prior to third sample

*CAF = controlled activity facility

TABLE 6 ---- Concluded

EXPERIMENT IX

	CAF *		Evaluator					
	Pre-Entry (Residual Count)	Post-Entry						
			1	2	3	4	5	6
Tables Fore	2	8	200	178	68	88	213	
Aft	0	9	273	106	244	60	160	
Floor-Personal Hygiene Area	9	19	46	58	383	170	178	
Bed	0	10	108	113	153	43	153	

	CAF *		Evaluator						CAF	
	Pre-Entry (Residual Count)	Post-Entry							Pre-Entry (Residual Count)	
			7	8	9	10	11	12	2	1
Tables Fore	449	212	195	341	239	2	131			
Aft	288	198	108	251	192	1	157			
Floor-Personal Hygiene Area	416	285	350	84	104	1	82			
Bed	140	107	103	216	96	0	64			

*CAF = controlled activity facility

TABLE 7. TOTAL BACTERIAL COUNTS BY BODY AREA
FOR EACH CULTURING PERIOD

Subject 17

Body Area	Dilution	Sampling Period															
		1	2	3	4	5	6	7	8	9	10	11	12	13	14	15	16
<u>A Areas</u>																	
Ear	10 ⁻³	0	0	0	0	11	0	3	0	0	0	2	10	2	0		
Eye	10 ⁻³	100	0	1	7	Mold	0	Mold	1	0	0	0	0	0	0		
Nose	10 ⁻³	51	33	Mold	1	33	85	300	500	250	150	110	163	120	130		
Throat	10 ⁻⁴	500	0	65	0	10	170	300	500	190	200	122	128	200	200		
Axilla	10 ⁻³	20	8	1	0	150	33	3	12	5	25	15	18	13	18		
Umbilicus	10 ⁻³	0	25	1	0	Mold	1	1	0	0	2	0	0	0	0		
Groin	10 ⁻⁴	500	500	51	200	500	300	320	500	500	500	250	140	115	250		
Anal fold	10 ⁻⁴	300	500	10	10	70	82	23	5	75	82	13	200	80	90		
Feces	10 ⁻⁵	500	78	80	7	31	18	9	5	27	20	14	NS	NS	NS		
<u>B Areas</u>																	
Scalp	10 ⁻³		1	3						150					Mold		
Mouth	10 ⁻⁵		250	500						100					230		
Forearm	10 ⁻³		Mold	2						1					2		
Glans Penis	10 ⁻⁴		500	0						2					0		
Toes	10 ⁻³		92	1						150					1		

NS = No sample

TABLE 7 --- Continued

Subject 18

Body Area	Dilution	Sampling Period															
		1	2	3	4	5	6	7	8	9	10	11	12	13	14	15	16
<u>A Areas</u>																	
Ear	10 ⁻³	250	300	80	25	2	50	0	50	150	2	4	47	110	36		
Eye	10 ⁻³	1	30	Mold	0	38	23	14	9	0	1	0	0	0	4		
Nose	10 ⁻³	250	150	10	0	75	3	Mold	35	150	150	55	NS	56	47		
Throat	10 ⁻⁴	500	500	150	0	0	2	150	500	160	150	264	61	138	56		
Axilla	10 ⁻³	16	1	1	0	3	6	3	7	8	7	5	5	Mold	0		
Umbilicus	10 ⁻³	0	200	13	0	100	151	75	54	283	185	19	22	X	123		
Groin	10 ⁻⁴	500	200	50	4	0	250	100	58	100	100	240	310	270	250		
Anal fold	10 ⁻⁴	500	250	20	13	75	10	19	17	380	19	4	7	40	18		
Feces	10 ⁻⁵	250	150	155	10	120	29	21	83	8	45	NS	NS	NS	NS		
<u>B Areas</u>																	
Scalp	10 ⁻³		250	20						2					250		
Mouth	10 ⁻⁵		500	500						150					126		
Forearm	10 ⁻³		0	3						8					2		
Glans penis	10 ⁻⁴		500	10						12					0		
Toes	10 ⁻³		250	70						2					20		

X = Spreader
NS = No sample

TABLE 7 --- Continued

Subject 19

Body Area	Dilution	Sampling Period														
		1	2	3	4	5	6	7	8	9	10	11	12	13	14	15
<u>A Areas</u>																
Ear	10 ⁻³	250	200	Mold	1	1	12	Mold	2	22	7	9	116	200	60	
Eye	10 ⁻³	0	4	Mold	0	1	0	3	26	0	0	10	2	0	0	
Nose	10 ⁻³	500	20	10	0	10	0	13	45	90	15	115	87	115	20	
Throat	10 ⁻⁴	0	13	30	0	0	5	10	250	500	200	340	74	200	130	
Axilla	10 ⁻³	250	100	10	0	500	90	300	150	81	10	21	18	23	32	
Umbilicus	10 ⁻³	100	35	0	0	37	55	0	NS	8	4	2	5	X	0	
Groin	10 ⁻⁴	600	300	70	10	0	200	30	71	300	28	146	10	X	0	
Anal fold	10 ⁻⁴	32	300	36	60	65	250	27	43	14	182	15	150	220	130	
Feces	10 ⁻⁵	150	140	3	54	110	128	8	32	4	6	3	NS	NS	NS	
<u>B Areas</u>																
Scalp	10 ⁻³		23	2						1					X	
Mouth	10 ⁻⁵		300	500						120					227	
Forearm	10 ⁻³		1	2						0					1	
Glans penis	10 ⁻⁴		500	100						4					Mold	
Toes	10 ⁻³		300	10						5					0	

X = Spreader
 NS = No Sample

TABLE 7 --- Continued

Subject 20

Body Area	Dilution	Sampling Period														
		1	2	3	4	5	6	7	8	9	10	11	12	13	14	15
A Areas																
Ear	10 ⁻³	500	500	150	5	10	3	Mold	30	60	142	134	12	100	0	
Eye	10 ⁻³	19	0	Mold	0	0	0	0	0	0	0	0	0	0	0	
Nose	10 ⁻³	300	20	Mold	0	13	1	2	8	3	43	100	0	1	10	
Throat	10 ⁻⁴	500	30	125	0	5	45	85	250	350	126	150	116	145	1	
Axilla	10 ⁻³	106	250	141	61	200	200	X	56	400	165	70	200	10	81	
Umbilicus	10 ⁻³	6	1	0	0	0	1	7	4	60	0	0	0	X	219	
Groin	10 ⁻⁴	500	300	4	4	0	250	2	250	2	23	50	5	X	0	
Anal fold	10 ⁻⁴	50	2	48	150	35	45	85	Mold	15	11	84	3	18	7	
Feces	10 ⁻⁵	200	180	150	200	500	1	48	89	90	120	NS	NS	NS	NS	
B Areas																
Scalp	10 ⁻³		63	0						1					7	
Mouth	10 ⁻⁵		300	350						79					34	
Forearm	10 ⁻³		0	0						1					4	
Glans penis	10 ⁻⁴		500	10						3					3	
Toes	10 ⁻³		400	79						195					14	

X = Spreader

NS = No Sample

TABLE 7 --- Continued

Subject 21

Body Area	Dilution	Sampling Period															
		1	2	3	4	5	6	7	8	9	10	11	12	13	14	15	16
<u>A Areas</u>																	
Ear	10 ⁻³	309	402	46	29	40	122	276	106	125	600	350	401	472	740	400	69
Nose	10 ⁻³	102	1	0	315	tntc	397	528	tntc	408	700	147	401	400	659	88	tntc
Mouth	10 ⁻⁵	208	353	303	205	tntc	300	tntc	250	113	259	225	133	191	96	330	tntc
Throat	10 ⁻⁴	68	138	89	29	262	131	93	125	116	184	tntc	170	174	42	114	279
Axilla	10 ⁻³	300	0	300	65	tntc	300	tntc	tntc	454	tntc	tntc	tntc	tntc	tntc	tntc	tntc
Groin	10 ⁻⁴	435	57	328	1	tntc	23	tntc	tntc	tntc	tntc	tntc	tntc	tntc	tntc	tntc	tntc
Glans penis	10 ⁻⁴	26	1	0	1	6	8	56	139	46	52	64	52	92	342	260	7
Feces	10 ⁻⁵	35	185	15	10	26	66	15	22	9	2	30	12	5	38		
<u>B Areas</u>																	
Scalp	10 ⁻³	5	0								5					7	
Eye	10 ⁻³	0	1								0					0	
Forearm	10 ⁻³	0	0								5					2	
Umbilicus	10 ⁻³	11	0								0					7	
Anal fold	10 ⁻⁴	400	57								255					500	
Toes	10 ⁻³	300	tntc								tntc					tntc	

tntc = To numerous to count

TABLE 7 --- Continued
Subject 22

Body Area	Dilution	Sampling Period															
		1	2	3	4	5	6	7	8	9	10	11	12	13	14	15	16
<u>A Areas</u>																	
Ear	10 ⁻³	0	300	0	1	n.g.	0	13	1	80	3	1	2	0	6	0	
Nose	10 ⁻³	351	75	300	2	340	500	500	500	403	500	183	212	196	tntc	42	
Mouth	10 ⁻⁵	252	400	209	67	tntc	320	tntc	tntc	tntc	211	125	260	21	60	230	
Throat	10 ⁻⁴	350	600	290	37	tntc	198	250	200	133	263	500	521	190	tntc	300	
Axilla	10 ⁻³	91	11	37	0	2	400	72	116	19	30	4	148	tntc	665	500	
Groin	10 ⁻⁴	113	186	229	1	tntc	232	tntc	64	429	tntc	tntc	tntc	tntc	tntc	tntc	
Glans penis	10 ⁻⁴	115	202	355	0	268	262	267	125	46	111	300	tntc	174	114	198	
Feces	10 ⁻⁵	187	52	381	318	tntc	308	300	133	275	tntc	218	tntc	118	225		
<u>B Areas</u>																	
Scalp	10 ⁻³	11	5								6					134	
Eye	10 ⁻³	1	0								1					0	
Forearm	10 ⁻³	28	0								0					0	
Umbilicus	10 ⁻³	15	0								7					268	
Anal fold	10 ⁻⁴	455	tntc								213					518	
Toes	10 ⁻³	220	0								tntc					tntc	

tntc = To numerous to count
n. g. = No growth

TABLE 7 --- Continued
Subject 23

Body Area	Dilution	Sampling Period															
		1	2	3	4	5	6	7	8	9	10	11	12	13	14	15	16
<u>A Areas</u>																	
Ear	10 ⁻³	0	0	0	0	0	6	33	45	21	42	18	165	27	18	23	106
Nose	10 ⁻³	1	10	4	6	32	53	92	77	54	27	50	5	13	46	76	11
Mouth	10 ⁻⁵	500	163	312	130	tntc	250	900	900	450	tntc	190	540	tntc	270	19	676
Throat	10 ⁻⁴	305	tntc	750	96	tntc	328	105	500	tntc	436	250	182	178	340	363	331
Axilla	10 ⁻³	3	5	0	0	268	250	200	750	250	140	600	363	102	217	500	38
Groin	10 ⁻⁴	835	247	61	5	tntc	240	435	tntc	tntc	tntc	tntc	tntc	575	875	335	325
Glans penis	10 ⁻⁴	54	4	95	0	56	165	106	116	40	56	tntc	128	247	100	15	106
Feces	10 ⁻⁵	41	n.g.	6	35	56	114	n.g.	5	130	23	34	228	26	32		
<u>B Areas</u>																	
Scalp	10 ⁻³	2	1								42					5	
Eye	10 ⁻³	0	0								35					7	
Forearm	10 ⁻³	13	2								12					3	
Umbilicus	10 ⁻³	17	15								0					11	
Anal fold	10 ⁻⁴	19	52								589					800	
Toes	10 ⁻³	93	75								n.s.					n.s.	

tntc = To numerous to count
n.g. = No growth
n.s. = No sample

TABLE 7 --- Continued
Subject 24

Body Area	Dilution	Sampling Period															
		1	2	3	4	5	6	7	8	9	10	11	12	13	14	15	16
<u>A Areas</u>																	
Ear	10 ⁻³	3	15	2	0	2	1	0	360	4	22	10	3	0	58	8	0
Nose	10 ⁻³	141	85	243	11	54	72	150	69	145	166	118	195	71	210	98	130
Mouth	10 ⁻⁵	274	358	507	200	tntc	503	tntc	248	162	524	200	258	86	52	84	310
Throat	10 ⁻⁴	1000	905	400	114	tntc	550	148	511	tntc	390	300	185	316	257	550	56
Axilla	10 ⁻³	500	250	19	80	16	450	312	500	tntc	550	tntc	650	625	tntc	650	tntc
Groin	10 ⁻⁴	71	840	1150	2	45	80	374	tntc	193	525	800	258	94	277	86	165
Glans penis	10 ⁻⁴	92	109	675	0	2	36	47	500	36	40	225	220	75	448	161	22
Feces	10 ⁻⁵	125	72	33	217	42	70	100	n.s.	2000	500	206	n.s.	33	480		
<u>B Areas</u>																	
Scalp	10 ⁻³	10	n.g.								24					42	
Eye	10 ⁻³	6	13								3					18	
Forearm	10 ⁻³	53	1								1					7	
Umbilicus	10 ⁻³	0	1								0					90	
Anal fold	10 ⁻⁴	230	tntc								99					500	
Toes	10 ⁻³	350	tntc								n.s.					n.s.	

tntc = To numerous to count
n.g. = No growth
n.s. = No sample

TABLE 7 --- Continued
Subject 25

Body Area	Dilution	Sampling Period															
		1	2	3	4	5	6	7	8	9	10	11	12	13	14	15	16
<u>A Areas</u>																	
Ear	10 ⁻³	1	42	9	2	350	tntc	500	5000	1530	2200	3710	1020	5000	8580	2980	4600
Nose	10 ⁻³	3	77	13	78	15	465	268	1590	150	200	250	490	300	350	800	153
Mouth	10 ⁻⁵	96	3	75	8	30	54	181	128	83	185	215	17	3	46	146	127
Throat	10 ⁻⁴	439	159	380	500	126	190	500	231	1070	2400	7	30	2	206	81	19
Axilla	10 ⁻³	17	17	2	6	44	500	2	640	2700	580	12	23	10	10	0	30
Groin	10 ⁻⁴	0	33	0	37	55	tntc	590	613	241	1060	158	1310	3540	1990	2040	1350
Glans penis	10 ⁻⁴	0	7	0	14	3	21	28	16	3	35	194	118	147	421	12	15
Feces	10 ⁻⁵	2	1	1	2	1	2	1	41	2	4	17	17	6	7		
<u>B Areas</u>																	
Scalp	10 ⁻³	2							0								81
Eye	10 ⁻³	0							0								0
Forearm	10 ⁻³	0							3								0
Umbilicus	10 ⁻³	0							0								3
Anal fold	10 ⁻⁴	500							551								tntc
Toes	10 ⁻³	943							tntc								tntc

tntc = Too numerous to count

Note: 0.1 cc from these dilutions spread on plate

TABLE 7 ---- Continued
Subject 26

Body Area	Dilution	Sampling Period															
		1	2	3	4	5	6	7	8	9	10	11	12	13	14	15	16
<u>A Areas</u>																	
Ear	10 ⁻³	1000	tntc	tntc	tntc	540	tntc	2000	500	690	3160	440	tntc	3000	2000	5410	14400
Nose	10 ⁻³	3	155	2	94	6	256	98	78	123	69	87	63	334	121	17	54
Mouth	10 ⁻⁵	67	24	15	12	5	7	12	22	27	196	55	75	17	19	85	50
Throat	10 ⁻⁴	802	174	140	220	159	X	204	300	210	1120	1070	430	70	2780	420	136
Axilla	10 ⁻³	1	400	5	2	448	214	1000	120	540	242	3100	180	7920	5470	7500	6840
Groin	10 ⁻⁴	0	550	470	700	tntc	tntc	1500	tntc	tntc	16700	15300	4400	6820	1160	740	670
Glans penis	10 ⁻⁴	0	17	6	42	1	8	18	59	44	22	62	26	190	820	34	8
Feces	10 ⁻⁵	1	1	5	1	3	1	1	1	1	1	0	1	2	5		
<u>B Areas</u>																	
Scalp	10 ⁻³	0							3								340
Eye	10 ⁻³	0							1								1
Forearm	10 ⁻³	0							0								48
Umbilicus	10 ⁻³	0							0								3
Anal fold	10 ⁻⁴	201							51								tntc
Toes	10 ⁻³	500							2000								tntc

X = Spreader

tntc = Too numerous to count

Note: 0.1 cc from these dilutions spread on plates

TABLE 7 --- Continued

Subject 27

Body Area	Dilution	Sampling Period															
		1	2	3	4	5	6	7	8	9	10	11	12	13	14	15	16
<u>A Areas</u>																	
Ear	10 ⁻³	46	284	tntc	tntc	tntc	tntc	tntc	4800	4350	14180	39600	14800	36700	19800	25000	28000
Nose	10 ⁻³	163	308	217	468	218	tntc	tntc	1100	1720	990	1003	610	1700	580	74	92
Mouth	10 ⁻⁵	37	24	157	148	13	9	53	145	100	322	63	33	102	86	53	249
Throat	10 ⁻⁴	1600	346	210	143	336	329	116	389	1370	2970	1440	1440	50	770	930	180
Axilla	10 ⁻³	5	154	5	27	56	149	850	1440	75	2670	340	70	730	490	209	340
Groin	10 ⁻⁴	0	83	1	15	tntc	tntc	632	376	260	3600	2100	1180	850	574	1240	240
Glans penis	10 ⁻⁴	0	0	22	50	0	51	286	390	2700	1280	460	113	876	452	647	181
Feces	10 ⁻⁵	3	156	360	432	270	520	1600	70	308	140	152	306	71	166		
<u>B Areas</u>																	
Scalp	10 ⁻³	11							143								52
Eye	10 ⁻³	0							1								0
Forearm	10 ⁻³	0							1								0
Umbilicus	10 ⁻³	1							0								110
Anal fold	10 ⁻⁴	430							330								310
Toes	10 ⁻³	500							2000								tntc

tntc = Too numerous to count

Note: 0.1 cc from these dilutions spread on plate

TABLE 7 ---- Continued

Subject 28

Body Area	Dilution	Sampling Period															
		1	2	3	4	5	6	7	8	9	10	11	12	13	14	15	16
<u>A Areas</u>																	
Ear	10 ⁻³	0	8	0	2	5	0	40	56	5	5	214	90	20	10	0	2
Nose	10 ⁻³	2	17	19	65	104	327	41	83	1470	700	15	90	30	46	352	13
Mouth	10 ⁻⁵	77	30	70	10	24	27	28	160	266	69	297	62	30	202	191	425
Throat	10 ⁻⁴	270	357	220	60	200	293	83	623	730	446	750	700	800	382	2120	609
Axilla	10 ⁻³	0	229	2	509	800	tntc	800	70	648	1820	670	122	199	3700	720	1500
Groin	10 ⁻⁴	0	3	0	39	800	240	231	355	441	217	123	71	2270	410	250	450
Glans penis	10 ⁻⁴	0	0	0	5	0	3	16	2	31	6	12	1	6	18	4	8
Feces	10 ⁻⁵	1	1	1	50	54	26	11	70	45	2	2	4	15	4		
<u>B Areas</u>																	
Scalp	10 ⁻³	1							4								4
Eye	10 ⁻³	3							1								0
Forearm	10 ⁻³	1							1								4
Umbilicus	10 ⁻³	1							0								0
Anal fold	10 ⁻⁴	4							100								62
Toes	10 ⁻³	1400							1700								tntc

tntc = Too numerous to count

Note: 0.1 cc from these dilutions spread on plate

TABLE 7 --- Continued

Subject 29

Body Area	Dilution	Sampling Period																
		1	2	3	4	5	6	7	8	9	10	11	12	13	14	15	16	
<u>A Areas</u>																		
Ear	10 ⁻⁴	1500	320	380	130	230	780	70	440	830	460	79	660	6	77	180	360	
Nose	10 ⁻⁴	560	39	448	520	500	152	220	37	147	182	400	230	940	1181	131	260	
Mouth	10 ⁻⁴	9100	23000	1160	8600	2900	14700	16100	9900	1700	6100	10800	17800	16200	13700	6700	790	
Throat	10 ⁻⁴	23500	320	1090	210	5600	2210	20000	250	90	3730	530	2140	1640	614	2690	1230	
Axilla	10 ⁻⁴	325	5030	1	5160	5420	2520	1140	5920	3780	5840	3350	1130	5490	2140	5230	3500	
Groin	10 ⁻⁴	105	840	480	5500	9100	800	3500	9800	5280	tntc	tntc	13300	65000	90100	35500	35000	
Glans penis	10 ⁻⁴	2	0	4	1190	120	52	136	3030	320	4750	189	191	3400	266	74	650	
Feces	10 ⁻⁴	0	200	1200	5500	400	4000	4100	900	400	200	2200	200	100	200			
<u>B Areas</u>																		
Scalp	10 ⁻⁴	35								48							31	
Eye	10 ⁻⁴	0								0							0	
Forearm	10 ⁻⁴	2								2							8	
Umbilicus	10 ⁻⁴	1								35							120	
Anal fold	10 ⁻⁴	5100								32900							16200	
Toes	10 ⁻⁴	5400								NS*							80000	22100

Incubator not working properly at 10th sampling period for feces, 11th for body areas.
 Liquid diet started 0800 Tuesday, Apr. 27, date for feces sample #8
 * No sample

TABLE 7 --- Continued
Subject 30

Body Area	Dilution	Sampling Period														
		1	2	3	4	5	6	7	8	9	10	11	12	13	14	15
<u>A Areas</u>																
Ear	10 ⁻⁴	0	1	0	4	0	0	2	1	0	1	50	3	7	230	10
Nose	10 ⁻⁴	420	89	225	285	33	10	222	22	52	34	33	328	120	202	318
Mouth	10 ⁻⁴	4200	2300	3700	1900	3400	1390	7800	14000	3600	3300	24700	1200	24500	36700	1700
Throat	10 ⁻⁴	26400	9800	8700	6800	510	270	1750	2560	243	492	129	5510	1230	4720	3840
Axilla	10 ⁻⁴	2220	3620	5	1790	3000	3750	80	7060	2880	3960	3500	3370	4400	tmc	1700
Groin	10 ⁻⁴	507	510	1610	1980	1430	1864	1340	7000	3500	3350	1150	4900	Contam	4900	46400
Glans penis	10 ⁻⁴	107	48	0	2330	2830	350	850	1570	4400	820	460	2850	2900	470	3800
Feces	10 ⁻⁴	200	300	100	23400	1700	12200	Skip- ped	16800	900	2200	1400	4000	300		
<u>B Areas</u>																
Scalp	10 ⁻⁴	5							40							50
Eye	10 ⁻⁴	0							0							0
Forearm	10 ⁻⁴	0							0							6
Umbilicus	10 ⁻⁴	5							7							0
Anal fold	10 ⁻⁴	4400							11000							40900
Toes	10 ⁻⁴	7250							30500							5900

Incubator not working properly at 10th sampling period for feces, 11th for body areas.
Liquid diet started 0800 Tues., Apr. 27, date for feces sample #8

TABLE 7 --- Continued

Subject 31

Body Area	Dilution	Sampling Period															
		1	2	3	4	5	6	7	8	9	10	11	12	13	14	15	16
<u>A Areas</u>																	
Ear	10 ⁻⁴	5020	613	565	3200	5020	630	4700	5550	6400	3740	270	73	380	1500	50	1340
Nose	10 ⁻⁴	10	140	20	58	20	5	73	23	75	54	56	350	370	210	220	470
Mouth	10 ⁻⁴	15400	12200	1200	900	1450	19600	4600	20500	49000	39100	5000	36000	54000	30500	7600	17000
Throat	10 ⁻⁴	1950	5400	390	3700	2200	900	7200	2500	12500	1420	5500	2420	5550	6850	5460	2900
Axilla	10 ⁻⁴	630	3040	500	127	1820	840	9800	5560	3070	3530	4380	2000	4910	1780	4850	2750
Groin	10 ⁻⁴	900	2010	1870	2510	1990	1950	4960	8440	8000	8250	3800	1900	3850	3500	22000	36800
Glans penis	10 ⁻⁴	339	308	0	730	260	430	880	390	3750	6400	1800	400	5750	1700	2250	5100
Feces	10 ⁻⁴	400	400	2000	18500	19200	80000	9900	2600	1800	700	12400	300	700	1400		
<u>B Areas</u>																	
Scalp	10 ⁻⁴	89								7							4
Eye	10 ⁻⁴	1								0							0
Forearm	10 ⁻⁴	1								0							35
Umbilicus	10 ⁻⁴	2								72							225
Anal fold	10 ⁻⁴	1400								5200							11000
Toes	10 ⁻⁴	8500								8700							60000

Incubator not working properly at 10th sampling period for feces; 11th for body areas
 *Liquid diet started 0800 Tues. Apr. 27, date for feces sample #8

TABLE 7 --- Continued

Subject 32

Body Area	Dilution	Sampling Period															
		1	2	3	4	5	6	7	8	9	10	11	12	13	14	15	16
<u>A Areas</u>																	
Ear	10 ⁻⁴	206	610	474	620	270	1240	22	120	3	200	15	53	230	670	110	2600
Nose	10 ⁻⁴	35	19	570	450	155	153	130	120	101	150	78	37	180	80	168	260
Mouth	10 ⁻⁴	720	2500	15100	12100	830	11800	9400	2560	5800	2500	25500	6400	2400	3550	7700	1830
Throat	10 ⁻⁴	2500	630	30	100	740	280	1700	21000	580	970	351	1410	2370	1150	480	390
Axilla	10 ⁻⁴	48	1410	5	220	4520	6600	2800	2860	1650	4750	3400	6800	5840	3300	9500	5250
Groin	10 ⁻⁴	840	1900	214	3420	1690	3120	1590	3500	3260	5500	5580	3500	2400	1200	1330	3900
Glans penis	10 ⁻⁴	245	970	0	3720	1960	1740	330	175	342	3580	1400	2200	600	1020	570	360
Feces	10 ⁻⁴	700	0	2300	11700	1400	10200	11100	2400	1800	7100	1400	2900	100	100		
<u>B Areas</u>																	
Scalp	10 ⁻⁴	30								24							50
Eye	10 ⁻⁴	0								0							0
Forearm	10 ⁻⁴	0								0							0
Umbilicus	10 ⁻⁴	1								45							20
Anal fold	10 ⁻⁴	4800								10300							400
Toes	10 ⁻⁴	248								1200							37500

Incubator not working properly at 10th sampling period for feces, 11th for body areas. Liquid diet started 0800 Tuesday, April 27, date for feces sample #8.

TABLE 7 --- Continued

Subject 33

Body Area	Dilution	Sampling Period															
		1	2	3	4	5	6	7	8	9	10	11	12	13	14	15	16
<u>A Areas</u>																	
Nose	10 ⁻⁴	224	167	100	130	303	100	21	3190	23	43	2800	3300				
Gingival	10 ⁻⁴	810	13	20	2	6	133	158	970	380	103	49	880				
Throat	10 ⁻⁴	590	670	8600	1950	2720	1050	Cont.	5530	3260	1210	1590	1760				
Axilla	10 ⁻⁴	21	>8000	1320	3750	10000	4550	1300	>5000	7920	870	4700	>3000				
Groin	10 ⁻⁴	2380	6550	5400	25100	10300	3680	7200	10000	69700	14000	72400	15500				
Glans penis	10 ⁻⁴	1	144	1	36	12	34	28	381	1810	318	753	850				
Anal fold	10 ⁻⁴	1200	5630	1650	28000	5000	11600	3700	1810	6120	2400	7030	2840				
Feces	10 ⁻⁶	141	153	217	131	105	> 511	147	95	579	187	165	399				
Toes	10 ⁻⁴	5500	>14000	n.s. sweat test	5000	n.s. sweat test	3400	7800	39600	22500	47400	110000	45000				
<u>B Areas</u>																	
Scalp	10 ⁻⁴		21							280			760				
Ear	10 ⁻⁴		1							250			151				
Eye	10 ⁻⁴		5							1			3				
Forearm	10 ⁻⁴		1							179			>527				
Umbilicus	10 ⁻⁴		2450							8670			>4290				
Electrode	10 ⁻⁴		not wired							1			400				

Feces - additional count taken prior to start of experiment - 275

Electrode - 3B-285
n.s. = no sample

TABLE 7 --- Continued
Subject 34

Body Area	Dilution	Sampling Period															
		1	2	3	4	5	6	7	8	9	10	11	12	13	14	15	16
<u>A Areas</u>																	
Nose	10 ⁻⁴	4	11	11	116	4	63	44	115	176	340	540	300				
Gingival	10 ⁻⁴	1000	200	7400	3050	300	430	3510	2270	1240	tntc	3400	1670				
Throat	10 ⁻⁴	15200	24000	3600	42200	1900	1180	8900	7780	7300	7000	60	5400				
Axilla	10 ⁻⁴	222	149	140	8700	4070	174	644	8330	6180	tntc	780	4130				
Groin	10 ⁻⁴	1110	3280	4350	6320	23300	2070	4750	6950	3050	6700	15500	15300				
Glans penis	10 ⁻⁴	201	52	265	265	190	520	415	9420	3600	1005	4530	2830				
Anal fold	10 ⁻⁴	262	580	470	3800	930	600	420	5610	3320	13500	3940	>4500				
Feces	10 ⁻⁶	>774	7570	101	>650	204	>420	156	128	170	222	142	289				
Toes	10 ⁻⁴	2800	4300	n. s. sweat test	5060	n. s. sweat test	100	3400	21400	2800	5600	1700	12500				
<u>B Areas</u>																	
Scalp	10 ⁻⁴		95							495			105				
Ear	10 ⁻⁴		6000							148			40				
Eye	10 ⁻⁴		1							4			11				
Forearm	10 ⁻⁴		0							23			89				
Umbilicus	10 ⁻⁴		1							600			70				
Electrode	10 ⁻⁴		not wired							177			2120				

Feces - additional count taken prior to start of experiment - 7671
Electrode - 3B->354

TABLE 7 --- Continued
Subject 35

Body Area	Dilution	Sampling Period															
		1	2	3	4	5	6	7	8	9	10	11	12	13	14	15	16
<u>A Areas</u>																	
Nose	10 ⁻⁴	230	32	185	164	83	1110	313	98	82	580	124	4200				
Gingival	10 ⁻⁴	1110	0	50	530	1500	3250	220	310	2640	8000	500	1940				
Throat	10 ⁻⁴	10000	1500	4200	2100	1740	2900	2180	6300	4030	4180	3950	4900				
Axilla	10 ⁻⁴	1040	4110	1280	2490	5140	2140	2960	6400	contam	960	6460	>6020				
Groin	10 ⁻⁴	130	2900	2470	13700	540	930	6650	12000	22500	22000	5000	11800				
Glans penis	10 ⁻⁴	44	1250	415	296	1280	140	490	1270	1850	600	440	650				
Anal fold	10 ⁻⁴	3510	tntc	7700	28600	6300	1200	18800	15500	5000	32500	6700	18100				
Feces	10 ⁻⁶	236	>1500	59	>800	90	166	>296	>900	n. s.	39	194	>900				
Toes	10 ⁻⁴	5700	>16000	38700	45500	55000	118000	40000	91000	70000	127000	175000	92000				
<u>B Areas</u>																	
Scalp	10 ⁻⁴		78							270			>4210				
Ear	10 ⁻⁴		2500							692			910				
Eye	10 ⁻⁴		4							0			0				
Forearm	10 ⁻⁴		0							0			0				
Umbilicus	10 ⁻⁴		2860							2750			11				
Electrode	10 ⁻⁴		not wired							0			890				

Feces - additional count taken prior to start of experiment - 365

Electrode - 3B tntc

NS = No Sample

TABLE 7 --- Concluded
Subject 36

Body Area	Dilution	Sampling Period															
		1	2	3	4	5	6	7	8	9	10	11	12	13	14	15	16
<u>A Areas</u>																	
Nose	10 ⁻⁴	230	394	920	710	8680	454	1150	677	2390	2670	2040	1740				
Gingival	10 ⁻⁴	3900	1060	6770	570	300	460	530	290	1230	520	4200	1060				
Throat	10 ⁻⁴	4100	7900	360	6750	tntc	6700	3600	18400	1250	1800	1000	2150				
Axilla	10 ⁻⁴	0	670	1450	X	4480	58	130	3260	123	250	175	2640				
Groin	10 ⁻⁴	2120	2050	5760	>8000	4100	2040	2750	8800	17800	4800	3500	14000				
Glans penis	10 ⁻⁴	X	X	X	100	760	84	>530	3700	>838	182	>623	>980				
Anal fold	10 ⁻⁴	2450	990	2800	12900	1050	6630	2230	tntc	1400	1070	18500	18600				
Feces	10 ⁻⁶	331	>546	134	>900	>372	>438	282	408	tntc	333	>464	450				
Toes	10 ⁻⁴	X	X	X	X	X	64000	22000	X	71000	246000	48000	78000				
<u>B Areas</u>																	
Scalp	10 ⁻⁴		57							104			80				
Ear	10 ⁻⁴		3270							>5150			>4400				
Eye	10 ⁻⁴		0							2			0				
Forearm	10 ⁻⁴		1							1			40				
Umbilicus	10 ⁻⁴		11							3920			210				
Electrode	10 ⁻⁴		not wired							1			tntc				

Feces - additional count taken prior to start of experiment - >525

Electrode - 3 tntc

X = Spreader

Electrode - 3 B tntc

TABLE 8. AEROBIC BACTERIAL COUNT FROM AXILLA AND GROIN
EXPERIMENT V

		Sampling Period													
		1	2	3	4	5	6	7	8	9	10	11	12	13	14
17	Axilla	20	8	1	0	150	33	3	12	5	25	15	18	13	18
	Groin	500	500	51	200	500	300	320	500	500	500	250	140	115	250
18	Axilla	16	1	1	0	3	6	3	7	8	7	5	5	mold	0
	Groin	500	200	50	4	0	250	100	58	100	100	240	310	270	250
19	Axilla	250	100	10	0	500	90	300	150	81	10	21	18	23	32
	Groin	600	300	70	10	0	200	30	71	300	28	146	10	X	0
20	Axilla	106	250	141	61	200	200	X	56	400	165	70	200	10	81
	Groin	500	300	4	4	0	250	2	250	2	23	50	3	X	0

X = Spreader

TABLE 8 ---- Continued
EXPERIMENT VI

		Sampling Period															
		1	2	3	4	5	6	7	8	9	10	11	12	13	14	15	16
21	Axilla	300	0	300	65	tntc	300	tntc	tntc	454	tntc	tntc	tntc	tntc	tntc	tntc	tntc
	Groin	435	57	328	1	tntc	23	tntc	tntc	tntc	tntc	tntc	tntc	tntc	tntc	tntc	tntc
22	Axilla	91	11	37	0	2	400	72	116	19	30	4	148	tntc	665	500	
	Groin	113	186	229	1	tntc	232	tntc	64	429	tntc	tntc	tntc	tntc	tntc	tntc	
23	Axilla	3	5	0	0	268	250	200	750	250	140	600	363	102	217	500	38
	Groin	835	247	61	5	tntc	240	435	tntc	tntc	tntc	tntc	tntc	575	875	335	325
24	Axilla	500	250	19	80	16	450	312	500	tntc	550	tntc	650	625	tntc	650	tntc
	Groin	71	840	1150	2	45	80	374	tntc	193	525	800	258	94	277	86	165

tntc = Too numerous to count

TABLE 8 --- Continued
EXPERIMENT VII

		Sampling Period															
		1	2	3	4	5	6	7	8	9	10	11	12	13	14	15	16
25	Axilla	170	170	20	60	440	5000	20	6400	27000	5800	120	230	100	100	0	300
	Groin	0	330	0	370	550	tntc	5900	6130	2410	10600	1580	13100	35400	19900	20400	13500
26	Axilla	10	4000	50	20	4400	2140	10000	1200	5400	2420	31000	1800	79200	54700	75000	68400
	Groin	0	550	470	700	tntc	tntc	1500	tntc	tntc	16700	15300	4400	6820	1160	740	670
27	Axilla	50	1540	50	270	560	1490	8500	14400	750	26700	3400	700	7300	4900	2090	3400
	Groin	0	83	1	15	tntc	tntc	632	376	260	3600	2100	1180	850	574	1240	240
28	Axilla	0	2290	20	5090	8000	tntc	8000	700	6480	18200	6700	1220	1990	37000	7200	1500
	Groin	0	3	0	39	800	240	231	355	441	217	123	71	2270	410	250	450

tntc = Too numerous to count

TABLE 8 --- Continued

EXPERIMENT VIII

		Sampling Period															
		1	2	3	4	5	6	7	8	9	10	11	12	13	14	15	16
29	Axilla	325	5030	1	5160	5420	2520	1140	5920	3780	5840	3350	1130	5490	2140	5230	3500
	Groin	105	840	480	5500	9100	800	3500	9800	5280	tntc	tntc	13300	65000	90100	35500	35000
30	Axilla	2220	3620	5	1790	3000	3750	80	181	7060	2880	3960	3500	3370	4400	tntc	1700
	Groin	507	510	1610	1980	1430	1864	1340	1050	7000	3500	3350	1150	4900	Contam	4900	46400
31	Axilla	630	3040	500	127	1820	840	9800	5560	3070	3530	4380	2000	4910	1780	4850	2750
	Groin	900	2010	1870	2510	1990	1950	4960	8440	8000	8250	3800	1900	3850	3500	22000	36800
32	Axilla	48	1410	5	220	4520	6600	2800	2860	1650	4750	3400	6800	5840	3300	9500	5250
	Groin	840	1900	214	3420	1690	3120	1590	3500	3260	5500	5580	3500	2400	1200	1330	3900

tntc = Too numerous to count

TABLE 8 --- Concluded

EXPERIMENT IX

		Sampling Period											
		1	2	3	4	5	6	7	8	9	10	11	12
33	Axilla	21	78000	1320	1550	9680	4550	1300	6000	7920	870	4700	> 3000
	Groin	2380	6550	5400	25100	10300	3680	7200	10000	69700	14000	72400	15500
34	Axilla	222	149	140	~9000	4070	174	644	8330	~7000	tntc	780	4130
	Groin	1110	3280	2960	6520	23300	2070	4750	6950	3060	6700	15500	15300
35	Axilla	1040	4110	1280	2490	5140	2140	2960	~6400	Contam	960	7000	> 6020
	Groin	130	2900	2470	13700	540	930	6650	~12000	22500	22000	5000	11800
36	Axilla	N. G.	670	1450	X	4480	58	130	3260	123	250	175	2640
	Groin	2120	2050	5760	8000	4100	2040	2750	8800	17800	4800	3500	14000

X = Spreader
 N. G. = no growth
 tntc = too numerous to count

TABLE 9. OCCURRENCE OF STREPTOCOCCI
EXPERIMENT V

Subject	Body Area	Sampling Period															
		1	2	3	4	5	6	7	8	9	10	11	12	13	14	15	16
17	Throat	salivarius		salivarius	mitis	salivarius	mitis	mitis	salivarius	mitis	mitis	mitis	salivarius mitis	mitis			
	Mouth			mitis	mitis												
	Adilla			salivarius		enterococci											
	Feces	enterococci															
18	Umbilicus					enterococci											
	Throat			mitis	mitis	salivarius	mitis	mitis	mitis	mitis	mitis	mitis	mitis	mitis			
	Mouth	mitis			mitis												
	Nose				mitis												
19	Feces				bovis	salivarius	mitis	mitis	mitis	mitis	mitis	mitis	mitis	mitis	mitis	mitis	mitis
	Feces				mitis	salivarius	mitis	mitis	mitis	mitis	mitis	mitis	mitis	mitis	mitis	mitis	mitis
	Nose				bovis	salivarius	mitis	mitis	mitis	mitis	mitis	mitis	mitis	mitis	mitis	mitis	mitis
	Anal fold				mitis	salivarius	mitis	mitis	mitis	mitis	mitis	mitis	mitis	mitis	mitis	mitis	mitis
20	Groin					enterococci											
	Throat					enterococci											
	Feces	enterococci		enterococci		enterococci											
	Anal fold					mitis	mitis	mitis	mitis	mitis	mitis	mitis	mitis	mitis	mitis	mitis	mitis

TABLE 9 --- Continued
EXPERIMENT VI*

Subject No.	Body Area	VERIDANS GROUP										ENTEROCOCCUS GROUP					LACTIC GROUP									
		Salvarius			Mitis			Bovis		Equinus		Thermophilus		Ubersis		Fusalis			Liquefactions	Zymogenus	Durans	Lactis	Cremoris			
21	Nose	Bio. M.S.				3																				
	Mouth	Bio. M.S.	1, 2, 5, 7, 9, 11, 14, 15			1, 12																				
		M.S.	1, 2, 3, 4, 5, 6, 7, 8, 9, 10, 12, 13, 14, 15, 16			1, 2, 4, 5, 6, 7, 8, 9, 10, 11, 12, 13, 14, 15, 16																				
	Throat	Bio. M.S.	1, 9, 12			4, 7, 14																				
	M.S.	2, 4, 6, 7, 8, 10, 11, 12, 13, 14, 15, 16			1, 2, 4, 5, 6, 7, 8, 9, 10, 12, 13, 14, 15, 16																					
Anal	Bio. M.S.																									
	M.S.	8, 10																								
Feces	Bio. M.S.																									
	M.S.	8, 10																								
22	Nose	Bio. M.S.																								
	Mouth	Bio. M.S.	1, 5, 6, 11, 12, 14, 15			6, 8, 25																				
		M.S.	1, 2, 3, 4, 5, 6, 7, 8, 10, 11, 12, 13			2, 6, 7, 8, 9, 10, 11, 12, 13, 14, 15																				
	Throat	Bio. M.S.	1, 14			4, 6, 7, 11, 12																				
	M.S.	1, 2, 3, 4, 5, 6, 7, 8, 9, 10, 11, 12, 13, 14, 15, 16			1, 2, 3, 4, 5, 6, 7, 8, 9, 10, 11, 12, 13, 14, 15, 16																					
Anal	Bio. M.S.																									
	M.S.																									
Feces	Bio. M.S.																									
	M.S.																									

Each number represents one culture and sampling time of recovery.

Bio. = Biochemical identification

M.S. = Mixis Salvarius Medium, Identification

1. Only 2 species, 1 group

[Mitis

Salvarius

Enterococcus Group

Enterococcus Group

Enterococcus Group

*Work performed by A. West, Microbiologist, AMRL, Wright-Patterson AFB, Dayton, Ohio.

TABLE 9 ---- Continued

Subject No.	Body Area	VERIDANS GROUP										ENTEROCOCCUS GROUP					LACTIC GROUP	
		Salvarius	Mitis	Bovis	Equinus	Thermophilus	Uberis	Faecalis	Lapsacicus	Zymogenus	Durans	Lentis	Cremoris					
23	Nose	Bio. 1, 9, 12, 15										6, 7, 14						
		M.S. 2, 3, 4, 5, 12, 13	15 2, 3, 4, 5, 6, 7, 8, 10, 13, 14, 15, 16															
	Mouth	Bio. 1, 7, 8, 12, 13, 14	11, 12															
		M.S. 1, 2, 3, 4, 5, 6, 7, 8, 10, 11, 12, 13, 14, 15, 16	11, 12 2, 3, 4, 5, 6, 7, 8, 9, 10, 11, 12, 13, 14, 15, 16				11											
	Throat	Bio. 1, 7, 8, 12, 13, 14	11, 12															
		M.S. 1, 2, 3, 4, 5, 6, 7, 8, 10, 11, 12, 13, 14, 15, 16	11, 12 2, 3, 4, 5, 6, 7, 8, 9, 10, 11, 12, 13, 14, 15, 16															
24	Anal	Bio. 1																
		M.S. 7, 8, 9, 10	5, 9															
	Feces	Bio. 1																
		M.S. 4, 5, 10, 14, 15	5, 9 4, 5, 10, 14, 15															
	Nose	Bio. 1, 5, 7, 8, 10, 11, 12, 13, 15	9, 12															
		M.S. 1, 4, 6, 8, 10, 18	9, 4, 5, 6, 7, 8, 9, 10, 12, 13, 14, 15, 16															
25	Mouth	Bio. 11, 14, 15																
		M.S. 1, 2, 3, 4, 5, 6, 7, 8, 9, 10, 11, 12, 13, 14, 15,	1, 2, 3, 4, 5, 6, 7, 8, 9, 10, 11, 12, 13, 14, 15, 16															
	Throat	Bio. 1, 2, 3, 4, 5, 6, 7, 8, 9, 10, 11, 12, 13, 14, 15,	1, 2, 3, 4, 5, 6, 7, 8, 9, 10, 11, 12, 13, 14, 15, 16															
		M.S. 11	11															
26	Anal	Bio. 1																
		M.S. 11	11															
27	Feces	Bio. 1																
		M.S. 11	11															

Each number represents one culture and sampling date of recovery.

Bio. = Biochemical Identification
M.S. = Mitis Salvarius Medium, Identification

1. Only 2 species, 1 group

Mitis
 Salvarius
 Enterococcus Group
 Enterococcus Group

**TABLE 9 --- Continued
EXPERIMENT VII***

Subject No.	Body Area	VERIDANS GROUP										ENTEROCOCCUS GROUP				LACTIC GROUP		
		Salvarius	Milis	Bovis	Equinus	Thermophilus	Uberis	Faecalis	Lipofaciens	Zymogenes	Durcas	Lactis	Cremoris					
25	None	9									14							
	M.S.																	
	Bio.	1, 2, 3, 4, 5, 6, 7, 8, 9, 10, 11, 12, 13, 14, 15, 16	4, 5, 6, 7, 8, 9, 10, 12, 13, 14, 15															
	Mouth	16, 17, 18, 19, 20	3, 4, 5, 6, 7, 9, 10, 12, 13, 14, 15															4, 9
	M.S.	3, 5, 7, 10	3, 4, 5, 6, 7, 9, 10, 12, 13, 14, 15															
26	Throat	1, 2, 3, 4, 5, 6, 7, 8, 9, 10, 11, 12, 13, 14, 15, 16	3, 4, 5, 6, 7, 8, 9, 10, 11, 12, 13, 14, 15, 16						11									
	M.S.	1, 3, 4, 5, 6, 7, 8, 9, 10, 14	1, 3, 4, 5, 6, 7, 8, 14, 15, 16															
	Anal	8, 9, 10, 13																
	M.S.																	
	Bio.	1, 2, 3, 4, 5, 6, 7, 8, 9, 10, 11, 12, 13, 14, 15, 16	4, 5, 6, 7, 8, 9, 10, 13, 14, 15, 16															
26	Mouth	16, 17, 18, 19, 20	3, 4, 5, 6, 7, 9, 10, 13, 14, 15, 16															
	M.S.	16, 17, 18, 19, 20	3, 4, 5, 6, 7, 9, 10, 13, 14, 15, 16															
	Throat	1, 3, 4, 5, 6, 7, 8, 9, 10, 11, 12, 13, 14, 15, 16	3, 4, 5, 6, 7, 8, 9, 10, 11, 12, 13, 14, 15, 16															
	M.S.	1, 2, 3, 4, 5, 6, 7, 8, 9, 10, 11, 12	3, 4, 5, 6, 7, 8, 9, 10, 11, 12, 13, 14, 15, 16															
	Bio.	1, 2, 3, 4, 5, 6, 7, 8, 9, 10, 13	4, 8, 9, 10, 13															
26	Anal	4, 8, 9, 10, 13																
	M.S.																	
	Bio.	1, 2, 3, 4, 5, 6, 7, 8, 9, 10, 11, 12, 13, 14, 15, 16	3, 4, 5, 6, 7, 8, 9, 10, 11, 12, 13, 14, 15, 16															
	Feces	1, 2, 3, 4, 5, 6, 7, 8, 9, 10, 11, 12	3, 4, 5, 6, 7, 8, 9, 10, 11, 12, 13, 14, 15, 16															
	M.S.	4, 8, 9, 10, 13	4, 8, 9, 10, 13															

Each number represents one culture and sampling date of recovery.

Bio. - Biochemical Identification
M.S. - Mitis Salivarius Medium, Identification

1. Only 2 species, 1 group

[Milis
Salvarius]

Enterococcus Group
Enterococcus Group

(NO) - Total number of cultures recovered from Anaerobic and Aerobic Blood Agar and Chocolate Agar Plates.

* Work performed by A. West, Microbiologist, AMRL, Wright-Patterson AFB, Dayton, Ohio.

TABLE 9 ---- Continued

Subject No.	Body Area	VERIDANS GROUP										ENTEROCOCCUS GROUP					LACTIC GROUP	
		Salvatius	Mitis	Bovis	Equinus	Thermophilus	Uberis	Faecalis	Lepidactenus	Zymogenes	Durans	Lactis	Cremoris					
27	Bio.	4																
	M.S.																	
	Bio.	2, 3, 4, 5, 6, 7, 8, 9, 10, 11, 12, 13, 14, 15, 16	4, 5, 7, 9, 13, 14, 15, 16															
	M.S.	2, 3, 6, 9	4, 5, 9, 10, 13, 14, 15, 16															
	Bio.	1, 3, 4, 5, 6, 7, 8, 10	1, 2, 3, 5, 6, 7, 9, 10, 11, 12, 13, 14, 15, 16															
	M.S.	1, 3, 4, 5, 6, 8, 10, 11, 14	1, 2, 3, 5, 6, 7, 9, 10, 11, 12, 14, 15, 16															
28	Bio.	6, 8, 10	3, 8															
	M.S.																	
	Bio.	1, 2, 3, 4, 5, 6, 7, 8, 9, 10, 11, 12, 13, 14, 15, 16	3, 5, 7, 11, 13, 14, 15, 16															
	M.S.	1, 2, 10	3, 4, 5, 6, 7, 9, 10, 14, 15, 16															
	Bio.	1, 2, 4, 5, 6, 7, 8, 9, 10, 11, 12, 13, 14, 15, 16	1, 3, 3, 4, 5, 6, 7, 8, 9, 10, 11, 12, 13, 14, 15, 16															
	M.S.	1, 2, 3, 4, 5, 6, 8, 9, 10, 11	1, 3, 4, 5, 6, 7, 8, 10, 11, 12, 13, 14, 15, 16															

Each number represents one culture and sampling date of recovery.

Bio. = Biochemical Identification

M.S. = Mitis Salvatius Medium Identification

1. Only 2 species, 1 Group

Mitis Salvatius

Enterococcus Group

Enterococcus Group

Enterococcus Group

Enterococcus Group

Enterococcus Group

⊖ = Total number of cultures recovered from Anaerobic and Aerobic Blood Agar and Chocolate Agar Plates.

TABLE 9 --- Continued
EXPERIMENT VIII*

Subject No.	Body Area	EXPERIMENT VIII*										LACTIC GROUP		
		VERIDANS GROUP					ENTEROCOCCUS GROUP					Lactis	Durans	Cremoris
		Salivarius	Mitis	Bovis	Equinus	Thermophilus	Uberis	Facialis	Liquefaciens	Zymogenes	Durans	Lactis	Cremoris	
28	Nose	Bio. M.S.	31, ①					7				4, ①		
	Mouth	Bio.	1, 2, 3, 4, 5, 6, 7, 8, 9, 10, 11, 12, 13, 14, 15, 16, ②	1, 2, 3, 4, 5, 6, 7, 8, 9, 10, 11, 12, 13, 14, 15, 16, ③										
		M.S.	4, 7, 13, 18	2, 3, 4, 5, 6, 8, 9, 10, 11, 12, 13, 16					4					
	Throat	Bio.	1, 2, 3, 4, 5, 6, 7, 8, 9, 10, 11, 12, 13, 14, 15, 16, ④	1, 2, 3, 4, 5, 6, 7, 8, 9, 10, 11, 12, 13, 14, 15, 16, ⑤					8					
		M.S.	1, 2, 3, 4, 5, 6, 7, 8, 9, 10, 12, 13, 14, 15	2, 3, 4, 5, 6, 7, 8, 9, 10, 11, 12, 13, 15					5, 9, 14, ⑥			9, ⑦		
	Anal	Bio. M.S.	3, 7, 14 ⑧	5, 9, 11, 13					3, 7, 10, 11, 14, 15, 19, ⑨			14, ①		
Feces	Bio. M.S.	5, 9, 11, 13, 15						13, 14, 15						
30	Nose	Bio. M.S.	6, ①	6, 8, 14				10						
	Mouth	Bio.	1, 2, 3, 4, 5, 6, 7, 8, 9, 10, ②, 13, 15, 16, 12	1, 2, 3, 4, 5, 6, 7, 8, 9, 10, 11, 12, 13, 14, 15, 16, ③										
		M.S.	15, 16, 12	1, 2, 3, 4, 5, 6, 7, 8, 9, 10, 12, 13, 14, 15										
	Throat	Bio.	1, 2, 3, 4, 5, 6, 9, 10, 11, 12, 14, 15, ④	1, 2, 3, 4, 5, 6, 7, 8, 9, 10, 11, 12, 13, 14, 15, 16, ⑤										
		M.S.	3, 4, 5, 7, 8, 11, 12, 14, 15, 16	2, 3, 4, 5, 6, 9, 12, 14, 15										
	Anal	Bio. M.S.	9, 15 ⑥	12					8, 9, 11, 12, 15, 16, ⑥			14, 15 ⑧		
Feces	Bio. M.S.	7	7, 10, 13, 16					2, 6, 10, 11, 12, 13, 14, 15, 16 ⑦						

Each number represents one culture and sampling site of recovery.

Bio. = Biochemical Identification

M.S. = Mide Salivarius Medium, Identification

1. Only 2 species, 1 group

Mite Salivarius

Enterococcus Group

Enterococcus Group

* ⑧ = Total No. of cultures re-covered from Anus and Chocolate agar plates.

* Work performed by A. West, Microbiologist, AFMIL, Wright-Patterson AFB, Dayton, Ohio.

TABLE 9 --- Continued

Subject No.	Body Area	VERDANS GROUP										ENTEROCOCCUS GROUP				LACTIC GROUP		
		No.	Salivarium	Milia	Bovis	Equinus	Thermophilus	Uthera	Faecalis	Liquefaciens	Zymogonus	Durazii	Durazii	Lactis	Cremoris			
31	Nose	No. M.S.	11															
	Mouth	Bio. M.S.	2, 3, 4, 5, 6, 7, 8, 9, 10, 11, 12, 13, 14, 15, 16, 17, 18, 19, 20	1, 2, 3, 4, 5, 6, 7, 8, 9, 10, 11, 12, 13, 14, 15, 16, 17, 18, 19, 20														
	Throat	Bio. M.S.	1, 2, 3, 4, 5, 6, 7, 8, 9, 10, 11, 12, 13, 14, 15, 16, 17, 18, 19, 20	1, 2, 3, 4, 5, 6, 7, 8, 9, 10, 11, 12, 13, 14, 15, 16, 17, 18, 19, 20														
	Anal	Bio. M.S.	1, 2, 3, 4, 5, 6, 7, 8, 9, 10, 11, 12, 13, 14, 15, 16, 17, 18, 19, 20	1, 2, 3, 4, 5, 6, 7, 8, 9, 10, 11, 12, 13, 14, 15, 16, 17, 18, 19, 20														
	Feeces	Bio. M.S.	7, 8, 14, 16, 10															
32	Nose	No. M.S.	11, 1															
	Mouth	Bio. M.S.	1, 2, 3, 4, 5, 6, 7, 8, 9, 10, 11, 12, 13, 14, 15, 16, 17, 18, 19, 20	1, 2, 3, 4, 5, 6, 7, 8, 9, 10, 11, 12, 13, 14, 15, 16, 17, 18, 19, 20														
	Throat	Bio. M.S.	1, 2, 3, 4, 5, 6, 7, 8, 9, 10, 11, 12, 13, 14, 15, 16, 17, 18, 19, 20	1, 2, 3, 4, 5, 6, 7, 8, 9, 10, 11, 12, 13, 14, 15, 16, 17, 18, 19, 20														
	Anal	Bio. M.S.	1, 2, 3, 4, 5, 6, 7, 8, 9, 10, 11, 12, 13, 14, 15, 16, 17, 18, 19, 20	1, 2, 3, 4, 5, 6, 7, 8, 9, 10, 11, 12, 13, 14, 15, 16, 17, 18, 19, 20														
	Feeces	Bio. M.S.	6, 7, 8, 9, 10, 11, 12, 16															

Each number represents one culture and sampling date of recovery.
 No. = Biochemical identification
 M.S. = Milia Salivarium Medium, identification
 1. Only 2 species, 1 group
 Milia
 Salivarium
 Enterococcus Group
 Enterococcus Group
 Enterococcus Group
 * No. = Total No. of cultures recovered from Anastrobic and Charotic Blood agar and Charotic agar plates.

**TABLE 9 --- Continued
EXPERIMENT IX***

EXPERIMENT IX*

Subject No.	Body Area	VERIDANS GROUP						ENTEROCOCCUS GROUP				LACTIC GROUP	
		Salivarius	Mitis	Bovis	Equinus	Thermophilus	Uberis	Faecalis	Liquefaciens	Zymogenus	Durans	Lactis	Cremoris
33	Glottal	Bio. M.S. 9, 11	12, 6										
	Throat	Bio. M.S. 3, 5, 7-10, 11	4, 12					1, 2, 3, 5, 6, 7, 8, 9, 11					
	Feces	Bio. M.S. 4, 12	3, 5, 7-10, 11					12					
34	Glottal	Bio. M.S. 3, 6, 7, 8, 9	1, 4, 5, 10, 11, 12										
	Throat	Bio. M.S. 4, 10, 11	6, 7, 8, 9					11					
	Feces	Bio. M.S. 1, 2, 3, 4, 5, 6, 7, 8, 9, 10, 12	1, 5, 9, 12					1, 2, 3, 5, 8, 12					

Each number represents one culture and sampling date of recovery.

Bio. = Biochemical Identification
M.S. = Mitis Salivarius Medium, identification

1. Only 2 species, 1 group

Mitis Salivarius
Enterococcus Group
Enterococcus Group

*Work performed by A. West, Microbiologist, AMRL, Wright-Patterson AFB, Dayton, Ohio.

TABLE 9 --- Concluded

TABLE 9 --- Concluded

Subject No.	Body Area	VERIDANS GROUP							ENTEROCOCCUS GROUP				LACTIC GROUP			
		Salivaricus	Mitis	Bovis	Equinus	Thermophilus	Uberis	Faecalia	Liquefaciens	Zymogenes	Durans	Lactis	Cremoris			
35	Nose	Bio. 11 M.S.														
	Gingival	Bio. 2, 7 M.S. 6, 10	1, 4, 5, 6, 9, 10, 11, 12													
		Throat	Bio. 1, 2, 6, 7, 8, 9, 10, 11, 12 M.S. 4	1, 2, 6, 8, 9, 10, 11, 12												
	Feces		Bio. 11 M.S.													
36	Gingival	Bio. 9, 1, 3, 6, 12 M.S.	1, 8, 5, 6, 7, 10, 11, 12													
	Throat	Bio. 5, 8, 9 M.S. 4, 6	2, 6, 7, 10, 12 3, 6													
		Feces	Bio. 3, 10 M.S. 1, 2, 4, 6, 7, 9, 11, 12	4, 5 7, 8, 11												

Each number represents one culture and sampling date of recovery.
 Bio. = Biochemical identification
 M.S. = Mits Saltvaricus Medium, Identification
 1. Only 2 species, 1 group
 Mitis
 Salivaricus
 Enterococcus Group
 Enterococcus Group

TABLE 10. RECOVERY OF MICROCOCCACEAE*

Subject 17 - EXPERIMENT V

Body Area	Sampling Period															
	1	2	3	4	5	6	7	8	9	10	11	12	13	14	15	16
Scalp		+							+					+(2)		
Ear					-											
Eye																
Nose	(2)	-				-	+	+(2)		+(2)	+	-	+	+(2)		
Mouth			-											-(2)		
Throat										-		+		+		
Axilla	-	-			(2)	-	-	+		(2)	+	-	+(2)	+(2)		
Forearm																
Umbilicus			-													
Groin	+(2)	+	+	+	-	-	+(2)	+(2)	-	+	+(2)	+(2)	-(2)	+		
Glans penis		+(2)	+						-(2)							
Anal fold	+	-				-						-		+		
Feces	-											-				
Toes		-(2)												+		

+ = positive coagulase test
 - = negative coagulase test
 * = Work performed by Mr. J. Rack and Mrs. B. Horstman, Miami Valley Hospital Research Department under contract AF33(657)-11716.
 () = Number of different strains

Continued

TABLE 10 --- Continued
 Subject 18 - EXPERIMENT V

Body Area	Sampling Period															
	1	2	3	4	5	6	7	8	9	10	11	12	13	14	15	16
Scalp		(2)														
Ear		-				-			-		(2)	-		-		
Eye		-				-			-		-					
Nose		(2)				-	(2)	(2)	(2)	(2)	(2)		(2)	(2)		
Mouth		-														
Throat						-						-				
Axilla						-		(2)	+							
Forearm		-							-							
Umbilicus		-				(2)		(2)	-	(2)	-	-	-	+		
Groin		-				(2)		(2)	+	(2)	-	(2)	+	+		
Glans penis		+														
Anal fold		+				+			+	+		(2)				
Feces					+					(2)						
Toes		(2)														+

+ = positive coagulase test
 - = negative coagulase test
 () = Number of different strains

TABLE 10 --- Continued
Subject 19 - EXPERIMENT V

Body Area	Sampling Period															
	1	2	3	4	5	6	7	8	9	10	11	12	13	14	15	16
Scalp		+														
Ear	(2) +	+	+		-		+	-	+		+	+		+(2)		
Eye	+	(2) -				+						-		-		
Nose	-	(2) -	+				-	(2) -	-	-	-	(2) -	-	-(2)		
Mouth														+		
Throat		-						-		+	+	-				
Axilla	-	-			-	+(2) -	-	(2) -	-		+	+		-		
Forearm																
Umbilicus	-	-				-				-			-			
Groin	+(2) -	+	+		-	-		+	-		+					
Glans penis		+														
Anal fold					+					+						
Feces									+(2) +							
Toes		+												-		

+ = positive coagulase test
- = negative coagulase test
() = Number of different strains

TABLE 10 --- Continued
Subject 20 - EXPERIMENT V

Body Area	Sampling Period															
	1	2	3	4	5	6	7	8	9	10	11	12	13	14	15	16
Scalp		+ -														
Ear	-											(2) -		-		
Eye												-		-		
Nose	+ (2) -	+ -			+ -		-	+	-	+ -	-		+			
Mouth		-												-		
Throat																
Axilla	-	-		-	-	-	(2) -	-	-	-	+	(2) -	-	-		
Forearm		-														
Umbilicus	+				+			(2) -	(2) -		+					
Groin	+ -	-	-	-		+	-	-		(2) -	+	+	+(2) -			
Glans penis		+ -														
Anal fold		+		-	+					+	-		+			
Feces					+ (2) -											
Toes		-	-						+ -							

+ = positive coagulase test
 - = negative coagulase test
 () = Number of different strains

TABLE 10 ---- Continued
 Subject 21 - EXPERIMENT VI

Body Area	Sampling Period															
	1	2	3	4	5	6	7	8	9	10	11	12	13	14	15	16
Scalp	+	(2)								(2)						
Ear	(2)	(2)	+	+	(2)	(2)	+	(2)	-	-	(2)	+				
Eye		-														
Nose	(2)	-	(3)	(3)	(2)	(2)	+	(2)	(3)	(4)	(3)	(3)				
Mouth	+		(2)				-				(2)					
Throat	-	-						+	-		(2)	-				
Axilla	+		+	+		+	+	+	(2)	+	+	+				
Forearm	-															
Umbilicus	-	+								(2)						
Groin	(2)	(2)	-	+	+	+	+	+	+	+	+	+				
Glans penis	+	+	(3)	(2)	(2)	+	+	+	+	+	+	+				
Anal fold	(3)	(4)								(3)						
Feces																
Toes	(2)	(2)								-						(2)

+ = positive coagulase test
 - = negative coagulase test
 () = Number of different strains

TABLE 10 --- Continued
Subject 22 - EXPERIMENT VI

Body Area	Sampling Period															
	1	2	3	4	5	6	7	8	9	10	11	12	13	14	15	16
Scalp	+(3) -(2)	+(2) -(2)								(2)						
Ear	-	(2) -	(2) -	-	-	-	(2) -		+	+(2) -	+(2) -	+(2) -				+(2) -
Eye																
Nose	+(3) -(2)	(3) -	+	-	-	(3) -	(2) -	(2) -	(3) -	(2) -	(2) +	(3) -				
Mouth	+		-	-	+(2) -											
Throat	-	+	+	+	+	+	+	+		+						
Axilla	(2) -	-	+	-	-	-	(2) -	+(2) -	+	+(2) -	(3) -	(3) -				
Forearm	+	+								-						-(2)
Umbilicus	+(2) -	+								+						+
Groin	+(2) -	(2) -	+	-	(2) -	+	-(2) -	-	+	-(2) -	+	+(2) -				
Glans penis	+(2) -	-(2) -	+	+	+(2) -	-(2) -	+(2) -	+(2) -		+(2) -	+(2) -	+				
Anal fold	-	+								-						
Feces																
Toes	+(4) -															-

+ = positive coagulase test
 - = negative coagulase test
 () = Number of different strains

TABLE 10 -- Continued
Subject 23 - EXPERIMENT VI

Body Area	Sampling Period															
	1	2	3	4	5	6	7	8	9	10	11	12	13	14	15	16
Scalp	+(2) -(2)	-(2)								+	-(2)					
Ear	+	-	-(2)		-(2)	+(2) -(2)	+(2) -(2)	+(2) -(2)	-(2)	+(2) -(2)	-(2)	+				
Eye		-								+(2) -(2)					+(2) -	
Nose	+(2) -(2)	+(2) -(2)	+	-(2)	-	-		+(2) -	+	+	+	-				
Mouth					-	-	-			-	+					
Throat				-(2)												
Axilla	+		-	-	-	-(2)	-(3)	-	-	-(2)	+	-(2)				
Forearm		+								-					+(2)	
Umbilicus										-(2)					+	
Groin	-	-	-	-(3)	-	-	+	+	-	-(2)	+	-(2)				
Glans penis	-(2)	-(2)	-	-(2)	-(2)	-(2)	+(2) -	+	-(2)	-	+(3) -	+				
Anal fold		-								-						
Feces																
Toes	-(3)	-														

+ = positive coagulase test
 - = negative coagulase test
 () = Number of different strains

TABLE 10 -- Continued
Subject 24 - EXPERIMENT VI

Body Area	Sampling Period															
	1	2	3	4	5	6	7	8	9	10	11	12	13	14	15	16
Scalp	+	+								-						
Ear	+(2)	-(2)	-(2)	-	-	-(3)	+(2)	-(2)	-(2)	-(2)	+				+	
Eye	-(4)	-(2)								-(2)						-(2)
Nose	+	+(3)	+	+(2)	+	+(2)	+(2)	+	+	+	+(3)	+(2)				
Mouth		-			+	+					+					
Throat	+(2)				+	-						+				
Axilla	-(2)	+(2)	-(2)	-(4)	+(2)	+	+(2)	-(2)	-	-	-(3)	+				
Forearm		-								-(2)					+	-(3)
Umbilicus	-	-(2)								-(3)					+	-(2)
Groin	-(2)	+	-	-(2)	+(3)	+(3)	+(2)	+	+	+	+	+(2)				
Glans penis	-(3)	-	-	-	-(2)	+(2)	+(2)	+(2)	+(2)	+(3)	+	+	+	+		
Anal fold	-	-								+						
Feces																
Toes	-(3)	-														

+ = positive coagulase test
 - = negative coagulase test
 () = Number of different strains

TABLE 10 -- Continued
Subject 25 - EXPERIMENT VII

Body Area	Sampling Period															
	1	2	3	4	5	6	7	8	9	10	11	12	13	14	15	16
Scalp	+(2) -															
Ear	+	+(2) -	+	+(2) -	+(2) -	+(2) -	+(2) -(2)	+(2) -	+(3) -	+(2) -	+	+(2)				
Nose	-(2)	-(2)	-(2)	-	-	-	+(2) -	-	-(2)	+(2) -	-	-(2)				
Eye																-
Mouth								-(3)		-						
Throat						+	+				+					
Axilla	+(2) -	+	+	-	+(2) -	+(2) -(3)	+(2) -(2)	+(2) -(3)	+(2) -(2)	+(2) -(2)	+(2) -(2)	-(2)				
Forearm	-							+								+(2)
Umbilicus																+(2)
Groin		+	+	+(2) -	+	+(2) -(2)	+	+	+(2) -(2)	+(2) -(2)	+	-				
Glans penis	-	-	-	+(2) -	+(2) -	+(2) -	+(2) -(2)	+	+(2) -(2)	+(2) -	+(3) +	+				
Anal fold								-								-
Feces																
Toes								+								+

+ = positive coagulase test
 - = negative coagulase test
 () = Number of different strains

TABLE 10 -- Continued
Subject 26 - EXPERIMENT VII

Body Area	Sampling Period															
	1	2	3	4	5	6	7	8	9	10	11	12	13	14	15	16
Scalp	+(2)	-														+(4)
Ear	-		+	+(3)	+(2)	+	+	±(2)	±		+(2)	±				
Nose	-(2)	-(2)	-(2)	-(2)	-	-	-(2)	-	±(2)	-(2)	-	±(2)				
Eye																-
Mouth							±	-	+	-						
Throat											+					
Axilla		-	-(2)	-(2)	-(2)	-(2)	+	±(2)	+	±(2)	±(2)	-(2)				
Forearm								+								+(2)
Umbilicus																+(2)
Groin		+	±	±	±	±	±(2)	±(2)	+	±(2)	±(2)	±				
Glans penis		+	+	+	+	+(3)	+	+	±(2)	±(2)	+	+				
Anal fold								±(2)								±(3)
Feces						-							+(2)			
Toes		-(3)														±(2)

+ = positive coagulase test
 - = negative coagulase test
 () = Number of different strains

TABLE 10 -- Continued
Subject 27 - EXPERIMENT VII

Body Area	Sampling Period															
	1	2	3	4	5	6	7	8	9	10	11	12	13	14	15	16
Scalp	+(3)							+(2)								+
Ear																
Nose	-		+(2)	+	+	+	+(2)	+(2)	+(2)	+(2)	+(3)	+(3)				
Eye	-	+	+(3)	+(2)	+(3)	+(2)	+	+	+(2)	+(4)	+(2)	+(2)				-(3)
Mouth					-				-	-						
Throat			+	+	+	+	+			-	+	+				
Axilla	-		-	-	+	-	+	+	+(2)	-	+	+				
Forearm								+(3)								+
Umbilicus																-(2)
Groin	+	+	+	+	+(2)	+	+	+	+(2)	+(3)	+	+				
Glans penis			+			+	-			+(2)	+					
Anal fold																+
Feces								+			+		+			
Toe	-(2)															+

+ = positive coagulase test
 - = negative coagulase test
 () = Number of different strains

Contrails

TABLE 10 -- Continued
Subject 28 - EXPERIMENT VII

Body Area	Sampling Period															
	1	2	3	4	5	6	7	8	9	10	11	12	13	14	15	16
Scalp	+(2)	-						+(2)								+(2)
Ear	+	+(2)	+	+(2)	+(2)	+	+	+(2)	+(2)	+(2)	+(2)	+(2)				
Nose	+	+	+	+	+	+	+(2)	+	+	+	+	+				
Eye	-															+(2)
Mouth																
Throat			+	+			+		+			+				
Axilla		-	-	-(2)	-(2)	-	-(2)	-	-(2)	-(2)	+	-				
Forearm	-															+
Umbilicus																
Groin	-	+(2)	+(2)	+(2)	+	+	+(2)	+	+(2)	+	+	+				
Glans penis		-	+(2)	-	+	+(2)	+	+	+	-	+	+				
Anal fold	-							-								-
Feces																
Toes	-															+

+ = positive coagulase test
 - = negative coagulase test
 () = Number of different strains

TABLE 10 -- Continued
Subject 29 - EXPERIMENT VII

Body Area	Sampling Period															
	1	2	3	4	5	6	7	8	9	10	11	12	13	14	15	16
Scalp		+							+(3)							+(3)
Ear	+(3)	+ -	+(2) -	+(3) -(3)	+(2) -(2)	+	+(2) -(2)	+(2) -	+(3) -	+(2) -(2)	+(2) -	+(2) -				
Nose	-(2)	-	-	-(2)	-	-	-(2)	-(2)	-(2)	-(2)	-	±				-(2)
Eye		-(3)							-							
Mouth			+ -		+	+ -	-	+ -	+ -		+	+				
Throat							+	-(2)								
Axilla	±	-	-	-	-	-	-	-	-	±	-	±				
Forearm		+(2)							+(2)							+(2)
Umbilicus									+(2)							+
Groin	+		±	+	+	+	+	±		±	+	+				-
Glans penis	+ 2	+	+ 2	+		+	+	+ 2	+	+	+ 2	+				
Anal fold	-	+							+							
Feces	-	+						±			+					
Toes		+							ns							+(2) -

+ = positive coagulase test
 - = negative coagulase test
 ns = no sample
 () = Number of different strains

TABLE 10 --- Continued
Subject 30 - EXPERIMENT VIII

Body Area	Sampling Period															
	1	2	3	4	5	6	7	8	9	10	11	12	13	14	15	16
Scalp		+(3)							+							+(2)
Ear		+ -	-		+	-(2)	+(2) -		+	-	+(2) -	+				
Nose	-(2)	-(2)	-(2)	-(3)	-	-	-(2)	+(3) -	-(3)	-(2)	+	-				
Eye																
Mouth				-							-					
Throat	-				-											
Axilla	-	-	-(2)	-	-(2)	-(2)	-(2)	-	-	-	-	-				
Forearm									-							
Umbilicus		+(2)							±							
Groin	+(2) -	+	+(2) -	+	+	-	-(3)	+	+	+	+	-				
Glans penis	+	+(2) -	+	+	+	+	+(2) -	+(2)	+	-(2)	+	+				
Anal fold		-							-(2)							-(2)
Feces									+		+			+		
Toes		-(2)						-								-(2)

+ = positive coagulase test
- = negative coagulase test
() = Number of different strains

TABLE 10 -- Continued
Subject 31 - EXPERIMENT VIII

Body Area	Sampling Period															
	1	2	3	4	5	6	7	8	9	10	11	12	13	14	15	16
Scalp		+(2)							+							+(2)
Ear	-	-	-	-	-	+(2)	+	+	+	+	+(2)	-(2)				
Nose	-(3)	+	+(2)	+(2)	+	+	+(2)	-(3)	-(2)	-(3)	-(2)	-(4)				
Eye		-							-							
Mouth										+						
Throat																
Axilla	-(3)	-(2)	-	-(4)	-(2)	-(3)	-	-(2)	-(2)	-(2)	-(2)	-(2)				-(2)
Forearm		±							+	{3}						-
Umbilicus		+(4)							+							
Groin	±	-(3)	+(2)	+(2)	+(2)	+	±	+	+(2)	+	±	±				
Glans penis	-(3)	+(2)	+(3)		+	+(2)	+(2)	+	+	+	+(2)	+				+
Anal fold	-(2)								+(2)							
Feces									+							
Toes	-(2)								ns							+(5)

+ = positive coagulase test
 - = negative coagulase test
 ns = no sample
 () = Number of different strains

TABLE 10 -- Continued
Subject 32 - EXPERIMENT VIII

Body Area	Sampling Period															
	1	2	3	4	5	6	7	8	9	10	11	12	13	14	15	16
Scalp		+(2)							+(2)							
Ear	-	+	+	-	+	+	+(2)	+	+	+	+					
Nose	+	+(2)	+	+	-(2)	+(2)	+(2)	+	+(2)	+	+	+(2)				
Eye									+(2)							
Mouth					-											
Throat				-		+	-		+							
Axilla	-	+(2)	+(3)	+(2)	-(2)	-(2)	+(2)	+(2)	+(2)	+	+	+(2)				
Forearm									+							+(2)
Umbilicus									+							+(2)
Groin	+(2)	+	+	+	+	+	+	+	+	+	+(2)	+				+(2)
Glans penis	-(2)	+	+(2)	+	+	+	+(2)	+	+	+(2)	+(2)	+				-(2)
Anal fold		+(2)							+(3)							-(2)
Feces							-									
Toes									-							-(3)

+ = positive coagulase test
 - = negative coagulase test
 () = Number of different strains

TABLE 10 -- Continued
Subject 33 - EXPERIMENT IX

Body Area	Sampling Period															
	1	2	3	4	5	6	7	8	9	10	11	12	13	14	15	16
Scalp		+(2)							+(3)			+				
Ear		+ -							+ -(2)			-(2)				
Eye		+							-(2)			-				
Nose	-	-	-	-(2)	-(2)	-(2)	+	+	+	+(2)	+	+				
Gingival										+						
Throat					+			+		+	+	+				
Axilla	+ -(2)	+ -(2)	+ -	+ -		+ -(2)		- -(3)	- -	- -(2)	+	-(2)				
Forearm		-							±			-(2)				
Umbilicus		+							-(2)			-				
Groin	+	+(2)	+		+	-	+	-	-	-	+					
Glans penis	-	+	+	-	+(2)	-(2)	-(3)	-(2)	-	-	-(2)	-				
Anal fold	+	+	+	-	+	+	+	+	+			+(2)				
Toes	-(3)	-(3)		-(2)		+	-	-	-(2)	+	-	+				
Electrode		+							+(2)			-(2)				

+ = positive coagulase test
 - = negative coagulase test
 Feces - No micrococaceae
 () = Number of different strains

TABLE 10 -- Continued
Subject 34 - EXPERIMENT IX

Body Area	Sampling Period															
	1	2	3	4	5	6	7	8	9	10	11	12	13	14	15	16
Scalp		+							+ (2)			+				
Ear																
Eye		-							+ (2)							
Nose	-	-	-	-	-(2)	-	+	+	+	+	+	+				
Gingival					-	-	+(2)									
Throat								+			+					
Axilla	+	-	-	-	-(2)	-	-	-(2)	-	+	-	+				
Forearm		+							+			+				
Umbilicus		+							+		+					
Groin	+	+(2)	+	+	+	-	+	+	+(2)	+	+	+				
Glans penis	+	+(2)		+	+(2)	+(2)	+(2)	+	+(2)	+(2)	+	+				
Anal fold	-	+	-(2)	-(3)	+	-	+(2)	-(2)	+(2)	+	+	+(2)				
Feces																
Toe	+	-(2)		+		-(2)	+	-(3)	-(2)	-	-	-(2)				
Electrode	+											-(4)				

+ = positive coagulase test
- = negative coagulase test
() = Number of different strains

TABLE 10 -- Continued
Subject 35 - EXPERIMENT IX

Body Area	Sampling Period															
	1	2	3	4	5	6	7	8	9	10	11	12	13	14	15	16
Scalp		+							+(2)			-				
Ear		-							+(2)							
Eye		-(2)							-			+				
Nose		+	+	+	+	+	+	+(2)	+(2)	+(2)	+(2)	+				
Gingival							-(2)					-				
Throat									-			-				
Axilla	+	+	-	+		-	-		+	+(2)		-				
Forearm		+							-			±				
Umbilicus		-(2)							-(2)			-(2)				
Groin	+(2)	+(2)	-(3)	+(2)	+	+(2)	+(2)	+(2)	+(2)	+	-	+(2)				
Glans penis	-(2)	-(2)	+	+	+	-(2)	+	+(2)	+(3)	+	+(2)	-				
Anal fold		+	-(2)	+(2)	+	+	+	+	+	+	+	+(2)				
Feces																
Toes	+	+(2)	-	-(2)	+	-(2)	-	+	-(2)	+	-(2)	+				
Electrode		-							-			-(4)				

+ = positive coagulase test
 - = negative coagulase test
 () = Number of different strains

TABLE 10 -- Concluded
Subject 36 - EXPERIMENT IX

Body Area	Sampling Period															
	1	2	3	4	5	6	7	8	9	10	11	12	13	14	15	16
Scalp		±							±			+				
Ear		-							±			-				
Eye																
Nose	-	-	-		-	-(2)			-		-(2)	+				
Gingival				-												
Throat																
Axilla		-(2)	-(3)		-(3)											
Forearm		+							+(2)			-(3)				
Umbilicus		+							-(2)							
		-(2)														
Groin	+	+	+	-(2)	-(2)	-(3)	-(3)	-(2)	-(2)		-(3)					
	-	-	-(2)													
Glans penis				-(3)	+	+	-(3)	+			+	+				
					-	-		-(2)		-(2)	-	-(2)				
Anal fold	-	+	+		+	-			+	-(2)	+	+				
		-	-		-			-(2)	-(2)		-	-(2)				
Feces						+	+			+	+					
Toe		+(2)	+(2)		+	-(2)	-(2)	-(3)	-(2)	-(2)	-	-(2)				
Electrode												-(5)				

+ = positive coagulase test
- = negative coagulase test
() = Number of different strains

TABLE 11. OCCURRENCE OF NEISSERIA

Sampling Period

Subject	Body Area	1	2	3	4	5	6	7	8	9	10	11	12	13	14	15	16
17	Umbilicus							X									
	Groin														X		
	Glans penis					X											
18	Nose								X								
	Mouth		X														
	Throat														X		
	Glans penis				X												
19	Ear							X			X						
	Eye				X												
	Nose								X								
	Throat						X										
	Axilla					X											
	Umbilicus											X					
	Groin										X						
20	Glans penis	X															
	Scalp			X													
	Nose										X						
	Throat										X						
	Axilla												X				

TABLE 11. --- Continued

Sampling Period

Subject	Body Area	1	2	3	4	5	6	7	8	9	10	11	12	13	14	15	16
21	Throat				X							X					
	Axilla								X								
	Groin								X								
	Glans penis									X		X					
22	Ear													X			
	Throat													X			
	Feces					X											
	None																
24	Ear													X			
	Feces						X										
25	Nose							X	X	X	X					X	
	Mouth	X		X	X	X	X		X	X		X		X	X		X
	Throat	X	X	X	X	X	X	X	X	X		X		X		X	
	Nose				X		X		X	X							
26	Mouth			X	X	X	X		X	X	X		X	X	X	X	X
	Throat		X	X	X	X	X	X	X	X	X	X	X		X	X	X
	Nose						X		X	X							
	Mouth						X		X	X							
27	Throat								X								
	Nose																
	Mouth					X				X	X	X		X	X	X	X
	Throat				X	X	X		X	X	X	X	X	X	X	X	X

TABLE 11 --- Continued

Sampling Period

Subject	Body Area	1	2	3	4	5	6	7	8	9	10	11	12	13	14	15	16
28	Mouth			X	X	X	X		X	X	X	X	X	X	X	X	
	Throat		X	X		X	X		X	X		X			X	X	X
	Nose								X								
29	Mouth	X		X	X	X					X	X	X	X	X	X	X
	Throat	X				X		X		X	X	X	X	X	X	X	X
	Glans penis					X				X					X		
30	Feces													X			
	Nose						X			X							
	Mouth	X	X	X	X	X	X			X	X	X	X	X	X	X	X
31	Throat	X	X	X	X		X	X		X	X	X	X	X	X	X	X
	Groin											X					
	Nose											X			X		
32	Mouth	X	X	X			X	X	X	X	X	X	X	X	X	X	X
	Throat		X	X	X	X	X	X	X	X	X	X	X	X	X	X	X
	Axilla													X			
33	Mouth	X	X		X		X	X		X	X	X	X	X	X	X	X
	Throat	X	X	X	X	X	X		X	X	X	X	X	X	X	X	X
	Throat		X								X	X	X				

TABLE 11 ---- Concluded

Sampling Period

Subject	Body Area	1	2	3	4	5	6	7	8	9	10	11	12	13	14	15	16
34	Gingival			X						X							
	Throat	X							X								
35	Gingival		X														
	Throat						X			X	X		X				
36	Gingival	X															
	Throat	X		X	X		X	X			X		X				

TABLE 12. OCCURRENCE OF ENTEROBACTERIACEAE IN BODY AREAS

Exp.	Subject	Sampling Period															
		1	2	3	4	5	6	7	8	9	10	11	12	13	14	15	16
V	17	anal-E. coli no type								anal-E. coli no type							
	18	axilla- Aerobacter anal-E. coli 086:B7							eye-E. coli saline +								
	19	axilla- glass penis- Aerobacter	glass penis- Aerobacter														
	20	axilla- Aerobacter anal-E. coli saline +	anal-E. coli saline + Aerobacter														
	21																
VI	22	anal-E. coli no type Alk. dispar	E.P. - E. coli no type Alk. dispar	glass penis- Alk. dispar													
	23																
	24																
VII	25	anal-E. coli Poly B															
	26																
	27	nose-E. coli no type	nose-E. coli no type														
	28																

TABLE 12 --- Concluded

Exp.	Subject	Sampling Period																		
		1	2	3	4	5	6	7	8	9	10	11	12	13	14	15	16	17	18	
VII	29	anal-E. coli no type Alk. dispar	anal-E. coli no type Alk. dispar	anal-E. coli mouth- Fuzzers B-C eye-E. coli Poly A O111:24 O47:28 O28:26	giens penis- pseudomonas		giens penis- pseudomonas		giens penis- pseudomonas	giens penis- pseudomonas	giens penis- pseudomonas	giens penis- pseudomonas								
	30		toe-pseudo- monas																	
	31	anal-E. coli no type Alk. dispar	anal-E. coli no type Alk. dispar	anal-E. coli mouth- Fuzzers B-C eye-E. coli Poly A O111:24 O47:28 O28:26	anal-E. coli no type Alk. dispar		throat- alcaligenes anal-E. coli no type		anal-E. coli Poly A, no further type	throat- aerobacter anal-E. coli no type		anal-E. coli Poly A, no further type alcaligenes								
IX	32	toe-E. coli no type																		
	33	gingival- alcaligenes giens penis- alcaligenes																		
	34	anal-E. coli no type Aerobacter			giens penis- alcaligenes															
	35	anal-E. coli Poly A, no further type	anal-E. coli no type further type		throat- Proteus sp. anal-E. coli no type		non- alcaligenes													
	36	giens penis- pseudomonas toe-E. coli no type Proteus sp.	E. E. toe- Proteus sp.	E. E. toe- Proteus sp.	gingiva, exilia, groin alcaligenes anal-E. coli no type		non- alcaligenes		throat- alcaligenes	throat- alcaligenes	throat- alcaligenes									
	38	anal-E. coli no type Alk. dispar	anal-E. coli no type Alk. dispar	anal-E. coli mouth- Fuzzers B-C eye-E. coli Poly A O111:24 O47:28 O28:26	anal-E. coli no type Alk. dispar		throat- alcaligenes anal-E. coli no type		anal-E. coli Poly A, no further type	throat- aerobacter anal-E. coli no type		anal-E. coli Poly A, no further type alcaligenes								

TABLE 13. RECOVERY OF ENTEROBACTERIACEAE FROM FECES

Subject Number	Sampling Period							
	1	2	3	4	5	6	7	8
17	E. coli Saline +			Aerobacter E. coli Saline +	E. coli no type	Aerobacter	E. coli Saline +	
18	E. coli Saline + 0119:B14	Aerobacter E. coli 0119:B14	Aerobacter E. coli Saline +	E. coli Saline +	E. coli no type	E. coli no type	E. coli Saline +	E. coli Saline +
19		E. coli Saline +	Aerobacter	Aerobacter E. coli Saline +	E. coli Saline +		E. coli Saline +	E. coli Saline +
20	E. coli Saline + 74:011B	E. coli Saline +	E. coli Saline +	Aerobacter E. coli no type	Aerobacter E. coli	E. coli Saline +	E. coli Saline +	E. coli no type
Subject Number	Sampling Period							
	9	10	11	12	13	14	15	16
17	Aerobacter E. coli Saline +	Aerobacter	E. coli Saline +					
18	Aerobacter							
19	E. coli Saline +							
20	E. coli no type							

TABLE 13 --- Continued

Subject Number	Sampling Period							
	1	2	3	4	5	6	7	8
21		Klebsiella Aerobacter		Klebsiella Aerobacter	E. coli no type Klebsiella Aerobacter	E. coli 0125:B15	E. coli 0125:B15 no type	E. coli no type
22	Alk. dispar E. coli no type	Alk. dispar E. coli no type	Alk. dispar	Alk. dispar E. coli 0127:B8	Alk. dispar	Weak Alk. dispar E. coli no type	Very weak Alk. dispar E. coli no type	*Pattern S-C E. coli no type
23	E. coli 0127:B8		E. coli 0127:B8	E. coli no type Klebsiella Aerobacter	E. coli no type Klebsiella Aerobacter	*Pattern S-C E. coli 0126:B16 no type	*Pattern S-C	*Pattern S-C
24	E. coli no type	E. coli no type		E. coli no type	E. coli no type	E. coli no type	E. coli no type	E. coli no type

Subject Number	Sampling Period							
	9	10	11	12	13	14	15	16
21			E. coli no type					
22	*Pattern S-C E. coli no type	*Pattern S-C E. coli no type	*Pattern S-C E. coli no type	*Pattern S-C E. coli 0126:B16	*Pattern S-C E. coli 0126:B16	*Pattern S-C	*Pattern S-C	
23	*Pattern S-C	*Pattern S-C	*Pattern S-C Klebsiella Aerobacter	*Pattern S-C	*Pattern S-C			
24	E. coli no type	E. coli no type 0127:B8		E. coli 0127:B8				

* Pattern S-C (Shigella - Coli)

TABLE 13 --- Continued

Subject Number	Sampling Period							
	1	2	3	4	5	6	7	8
25	E. coli Poly B	E. coli no type	E. coli no type	E. coli Poly B	E. coli no type	E. coli no type	E. coli Poly B	E. coli no type Aerobacter
26	Alkalescen dispar	Weak Alk. dispar	Alkalescen dispar	Alkalescen dispar	Alkalescen dispar	Alkalescen dispar	Weak Alk. dispar	Weak Alk. dispar
27		E. coli no type	Aerobacter E. coli no type	E. coli no type Pattern I*	Aerobacter	E. coli no type Pattern I*	E. coli no type Pattern I*	E. coli no type Aerobacter
28	E. coli no type	E. coli no type		E. coli no type	E. coli no type	E. coli no type	E. coli no type Pattern II*	E. coli no type Pattern II*

Subject Number	Sampling Period							
	9	10	11	12	13	14	15	16
25	Aerobacter	Aerobacter	Aerobacter	Aerobacter E. coli no type	E. coli no type	E. coli no type	E. coli no type	
26								
27	Aerobacter	Aerobacter	Bethesda-Ballerup +	Aerobacter	E. coli no type Aerobacter	E. coli no type		
28	E. coli no type	Pattern I*	E. coli no type	E. coli no type	E. coli no type	E. coli no type	E. coli no type	

* Pattern I - +--+ A/AG; Pattern II = -+--+ A/H₂S + G (Does not type Salmonella, Arizona, or Bethesda-Ballerup)

TABLE 13 --- Continued

Subject Number	Sampling Period						
	1	2	3	4	5	6	7
29		Pseudomonas	E. coli, Poly B 0126:B16 Pseudomonas			E. coli, Poly B 0126:B16	
30		E. coli, no type	E. coli, Poly B NFT**	Aerobacter	Aerobacter E. coli, Poly B NFT*	E. coli, Poly B NFT**	
31	E. coli no type	E. coli, Poly B 0124:B17 0126:B16	E. coli, no type	E. coli, Poly B 0126:B16	E. coli, Poly A 0127:B8 026:B6 Poly B, 086:B7 0124:B17 0126:B16	E. coli, Poly A 0127:B8 026:B6 Poly B, 086:B7 0125:B17 0126:B16	E. coli, Poly A 0127:B8 026:B6 Poly B, 0124:B17 0126:B16
32	E. coli no type	E. coli, no type	E. coli, no type *Pattern S-C	E. coli, no type	E. coli, no type *Pattern S-C	E. coli, no type *Pattern S-C	E. coli, no type *Pattern S-C
	8	9	10	11	12	13	14
29	E. coli, Poly A 0127:B8 Poly B 0126B16	Aerobacter E. coli, Poly A 0127:B8; Poly B 0126:B16	Aerobacter	E. coli, Poly A 0127:B8; Poly B 0126:B16	E. coli, no type	E. coli, Poly A 0111:B4, 0127: B8; Poly B 0126:B6	Aerobacter E. coli, Poly A 0127:B8; Poly B 0126:B16
30	E. coli no type Aerobacter	E. coli, Poly B NFT**	E. coli, no type	E. coli, no type	E. coli, no type Aerobacter	E. coli, no type Aerobacter	Aerobacter
31	E. coli, Poly B, 0124:B17 0126:B16	Aerobacter	Aerobacter	E. coli	E. coli, Poly A 0111:B4, 0127: B8, 026:B6 Poly B, 0126: B16, Aerobacter	Aerobacter E. coli	Aerobacter
32	E. coli no type	E. coli, no type *Pattern S-C	E. coli, no type *Pattern S-C	E. coli, no type *Pattern S-C	E. coli, no type E. coli, Poly A 0127:B8; Poly B 0125:B15	E. coli, no type E. coli, Poly B 0127:B8; Poly B 0125:B15	E. coli, no type *Pattern S-C

*Pattern S-C - Shigella-coli; **NFT = No further type

TABLE 13 --- Concluded

Subject Number	Sampling Period							
	1	2	3	4	5	6	7*	8
33	E. coli, Poly A & B, NFT**, E. coli, no type Aerobacter	E. coli no type	E. coli Poly A NFT**	E. coli Poly A NFT**	E. coli Poly A NFT**	E. coli Poly A NFT**	E. coli Poly A NFT**	E. coli no type
34	E. coli no type	E. coli no type Aerobacter	E. coli no type	E. coli no type Aerobacter	E. coli Poly B 0126:B16	E. coli Poly B 0126:B16	E. coli no type	E. coli no type
35	E. coli Poly A NFT**	E. coli no type	E. coli Poly B NFT**	Aerobacter	E. coli Poly B 0126:B16	E. coli Poly B 0126:B16	E. coli no type	Aerobacter
36	E. coli no type	E. coli no type Aerobacter	E. coli Poly A 011:B4	E. coli, Poly A&B, NFT** Aerobacter	E. coli, Poly A&B, NFT** Proteus sp.	E. coli, Poly A&B, NFT** Aerobacter	E. coli No type	Alcaligenes Aerobacter Proteus sp.
Subject Number	Sampling Period							
	9	10	11	12	13	14	15	16
33	E. coli Poly A NFT**	E. coli no type	E. coli Poly A NFT**	E. coli Poly A NFT**	E. coli Poly A NFT**			
34	E. coli no type	Aerobacter E. coli no type	E. coli Poly B NFT**	E. coli Poly B NFT**	E. coli Poly B NFT**			
35	no spec.	E. coli no type	E. coli Poly A NFT**	E. coli no type				
36	Aerobacter Alcaligenes Proteus sp. E. coli, Poly A, NFT**	E. coli no type Proteus sp.	Proteus sp.	Alcaligenes Aerobacter				

* Room area, aft table - Protues sp.

** NFT = no further type

TABLE 14. OCCURRENCE OF E. COLI IN THE FECES

Exp. Number	Subject Number	Sampling Period													
		1	2	3	4	5	6	7	8	9	10	11	12	13	14
V	17	Saline +		Saline +	Saline +	Saline +	Saline +	Saline +	Saline +	Saline +	Saline +	Saline +			
	18	0119:B14	Saline +	Saline +	Saline +	Saline +	Saline +	Saline +	Saline +	Saline +	Saline +	Saline +			
		0119:B14	Saline +	Saline +	Saline +	Saline +	Saline +	Saline +	Saline +	Saline +	Saline +	Saline +			
	VI	20	74:011B	Saline +	Saline +	Saline +	Saline +	Saline +	Saline +	Saline +	Saline +	Saline +			
		21					0126:B15	0126:B15	0126:B15	0126:B15	0126:B15	0126:B15	0126:B15	0126:B15	0126:B15
		22	no type	no type	no type	0127:B8	no type	no type	no type	no type	no type	no type	no type	0126:B16	0126:B16
23		0127:B8	Saline +	0127:B8	no type	no type	0126:B16	no type	no type	no type	no type	no type	no type	no type	
VII	24	no type	no type	no type	no type	no type	no type	no type	no type	no type	no type	no type	no type	no type	
	25	Poly B	no type	no type	Poly B	no type	no type	no type	no type	no type	no type	no type	no type	no type	
	26														
	27														
	28	no type	no type	no type	no type	no type	no type	no type	no type	no type	no type	no type	no type	no type	
	29														
	VIII	30	no type	no type	no type	no type	no type	no type	no type	no type	no type	no type	no type	no type	no type
31		no type	Poly B 0124:	no type	Poly B	Poly A, 0127:	Poly A, 0127:	Poly A, 0127:	Poly A, 0127:	Poly A, 0127:	Poly A, 0127:	Poly A, 0127:	Poly A, 0127:	Poly A, 0127:	
32		no type	no type	no type	no type	no type	no type	no type	no type	no type	no type	no type	no type	no type	
IX	33	Poly A&B, no further type	no type	Poly A, no further type	Poly A, no further type	Poly A, no further type	Poly A, no further type	Poly A, no further type	Poly A, no further type	Poly A, no further type	Poly A, no further type	Poly A, no further type	Poly A, no further type	Poly A, no further type	
	34	no type	no type	no type	no type	no type	no type	no type	no type	no type	no type	no type	no type	no type	
	35	Poly A, no further type	no type	Poly B, no further type	Poly B, no further type	Poly B, no further type	Poly B, no further type	Poly B, no further type	Poly B, no further type	Poly B, no further type	Poly B, no further type	Poly B, no further type	Poly B, no further type	Poly B, no further type	
	36	no type	no type	no type	Poly A&B, no further type	Poly A&B, no further type	Poly A&B, no further type	Poly A&B, no further type	Poly A&B, no further type	Poly A&B, no further type	Poly A&B, no further type	Poly A&B, no further type	Poly A&B, no further type	Poly A&B, no further type	

TABLE 15. PATTERNS FOR UNIDENTIFIED CORYNEBACTERIA

Unidentified Pattern	Gelatin Liquefaction	Growth on Gelatin	Litmus Milk	Nitrate	Fermentation		Starch	
					Glucose	Sucrose	Growth	Hydrolysis
A	-	+	(no action)	-	-	-	+	-
A ¹	-	+	-	-	+	Acid	+	-
B*	-	+	-	+	+	Acid	+	-
B ^{1**}	-	+	-	+	+	Acid	+	-
B ²	-	heavy growth	ARC with beginning proteolysis	+	+	Acid	+	-
B ³	-	heavy growth	-	+	-	-	+	-
B ⁴	-	heavy growth	reduced	+	+	slight anaerobic acid	+	-

* This pattern seems to be related biochemically to both C. acnes and C. enzymicum, although there is no action on litmus milk. Gelatin liquefaction is absent.

** Pattern is the same as B except there is some acid produced from sucrose.

ARC = acid reduced curd

Contrails

TABLE 16. OCCURRENCE OF GRAM POSITIVE RODS
BY BODY AREA

Subject 17 - EXPERIMENT V

Body Area	Lactobacillae	Bacillaceae	Bacillus striatum	Corynebacterium				Pattern			
				S+(a)	pseudo(b)	enz.-(c)	xerosis	acnes	A	B Sp.	
Eye							3				
Ear			9								
Nose	7, 10, 12, 14										
Throat	3, 7, 8, 9, 10, 14, 16										
Axilla			11, 12, 13								
Umbilicus											
Groin			2, 3, 7, 9, 13, 14								
Anal Fold		13									
Feces	3, 8, 10, 11, 9, 12, 13, 14										
Scalp											
Mouth	3, 5, 10, 14					3					
Forearm											
Glans Penis											
Toes			3								

(a) Variety of C. striatum fermenting sucrose
 (b) pseudophtheriticum
 (c) C. enzymicum
 Numbers represent sampling period

TABLE 16 --- Continued
Subject 18 - EXPERIMENT V

Body Area	Lactobacillae	Bacillaceae	striatum	Corynebacterium					Pattern			
				S+(a)	pseudo (b)	enz-(c)	xerosis	acnes	A	B Sp.		
Eye								8,13				
Ear		7, 10, 13										
Nose	10		8, 10		4							
Throat	2, 3, 5, 10, 14											
Axilla			7, 10									
Umbilicus			7, 10, 12									
Groin												
Anal Fold												
Feces	1, 3, 4, 10, 11, 13			1, 9, 12								
Scalp		3										
Mouth												
Forearm												
Glans Penis							2, 3					
Toes												

(a) Variety of *C. striatum* fermenting sucrose
 (b) *pseudodiphtheriticum*
 (c) *C. enzymicum*
 Numbers represent sampling period

TABLE 16 --- Continued
 Subject 19 - EXPERIMENT V

Body Area	Lactobacillae	Bacillaceae	Bacillaceae striatum	Corynebacterium					Pattern			
				S+(a)	pseudo (b)	enz-(c)	xerosis	acnes	A	B Sp.		
Eye												
Ear					12				6			
Nose	9, 10, 12, 13, 14	7	7									
Throat	2, 3, 4, 10, 15		14		1, 2, 3, 4, 5, 7, 12							
Axilla												
Umbilicus												
Groin												
Anal Fold			5, 6, 7, 9, 11, 12									
Feces	10, 1, 8, 9, 11, 13		10		6							
Scalp												
Mouth					3							
Forearm												
Glans Penis					3, 4							
Toes			1, 3									

(a) Variety of *C. striatum* fermenting sucrose
 (b) *pseudodiphtheriticum*
 (c) *C. enzymicum*
 Numbers represent sampling period

Contrails

TABLE 16 ---- Continued
 Subject 20 - EXPERIMENT V

Body Area	Lactobacillae	Bacillaceae	Bacillaceae striatum	Corynebacterium					Pattern			
				S+(a)	pseudo (b)	enz-(c)	xerosis	acnes	A	B Sp.		
Eye								8				
Ear					7							
Nose	5, 10, 13	13										
Throat	3, 5, 7, 8, 9, 10, 14											
Axilla		10										
Umbilicus												
Groin						4						
Anal Fold						2, 3, 4, 12, 13, 14						
Feces	7, 8, 9, 10, 11, 4, 11											
Scalp												
Mouth	14											
Forearm												
Glans Penis			4, 5									
Toes			2, 3									

(a) Variety of C. striatum fermenting sucrose
 (b) pseudodiphtheriticum
 (c) C. enzymicum
 Numbers represent sampling period

TABLE 16 --- Continued
Subject 21 - EXPERIMENT VI

Body Area	Lactobacillae	Bacillaceae	Bacillaceae striatum	Corynebacterium					Pattern			
				S+(a)	pseudo (b)	enz-(c)	xerosis	acnes	A	B Sp.		
Eye									2			
Ear	5, 11, 12		11						12			
Nose	5				2, 10		14		7, 4			
Throat	3, 8, 9, 10, 14, 16		4						8			
Axilla					10				4, 14, 16			
Umbilicus									1			
Groin	5				10		14		6, 5			
Anal Fold												
Feces	1, 3, 4, 8, 9, 10, 11, 12, 13, 14		13						5, 1			
Scalp												
Mouth	3, 5, 10, 11, 13, 14								7			
Forearm												
Glans Penis					12							
Toes												

(a) Variety of *C. striatum* fermenting sucrose
 (b) *pseudodiphtheriticum*
 (c) *C. enzymicum*
 Numbers represent sampling period

TABLE 16 ---- Continued

Subject 22 - EXPERIMENT VI

Body Area	Lactobacillae	Bacillaceae	striatum	Corynebacterium					Pattern			
				S+(a)	pseudo (b)	enz-(c)	xerosis	acnes	A	B Sp.		
Eye												
Ear	13, 9											
Nose	14	4			2							
Throat	14, 12	12						3		2		
Axilla		14			12		14					
Umbilicus												
Groin	14				9		16	1, 5, 6, 7, 13				
Anal fold												
Feces	1, 4, 5, 9, 11, 13, 12							9				
Scalp												
Mouth	3				15			7, 6, 5				
Forearm												
Glans penis	5, 6, 8, 7, 12		14					12	3			
Toes	3	3, 2										

(a) Variety of C. striatum fermenting sucrose(b) pseudodiphtheriticum(c) C. enzymicum

Numbers represent sampling period

TABLE 16 --- Continued
 Subject 23 - EXPERIMENT VI

Body Area	Lactobacillae		Bacillaceae		Corynebacterium					Pattern	
	Lactobacillae	Bacillaceae	striatum	S+(a)	pseudo(b)	enz_(c)	xerosis	acnes	A	B	Sp.
Eye											
Ear		12, 5									
Nose								5			
Throat	15, 5, 11, 12	11, 12			2			3, 6			
Axilla		14			14						
Umbilicus	1	1	1						1		
Groin	11, 13, 10, 1	1					10, 15	4, 5			
Anal fold	1	1			4						
Feces	1, 4, 8, 3, 9, 11, 13, 6, 14	1, 9, 8						4, 5, 6, 7			
Scalp								3			
Mouth	2, 4	2, 4	11					8, 14			
Forearm	1	1									
Glans penis	11, 13, 9, 12, 6	7			12		1, 10	5, 3			
Toes								3			

(a) Variety of *C. striatum* fermenting sucrose
 (b) *pseudodiphtheriticum*
 (c) *C. enzymicum*
 Numbers represent sampling period

TABLE 16 --- Continued
 Subject 24 - EXPERIMENT VI

Body Area	Lactobacillae	Bacillaceae	Bacillaceae striatum	Corynebacterium					Pattern			
				S+(a)	pseudo (b)	enz-(c)	xerosis	acnes	A	B Sp.		
Eye												
Ear									5			
Nose					10				7, 4			
Throat	2, 3, 11, 14, 13 5		2, 5						12			
Axilla									8, 4, 12, 14			
Umbilicus			1, 2							2		
Groin	14		13						1, 3, 4, 16, 13			
Anal fold	2, 1		3						1, 2			
Feces	1, 4, 11, 2, 9		1		7			10	5, 6, 9			
Scalp									3			
Mouth	14, 7, 5, 4											
Forearm	2		2						1			
Glans penis	8, 14, 5		14		12				2, 6			
Toes									3			

(a) Variety of *C. striatum* fermenting sucrose
 (b) *pseudodiphtheriticum*
 (c) *C. enzymicum*
 Numbers represent sampling period

TABLE 16 --- Continued
 Subject 25 - EXPERIMENT VII

Body Area	Lactobacillae	Bacillaceae	Bacillaceae striatum	Corynebacterium					Pattern			
				S+(a)	pseudo(b)	enz_(c)	xerosis	acnes	A	B Sp.		
Eye												
Ear		8, 16								6, 8-16		
Nose			2, 3, 5-16									
Throat	3, 7-10				1, 3-5, 7-9 11, 12, 14-16							
Axilla		6										
Umbilicus												
Groin			9, 11							2, 4-7, 9-16		
Anal fold										1-3		
Feces	5, 10											
Scalp										1		
Mouth	1, 3, 5-10				1, 5, 6, 8- 11, 14, 15							
Forearm		2										
Glans penis			4, 6-16									
Toes				1, 2, 3								

(a) Variety of C. striatum fermenting sucrose
 (b) pseudodiphtheriticum
 (c) C. enzymicum
 Numbers represent sampling period

TABLE 16 --- Continued
 Subject 26 - EXPERIMENT VII

Body Area	Lactobacillae	Bacillaceae	Corynebacterium					Pattern				
			striatum	S+(a)	pseudo(b)	enz-(c)	xerosis	acnes	A	B Sp.		
Eye												
Ear											1-10, 12,14, 15	
Nose				13,14, 16							2,9-11, 14	4,6,7, 8,13
Throat	1,3,6											1-4,7- 12,14, 15
Axilla		4									7,8,13, 14,16	
Umbilicus												
Groin				2-16								
Anal fold				1,2								
Feces	3											3
Scalp												
Mouth						1-6,8-12, 14,15						
Forearm												3
Glans penis			12-14,16	2,4,6-11								
Toes												1,2,3

(a) Variety of *C. striatum* fermenting sucrose
 (b) *pseudodiphtheriticum*
 (c) *C. enzymicum*
 Numbers represent sampling period

TABLE 16 ---- Continued
Subject 27 - EXPERIMENT VII

Body Area	Lactobacillae	Bacillaceae	Bacillaceae	striatum	Corynebacterium					Pattern		
					S+(a)	pseudo(b)	enz_(c)	xerosis	acnes	A	B	Sp.
Eye												
Ear			6								2-6, 8-15	
Nose							1-9, 11-14, 15					
Throat	1-13		13				1, 4, 6, 8- 10, 12, 14, 15					
Axilla				4, 5, 12, 13-16							6-11	
Umbilicus			1									
Groin				8-13, 15							2, 4-7	
Anal fold				1-3								
Feces	1-8, 10-13											
Scalp												3
Mouth	3-8, 10-12, 15											1, 4-11, 15
Forearm												
Glans penis					3, 4, 6, 8, 9, 10-16							
Toes					1							

(a) Variety of *C. striatum* fermenting sucrose
 (b) *pseudodiphtheriticum*
 (c) *C. enzymicum*
 Numbers represent sampling period

TABLE 16 ---- Continued
Subject 28 - EXPERIMENT VII

Body Area	Lactobacillae				Corynebacterium				Pattern	
	Bacillaceae	striatum	S+(a)	pseudo(b)	enz-(c)	xerosis	acnes	A	B	Sp.
Eye										
Ear										7,13, 14,16
Nose										14,16
Throat	8		1,3,4-9 11,13, 14,15							
Axilla		12						2,4,5, 6,7, 9-16		
Umbilicus										
Groin								4,5, 7-16		
Anal fold								1,2		
Feces	1,9									
Scalp		8,10								
Mouth							4,5,6-8, 10-12,14, 15			
Forearm										
Glans penis			4,6-16							
Toes								1,2,3		

(a) Variety of *C. striatum* fermenting sucrose
 (b) *pseudodiphtheriticum*
 (c) *C. enzymicum*
 Numbers represent sampling period

TABLE 16 --- Continued
Subject 29 - EXPERIMENT VIII

Body Area	Lactobacillae	Bacillaceae	striatum	Corynebacterium					Pattern				
				S+(a)	pseudo (b)	enz-(c)	xerosis	acnes	A	B	Sp.		
Eye													
Ear					15								
Nose		14	8		5, 7, 10, 13, 15, 16						10, 14		
Throat		3, 7	10								14		
Axilla			2, 6	2, 5, 6, 10, 15									
Umbilicus				3									
Groin		13	2, 5	16									
Anal fold					1		9					1, 2, 3	9(3)
Feces	13		13, 14		13		7, 11						11(3)
Scalp				3							6		
Mouth													
Forearm													
Glans penis				4, 12, 16									
Toes				1									

(a) Variety of C. striatum fermenting sucrose
 (b) pseudodiphtheriticum
 (c) C. enzymicum
 Numbers represent sampling period
 (3) C. hoagii

TABLE 16 --- Continued

Subject 30 - EXPERIMENT VIII

Body Area	Lactobacillae	Bacillaceae	striatum	Corynebacterium					Pattern			
				S+(a)	pseudo(b)	enz-(c)	xerosis	acnes	A	B Sp.		
Eye												
Ear												15
Nose				1,7	10	5,6,14						2,7,8, 16
Throat												
Axilla				1,2,6- 8,10,15								
Umbilicus												
Groin				2,3,4, 6,9,16	15							
Anal fold												3(1)
Feces	1,2,5,13				3					16		
Scalp												
Mouth												
Forearm												
Glans penis				1,5,6, 14,16						9		
Toes												1

(a) Variety of C. striatum fermenting sucrose(b) pseudodiphtheriticum(c) C. enzymicum

Numbers represent sampling period

(1) C. avidum

TABLE 16 ---- Continued
Subject 31 - EXPERIMENT VIII

Body Area	Lactobacillae	Bacillaceae	Bacillaceae striatum	Corynebacterium					Pattern			
				S+(a)	pseudo (b)	enz-(c)	xerosis	acnes	A	B Sp.		
Eye												
Ear			4									
Nose				1, 9						3, 16		
Throat	1, 2		14									
Axilla			5, 14-16	14		15					2, 3, 10	
Umbilicus				2		9					11, 13, 16	
Groin				1, 2, 5-9 14-16								
Anal Fold				1-3		9						
Feces	2, 13											
Scalp												
Mouth												
Forearm												
Glans Penis				1, 2, 5, 7-9 11, 12, 16		10, 15						
Toes												

(a) Variety of *C. striatum* fermenting sucrose
 (b) *pseudodiphtheriticum*
 (c) *C. enzymicum*
 Numbers represent sampling period

TABLE 16 --- Continued
Subject 32 - EXPERIMENT VIII

Body Area	Lactobacillae	Bacillaceae	Bacillaceae striatum	Corynebacterium					Pattern			
				S+(a)	pseudo (b)	enz. (c)	xerosis	acnes	A	B	Sp.	
Eye												
Ear				1								
Nose				1, 2, 14	5, 7, 8 13-15	2						
Throat	1											
Axilla			11, 13, 14, 16									
Umbilicus												
Groin		13	11	3, 5, 6		2, 4						1(4)
Anal Fold											1, 3	
Feces			1		5	5						1(4)
Scalp									9			
Mouth	7, 14	1, 16										
Forearm												
Glans Penis			6, 11	4		3, 8						6(2), 13
Toes				3								1, 3

(a) Variety of *C. striatum* fermenting sucrose
 (b) *pseudodiphtheriticum*
 (c) *C. enzymicum*
 Numbers represent sampling period

(1) *C. avidum*, (2) *C. pyogenes*, (3) *C. hoagii*, (4) *C. acnes*

TABLE 16 --- Continued
 Subject 33 - EXPERIMENT IX

Body Area	Lacto-bacillae	Corynebacterium					Pattern					
		striatum	pseudo (b)	enz-(c)	xerosis	A	A ¹	B	B ¹	B ²	B ³	B ⁴
Scalp		12				12						
Ear			12			12						
Eye						2						
Nose *		3, 10	1, 4, 6, 7, 12	2(R)		6, 7, 11						
Gingival					1	3, 5						
Throat	11	7	1	7(R)								
Axilla						1, 4, 6, 7		5				
Forearm			2		9							
Umbilicus		12				2, 9, 12		12				
Groin		1, 3, 6, 7, 9, 10, 11			2, 3	6, 9, 10, 12	4, 5	4, 9, 11				
Glans penis		6, 8, 9, 12	2, 7, 11		10	1, 3, 4, 5, 6, 10, 11, 12			7			
Anal fold		1, 2, 3, 8, 12	7		2, 9	4, 5, 6, 10	4	4, 11, 12	1, 6		5, 6	
Feces	1-3, 7, 8, 12											
Toes		9, 10	7			6, 8, 11, 12						

* Bacillaceae 5th sampling period
 (b) pseudodiphtheriticum
 (c) C. enzymicum
 Numbers represent sampling period
 (R) This pattern seems to be biochemically related to C. enzymicum although the action on nitrate is absent.

TABLE 16 ---- Continued
 Subject 34 - EXPERIMENT IX

Body Area	Lacto- bacillaeae	Corynebacterium				Pattern							
		striatum	pseudo (b)	enz-(c)	xerosis	A	A ¹	B	B ¹	B ²	B ³	B ⁴	
Scalp						2							
Ear						9, 12							
Eye													
Nose		7	1, 3, 6, 7, 8			2, 3, 4, 9 10, 12		11					
Gingival *	1, 4-8, 10-12							12				5	6
Throat	1-10, 12					3							
Axilla *		2, 4, 9, 11, 12				1, 3, 5, 8, 10, 12	5					8	
Forearm		12							12				
Umbilicus			12			3	2						
Groin		2, 4, 5, 6, 8	7	8(R)		1, 3, 10, 11		10, 11, 12	1, 2, 4, 5, 8				
Glans penis		4, 5, 7	10, 2		1, 3	2, 6, 8, 11	5	12	8, 9, 11			6	
Anal fold		1, 2, 3, 4, 6, 7, 8, 9, 12				3, 4, 6	9						
Feces	1, 2, 4, 5, 7, 10-12												
Toes				4		6, 7, 8							11

* Bacillaceae - Gingival 4 & 8 sampling period; Axilla 6th sampling period.
 (b) pseudodiphtheriticum
 (c) C. enzymicum
 (R) This pattern seems to be biochemically related to C. enzymicum although the action on nitrate is absent.
 Numbers represent sampling period

TABLE 16 --- Continued
 Subject 35 - EXPERIMENT IX

Body Area	Lacto- bacillae	Corynebacterium				Pattern							
		striatum	pseudo (b)	enz-(c)	xerosis	A	A ¹	B	B ¹	B ²	B ³	B ⁴	
Scalp													
Ear													
Eye													
Nose		8			1, 2, 3, 5								6
Gingival	4, 5, 7, 10-12					5		11					
Throat	1-3, 5, 6, 9-11				9								
Axilla		4, 8, 12			3, 12				8, 11				
Forearm													
Umbilicus						2, 9							
Groin		6, 7, 8, 11 12			10, 12				1, 2, 5, 9 10				7
Glans penis		7	12		2, 5, 6					2	8		
Anal fold		1, 2, 4, 5, 6, 7, 8, 10			1, 10, 12	4, 5, 6, 8		11	3, 4				
Feces	2, 3, 4-8, 10-12	10, 12											
Toes		4, 7	5		2*, 3, 4				10	1			

(b) *pseudodiphtheriticum*

(c) *C. enzymicum*

Numbers represent sampling period

* Reacts biochemically like A in that it showed no action on carbohydrates and nitrates but showed proteolytic activity on litmus milk and Loeffler's blood serum although it failed to liquify gelatin at the end of seven days.

TABLE 16 --- Concluded

Subject 36 - EXPERIMENT IX

Body Area	Lacto-bacillae	Corynebacterium					Pattern					
		striatum	pseudo (b)	enz-(c)	xerosis	A	A ¹	B	B ¹	B ²	B ³	B ⁴
Scalp						2						
Ear						2, 9, 12						
Eye												
Nose			2, 3, 4, 5, 8 9, 10, 11	3		1	9		9			
Gingival	10			3(R)								
Throat												
Axilla						2, 6, 10, 11						
Forearm						9						
Umbilicus									9, 12			
Groin		1, 8, 10, 11 12		7(R)	2, 9	2, 3, 5, 9, 10						
Glans penis		4, 5, 6, 8, 9, 10, 12		7(R)	5	9, 11				6		
Anal fold		1, 2, 3, 4, 5, 6, 7, 8, 9	12		10	9	6, 7					
Feces	8-12											
Toes		6, 9, 10, 11 12				11	6, 9	12				

(b) pseudodiphtheriticum

(c) C. enzymicum

(R) This pattern seems to be biochemically related to C. enzymicum although the action on nitrate is absent. Numbers represent sampling period

TABLE 17. OCCURRENCE OF GRAM POSITIVE RODS
BY SAMPLING PERIOD
Subject 17 - EXPERIMENT V

Sampling Period	Lactobacillaeae	Bacillaceae	Corynebacterium						Pattern			
			striatum	S+(a)	pseudo (b)	enz-(c)	xerosis	acnes	A	B Sp.		
1												
2			groin									
3	feces, mouth throat		groin foes		mouth			eye				
4												
5	mouth											
6												
7	nose, throat		groin									
8	throat, feces											
9	feces, throat		groin, ear									
10	nose, throat mouth, feces											
11	feces		axilla									
12	nose, feces		axilla									
13	feces	anal fold	groin axilla									
14	nose, throat mouth		groin									
15												
16	throat											

(a) Variety of C. striatum fermenting sucrose
(b) pseudoptheriticum
(c) C. enzymicum

TABLE 17 --- Continued

Subject 18 - EXPERIMENT V

Sampling Period	Lactobacillae	Bacillaceae	Corynebacterium					Pattern				
			striatum	S+(a)	pseudo(b)	enz-(c)	xerosis	acnes	A	B Sp.		
1	feces	anal fold										
2	throat				glans penis							
3	throat, feces	scalp			glans penis							
4	feces				nose							
5	throat											
6												
7		ear	axilla umbilicus									
8			nose					eye				
9		anal fold										
10	nose, throat feces	ear	axilla umbilicus nose									
11	feces											
12		anal fold	umbilicus									
13	feces	ear						eye				
14	throat											

(a) Variety of C. striatum fermenting sucrose(b) pseudodiphtheriticum(c) C. enzymicum

TABLE 17 ---- Continued
Subject 19 - EXPERIMENT V

Sampling Period	Lactobacillae	Bacillaceae	Corynebacterium					Pattern				
			striatum	S+(a)	pseudo(b)	enz-(c)	xerosis	acnes	A	B Sp.		
1	feces		toes		throat							
2	throat				throat							
3	throat		toes		glans penis mouth throat							
4	throat				glans penis throat							
5			anal fold		throat							
6			anal fold		feces			ear				ear
7		nose	nose anal fold		throat							
8	feces											
9	nose, feces		anal fold							groin		
10	nose, throat feces		feces							groin		
11	feces		anal fold									
12	nose		anal fold		throat, ear					umbil.		
13	nose, feces									groin		
14	nose		throat									
15	throat											
16												

(a) Variety of C. striatum fermenting sucrose
(b) pseudodiphtheriticum
(c) C. enzymicum

TABLE 17 --- Continued
Subject 20 - EXPERIMENT V

Sampling Period	Lactobacillae	Bacillaceae	Bacillaceae	Corynebacterium				Pattern					
				striatum	S+(a)	pseudo (b)	enz-(c)	xerosis	acnes	A	B Sp.		
1	feces												
2				toes			anal fold						
3	throat			toes			anal fold						
4	feces			glans penis			anal fold groin						
5	nose, throat			glans penis									
6													
7	throat, feces						ear						
8	throat, feces								eye				
9	throat, feces												
10	nose, throat, feces												
11	feces												
12													
13	nose												
14	throat, mouth												
15													
16													

(a) Variety of C. striatum fermenting sucrose
 (b) pseudodiphtheriticum
 (c) C. enzymicum

TABLE 17 --- Continued
 Subject 21 - EXPERIMENT VI

Sampling Period	Lactobacillae	Bacillaceae	Corynebacterium				Pattern					
			striatum	S+(a)	pseudo (b)	enz-(c)	xerosis	acnes	A	B	Sp.	
1	feces								umbil. feces			
2					nose				eye			
3	throat, feces, mouth											
4	feces	throat							nose			
5	ear, nose groin, mouth								axilla groin feces			
6									groin			
7									nose mouth throat			
8	throat, feces											
9	throat, feces											
10	throat, feces mouth											
11	ear, feces, mouth	ear							nose, groin axilla			
12	feces, ear								glans penis			
13	feces, mouth	feces							ear			
14	throat, feces mouth											
15									nose groin			
16	throat											

(a) Variety of C. striatum fermenting sucrose
 (b) pseudodiphtheriticum
 (c) C. enzymicum

TABLE 17 --- Continued
Subject 22 - EXPERIMENT VI

Sampling Period	Lactobacillaeae	Bacillaceae	Corynebacterium					Pattern				
			striatum	S+(a)	pseudo(b)	enz-(c)	xerosis	acnes	A	B Sp.		
1	feces							groin				
2		toes			nose					throat		
3	mouth, toe	toes						throat glans penis				
4	feces	nose										
5	feces							groin mouth				
6	glans penis							groin mouth				
7	glans penis							groin mouth				
8	glans penis											
9	feces, ear				groin					feces		
10												
11	feces											
12	feces, throat	throat										
13	glans penis									glans penis		
14	ear, feces							axilla				
15	nose, throat	axilla								axilla		
16	groin				mouth							
16										groin		

(a) Variety of C. striatum fermenting sucrose
 (b) pseudodiphtheriticum
 (c) C. enzymicum

TABLE 17 --- Continued
 Subject 23 - EXPERIMENT VI

Sampling Period	Lactobacillaeae	Bacillaceae	Corynebacterium					Pattern		
			striatum	S+(a)	pseudo(b)	enz_(c)	xerosis	acnes	A	B Sp.
1	feces, anal groin, umbil. forearm	umbil, groin, umbilicus feces, anal, forearm					glans penis	feces	umbil	
2	mouth	mouth			throat					
3	feces							throat scalp g. p. toes		
4	feces, mouth	mouth			anal fold			groin feces		
5	throat	ear						nose, g.p. feces groin		
6	feces glans penis							throat feces		
7		glans penis						feces		
8	feces	feces						mouth		
9	feces	feces								
10	glans penis groin									
11	groin, throat feces, g. p.	throat	mouth							
12	throat, g. p.	ear, throat			glans penis					
13	groin, feces									
14	glans penis feces	axilla			axilla					
15	throat							mouth		

(a) Variety of C. striatum fermenting sucrose
 (b) pseudodiphtheriticum
 (c) C. enzymicum

TABLE 17 --- Continued
 Subject 24 - EXPERIMENT VI

Sampling Period	Lactobacillaeae	Bacillaceae	Corynebacterium				Pattern					
			striatum	S+(a)	pseudo (b)	enz-(c)	xerosis	acnes	A	B	Sp.	
1	feces, anal	umbilicus feces						groin anal fold forearm				
2	anal fold feces, throat forearm	throat umbilicus forearm						anal fold G.P.	umbil.			
3	throat	anal fold						groin, bes scalp				
4	feces, mouth							groin nose, axilla				
5	throat, mouth glans penis	throat						ear, feces				
6								feces, GP				
7	mouth				feces			nose				
8	glans penis							axilla				
9	feces							feces				
10					nose			feces				
11	throat, feces											
12					glans penis							
13	throat	groin						thr, axil.				
14	throat, groin G.P., mouth	glans penis						groin axilla				
15												
16								groin				

(a) Variety of C. striatum fermenting sucrose

(b) pseudodiphtheriticum

(c) C. enzymicum

TABLE 17 --- Continued
 Subject 25 - EXPERIMENT VII

Sampling Period	Lactobacillaeae	Bacillaceae	Corynebacterium				Pattern				
			striatum	S+(a)	pseudo (b)	enz-(c)	xerosis	acnes	A	B	Sp.
1	mouth			toes	throat mouth					anal	
2		forearm	nose	toes						scalp	
3	throat, mouth		nose	toes	throat					groin	
4			g.p.		throat					anal	
5	feces, mouth		nose		throat mouth					groin	
6	mouth	axilla	nose, g. p.		mouth					groin	
7	throat, mouth		nose, g. p.		throat					ear	
8	throat, mouth	ear	nose, g. p.		throat mouth					groin	
9	throat, mouth		nose, g. p.		throat mouth					ear	
10	throat, mouth feces		nose, g. p.		mouth					groin	
11			nose, g. p.		throat					ear	
12			groin		mouth					groin	
13			nose, g. p.		throat					ear	
14			nose, g. p.							groin	
15			nose, g. p.		throat mouth					ear	
16		ear	nose, g. p.		throat mouth					groin	

(a) Variety of C. striatum fermenting sucrose
 (b) pseudodiphtheriticum
 (c) C. enzymicum

TABLE 17 --- Continued
 Subject 26 - EXPERIMENT VII

Sampling Period	Lactobacillae	Bacillaceae	Corynebacterium					Pattern		
			striatum	S+(a)	pseudo (b)	enz_(c)	xerosis	acnes	A	B Sp.
1	throat			anal	mouth				ear	throat, toes
2				groin	mouth				ear	throat
3	throat, feces			anal, gp	mouth				nose	toes
4				groin	mouth				ear	throat, toes
5		axilla		g. p.	mouth					forearm
6	throat			groin	mouth				ear	scalp
7				g. p.	mouth				ear	nose
8				groin	mouth				ear	throat
9				g. p.	mouth				axilla	nose
10				groin	mouth				ear	throat
11				g. p.	mouth				nose	throat
12				groin	mouth				ear	throat
13			G. P.	nose	mouth				axilla	nose
14			G. P.	groin	mouth				axilla	throat
15				nose	mouth				ear	throat
16			G. P.	groin	mouth				axilla	throat

(a) Variety of C. striatum fermenting sucrose; (b) pseudodiphtheriticum; (c) C. enzymicum

TABLE 17 --- Continued
Subject 27 - EXPERIMENT VII

Sampling Period	Lactobacillae	Bacillaceae	Corynebacterium						Pattern		
			striatum	S+(a)	pseudo (b)	enz-(c)	xerosis	acnes	A	B	Sp.
1	throat, feces	umbilicus	anal fold		nose, thr					ear,gr	mouth
2	throat, feces		anal fold		nose					ear	scalp
3	thr, fec, mouth		anal fold	g.p.	nose					ear	mouth
4	throat, feces		axilla	glans penis	throat					groin	mouth
5	throat, feces		axilla		nose					ear	mouth
6	throat, feces	ear		glans penis	nose throat					ear	mouth
7	throat, feces				nose					axilla	mouth
8	throat, feces		groin	glans penis	nose throat					groin	mouth
9	throat		groin	glans penis	nose throat					ear	mouth
10	throat, feces		groin	glans penis	throat					axilla	mouth
11	throat, feces		groin	glans penis	throat					ear	mouth
12	throat, feces		axilla	glans penis	nose					axilla	mouth
13	throat, feces	throat	ax, groin	g.p.	nose					ear	
14			axilla	glans penis	nose					ear	
15	mouth		axilla	glans penis	throat					ear	mouth
16			axilla	g.p.	nose throat						

(a) Variety of C. striatum fermenting sucrose
 (b) pseudodiphtheriticum
 (c) C. enzymicum

TABLE 17 --- Continued
Subject 28 - EXPERIMENT VII

Sampling Period	Lactobacillae	Bacillaceae	Corynebacterium					Pattern			
			striatum	S+(a)	pseudo(b)	enz-(c)	xerosis	acnes	A	B Sp.	
1	feces			throat						anal	
2										toes	
3				throat						axilla	
4				throat g.p.	mouth					anal	
5				throat	mouth					toes	
6				throat g.p.	mouth					toes	
7				throat g.p.	mouth					axilla	
8	throat	feces		throat g.p.	mouth					axilla	ear
9	feces			throat						groin	
10		feces		g.p.	mouth					groin	
11				throat	mouth					axilla	
12		throat		g.p.	mouth					groin	
13				throat						axilla	ear
14				g.p.	mouth					groin	ear
15				throat g.p.	mouth					axilla	nose
16				throat g.p.						axilla	

TABLE 17 --- Continued

Subject 29 - EXPERIMENT VIII

Sampling Period	Lactobacillaeae	Bacillaceae	Corynebacterium					Pattern			
			striatum	S+(a)	pseudo (b)	enz-(c)	xerosis	acnes	A	B Sp.	
1				toes	anal					anal	
2			axilla groin	axilla						anal	
3		throat		scalp umbil						anal	
4				g.p.							
5			groin	axilla	nose						
6			axilla	axilla						mouth	
7		throat			nose	feces					
8			nose								
9						anal					anal(3)
10			throat	axilla	nose					nose	
11						feces					feces(3)
12				g.p.							
13	feces	groin	feces		nose feces						
14		nose	feces							nose throat	
15				axilla	nose, ear						
16				groin g.p.	nose						

(a) Variety of C. striatum fermenting sucrose
 (b) pseudodiphtheriticum
 (c) C. enzymicum
 (1) C. avidum, (2) C. pyogenes, (3) C. hoagii

TABLE 17 --- Continued
Subject 30 - EXPERIMENT VIII

Sampling Period	Lactobacillae	Bacillaceae	striatum	Corynebacterium					Pattern				
				S+(a)	pseudo (b)	enz-(c)	xerosis	acnes	A	B	Sp.		
1	feces		anal toes	nose axilla g.p.									toes
2	feces		toes	axilla groin									nose
3			anal toes	groin feces									feces ¹
4				groin									
5	feces			g.p.			nose						
6				axilla groin g.p.			nose						
7				nose axilla									nose
8				axilla									nose
9			g.p.	groin						g.p.			
10			feces	axilla nose									
11			feces										
12													
13	feces		feces										
14				g.p.			nose						
15				axilla groin									ear
16				groin g.p.						scalp			nose

(a) Variety of C. striatum fermenting sucrose
 (b) pseudodiphthericum
 (c) C. enzymicum
 (1) C. avidum

TABLE 17 --- Continued

Subject 31 - EXPERIMENT VIII

Sampling Period	Lactobacillaeae	Bacillaceae	Corynebacterium						Pattern			
			striatum	S+(a)	pseudo (b)	enz-(c)	xerosis	acnes	A	B Sp.		
1	throat			anal groin g.p. nose								
2	throat mouth feces			anal groin g.p.							axilla	
3				umbil. anal			anal			nose	axilla	
4			ear									
5			axilla	groin g.p.								
6												
7				groin g.p.								
8				groin g.p.								
9				groin g.p. nose			umbilicus g.p.					
10											axilla	
11											axilla	
12												
13	feces										axilla	
14			throat axilla axilla	axilla groin groin								
15							g.p. axilla					
16			axilla	groin g.p.						nose	axilla	

(a) Variety of C. striatum fermenting sucrose (b) pseudodiphtheriticum; (c) C. enzymicum

TABLE 17 --- Continued
Subject 32 - EXPERIMENT VIII

Sampling Period	Lactobacillae		Corynebacterium				Pattern				
	feces, throat	Bacillaceae	striatum	S+(a)	pseudo(b)	enz-(c)	xerosis	acnes	A	B	Sp.
1		mouth		nose ear				groin scalp		anal	toe
2				nose		g.p. groin nose				groin	
3				groin toe						anal	toe
4				g.p.		groin					
5				groin	nose	feces					
6	feces		g.p.	groin	feces						g.p.Ⓞ
7	mouth			groin	nose						
8					nose	g.p.					
9					nose				scalp		
10											
11			axilla groin g.p.								
12											
13		groin	axilla		nose						g.p.
14	mouth		axilla	nose	nose						
15					nose						
16		mouth	axilla								

(a) Variety of C. striatum fermenting sucrose
 (b) pseudodiphtheriticum
 (c) C. enzymicum
 (1) C. avidum, (2) C. pyogenes, (3) C. hoagii

TABLE 17 --- Continued
Subject 33 - EXPERIMENT IX

Sampling Period	Lacto-bacillus	Bacill-laceae	Corynebacterium						Pattern		
			striatum	S+(a)	pseudo (b)	enz-(c)	xerosis	acnes	A	B	
1	feces		groin, anal		nose, throat			gingival		g.p., axilla	anal (1)
2	feces		anal		g.p., forearm	nose(R)		anal, groin		umbil, eye	
3	feces		groin, nose anal					groin		g.p., gingival	
4					nose					anal(1), anal axilla, g.p. groin (1)	anal, groin
5		nose								groin (1) gingival, g.p., anal	anal (3) axilla
6			g.p., groin		nose					groin, nose g.p., toe axilla, anal	anal(3) anal (1)
7	feces		groin, throat		toe, g.p.	throat(R)				axilla, nose	g.p. (1)
8	feces		groin, anal		anal, nose					toe	
9			toe, g.p. groin					forearm anal fold		groin umbilicus	groin
10			toe, nose groin					glans penis		anal, g.p. groin	
11	throat		groin		glans penis					toe, nose, glans penis	anal fold glans penis
12	feces		scalp, anal g.p., umbili		nose, ear					scalp, g.p. groin, ear umbilicus toe	anal fold umbilicus

(a) Variety of C. striatum fermenting sucrose (b) pseudodiphtheriticum, (c) C. enzymicum

(R) This pattern seems to be biochemically related to C. enzymicum although the action on nitrate is absent

* Number in parenthesis indicates pattern (A¹, B¹, B², etc.). See Table 14 for pattern description.

TABLE 17 --- Continued
Subject 34 - EXPERIMENT IX

Sampling Period	Lacto-bacillae	Bacil-laceae	Corynebacterium						Pattern*		
			striatum	S+(a)	pseudo (b)	enz-(c)	xerosis	acnes	A	B	
1	th, gin, fec		anal fold		nose			glans penis		axilla, groin	groin (1)
2	throat feces		axilla groin, anal							g.p., nose umbilicus(1) scalp	groin (1)
3	throat		anal fold		nose			glans penis		axilla, nose throat, g.p. groin, anal	
4	throat, gin, fec	gingival	groin, anal axilla, g.p.					toe		nose, anal	groin (1)
5	thr, feces gingival		groin, g.p.							axilla, g.p.(1) axilla (1)	gingival(2) groin (1)
6	throat gingival	axilla	groin, anal		nose					toe, anal glans penis	g.p. (2) gingival (4)
7	throat, fec gingival		anal, nose glans penis		groin, nose					toe	
8	throat gingival	gingival	groin, anal		nose		groin(R)			g.p., toe anal fold	axilla (2) groin(1), g.p. (1)
9	throat		axilla, anal							nose, ear anal (1)	g.p. (1)
10	thr, feces gingival				glans penis					axilla, nose groin	groin
11	gingival feces		axilla							glans penis groin	g.p. (1), nose groin, toe(3)
12	throat gingival feces		anal, axilla forearm		umbilicus glans penis					axilla nose, ear	groin, g.p. forearm (1) gingival

(a) Variety of *C. striatum* fermenting sucrose (b) pseudodiphtheriticum, (c) *C. enzymicum*
 (R) This pattern seems to be biochemically related to *C. enzymicum* although the action on nitrate is absent
 * Number in parenthesis indicates pattern (A¹, B¹, B², etc.). See Table 14 for pattern description.

TABLE 17 --- Continued
Subject 35 - EXPERIMENT IX

Sampling Period	Lacto-bacillaeae	Bacil-laceae	striatum	Corynebacterium				Pattern*		
				S+(a)	pseudo (b)	enz-(c)	xerosis	acnes	A	B
1	throat		anal fold				glans penis		nose, anal	toe(2), groin(1)
2	throat feces		anal fold						toe**, nose umbil, g. p.	g. p. (2) groin (1)
3	throat feces						groin, anal		nose, toe axilla	anal (1)
4	gingival		toe, anal axilla						toe, anal(1)	anal fold (1)
5	throat gingival feces		anal fold		toe				anal (1) gingival(1) g. p., nose	groin (1)
6	thr, feces		anal, groin						g. p., anal(1)	nose (4) groin (4)
7	gingival feces		anal, g. p. toe, groin							
8	feces		anal, groin groin		nose				anal (1)	axilla (1) g. p. (3)
9	throat						glans penis		umbil, throat	groin (1)
10	thr, feces gingival		feces, anal						anal, groin	toe (1) groin (1)
11	thr, feces gingival		groin							axilla (1) anal, Gingival
12	gingival feces		axilla, feces groin		glans penis				axilla, anal groin	

* Number in parenthesis indicates pattern (A¹, B¹, B², etc.). See Table 14 for pattern description.

** Reacts biochemically like Pattern A in that it showed no action on carbohydrates and nitrates but showed proteolytic activity on litmus milk and Loeffler's blood serum although it failed to liquify gelatin at the end of seven days.

TABLE 17 --- Concluded
Subject 36 - EXPERIMENT IX

Sampling Period	Lacto-bacillae	Bacil-laceae	Corynebacterium					Pattern*			
			striatum	S+(a)	pseudo (b)	enz-(c)	xerosis	acnes	A	B	
1			anal, groin						nose		
2			anal		nose			groin	groin, ear axilla, scalp		
3			anal		nose	gingi(R)		nose	groin		
4			anal, g.p.		nose						
5			g.p., anal		nose			glans penis	groin	throat(4), (1)	
6			toe, anal, g.p.						axilla toe(1), anal(1)	glans penis(2)	
7			anal fold			g.p. (R) groin (R)			anal fold (1)		
8	feces		groin, g.p. anal fold		nose						
9	feces		toe, anal g.p.		nose			groin	groin, ear glans penis anal, toe(1) forearm umbilicus (1)	nose(1)	
10	gingival feces		toe, g.p. groin		nose			anal fold	axilla, groin		
11	feces		groin, toe		nose				g.p., toe axilla		
12	feces		toe, groin glans penis		anal fold				umbilicus(1) ear	toe	

* Number in parenthesis indicates pattern (A¹, B¹, B², etc.). See Table 14 for pattern description.
(R) This pattern seems to be biochemically related to C. enzymicum although the action on nitrate is absent

TABLE 18. INCIDENCE OF CORYNEBACTERIA AND STAPHYLOCOCCI
IN SELECTED BODY AREAS

Subject 17

	Sampling Period													
	1	2	3	4	5	6	7	8	9	10	11	12	13	14
Coryn. Ear	0		0	0	0	0	20		0	0	0	0	0	0
Staph.	0		0	0	160	0	0		0	0	10	10	0	0
Coryn. Nose	>3000	530	0	0	10	0			170	1380	30	1500	120	100
Staph.	20	0	0	0	720	380			2050	1000	11	400	600	1250
Coryn. Groin	>5000	>3000	1400	10	>5000	>3000	120		2500	0	2000	1100	2000	TNTC
Staph.	>5000	>3000	0	TNTC	4000	600	40		270	5180	1000	1260	200	300
Coryn. G. P.	>7000	0		0										
Staph.	100	10		0										
Coryn. Axilla	250	340	0	0	60	190	40		0	10	0	0	0	40
Staph.	40	0	0	0	0	410	0		60	260	180	220	110	140
Coryn. Toes	2000	300		0										
Staph.	2000	210		100										

TABLE 18 --- Continued

Subject 18

	Sampling Period													
	1	2	3	4	5	6	7	8	9	10	11	12	13	14
Coryn. Ear	>5120	200	500	0	0	0	0		3000	0	30	320	TNTC	140
Staph.	~500	>2000	40	330	0	780	110		350	40	0	140	1150	100
Coryn. Nose	>5000	1000	30	0	650	0			1500	0	0	0	600	0
Staph.	>2500	120	10	0	260	20			1500	1000	530	0	600	1250
Coryn. Groin	1000	1000	20	10	0	~1000	50		100	0	0	40	0	
Staph.	160	500	20	30	0	2190	90		150	1020	1040	350	300	
Coryn. G. P.	>5000	0		0										
Staph.	340	0		10										
Coryn. Axilla	50	0	0	0	0	0	0		0	0	20	0	0	0
Staph.	160	0	30	0	20	20	60		70	60	10	20	0	0
Coryn. Toes	~500	0		0										
Staph.	2000	10		0										

Continued

TABLE 18 --- Continued

Subject 19

	Sampling Period													
	1	2	3	4	5	6	7	8	9	10	11	12	13	14
Coryn. Ear Staph.	50 3600	00 2020	00 80	00 10	0 00	10 140	0 20	0 10	30 120	0 70	0 110	10 1200	0 3000	0 610
Coryn. Nose Staph.	0 >5000	0 220	10 0	0 10	0 20	0 0	0 0	0 0	0 210	0 120	0 120	0 1020	0 0	270 0
Coryn. Groin Staph.	>5210 440	>3130 60	300 20	10 110	0 0	>3000 10	300 70		1500 3000	60 1250	220 40	40 100	90 760	10 10
Coryn. G.P. Staph.	>5000 250	0 30	0 10											
Coryn. Axilla Staph.	>250 500	830 30	0 100	0 0	0 1010	0 480	0 >3000		20 710	0 120	400 280	0 230	0 200	0 250
Coryn. Toes Staph.	>3000 >2500	0 0	0 10	0 20										

TABLE 18 ---- Continued

Subject 20

	Sampling Period													
	1	2	3	4	5	6	7	8	9	10	11	12	13	14
Coryn. Ear	400	>5000	>5000	110	700	50	0	0	0	0	0	0	0	0
Staph.	>5080	>5090	1500	70	210	90	0	350	870	1500	1260	700	1200	110
Coryn. Nose	>1000	0	0	0	0	0	NS	0	0	**	0	0	0	0
Staph.	>2500	0	0	0	0	0	NS	40	10	**	0	30	20	20
Coryn. Groin	1000	>5000	~300	0	0	>2000	10	2000	200	0	0	TNTC	20	300
Staph.	750	1000	0	10	0	>2800	10	200	250	140	400	50	30	40
Coryn. G.P.	>2500	0	NS	0										
Staph.	0	10	NS	60										
Coryn. Axilla	0	0	0	0	0	0	0	0	0	0	0	0	0	0
Staph.	0	0	0	480	950	>2000	>3000	510	0	1600	420	1200	290	1950
Coryn. Toes	0	>2000	NS	0										
Staph.	>3000	>2300	NS	240										

** No count given
NS = No Sample

TABLE 18 ---- Continued

Subject 21

	Sampling Period													
	1	2	3	4	5	6	7	8	9	10	11	12	13	14
Coryn.	0	0	0	0	>400*	1080	900	0	400	0	>3500*	>1500	0	140
Ear Staph.	>3090	>4010	260	290	>400	140	1860	1060	850	>6000	>3500	>2500	>4700	>230
Coryn.	>1000	0	0	>2000	**	970	2080	TNTC	1600	~3000	0	0	TNTC	360
Nose Staph.	20	10	0	1150		>3000	3120	TNTC	2480	>4000	1470	>4000	>4000	>6230
Coryn.	>3000	0	850	0	TNTC	0	TNTC	TNTC	TNTC	TNTC	TNTC	TNTC	TNTC	TNTC
Groin Staph.	550	250	>2000	0	>700*	230	>3000	TNTC	>2900	890	420	>4800	1590	>3760
Coryn.	60	0	0	0	>60*	0	300	>1000	~300	~300	480	~500	**	>3000
G. P. Staph.	180	0	0	0	>60	80	260	280	160	220	160	20	920	390
Coryn.	0	0	0	0	TNTC	0	TNTC	TNTC	>3000	TNTC	TNTC	TNTC	TNTC	TNTC
Axilla Staph.	0	0	>3000	630	TNTC	>3000	>3000	>2000	1540	>4000	840	790	1800	10
Coryn.	0	TNTC	TNTC											
Toes Staph.	0	TNTC	TNTC											

* Total Count - Not broken down

** No Count Given

TABLE 18 ---- Continued
Subject 22

	Sampling Period													
	1	2	3	4	5	6	7	8	9	10	11	12	13	14
Coryn. Ear Staph.	0	>3000	0	0	0	0	0	0	700	0	0	0	0	30
Coryn. Nose Staph.	>2000	190	0	0	900	0	0	<5000*	~250	0	820	~500	**	220
Coryn. Groin Staph.	>1510	560	>3000	0	2500	>5000	>5000	<5000	3780	>5000	610	1620	1960	TNTC
Coryn. G. P. Staph.	600	0	150	0	TNTC	0	TNTC	400	>3000	0	>2800	TNTC	TNTC	TNTC
Coryn. Axilla Staph.	530	860	140	0	90	810	3160	240	1290	TNTC	1510	>5000	>4000	TNTC
Coryn. Toes Staph.	1000	0	0	0	<2680*	>1580	~500	<>1250*	370	**	<>3000*	TNTC	**	>500
	150	20	550	0	<2680	300	20	<>1250	90	160	<>3000	210	1720	>640
	0	0	0	0	0	0	0	<1160*	0	0	0	>1000	TNTC	>1250
	910	110	370	0	0	>4000	720	<1160	190	300	40	470	>2500	>5380
	700	0	TNTC											
	1500	0	1200											

* Total Count - Not Broken Down

** No Count Given

TABLE 18 ---- Continued

Subject 23

	Sampling Period													
	1	2	3	4	5	6	7	8	9	10	11	12	13	14
Coryn. Ear	0	0	0	0	0	10	0	60	10	400	20	0	260	0
Staph.	0	0	0	0	0	50	320	390	200	20	130	>1650	0	180
Coryn. Nose	0	0	0	0	<320*	0	0	160	460	120	0	0	0	100
Staph.	10	100	0	60	<320	530	870	610	760	150	0	50	130	310
Coryn. Groin	>5000	2000	450	50	TNTC	450	>3000	TNTC	TNTC	>5000	TNTC	>5000	>4000	0
Staph.	350	20	150	0	<55	780	550	TNTC	TNTC	>2000	470	1500	120	1750
Coryn. G. P.	300	0	650	0	<560*	0	300	600	200	250	TNTC	750	2250	110
Staph.	40	40	300	0	<560	650	530	460	150	280	3600	1750	410	750
Coryn. Axilla	0	0	0	0	0	0	0	0	0	0	0	0	0	0
Staph.	30	50	0	0	2680	2500	>2000	7500	>2500	1400	>6000	3620	1020	71500
Coryn. Toes	750	<750*	NS											
Staph.	180	<750	NS											

* Total Count - Not Broken Down
 NS = No Sample Taken, Electrodes on Feet

TABLE 18 --- Continued

Subject 24

	Sampling Period													
	1	2	3	4	5	6	7	8	9	10	11	12	13	14
Ear Coryn.	0	0	0	0	0	0	0	50	0	0	10	0	0	230
Staph.	30	150	20	0	20	150	0	280	20	200	80	30	0	340
Nose Coryn.	60	60	0	0	<540*	0	100	100	>500	470	220	.500	300	200
Staph.	>1000	790	2430	110	<540	720	1390	390	930	1190	960	940	410	1820
Groin Coryn.	350	5000	>5000	0	<450*	0	>3000	TNTC	>1500	>3000	0	>2000	500	71,000
Staph.	360	400	>1500	20	<450	800	740	1140	210	750	790	310	350	8750
G. P. Coryn.	750	1000	5000	0	20	0	300	2500	100	200	>1250	>1250	400	>2800
Staph.	170	90	1750	0	0	350	170	>2500	260	200	840	410	300	1680
Axilla Coryn.	2500	1000	0	0	<160*	0	120	>5000*	>5000	>2000	>2000*	>5000	>5000	TNTC
Staph.	2500	1500	190	800	<160	4500	>3000	>5000	>5000	>3500	>2000	>1500	1250	>4000
Toes Coryn.	>2500	TNTC	NS											
Staph.	1000	TNTC	NS											

* Total Count - Not Broken Down
NS = No Sample Taken

TABLE 18 ---- Continued

Subject 25

		Sampling Period															
		1	2	3	4	5	6	7	8	9	10	11	12	13	14	15	16
Ear	Coryn.	-	-	-	-	-	tntc	-	>500	73	30	3600	980	1200	8000	1980	-
	Staph.	10	420	90	20	3500	240	5000	100	800	2170	110	40	3800	580	1000	4000
Nose	Coryn.	-	480	90	-	140	4000	2160	1200	1190	160	150	380	200	280	420	80
	Staph.	30	290	40	780	10	650	520	3800	310	40	100	110	100	70	360	30
Groin	Coryn.	0	280	0	300	5000	tntc	3440	-	70	3500	830	7700	22000	16400	19100	6000
	Staph.	0	50	0	70	510	6000	2040	6130	2580	7200	750	5400	7400	3300	1300	7500
G. P.	Coryn.	0	60	0	130	0	160	240	700	240	300	1600	1000	940	4000	90	110
	Staph.	0	0	0	10	0	50	40	970	100	420	340	800	1400	150	30	40
Coryn. Axilla Staph.	Coryn.	0	0	0	0	0	0	0	0	0	10	10	0	0	0	0	0
	Staph.	170	170	20	60	440	>500	20	640	2700	570	110	30	10	100	0	30
Coryn. Toes Staph.	Coryn.	>8000	tntc	tntc													
	Staph.	1430	2240	tntc													

TABLE 18 --- Continued

Subject 26

	Sampling Period															
	1	2	3	4	5	6	7	8	9	10	11	12	13	14	15	16
Coryn. Ear Staph.	tntc 1070	tntc 1640	tntc 1470	tntc 90	7500	tntc 1250	20000 > 4620	800 4900	180 500	1640 1520	0 4400	tntc 260	tntc 3000	1000 80	4800 610	0 >14400
Coryn. Nose Staph.	0 30	320 1230	0 20	50 890	0 60	120 2440	160 820	70 710	60 1170	10 10	300 570	0 630	20 0	320 910	0 170	0 10
Coryn. Groin Staph.	0 0	>2500 3000	4650 50	7600 400	5000 5000	tntc 2500	>10000 3540	tntc 4550	tntc 5000	860 810	1070 460	210 210	3680 3140	990 170	70 40	1600 2840
Coryn. G. P. Staph.	0 0	30 140	0 60	420 0	0 10	60 20	510 130	500 90	250 190	140 80	410 210	40 220	1400 500	690 130	220 120	60 20
Coryn. Axilla Staph.	0 10	0 >4000	0 50	0 20	0 4480	0 2140	30 >10000	30 1170	0 540	0 130	0 3100	0 180	2560 5360	1270 4200	0 7500	3600 3240
Coryn. Toes Staph.	0 >5000	>10000 >10000	600 tntc													

TABLE 18 --- Continued
Subject 27

		Sampling Period															
		1	2	3	4	5	6	7	8	9	10	11	12	13	14	15	16
Ear	Coryn.	0	2000	tntc	tntc	tntc	tntc	tntc	2000	9400	4000	2720	10000	390	1930	2300	0
	Staph.	460	840	1190	tntc	3600	2500	tntc	2800	3410	>10080	690	4800	3280	50	200	280
Nose	Coryn.	1200	3000	1000	>1500	1720	tntc	>8000	630	1360	810	9960	5600	1340	500	500	0
	Staph.	430	70	1170	>3180	460	5000	3000	280	360	180	70	470	360	80	240	0
Groin	Coryn.	0	800	0	150	tntc	tntc	4900	>3000	~2400	>5000	~20400	tntc	2760	5500	1240	2000
	Staph.	0	30	10	0	~4000	3000	1420	760	200	>6000	600	30	3160	230	150	1930
G. P.	Coryn.	0	0	200	40	0	510	260	340	2600	2800	4580	1120	200	4360	6470	60
	Staph.	0	0	20	460	0	0	2600	50	100	>10000	40	10	8560	210	0	1750
Axilla	Coryn.	0	0	0	70	120	330	>8000	1280	490	2640	280	30	>660	480	1850	330
	Staph.	50	1540	50	200	440	1160	530	160	260	30	60	40	70	10	230	10
Toes	Coryn.	5000	10000	>4500													
	Staph.	1890	10000	tntc													

TABLE 18 --- Continued

Subject 28

	Sampling Period															
	1	2	3	4	5	6	7	8	9	10	11	12	13	14	15	16
Coryn. Ear	0	0	0	0	0	0	310	0	0	0	0	0	10	10	0	20
Staph.	0	80	0	20	50	0	90	560	50	0	20	90	10	90	0	0
Coryn. Nose	0	0	0	30	0	0	80	0	0	0	20	0	0	70	0	150
Staph.	20	170	190	620	1040	3260	330	830	1470	700	130	90	20	390	3520	0
Coryn. Groin	0	0	0	380	tntc	0	2000	2500	> 3000	1980	1090	540	2100	350	210	4240
Staph.	0	20	0	10	2880	1100	310	1050	1510	190	140	170	170	60	40	550
Coryn. G. P.	0	0	0	50	0	30	160	90	2500	30	1160	20	50	930	180	40
Staph.	0	0	0	0	0	0	0	110	440	0	90	80	10	910	260	40
Coryn. Axilla	0	>2000	0	> 5000	tntc	tntc	>8000	0	> 6000	1780	620	1000	210	3240	~600	tntc
Staph.	0	290	20	40	320	200	160	70	480	30	50	220	10	440	120	260
Coryn. Toes	>13000	>8000	320													
Staph.	610	>8010	tntc													

TABLE 18 --- Continued

Subject 29

	Sampling Period															
	1	2	3	4	5	6	7	8	9	10	11	12	13	14	15	16
Coryn.	0	120	310	60	120	0	0	0	0	20	0	0	0	0	0	0
Ear Staph.	1500	200	70	70	110	780	70	440	830	440	79	660	6	77	180	360
Coryn.	0	27	360	450	120	95	90	0	70	124	60	40	410	400	40	130
Nose Staph.	560	12	88	70	380	57	130	37	77	58	340	190	530	780	91	30
Coryn.	95	820	100	5000	8000	700	2000	8000	4000	tntc	8000	7300	12500	80000	29000	10000
Groin Staph.	10	20	380	500	1100	100	1500	1800	1200	tntc	750	6000	52500	10100	6500	25000
Coryn.	0	0	0	800	90	35	120	1600	0	2300	120	0	1800	200	0	300
G. P. Staph.	2	0	4	110	20	1	7	1200	30	250	51	73	1500	41	7	300
Coryn.	250	5000	0	5000	5200	2000	900	5000	3500	5500	3000	150	5000	2000	4500	2000
Axilla Staph.	75	30	1	160	220	520	240	920	280	340	350	980	490	140	730	1500
Coryn.	3500															9000
Toes Staph.	1900								NS*							13100

NS = No sample
Data equivalent to 10^{-4} total bacteria per gram of sample

TABLE 18 --- Continued

Subject 30

	Sampling Period															
	1	2	3	4	5	6	7	8	9	10	11	12	13	14	15	16
Coryn. Ear	0	0	0	4	0	0	0	0	0	0	0	0	0	0	200	3
Staph.	0	1	0	0	0	0	0	2	1	0	1	50	3	7	30	7
Coryn. Nose	330	31	115	21	21	0	18	52	2	10	10	4	125	50	68	210
Staph.	90	58	56	260	11	10	25	170	20	42	24	29	203	70	134	108
Coryn. Groin	450	500	1500	1600	980	1800	1000	180	5000	2000	2000	350	3700	contam	4500	28900
Staph.	57	10	110	380	450	53	340	870	2000	1500	1350	800	1200	contam	400	17500
Coryn. G. P.	95	48	0	1800	2000	300	500	1690	1230	2000	700	100	850	2500	450	1900
Staph.	12	0	0	530	830	50	350	440	340	2400	120	360	2000	400	20	1900
Coryn. Axilla	2000	2000	0	770	1750	2300	65	130	6000	2750	2800	0	2800	3000	tntc	1000
Staph.	220	1620	5	1020	1250	1450	15	51	1060	130	1160	3500	5700	1400	180	700
Coryn. Toes	5250								26200							2000
Staph.	2000								4200							3900

Data equivalent to 10^{-4} total bacteria per gram of sample

TABLE 18 --- Continued

Subject 31

	Sampling Period															
	1	2	3	4	5	6	7	8	9	10	11	12	13	14	15	16
Ear Coryn. Staph.	5000 20	600 13	550 15	3000 200	5000 20	600 30	4500 20	5500 50	5500 90	800 2940	200 70	0 73	0 380	0 1500	30 20	0 1340
Nose Coryn. Staph.	0 10	0 140	16 4	26 32	0 20	0 5	0 73	0 23	12 63	11 43	0 56	0 350	20 350	0 210	0 220	20 450
Groin Coryn. Staph.	860 40	1980 30	1730 140	2250 260	1500 490	1750 200	4000 960	5000 3440	6000 2000	4000 4250	1300 2500	850 1050	3000 2850	2500 1000	13000 9000	32000 4800
G. P. Coryn. Staph.	320 19	270 38	0 0	650 80	150 110	420 10	400 480	140 250	1800 1950	2400 4000	1000 800	0 400	2250 3500	1400 300	1700 550	2000 3100
Axilla Coryn. Staph.	250 380	1020 2020	11 116	100 400	500 1320	40 800	5000 4800	2560 3000	1920 1150	2120 1410	1980 2400	0 2000	2410 2500	80 1700	0 4850	2200 550
Toes Coryn. Staph.	6000 2500								5500 3200						70000 70000	20000 40000

Data equivalent to 10^{-4} total estimated bacteria per gram of sample

TABLE 18 --- Continued

Subject 32

	Sampling Period															
	1	2	3	4	5	6	7	8	9	10	11	12	13	14	15	16
Ear																
Coryn.	170	0	400	214	120	1200	15	30	0	69	0	0	2	0	0	0
Staph.	36	610	73	200	150	40	7	110	3	65	15	53	110	670	110	2600
Nose																
Coryn.	7	7	160	256	45	49	40	10	5	50	0	19	60	0	110	38
Staph.	28	12	410	460	110	104	130	110	95	100	78	18	135	8	58	250
Groin																
Coryn.	700	1880	205	3000	1500	2000	1300	3000	2800	4200	5000	2300	19000	400	900	3000
Staph.	140	1200	9	420	190	1120	290	500	460	2000	580	1200	5000	800	430	900
G.P.																
Coryn.	205	900	0	300	174	1400	250	140	130	200	1150	600	250	500	190	310
Staph.	40	70	0	320	22	340	80	35	210	250	250	1600	350	520	380	50
Axilla																
Coryn.	0	0	0	40	900	800	1200	2000	1110	2750	3000	2000	3800	1900	tntc	4500
Staph.	48	1410	5	180	3620	5600	1600	860	550	2000	400	4800	2040	1400	4500	740
Toes																
Coryn.	165						12000									32500
Staph.	83						0									4300

Data equivalent to 10^{-4} total estimated bacteria per gram of sample

TABLE 18 --- Continued

Subject 33

	Sampling Period											
	1	2	3	4	5	6	7	8	9	10	11	12
Coryn. Nose	200	145	65	83	142	62	0	81	0	0	400	1100
Staph.	24	22	35	47	161	38	21	238	23	43	2400	2200
Coryn. Axilla	0	0	0	240	5500	3980	400	0	0	0	0	0
Staph.	21	8000	1320	1310	4180	570	900	> 5000	7920	870	4700	> 3000
Coryn. Groin	2000	3000	3000	24000	7000	3500	4000	> 6000	60000	11000	60000	1300
Staph.	300	3550	400	800	3300	1010	3200	4000	9300	3000	5900	250
Coryn. G.P.	0	117	1	30	12	32	0	200	1140	170	> 600	600
Staph.	1	27	0	6	0	2	28	180	670	148	150	250
Coryn. Anal	1150	4750	900	11700	1000	10500	100	1280	5150	1850	> 6000	> 2540
Staph.	50	880	0	16300	4000	1000	3600	500	900	500	500	200
Coryn. Toes	3500	> 6000	*	2800	*	2300	5700	21000	7000	25000	60000	30000
Staph.	2000	> 8000	*	2200	*	1100	2100	18600	15500	22400	> 50000	> 250000

Data equivalent to 10^{-4} total bacteria per gram of sample.
 * No sample taken, sweat test instead

TABLE 18 --- Continued

Subject 34

		Sampling Period											
		1	2	3	4	5	6	7	8	9	10	11	12
Nose	Coryn.	0	3	2	46	0	13	9	38	112	20	255	120
	Staph.	4	8	9	70	-4	50	35	77	64	320	285	180
Axilla	Coryn.	200	145	130	>8000	4000	161	580	1650	>6000	tnctc	650	2756
	Staph.	22	4	10	690	60	13	64	6680	180	490	130	1380
Groin	Coryn.	1000	2000	2010	4500	13200	1420	1250	3450	10	2900	12100	11300
	Staph.	110	1280	150	1820	10100	650	3500	3500	3000	3800	3400	4000
G. P.	Coryn.	>200	35	195	225	154	330	181	3820	0	405	2530	2180
	Staph.	1	17	70	38	36	190	234	5600	3600	600	2000	650
Anal	Coryn.	200	440	270	3300	830	530	80	1750	2850	>6150	2810	> 2000
	Staph.	0	140	200	500	100	70	340	3860	470	>6000	1130	> 2500
Toes	Coryn.	1800	2500	*	3500	*	0	2500	14200	500	0	0	4500
	Staph.	1000	1800	*	1560	*	100	900	7200	2300	5600	1700	8000

Data equivalent to 10^{-4} total bacteria per gram of sample
 * No sample taken, sweat test instead

TABLE 18 --- Continued

Subject 35

	Sampling Period											
	1	2	3	4	5	6	7	8	9	10	11	12
Coryn. Nose	0	0	22	16	16	0	0	19	0	0	0	0
Staph.	230	32	163	148	.67	1110	300	79	82	580	124	4200
Coryn. Axilla	850	2100	1050	2400	4800	2000	2850	> 6000	contam	870	> 6000	6000
Staph.	190	2010	230	90	340	140	110	400	contam	90	460	200
Coryn. Groin	110	1000	2100	8500	430	790	4400	> 6050	12000	10000	1300	7000
Staph.	20	1900	370	3100	110	140	2250	> 5000	10500	12000	3700	4800
Coryn. G. P.	20	700	360	200	1070	0	100	580	0	330	10	250
Staph.	24	550	55	96	210	140	390	690	1850	270	430	400
Coryn. Anal	350	tnrc	5400	18800	3300	400	13000	9600	0	500	4500	15000
Staph.	0	0	2300	9800	3000	800	5800	5900	> 5000	32000	2200	3100
Coryn. Toes	0	>8000	13000	28000	0	85000	0	51000	40000	95000	145000	>30000
Staph.	5700	>8000	25700	17500	55000	33000	40000	40000	30000	28000	30000	>25000

Data equivalent to 10^{-4} total bacteria per gram of sample

TABLE 18 --- Concluded
Subject 36

	Sampling Period											
	1	2	3	4	5	6	7	8	9	10	11	12
Coryn. Nose	210	343	550	560	8000	450	830	400	2000	2320	1330	960
Staph.	20	51	370	150	680	4	320	277	390	350	710	830
Coryn. Axilla	0	0	180	X	3450	0	0	0	0	0	150	> 2500
Staph.	0	670	1270	X	1030	58	130	3260	123	250	25	140
Coryn. Groin	700	750	1760	>4000	0	1160	0	2000	6000	3400	2500	8000
Staph.	1420	1300	4000	>4000	4100	780	2750	6800	11800	1400	1000	6000
Coryn. G. P.	X	X	X	40	3020	71	> 500	3000	> 800	165	> 600	tntc
Staph.	X	X	X	X 60 + spreaders	4400 + X preader	13	30	700	38	17	23	270
Coryn. Anal	1200	560	1600	6400	790	6030	970	tntc	0	980	11000	12500
Staph.	1250	430	1000	6500	260	600	1260	6000	1400	90	7500	6000
Coryn. Toes	X	X	X	X	X	2000	10000	X	10000	126000	9000	46000
Staph.	X	X	X	X	X	62000 + spreader	12000	X	61000	120000	39000	35000

Data equivalent to 10^{-4} total bacteria per gram of sample
X = plates covered with Proteus sp.

TABLE 19. OCCURRENCE OF OTHER AEROBES
Subject 17 - EXPERIMENT V

Body Area	Haemophilus			Neisseria				spp.*	Misc.
	Sarcina	Gaffneya	pharyngitis	catarrhalis	sicca	perflava	flava		
Scalp									
Ear									micro-cocci -6
Eye									
Nose			5						
Mouth	3								
Throat	9								
Axilla		12							
Forearm									
Umbilicus								7	
Groin								14	6
Glans penis								5	
Anal fold		6							
Feces									
Toes									

*Identification was not carried to species
Numbers represent culturing period

TABLE 19 --- Continued
 Subject 18 - EXPERIMENT V

Body Area	Haemophilus		Gaffkya			Neisseria				Misc.	
	multicapsulatus	parvulus	pharyngitis	catarrhalis	flava	perflava	flava	spp.*	Moraxella		
Scalp											
Ear										8	
Eye										5	
Nose			5, 6						8		
Mouth									2		
Throat			9						14		
Axilla										7	
Forearm											
Umbilicus											
Groin											
Glans penis											
Anal fold									4		
Feces											
Toes											

* Identification was not carried to species
 Numbers represent culturing period

TABLE 19 --- Continued
Subject 19 - EXPERIMENT V

Body Area	Haemophilus		Gaffney			Neisseria				Moraxella		Misc.
	phagocyti- vum	parvulus	pharyngitis	catarrhalis	siCCA	perflava	flava	spp. *	flava	Misc.		
Scalp												
Ear								7, 10				
Eye								4				
Nose								8				
Mouth		1, 2, 3, 4										
Throat		12						6				
Axilla								5				
Forearm												
Umbilicus								11				
Groin								10				
Glans penis								1				
Anal fold												
Feces												
Toes												

*Identification was not carried to species
Numbers represent culturing period

TABLE 19 ---- Continued
 Subject 20 - EXPERIMENT V

Body Area	Haemophilus		Gaffkya		Neisseria			spp. *	Nonferrous	
	parvulus	parvulus	parvulus	parvulus	pharyngitis	catarrhalis	flava		Misc.	Misc.
Scalp								3		
Ear		14								
Eye										
Nose			6					10		
Mouth										
Throat				9				10		
Axilla								12		
Forearm										
Umbilicus										
Groin										
Glans penis										
Anal fold										
Feces										
Toes										

* Identification was not carried to species
 Numbers represent culturing period

TABLE 19 --- Continued
 Subject 21 - EXPERIMENT VI

Body Area	Haemophilus		Neisseria				spp.*	Moraxella	Misc.
	parvulus	influenzae	pharyngitis	catarrhalis	slicca	perflava			
Scalp									
Ear								4	
Eye								1	
Nose		5, 7						11	
Mouth								4, 14	
Throat				4, 11				11	
Axilla			8						
Forearm									
Umbilicus									
Groin			8					9	
Glans penis			11	9					
Anal fold									
Feces								5	
Toes									

*Identification was not carried to species
 Numbers represent culturing period.

TABLE 19 --- Continued
 Subject 22 - EXPERIMENT VI

Body Area	Haemophilus		Gaffneya		Neisseria				Misc.
	Haemophilus	Sarcophaga	pharyngitis	catarrhalis	isicca	perflava	flava	spp.*	
Scalp									
Ear			13						
Eye									
Nose									
Mouth		11							4
Throat		12			13				
Axilla									
Forearm									
Umbilicus									
Groin									9
Glans penis		5							6, 12
Anal fold									
Feces					5				
Toes									

*Identification was not carried to species
 Numbers represent culturing period.

TABLE 19 --- Continued
 Subject 23 - EXPERIMENT VI

Body Area	Haemophilus		Neisseria			spp.*	Misc.
	Saerdingia	Geffkya	pharyngitis	catarrhalis	perflava flava		
Scalp							
Ear							
Eye							
Nose							
Mouth							
Throat	15					2, 14	
Axilla							
Forearm							
Umbilicus							
Groin	12						
Glans penis							
Anal fold							
Feces							
Toes							

*Identification was not carried to species
 Numbers represent culturing period.

TABLE 19 --- Continued
 Subject 24 - EXPERIMENT VI

Body Area	Haemophilus		Gaffkya			Neisseria				Moraxella		Misc.
	Saracina	parvulus	pharyngitis	catarrhalis	sicca	perflava	flava	spp.*	Moraxella	Moraxella		
Scalp												
Ear			13									
Eye										1		
Nose		7								5		
Mouth												
Throat		14										
Axilla		8										
Forearm												
Umbilicus												
Groin												
Glans penis												
Anal fold												
Feces		3, 5, 7, 13								6		
Toes												

*Identification was not carried to species
 Numbers represent culturing period.

TABLE 19 --- Continued
 Subject 25 - EXPERIMENT VII

Body Area	Haemophilus		Neisseria				Misc.		
	parvulus	glaucovirgatus	pharyngitis	catarrhalis	sicca	perflava		flava	spp.*
Scalp									
Ear									
Eye									
Nose	15								
Mouth	1, 4, 5, 6, 9				11, 13, 14			7, 8, 9, 10, 15	
Throat	1, 14, 15, 16				2, 3, 4, 5, 6			1, 3, 4, 5 6, 8, 9, 16 1, 7, 8, 9 10, 12, 15	13, 14
Axilla									
Forearm									
Umbilicus									
Groin									
Glans penis									
Anal fold									
Feces									
Toes									

*Identification was not carried to species.
 Numbers represent culturing period.

TABLE 19 ---- Continued
 Subject 26 - EXPERIMENT VII

Body Area	Haemophilus		Neisseria				Misc.	
	Sarccina	Gaffkya	pharyngitis	sicca	perflava	flava		spp.*
Scalp								
Ear								
Eye								
Nose				4, 8, 9		6, 8, 9		
Mouth	4, 14			6, 8, 13, 16		3, 4, 9, 12, 15	4, 10, 14	
Throat	1, 3, 4, 10 14, 15			2, 3, 5, 6, 8, 11		2, 4, 7, 9, 10, 12, 14	4, 15, 16	Gaffkya 4
Axilla								
Forearm								
Umbilicus								
Groin						14		
Glans penis								
Anal fold								
Feces								
Toes								

*Identification was not carried to species
 Numbers represent culturing period.

TABLE 19 ---- Continued
Subject 27 - EXPERIMENT VII

Body Area	Haemophilus		Gaffky		Neisseria			Misc.	
	influenzae	parvulus	pharyngitis	Catarrhalis	sicca	perflava	flava	spp.*	Misc.
Scalp									
Ear									
Eye									
Nose	8						8		
Mouth	1, 3				6, 9, 10, 11 13, 14, 15				
Throat	4, 5, 6, 14, 15	1, 3, 5, 7, 8, 9, 13, 16			4, 5, 6, 8		9, 10, 11, 12, 13, 15, 16	13, 14	
Axilla									
Forearm									
Umbilicus									
Groin									
Glans penis									
Anal fold								3	
Feces									
Toes									

*Identification was not carried to species.
Numbers represent culturing period.

TABLE 19 --- Continued
Subject 28 - EXPERIMENT VII

Body Area	Haemophilus		Gaffkya		Neisseria			app.*	Misc.
	parvulus	discrepans	pharyngitis	catarrhalis	flava	perflava	flava		
Scalp									
Ear									
Eye									
Nose									
Mouth	3, 4, 5, 9, 10, 12			10, 13, 14, 15			3, 4, 6, 8, 5, 9, 11, 12		
Throat	2, 12, 14, 15			5, 8, 10, 14			2, 3, 6, 9, 11, 15, 16		
Axilla									
Forearm									
Umbilicus									
Groin									
Glans penis									
Anal fold									
Feces									
Toes									

*Identification was not carried to species.
Numbers represent culturing period.

TABLE 19 ---- Continued
 Subject 29 - EXPERIMENT VIII

Body Area	Haemophilus		Gaffkya		Neisseria			Misc.**
	parvulus	parvus	pharyngitis	catarrhalis	flava	perflava	flava	
Scalp								
Ear								
Eye								
Nose								
Mouth			4		10			
Throat					7, 11, 14	10		15
Axilla								
Forearm								
Umbilicus								
Groin								
Glans penis						5, 9, 14		
Anal fold								
Feces							13	
Toes								

* Identification was not carried to species
 ** Glucose, Sucrose, Mannitol - ; Maltose +

TABLE 19 --- Continued
Subject 30 - EXPERIMENT VIII

Body Area	Hemophilus		Neisseria			Misc.**		
	Saradites	pharyngitis	catarrhalis	sicca	perflava		flava	spp.
Scalp								
Ear								
Eye								
Nose								
Mouth	7			5, 13, 14		12	10, 13, 16	*12 **9, 15
Throat				3, 7, 11, 13, 14	3, 4, 13	15	1	1-3, 8, 11, 14-16
Axilla								
Forearm								
Umbilicus								
Groin	7, 9, 12, 15							
Glans penis	7, 9, 11, 12			11				
Anal fold								
Feces								
Toes								

* Glucose, Sucrose, Mannitol - ; Maltose +

** Large gram positive coccus resembling Sarcina microscopically but with a very shiny gray stringy colonial morphology

TABLE 19 --- Continued
Subject 31 - EXPERIMENT VIII

Body Area	Haemophilus		Neisseria				Misc. **
	Saradovici	Gaffkyi	pharyngitis	catarrhalis	sicca	perflava flava	
Scalp							
Ear							
Eye							
Nose					11, 14		
Mouth	6		10		10	13	7** 1-3, 7-9* 11, 14-16*
Throat						15	14, 15**
Axilla			13				2, 6-8, 10, 13, 15, 16
Forearm							
Umbilicus							
Groin							
Glans penis							
Anal fold							1**
Feces							
Toes							

* Glucose, Sucrose, Mannitol - ; Maltose +

** Large gram positive coccus resembling Sarcina microscopically but with a very shiny gray stringy colonial morphology

TABLE 19 --- Continued
Subject 32 - EXPERIMENT VIII

Body Area	Haemophilus		Neisseria				Misc.	
	Sarcina	Gaffkya	pharyngitis	catarrhalis	sicca	perflava flava		spp.
Scalp								
Ear								
Eye								
Nose								
Mouth					10, 13			3, 6-9, 16
Throat					9, 13-15			7, 8, 11, 16
Axilla								14*
Forearm								
Umbilicus								
Groin								
Glans penis								
Anal fold								
Feces								
Toes								

* Glucose, Sucrose, Mannitol - ; Maltose +

TABLE 19 --- Continued
Subject 33 - EXPERIMENT IX

Body Area	Haemophilus		Neisseria				Misc.
	Sarcina	Gaffky's	pharyngitis	catarrhalis	perflava	flava	
Scalp							
Ear							
Eye							
Nose							*Bacillus 5
Gingival		12					Sarcina 9, 11
Throat		9, 11, 12		10, 11, 12	11		2
Axilla							
Forearm							
Umbilicus							
Groin							
Glans penis							
Anal fold							
Feces							
Toes							

* Bacillus pos. B. subtilis

TABLE 19 ---- Continued
 Subject 34 - EXPERIMENT IX

Body Area	Haemophilus		Neisseria			Moraxella		Misc.
	subtilis	parvulus	pharyngitis	catarrhalis	perflava	flava	spp.	
Scalp								
Ear								
Eye								
Nose								
Gingival							3, 9	Sarcina 5
Throat		9, 11		8			1	*Bacillus 8, 12 Sarcina 5
Axilla								
Forearm								
Umbilicus								
Groin								
Glans penis								
Anal fold								
Feces								
Toes								Sarcina 11

* Bacillus = pos. B. subtilis

TABLE 19 --- Continued
 Subject 35 - EXPERIMENT IX

Body Area	Haemophilus		Gaffkya		Neisseria				Moraxella		Misc.
	subdolus	parvulus	pharyngitis	catarrhalis	sicca	perflava	flava	spp.	Moraxella	Misc.	
Scalp											
Ear											
Eye											
Nose											
Gingival			7, 12					2			
Throat			8, 12		9, 10	12		6		Sarcina 4	
Axilla											
Forearm											
Umbilicus											
Groin											
Glans penis											
Anal fold											
Feces											
Toes											

TABLE 19 --- Concluded
 Subject 36 - EXPERIMENT IX

Body Area	Haemophilus		Neisseria				Misc.
	Sarcina	Gaffya	pharyngitis	catarrhalis	sicca	perflava flava	
Scalp							
Ear							
Eye							
Nose							
Gingival		12					1
Throat		4, 7, 12		7, 10, 12			1, 3, 4, 6
Axilla							
Forearm							
Umbilicus							
Groin							
Glans penis							
Anal fold							Sarcina 6
Feces							
Toes							

TABLE 20. CHROMOGENIC COLONY RECOVERY FROM ACTINO PLATES

Actinomycetales

EXPERIMENT VI

Subject Number	Sampling Period							
	1	2	3	4	5	6	7	8
21	Feces	Groin	Glans penis Throat	Nose Feces Throat	Nose Feces Ear	Mouth Glans penis	Feces	
22		Throat Groin Nose		Feces Ear	Mouth Axilla	Mouth Glans penis	Feces	
23		Throat		Mouth Axilla Groin Glans penis Feces Ear	Nose Glans penis	Axilla		Throat
24	Glans penis				Mouth Groin Glans penis Ear	Axilla	Feces	Throat Glans penis

Continued

TABLE 20 --- Continued
EXPERIMENT VI (cont'd)

Subject Number	Sampling Period							
	9	10	11	12	13	14	15	16
21		Groin Nose Throat Ear	Glans penis Throat	Nose	Axilla	Glans penis Ear	Mouth	Axilla Nose Ear
22	Ear	Groin	Throat Groin Nose Glans penis Ear		Axilla Groin Ear	Nose Glans penis Ear		Throat Mouth Groin Glans penis
23		Mouth	Groin	Axilla		Mouth Glans penis Ear	Axilla	Groin Nose Ear
24		Mouth			Mouth	Throat Mouth Axilla Feces	Mouth	Throat Mouth Axilla Groin Nose Glans penis

TABLE 20 --- Continued

EXPERIMENT VII

Subject Number	Sampling Period															
	1	2	3	4	5	6	7	8	9	10	11	12	13	14	15	16
25														Throat		
26														Groin*		
27											Throat **			Ear Throat*		
28						Throat* Mouth**			Axilla*	Throat*		Ear		Axilla		
Room Area											Floor Psnl. Hyg. Area*					

* = *Proactinomyces*. Species unidentified

** = *Mycococcus luteus*

TABLE 20 --- Continued

EXPERIMENT VIII

Subject Number	Sampling Period															
	1	2	3	4	5	6	7	8	9	10	11	12	13	14	15	16
29										Groin*						
30									Mouth		Ear*	Groin				
31						Glans penis						Groin	Glans penis			
32			Throat		Throat											
Room Area											Aft Table					

* Actinomyces flavus also found

TABLE 20 --- Concluded
EXPERIMENT IX

Subject Number	Sampling Period												
	1	2	3	4	5	6	7	8	9	10	11	12	
33	Eye							Glans penis					
34		Groin											
35	Ear									Gingival			
36	Toe												
Room Area	Floor Psnl. Hyg.*				Fore Table	Fore Table*							

* Actinomyces flavus also found

TABLE 21. OCCURRENCE OF FUNGI

Subject Number	albicans	Candida parapsilosis	species	Rhodotorula	Trichosporon	Penicillium	Aspergillus sp.	Trichophyton rubrum	Aspergillus sp.	Yeast	Miscellaneous
17	Feces: 1			Feces: 5 Feces: 5, 9				Grain: 2, 3		Feces: 0	
18		Glass penis & Grain: 3 Grain: 4, 5-8		Throat: 5							
19	Feces: 4										
20	Mouth: 2, 5 Anal fold: 2, 3										
21	Mouth: 5, 9-12, 13, 16 Throat: 2, 3, 5, 6, 9										
22	Mouth: 8, 12, 13, 16 Throat: 1, 5, 16 Feces: 8, 11, 15										
23	Mouth: 4, 12 Throat: 4, 13										
24											
25											
26											
27	Nose: 6, 7, 9, 10, 12, 14 Mouth: 1-4, 5-11, 15 Throat: 1-6, 8-10, 12-18 Feces: 2, 3, 5										
28											
29											
30	Mouth: 3, 4, 9, 12 Throat: 4, 5, 6, 9 Feces: 9										
31											
32											
33											
34											
35											
36											

* Non-pathogenic
Numbers refer to sampling period.

Controls

TABLE 22. RECOVERY OF PPLO
EXPERIMENT V

Subject Number	Body Area	Sampling Period													
		1	2	3	4	5	6	7	8	9	10	11	12	13	14
17	Nose						+		+						
	Mouth		+		+		+								
	Throat	+	+												
	Groin		+												
	Anal fold		+												+
18	Nose														
	Mouth		+												
	Throat			+					+						
	Groin								+						
	Anal fold														
19	Mouth														
	Throat														
	Groin														
	Anal fold														
20	Mouth														
	Throat														
	Groin														
	Glans penis														
	Anal fold														

Controls

TABLE 22 --- Continued
EXPERIMENT VI

Subject Number	Body Area	Sampling Period																	
		1	2	3	4	5	6	7	8	9	10	11	12	13	14				
21	Mouth	+		+			+				+								
	Throat			+															
	Feces	+	+																
22	Nose																		
	Mouth			+			+												
	Throat			+															
	Groin																		
	Glans penis			+															
	Feces																		
23	Mouth																		
	Throat			+															
	Feces	+																	
24	Mouth			+															
	Throat	+																	
	Glans penis	+																	

NOTE: Samples, other than feces, were taken only on sampling periods 1, 3, 6, 9 and 12.

TABLE 22 --- Concluded

EXPERIMENT VI

Subject Number	Sampling Period													
	1	2	3	4	5	6	7	8	9	10	11	12	13	14
25	Body Area	+												
	Anal fold			+										
26	Feces						+			+				
	Anal fold	+												
27														
28														

Run VIII

29	Throat	+						+									
	Axilla					+					+						+
	Glans penis																+
	Anal fold	+						+									+
30	Mouth																
	Throat	+															
	Anal fold	+						+									
	Feces																+
31																	
32	Feces	+									+						

Run IX

33	Anal fold																
			+														
34																	
35																	
36	Gingival																
	Anal fold	+														+	
	Feces																

TABLE 23. DILUTIONS FROM WHICH ANAEROBIC BLOOD PLATES WERE MADE
EXPERIMENT IX

Subject 33

Body Area	Sampling Period											
	1	2	3	4	5	6	7	8	9	10	11	12
Nose	L	L	L	L	L	L	L	1	L	L	L	L
Gingival	1	1	1	1	1	1	1	1	1	1	1	1
Throat	2	2	2	2	2	2	1	2	1	1	1	1
Axilla	L	L	1	2	1	1	1	1	1	1	1	1
Groin	1	1	1	2	2	2	1	1	2	2	2	2
Glans penis	L	L	L	L	L	L	L	L	L	L	L	L
Anal fold	1	1	2	2	2	2	2	2	1	1	1	1
Toes	1	1	2	2	3	3	3	2	2	2	2	2
Scalp	L								L			L
Ear	L								1			1
Eye	L								L			L
Forearm	L								L			L
Umbilicus	L								L			L
Electrode									L			L

L = 10^{-3} , 1 = 10^{-4} , 2 = 10^{-5} , 3 = 10^{-6}

TABLE 23 ---- Continued

Subject 34

Body Area	Sampling Period											
	1	2	3	4	5	6	7	8	9	10	11	12
Nose	L	L	L	L	L	L	L	1	L	L	L	L
Gingival	1	1	1	1	1	1	1	1	1	1	1	1
Throat	2	2	2	2	2	2	1	1	2	2	2	2
Axilla	L	L	L	L	1	1	1	L	1	1	1	1
Groin	1	1	1	1	1	1	1	1	2	2	2	2
Glans penis	L	L	L	L	L	L	L	L	L	L	L	L
Anal fold	1	1	2	2	2	1	1	1	1	1	2	2
Toes	1	1	2	2	2	3	3	2	2	2	2	2
Scalp	L								L			L
Ear	L								1			1
Eye	L					.			L			L
Forearm	L								L			L
Umbilicus	L								L			L
Electrode									L			L

TABLE 23 --- Continued

Subject 35

Body Area	Sampling Period											
	1	2	3	4	5	6	7	8	9	10	11	12
Nose	L	L	L	L	L	L	L	L	L	L	L	L
Gingival	1	1	1	1	1	1	1	1	1	1	1	1
Throat	2	2	2	2	2	1	2	1	1	1	1	1
Axilla	L	L	1	1	1	1	1	1	1	1	1	1
Groin	1	1	2	2	2	1	1	1	2	2	2	2
Glans penis	L	L	2	1	1	1	1	1	1	1	1	1
Anal fold	1	1	2	2	2	2	2	2	2	2	2	2
Toes	1	1	2	2	2	3	3	3	3	3	3	3
Scalp	L								L			L
Ear	L								1			1
Eye	L								L			L
Forearm	L								L			L
Umbilicus	L								L			L
Electrode									L			L

TABLE 23 ---- Concluded

Subject 36

Body Area	Sampling Period											
	1	2	3	4	5	6	7	8	9	10	11	12
Nose	L	L	L	L	L	1	1	1	1	1	1	1
Gingival	1	1	1	1	1	1	1	1	1	1	1	1
Throat	2	2	2	1	1	2	2	2	2	2	2	2
Axilla	L	L	L	L	L	1	1	L	1	1	1	1
Groin	1	1	1	1	1	1	1	1	2	2	2	2
Glans penis	L	L	L	L	L	L	L	L	L	L	L	L
Anal fold	1	1	2	2	2	1	1	1	2	2	2	2
Toes	1	1	2	2	2	3	3	3	3	3	3	3
Scalp	L								L			L
Ear	L								1			1
Eye	L								L			L
Forearm	L								L			L
Umbilicus	L								L			L
Electrode									L			L

TABLE 24. OCCURRENCE OF MICROCOCCACEAE*
EXPERIMENT V

Body Area	Subject Number 17			Subject Number 18				
	Flavus	Candidus	Varians	Unidentified	Flavus	Candidus	Varians	Unidentified
Eye								3
Ear		6						
Nose	5, 7, 10					3, 5, 9		
Throat								
Axilla			6, 11					
Umbilicus		7					3, 14	
Groin			8, 10, 11 12					
Anal Area		6						
Feces								
Scalp				4				
Mouth								
Forearm								
Glans Penis					1			
Toes								

*Staphylococci not included

TABLE 24 --- Concluded

Body Area	Subject Number 19				Subject Number 20			
	Flavus	Candidus	Varians	Unidentified	Flavus	Candidus	Varians	Unidentified
Eye								14
Ear						12		
Nose	9, 10, 13							
Throat	13							
Axilla			3, 6				6, 7, 13	
Umbilicus		5, 13						
Groin						8		
Anal Area		3						
Feces								
Scalp								
Mouth								
Forearm								
Glans Penis								
Toes						2		

TABLE 25. MICROSCOPIC IDENTIFICATION OF AEROBIC DILUTION SERIES

Subject	Body Area	Micrococci	Streptococci	Gram Positive Rod	Gram Negative Rod	Gram Negative Rod
33	Scalp	9				
	Nose	1, 7, 8, 9, 10, 12	10	7	9	
	Ear	3, 9				
	Eye	9	3			
	Throat	1, 7, 8, 12	7, 8	7, 12	7, 10	6, 10
	Gingival	7, 12	1, 8, 12	1, 7		10
	Axilla	1, 7, 9	9		9	8, 9
	Umbilicus	1, 3	3	1, 3	1	
	Groin	1, 7, 8, 9	1, 9	7, 8		
	Glans penis	1, 6, 7, 8, 12		7, 12	7	
	Anal fold	1, 7, 8	8, 12	7		
	Forearm	1, 3				
	Toe	1, 7, 8, 9	12	7		
	Electrode	9				
34	Nose	7, 8, 9	9, 12			
	Ear	3				
	Eye	3				
	Throat	7	8			
	Gingival	7, 8, 9	9, 12	7, 8, 9	7	8
	Axilla	7, 8, 9, 11, 12	12	8		9
	Umbilicus		3	3		
	Groin	7, 8, 9	9	9	9	
	Glans penis	1, 7, 8	12	8		
	Anal fold	7, 8	12	12	7, 8	
	Forearm		3			
	Toe	7, 8				

Numbers refer to sampling period.

TABLE 25 --- Concluded

Subject	Body Area	Micrococci	Streptococci	Gram Positive Rod	Gram Negative Rod	Gram Negative Rod
35	Nose	6, 7, 8, 12	12			
	Ear	11				
	Eye	3				
	Throat	6, 7, 8, 12	12	6, 7, 8, 12	7	8
	Gingival	6, 7, 8, 12	12			
	Axilla	6, 7, 8, 11, 12	11, 12	6, 7, 8, 11, 12		
	Umbilicus	3				
	Groin	6, 7, 8, 11, 12		8	12	
	Glans penis	6, 7, 8, 12	12	6, 8, 12	12	
	Anal fold	6, 7, 8, 9, 11, 12	11, 12	6, 7, 8, 9	8, 9	
	Forearm	3			8	
	Toe	6, 7, 8, 9, 11, 12		9	9	9
36	Scalp	9				
	Nose	6, 7, 8, 9, 12		7	6, 7, 8	9
	Ear	9		9, 12		
	Eye	3	3			
	Throat	6, 9, 12		6, 8, 9, 12	8, 9	6
	Gingival	6, 7, 8, 8, 12	9, 12	6, 7, 8, 9	6, 9	6, 9
	Axilla	6, 7, 8, 9, 12	12	6	6	9
	Umbilicus	3				
	Groin	6, 7, 8, 9, 12		8, 9	6, 12	6, 9
	Glans penis	6, 8, 9, 12		8, 9, 12	8, 9, 12	
	Anal fold	6, 9, 12		6, 7, 8, 9, 12	6, 9	6
	Forearm	3		3		
	Toe	6, 7, 8		7, 8	6, 7	

Numbers refer to sampling period.

TABLE 26. RECOVERY OF MICROCOCCACEAE FROM ROOM AREAS*

EXPERIMENT V

Area	Sampling Period																		
	1	2	3	4	5	6	7	8	9	10	11	12	13	14	15	16	17	18	19
Bed	+	+	+	-(2)	-			-	+	+	+(2)	-(2)	+(2)		+	-(2)	-(2)	+	+(2)
Table	+(2)	-(2)	+	-	-													+(2) -(2)	+(2)
Window			+																
Psnl. Hyg.			-	+(2)	+		-	+	+	+	+	+	-		+	+	-	+	+(2)
Fore Table						-	+	+	+	+	-(2)	+(2)	-(2)	+	+	+(3)	+(2)		
Aft Table							-(2)	-	+	+	+	+	+	-	+	+	+	+	+(2)
Filter													-(4)						

+ = positive coagulase test

- = negative coagulase test

* = Work performed by Mr. J. Rack and Mrs. B. Horstman, Miami Valley Hospital, Research Group, under contract AF33(657)-11716.

() = Number of differing strains

TABLE 26 --- Continued

EXPERIMENT VI

Area	Sampling Period									
	1	2	3	4	5	6	7	8	9	10
Bed	-	+ -(2)	+ -		+(2) -	-(2)	-	-(2)	-(2)	+ -(2)
Eating Table	+ -(2)								-(3)	-(3)
Fore Table		+ -	+ -(2)	+ -(4)	+ -(2)	-	-(2)	+ -(2)		
Aft Table	+(2) -(2)	-(3)	-(2)	+(2) -	+ -(2)	+ -	-	-(2)	+ -	
Personal Hygiene	-(3)	-	-		+ -(2)	+ -(2)	-(2)	+	+ -(2)	-(3)

+ = positive coagulase test
 - = negative coagulase test
 () = Number of differing strains

TABLE 26 --- Continued

EXPERIMENT VII

Area	Sampling Period												
	1	2	3	4	5	6	7	8	9	10	11	12	13
Bed	+ -	+ -(2)	+(2)		+(2) -	+(2)	+(3) -(2)	+(3) -(2)	+(2) -	+(2)	+(4)	+ -(2)	+(3) -(2)
Eating Table	+ -	+(2) -	+ -(2)									+ -(2)	+(3) -(3)
Fore Table				+(2) -	+	+(4)	+(2) -	+(3) -	+(2) -(2)	+	+(2) -(2)		
Aft Table				+(2) -	+(2) -(2)		+(2) -	+(2) -(2)	+(2) -(3)	+(2)	+(2) -		
Working Table	+ -	-(2)	+ -(3)									+ -(3)	+(2) -
Floor	+ -(2)	-(3)	+ -(3)		+(2) -(2)	+(3) -(2)	+(2) -	+(2) -	+(2) -(3)	+(2) -	+(2) -	+ -	+(3) -(3)

+ = positive coagulase test
 - = negative coagulase test
 () = Number of differing strains

TABLE 26 --- Continued

EXPERIMENT VIII

Area	Sampling Period										
	1	2	3	4	5	6	7	8	9	10	11
Bed	+(2) -	-(2)	-	+(2) -	+ -(2)	+(2) -	+(2) -	+(2)	+(2) -		+(2) -
Eating Table	+(3) -	+(2) -								-	+ -(2)
Fore Table			+ -	+(4) -	+(3)	-		+ -	+ -(2)		
Aft Table	+(2) -	+ -	-	+ -(2)	+(3)	+(2) -	+(2) -	+(2) -	+ -		
Working Table										+	+(2) -(2)
Floor	+ -	+	-(2)	+(2) -(2)	+(4)	+(2) -(3)	+(2)	+ -	+(3) -(2)	+	+(2) -(2)

+ = positive coagulase test
 - = negative coagulase test
 () = Number of differing strains

TABLE 26 --- Concluded
EXPERIMENT IX

Area	Sampling Period											
	1	2	3	4	5	6	7	8	9	10	11	12
Bed	+ -	+ -(2)	+(2) -	+(2) -	+(2) -	+ -(2)	+(2) -(2)	+ -	+(2) -	+(3) -	+(2) -	+(2) -
Eating Table	+ -(3)											+ -(3)
Fore Table		+(2) -	+ -	+ -(3)	+ -(2)	+(2) -	+(2) -	+(2) -(2)	+(2) -	+(2) -	+(3)	
Aft Table		+(2) -	+(2) -(2)	+(2) -	- (3)	+(2) -	+ -	+ -	+(2) -	+(2) -	+(2) -	
Working Table	+ -											+ -(2)
Floor	-(3)	+ -	-(3)	+(2) -	+ -(2)	+(2) -	+(3)	+(2) -	+(2)	+(2)	+(2)	+(2) -(2)

+ = positive coagulase test
 - = negative coagulase test
 () = Number of differing strains

TABLE 27. BACTERIOLOGICAL RESULTS OF ENVIRONMENTAL MONITORING
EXPERIMENT V

Area	Sampling Period																				
	1	2	3	4	5	6	7	8	9	10	11	12	13	14	15	16	17	18	19	20	21
Bed	staph	staph	staph	staph	staph	staph		staph	staph	staph	staph	staph	staph	staph	staph	staph	staph	staph	staph	staph	staph
Pore Table						staph	staph	staph	staph	staph	staph	staph	staph	staph	staph	staph	staph	staph	staph	staph	staph
AIR Table							staph	staph	staph	staph	staph	staph	staph	staph	staph	staph	staph	staph	staph	staph	staph
Penl. Bgt.			staph	staph	staph	staph	staph	staph	staph	staph	staph	staph	staph	staph	staph	staph	staph	staph	staph	staph	staph
Hand Set																					
Chair Arm																					
Window			staph																		
Filter																					

Gram negative rod positive:

	Biol	Methyl Red	Voges-Proskauer	Citrate	Urease	Indolify	Oxidase	Cytochrome oxidase	TR
a	-	+	-	-	-	-	-	-	alk/alk
b	-	-	-	+	-	-	-	-	alk/alk
c	-	-	-	+	-	-	-	-	alk/alk
d	-	-	-	+	-	+	+	+	alk/alk

TABLE 27 --- Continued
EXPERIMENT VI

Area	Sampling Period															
	1	2	3	4	5	6	7	8	9	10	11	12	13	14	15	16
Bed	staph	staph	staph	staph	staph	staph	staph	staph	staph gm pos rod	staph klebsiella			bacillus	corynebacter		
Eating Table	staph		coryn gm neg res- ing form actino	bacillus					staph	staph						
Fore Table		staph	staph	staph	staph	staph klebsiella	staph	staph								
All Table	staph	staph	staph	staph	staph	staph gm pos rods	staph	staph klebsiella klebsiella	staph klebsiella	klebsiella	leptobacillus			klebsiella		
Pen. Hyg.	staph	staph	staph	staph	staph	staph gm pos rod	staph	staph klebsiella	staph	staph			bacillus			

Run VII																
Bed	staph	staph	staph		staph	staph	staph	staph	staph	staph	staph	staph	staph	staph		
Eating Table	staph	staph	staph										staph	staph		
Fore Table				staph	staph	staph	staph	staph	staph	staph	staph					
All Table				staph	staph	staph	staph	staph	staph	staph	staph actino albus					
Working Table	staph	staph	staph													
Floor	staph	staph	staph		staph	staph	staph	staph	staph	staph	staph mycoccocus lutera prometuo, actino albus	staph staph serobact.	staph	staph		gm neg rod

TABLE 27 --- Concluded
EXPERIMENT VIII

Area	Sampling Period															
	1	2	3	4	5	6	7	8	9	10	11	12	13	14	15	16
Bed	staph	staph	staph	coryn (B+) staph	staph coryn (B+)	staph	staph coryn (B-)	staph	staph	gm pos cocci	staph		gm pos rod	gm pos cocci		coryn (B+)
Aft Table	staph	bacillus staph yeast	staph	coryn (untidus) staph	staph	staph coryn (B)	staph coryn (B+) yeast	staph	micrococci		actino albus		gm pos cocci	gm pos cocci		yeast
Fore Table		bacillus	staph	coryn (untidus) staph	staph	staph	staph	staph	staph	gm pos rod		gm pos cocci	gm pos cocci (untidus) gm neg rod			coryn yeast
Evaluater																
Penl. Evg.	staph	staph	staph	staph gm neg rod	staph	staph coryn (B+)	staph	staph	staph	staph yeast	staph coryn (A)					
Eating Table	staph	staph			staph					staph	staph					

Run IX

Bed	staph	staph	staph coryn (A)	staph	staph	staph	staph	staph	staph	staph	staph coryn (B)	staph C. parvus, C. xerosis coryn (B)				
Eating Table	staph	staph	staph	staph	staph actino albus actino flavus	staph actino albus actino flavus	staph	staph	staph	staph	staph	staph				
Aft Table		staph	staph coryn (A)	staph	staph C. stritium	staph	staph	staph	staph	staph C. xerosis	staph	coryn (B)				
Work Table												staph				
Floor	staph actino albus actino flavus	staph	staph coryn (A)	staph	staph C. stritium	staph	staph	staph	staph C. stritium	staph	staph coryn (B)	staph C. xerosis				
Fore Table			coryn (A)		C. stritium					C. eaz	coryn (A)	coryn (B)				

TABLE 28. OCCURRENCE OF VARIOUS MICROORGANISMS ON AXILLA

	Subject Number																				
	17	18	19	20	21	22	23	24	25	26	27	28	29	30	31	32	33	34	35	36	
Microflora																					
Aerobacter		x	x	x																	
PPLO													x								
Streptococcus	x																				
Corynebacteria	x	x	x	x		x				x	x	x	x	x	x	x	x	x	x	x	x
Micrococcus	x		x	x																	
Bacillaceae	x			x		x	x		x												
Proactinomyces	x		x	x	x	x	x	x				x									
Neisseria		x	x	x	x										x						
Staphylococcus	x	x	x	x	x	x	x	x	x	x	x	x	x	x	x	x	x	x	x	x	x
Sarcina	x	x																			
Obligate anaerobes	x																				
Facultative anaerobes		x	x																		
Mimae		x																			
Yeast																					
Gaffkya													x								
<u>Helminthosporium</u> sp.																					
Mycelia sterila																					
Nitrate negative rod																					
Haemophilus																					

TABLE 29. OCCURRENCE OF VARIOUS MICROORGANISMS ON ANAL AREA

Microflora	Subject Number																				
	17	18	19	20	21	22	23	24	25	26	27	28	29	30	31	32	33	34	35	36	
<u>E. coli</u>		x	x	x		x	x		x						x						
Aerobacter				x		x															
Alcalescens dispar						x									x						
PPLO	x	x	x	x					x	x			x	x							
Streptococci			x	x	x	x	x	x	x	x	x	x									
Corynebacteria	x	x	x	x		x	x	x	x	x	x	x	x	x	x	x	x	x	x	x	x
Micrococci	x		x																		
Clostridium					x																
Alcaligenes				x																	
Lactobacillus										x											
Bacillaceae		x				x	x	x													
Proactinomyces				x	x		x														
Neisseria																x					
Anaerobes	x	x	x	x																	
Staphylococcus	x	x	x	x	x	x	x	x	x	x	x	x	x	x	x	x	x	x	x	x	x
Obligate anaerobes	x	x	x	x																	
Facultative anaerobes	x	x	x	x																	
Candida					x																
Trichosporium																					
Sarcina	x	x																			
<u>Scopulariopsis sp.</u>																					

TABLE 30. OCCURRENCE OF VARIOUS MICROORGANISMS IN UMBILICUS

	Subject Number																				
	17	18	19	20	21	22	23	24	25	26	27	28	29	30	31	32	33	34	35	36	
Microflora																					
Streptococci			x	x																	
Corynebacteria			x				x						x								
Micrococci	x	x	x																		
Bacillaceae							x	x													
Proactinomyces							x	x													
Neisseria	x		x																		
Staphylococcus	x	x	x	x	x	x	x	x	x	x	x	x	x	x	x	x	x	x	x	x	x
Facultative anaerobes			x																		
<u>Pencilium sp.</u>																					
Scopulariopsis																					

TABLE 31. OCCURRENCE OF VARIOUS MICROORGANISMS IN EYE

Microflora	Subject Number																				
	17	18	19	20	21	22	23	24	25	26	27	28	29	30	31	32	33	34	35	36	
<u>E. coli</u>		x													x						
Aerobacter		x																			
Streptococci				x																	
Corynebacteria	x	x		x													x				x
Micrococci		x		x																	
Proactinomyces						x															
Neisseria			x																		
Staphylococcus	x	x	x	x	x	x	x	x	x	x	x	x	x	x	x	x	x	x	x	x	x
Moraxella		x			x			x													
Facultative anaerobes				x																	
Obligate anaerobes	x																				

TABLE 32. OCCURRENCE OF VARIOUS MICROORGANISMS ON SCALP

	Subject Number																				
	17	18	19	20	21	22	23	24	25	26	27	28	29	30	31	32	33	34	35	36	
Microflora																					
Corynebacteria		x							x	x	x		x	x		x	x	x			x
Micrococci	x																				
Bacillaceae		x																			
Proactinomyces							x	x													
Neisseria				x																	
Staphylococcus	x	x	x	x	x	x	x	x	x	x	x	x	x	x	x	x	x	x	x	x	x
Trichosporum											x										
Facultative anaerobes				x																	

TABLE 33. OCCURRENCE OF VARIOUS MICROORGANISMS IN EAR

	Subject Number																				
	17	18	19	20	21	22	23	24	25	26	27	28	29	30	31	32	33	34	35	36	
Microflora																					
Corynebacteria	x	x	x	x					x	x	x	x	x		x	x	x	x			x
Micrococci	x			x																	
Lactobacillus					x																
<u>Bacillaceae</u>		x		x	x	x	x		x		x										
Proactinomyces		x	x	x	x	x	x	x			x	x									
Neisseria			x			x		x													
<u>Penicillium sp.</u>												x									
Staphylococcus	x	x	x	x	x	x	x	x	x	x	x	x	x	x	x	x	x				x
Mimae	x	x																			
Sarcina			x	x																	
Candida sp.					x																x
Moraxella					x																

TABLE 34. OCCURRENCE OF VARIOUS MICROORGANISMS ON TOES

	Subject Number																				
	17	18	19	20	21	22	23	24	25	26	27	28	29	30	31	32	33	34	35	36	
Microflora																					
<u>E. coli</u>																x					
Corynebacteria	x			x					x												
Micrococci				x																	
Bacillaceae					x																
Proactinomyces	x		x		x	x	x														
Staphylococcus	x	x	x	x	x	x	x	x	x	x	x	x	x	x	x	x	x	x	x	x	x
Yeasts			x																		
<u>T. rubrum</u>					x																
<u>Penicillium sp.</u>													x								
Pseudomonas																				x	
<u>T. mentagrophytes</u>																					x

TABLE 35. NUTRIENT COMPOSITION OF THE DIET

Experiment	Calories Kcal	Protein (gm)	Fat (gm)	Carbo- hydrate (gm)	Fiber (gm)
V Fresh	2620	110	80	315	6-9
VI Dehydrated and Bite-sized Foods	2660	116	90	280	5-7
VII Fresh (21 days)*	2720	72	174	216	3-6
Liquid (21 days)*	2700	72	173	213	0
VIII Fresh (21 days)*	2760	72	176	220	2-5
Liquid (21 days)*	2750	72	176	222	0
IX Fresh*	2780	90	100	379	3

* Calculated

TABLE 36. AEROBIC MICROBIAL PROFILE OF SUBJECTS

Subject 17

Body Area	Sampling Period													
	1	2	3	4	5	6	7	8	9	10	11	12	13	14
Scalp	ns	staph	staph	mic.	ns	ns	ns	ns	staph	ns	ns	ns	ns	staph
Ear	nr	nr	nr	nr	staph	mic.	nr	nr	G + R	nr	nr	nr	nr	nr
Eye	nr	nr	G + R Coryn. X	nr	mic.	nr	mic.	nr	nr	mic.	nr	nr	nr	nr
Nose	staph	staph	nr	nr	Sarcina	PPLO staph	G + R lacto. staph	PPLO staph	staph	lacto. staph	staph	G + R lacto. staph	PPLO staph	G + R lacto. staph
Mouth	ns	saliv Haemo- philus staph	saliv staph actino G + R	ns	ns	ns	ns	ns	saliv, staph mitis, PPLO actino, G+R Haemophilus Coryn. P	ns	ns	ns	ns	mitis saliv staph G + R
Throat	saliv PPLO	PPLO	saliv lacto	nr	nr	saliv	mitis G + R lacto	PPLO	PPLO mitis Haemophilus staph	mitis PPLO staph	mitis PPLO	saliv mitis staph	mitis	PPLO staph
Axilla	staph	staph	nr	nr	staph	mic. entero staph	staph	staph	staph	staph	mic. G + R staph	G + R Sarcina staph	G + R staph	staph
Umbilicus	nr	nr	staph	nr	nr	nr	mic. entero Neisseria	staph	nr	nr	nr	staph	nr	nr
Groin	nr	PPLO, staph T. rubrum Coryn. S	G + R Coryn. S staph	staph	staph	PPLO Moraxella staph	G+R, staph T. rubrum Coryn. S	mic. staph	Coryn. S staph	mic. staph	mic. staph	mic. staph	Coryn. S staph	G+R, staph Neisseria Coryn. S
Clauis penis	ns	staph	Neisseria staph	ns	ns	ns	ns	ns	staph	ns	ns	ns	ns	staph
Anal fold	E. coli staph	PPLO staph	nr	nr	nr	mic. Sarcina staph	nr	staph	E. coli PPLO staph	nr	nr	proact. staph	Eac. proact.	proact. staph
Feces	E. coli E. coli Sal+ entero staph	ns	Lacto	Aerobacter E. coli E. coli Sal+	E. coli	Aerobacter	E. coli E. coli Sal+	ns	Aerobacter E. coli E. coli Sal+ Yeast	Aerobacter Lacto	E. coli Sal+ Lacto	staph	ns	ns
Toes	ns	staph	G + R	ns	ns	ns	ns	ns	nr	ns	ns	ns	ns	staph

TABLE 36 --- Continued

Subject 19

Body Area	Sampling Period													
	1	2	3	4	5	6	7	8	9	10	11	12	13	14
Scalp	ns	staph	nr	ns	ns	ns	ns	ns	nr	ns	ns	ns	ns	ns
Ear	staph	staph	staph	nr	staph	G + R	Neisseria proact. staph.	staph	staph	Neisseria	staph	G + R staph	nr	staph
Eye	staph	staph	nr	Neisseria	nr	staph	nr	nr	nr	nr	nr	staph	nr	staph
Nose	staph	staph	staph	nr	nr	nr	G+R, Bac. Coryn. S staph	Neisseria staph	mic, G+R Neisseria lacto staph	mic, G+R Neisseria lacto, staph	saliv, staph	mitis, G+R lacto staph	mic, G+R lacto staph	G + R lacto staph
Mouth	ns	mitis, PFILO Hemophilus strep. Type A saliv, staph	Hemophilus Neisseria saliv	ns	ns	ns	ns	ns	mitis, saliv actino, PFILO staph, G+R Hemophilus Neisseria	ns	ns	ns	ns	mitis, saliv Hemophilus Neisseria actino. pneumococci
Throat	G + R Coryn. P	mitis PFILO lacto Coryn. F staph	mitis lacto Coryn. P	saliv lacto Coryn. P	Coryn. P	mitis Neisseria	Coryn. P	Aerobacter mitis PFILO par. staph	saliv mitis PFILO staph G+R, lacto	saliv mitis PFILO staph	staph	saliv, mitis PFILO, staph G + R Hemophilus Coryn. P	mic. saliv mitis	G + R
Axilla	Aerobacter staph	staph	mic.	nr	Neisseria staph	mic, proact. staph	staph	staph	staph	nr	G+R, staph proact.	staph	nr	staph
Umbilicus	staph	staph	nr	nr	mic.	staph	nr	nr	nr	staph	Neisseria	G + R	mic., staph	nr
Oroin	Aerobacter staph	par. staph	staph	Aerobacter par.	nr	Aerobacter par., staph	entero par.	staph	PFILO G + R	Aerobacter G + R Neisseria	Aerobacter G + R staph	nr	Aerobacter G + R par.	nr
Glans penis	ns	Aerobacter Neisseria	Aerobacter par., staph	ns	ns	ns	ns	ns	G + R	ns	ns	ns	ns	G + R
Anal fold	PFILO	nr	mic PFILO	nr	PFILO, G+R Coryn. S staph	PFILO Coryn. S	entero Coryn. S	nr	Coryn. S	staph	E. coli PFILO, G+R Coryn. S	G + R Coryn. S	nr	nr
Peeces	entero	E. coli E. coli Sal- Rhodotorula	Aerobacter E. coli E. coli Sal- entero	Aerobacter E. coli E. coli Sal- Rhodotorula entero	E. coli E. coli Sal- Rhodotorula	entero G + R	E. coli Sal- E. coli Sal- E. coli Sal- Rhodotorula	E. coli E. coli Sal- E. coli Sal- Rhodotorula	G+R, staph Rhodotorula E. coli Sal-	lacto Coryn. S	entero	ns	ns	ns
Toes	ns	proact. G + R	proact. staph	ns	ns	ns	ns	ns	G + R proact.	ns	ns	ns	ns	nr

TABLE 36 --- Continued

Subject 20

Body Area	Sampling Period													
	1	2	3	4	5	6	7	8	9	10	11	12	13	14
Scalp	ns	staph	Neisseria	ns	ns	ns	ns	ns	nr	ns	ns	ns	ns	nr
Ear	staph	nr	nr	nr	nr	nr	nr	nr	nr	nr	nr	mid, staph	nr	Sarcina, staph
Eye	nr	nr	nr	nr	nr	nr	nr	G + R Coryn. X	nr	nr	nr	staph	nr	ns
Nose	staph	staph	nr	nr	lacto staph	Homophilus	staph	staph	staph	lacto staph	staph	nr	G+R, lacto staph, Bac.	nr
Mouth	ns	PFLO, staph, saliv	PFLO, staph, actino, strep-type A, Neisseria	ns	ns	ns	ns	ns	saliv, PFLO, Neisseria, actino	ns	ns	ns	ns	actino staph, saliv, actino
Throat	nr	PFLO	PFLO, lacto	nr	Rhodococcus lacto	nr	Citrobacter lacto	saliv, actino, PFLO, G+R, lacto	Homophilus lacto	saliv, lacto, Neisseria	actino, mitis	mitis, PFLO	saliv, actino, PFLO	PFLO, G + R, lacto
Axilla	Aerobacter staph	staph	nr	staph	staph	act, G+R, proact, staph	act, staph	act, staph	staph	G+R, Bac. proact, staph	staph	Neisseria staph	Aerobacter act., G+R, proact, staph	staph
Forearm	ns	staph	nr	ns	ns	ns	ns	ns	nr	ns	ns	ns	ns	nr
Umbilicus	staph	nr	nr	nr	staph	nr	nr	staph	staph	nr	nr	nr	nr	nr
Groin	PFLO, staph	PFLO, staph	staph	G + R staph	nr	staph	staph	act, staph	nr	PFLO, staph	staph	staph	par, staph	nr
Glans penis	ns	PFLO	staph	ns	ns	ns	ns	ns	PFLO, G+R	ns	ns	ns	ns	nr
Anal fold	E. coli, Aerobacter, E. coli Sal+, E. coli Sal+, PFLO, staph, Coryn. P	Aerobacter, E. coli, E. coli Sal+, E. coli Sal+, Coryn. P	PFLO, G + R, Coryn. P	E. coli, E. coli Sal+, G+R, staph, Coryn.	staph	Alcaligenes, mitis, entero, E. coli Sal+	entero, G + R	nr	nr	staph	E. coli, staph	G + R, Coryn. P	G + R, Coryn. P, staph	G + R, Coryn. P
Feces	entero, E. coli, E. coli Sal+, E. coli Sal+, 7/10/61B	E. coli, E. coli Sal+, E. coli Sal+, entero	E. coli, E. coli Sal+, entero	Aerobacter, E. coli, E. coli Sal+, E. coli	Aerobacter, E. coli, E. coli Sal+, E. coli Sal+, par, staph	E. coli, E. coli Sal+, E. coli Sal+, E. coli Sal+	Lacto, E. coli, S. coli, E. coli, proact.	lacto, E. coli, S. coli, E. coli, lacto	G + R, S. coli, lacto	lacto	ns	ns	ns	ns
Tons	ns	act, G+R, staph, yeast, Coryn. S	G + R, Coryn. S, staph	ns	ns	ns	ns	ns	staph	ns	ns	ns	ns	nr

66

TABLE 36 --- Continued

Subject 21

Body Area	Sampling Period															
	1	2	3	4	5	6	7	8	9	10	11	12	13	14	15	16
Scalp	staph	staph	ns	ns	ns	ns	ns	ns	staph	staph	ns	ns	ns	ns	staph	ns
Ear	staph	par.	staph	par, staph	par.	par.	staph	staph	staph	staph	lacto	lacto	par.	nr	nr	nr
Eye	Moraxella	G + R	ns	ns	ns	ns	ns	ns	nr	ns	ns	ns	ns	ns	staph	ns
Nose	staph	Coryn. F	staph	Pen. sp.	Lacto	staph	G + R	staph	Coryn. P	staph	Pen. sp.	Proact.	Pen. sp.	Coryn. I	Pen. sp.	nr
Mouth	PfLO	sally	PfLO, staph	G + R	PfLO	G + R	Calbioan	PfLO	lacto	lacto	lacto	PfLO	lacto	G + R, lacto	sally	sally
	staph	faecalis	lacto	Moraxella	Calbioan	staph, sally	staph, sally	sally	sally	sally	staph, sally	sally	sally, mitis	Moraxella	mitis	mitis
	sally	faecalis	sally	Mim, sally	Mim, sally	mitis	mitis	mitis	mitis	mitis	mitis	mitis	mitis	Mim	faecalis	faecalis
	mitis	staph	sally, mitis	mitis, Bac.	mitis	sally	mitis	mitis	mitis, lacto	mitis, cat.	sally	sally	sally	mitis	sally, mitis	mitis
Throat	sally	faecalis	PfLO, lacto	staph, G + R	sally	mitis	lacto, G + R	staph	staph	staph	staph	staph	staph	mitis	mitis	mitis
	mitis	staph	proact.	sally	staph	faecalis	faecalis	staph	staph	staph	staph	staph	nr	mitis	mitis	sally
Arilla	staph	nr	staph	staph, G + R	staph	staph	staph, kina	staph	staph, G + R	staph	staph	staph	nr	G + R	nr	G + R
Forearm	proact.	nr	ns	ns	ns	ns	ns	ns	staph	ns	ns	ns	ns	ns	staph	ns
Umbilicus	staph	proact.	ns	ns	ns	ns	ns	ns	staph	ns	ns	ns	ns	ns	staph	ns
	G + R	Coryn, staph	ns.	ns	ns	ns	ns	ns	staph	ns	ns	ns	ns	ns	staph	ns
	ns.	ns.	ns.	ns.	ns.	ns.	ns.	ns.	ns.	ns.	ns.	ns.	ns.	ns.	ns.	ns.
Groin	proact.	Klebsiella	staph	staph	Klebsiella	G + R	staph	cat.	G + R	staph	staph	staph	ns	Coryn. I	ns	ns
	staph	Aerobacter	proact.	staph	Aerobacter	Alternaria	staph	staph	staph	staph	staph	staph	ns	ns	ns	ns
	proact.	staph	proact.	proact.	staph	staph	staph	staph	staph	staph	staph	staph	ns	proact.	nr	nr
	staph	staph	staph	staph	staph	staph	staph	staph	staph	staph	staph	staph	ns	ns	ns	ns
Anal fold	proact.	Calbioan	ns	ns	ns	ns	ns	ns	staph	lactis	ns	ns	ns	ns	staph	ns
	staph	staph	faecalis	faecalis	faecalis	faecalis	faecalis	faecalis	faecalis	faecalis	faecalis	faecalis	faecalis	faecalis	faecalis	faecalis
Feces	PfLO	Klebsiella	lacto	Klebsiella	E. coli	E. coli	E. coli	lacto	lacto	lacto	lacto	lacto	lacto	lacto	lacto	ns
	G + R	Aerobacter	proact.	Aerobacter	0125, B15	0125, B15	0125, B15	proact.	proact.	proact.	proact.	proact.	proact.	Bac.	ns	ns
	lacto	proact.	proact.	proact.	faecalis	faecalis	faecalis	faecalis	faecalis	faecalis	faecalis	faecalis	faecalis	faecalis	faecalis	faecalis
	faecalis	proact.	proact.	proact.	faecalis	faecalis	faecalis	faecalis	faecalis	faecalis	faecalis	faecalis	faecalis	faecalis	faecalis	faecalis
Toes	staph	proact.	ns	ns	ns	ns	ns	ns	staph	ns	ns	ns	ns	ns	staph	ns
	staph	staph	staph	staph	staph	staph	staph	staph	staph	staph	staph	staph	staph	staph	staph	staph
	staph	staph	staph	staph	staph	staph	staph	staph	staph	staph	staph	staph	staph	staph	staph	staph

TABLE 36 --- Continued

Subject 22

Body Area	Sampling Period															
	1	2	3	4	5	6	7	8	9	10	11	12	13	14	15	16
Body Area	staph	staph	ns	ns	staph	staph	staph	ns	ns	staph	staph	ns	ns	ns	staph	ns
Scalp	staph	staph	staph	staph	staph	staph	staph	ns	proact. staph,lacto	staph	staph	staph	lacto	proact	staph	ns
Ear	staph	staph	staph	staph	staph	staph	staph	ns	staph,lacto	staph	staph	staph	lacto	proact	nr	nr
Nose	staph	staph	staph	staph	staph	staph	staph	staph	staph	staph	staph	staph	staph	staph	nr	nr
Mouth	staph	staph	staph	staph	staph	staph	staph	staph	staph	staph	staph	staph	staph	staph	staph	staph
Throat	staph	staph	staph	staph	staph	staph	staph	staph	staph	staph	staph	staph	staph	staph	staph	staph
Axilla	staph	staph	staph	staph	staph	staph	staph	staph	staph	staph	staph	staph	staph	staph	staph	staph
Forearm	staph	staph	staph	staph	staph	staph	staph	staph	staph	staph	staph	staph	staph	staph	staph	staph
Umbilicus	staph	staph	staph	staph	staph	staph	staph	staph	staph	staph	staph	staph	staph	staph	staph	staph
Groin	staph	staph	staph	staph	staph	staph	staph	staph	staph	staph	staph	staph	staph	staph	staph	staph
Glans penis	staph	staph	staph	staph	staph	staph	staph	staph	staph	staph	staph	staph	staph	staph	staph	staph
Anal fold	staph	staph	staph	staph	staph	staph	staph	staph	staph	staph	staph	staph	staph	staph	staph	staph
Feces	staph	staph	staph	staph	staph	staph	staph	staph	staph	staph	staph	staph	staph	staph	staph	staph
Toes	staph	staph	staph	staph	staph	staph	staph	staph	staph	staph	staph	staph	staph	staph	staph	staph

TABLE 36 --- Continued

Subject 23

Body Area	Sampling Period															
	1	2	3	4	5	6	7	8	9	10	11	12	13	14	15	16
Scalp	staph	staph, G+R	ns	ns	ns	ns	ns	ns	ns	staph	ns	ns	ns	ns	staph	ns
Ear	staph	staph	staph	ns	staph, Bac	staph	staph	staph	staph	staph	staph	staph, Bac, nr	ns	ns	nr	nr
Eye	nr	staph	ns	ns	ns	ns	ns	ns	ns	staph	ns	ns	ns	ns	staph	ns
Nose	staph	staph	staph	staph	staph, G + R	staph, faecalis	faecalis	staph	staph	staph	staph	staph	nr	faecalis	nr	nr
Mouth	saliv faecalis	Bac, mitis lacto saliv faecalis	saliv mitis	Bac, lacto proact. saliv faecalis	staph saliv mitis	PfLO staph mitis	staph mitis G + R	staph mitis G + R	C. albicans saliv	staph	Coryn. S staph	C. albicans saliv faecalis	C. albicans mitis faecalis	mitis G + R	C. albicans saliv mitis	C. albicans mitis
Throat	PfLO saliv faecalis	Moraxella mitis saliv mitis	PfLO, G+R Coryn. P saliv mitis	faecalis staph saliv mitis	saliv mitis faecalis	lacto, G+R saliv mitis	saliv mitis	saliv mitis	saliv mitis	staph	Bac, lacto saliv mitis S. uberris	PfLO, mitis C. albicans lacto, Bac, staph, saliv	nr	Bac. Coryn. P	nr	C. albicans saliv mitis
Acilla	staph	nr	proact. staph	proact. staph	staph	staph	staph	staph	staph	staph	staph	staph	staph	staph	staph	nr
Forearm	Bac. lacto	proact. staph	ns	ns	ns	ns	ns	ns	ns	staph	ns	ns	ns	ns	staph	ns
Umbilicus	Bac, G+R Coryn. S proact. lacto	nr	ns	ns	ns	ns	ns	ns	ns	staph	ns	ns	ns	ns	staph	ns
Ureth	Bac. lacto staph	nonpatho- genic yeast staph	staph	Coryn. S staph G + R	Klebsiella Aerobacter staph G + R	Klebsiella Aerobacter staph	Klebsiella Aerobacter staph Trich. sp.	Klebsiella Aerobacter Trich. sp. staph	Klebsiella Aerobacter Trich. sp. lacto, staph proact.	Klebsiella Aerobacter Coryn. X Trich. sp. lacto, staph proact.	Klebsiella Aerobacter Trich. sp. lacto, staph	Klebsiella Aerobacter Trich. sp. Klebsiella Aerobacter staph	Trich. sp. Trich. sp. Trich. sp. Trich. sp.	Trich. sp. Coryn. X Trich. sp.	Trich. sp.	Trich. sp.
Glans penis	Coryn. X staph	nr	staph G + R	Coryn. P staph	staph G + R	Trich. sp. lacto staph	Trich. sp. Bac. staph	Trich. sp. staph	Trich. sp. lacto, staph	Coryn. X Trich. sp. lacto, staph	lacto staph	Coryn. P Trich. sp. lacto, staph	Trich. sp. lacto	Trich. sp. proact.	Trich. sp.	Trich. sp.
Anal fold	Bac, lacto saliv faecalis	staph	ns	ns	ns	ns	ns	ns	ns	staph Pat. S-C Trich. sp.	ns	ns	ns	ns	Coryn. S Trich. sp. faecalis	ns
Feces	E. coli 0127:198 lacto Bac, G+R C. acnes	ns	E. coli 0127:198 lacto proact.	E. coli Klebsiella Aerobacter lacto faecalis G + R	E. coli Klebsiella Aerobacter lacto mitis faecalis G + R	Pat. S-C lacto 0126:198 lacto faecalis G + R	Pat. S-C lacto faecalis G + R	Pat. S-C lacto Bac. proact. saliv faecalis	Pat. S-C lacto Bac. saliv mitis faecalis	Pat. S-C lacto saliv	Pat. S-C Klebsiella Aerobacter lacto C. albicans faecalis	Pat. S-C lacto proact. faecalis	Pat. S-C C. albicans faecalis	Pat. S-C	ns	ns
Toes	staph	staph	ns	ns	ns	ns	ns	ns	ns	G + R	ns	ns	ns	ns	nr	ns

TABLE 36 --- Continued

Body Area	Sampling Period															
	1	2	3	4	5	6	7	8	9	10	11	12	13	14	15	16
Scalp	staph	staph	ns	ns	ns	staph	staph	ns	staph,G+R	ns	ns	ns	ns	ns	staph	ns
Ear	staph	staph	staph	proact. staph	proact. staph,G+R	staph	staph	staph	staph	staph	staph	cat.	ns	ns	ns	ns
Eye	Moraxella, Mms, staph	staph	ns	ns	ns	ns	ns	ns	staph	staph	ns	ns	ns	ns	ns	ns
Nose	staph	Pen.sp. staph	staph	staph	Moraxella Mms	staph	Trich.sp. Hemophilus staph,G+R	staph	Coryn. P staph	staph	staph	staph	ns	mitis	mitis	ns
Mouth	PFLO	PFLO	mitis	C. albicans	lacto	staph	lacto	staph	staph	staph	staph	PFLO	saliv	lacto	saliv	proact. saliv
Throat	PFLO	Bac, mitis	lacto	C. albicans	lacto	staph	staph	proact. saliv	PFLO	staph	lacto	PFLO,G+R	C. albicans	lacto	saliv	C. albicans
Arilla	staph	staph	staph	staph	staph	staph	staph	staph	staph	staph	staph	staph	staph	staph	staph	ns
Forearm	G + R	Bac.	ns	ns	ns	ns	ns	ns	ns	ns	ns	ns	ns	ns	staph	ns
Umbilicus	Bac.	proact. staph,G+R	ns	ns	ns	ns	ns	ns	ns	ns	ns	ns	ns	ns	staph	ns
Groin	staph	staph	G + R	G + R	staph	staph	staph	staph	staph	staph	staph	staph	Bac,G+R	Alcaligenes	ns	G + R
Clans penis	proact. ans.	G + R	staph	staph	lacto	G + R	staph	lacto	enz. staph	staph	staph	PFLO	ns	lacto	ns	ns
Anal fold	enz.,G+R	G + R	ns	ns	ns	ns	ns	ns	staph	staph	ns	ns	ns	ns	ns	ns
Feces	E. coli	E. coli	Hemophilus	E. coli	E. coli	E. coli	E. coli	E. coli	E. coli	E. coli	E. coli	proact.	E. coli	fecalis	ns	ns
Toes	proact. staph	proact. staph	ns	ns	ns	ns	ns	ns	G + R	G + R	ns	ns	ns	ns	ns	ns

TABLE 36 --- Continued

Subject 25

Body Area	Sampling Period															
	1	2	3	4	5	6	7	8	9	10	11	12	13	14	15	16
Scalp	Coryn. Pat. A staph	ns	ns	ns	ns	ns	ns	ns	ns	ns	ns	ns	ns	ns	ns	staph
Ear	staph	staph	staph	staph	staph	Coryn. Pat. A staph	staph	Bas. Pat. A Coryn staph	staph	staph	staph	staph	ns	ns	Coryn. Pat. A	Bas.
Eye	ns	ns	ns	ns	ns	ns	ns	ns	ns	ns	ns	ns	ns	ns	ns	staph
Nose	Pen. sp (oryzase) staph	Coryn S+ staph	Asyn. sp. Coryn S+ staph	staph	Coryn S+ staph	staph	N. Flava staph	weak alk. dispar. E. rubrum N. Flava staph	weak alk. dispar. N. Flava staph	N. Flava staph	staph	staph	ns	ns	weak alk. dispar. N. Flava Hemophilus	Coryn. S+
Mouth	Lacto Coryn. P Hemophilus N. Flava saliv	saliv	Lacto N. Flava saliv mitis	Hemophilus N. Flava saliv mitis Lactis	Lacto, mitis Coryn. P Hemophilus N. Flava saliv	Coryn. P Hemophilus saliv mitis faecalis	Asyn. sp. saliv mitis	Coryn. P saliv mitis	Hemophilus saliv mitis Lactose	Lacto staph saliv	Coryn. P N. siccus saliv	saliv mitis	N. siccus saliv mitis	Coryn. P N. siccus saliv mitis	Coryn. P saliv mitis	saliv mitis
Throat	Coryn. P Hemophilus N. Flava saliv, mitis	N. siccus saliv	Lacto Coryn. P N. siccus saliv, mitis	N. siccus saliv mitis	Coryn. P N. siccus staph saliv, mitis	Pen. sp. N. siccus staph saliv, mitis	Lacto, mitis Coryn. P N. Flava N. Flava saliv	Trich. sp. N. Flava N. Flava mitis	Coryn. P N. Flava saliv mitis	Lacto N. Flava saliv mitis	Coryn. P staph saliv, mitis tubercis	N. Flava saliv mitis	Neisseria saliv mitis	Hemophilus N. siccus saliv mitis	Hemophilus N. Flava saliv mitis	Pen. sp. Hemophilus saliv mitis
Axilla	staph	staph	staph	staph	staph	Bas. staph	M. lundich. staph	staph	staph	staph	staph	staph	ns	ns	ns	ns
Forearm	staph	Bas.	ns	ns	ns	ns	ns	staph	ns	ns	ns	ns	ns	ns	ns	staph
Umbilicus	ns	ns	ns	ns	ns	ns	ns	ns	ns	ns	ns	ns	ns	ns	ns	Scop. sp. staph
Groin	ns	Coryn. Pat. A staph	staph	Coryn. Pat. A staph	staph	staph	Coryn. Pat. A staph	staph	Coryn. S+ staph	staph	Coryn S+ staph	staph	ns	ns	ns	ns
Glans penis	staph	staph	staph	Coryn S+ staph	staph	Coryn. S+ staph	staph	staph	staph	staph	staph	staph	ns	ns	ns	Coryn. S+
Anal fold	E. coli Poly A Coryn. Pat. A	ns	ns	ns	ns	ns	ns	staph faecalis	ns	ns	ns	ns	ns	ns	ns	Scop. sp. staph faecalis
Feet	E. coli Poly A faecalis	E. coli	E. coli	E. coli Poly A	Lacto	E. coli	E. coli Poly A faecalis	E. coli Aerobacter saliv faecalis	Aerobacter saliv faecalis	Aerobacter lacto saliv faecalis	Aerobacter faecalis	Aerobacter E. coli faecalis	E. coli saliv faecalis	E. coli faecalis	faecalis	faecalis
Toes	Coryn. S+	ns	ns	ns	ns	ns	ns	staph Coryn. S+	ns	ns	ns	ns	ns	ns	ns	staph Coryn. S+

* 10⁻⁶ lowest dilution of feces plated

TABLE 36 --- Continued

Subject 26

Body Area	Sampling Period															
	1	2	3	4	5	6	7	8	9	10	11	12	13	14	15	16
Beak	staph	ns	ns	staph	staph	staph	staph	ns	staph	ns	ns	ns	ns	ns	ns	staph Coryn.sp.
Ear	Coryn. BkA staph	nr	staph	staph	staph	staph	staph	staph	staph	Coryn. Pat. A	staph	Coryn. Pat. A	nr	Coryn. Pat. A	nr	nr
Eye	nr	ns	ns	ns	ns	ns	ns	nr	nr	ns	ns	ns	ns	ns	ns	staph
Nose	staph	Coryn. Pat. A	staph	Asperg.sp. Coryn.sp. N. sioca staph	staph	Coryn.sp. N. flava staph	Coryn.sp. staph	N. flava N. sioca staph	Coryn. BkA N. flava N. sioca staph	staph	staph	staph	Coryn. S+ Coryn. Pat. A	Coryn. S+ Coryn. Pat. A	nr	Coryn. S+
Mouth	Coryn. P sally	sally	N. flava sally mitis	Hemophilus N. flava Mitis sally	sally mitis	Coryn. P N. sioca sally mitis	staph sally mitis	Coryn. P N. flava staph sally mitis	Coryn. P N. flava staph sally mitis	staph sally mitis	sally	Coryn. P N. flava sally mitis	N. sioca sally mitis	Coryn. P Hemophilus N. flava sally mitis	Coryn. P Hemophilus N. flava sally mitis	Pen.sp. N. sioca sally mitis
Throat	Lacto Coryn.sp. Hemophilus sally mitis	N. flava N. sioca sally mitis	Lacto Hemophilus N. sioca sally mitis	Coryn.sp. Hemophilus N. flava Mitis sally	N. sioca sally mitis	Lacto N. sioca sally mitis	Coryn.sp. N. flava sally mitis	N. sioca sally mitis	N. flava N. sioca sally mitis	Hemophilus N. flava Hemophilus sally mitis	N. sioca staph sally mitis	Coryn.sp. N. flava sally mitis	sally	Coryn.sp. Hemophilus N. flava sally mitis	Hemophilus Hemophilus sally mitis	Hemophilus N. sioca sally mitis
Acilla	nr	staph	staph	Bac, staph	staph	staph	Coryn. BkA staph	Coryn. BkA staph	Coryn. BkA staph	staph	staph	staph	Coryn. Pat. A	Coryn. Pat. A	nr	Coryn. Pat. A
Forearm	staph	ns	ns	ns	ns	ns	ns	ns	ns	ns	ns	ns	ns	ns	ns	staph Coryn.sp.
Umbilicus	nr	nr	ns	ns	ns	ns	ns	nr	nr	ns	ns	ns	ns	ns	ns	staph
Ureth	nr	Trich. Coryn. S+ staph	Asperg.sp. staph	Trich. staph	Trich. staph	Trich. staph	Trich. staph	Trich. staph	Trich. staph	Trich. staph	Trich. staph	Trich. staph	Trich. staph	Trich. staph	Trich. staph	Trich. staph
GLAND penis	nr	Coryn. S+ staph	staph	Coryn. S+ staph	Trich. staph	Trich. Coryn. S+ staph	Trich. staph	Trich. staph	Trich. staph	staph	Trich. Coryn. S+ staph	Trich. Coryn. S+ staph	nr	Trich. Coryn. S+	nr	Coryn. S+
Anal fold	Coryn. S+	ns	ns	ns	ns	ns	ns	staph Trich. Coryn. S+	Trich. Coryn. S+	ns	ns	ns	ns	ns	ns	staph faecalis
Feces **	Alk. dispar faecalis	weak Alk. dispar	Alk. dispar lacto	Alk. dispar sally faecalis	Alk. dispar faecalis	Alk. dispar staph	weak Alk. dispar faecalis	weak Alk. dispar faecalis	weak Alk. dispar faecalis	sally faecalis	nr	Pen.sp.	staph sally faecalis	faecalis	faecalis	nr
Toes	Coryn. sp staph	ns	ns	ns	ns	ns	ns	Coryn.sp. ns	Coryn.sp. ns	ns	ns	ns	ns	ns	ns	staph Coryn.sp.

** 10⁻⁶ Lowest dilution of feces plated

TABLE 36 --- Continued

Subject 27

Body Area	Sampling Period															
	1	2	3	4	5	6	7	8	9	10	11	12	13	14	15	16
Scalp	staph	ns	ns	ns	ns	ns	ns	staph	ns	ns	ns	ns	ns	ns	ns	Trich, staph Coryn. sp.
Ear	Cand. sp. Coryn. S+ A	Cand. sp. Coryn. S+ A	Cand. sp.	Cand. sp.	Cand. sp.	Cand. sp. Pat. A	Cand. sp.	Cand. sp. Coryn. S+ A	Cand. sp.	Cand. sp.	Cand. sp.	Cand. sp.	Cand. sp.	Cand. sp. Actino. albus	Cand. sp. Coryn. Pat. A	nr
Eyes	staph	ns	ns	ns	ns	ns	ns	staph	ns	ns	ns	ns	ns	ns	ns	staph
Nose	E. coli Coryn. P staph	E. coli staph	staph	T. rubrum staph saliv	Cand. sp. staph	C. albicans staph	Rhodo. staph	Coryn. P Hemophilus N. flava	Coryn. P staph	ns	Coryn. P staph	staph	ns	T. rubrum Coryn. P	E. coli Coryn. P	ns
Mouth	C. albicans Lacto sp. Sarcina Hemophilus Neisseria	C. albicans saliv	C. albicans Hemophilus Neisseria saliv, Sarcina faecalis	Coryn. sp. saliv mitis faecalis	C. albicans Neisseria staph, saliv Sarcina faecalis	C. albicans N. sicca saliv faecalis	C. albicans saliv mitis Neisseria Sarcina	C. albicans Lacto N. sicca saliv mitis	C. albicans C. albicans N. sicca staph saliv mitis	C. albicans Lacto N. sicca staph saliv mitis	C. albicans Rhodotorula saliv mitis	Lacto saliv mitis	Rhodotorula saliv mitis	saliv mitis	Lacto Coryn. sp. saliv mitis	C. albicans saliv
Throat	C. albicans Lacto Coryn. P saliv mitis	C. albicans faecalis	C. albicans staph mitis	C. albicans Hemophilus N. sicca staph, saliv mitis	C. albicans Hemophilus N. sicca saliv mitis	C. albicans saliv mitis	C. albicans Coryn. P saliv mitis	C. albicans Coryn. P N. sicca saliv mitis	C. albicans C. albicans N. flava Coryn. P Mycoco- luteus saliv mitis	C. albicans Coryn. P N. flava saliv mitis	C. albicans Rhodotorula Lactobac. N. flava Neisseria proact. mitis	C. albicans Rhodotorula saliv mitis	C. albicans Rhodotorula Lactobac. N. flava Neisseria saliv mitis	C. albicans Coryn. P Hemophilus N. flava saliv mitis	C. albicans N. flava saliv mitis	C. albicans N. flava saliv mitis
Axilla	staph	staph	staph	Coryn. S+ staph	staph, Mycoda sterilis Coryn. S+	Coryn Pat. A staph	staph	staph	staph	staph	staph	Coryn. S- staph	Coryn. S+ staph	nr	nr	Coryn. S+ staph
Forearm	nr	ns	ns	ns	ns	ns	ns	staph	ns	ns	ns	ns	ns	ns	ns	nr
Umbilicus	Pen. sp. Bag.	ns	ns	ns	ns	ns	ns	nr	ns	ns	ns	ns	ns	ns	ns	staph
Groin	staph	Trich, staph Coryn. Pat A	staph	Trich, staph Coryn. Pat A	staph	Trich. staph	Trich, staph Coryn. Pat A	Trich, staph Coryn. S+	Trich. staph	Trich. staph	Trich. staph	Trich. staph	Coryn. S+ staph	Trich. Coryn. S+	Trich. Coryn. S+	Trich.
Glans penis	nr	nr	Coryn. S+ staph	Coryn. S+ nr	nr	Coryn. S+ staph	staph	Coryn. S+ staph	Coryn. S+ staph	Trich. staph	Trich. staph	nr	nr	Trich.	Trich.	Coryn. S+
Anal fold	Coryn. S+	ns	ns	ns	ns	ns	ns	Trich. lacto	ns	ns	ns	ns	ns	ns	ns	High, staph Coryn. S+ N. flava faecalis
Feces**	Lacto faecalis	E. coli C. albicans faecalis	Aerobacter E. coli C. albicans faecalis	E. coli Pattern I faecalis	Aerobacter I faecalis	E. coli Pattern I faecalis	E. coli Pattern I faecalis	E. coli Aerobacter lacto staph	Aerobacter C. albicans lacto staph	Aerobacter C. albicans lacto staph	Aerobacter C. albicans lacto staph	Aerobacter C. albicans lacto staph	E. coli lacto staph	E. coli C. albicans lacto staph	faecalis	ns
Toes	Coryn. S+ staph	ns	ns	ns	ns	ns	ns	Pen. sp. staph	ns	ns	ns	ns	ns	ns	ns	ns

*Cand. sp. probably C. guilliermondii; ** 10⁻⁶ lowest dilution of feces plated; I K Vi C Pattern I = + + + alk/alk

TABLE 36 --- Continued

Subject 28

Body Area	Sampling Period																
	1	2	3	4	5	6	7	8	9	10	11	12	13	14	15	16	
Scalp	staph	ns	ns	ns	ns	ns	ns	staph	ns	ns	ns	ns	ns	ns	ns	staph	
Ear	Pen.sp. staph	staph	staph	staph	staph	Coryn. sp. staph	staph	staph	staph	staph	staph	Act.albus staph	Coryn. sp.	Coryn. sp.	nr	Coryn. sp.	
Eye	staph	ns	ns	ns	ns	ns	ns	nr	ns	ns	ns	ns	ns	ns	ns	staph	
Nose	staph	staph	staph	staph	staph	staph	staph	staph	faecalis	staph	staph	staph	nr	Coryn. sp.	nr	Coryn. sp.	
Mouth	sally	sally	Hemophilus N. flava sally mitis	Coryn. P Hemophilus N. flava sally mitis	Coryn. P Hemophilus N. flava sally mitis	Coryn. P Hemophilus N. flava sally mitis	Rhodo. sally mitis	Coryn. P Hemophilus N. flava sally mitis	Hemophilus N. flava sally mitis	Coryn. P Hemophilus N. siccica sally mitis	Coryn. P Hemophilus N. siccica sally mitis	Coryn. P Hemophilus N. siccica sally mitis	Coryn. sp.	Coryn. P Hemophilus N. siccica sally mitis	nr	ns	
Throat	Coryn. S+ sally mitis	Hemophilus N. flava sally mitis	Coryn. S+ N. flava sally mitis	Coryn. S+ N. flava sally mitis	N. siccica sally mitis	N. flava promot. sally mitis	Rhodo. sally mitis	Coryn. S+ N. flava sally mitis	Coryn. S+ N. flava sally mitis	N. siccica promot. sally mitis	Coryn. S+ N. flava sally mitis	Coryn. S+ N. flava sally mitis	Coryn. S+ N. siccica sally mitis	Coryn. S+ Hemophilus N. flava sally mitis	Coryn. S+ Hemophilus N. flava sally mitis	nr	ns
Axilla	nr	Coryn. S+ staph	Coryn. S+ staph	Coryn. S+ staph	Coryn. S+ staph	Coryn. S+ staph	Coryn. S+ staph	Coryn. S+ staph	Coryn. S+ staph	Coryn. S+ staph	Coryn. S+ staph	Coryn. S+ staph	nr	Act.albus	nr	Coryn. S+ staph	
Forearm	staph	ns	ns	ns	ns	ns	ns	nr	ns	ns	ns	ns	ns	ns	ns	staph	
Umbilicus	nr	ns	ns	ns	ns	ns	ns	staph	ns	ns	ns	ns	ns	ns	ns	nr	
Groin	staph	staph	staph	Coryn. S+ staph	Coryn. S+ staph	Coryn. S+ staph	Coryn. S+ staph	Coryn. S+ staph	staph	nr	staph	nr	nr	nr	nr	nr	
Glans penis	nr	staph	staph	Coryn. S+ staph	Coryn. S+ staph	Coryn. S+ staph	Coryn. S+ staph	staph	staph	staph	staph	nr	nr	nr	nr	Coryn. S+ staph	
Anal fold	Scop. sp. Coryn. S+ staph	ns	ns	ns	ns	ns	ns	staph	ns	ns	ns	ns	ns	ns	ns	Coryn. S+ staph	
Feces**	E. coli faecalis	E. coli faecalis	faecalis	E. coli faecalis	E. coli faecalis	E. coli faecalis	E. coli faecalis	E. coli faecalis	E. coli faecalis	E. coli faecalis	E. coli faecalis	E. coli faecalis	E. coli faecalis	E. coli faecalis	E. coli faecalis	staph	
Toes	Coryn. S+ staph	ns	ns	ns	ns	ns	ns	Coryn. S+ staph	ns	ns	ns	ns	ns	ns	ns	staph faecalis	

** 10⁻⁶ lowest dilution of feces plated
Pattern II = - - - + A/H₂S + G (Does not type Salmonella, Arizona, or Bethesda-Ballarp)

TABLE 36 --- Continued

Subject 29

Body Area	Sampling Period															
	1	2	3	4	5	6	7	8	9	10	11	12	13	14	15	16
Scalp	ns	staph	ns	ns	ns	ns	ns	ns	staph	ns	ns	ns	ns	ns	ns	Coryn. S+ staph
Ear	Cand. sp. staph	staph	Cand. sp. staph	staph	staph	staph	staph	staph	staph	staph	staph	staph	nr	nr	Coryn. P	nr
Eye	ns	staph	ns	ns	ns	ns	ns	ns	staph	ns	ns	ns	ns	ns	ns	staph
Nose	Pen. sp. staph	Pen. sp. staph	staph	staph	Coryn. P Pen. sp. staph	Asperg. sp. staph	Coryn. P Asperg. sp. staph	Coryn. S staph	Asp. rg. sp. staph	Coryn. P Coryn. P staph	ns	staph	Coryn. P	Bac. Coryn. Pat. A	Coryn. P	Coryn. P Asperg. sp.
Mouth	nr	nr	staph	cat.	staph	Coryn. Pat. staph	staph	staph	staph	H. siccus	staph	staph	nr	nr	nr	nr
Throat	Helicobacteria PFLO	nr	Bac.	nr	nr	nr	Bac. H. siccus	PFLO	staph	Coryn. S H. siccus	ns	nr	nr	Coryn. Pat. H. siccus	Helicobacteria Pat. I	Rhodo.
Axilla	staph	Coryn. S Coryn. S+ staph	staph	staph	Coryn. S+ staph	Coryn. S staph	staph	staph	staph	Coryn. S+ PFLO	staph	staph	nr	PFLO	Coryn. S+	nr
Forearm	nr	staph	ns	ns	ns	ns	ns	ns	staph	ns	ns	ns	ns	ns	ns	staph
Umbilicus	nr	nr	ns	ns	ns	ns	ns	ns	staph	ns	ns	ns	ns	ns	ns	staph
Groin	staph	Coryn. S	staph	staph	Coryn. S staph	staph	staph	staph	nr	Act. albus Act. flavus staph	staph	staph	Bac.	nr	nr	Coryn. S+
Glans penis	staph	staph	staph	Pseudomonas Coryn. S+ staph	Pseudomonas H. perflava	Pseudomonas staph	Pseudomonas staph	staph	Pseudomonas staph	Pseudomonas staph	Pseudomonas staph	Coryn. S+ staph	Pseudomonas H. perflava	Pseudomonas H. perflava PFLO	nr	Coryn. S+
Anal fold	Coryn. P Coryn. Pat. B staph, PFLO	ns	ns	ns	ns	ns	ns	Coryn. ens. staph	ns	ns	ns	ns	ns	ns	ns	Coryn. sp. Coryn. Pat. A staph, PFLO
Face**	staph	Pseudomonas staph	E. coli, Poly B Pseudomonas	ns	ns	E. coli, Poly B Coryn. ens. CL26/R16	Coryn. ens. Coryn. ens. CL26/R16	E. coli, Poly A CL27/R8 Poly B CL26/R16	Aerobacter A CL27/R8 Poly B CL26/R16	Aerobacter A CL27/R8 Poly B CL26/R16	E. coli, Poly A CL27/R8 Poly B CL26/R16	E. coli, Poly A CL27/R8 Poly B CL26/R16	E. coli, Poly A CL27/R8 Poly B CL26/R16	E. coli, Poly A CL27/R8 Poly B CL26/R16	Coryn. P	ns
Toes	ns	Pen. sp. staph Coryn. S+	ns	ns	ns	ns	ns	ns	staph	nr	ns	ns	ns	ns	ns	staph
WLP-6	lowest dilution of feces plated															

TABLE 36 --- Continued

Body Area	Sampling Period															
	1	2	3	4	5	6	7	8	9	10	11	12	13	14	15	16
Scalp	ns	staph	ns	ns	ns	ns	ns	ns	staph	ns	ns	ns	ns	ns	ns	Coryn. Pat A staph
Ear	nr	staph	staph	nr	staph	staph	staph	nr	staph	staph	Aut. albus Act. flavus staph	staph	nr	nr	Coryn. sp.	nr
Nose	Coryn. S+ pen. sp. staph	Coryn. sp. Pen. sp. staph	Clado- sporium staph	staph	ns, pen. sp. staph	ns, staph	Coryn. S+ Coryn. sp. staph	Coryn. sp. staph	staph	Coryn. P Asperg. sp. staph	Asperg. sp. staph	staph	Asperg. sp.	ns	Asperg. sp.	Coryn. sp.
Mouth	nr	nr	nr	staph	N. sioca PFLO	nr	Hemophilus nr	Misc. Act. albus	Misc.	Neisseria staph	N. sioca Neisseria staph	N. sioca Neisseria staph	N. sioca Neisseria	N. sioca	Misc.	Neisseria
Throat	Neisseria Misc (1) PFLO staph	nr	N. sioca perflava Misc.	Neisseria perflava	staph	nr	N. sioca nr	Misc.	Misc.	nr	N. sioca Misc.	nr	N. sioca Neisseria perflava	N. sioca Misc. PFLO	Neisseria perflava	Misc.
Axilla	Coryn. S+ staph	Coryn. S+ staph	staph	staph	staph	Coryn. S+ staph	staph	Coryn. S+ staph	staph	Coryn. S+ staph	staph	staph	nr	nr	Coryn. S+	nr
Forearm	ns	nr	ns	ns	ns	ns	ns	ns	staph	ns	ns	ns	ns	ns	ns	nr
Umbilicus	ns	staph	ns	ns	ns	ns	ns	ns	staph	ns	ns	ns	ns	ns	ns	nr
Ureth	staph	Coryn. S+ staph	Coryn. S+ staph	Coryn. S+ staph	staph	Coryn. S+ staph	staph	staph	Gaffky staph	staph	N. sioca staph	Act. albus staph	nr	nr	Coryn. P Gaffky	Coryn. S+
Glans penis	Coryn. S+ staph	staph	staph	staph	Coryn. S+ staph	Coryn. S+ staph	staph	staph	Coryn. Pat A Gaffky staph	staph	Gaffky staph	Gaffky staph	nr	Coryn. S+	nr	Coryn. S+
Anal fold	ns	PFLO, staph Coryn. S	ns	ns	ns	ns	ns	ns	staph	ns	ns	ns	ns	ns	ns	Coryn. S staph
Feces (2)	Laeto	E. coli Laeto	E. coli Poly B-NFT Coryn. P Coryn. sp	Aerobacter E. coli H - HPI NFI Laeto	Aerobacter E. coli Poly B NFI Laeto	E. coli Aerobacter Poly B NFI staph	E. coli Aerobacter Poly B NFI staph	E. coli Coryn. S staph	E. coli Coryn. S staph	E. coli Coryn. S staph	E. coli Coryn. S staph	Aerobacter E. coli Laeto PFLO	E. coli Laeto Coryn. S	Aerobacter staph	ns	ns
Toes	ns	staph Coryn. sp.	ns	ns	ns	ns	ns	ns	staph	ns	ns	ns	ns	ns	ns	staph

(1) Mesgallentous - large gran positive coccus resembling sarcosia macroscopically but with a very shiny grey straggy colonial morphology.
 (2) 10⁶ Lowest dilution

TABLE 36 --- Continued

Subject 31

Body Area	Sampling Period															
	1	2	3	4	5	6	7	8	9	10	11	12	13	14	15	16
Sculp	ns	staph	ns	ns	ns	ns	ns	staph	ns	ns	ns	ns	ns	ns	ns	staph
Ear	staph	staph	staph	Coryn. S staph	staph	staph	staph	staph	staph	staph	staph	staph	nr	nr	nr	nr
Eye	ns	staph	ns	ns	ns	ns	ns	staph	ns	ns	ns	ns	ns	ns	ns	E. coli 0117:186 026:186
Nose	Coryn. S+ Pen. sp. staph	Pen. sp. staph	Coryn. Pat A staph	staph	staph	staph	staph	Coryn. S+ staph	staph	staph	N. sicca staph	staph	N. parviflora	nr	nr	Coryn. Pat A Clado- sporium
Mouth	Pen. Neisseria	Pat. S-C* lacto C. albicans	Neisseria	C. albicans nr	nr	Hemophilus misc. Neisseria	lacto misc. Neisseria	nr	Neisseria Pat. I C. albicans staph	N. sicca out. staph	Neisseria	C. albicans	Neisseria	lacto	nr	Fac. Neisseria
Throat	lacto	lacto Neisseria	nr	G. albicans	C. albicans	Neisseria C. albicans	nr	Neisseria	G. albicans	Neisseria	nr	nr	Coryn. Pat B out.	Coryn. S Misc. Neisseria	nr	Neisseria
Axilla	staph	Coryn. B staph	Coryn. B staph	staph	Coryn. S staph	staph	staph	staph	staph	Coryn. B staph	Coryn. B staph	staph	nr	Coryn. S Coryn. S+ Coryn. S	nr	Coryn. S Coryn. B
Forearm	ns	staph	ns	ns	ns	ns	ns	ns	staph	ns	ns	ns	ns	ns	ns	staph
Umbilicus	ns	Coryn. S+ staph	ns	ns	ns	ns	ns	ns.	staph	ns	ns	ns	ns	ns	ns	staph
Ureoin	Coryn. S+ staph	Coryn. S+ staph	Coryn. S+ staph	staph	Coryn. S+ staph	staph	Coryn. S+ staph	Coryn. S+ staph	Coryn. S+ staph	staph	staph	Coryn. S+ staph	nr	Coryn. S+ Coryn. S+ Act. albus	nr	Coryn. S+ Act. albus
Glans penis	Coryn. S+ staph	Coryn. S+ staph	Coryn. S+ staph	nr	Coryn. S+ staph	Act. albus staph	Coryn. S+ staph	Coryn. S+ staph	Coryn. S+ staph	ens. staph	Coryn. S+ staph	nr	nr	nr	ens.	Coryn. S+
Anal fold	ns	E. coli Misc.	ns	ns	ns	ns	ns	ns	Coryn. S+ staph	ns	ns	ns	ns	ns	ns	E. coli staph Coryn. S+ ens.
Feces**	E. coli Coryn. S	E. coli, Poly B 0124:187 0126:186 lacto	E. coli 0124:187 0126:186	E. coli Poly B 0126:186	E. coli, Poly A 0127:186 026:186 Poly B 086:87 0124:187 0126:186	E. coli, Poly A 0127:186 026:186 Poly B 086:87 0124:187 0126:186	E. coli Poly B 0124:187 0126:186	E. coli Poly B 0124:187 0126:186	Aerobacter C. albicans staph	Aerobacter E. coli	E. coli Poly B 0124:187 0126:186	E. coli Poly B 0124:187 0126:186 Aerobacter	Aerobacter E. coli lacto	Aerobacter	ns	ns
Toes	ns	T. menta. staph	ns	ns	ns	ns	ns	nr	nr	ns	ns	ns	ns	ns	ns	T. menta. staph

**Pattern E-C = S. faecalis-coli
*nr = lowest division of feces plated
***Misc: large gram positive cococcus resembling sarcina microscopically but with a very shiny, grey, stringy colonial morphology.

TABLE 36 --- Continued

Subject 32

Body Area	Sampling Period															
	1	2	3	4	5	6	7	8	9	10	11	12	13	14	15	16
Scalp	ns	Coryn.sp. staph	ns	ns	ns	ns	ns	ns	staph Coryn.Pat A	ns	ns	ns	ns	ns	ns	staph
Nose	Coryn. S+ Cand.sp. Staph	Cand. sp. staph	Cand. sp. Staph	Cand. sp. staph	Cand. sp. staph	Cand. sp. staph	staph	staph	staph	staph	staph	nr	nr	nr	nr	nr
Eye	ns	nr	ns	ns	ns	ns	ns	ns	staph	ns	ns	ns	ns	ns	ns	staph
Mouth	Coryn. S+ Fec. sp. Staph	Coryn. S+ Cand.sp. Staph,ens.	ns	staph	Coryn. P staph	staph	ns	Coryn. P staph	staph	staph	staph	staph	Coryn. P Coryn. P	Coryn. S+ Coryn. P	Coryn. P	nr
Throat	Bac.	nr	ns	nr	staph	Neisseria	lacto	nr	Neisseria	N. sicca	nr	nr	N. sicca	lacto Neisseria	nr	Bac. Neisseria
Axilla	Lacto	nr	Act.albus	staph	Act.albus	staph	staph	Neisseria	N. sicca staph	nr	Neisseria	N. Flava	N. sicca	nr	N. sicca N. Flava	Neisseria
Forearm	staph	staph	staph	staph	Gaffkya staph	staph	staph	staph	staph	Gaffkya staph	Coryn. S staph	Gaffkya staph	Coryn. S	Coryn. S	nr	Coryn. S
Umbilicus	ns	nr	ns	ns	ns	ns	ns	ns	staph	ns	ns	ns	ns	ns	ns	staph
Groin	Gaffkya staph	Coryn.PatB staph,ens.	Coryn. S+ staph	ens. staph	Coryn. S+ staph	Coryn. S+ staph	staph	staph	staph	Gaffkya staph	Coryn. S staph	Gaffkya staph	Bac.	nr	nr	nr
Glands penis	Gaffkya staph	Gaffkya staph,ens.	ens. staph	Coryn. S+ Gaffkya staph	staph	Coryn. S Coryn.sp. staph	staph	ens. Gaffkya staph	staph	Gaffkya staph	Coryn. S staph	Gaffkya staph	Coryn.sp. staph	nr	nr	nr
Anal Fold	ns	Coryn.PatB staph	ns	ns	ns	ns	ns	ns	staph	ns	ns	ns	ns	ns	ns	staph Coryn.Pat B
Feces**	E. coli Coryn. S Coryn.sp. PF10,lacto	E. coli PF10	E. coli Pat. S-C	E. coli Pat. S-C Coryn. P ens.	E. coli Pat. S-C Coryn. P ens.	E. coli Pat. S-C Lacto	E. coli Pat. S-C staph	E. coli Pat. S-C PF10	E. coli Pat. S-C PF10	E. coli Pat. S-C PF10	E. coli Pat. S-C PF10	E. coli Pat. S-C OLE:R15	E. coli Pat. S-C Poly B	E. coli Pat. S-C	ns	ns
Toes	ns	E. coli Coryn.sp. staph	ns	ns	ns	ns	ns	ns	staph	ns	ns	ns	ns	ns	ns	Coryn.sp. staph Coryn. S+

** 10-6 lowest dilution of feces plated

TABLE 36 --- Continued

Subject 33

Body Area	Sampling Period											
	1	2	3	4	5	6	7	8	9	10	11	12
Scalp	ns	staph	ns	ns	ns	ns	ns	ns	staph	ns	ns	Coryn. S Coryn. Pat. A staph
Ear	ns	staph	ns	ns	ns	ns	ns	ns	staph	ns	ns	Coryn. P Coryn. Pat. A staph
Eye	ns	Coryn. Pat. A staph	ns	ns	ns	ns	ns	ns	staph	ns	ns	staph
Nose	Coryn. P staph	ns. (R) staph	Coryn. S staph	ns	Coryn. P staph	Coryn. Pat. A staph	Coryn. P staph	Coryn. P staph	staph	Coryn. S staph	Coryn. Pat. A staph	Coryn. P staph
Oingival	Coryn. X	nr	Coryn. Pat. A staph	nr	Coryn. Pat. A staph	mitis, saliv	nr	nr	Sarcina saliv, mitis	nr	Sarcina saliv	Geiffya mitis
Throat	Coryn. P	Neisseria	saliv, mitis	nr	saliv, mitis staph	nr	Coryn. S saliv mitis, ens(R)	saliv mitis staph	Geiffya saliv mitis	saliv mitis staph, oat.	Geiffya, oat. H. sicca, saliv mitis, staph	Geiffya saliv staph
Acilla	Coryn. Pat. A staph	staph	staph	Coryn. Pat. A staph	Coryn. Pat. B staph	Coryn. Pat. A staph	Coryn. Pat. A staph	staph	Sarcina staph	staph	staph	staph
Forearm	ns	Coryn. P staph	ns	ns	ns	ns	ns	ns	Coryn. X staph	ns	ns	staph
Umbilicus	ns	Coryn. Pat. A staph	ns	ns	ns	ns	ns	ns	Coryn. Pat. A staph	ns	ns	Coryn. S Pat. A & B staph
Breast	Coryn. S staph	Coryn. X staph	Coryn. S & X staph	Coryn. Pat. A Pat. B & A1	Coryn. Pat. A1 staph	Coryn. S Pat. A, staph	Coryn. S staph	staph	staph, Coryn. S Pat. A & B	Coryn. S Pat. A, staph	Coryn. S Pat. B, staph	Coryn. Pat. A
Glans penis	Coryn. Pat. A staph	Coryn. P staph	Coryn. Pat. A staph	Coryn. Pat. A staph	Coryn. Pat. A staph	Coryn. S Pat. A, staph	Coryn. P Pat. B, staph	Coryn. S staph	Coryn. S staph	Coryn. X Pat. A, staph	Coryn. P Pat. A, staph	Coryn. S & Pat. B
Anal fold	Coryn. S Pat. B1 staph	Coryn. S & X staph	Coryn. S staph	Coryn. Pat. A Pat. A1 & B	Coryn. Pat. A Pat. B3 staph	Coryn. Pat. A Pat. B1 & B3 staph	Coryn. Pat. A staph	Coryn. S, P & X staph	staph	Coryn. Pat. A staph	Coryn. Pat. B staph	Coryn. S & Pat. B
Face	E. coli, Poly A & B, NFT Aerobacter entero, E. coli	E. coli entero mitis	E. coli Poly A, NFT entero	E. coli Poly A, NFT	E. coli Poly A, NFT entero	E. coli Poly A, NFT entero	E. coli Poly A, NFT entero, saliv	E. coli Poly A, NFT entero	E. coli Poly A, NFT entero, mitis	E. coli	E. coli Poly A, NFT entero	E. coli Poly A, NFT saliv, entero
Toes	staph	staph	nr	staph	nr	Coryn. Pat. A staph	Coryn. P staph	Coryn. Pat. A staph	Coryn. S staph	Coryn. S staph	Coryn. Pat. A staph	Coryn. Pat. A staph

(R) - This pattern seems to be biochemically related to C. amylicum; although the action on nitrate is absent

TABLE 36 --- Continued

Subject 34

Body Area	Swabbing Period												
	1	2	3	4	5	6	7	8	9	10	11	12	
Body Area													
Scalp	ns	Coryn. Pat. A staph	ns	ns	ns	ns	ns	ns	staph	ns	ns	staph	
Ear	ns	nr	ns	ns	ns	ns	ns	ns	Coryn. Pat. A staph	ns	ns	Coryn. Pat. A nr	
Eye	ns	staph	ns	ns	ns	ns	ns	ns	staph	ns	ns	nr	
Nose	Coryn. P staph	Coryn. Pat. A staph	Coryn. P Pat. A, staph	Coryn. Pat. A staph	Coryn. P staph	Coryn. P staph	Coryn. S & P staph	Coryn. P staph	Coryn. Pat. A staph	Coryn. Pat. A staph	staph	staph	
Gingival	mitis	nr	Neisseria saliv	Bac., mitis saliv	Sarcina mitis, staph	Coryn. Pat. A2 mitis, staph	Bac. mitis, staph	Bac. mitis	Neisseria saliv, mitis	Coryn. Pat. A saliv, mitis	mitis saliv entero	Coryn. sp. Coryn. Pat. B mitis	
Throat	Neisseria saliv mitis	saliv	Coryn. Pat. A saliv	saliv	Sarcina saliv	saliv	saliv	Bac., mitis Neisseria saliv	Gaffery saliv, mitis, staph	saliv	Gaffery staph	Bac. saliv mitis	
Axilla	Coryn. Pat. A staph	Coryn. S staph	Coryn. Pat. A staph	Coryn. S staph	Coryn. sp. Coryn. Pat. A1 Pat. A, staph	Bac. staph	staph	Coryn. Pat. B2 staph	Coryn. S staph	Coryn. Pat. A staph	Coryn. S staph	Coryn. Pat. A Coryn. S staph	
Forearm	ns	staph	ns	ns	ns	ns	ns	ns	staph	ns	ns	Coryn. S, Coryn. Pat. B, staph	
Umbilicus	ns	Coryn. Pat. A1 staph	ns	ns	ns	ns	ns	ns	staph	ns	ns	Coryn. P staph	
Ureth	Coryn. sp. Pat. A & B staph	Coryn. S Coryn. Pat. B staph	Coryn. Pat. A staph	Coryn. S Coryn. Pat. A1 staph	Coryn. S Coryn. Pat. B1 staph	Coryn. S staph	Coryn. P staph	Coryn. S Coryn. Pat. B1 staph	staph	Coryn. Pat. A Pat. B staph	nr	Coryn. Pat. A Pat. B & B1 staph	
Gland penis	Coryn. X staph	Coryn. Pat. A staph	Coryn. X Pat. A	Coryn. S staph	Coryn. S Pat. A1, staph	Coryn. Pat. A Pat. B2, staph	Coryn. S staph	Coryn. Pat. A Pat. B1, staph	Coryn. Pat. B1 staph	Coryn. P staph	staph	Coryn. Pat. A Coryn. P & Pat. B staph	
Anal fold	Coryn. S staph	Coryn. S staph	Coryn. S Coryn. Pat. A staph	Coryn. S Coryn. Pat. A staph	staph	Coryn. S Coryn. Pat. A staph	Coryn. S staph	Coryn. S Pat. A staph	Coryn. S Pat. A1 staph	staph	staph	Coryn. S staph	
Feces	E. coli entero	E. coli Aerobacter entero saliv	E. coli entero saliv	E. coli Aerobacter saliv	E. coli Poly B O128:B16 saliv mitis	E. coli Poly B O128:B16 saliv entero	E. coli saliv entero	E. coli saliv entero	E. coli saliv entero	E. coli Aerobacter saliv entero	E. coli Poly B, NPT saliv	E. coli Poly B, NPT saliv	E. coli Poly B, NPT entero saliv
Toes	staph	staph	nr	Coryn. X staph	nr	Coryn. Pat. A staph	Coryn. Pat. A staph	Coryn. Pat. A staph	staph	staph	Sarcina staph	Coryn. Pat. B staph	

TABLE 36 --- Continued

Subject 35

Body Area	Sampling Period											
	1	2	3	4	5	6	7	8	9	10	11	12
Scalp	nr	staph	ns	ns	ns	ns	ns	ns	staph	ns	ns	staph
Ear	ns	staph	ns	ns	ns	ns	ns	ns	staph	ns	ns	nr
Eye	ns	staph	ns	ns	ns	ns	ns	ns	staph	ns	ns	staph
Nose	Coryn. Pat. A staph	Coryn. Pat. A staph	Coryn. Pat. A staph	Coryn. Pat. A staph	Coryn. Pat. A staph	Coryn. Pat. A staph	entero staph	Coryn. P staph	staph	staph	staph	entero staph
Oral cavity	mitis	Neisseria sally	nr	mitis	Coryn. Pat. A mitis	mitis sally	Gaffky sally, staph	nr	mitis	mitis sally	Coryn. Pat. B mitis	Gaffky, mitis entero, staph
Throat	sally mitis	sally mitis	mitis	Sarcina mitis sally	mitis entero	Neisseria sally mitis entero	sally	Gaffky sally mitis	Coryn. Pat. A sally, cat. sally, cat. mitis, entero staph	cat. sally mitis	sally mitis	Gaffky N. staph sally, mitis staph
Axilla	staph	staph	Coryn. Pat. A staph	Coryn. S staph	nr	staph	staph	Coryn. S Pat. B1	staph	staph	Coryn. Pat. B1 Pat. A, staph	Coryn. S Pat. A, staph
Forearm	ns	staph	ns	ns	ns	ns	ns	ns	staph	ns	ns	staph
Umbilicus	ns	Coryn. Pat. A staph	ns	ns	ns	ns	ns	ns	Coryn. Pat. A staph	ns	ns	staph
Groin	Coryn. Pat. B1 staph	Coryn. Pat. B1 staph	Coryn. X staph	staph	Coryn. Pat. B1 staph	Coryn. S staph	Coryn. S Pat. B1, staph	Coryn. S staph	Coryn. Pat. B1 staph	Coryn. Pat. A staph	Coryn. S staph	Coryn. S Pat. A, staph
Glans penis	Coryn. X staph	Coryn. Pat. A Pat. B2, staph	staph	staph	Coryn. Pat. A staph	Coryn. Pat. A staph	Coryn. S staph	Coryn. Pat. B3 staph	Coryn. X staph	staph	staph	Coryn. P staph
Anal fold	Coryn. S & Pat. A	Coryn. S staph	Coryn. X Pat. B1, staph	Coryn. S Pat. A1 & B1 staph	Coryn. S Pat. A1, staph	Coryn. S Pat. A1, staph	Coryn. S staph	Coryn. S Pat. A1, staph	staph	Coryn. S Pat. A, staph	Coryn. Pat. B staph	Coryn. Pat. A staph
Pecus	E. coli Poly A, MFT entero	E. coli entero mitis	E. coli Poly A, MFT entero	Aerobacter entero sally	E. coli Poly B O126:H16 mitis entero	E. coli entero	E. coli entero	Aerobacter entero	ns	E. coli Coryn. S staph	E. coli Poly A, MFT entero sally	E. coli Coryn. S entero
Toes	Coryn. Pat. B2 staph	Coryn. Pat. A staph	Coryn. Pat. A staph	Coryn. S Pat. A, staph	Coryn. P staph	staph	Coryn. S staph	staph	staph	Coryn. Pat. B1 staph	staph	staph

* Reacts biochemically like A. In that it showed no action on carbohydrates and nitrates, but showed proteolytic activity on litmus milk and Loeffler's blood serum although it failed to liquify gelatin at the end of seven days.

TABLE 36 --- Continued

Subject 36

Body Area	Sampling Period											
	1	2	3	4	5	6	7	8	9	10	11	12
Scalp	ns	Coryn. Pat. A staph	ns	ns	ns	ns	ns	ns	staph	ns	ns	staph
Ear	ns	Coryn. Pat. A staph	ns	ns	ns	ns	ns	ns	staph	ns	ns	staph
Eye	ns	nr	ns	ns	ns	ns	ns	ns	Coryn. Pat. A	ns	ns	Coryn. Pat. A
Nose	Coryn. Pat. A staph	Coryn. P staph	Coryn. P & X staph	Coryn. P	Coryn. P staph	staph	staph	Coryn. P staph	Coryn. P Pat. B, staph	Coryn. P staph	Coryn. ? staph	staph
Gingival	Neisseria mitis sally	nr	ens.(R),mitis entero sally	entero staph	mitis sally	mitis sally	mitis	nr	sally mitis	mitis	mitis	Gaffky mitis sally
Throat	Neisseria	mitis	Neisseria entero mitis	Gaffky Neisseria entero,sally	Coryn. Pat. B, Pat. B,sally	Neisseria mitis sally	Gaffky cat., mitis	sally mitis staph	sally staph	cat. mitis	staph	Gaffky cat., mitis
Axilla	nr	Coryn. Pat. A staph	staph	nr	staph	Coryn. Pat. A staph	nr	staph	staph	Coryn. Pat. A staph	Coryn. Pat. A staph	staph
Forearm	ns	staph	ns	ns	ns	ns	ns	ns	Coryn. Pat. A staph	ns	ns	staph
Umbilicus	ns	staph	ns	ns	ns	ns	ns	ns	Coryn. Pat. A, staph	ns	ns	Coryn. Pat. A staph
Breast	Coryn. S staph	Coryn. X Pat. A, staph	Coryn. Pat. A staph	staph	Coryn. Pat. A staph	staph	ens. (?) staph	Coryn. S staph	Coryn. X Pat. A, staph	Coryn. S Pat. A	Coryn. S staph	Coryn. S staph
Glans penis	nr	nr	nr	Coryn. S staph	Coryn. S & X staph	Coryn. S Pat. B, staph	Coryn. ens.(R),staph	Coryn. S staph	Coryn. S Pat. A, staph	Coryn. S staph	Coryn. Pat. A staph	Coryn. S staph
Anal fold	Coryn. S staph	Coryn. S staph	Coryn. S staph	Coryn. S	Coryn. S staph	Sarcina Coryn. S Pat. A, staph	Coryn. S Pat. A, staph	Coryn. S staph	Coryn. S Pat. A staph	Coryn. X staph	staph	Coryn. P staph
Feces	E. coli entero sally	E. coli Aerobacter entero sally	E. coli Poly A O157E sally entero	E. coli Poly A&B,NFT Aerobacter entero,sally	E. coli Poly A&B,NFT Proteus sp. mitis entero	Proteus sp. Aerobacter entero sally staph	E. coli entero mitis sally staph	Alcaligenes Aerobacter Proteus sp. entero mitis staph	Aerobacter Alcaligenes Proteus sp. E. coli Poly A, NFT entero,sally	B. coli Proteus a, sally entero staph	Proteus sp. entero mitis sally staph	Alcaligenes Aerobacter entero sally
Toes	nr	staph	staph	nr	staph	Coryn. S Pat. A, staph	staph	staph	Coryn. S Pat. A, staph	Coryn. S staph	Coryn. S Pat. A, staph	Coryn. S Pat. B, staph

TABLE 36 --- Concluded

KEY

Act	actinomycetes	NR	=	no recovery
Alk. dispar	<u>Alkalescens dispar</u>	NS	=	no sample
Asp.	<u>Aspergillus</u>	P	=	<u>C. pseudodiphtheriticum</u>
Bac.	Bacillus	par.	=	<u>Candida parapsilopsis</u>
bovis	<u>Streptococcus bovis</u>	pat	=	pattern
cand.	candida	Pen	=	Penicillium
cat.	<u>N. catarrhalis</u>	PPLO	=	pleuropneumonia-like organisms
coryne	Corynebacterium	proact	=	proactinomyces
durans	<u>Streptococcus durans</u>	Rhodo	=	Rhodotorula
entero	enterococcus	S	=	<u>C. striatum</u>
enz	<u>Corynebacterium enzymicum</u>	sal +	=	saline positive
faecalis	<u>Streptococcus faecalis</u>	saliv	=	<u>Streptococcus salivarius</u>
G + R	gram positive rod	Scop.	=	Scopulariopsis
Helminth.	Helminthosporium	Synceph	=	Syncephalostrum
lactis	<u>Streptococcus lactis</u>	sicea	=	<u>N. sicea</u>
lacto	<u>Lactobacillus</u>	sp	=	species
mic	micrococcus	spp	=	species (plural)
mitis	<u>Streptococcus mitis</u>	staph	=	staphylococcus
mycobact	mycobacterium	Trich	=	Trichosporum
mycoc	mycococcus	T. menta	=	<u>Trycophyton mentagrophytes</u>
N	Neisseria	T. rubrum	=	<u>Trycophyton rubrum</u>
NFT	no further type	X	=	<u>C. xerosis</u>

TABLE 37. PHYSIOLOGICAL CHARACTERISTICS OF THE PREDOMINATING FECAL ANAEROBES***

Type Culture	Morphology	Agar Shake	pH Broth*	Deamination % Substrate Converted to NH ₃	Decarboxylation				% Lactic Acid/Wt. Glucose	Gas From Glucose	Vitamins				
					Lysine	Histidine	Tyrosine	Arginine			B ₁₂	B ₂	Niacin	P.A.	Folic Acid
FA-10	very small gram positive rods in chains, bipolar, slightly pointed	very anaerobic	6.7 4.90	12	+	+	+	+	20	CO ₂	+	0	-	+	+
FA-11	short medium gram positive rods	very anaerobic	6.5 4.5	2	X	0	0	0	37		X	X	X	X	X
FA-12	tiny pointed gram positive rods, chains, coccoid	very anaerobic with slight gas	7.2 4.65	28	+	+	+	+	19		+	0	-	+	+
FA-13	small gram negative cocci in masses	very anaerobic heavy gas	6.7 8.1	2	(+)	(+)	(+)	(+)	used		+	+	0	-	+
**FA-14	gram negative rods long slender with gram positive areas	very anaerobic heavy gas	6.7 5.3	2	+	+	+	+	9	CO ₂ H ₂	+	+	-	-	0
FA-15	short fat gram negative rod, pointed ends	very anaerobic heavy gas	6.7 4.65	9	0	0	0	+	21		+	0	0	0	+
FA-16	gram positive pleomorphic rods, tadpole	anaerobic collar	6.8 4.62	2	0	0	0	+	40		0	0	0	0	0

* Top number pH = 1/10% glucose heavily buffered

Bottom = 5/10% glucose not buffered

** Fixes nitrogen

*** Results obtained under NASA contract NASw-738, "Study of the Normal Fecal Bacterial Flora of Man".

X = Test not done
() = Questionable results due to gas formation by culture

TABLE 37 --- Concluded

Type Culture	Morphology	Agar Shake	pH Broth*	Deamination % Substrate converted to NH ₃	Decarboxylation***				% Lactic Acid/Wt. Glucose	Gas From Glucose	Vitamins***			
					Lysine	Histidine	Tyrosine	Arginine			B ₁₂	B ₂	Niacin	P.A.
FA-1	slender gram positive rod	very anaerobic	7.0 4.6	13	0	+	+	+			+	0	+	+
FA-2	Slender gram positive rod, tadpole	very anaerobic	6.4 4.5	<2	0	0	0	+			+	0	+	+
FA-3**	gram negative elongated pointed rods in pairs	very anaerobic heavy gas	7.5 6.1	6	+	+	+	+	CO ₂		+	0	0	0
FA-4	slender gram positive rod	very anaerobic	5.6 4.65	<2	0	0	0	0			X	X	X	X
FA-5	short medium gram positive rod, clusters	very anaerobic	5.5 4.55	2	0	0	0	0			+	+	-	+
FA-6	gram positive medium rods, clusters	very anaerobic	6.6 4.45	<2	0	0	0	0			+	0	0	+
FA-7	small gram negative slender rod, bipolar	very anaerobic	6.6 4.85	12	0	+	+	+			+	0	-	+
FA-8	tiny gram negative slender rod, slightly curved	very anaerobic	6.9 8.0	23	0	+	+	0			+	0	0	+
FA-9	pleomorphic gram positive rod, hooked, chains	very anaerobic	7.0 4.85	16	+	+	+	+			+	-	-	+

* Top number pH = 1/10% glucose heavily buffered
Bottom = 5/10% glucose not buffered

** Produces indol

X Test not done

*** + = activity or production

- = utilization

0 = no reaction

TABLE 38. LIPASE PRODUCTION BY ANAEROBIC TYPE CULTURES*

Type Culture	Spirit Blue Agar Shake	Type Culture	Spirit Blue Agar Shake
FA-1	-	FA-10	-
FA-2	+	FA-11	+
FA-3	-	FA-12	-
FA-4	+	FA-13	-
FA-5	+	FA-14	-
FA-6	-	FA-15	+
FA-7	-	FA-16	+
FA-8	-	Control (lipase enzyme)	+
FA-9	-	Uninoculated Control	-

Blue color = positive

* Results obtained under NASA contract NASw-738, "Study of the Normal Fecal Bacterial Flora of Man".

TABLE 39. B VITAMIN PRODUCTION OR USE BY THE TYPE CULTURES *

Type Culture	Vitamin B-12 m μ /cc	Riboflavin μ /cc	Niacin μ /cc	Pantothenic Acid μ /cc	Folic Acid m μ /cc
FA-1	0.288	0.096	3.1	0.37	35.0
FA-2	0.237	0.078	3.6	0.37	14.5
FA-3	0.125	0.099	3.0	0.0463	10.0
FA-5	0.262	0.102	3.2	0.0814	15.5
FA-6	0.262	0.093	3.35	0.243	16.5
FA-7	0.262	0.093	2.65	0.393	25.0
FA-8	0.225	0.087	3.60	0.532	14.5
FA-9	0.362	0.078	2.45	0.208	15.5
FA-10	0.400	0.084	2.74	0.301	25.0
FA-12	0.325	0.090	2.65	0.359	17.0
FA-13	0.300	0.111	3.10	0.0116	35.0
FA-14	0.200	0.114	2.50	0.0231	11.0
FA-15	0.255	0.096	3.40	0.301	10.0
FA-16	0.0953	0.093	3.6	0.254	10.5
Control	0.084	0.084	3.6	0.254	10.0

*Results obtained under NASA contract NASw-738, "Study of the Normal Fecal Bacterial Flora of Man".

**TABLE 40. OPTIMAL TEMPERATURE AND pH RANGE
FOR GROWTH OF EIGHTEEN ANAEROBIC TYPE CULTURES****

Anaerobic Type	5.0	6.6	7.5	R. T.	37.5°C	45°C
FA-1	-	+	-	-	+	-
FA-2	-	+	-	-	+	-
FA-3	-	+	-	-	+	-
FA-4	-	+	-	-	+	-
FA-5	-	+	-	-	+	-
FA-6	-	+	-	-	+	-
FA-7	-	+	-	-	+	-
FA-8	-	+	-	-	+	-
FA-9	-	+	-	-	+	-
FA-10	-	+	-	-	+	-
FA-11	-	+	-	-	+	-
FA-12	-	+	-	-	+	-
FA-13	-	+	-	-	+	-
FA-14	-	+	-	+ sl no gas	+ hy gas	+ hy no gas*
FA-15	-	+	-	-	+	-
FA-16	-	+	-	-	+	-

R. T. = room temperature

sl = slight

+ = growth

hy = heavy

- = no growth

*FA-14 failed to grow at 50-52°C

**Results obtained under NASA contract NASw-738,
"Study of the Normal Fecal Bacterial Flora of Man".

TABLE 4L. PHYSIOLOGICAL CHARACTERISTICS OF TYPE CULTURES*

	Type Culture	% Lactic Acid/ Wt. Glucose	% Substrate Converted to NH ₃	Decarboxylation			
				Lysine	Histidine	Tyrosine	Arginine
Lactic Acid Forming Predominating Fecal Anaerobes	FA-2	26	2	0	0	0	+
	FA-4	39	2	0	0	0	0
	FA-5	40	2	0	0	0	0
	FA-11	37	2	X	0	0	0
	FA-16	40	2	0	0	0	+
Deaminating and Decarboxylating Predominating Fecal Anaerobes	FA-1	5	13	0	+	+	+
	FA-9	26	16	+	+	+	+
	FA-10	20	12	+	+	+	+
	FA-12	19	28	+	+	+	+
	FA-7	28	12	0	+	+	+
FA-8	28	23	0	+	+	0	
Miscellaneous Predominating Fecal Anaerobes	FA-3	9	6	+	+	+	+
	FA-6	9	2	0	0	0	0
	FA-13	Used	2	(+)	(+)	(+)	(+)
	FA-14	9	2	+	+	+	+
	FA-15	21	9	0	0	0	+

() = Questionable results due to gas formation by culture

X = Test not done

* = Results obtained under NASA contract NASw-738, "Study of the Normal Fecal Bacterial Flora of Man."

TABLE 42. COLONY COUNTS - AEROBIC DILUTION POUR PLATES FROM FECES

Subject Number	Sampling Period													
	1	2	3	4	5	6	7	8	9	10	11	12	13	14
17	4	20	18	3	32	45	8	42	20	10	8			
18	>250	150	155	10	120	29	21	83	8	45				
19	190	140	3	54	110	128	18	32	4	6	3			
20	200	180	150	200	500	3	48	89	70	120				

These numbers are equivalent to 10^{-6} bacteria per gram of feces

TABLE 42 ---- Continued

Subject Number	Sampling Period													
	1	2	3	4	5	6	7	8	9	10	11	12	13	14
21	150	103	NG	TNTC	2	3	3	1	1	3	3	1	1	7
	150	100	NG	TNTC	18	2	5	3	1	0	8	7	2	14
22	0	2	103	25	10	12	1	1	20	180	14	45	11	8
	1	3	400	24	35	26	44	10	13	157	13	52	21	35
23	2	2	NG	3	5	34	4	1	9	8	1	0	3	1
	2	0	NG	3	8	16	3	4	28	5	2	2	4	3
24	115	3	3	8		8	5	NS	156	25	14	NS	4	230
	300	4	20	17	2	5	26	NS	206	27	24	NS	1	>850

NG = No growth

NS = No sample

These numbers are equivalent to 10^{-6} bacteria per gram of feces

TABLE 42 --- Continued

Subject Number	Sampling Period													
	1	2	3	4	5	6	7	8	9	10	11	12	13	14
25	2	0	1	2	1	2	1	41	2	4	17	7	6	7
	3	1	1	0	1	1		23	4	4	13	2	4	4
26	2	1	5	1	3	1	1	1	1	1	0	1	2	5
	1	2	4	1	2	2	0	5	4	1	1	1	4	0
27	3	156	360	432	270	520	1600	70	308	140	152	306	71	166
	2	80	550	600	206	360	1120	97	320	175	129	228	56	130
28	1	1	1	50	54	26	11	70	45	2	2	4	15	4
	1	2	1	66	230	33	11	40	54	4	41	9	16	10

These numbers are equivalent to 10^{-6} bacteria per gram of feces

TABLE 42 ---- Continued

Subject Number	Sampling Period													
	1	2	3	4	5	6	7	8	9	10	11	12	13	14
29	0 0	2 3	12 34	55 66	4 3	40 25	41 33	9 24	4 2	2 2	22 14	2 2	1 0	2 7
30	2 2	3 2	1 0	234 148	17 12	122 99	NS NS	168 225	9 20	2 5	22 31	14 7	40 25	3 6
31	4 1	4 9	20 37	185 213	192 241	800 720	99 132	26 44	18 22	7 16	124 230	3 4	7 11	14 4
32	7 8	0 3	23 27	117 132	14 11	102 77	111 103	24 24	18 3	71 93	14 187	29 37	1 7	1 1

NS = No sample
 These numbers are equivalent to 10^{-6} bacteria per gram of feces

TABLE 42 --- Concluded

Subject Number	Sampling Period												
	Extra	1	2	3	4	5	6	7	8	9	10	11	12
33	63	11	29	16	14	16	119	23	2	87	67	28	49
	78	5	22	12	17	10	115	22	6	160	26	20	33
34	270	342	300	7	960	43	79	80	14	80	36	22	140
	181	374	360	10	576	28	52	56	22	64	32	18	104
35	40	73	75	5	684	20	22	13	29	NS	7	49	26
	81	75	81	2	151	11	23	16	16	NS	4	48	18
36	219	310	545	63	692	103	191	110	276	344	288	218	91
	360	286	800	48	980	90	213	191	294	288	242	250	71

These numbers are equivalent to 10^{-6} bacteria per gram of feces

TABLE 43. GROWTH HEIGHT BY TUBE NUMBER

ANAEROBIC FECES
EXPERIMENT V

		Sampling Period													
		1	2	3	4	5	6	7	8	9	10	11	12	13	14
<u>Subject Number</u>															
17	8	10	10	10	10	8	10	8	8	10	7	8			
18	8	8	10	10	10	10	9	10	8	10	10				
19	8	10	10	10	10	7	9	8	8	10	7	8			
20	8	7	10	10	10	10	8	10	10	10	10				

ANAEROBIC THROAT

		Sampling Period													
		1	2	3	4	5	6	7	8	9	10	11	12	13	14
<u>Subject Number</u>															
17	7	6	6	6	5	6	5	5	6	7	5	6	7	6	
18	6	5	4	5	5	6	6	6	5	6	5	4	7	4	
19	7	6	6	6	4	3	4	5	6	7	5	5	7	5	
20	7	5	5	5	5	6	5	6	6	6	6	6	7	5	

4 = 10^{-7} ; 5 = 10^{-8} , etc.

TABLE 43 --- Continued
 EXPERIMENT VI
 ANAEROBIC FECES

Subject Number	Sampling Period													
	1	2	3	4	5	6	7	8	9	10	11	12	13	14
21	9	10	9	9	10	9	9	9	7	9	9	9	8	9
22	9	10	10	10	10	8	8	10	10	10	8	9	9	10
23	10	10	9	10	10	10	9	10	10	9	9	8	10	9
24	10	10	9	10	9	10	9	N.S.	9	9	9	N.S.	9	10

ANAEROBIC THROAT

Subject Number	Sampling Period															
	1	2	3	4	5	6	7	8	9	10	11	12	13	14	15	16
21	5	6	6	7	5	7	6	5	5	6	6	7	6	7	5	6
22	6	7	6	7	6	5	7	6	6	6	6	6	7	7	6	6
23	6	6	6	7	6	5	6	6	6	6	7	6	7	6	5	6
24	6	6	6	5	7	6	6	7	N.S.	6	6	6	6	6	6	5

N. S. = no sample
 4 = 10^{-7} ; 5 = 10^{-8} , etc.

TABLE 43 --- Continued
EXPERIMENT VII
 ANAEROBIC FECES

Subject Number	Sampling Period													
	1	2	3	4	5	6	7	8	9	10	11	12	13	14
25	10	9	10	7	8	7	10	8	10	9	8	8	7	7
26	8	9	8	8	10	8	8	9	10	8	10	9	8	9
27	8	9	8	8	8	9	10	9	10	8	9	10	9	8
28	8	9	8	8	9	8	10	8	10	7	8	8	7	8

ANAEROBIC THROAT

Subject Number	Sampling Period															
	1	2	3	4	5	6	7	8	9	10	11	12	13	14	15	16
25	7	7	6	7	7	7	6	5	6	5	7	5	7	4	4	4
26	7	7	5	7	7	7	4	4	6	5	7	5	7	4	6	7
27	6	7	7	7	7	7	5	7	7	6	7	5	5	6	6	3
28	7	7	6	7	6	7	6	7	7	5	6	4	5	4	6	5

4 = 10^{-7} ; 5 = 10^{-8} , etc.

TABLE 43 --- Continued

EXPERIMENT VIII

ANAEROBIC FECES

Subject Number	Sampling Period													
	1	2	3	4	5	6	7	8	9	10	11	12	13	14
29	9	9	8	8	8	10	10	9	8	10	8	8	10	10
30	10	9	9	8	8	8	*	10	8	9	9	10	10	8
31	10	8	8	8	9	10	7	7	9	8	8	10	10	8
32	8	8	8	9	9	9	9	10	8	9	9	10	10	8

* Fecal spec. for sampling period (7) not given

ANAEROBIC THROAT

Subject Number	Sampling Period															
	1	2	3	4	5	6	7	8	9	10	11	12	13	14	15	16
29	5	5	5	5	5	5	5	5	5	5	5	5	5	6	6	5
30	5	5	5	4	5	5	5	5	5	6	5	5	4	6	6	4
31	6	6	5	4	7	5	6	5	5	6	6	6	5	5	7	5
32	4	4	6	4	5	5	5	6	4	5	5	4	4	5	5	5

4 = 10^{-7} ; 5 = 10^{-8} , etc.

TABLE 43 --- Concluded
ANAEROBIC FECES
EXPERIMENT IX

Subject Number	Sampling Period													
	E	1	2	3	4 90°	5 90°	6	7	8 90°	9 90°	10	11	12	
33	10	10	7	8	9	10	9	10	10	10	10	10	10	10
34	10	10	9	8	10	10	9	10	9	10	10	10	10	9
35	10	9	10	8	10	10	10	9	9	N.S.	10	10	10	9
36	10	10	19	8	9	10	10	8	9	10	9	10	10	10

ANAEROBIC THROAT

33	7	6	7	6	5	5	5	5	7	5	4	4	4
34	6	6	6	5	6	7	6	6	7	5	5	6	4
35	6	5	7	5	6	5	5	5	7	4	6	6	4
36	7	5	7	4	6	6	5	5	7	7	7	5	4

GINGIVAL

33	5	5	3	5	4	3	3	3	3	4	3	3	3
34	5	5	3	5	4	5	5	4	4	5	5	4	3
35	5	4	5	4	5	4	3	5	5	4	5	3	3
36	5	5	5	4	4	5	5	5	5	5	5	4	2

4 = 10⁻⁷; 5 = 10⁻⁸, etc.

TABLE 44. OCCURRENCE OF STRICT VS FACULTATIVE ANAEROBES IN FECES**EXPERIMENT V**

Sampling Period	Subject Number							
	17		18		19		20	
	A	F	A	F	A	F	A	F
1	3	0	2	0	3	0	1	2
2	4	0	2	3	3	0	0	1
3	1	3	5	1	5	1	2	1
4	2	1	2	0	2	0	2	3
5	1	0	2	0	1	1	1	0
6	1	1	4	0	1	1	3	0
7	5	0	1	1	4	0	5	0
8	1	2	2	1	3	0	3	0
9	3	1	3	0	2	1	3	2
10	3	0	3	1	4	0	2	1
11	4	0	0	0	2	0	0	0

A = Anaerobic
F = Facultative

TABLE 44 --- Continued

EXPERIMENT VI

Sampling Period	Subject Number							
	21		22		23		24	
	A	F	A	F	A	F	A	F
1	3	0	3	0	3	0	3	0
2	3	0	3	0	3	0	3	0
3	3	0	3	0	3	0	3	0
4	3	0	3	0	3	0	3	0
5	3	0	3	0	3	0	3	0
6	3	0	3	0	3	0	3	0
7	3	0	3	0	3	0	3	0
8	3	0	3	0	3	0	N. S.	N. S.
9	2	1	3	0	3	0	A. C.	A. C.
10	3	0	3	0	3	0	3	0
11	3	0	3	0	3	0	3	0
12	3	0	3	0	3	0	N. S.	N. S.
13	3	0	3	0	3	0	3	0
14	A. C.	A. C.	3	0	3	0	3	0

N. S. = no sample
 A. C. = aerobic contamination

TABLE 44 --- Continued

EXPERIMENT VII

Sampling Period	Subject Number							
	25		26		27		28	
	A	F	A	F	A	F	A	F
1	3	0	3	0	1	A. C.	2	1
2	2	1	2	1	3	0	2	1
3	3	0	3	0	1	2	2	1
4	A. C.	1	0	3	1	2	A. C.	1
5	1	2	3	0	1	2	1	2
6	1	2	3	0	3	0	2	1
7	3	0	3	0	2	1	3	0
8	3	0	3	0	1	2	A. C.	A. C.
9	3	0	3	0	2	1	2	A. C.
10	3	0	2	1	2	1	2	1
11	3	0	1	2	2	1	2	1
12	3	0	1	2	1	2	2	1
13	2	1	1	2	2	1	1	A. C.
14	2	1	3	0	2	1	2	1

A. C. = aerobic contamination

TABLE 44 --- Continued

EXPERIMENT VIII

Sampling Period	Subject Number							
	29		30		31		32	
	A	F	A	F	A	F	A	F
1	2	1	3	0	3	0	2	1
2	3	0	3	0	2	1	3	0
3	2	1	2	1	1	2	2	1
4	3	0	2	1	1	2	1	A. C.
5	3	0	2	1	2	1	3	0
6	2	1	2	1	2	1	1	2
7	0	3	N. S.	N. S.	1	2	2	1
8	1	2	3	0	2	1	2	1
9	2	1	1	2	2	1	1	A. C.
10	3	0	1	2	1	2	2	1
11	3	0	3	0	2	1	1	A. C.
12	3	0	A. C.	A. C.	2	1	3	0
13	3	0	2	1	1	2	2	1
14	2	1	1	2	1	2	3	0

A. C. = aerobic contamination

N. S. = no sample

TABLE 44 --- Concluded

EXPERIMENT IX

Sampling Period	Subject Number							
	33		34		35		36	
	A	F	A	F	A	F	A	F
1	2	1	3	0	3	0	3	0
2	3	0	3	0	A. C.	A. C.	2	1
3	2	A. C.	2	A. C.	2	1	2	1
4	3	0	2	A. C.	1	2	2	A. C.
5	1	2	1	A. C.	2	1	1	A. C.
6	2	A. C.	2	A. C.	2	1	2	A. C.
7	3	0	2	1	3	0	1	2
8	2	1	2	1	3	0	2	A. C.
9	1	2	3	0	N. S.	N. S.	2	1
10	2	1	2	1	A. C.	A. C.	2	1
11	3	0	3	0	2	A. C.	2	A. C.
12	2	1	3	0	3	0	1	A. C.

A. C. = aerobic contamination
 N. S. = no sample

TABLE 45. DISTRIBUTION OF FECAL ANAEROBES

Subject 17 - EXPERIMENT V

Anaerobes	Sampling Period										
	1	2	3	4	5	6	7	8	9	10	11
FA-1	2				2	1	1	1	2		
FA-2					1					1	2
FA-3	1	1	1	1	1	1	1	1	1		2
FA-4											
FA-5	1				1						
FA-6	1	2	1			1		1	3		1
FA-7		1									
FA-8	1						1	1	1		1
FA-9	1			1	1	1					1
FA-10	1										
FA-11											
FA-12								1		1	
FA-13											
FA-14											1
FA-15	2	2	1		2					1	
FA-16											
FA-17				1							
FA-18		1		1	1		1		1	1	1
GD-1											
GD-2											
GD-3	1										1
GD-4					1				1		1
GD-5											
GD-6	2				1				1		
GD-7			1							1	
Unkeyed					1						
TOTAL	13	7	4	4	12	4	4	5	10	5	11
FN-1											
FN-2	1				1						
FN-3	1										
FN-4	2					1					
FN-5	2										
Unkeyed	2										
Lactobacillus						1					
Enterococci	1										
Miscellaneous											
TOTAL	9	0	0	0	1	2	0	0	0	0	0

TABLE 45 --- Continued
Subject 18 - EXPERIMENT V

Anaerobes	Sampling Period										
	1	2	3	4	5	6	7	8	9	10	11
FA-1				1				1	1	2	
FA-2						2					
FA-3	1	1			1		1	1	1	2	
FA-4	1										
FA-5				1	1						
FA-6					1					1	
FA-7											
FA-8			1				1				
FA-9							1	1			
FA-10						1					
FA-11											
FA-12					1						
FA-13									1	2	
FA-14	1			1					1		
FA-15	1	1	2	1	3			2	2		
FA-16											
FA-17											
FA-18					2	1			1		
GD-1											
GD-2											
GD-3							1				
GD-4											
GD-5											
GD-6		1						1			
GD-7											
Unkeyed		1		1							
TOTAL	4	4	3	5	9	4	4	6	7	7	
FN-1							1				
FN-2										2	
FN-3											
FN-4					1			1		2	
FN-5	1						1		1		
Unkeyed											
Lactobacillus		1									
Enterococci								1			
Miscellaneous								1		1	
TOTAL	1	1	0	0	1	0	2	3	1	5	

Contrails

TABLE 45 --- Continued

Subject 19 - EXPERIMENT V

Anaerobes	Sampling Period										
	1	2	3	4	5	6	7	8	9	10	11
FA-1		1	1		1		3		1		
FA-2											1
FA-3	1	3	1			1		1		2	1
FA-4											
FA-5	1				1	1		1			
FA-6	1	1	2					1	1		2
FA-7											
FA-8	1					1	1				
FA-9	1				1		2				
FA-10	1							1			
FA-11										1	
FA-12											
FA-13											
FA-14						1		1		1	
FA-15	2		2		2	1	1			2	
FA-16											
FA-17				1							
FA-18	1	1	1		1	1	1		1	2	
GD-1											
GD-2											
GD-3											
GD-4				1	1	1			1	1	
GD-5											
GD-6	1										
GD-7			1							1	
Unkeyed				1							
TOTAL	10	6	8	2	8	7	8	5	4	10	5
FN-1											
FN-2	1			1							
FN-3	1										
FN-4	1		1								
FN-5	1										
Unkeyed	1										
Lactobacillus			1		1						
Enterococci	1										
Miscellaneous											
TOTAL	6	0	2	0	2	0	0	0	0	0	0

TABLE 45 --- Continued

Subject 20 - EXPERIMENT V

Anaerobes	Sampling Period										
	1	2	3	4	5	6	7	8	9	10	11
FA-1		2	1				2	3	1	2	
FA-2						1	1				
FA-3	1		1		2		1	1	2	1	
FA-4	1										
FA-5		2			1	1					
FA-6				1						1	
FA-7			1								
FA-8						1	1				
FA-9				3			1	1			
FA-10											
FA-11											
FA-12					1						
FA-13									1	1	
FA-14	1			1					1	1	
FA-15	1	2	1	1	1		2	3	1		
FA-16											
FA-17											
FA-18		2			1						
GD-1											
GD-2											
GD-3							1				
GD-4											
GD-5											
GD-6		3			2				1		
GD-7											
Unkeyed		2									
TOTAL	4	13	4	6	8	3	9	8	7	6	
FN-1							1				
FN-2										1	
FN-3											
FN-4									1		
FN-5	1								1		
Unkeyed Lactobacillus Enterococci Miscellaneous							1				
TOTAL	1	0	0	0	0	0	2	0	2	1	

TABLE 45 --- Continued
Subject 21 - EXPERIMENT VI

Anaerobes	Sampling Period													
	1	2	3	4	5*	6	7*	8	9	10	11	12	13	14
FA-1	1									1		1		
FA-2														
FA-3	2			1				1						
FA-4														
FA-5									1				1	
FA-6														
FA-7														
FA-8								2						
FA-9										1	3	1	2	2
FA-10														
FA-11				1										
FA-12														
FA-13														
FA-14	1	1		1				1			1	1	1	
FA-15	2	3	2	1							1	1	1	1 1
FA-16														
FA-17				1	1			1						
FA-18	1	1						1	1					
GD-1														
GD-2														
GD-3														
GD-4								1						
GD-5														
GD-6														
GD-7														
Unkeyed - Ob.	2			1				1	1	1				2
TOTAL	9	5	3	6	0	4	1	5	4	5	5	5	5	3
FN-1														
FN-2	1	1												
FN-3														
FN-4	1											2		
FN-5														
Unkeyed - Fac. Lactobacillus Enterococci Miscellaneous	1													
TOTAL	3	1	0	0	0	0	0	0	0	0	2	0	0	0

* Cultures showed no growth or were not transferable.

TABLE 45 --- Continued
Subject 22 - EXPERIMENT VI

Anaerobes	Sampling Period													
	1	2	3	4	5	6	7	8	9	10	11	12	13	14
FA-1		1	1		2									
FA-2														
FA-3			1		1	1	1			2				
FA-4														
FA-5				1			1				2			
FA-6														
FA-7			1									2	1	5
FA-8				2							1		1	
FA-9														
FA-10			1											
FA-11														
FA-12					1				1				1	
FA-13														
FA-14										1	1			
FA-15		2	1	1		1	2	2	1		1		1	
FA-16	2													
FA-17						1	1							
FA-18														
GD-1														
GD-2														
GD-3														
GD-4														
GD-5														
GD-6	1													
GD-7														
Unkeyed	2			1					1	1	1	1		
TOTAL	5	3	5	5	4	3	4	3	3	4	6	3	4	5
FN-1														
FN-2														
FN-3														
FN-4														
FN-5														
Unkeyed Lactobacillus Enterococci Miscellaneous				1										
TOTAL	0	0	0	1	0	0	0	0	0	0	0	0	0	0

TABLE 45 --- Continued
Subject 23 - EXPERIMENT VI

Anaerobes	Sampling Period													
	1	2	3	4	5	6	7	8	9	10	11	12	13	14
FA-1			1			1					1	2		1
FA-2														
FA-3	2	1	2		2			1		1	2	2	1	
FA-4														
FA-5												1		
FA-6				1	1	1	1							
FA-7														1
FA-8														1
FA-9														
FA-10										1				
FA-11														
FA-12														
FA-13														
FA-14			1	2		1	1		1					
FA-15	1	2				3	3	3	1	2	3			
FA-16														
FA-17								1	1					
FA-18								1					1	
GD-1														
GD-2												2	1	
GD-3														
GD-4														
GD-5														
GD-6														
GD-7														
Unkeyed						2	1	1						
TOTAL	3	3	4	3	3	8	6	7	3	4	6	7	3	3
FN-1														
FN-2				1										
FN-3														
FN-4														
FN-5												1		
Unkeyed Lactobacillus Enterococci Miscellaneous								1				1		
TOTAL	0	0	0	1	0	0	0	1	0	0	1	1	0	0

TABLE 45 --- Continued
Subject 24 - EXPERIMENT VI

Anaerobes	Sampling Period													
	1	2	3	4	5	6	7	8*	9	10	11	12*	13	14
FA-1					1	1	2							
FA-2														
FA-3		2	2	1	1	1	1				1		2	
FA-4														
FA-5														
FA-6			1		1		2							
FA-7		1			1				3	2	3		2	4
FA-8														
FA-9														
FA-10														
FA-11														
FA-12														
FA-13														
FA-14				1										
FA-15	3		1						1	1	1			
FA-16			1											
FA-17							2							
FA-18	1													
GD-1														
GD-2														
GD-3														
GD-4														
GD-5														
GD-6						1	1						1	
GD-7														
Unkeyed				1		1								
TOTAL	4	3	5	3	4	4	8	0	4	3	5	0	5	4
FN-1														
FN-2														
FN-3														
FN-4														
FN-5														
Unkeyed Lactobacillus Enterococci Miscellaneous														
TOTAL	0	0	0	0	0	0	0	0	0	0	0	0	0	0

TABLE 45 --- Continued

Subject 25 - EXPERIMENT VII

Anaerobes	Sampling Period													
	1	2	3	4**	5	6	7	8	9	10	11	12	13**	14
FA-1														
FA-2														
FA-3							1			1	2			1
FA-4														
FA-5							1							
FA-6		1	1						1					
FA-7											1			
FA-8														
FA-9							1							
FA-10		1			1	2	1			3		1	1	1
FA-11														
FA-12														
FA-13														
FA-14							1					1		
FA-15				1	1		1					2	3	1 1
FA-16														
FA-17		2	2		1			1						1
FA-18		1			1			1	2					
GD-1														
GD-2														
GD-3				1			1	2	1					
GD-4														
GD-5		1												
GD-6	1	2			1	1			1					1
GD-7							1							
Unkeyed									2*	1	2*			
TOTAL	1	8	3	2	5	5	5	5	7	5	8	4	2	5
FN-1														
FN-2														
FN-3														
FN-4														
FN-5														
Unkeyed Lactobacillus Enterococci Miscellaneous														
TOTAL	0	0	0	0	0	0	0	0	0	0	0	0	1	0

* Satellite colonies mixed curved rod and diplococcus.
 ** Several cultures showed no growth or were not transferable.

TABLE 45 --- Continued

Subject 26 - EXPERIMENT VII

Anaerobes	Sampling Period													
	1	2*	3	4*	5	6	7	8*	9	10	11	12	13	14
FA-1										1				
FA-2														
FA-3											1		1	2
FA-4														
FA-5	1					1								
FA-6														
FA-7														
FA-8			1	1		1								
FA-9														
FA-10		1			1	3		1	2	3	1	1		2
FA-11														
FA-12		1	1	1	1						1	1	1	1
FA-13														
FA-14	1					1								
FA-15												1		
FA-16														
FA-17										1	1	1		
FA-18														
GD-1														
GD-2														
GD-3					1			1		1		1	1	1
GD-4														
GD-5														
GD-6	1		1			3			1					
GD-7														
Unkeyed			1				1		1	1				
TOTAL	3	2	4	2	3	9	1	2	4	7	4	5	3	6
FN-1														
FN-2														
FN-3														
FN-4														
FN-5														
Unkeyed Lactobacillus Enterococci Miscellaneous	1							1						
TOTAL	1	0	0	0	0	0	0	1	0	0	0	0	0	0

* Several cultures showed no growth or were not transferable.

TABLE 45 --- Continued
Subject 27 - EXPERIMENT VII

Anaerobes	Sampling Period													
	1*	2	3	4	5	6*	7*	8	9*	10	11	12*	13	14
FA-1 FA-2 FA-3					1									
FA-4 FA-5 FA-6		1											1	
FA-7 FA-8 FA-9		1									2			
FA-10 FA-11 FA-12				1			1							
FA-13 FA-14 FA-15						1							1	
FA-16 FA-17 FA-18		1		1						2	3	1		1
GD-1 GD-2 GD-3 GD-4								2						
GD-5 GD-6 GD-7 Unkeyed					1								1	
TOTAL	0	3	0	2	3	2	1	3	2	3	3	0	5	3
FN-1 FN-2 FN-3 FN-4 FN-5					1		1							
Unkeyed Lactobacillus Enterococci Miscellaneous		2	2	3	1		4					1		
TOTAL	0	2	3	3	2	1	5	0	0	0	0	1	0	0

* Several cultures showed no growth or were not transferable.

TABLE 45 --- Continued
Subject 28 - EXPERIMENT VII

Anaerobes	Sampling P rioid													
	1	2	3	4*	5	6	7	8*	9*	10	11	12	13	14
FA-1									1		1			
FA-2														
FA-3			1			2	1				1	2		
FA-4										1				
FA-5	1				1	1								
FA-6		1	1											
FA-7			1							1				
FA-8						2					1			
FA-9	2													
FA-10														
FA-11														
FA-12														
FA-13														
FA-14	2				2					1		1	1	2
FA-15		1	1				1			1			1	1
FA-16														
FA-17	2										1			
FA-18						1							1	1
GD-1														
GD-2														
GD-3										1				
GD-4														
GD-5														
GD-6								1						
GD-7														
Unkeyed								1	1					
TOTAL	7	2	4	0	3	6	2	2	2	5	4	3	3	4
FN-1														
FN-2														
FN-3					1									
FN-4				1										
FN-5														
Unkeyed														
Lactobacillus														
Enterococci														
Miscellaneous														
TOTAL	0	0	0	1	1	0	0	0	0	0	0	0	0	0

* Several cultures showed no growth or were not transferable.

TABLE 45 --- Continued
Subject 29 - EXPERIMENT VIII

Anaerobes	Sampling Period													
	1	2	3	4	5	6	7	8	9	10	11	12	13	14
FA-1		1	1						1					
FA-2														
FA-3		1									1			
FA-4														
FA-5	1	2		1					1		4	3	3	2
FA-6														
FA-7	1													
FA-8							1							
FA-9	2	1	1							1				
FA-10	1	1												
FA-11		1								1				
FA-12		2				1					1			
FA-13					2		1							
FA-14					1		1							
FA-15	1	2				1	1	1	1					
FA-16									1					
FA-17	1			2		1				3	1			
FA-18	1						1		1	1				
GD-1														
GD-2									1					
GD-3			1	1										
GD-4			1											
GD-5													1 ⁽¹⁾	
GD-6				1										
GD-7														
Unkeyed	1	1	1				1 ⁽⁴⁾	2			2 ^(3,4)		1	
TOTAL	9	13	5	5	3	3	6	3	5	7	9	3	3	4
FN-1							1							
FN-2														
FN-3														
FN-4														
FN-5														
Unkeyed	1	1	1	1			2	2		1	1			
Lactobacillus							1							
Enterococci								1						
Miscellaneous							1 ⁽²⁾							
TOTAL	1	1	1	1	0	0	5	3	1	1	0	0	0	0

- (1) GD5A
- (2) Streptococcus faecalis
- (3) Possibly clostridium sp.
- (4) Peptococcus

NOTE: numbers include biochemical and morphological identification.

Contrails

TABLE 45 --- Continued

Subject 30 - EXPERIMENT VIII

Anaerobes	Sampling Period													
	1	2	3	4	5	6	7	8	9	10	11	12	13	14
FA-1				2										2
FA-2								2	1					
FA-3			1										1	
FA-4														
FA-5				1	1	1								1
FA-6			1											
FA-7														
FA-8												1		
FA-9	1					1				1				
FA-10														
FA-11														1
FA-12					2									1
FA-13														
FA-14					1			1				2		1
FA-15	2	2		1	2			3	1	3	1	1	1	
FA-16				1										1
FA-17														
FA-18				1		1		1		2		2	1	1
GD-1						1						1		
GD-2														
GD-3														
GD-4														
GD-5														
GD-6				2		1								
GD-7														
Unkeyed	1 ⁽³⁾	1 ⁽⁴⁾	2 ⁽⁵⁾	3*	2**	2***			1		1	1 ⁽³⁾	1 ⁽³⁾	1 ⁽⁶⁾
TOTAL	4	3	6	9	8	7	0	7	3	6	3	7	8	6
FN-1														
FN-2														
FN-3									1					
FN-4									1					
FN-5														
Unkeyed Lactobacillus				1		1			1	3	1			
Unkeyed Enterococci														
Unkeyed Miscellaneous				1 ⁽¹⁾							1 ⁽²⁾			
TOTAL	0	0	0	2	0	1	0	0	3	3	2		0	0

- (1) PS₂
- (2) Peptostreptococcus morbillorum
- (3) Sphaerophorus ridiculosus
- * one (3), two (4); **one (3), one (7);
- *** one (2), one (7)

- (4) Peptococcus Sp.
- (5) Vibrio sputorum 1
- (6) Peptostreptococcus parvulus
- (7) Vermiform

NOTE: Numbers include biochemical and morphological identification.

TABLE 45 --- Continued

Subject 31 - EXPERIMENT VIII

Anaerobes	Sampling Period													
	1	2	3	4	5	6	7	8	9	10	11	12	13	14
FA-1		2			1							1		
FA-2														
FA-3							1							
FA-4														
FA-5							1							
FA-6														
FA-7														
FA-8							1							
FA-9		1					1							
FA-10			1											
FA-11														
FA-12		1										1	2	
FA-13														
FA-14					1				1		1			
FA-15	1	2	4	4	1	2	3	2	3	4	1	2	3	
FA-16					1	1		1		1	1	1		
FA-17	1													1
FA-18			1	1	1	1		1	1			1		1
GD-1														
GD-2				2								1		
GD-3														
GD-4														
GD-5														
GD-6														
GD-7														
Unkeyed	1	1		2 ^(3,4)	1 ⁽²⁾	1 ⁽⁴⁾		1 ⁽⁴⁾	1 ⁽⁴⁾	2	1 ⁽²⁾		1 ⁽²⁾	
TOTAL	3	7	6	9	6	5	3	9	6	8	5	7	8	
FN-1				1										
FN-2														
FN-3														
FN-4			1	1		1								
FN-5							2		1					
Unkeyed			1 ⁽¹⁾	1 ⁽¹⁾				3						
Lactobacillus														
Enterococci														
Miscellaneous														
TOTAL	0	0	2	3	0	1	2	3	1	0	0	0	0	

(1) PS₂

*one (3), one (4)

(2) Peptostreptococcus lanceolatus

(3) An. vibrio

(4) Peptococci

NOTE: Numbers include biochemical and morphological identification.

TABLE 45 --- Continued

Subject 32 - EXPERIMENT VIII

Anaerobes	Sampling Period													
	1	2	3	4	5	6	7	8	9	10	11	12	13	14
FA-1						2			1					1
FA-2														
FA-3							2			1		1		1
FA-4														
FA-5						1							1	1
FA-6							1							
FA-7					1		1							
FA-8				1									1	
FA-9	1	1	1						1					
FA-10														
FA-11														
FA-12				1	1	1		1		1	1	1		
FA-13														
FA-14		1			1									
FA-15	1	1			3	3	2	1	2	3	1	1	2	3
FA-16								1						
FA-17		1					3						1	
FA-18			1	1	1	1	1	1		1	1		1	2
GD-1			1											
GD-2	1				1							1		
GD-3														
GD-4														
GD-5														
GD-6	1	1										1		
GD-7														
Unkeyed		2	1			1 ⁽¹⁾	1 ⁽²⁾			1				
TOTAL	4	7	4	3	8	9	9	6	4	7	3	5	6	8
FN-1														
FN-2														
FN-3					1									
FN-4				1		1								
FN-5														
Unkeyed Lactobacillus Enterococci Miscellaneous						1	1	1						
TOTAL	0	0	0	1	1	2	1	1	0	0	0	0	0	0

(1) Sphaerophorus sp.
(2) Peptococcus

NOTE: Numbers include biochemical and morphological identification

TABLE 45 --- Continued
Subject 33 - EXPERIMENT IX

Anaerobes	Sampling Period											
	1	2	3	4	5	6	7	8	9	10	11	12
FA-1												
FA-2				2								
FA-3	2											
FA-4	2											
FA-5												
FA-6												
FA-7									1			
FA-8												
FA-9			2		1						1	
FA-10												
FA-11					1	1						
FA-12	1			1			3	1	5	4	3	
FA-13												
FA-14												
FA-15							2					1
FA-16							1					
FA-17	1			2								
FA-18											1	
GD-1		2										
GD-2		2										
GD-3												
GD-4								1				
GD-5		1*										1
GD-6												
GD-7												
Unkeyed					1	1 ⁽³⁾		1 ⁽²⁾	1	1		1 ⁽¹⁾ 2 ⁽³⁾
TOTAL	6	5	2	5	3	2	6	4	6	5	5	5
FN-1												
FN-2												
FN-3												
FN-4												
FN-5												
Unkeyed	1							1		1	3	1
Lactobacillus	1			1					1			
Enterococci					1		2					
Miscellaneous	1 ⁽³⁾											
TOTAL	3	0	0	1	1	0	2	1	1	1	3	1

- (1) *Peptococcus grigoroffi*
- (2) *Fusobacterium* sp.
- (3) *Peptostreptococcus* sp.

* GD-5A

NOTE: Numbers include biochemical and morphological identification.

TABLE 45 --- Continued
Subject 34 - EXPERIMENT IX

Anaerobes	Sampling Period											
	1	2	3	4	5	6	7	8	9	10	11	12
FA-1		1										
FA-2												
FA-3					1			1	1			
FA-4												
FA-5												
FA-6												
FA-7	2								2			
FA-8	1											
FA-9			3			2		1	2			
FA-10												
FA-11												
FA-12	1	1				1	4	2	1	1		
FA-13												
FA-14												
FA-15					1			1				
FA-16												
FA-17												
FA-18												
GD-1						1		1		4		2
GD-2												
GD-3												
GD-4												
GD-5	1				1	3						
GD-6												
GD-7												
Unkeyed	1 ⁽²⁾ 1 ⁽¹⁾	1 ⁽⁵⁾	1 ⁽⁴⁾ 1 ⁽¹⁾	1					1 ⁽²⁾			
TOTAL	7	3	6	0	3	7	4	6	8	5	0	2
FN-1												
FN-2												
FN-3												
FN-4												
FN-5												
Unkeyed Lactobacillus			1					1		1		
Unkeyed Enterococci												
Unkeyed Miscellaneous	1 ⁽³⁾					2 ⁽³⁾						
TOTAL	1	0	1	2	0	0	0	1	0	1	0	0

- (1) *Peptostreptococcus parvulus*
- (2) *Peptostreptococcus* sp.
- (3) PS₂
- (4) *Peptostreptococcus productus*
- (5) *Peptostreptococcus micros*

NOTE: Numbers include biochemical and morphological identification.

Contrails

TABLE 45 --- Continued
Subject 35 - EXPERIMENT IX

Anaerobes	Sampling Period											
	1	2	3	4	5	6	7	8	9	10	11	12
FA-1											2	
FA-2												
FA-3	1		1		1							
FA-4												
FA-5						2						
FA-6							2					
FA-7	2											
FA-8						1					2	1
FA-9							1					
FA-10												
FA-11												
FA-12	1				2							
FA-13												
FA-14	1											
FA-15				1								
FA-16					1							
FA-17			1									
FA-18		1										
GD-1	1		1					1				4
GD-2												
GD-3											1	
GD-4												
GD-5						2						2
GD-6												
GD-7								2				
Unkeyed	1 ⁽²⁾	1	1 ⁽³⁾		2 ⁽¹⁾		1	1	3 ⁽⁴⁾		3	
TOTAL	8	1	4	1	6	5	3	7	NS	3	5	7
FN-1												
FN-2												
FN-3												
FN-4												
FN-5												
Unkeyed						1						
Lactobacillus												
Enterococci												
Miscellaneous												
TOTAL	0	0	0	0	0	1	0	0	NS	0	0	0

- (1) Lactobacillaceae sp.
- (2) Peptococcus aerogenes
- (3) Fusobacterium sp.
- (4) Peptostreptococcus sp.

NS = no sample

NOTE: Numbers include biochemical and morphological identification.

TABLE 45 --- Concluded
Subject 36 - EXPERIMENT IX

Anaerobes	Sampling Period											
	1	2	3	4	5	6	7	8	9	10	11	12
FA-1 FA-2 FA-3				1								
FA-4 FA-5 FA-6										3		
FA-7 FA-8 FA-9		4										
FA-10 FA-11 FA-12				1	2							
FA-13 FA-14 FA-15			2				1				3	1
FA-16 FA-17 FA-18		1		1							1	
GD-1 GD-2 GD-3 GD-4					2							
GD-5 GD-6 GD-7 Unkeyed									1			
	2 ⁽⁶⁾	1	1	2 ⁽²⁾	2 ⁽⁴⁾	1		1 ⁽¹⁾				
TOTAL	4	5	8	5	4	1	1	1	3	5	4	3
FN-1 FN-2 FN-3 FN-4 FN-5							3					
Unkeyed Lactobacillus Enterococci Miscellaneous		3	1	3						4		
							3			3		1
	3 ⁽⁵⁾					1 ⁽⁷⁾	2 ⁽⁹⁾	5 ⁽³⁾			3 ⁽¹⁾	
TOTAL	3	3	1	3	0	1	5	5	4	3	3	1

(1) Peptostreptococcus sp.

(2) Peptostreptococcus productus

(3) Micrococcaecae

(4) Lactobacilli

(5) PS₃

(6) Fusobacterium sp.

(7) PS₂

NOTE: Numbers include biochemical and morphological identification.

TABLE 46. TOTAL DISTRIBUTION OF FECAL ANAEROBES BY SUBJECT

EXPERIMENT V

Anaerobes	Subject Number			
	17	18	19	20
FA-1	9	5	7	11
FA-2	4	2	1	2
FA-3	11	8	10	9
FA-4	0	1	0	1
FA-5	2	2	4	4
FA-6	10	2	8	2
FA-7	1	0	1	1
FA-8	5	2	3	2
FA-9	5	2	4	5
FA-10	1	1	2	0
FA-11	0	0	0	0
FA-12	2	1	1	1
FA-13	0	3	0	2
FA-14	1	3	3	4
FA-15	8	12	10	12
FA-16	0	0	0	0
FA-17	1	0	1	0
FA-18	7	4	9	3
GD-1	0	0	0	0
GD-2	0	0	0	0
GD-3	2	1	0	1
GD-4	3	0	5	0
GD-5	0	0	0	0
GD-6	4	2	1	6
GD-7	2	0	2	0
Unkeyed	1	2	1	2
TOTAL	79	53	73	68
FN-1	0	1	0	1
FN-2	2	2	2	1
FN-3	1	0	1	0
FN-4	3	4	2	1
FN-5	2	3	1	2
Unkeyed	2	1	1	0
Lactobacillus	1	1	2	0
Enterococci	1	2	1	1
Miscellaneous	0	0	0	0
TOTAL	12	14	10	6

TABLE 46 --- Continued

EXPERIMENT VI

Anaerobes	Subject Number			
	21	22	23	24
FA-1	3	4	6	4
FA-2	0	0	0	0
FA-3	4	6	14	11
FA-4	0	0	0	0
FA-5	2	4	1	0
FA-6	0	0	4	4
FA-7	0	9	1	16
FA-8	11	4	1	0
FA-9	0	0	0	0
FA-10	0	1	1	0
FA-11	1	0	0	0
FA-12	0	3	0	0
FA-13	0	0	0	0
FA-14	7	2	6	1
FA-15	13	12	18	7
FA-16	0	2	0	1
FA-17	4	2	2	2
FA-18	6	0	2	1
GD-1	0	0	0	0
GD-2	0	0	3	0
GD-3	0	0	0	0
GD-4	1	0	0	0
GD-5	0	0	0	0
GD-6	0	1	0	3
GD-7	0	0	0	0
Unkeyed	8	7	4	2
TOTAL	60	57	63	52
FN-1	0	0	0	0
FN-2	2	0	1	0
FN-3	0	0	0	0
FN-4	1	0	0	0
FN-5	0	0	1	0
Unkeyed	3	1	1	0
Lactobacillus	0	0	0	0
Enterococci	0	0	1	0
Miscellaneous	0	0	0	0
TOTAL	6	1	4	0

TABLE 46 --- Continued

EXPERIMENT VII

Anaerobes	Subject Number			
	25**	26**	27*	28*
FA-1	0	1	0	2
FA-2	0	0	0	0
FA-3	5	4	1	7
FA-4	0	0	0	1
FA-5	1	2	2	3
FA-6	3	0	0	2
FA-7	1	0	0	2
FA-8	0	3	0	3
FA-9	1	0	3	2
FA-10	11	15	1	0
FA-11	0	0	0	0
FA-12	0	8	1	0
FA-13	0	0	0	0
FA-14	2	2	2	9
FA-15	10	1	5	6
FA-16	0	0	0	0
FA-17	7	3	7	3
FA-18	5	0	2	3
GD-1	0	0	0	0
GD-2	0	0	0	0
GD-3	5	6	2	1
GD-4	0	0	0	0
GD-5	1	0	0	0
GD-6	7	6	2	1
GD-7	1	0	0	0
Unkeyed	5*	4	2	2
TOTAL	65	55	30	47
FN-1	0	0	0	0
FN-2	1	0	0	0
FN-3	0	0	0	1
FN-4	0	0	3	1
FN-5	0	0	8	0
Unkeyed	0	2	6	0
Lactobacillus	0	0	0	0
Enterococci	0	0	0	0
Miscellaneous	0	0	0	0
TOTAL	1	2	17	2

* 4 Satellite colonies mixed curved rod and diplococcus.
 ** Several culture showed no growth or were not transferable.

TABLE 46 --- Continued

EXPERIMENT VIII*

Anaerobes	Subject Number			
	29	30	31	32
FA-1	3	4	3	4
FA-2	0	3	1	0
FA-3	2	2	1	5
FA-4	0	0	0	0
FA-5	17	4	1	3
FA-6	1	1		1
FA-7	1	0	0	2
FA-8	1	1	1	2
FA-9	5	3	2	4
FA-10	2	0	1	0
FA-11	2	1	0	0
FA-12	4	3	4	7
FA-13	3	0	0	0
FA-14	2	5	3	2
FA-15	7	17	32	23
FA-16	1	2	6	1
FA-17	8	0	2	5
FA-18	4	9	8	11
GD-1	0	2	1	1
GD-2	1	0	3	3
GD-3	2	0	0	0
GD-4	1	0	0	0
GD-5	(1)	0	0	0
GD-6	1	3	0	3
GD-7	0	4	1	0
Unkeyed	9	13	12	6
TOTAL	78	77	82	83
FN-1	0	0	1	0
FN-2	0	0	0	0
FN-3	0	1	0	1
FN-4	0	1	3	2
FN-5	0	0	3	0
Unkeyed	10	7	5	3
Lactobacillus	1	0	0	0
Enterococci	1	0	0	0
Miscellaneous	1	2	0	0
TOTAL	13	10	12	6

(1) GD5A

* Numbers include biochemical and morphological identification.

TABLE 46 --- Concluded

EXPERIMENT IX*

Anaerobes	Subject Number			
	33	34	35	36
FA-1	0	1	2	0
FA-2	2	0	0	0
FA-3	2	3	3	1
FA-4	2	0	0	3
FA-5	0	0	2	0
FA-6	0	0	2	0
FA-7	1	4	2	4
FA-8	0	1	4	0
FA-9	4	8	1	0
FA-10	0	0	0	2
FA-11	2	0	0	1
FA-12	18	11	3	7
FA-13	0	0	0	0
FA-14	0	0	1	3
FA-15	3	2	1	7
FA-16	1	1	1	0
FA-17	3	0	1	3
FA-18	1	0	1	0
GD-1	2	8	7	0
GD-2	2	0	0	0
GD-3	0	0	1	2
GD-4	1	0	0	0
GD-5	1 ^{GD5A1}	5	4	0
GD-6	0	0	0	0
GD-7	0	0	2	1
Unkeyed	8	7	13	10
TOTAL	54	51	51	44
FN-1	0	0	0	0
FN-2	0	0	0	0
FN-3	0	0	0	0
FN-4	0	0	0	0
FN-5	0	0	0	4
Unkeyed	2	4	1	5
Lactobacillus	1	0	0	6
Enterococci	0	0	0	2
Miscellaneous	0	2	0	12
TOTAL	3	6	1	29

* Numbers include biochemical and morphological identification.

TABLE 47. TOTAL DISTRIBUTION OF FECAL ANAEROBES BY SAMPLING PERIOD

Subject 17 through 20 - EXPERIMENT V

Anaerobes	Sampling Period											TOTAL
	1	2	3	4	5	6	7	8	9	10	11	
FA-1	2	3	2	1	3	1	6	5	5	4	0	32
FA-2	0	0	0	0	1	3	1	0	0	1	3	9
FA-3	4	5	3	1	4	2	3	4	4	5	3	38
FA-4	2	0	0	0	0	0	0	0	0	0	0	2
FA-5	2	2	0	1	4	2	0	1	0	0	0	12
FA-6	2	3	3	1	1	1	0	2	4	2	3	22
FA-7	0	1	1	0	0	0	0	0	0	1	0	3
FA-8	2	0	1	0	0	2	4	1	1	1	0	12
FA-9	2	0	0	4	2	1	4	2	0	1	0	16
FA-10	2	0	0	0	0	1	0	1	0	0	0	4
FA-11	0	0	0	0	0	0	0	0	0	0	0	0
FA-12	0	0	0	0	3	0	0	1	0	1	0	5
FA-13	0	0	0	0	0	0	0	0	2	3	0	5
FA-14	2	0	0	2	0	1	0	1	2	2	1	11
FA-15	6	5	6	2	8	1	3	5	3	3	0	42
FA-16	0	0	0	0	0	0	0	0	0	0	0	0
FA-17	0	0	0	2	0	0	0	0	0	0	0	2
FA-18	1	4	1	1	5	2	2	0	3	3	1	23
GD-1	0	0	0	0	0	0	0	0	0	0	0	0
GD-2	0	0	0	0	0	0	0	0	0	0	0	0
GD-3	1	0	0	0	0	0	2	0	0	0	1	4
GD-4	0	0	0	1	2	1	0	0	2	1	1	8
GD-5	0	0	0	0	0	0	0	0	0	0	0	0
GD-6	3	4	0	0	3	0	0	1	2	0	0	13
GD-7	0	0	2	0	0	0	0	0	0	2	0	4
Unkeyed	0	3	0	1	2	0	0	0	0	0	0	6
TOTAL	31	30	19	16	39	18	25	24	28	30	13	273
FN-1	0	0	0	0	0	0	1	0	0	0	0	1
FN-2	2	0	0	0	2	0	0	0	0	3	0	7
FN-3	2	0	0	0	0	0	0	0	0	0	0	2
FN-4	3	0	1	0	1	1	1	1	1	2	0	11
FN-5	5	0	0	0	0	0	1	0	2	0	0	8
Unkeyed	3	1	0	0	0	0	0	0	0	0	0	4
Lactobacillus	0	0	1	0	1	1	0	1	0	0	0	4
Enterococci	2	0	0	0	0	0	1	1	1	0	0	5
Miscellaneous	0	0	0	0	0	0	0	0	0	0	0	0
TOTAL	17	1	2	0	4	2	4	3	4	5	0	42

TABLE 47 --- Continued

Subject 21 through 24 - EXPERIMENT VI

Anaerobes															TOTAL
	1	2	3	4	5	6	7	8	9	10	11	12	13	14	
FA-1	1	1	2	0	3	2	2	0	0	1	1	3	0	1	17
FA-2	0	0	0	0	0	0	0	0	0	0	0	0	0	0	0
FA-3	4	3	5	2	4	2	1	3	0	3	3	2	3	0	35
FA-4	0	0	0	0	0	0	0	0	0	0	0	0	0	0	0
FA-5	0	0	0	1	0	0	1	0	1	0	2	2	0	0	7
FA-6	0	0	1	1	2	1	3	0	0	0	0	0	0	0	8
FA-7	0	1	1	0	1	0	0	0	3	2	3	2	3	10	26
FA-8	0	0	0	2	0	0	0	2	0	1	4	2	3	3	17
FA-9	0	0	0	0	0	0	0	0	0	0	0	0	0	0	0
FA-10	0	0	1	0	0	0	0	0	0	1	0	0	0	0	2
FA-11	0	0	0	1	0	0	0	0	0	0	0	0	0	0	1
FA-12	0	0	0	0	1	0	0	0	1	0	0	0	1	0	3
FA-13	0	0	0	0	0	0	0	0	0	0	0	0	0	0	0
FA-14	1	1	0	4	0	2	1	0	1	2	2	1	0	0	15
FA-15	6	7	4	2	0	4	5	5	3	4	6	1	2	1	50
FA-16	2	0	1	0	0	0	0	0	0	0	0	0	0	0	3
FA-17	0	0	1	1	0	2	3	1	2	0	0	0	0	0	10
FA-18	2	1	0	0	0	1	0	2	1	1	0	0	1	0	9
GD-1	0	0	0	0	0	0	0	0	0	0	0	0	0	0	0
GD-2	0	0	0	0	0	0	0	0	0	0	0	2	1	0	3
GD-3	0	0	0	0	0	0	0	0	0	0	0	0	0	0	0
GD-4	0	0	0	0	0	1	0	0	0	0	0	0	0	0	1
GD-5	0	0	0	0	0	0	0	0	0	0	0	0	0	0	0
GD-6	1	0	0	0	0	1	1	0	0	1	0	0	1	0	5
GD-7	0	0	0	0	0	0	0	0	0	0	0	0	0	0	0
Unkeyed	4	0	0	3	0	3	2	2	2	1	1	1	2	0	20
TOTAL	21	14	16	17	11	19	19	15	14	17	22	16	17	15	232
FN-1	0	0	0	0	0	0	0	0	0	0	0	0	0	0	0
FN-2	1	1	0	1	0	0	0	0	0	0	0	0	0	0	3
FN-3	0	0	0	0	0	0	0	0	0	0	0	0	0	0	0
FN-4	1	0	0	0	0	0	0	0	0	0	2	0	0	0	3
FN-5	0	0	0	0	0	0	0	0	0	0	0	1	0	0	1
Unkeyed	1	0	0	1	0	0	0	1	0	0	0	0	0	0	3
Lactobacillus	0	0	0	0	0	0	0	0	0	0	0	0	0	0	0
Enterococci	0	0	0	0	0	0	0	0	0	0	1	0	0	0	1
Miscellaneous	0	0	0	0	0	0	0	0	0	0	0	0	0	0	0
TOTAL	3	1	0	2	0	0	0	1	0	0	3	1	0	0	11

TABLE 47 --- Continued

Subject 25 through 28 - EXPERIMENT VII

Anaerobes	Sampling Period														TOTAL
	1	2	3	4	5	6	7	8	9	10	11	12	13	14	
FA-1	0	0	0	0	0	0	0	0	1	1	1	0	0	0	3
FA-2	0	0	0	0	0	0	0	0	0	0	0	0	0	0	0
FA-3	0	0	1	0	1	2	1	1	0	1	4	2	1	3	17
FA-4	0	0	0	0	0	0	0	0	0	1	0	0	0	0	1
FA-5	2	1	0	0	1	2	1	0	0	0	0	0	1	0	8
FA-6	0	2	2	0	0	0	0	0	1	0	0	0	0	0	5
FA-7	0	0	1	0	0	0	0	0	0	1	1	0	0	0	3
FA-8	0	0	1	1	0	3	0	0	0	0	1	0	0	0	6
FA-9	2	1	0	0	0	1	0	0	0	0	2	0	0	0	6
FA-10	0	2	0	1	2	5	1	1	2	6	1	2	1	3	27
FA-11	0	0	0	0	0	0	0	0	0	0	0	0	0	0	0
FA-12	0	1	1	1	1	0	1	0	0	0	1	1	1	1	9
FA-13	0	0	0	0	0	0	0	0	0	0	0	0	0	0	0
FA-14	3	0	0	0	2	3	0	0	0	1	1	1	2	2	15
FA-15	0	2	1	2	1	0	2	0	0	1	2	4	4	3	22
FA-16	0	0	0	0	0	0	0	0	0	0	0	0	0	0	0
FA-17	2	2	2	0	1	0	0	1	2	4	3	1	0	2	20
FA-18	0	1	0	0	1	1	0	2	2	0	0	0	1	2	10
GD-1	0	0	0	0	0	0	0	0	0	0	0	0	0	0	0
GD-2	0	0	0	0	0	0	0	0	0	0	0	0	0	0	0
GD-3	0	0	0	1	1	0	1	5	1	2	0	1	1	1	14
GD-4	0	0	0	0	0	0	0	0	0	0	0	0	0	0	0
GD-5	0	1	0	0	0	0	0	0	0	0	0	0	0	0	1
GD-6	2	2	1	0	2	4	0	1	2	0	0	0	1	1	16
GD-7	0	0	0	0	0	0	1	0	0	0	0	0	0	0	1
Unkeyed	0	0	1	0	1	1	1	1	4	2	2	0	0	0	13
TOTAL	11	15	11	6	14	22	9	12	15	20	19	12	13	18	197
FN-1	0	0	0	0	0	0	0	0	0	0	0	0	0	0	0
FN-2	0	0	0	0	0	0	0	0	0	0	0	0	1	0	1
FN-3	0	0	0	0	1	0	0	0	0	0	0	0	0	0	1
FN-4	0	0	1	1	1	0	1	0	0	0	0	0	0	0	4
FN-5	0	2	2	3	1	0	0	0	0	0	0	0	0	0	8
Unkeyed	1	0	0	0	0	1	4	1	0	0	0	1	0	0	8
Lactobacillus	0	0	0	0	0	0	0	0	0	0	0	0	0	0	0
Enterococci	0	0	0	0	0	0	0	0	0	0	0	0	0	0	0
Miscellaneous	0	0	0	0	0	0	0	0	0	0	0	0	0	0	0
TOTAL	1	2	3	4	3	1	5	1	0	0	0	1	1	0	22

TABLE 47 --- Continued

Subject 29 through 32 - EXPERIMENT VIII*

Anaerobes	Sampling Period														TOTAL
	1	2	3	4	5	6	7	8	9	10	11	12	13	14	
FA-1	0	0	1	2	1	2	0	0	1	1	0	0	2	1	11
FA-2	0	0	0	0	0	0	0	2	1	0	0	1	0	0	4
FA-3	0	0	1	0	0	0	0	3	0	1	1	1	1	1	9
FA-4	0	0	0	0	0	0	0	0	0	0	0	0	0	0	0
FA-5	1	2	0	2	1	2	0	1	1	0	4	3	4	4	25
FA-6	0	1	1	0	0	0	1	0	0	0	0	0	0	0	3
FA-7	1	0	0	0	1	0	1	0	0	0	0	0	0	0	3
FA-8	0	0	0	0	0	0	1	0	0	0	1	0	1	0	3
FA-9	4	3	2	0	0	1	0	1	1	2	0	0	0	0	14
FA-10	1	1	0	0	0	0	0	0	0	0	0	0	0	0	2
FA-11	0	1	0	0	0	0	0	0	0	1	0	0	0	1	3
FA-12	0	3	0	1	3	2	0	1	0	1	2	2	2	1	18
FA-13	0	0	0	0	2	0	1	0	0	0	0	0	0	0	3
FA-14	0	1	0	0	4	0	1	1	1	0	0	2	0	1	11
FA-15	5	7	4	5	6	6	6	7	7	10	3	4	6	3	79
FA-16	0	0	0	0	0	1	0	2	1	1	1	1	1	0	8
FA-17	2	1	0	2	0	0	3	0	0	3	1	0	2	0	14
FA-18	1	0	2	3	2	3	2	3	2	4	1	3	3	3	32
GD-1	0	0	1	0	0	1	1	0	0	1	0	1	0	0	5
GD-2	1	0	0	2	1	0	0	0	1	0	0	2	0	0	7
GD-3	0	0	1	1	0	0	0	0	0	0	0	0	0	0	2
GD-4	0	0	1	0	0	0	0	0	0	0	0	0	0	0	1
GD-5	0	0	0	0	0	0	0	0	0	0	0	0	0	1	1
GD-6	1	1	2	0	0	1	0	0	0	0	0	1	0	0	4
GD-7	0	0	0	0	1	1	0	0	0	0	1	0	1	0	4
Unkeyed	3	5	4	4	2	3	2	3	2	3	4	1	2	2	41
TOTAL	20	26	20	22	24	23	19	24	18	28	19	22	25	18	308
FN-1	0	0	2	1	0	0	1	0	0	0	0	0	0	0	4
FN-2	0	0	0	0	0	0	0	0	0	0	0	0	0	0	0
FN-3	0	0	0	0	1	0	0	0	1	0	0	0	0	0	2
FN-4	0	0	0	2	0	2	0	0	1	0	0	0	0	0	5
FN-5	0	0	0	0	0	0	2	0	1	0	0	0	0	0	3
Unkeyed	1	1	0	3	0	2	3	6	1	4	1	1	0	0	23
Lactobacillus	0	0	0	0	0	0	1	0	0	0	0	0	0	0	1
Enterococci	0	0	0	0	0	0	0	1	0	0	0	0	0	0	1
Miscellaneous	0	0	0	1	0	0	1	0	0	0	1	0	0	0	3
TOTAL	1	1	2	7	1	4	8	7	4	4	2	1	0	0	42

* Numbers include biochemical and morphological identification.

TABLE 47 --- Concluded

Subject 33 through 36 - EXPERIMENT IX**

Anaerobes	Sampling Period												TOTAL
	1	2	3	4	5	6	7	8	9	10	11	12	
FA-1	0	1	0	0	0	0	0	0	0	0	2	0	3
FA-2	0	0	0	2	0	0	0	0	0	0	0	0	2
FA-3	3	1	1	3	2	0	0	1	1	0	0	0	12
FA-4	2	0	0	0	0	0	0	0	0	3	0	0	5
FA-5	0	0	0	0	0	2	0	0	0	0	0	0	2
FA-6	0	0	0	0	0	0	2	0	0	0	0	0	2
FA-7	4	4	0	0	0	0	0	0	3	0	0	0	11
FA-8	1	0	0	0	0	1	0	0	0	0	2	1	5
FA-9	0	0	5	0	1	2	1	1	2	0	1	0	13
FA-10	0	0	0	0	2	0	0	0	0	0	0	0	2
FA-11	0	0	0	1	1	1	0	0	0	0	0	0	3
FA-12	3	1	2	1	2	1	8	3	6	5	6	1	39
FA-13	0	0	0	0	0	0	0	0	0	0	0	0	0
FA-14	1	1	0	1	0	0	0	0	0	0	1	0	4
FA-15	0	0	3	1	1	0	2	1	2	0	0	3	13
FA-16	0	0	0	0	1	0	1	0	1	0	0	0	3
FA-17	2	0	1	2	0	0	0	0	0	2	0	0	7
FA-18	0	1	0	0	0	0	0	0	0	0	1	0	2
GD-1	1	2	1	0	0	1	0	2	0	4	0	6	17
GD-2	0	2	0	0	0	0	0	0	0	0	0	0	2
GD-3	0	0	0	0	2	0	0	0	0	0	1	0	3
GD-4	0	0	0	0	0	0	0	1	0	0	0	0	1
GD-5	1	1*	0	0	1	5	0	0	0	0	0	3	11
GD-6	0	0	0	0	0	0	0	0	0	0	0	0	0
GD-7	0	0	0	0	0	0	0	2	1	0	0	0	3
Unkeyed	7	1	7	2	3	2	1	7	1	4	0	3	38
TOTAL	25	15	20	13	16	15	15	18	17	18	14	17	203
FN-1	0	0	0	0	0	0	3	0	0	0	0	0	3
FN-2	0	0	0	0	0	0	0	0	0	0	0	0	0
FN-3	0	0	0	0	0	0	0	0	0	0	0	0	0
FN-4	0	0	0	0	0	0	0	0	0	0	0	0	0
FN-5	0	0	0	0	0	0	0	0	4	0	0	0	4
Unkeyed	1	3	2	3	0	1	0	2	0	2	3	2	19
Lactobacillus	1	0	0	1	0	0	3	0	1	3	0	0	9
Enterococci	0	0	0	0	1	0	4	0	0	0	0	0	5
Miscellaneous	5	0	0	2	0	1	0	5	0	0	3	0	16
TOTAL	7	3	2	6	1	2	10	7	5	5	6	2	56

*GD-5A

** Numbers include biochemical and morphological identification.

TABLE 48. TOTAL DISTRIBUTION OF FECAL ANAEROBES BY EXPERIMENT

Anaerobes	Experiment Number					TOTAL
	V	VI	VII	VIII *	IX *	
FA-1	32	17	3	11	3	66
FA-2	9	0	0	4	2	15
FA-3	38	35	17	9	12	111
FA-4	2	0	1	0	5	8
FA-5	12	7	8	25	2	54
FA-6	22	8	5	3	2	40
FA-7	3	26	3	3	11	46
FA-8	12	17	6	3	5	43
FA-9	16	0	6	14	13	49
FA-10	4	2	27	2	2	37
FA-11	0	1	0	3	3	7
FA-12	5	3	9	18	39	74
FA-13	5	0	0	3	0	8
FA-14	11	15	15	11	4	56
FA-15	42	50	22	79	13	206
FA-16	0	3	0	8	3	14
FA-17	2	10	20	14	7	53
FA-18	23	9	10	32	2	76
GD-1	0	0	0	5	17	22
GD-2	0	3	0	7	2	12
GD-3	4	0	14	2	3	23
GD-4	8	1	0	1	1	11
GD-5	0	0	1	1	11	13
GD-6	13	5	16	4	0	38
GD-7	4	0	1	4	3	12
Unkeyed	6	20	13	41	38	118
TOTAL	273	232	197	307	203	1212
FN-1	1	0	0	4	3	8
FN-2	7	3	1	0	0	11
FN-3	2	0	1	2	0	5
FN-4	11	3	4	5	0	23
FN-5	8	1	8	3	4	24
Unkeyed	4	3	8	23	19	57
Lactobacillus	4	0	0	1	9	14
Enterococci	5	1	0	1	5	12
Miscellaneous	0	0	0	3	16	19
TOTAL	42	11	22	42	56	173

* Numbers include biochemical and morphological identification.

**TABLE 49. DISTRIBUTION OF EIGHTEEN TYPE CULTURES
IN THREE SEPARATE GROUPS AND
TOTAL RANK ACCORDING TO TOTAL OCCURRENCE***

Anaerobes	Series			Total
	1	2	3	
FA-1	25	65	36	126
FA-15	29	54	33	116
FA-3	26	22	44	92
FA-5	22	48	5	75
FA-12	18	18	22	58
FA-6	19	18	20	57
FA-14	19	9	26	54
FA-8	18	12	13	43
FA-10	15	13	7	35
FA-18	3	13	18	34
FA-17	15	8	10	33
FA-2	12	9	5	26
FA-16	8	5	3	16
FA-11	8	2	1	11
FA-7	2	2	6	10
FA-9	2	3	5	10
FA-13	3	3	2	8
FA-4	6	1	0	7
TOTAL	250	305	256	811

* Results obtained under NASA contract NASw-738, "Study of the Normal Fecal Bacterial Flora of Man."

TABLE 50 . B VITAMIN PRODUCTION OR USE BY THE TYPE CULTURES IN VITRO

Predominating Type Culture	Vitamine B ₁₂ m μ/cc	Riboflavin μ/cc	Niacin μ/cc	Pantothenic Acid μ/cc	Folic Acid m μ/cc	Predominating Type Culture	Vitamine B ₁₂ m μ/cc	Riboflavin μ/cc	Niacin μ/cc	Pantothenic Acid μ/cc	Folic Acid m μ/cc
*NASw-738						Exp. V					
FA-1	0.288	0.096	3.1	0.37	35.0	FA-15	0.255	0.096	3.40	0.301	10.0
FA-15	0.255	0.096	3.40	0.301	10.0	FA-3	0.125	0.099	3.0	0.0463	10.0
FA-3	0.125	0.099	3.0	0.0463	10.0	FA-1	0.288	0.096	3.1	0.370	35.0
FA-5	0.262	0.102	3.2	0.0814	15.5	FA-18**					
FA-12	0.325	0.090	2.65	0.359	17.0	FA-6	0.262	0.093	3.35	0.243	16.5
FA-6	0.262	0.093	3.35	0.243	16.5	FA-9	0.362	0.078	2.45	0.208	15.5
Total	1.517	0.576	18.70	1.4007	104.0	Total	1.292	0.462	15.30	1:1683	87.0
Exp. VI						Exp. VII					
FA-15	0.255	0.096	3.40	0.301	10.0	FA-10	0.400	0.84	2.74	0.301	25.0
FA-3	0.125	0.099	3.0	0.0463	10.0	FA-15	0.255	0.096	3.40	0.301	10.0
FA-7	0.262	0.093	2.65	0.393	25.0	FA-17**					
FA-1	0.288	0.096	3.10	0.37	35.0	FA-3	0.125	0.099	3.0	0.0463	10.0
FA-8	0.225	0.087	3.60	0.532	14.5	GD-6**					
FA-14	0.200	0.114	2.50	0.0231	11.0	FA-14	0.200	0.114	2.50	0.0231	11.0
Total	1.355	0.585	18.25	1.6654	105.5	Total	0.980	0.393	11.60	0.6714	56.0
Exp. VIII						Exp. IX					
FA-15	0.255	0.096	3.40	0.301	10.0	FA-12	0.325	0.090	2.65	0.359	17.0
FA-18**						GD-1**					
FA-5	0.262	0.102	3.2	0.0814	15.5	FA-9	0.362	0.078	2.45	0.208	15.5
FA-12	0.325	0.090	2.65	0.359	17.0	FA-15	0.255	0.096	3.40	0.301	10.0
FA-17**						FA-3	0.125	0.099	3.0	0.0463	10.0
FA-1	0.288	0.096	3.1	0.37	35.0	FA-7	0.262	0.093	2.65	0.393	25.0
Total	1.130	0.384	12.35	0.7784	77.5	Total	1.329	0.456	14.15	1.3073	77.5

* NASw-738, Study of the Normal Fecal Bacterial Flora of Man, Office of Space Sciences, NASA, Washington, D. C.
 ** Function unknown

TABLE 51. AMINO ACID DECARBOXYLASE SCREENING TESTS IN VITRO

Predominating Type Culture	Lysine	Histidine	Tyrosine	Arginine	Predominating Type Culture	Lysine	Histidine	Tyrosine	Arginine
*NASw-738					Exp. VII				
FA-1	0	+	+	+	FA-10	+	+	+	+
FA-15	0	0	0	+	FA-15	0	0	0	+
FA-3	+	+	+	+	FA-3	+	+	+	+
FA-5	0	0	0	0	GD-6**	+	+	+	+
FA-12	+	+	+	+	FA-14	+	+	+	+
FA-6	0	0	0	0	GD-3**				
Total	2	3	3	4	Total	3	3	3	4
Exp. V					Exp. VIII				
FA-15	0	0	0	+	FA-15	0	0	0	+
FA-3	+	+	+	+	FA-18**	0	0	0	0
FA-1	0	+	+	+	FA-5	+	+	+	+
FA-18**					FA-12	0	0	0	0
FA-6	0	0	0	0	FA-17**	0	0	0	0
FA-9	+	+	+	+	FA-1	0	0	0	0
Total	2	3	3	4	Total	1	2	2	3
Exp. VI					Exp. IX				
FA-15	0	0	0	+	FA-12	+	+	+	+
FA-3	+	+	+	+	FA-1**	+	+	+	+
FA-7	0	+	+	+	FA-9	0	0	0	0
FA-1	0	+	+	+	FA-15	+	+	+	+
FA-8	0	+	+	0	FA-3	0	0	0	0
FA-14	+	+	+	+	FA-7	0	0	0	0
Total	2	5	5	5	Total	3	4	4	5

*"Study of the Normal Fecal Bacterial Flora of Man, NASw-738, Office of Space Sciences, NASA, Washington
 ** Function unknown

**TABLE 52. EFFECT OF PREDOMINATING FECAL ANAEROBES
ON GERMFREE RATS***

Type Culture	3-Wk. Body Wt. Gain (gm)	Cecum as % of Body Wt.	Plasma Cholesterol mg/100 ml	Liver Cholesterol mg/100 g
Germfree	74	7.1	95	2.52
FA-1	95	6.8	97	2.78
FA-9	80	6.2	124	3.26
FA-13	98	5.6	99	2.16
FA-15	91	5.1	158	2.64
Germfree	83	7.1	88	
Cecum organism	101	2.4	78	
FA-1, 9, 13, 15	83	6.6	95	
FA-13 and L. acidophilus	77	6.1	73	
FA-13 and contaminant	87	7.3	71	
L. acidophilus	90	7.3	74	
Germfree	91	7.1	100	
FA-3	94	5.3	102	
FA-5	93	5.7	94	
FA-10	83	6.3	96	
L. acidophilus and L. bulgarius	88	6.3	101	
L. ATC 332	86	5.2	104	
Germfree	-	6.3		
Cecum organism	-	2.8		
FA-3	86	5.0		
GD-2	68	7.2		
GD-7	62	5.7		

* Results obtained under NASA contract NASw-738, "Study of the Normal Fecal Bacterial Flora of Man."

TABLE 53. SENSITIVITY OF EIGHTEEN ANAEROBIC TYPE CULTURES TO VARIOUS ANTIBIOTICS*

Anaerobic Type Culture	Antibiotics									
	Penbritin 10 mcg.	Unipen 1 mcg.	Lincoln 2 mcg.	Novobiocin 5 mcg.	Neomycin 5 mcg.	Erythromycin 2 mcg.	Chloromycetin 5 mcg.	Tetracycline 5 mcg.		
FA-1	GA	0	0	0	0	0	0	0		
	BP	0	0	0	0	0	0	0		
FA-2	GA	+	+	+	+	+	+	+		
	BP	+	+	+	+	+	+	+		
FA-3	GA	0	0	0	0	0	0	0		
	BP	0	0	0	0	0	0	0		
FA-4	GA	+	+	+	+	+	+	+		
	BP	+	+	+	+	+	+	+		
FA-5	GA	+	+	+	+	+	+	+		
	BP	+	+	+	+	+	+	+		
FA-6	GA	0	0	0	0	0	0	0		
	BP	0	0	0	0	0	0	0		
FA-7	GA	0	0	0	0	0	0	0		
	BP	0	0	0	0	0	0	0		
FA-8	GA	0	0	0	0	0	0	0		
	BP	+	-	+	+	+	+	+		
FA-9	GA	0	0	0	0	0	0	0		
	BP	-	-	-	-	-	-	-		
FA-10	GA	0	0	0	0	0	0	0		
	BP	+	+	+	+	+	+	+		

GA = Gall's agar without cysteine * Results obtained under NASA contract NASw-738, "Study of the
BP = Blood agar plate Normal Fecal Bacterial Flora of Man."
0 = no growth
+ = Sensitive
- = Not sensitive

TABLE 53 --- Concluded

Anaerobic Type Culture	Antibiotics							
	Penbritin 10 mcg.	Unipen 1 mcg.	Lincoicin 2 mcg.	Novobiocin 5 mcg.	Neomycin 5 mcg.	Erythromycin 2 mcg.	Chloromycetin 5 mcg.	Tetracycline 5 mcg.
FA-11	+	+	+	+	+	+	+	+
FA-12	0	0	0	0	0	0	0	0
FA-13	0	0	0	0	0	0	0	0
FA-14	+	+	+	+	+	+	+	+
FA-15	+	-	+	+	-	+	+	+
FA-16	+	+	+	+	+	+	+	+

GA = Gall's agar without cysteine
 BP = Blood agar plate
 0 = no growth
 + = Sensitive
 - = Not sensitive

TABLE 54. ANAEROBIC MICROBIAL PROFILE OF SUBJECTS

	Sampling Period															
	1	2	3	4	5	6	7	8	9	10	11	12	13	14	15	16
Body Area																
Eye												Und. ob. An.				
Nose																
Mouth	Strep. Vedd.															
Throat	PS2, PSI(2)		Und. fac. An. Strep. PSI	Strep. PS2, PSI, FA15		PS1, Strep. Vedd.	Strep. PS3, Und. ob. An.			Strep.		PS2				
Axilla																
Genit		Unden. fac. An.														
Glans penis	FA1, FN1															
Anal fold		FA12, GD3, FA3				Und. ob. An.	Und. ob. An. FA10				FA3, FA14, FN3	Und. ob. An. FA15, FA17				
Feces	FA1, 2, 4, 6, 8, 10, 11, 12, 13, 14, 15, 16, 17, 18 GD3, 6, 7, 18 9, 4, 5, 2 unk fac: 1 enterp coct	FA3, 6, 7, 13, 18 GD7	FA3, 6, 16:	FA3, 8, 17, 18	FA1, 2, 3, 5, 9, 15, 18, GD 4, 6, 1 unk. ob: FN2	FA1, 3, 6, 9; FN4; Lacto.	FA1, 3, 8, 18	FA1, 3, 6, 9, FA10	FA1, 3, 6, 9, 18; GD4, 6	FA2, 12, 15, 9, 14, 18; GD6	FA2, 3, 6, 8, 9, 14, 18; GD3					

strep = streptococcus
 V or Vedd = yeallonella
 unk = unkeyed
 Undent. = unidentified
 fac = facultative
 ob = obligate
 an = anaerobic
 Lacto = Lactobacillus
 Clostr = Clostridium
 P = Peptococcus

Subject 17

TABLE 54 --- Continued

Subject 16

Body Area	Sampling Period															
	1	2	3	4	5	6	7	8	9	10	11	12	13	14	15	16
Eye																
Nose																
Mouth	P81	P81, P82														
Throat	P81, P82					Strep. P82	Strep. P82, Veill. Unid. ob. an.			Veill.	P81, Strep. Unid. fac. An.	Lacto.				
Axilla																
Groin																
Glans penis																
Anal fold								FN 2			FA 10			FN 6		
Feces	FAS, 4, 14, 15; FNS	FAS, 18; GD-6; 1 unk. ob. 1 unk. fac.	FAS, 15	FAS, 5, 14, 15; 1 unk. ob	FAS, 5, 6, 12, 13, 15; FN4	FAS, 10, 18	FAS, 6, 9; GD5; FN1, F	FAS, 9, 15 GD6; FN4; 1 Lacto; #Micrococci	FAS, 13, 14, 15, 16; FNS	FAS, 13, 13; FN2, 4; 1 gastroco- col						

TABLE 54 --- Continued

Subject 19

Body Area	Sampling Period															
	1	2	3	4	5	6	7	8	9	10	11	12	13	14	15	16
Eye																
Nose																
Mouth			PS 1, Strep.													
Throat		Strep. PS 1 PS1, PS8	Udd. fac. An. Strep.							FluStrep	PS1, Strep. Udd. fac. An.	Lacto				
Arilla																
Croin																
Clans penis																
Anal fold			FA15, FA3	FN 4,			FA-6	FA-6					Udd. Oh. An. FA15, FA5			FN-4
Feces	FA3, PS, FN 1; 15, 15, 086; FN2, 3, 4, 5; 1 unk. Ind. 1 Enterococci	FA1, 3, 6, 18; GD7, Lacto; FN 4,	FA1, 3, 6, 15, 15; GD7, Lacto; FN 4,	FA17, GDA; 15, 15, 087; Lacto, FN4	FA1, 3, 6, 15; 15, 15, 087; Lacto, FN4	FA3, 5, 8, 10, 14; GDA	FA3, 5, 8, 10, 14; GDA	FA3, 5, 8, 10, 14; GDA	FA3, 5, 8, 10, 14; GDA	FA3, 5, 8, 10, 14; GDA, 6;	FA3, 5, 8, 10, 14; GDA, 6;					

NOTE: - FN2 cultured from forearm in sampling period 2.
Vibronella cultured from Umbilicus in sampling period 2.

TABLE 54 --- Continued

Subject 20

Body Area	Sampling Period															
	1	2	3	4	5	6	7	8	9	10	11	12	13	14	15	16
Eye			Strep.													
Nose																
Mouth	PSI, PSS	Strep; PSS														
Throat	Strep, PSS	Strep		Strep; Lacto	PSS,	Vall.					Strep. undent. fac. An.					
Axilla																
Groin																
Glans penis			Vell.	Strep.												
Anal fold			FA17, FA13	FA17, FA13	FA3,	FA17, FA13				FA-15						
Feces	FA3, 4, 14, 16; FN 5; 1 unk. ob	FA 1, 5, 15; 18; GDM; 1 unk. ob	FA 1, 3, 7; FA 6, 9, 14, 15;	FA 3, 5, 12, FA 2, 6, 8; 9, 9, 12; 15; GDM; FN1; 1 Enterococ	FA 3, 5, 12, FA 2, 6, 8; 15, 18; GDM	FA 1, 2, 3, FA 1, 3, 9, 8, 9, 12; 15; GDM; FN1; 1 Enterococ	FA 1, 3, FA 1, 3, 9, 13, 14, 16; 13, 14; FN2; GDM; FN 4, 5;									

NOTE: PSS isolated in the umbilicus in sampling period 4.

TABLE 54 --- Continued

Subject 21

Body Area	Sampling Period																	
	1	2	3	4	5	6	7	8	9	10	11	12	13	14	15	16	17	18
Eye																		
Nose																		
Mouth	PS2	PS2		PS2				Strep.	Lacto.									
Throat		Strep.	PS3		Strep.	PS1		PS1										
Axilla																		
Groin																		
Glans penis																		
Anal fold	FN 4, Clostr.																	
Feces	FA1,3,14, 15,18; 2 unk. ob. FN2,4; 1 unk. ob.	FA14,15, 18; FN2	FA15, 17	FA3,11,14, 15,17; 1 unk. ob.		FA14,17,18; GD4	1 unk. ob.	FA3,8,18 1 unk. ob.	FA5,17,18; 1 unk. ob.	FA1,8,14, 15,18	FA8,14, 15, FN4	FA1,8,9, 14,15	FA8,15 2 unk. ob.	FA 8, 15				

TABLE 54 --- Continued

Subject: 22

Body Area	Sampling Period															
	1	2	3	4	5	6	7	8	9	10	11	12	13	14	15	16
Eye																
Nose																
Mouth	PSI, Veill. #resp.		V; PSI	Resp.					PS 1				Lacto			
Throat	Veill.	Lacto.		Veill.	Veill.											
Arilla																
Groin																
Glans penis																
Anal fold																
Feces	FA 15; GDS 2 unk. ob.	FA 1, 16;	FA 1, 3, 7, 10, 18;	FA 8, 18 1 unkeyed ob. 1 unkeyed Frac.	FA 1, 3, 13	FA 3, 16, 17;	FA 5, 16, 17;	FA 3, 13;	FA 13, 15; 1 unk. ob.	FA 3, 14; 1 unk. ob;	FA 5, 6, 14, 16; 1 unk. ob.	FA 7; 1 unk. ob;	FA 7, 8, 13 16;	FA 7;		

TABLE 54 --- Continued

Subject 88

Body Area	Sampling Period															
	1	2	3	4	5	6	7	8	9	10	11	12	13	14	15	16
Eye																
Nose																
Mouth	Laoto			Scrap.	P80		P81					P81				
Throat	V, Scrap.			Scrap.	Scrap. i. V.				Laoto Unid. Rod							
Arilla																
Groin																
Glass penis										Unid. An. cecsi				Laoto		Unid. An. cecsi
Anal fold																
Feces	FAB, 15	FAB, 15	FAL, 8, 14	FAG, 141 FV8	FA 5, 6	FAL, 6, 14, 1513 unid. ob.	FAG, 14, 15 1 unid. ob. 1 unid. fer.	FAG, 15, 17, 18 1 unid. ob. 1 unid. fer.	FA 14, 15, 17	FA 5, 10, 18	FAL, 8, 15 1 entero- pocci	FAL, 5, 6 GEM/PNG	FAB, 15 G28	FA 1, 7, 8		

TABLE 54 --- Continued

Subject 24

Body Area	Sampling Period															
	1	2	3	4	5	6	7	8	9	10	11	12	13	14	15	16
Eye																
Nose																
Mouth			V.	Strep.						Strep.				PSB		
Throat			V.	V.	Strep.			V; Unid. rod								
Axilla																
Groin	FA 3															
Glans penis																
Anal fold			FA 3													
Feces	FA15, 18	FA3, 7	FA3, 6, 15, 16	FA 3, 14; 1 unk ob.	FA 1, 3, 6, 7	FA1, 3, GD6 1 unk. ob.	FA1, 3, 6, 17; GD 6	No sample	FA 7, 15	FA7, 15	FA3, 7, 15	No sample	FA3, 7; GD 6	FA 7		

TABLE 54 --- Continued

Subject 28

Body Area	Sampling Period															
	1	2	3	4	5	6	7	8	9	10	11	12	13	14	15	16
Ear	Unid. Fac. Ab.	Unid. Fac. Ab.		Unid. Anser. Cocci Unid. Cocci bac												
Nose	Peptococcus				Peptococcus											
Mouth	Lacto.	Lacto. Sphaerophoria		Lacto. Veillonella	Peptostrep. M. sp. Lacto. Veillonella(2) FA8, FA9, FA10		Veillonella(2) Unid.									
Throat					Veillonella Bififormis Peptococcus Aerogenes											
Axilla																
Groin																
Glans penis												Unid.				
Anal fold																
Feces	GD6;	FA8, 10, 17, 18; GD6, 6	FA8, 17;	FA15; GD3	FA10, 15, 17, 18; GD6	FA9, 10, 14; GD6;	FA5, 10, 18; GD8, 6;	FA8, 17, 18; GD8, 6;	FA8, 18; GD8, 6; #2 unk. ob;	FA9, 10; 1 unk. ob;	FA8, 7, 14, 15; #2 unk. ob;	FA10, 15; FNS;	FA10, 15; FNS;	FA3, 10, 16, 17; GD6;		

* Satellite colonies mixed curved rod and diplococcus

TABLE 54 --- Continued

TABLE 54 --- Continued
Subject 28

Body Area	Sampling Period															
	1	2	3	4	5	6	7	8	9	10	11	12	13	14	15	16
Eye																
Nose	Peptococcus Aerobius															
Mouth		Fusobacterium Nucleatum			Fusobacterium Polymorphum						Fusobacterium Polymorphum					
Throat		Veillonella(2)		Veillonella			Veillonella			Fusobacterium Fesuum Fusobacterium Nucleatum			Lacto.	Veillonella		Fusobact. Vesuum
Axilla																
Groin																
Glans penis																
Anal fold																
Feces	FA5,14;GD6; 1 unk.ob;	FA10,12; FA10,12; GD6; 1 unk.ob;	FA8,12; GD6; 1 unk.ob;	FA8,12;	FA10,12; GD3;	FA5,8,10,14; GD6;	FA10;GD3; 1 unk.fac;	FA10;GD3; 1 unk.ob;	FA10;GD6; 1 unk.ob;	FA2,10,17; GD3; 1 unk.ob;	FA3,10,12,17; FA10,12,15,17; GD3;		FA3,12; GD3;	FA3,10,12; GD3;		

TABLE 54 ---- Continued

Subject 27

Body Area	Sampling Period															
	1	2	3	4	5	6	7	8	9	10	11	12	13	14	15	16
Eye																
Nose																
Mouth				Vellionella												
Throat				Vellionella									Vellionella			
Axilla																
Groin							Peptococcus Niger									
Glans penis				Vellionella												
Anal fold				Peptococcus anserotus												
Feces		FA5, 8, 15; FN5	FN 4, 5;	FA10, 15; EN5;	FA3, GD8; 1 unkl. ob; FN 4, 5;	FA 14; 1 unkl. ob; 1 unkl. fac;	FA12; FN4; 4 unkl. ob;	FA18; GD8;	FA17;	FA 17;	FA 9, 17;	1 unkl. fac;	FA6, 14, 15; GD6;	FA6, 15, 17; 16;		

NOTE: - Vellionella Reaiformis cultured from umbilicus in sampling period 1.

TABLE 54 --- Continued

Subject 28

Body Area	Sampling Period															
	1	2	3	4	5	6	7	8	9	10	11	12	13	14	15	16
Eye																
Nose	<i>Psychococcus Ascarabola</i>															
Mouth																
Throat			<i>Fusobacterium</i> <i>Polymorphum</i> <i>Vedionella</i>	<i>Fusobacterium</i> <i>Polymorphum</i> <i>Vedionella</i>	<i>Vedionella</i>	<i>Vedionella</i>			<i>Fusobacterium</i> <i>Polymorphum</i> (8)						<i>Undeent.</i> <i>Strep.</i>	
Acilia																
Crotch																
Glans penis																
Anal fold																
Penis	<i>FAS, P, 14, 17</i>	<i>FAS, 15</i>	<i>FAS, 4, 5, 10</i>	<i>FN 4</i>	<i>FAS, 14</i> <i>FN 1</i>	<i>FAS, 5, 6, 10</i>	<i>FAS, 15</i>	<i>EDS</i> <i>1 wk. ob</i>	<i>FAL</i> <i>1 wk. ob</i>	<i>FAS, 7, 14, 15</i> <i>CD 8</i>	<i>FAL, 5, 6, 17</i>	<i>FAS, 14</i>	<i>FAL, 6, 10, 13</i>	<i>FAL, 6, 13, 16</i>		

TABLE 54 --- Continued

Subject 29

Body Area	Sampling Period																
	1	2	3	4	5	6	7	8	9	10	11	12	13	14	15	16	
Eye																	
Nose																	
Mouth				Veillonella	Veillonella; FNS		Veillonella S. faecalis										
Throat																	
Axilla																	
Groin																	
Glass penis													FAS				
Anal fold																	
Feces	FAS, 10; 15, 17, 18; 1 unk. ob. 1 unk. so.	FAS, 6, 9 10, 11, 12, 15; 1 unk. ob. 1 unk. so.	FAS, 9; GDS, 4; 1 unk. ob. 1 unk. so.	FAS, 17; GDS, 6; 1 unk. so.	FAS, 14; FAS, 14	FAS, 15, 17; FAS, 15, 17; 2 unk. so. 2 Lacto 1 E. coli	FAS, 11, 14, 15; FAS, 15, 17; 1 Pepsococcus 2 unk. so. 1 Lacto 1 E. coli	FAS, 15, 16; 18; GDS, 2; 1 E. coli	FAS, 15, 16; 17, 18; 1 unk. so.	FAS, 9, 11, 17, 18; 1 unk. so.	FAS, 9, 12, 17; 1 GDS, 4 1 unk.	FAS; 1 unk. so.	FAS, 9; GDS, 5A 1 unk. ob.				

* Possible Clostridium sp.

TABLE 54 ---- Continued

Subject 30

Body Area	Sampling Period															
	1	2	3	4	5	6	7	8	9	10	11	12	13	14	15	16
Eye																
Nose																
Mouth		Vedionella					Vedionella	Peptostreptococcus Micros V. (2)								
Throat																
Axilla																
Groin																
Glans penis																
Anal fold	Unid. Fac. Anal Fusobacterium Præcutum				FA 5											
Feces	FA 9, 15; 1 unk. ob(6)	FA 15; 1 unk. ob. (4)	FA 3, 6; CD6; 2 unk. ob. (6)	FA 1, 5, 15, 16; 18; 2 unk. ob. (3); 1(4) 1 unk. fac. (1)	FA 5, 12, 14, 15; 2 unk. ob. (2); 1(7)	FA 5, 9, 18; CD 1, 6; 1 unk. ob. (4) 1 unk. fac.	No slides	FA 2, 14, 15, 18; 1 unk. ob. (4) FN 3, 4; 1 unk. fac.	FA 8, 15; 1 unk. ob. (2) 1 unk. fac. (1) 1 Miscell. (2)	FA 8, 15; 3 unk. fac.	FA 14, 15, 18; GD 1; 1 unk. ob. (8); 1 unk. ob. (3)	FA 3, 15, 16; 18; GD7; 1 unk. ob. (3)	FA 5, 11, 12, 14, 18; 1 unk. ob(6)			

(1) P82
 (2) Peptostreptococcus Morbillorum
 (3) Sphaerophorus Rikuloosus
 (4) Peptococcus Sp.
 (5) Vibrio Spatum
 (6) Peptostreptococcus Parvulus
 (7) Vermiform

TABLE 54 --- Continued

Subject 31

Body Area	Sampling Period															
	1	2	3	4	5	6	7	8	9	10	11	12	13	14	15	16
Eye																
Nose																
Mouth	Sphaerophorus varius	Unid. Fac. An.							V.							
Throat									V.							
Axilla																
Groin																
Glans penis																
Anal fold																
Feces	FA15, 17; 1 unk. ob.	FA1, 9, 12, 13; FA10, 15, 18; FN 4 1 unk. fac(1)	FA10, 15, 18; FN 4 1 unk. fac(1)	FA15, 18; GD 2 2 unk. ob. 1(3) FN 1, 4, 1(4) 1 unk. fac. (1)	FA1, 14, 15, 16; 18; GD 2 1 unk. ob(2) FN 4	FA15, 16, 18; 1 unk. ob (4) FN 4	FA18; FN 6; 16, 18; 1 unk. ob(4) 3 unk. fac.	FA3, 5, 6, 9, 15; 16, 18; 1 unk. ob(4) 3 unk. fac.	FA14, 15, 18; 1 unk. ob(4) FN 5; 1 unk. fac.	FA15, 16; GD 1; 2 unk. ob.	FA14, 15, 16; GD 7; 1 unk. ob(2)	FA2, 12, 15, 16, 18; GD 2;	FA12, 15, 17, 18; 1 unk. ob(2)			

(1) FS 2
 (2) Peptonostreptococcus Lanceoblitus
 (3) Sarcobacter
 (4) Peptococci

TABLE 54 --- Continued

Subject 32

Body Area	Sampling Period															
	1	2	3	4	5	6	7	8	9	10	11	12	13	14	15	16
Eye																
Nose																
Mouth			V. (2)			V. (2)	V. (2)	V.							Strip. (Fwd An.) V.	V. Unid. An Strip.
Throat								V. (2)								
Axilla																
Groin																
Glass penis	V.															
Anal fold																
Feces	FAS 18; GD 2, 6;	FAS 14, 15; 17; 18; 2 unsk. ob.	FAS 18(GD); 1 unsk. ob.	FAS 12, 13, 18; FN 6;	FAS 7, 12, 14, 15; 16(GD); FRS;	FAS 5, 12, 15; 18; 1 unsk. ob(1); FRS;	FAS 7, 15; 17; 18; 1 unsk. ob(2); 1 unsk. fec.	FAS 12, 15, 18; 18; 1 unsk. fec.	FAS 9, 16; 18; 1 unsk. ob.	FAS 12, 15; 18; 1 unsk. ob.	FAS 12, 15; 18; 1 unsk. ob.	FAS 12, 15; GD 2, 6;	FAS 8, 15; 17, 18;	FAS 3, 5, 10; 18;		

(1) Sphaerococcus Sp.
(2) Peptococcus

TABLE 54 --- Continued

Subject 33

Body Area	Sampling Period															
	1	2	3	4	5	6	7	8	9	10	11	12	13	14	15	16
Eye																
Nose																
Gingival	Contam. of Bacillus Group															
Throat																
Axilla																
Groin																
Glans penis		Pepto- strepto- cocci Micros.														
Anal fold																
Feces	FA3, 4, 12, 17; 1 unk. fac. Lacto Miscell. (3)	GDI, 2, GDEA	FAB;	FA2, 12, 17; 1 Lacto	FA9, 11; 1 unk. ob. 1 enterococci	FA 11; 1 unk. ob. (3)	FA12, 15, 16; 2 Enterococci	FA12/GD4; 1 unk. ob. (1)	FA7, 12; 1 Lacto	FA12; 1 unk. ob. 1 unk. fac.	FA9, 12, 16; 3 unk. fac.	FA 15; FD 9; 3 unk. ob. 2(3)				

(1) Peptococcus griseovirens
(2) Fusobacterium sp.
(3) Peptostreptococcus

TABLE 54 --- Continued

Subject 34

Body Area	Sampling Period															
	1	2	3	4	5	6	7	8	9	10	11	12	13	14	15	16
Eye																
Nose						Peptostreptococcus Asaccharobius										
Mouth																
Throat																
Axilla							Lactobacillus									
Groin	Peptococcus Prevotii															
Glans penis																
Anal fold																
Feces	FA7,8,12; GD1; 2 unk. ob. (2)	FA1,12; 1 unk. ob. (5)	FA9; 3 unk. ob. (4) (5) 1(U) 1 unk. fac.	2 unk. ob. (2)	FA3,15; GD6;	FA9,12; GD 1,3;	FA12;	FA3,9,12,15; 1 unk. fac.	FA3,9,12, 16; 1 unk. ob. (2)	FA12; GD; 1 unk. ob. (2)	FA12; GD1; 1 unk. fac.					

(1) Peptostreptococcus Parvulus
 (2) Peptococcus Sp.
 (3) FS 2
 (4) Peptostreptococcus Productilis
 (5) Peptostreptococcus Micros

TABLE 54 ---- Continued

Subject 35

Body Area	Sampling Period															
	1	2	3	4	5	6	7	8	9	10	11	12	13	14	15	16
Eye																
Nose																
Gingival		PS 1														
Throat		PS 1					Eubacterium Sp.									
Axilla																
Groin																
Glans penis																
Anal fold																
Feces	FA 3, 7, 12, 14; GD 1; 1 unk. ob(2)	FA 18; GD 1; 1 unk. ob(2)	FA 3, 17; GD 1;	FA 15;	FA 3, 12, 16; 2 unk. ob. 1(1)	FA 5, 8; GD 5; 1 unk. fac	FA 6, 9; 1 unk. ob.	GD 1, 7; 1 unk. ob. 2 unk. ob. (4)		3 unk. ob.	FA 1, 8; GD 3;	FA 8; GD 1, 5;				

(1) Lactobacillaceae Sp. (3) Fusobacterium Sp.
 (2) Peptococcus Aerogenae (4) Peptostreptococcus Sp.

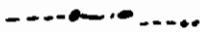
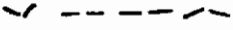



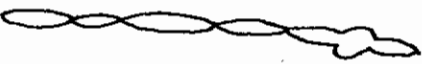





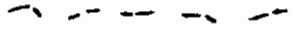







TABLE 54 --- Concluded

Subject 36

Body Area	Sampling Period															
	1	2	3	4	5	6	7	8	9	10	11	12	13	14	15	16
Eye																
Nose																
Mouth																
Throat																
Axilla							Pepto (1)									
Groin																
Glass penis																
Anal fold																
Feces	FA 17; 2 unk.ob. (6) 1 unk.ob. 3 miscell. (6)	FA 7,14; 3 unk.fac.	FA 12,15; 1 unk.ob. 2 unk.ob.(2) 1 unk.fac.	FA3,11,14; 2 unk.ob(4) 3 unk.fac.	FA 10; CD 3;	1 unk.ob. 1 miscell. (7)	FA 12; FN 1; 3 Lacto. 2 Enterococci	1 unk.ob. (1) 1 unk.ob. (3) 4 miscell. (3)	FA 15; CD 7; FN 5;	FA 4,17; 3 Lacto.	FA 12,13; 3 miscell.(1)1 unk.fac.	FA 12,15; 3 miscell.(1)1 unk.fac.				

(1) Peptostreptococcus Sp. (4) Lactobacilli
 (2) Peptostreptococcus Productus (5) FS 3
 (3) Micrococaceae (6) Fusobacterium Sp.

**TABLE 55. MORPHOLOGICAL TYPES OF ORGANISMS
RECOVERED FROM THE ANAEROBIC SERIES**

- A. Gram ± short rods in pairs short chains
sometimes with coccoid swellings 
- B. Gram ± short to medium slender rods singly and in pairs 
- C. Gram ± large lanceolate cocci chains 
- D. Gram ± large fat rods or cocci in pairs 
- E. Gram ± medium pleo rods in pairs many forms,
always shows pleomorphixm 
- G. Gram ± pointed rods, longer than C,
sometimes shows central swelling 
- I. Gram ± elongated cocci pairs and chains strep 
- J. Gram - short fat rods - coli 
- K. Gram ± medium rods singly, pairs and rafts
no pleomorphism 
- L. Gram ± long threadlike often irregular staining 
- M. Gram ± long rods, thicker than L
sometimes shows banded staining 
- N. Gram + medium reg. rods (like C. welchii) 
- O. Gram ± rods larger than A. 
- P. Gram + micrococcus 
- Q. Gram - medium rod pairs slightly curved 
- R. Gram ± very large cocci pairs 
- S. Gram - slender curve rod 
- T. Gram + very large fat rod 
- U. Gram ± medium rods in pairs may be same as K. 
- V. Gram - short fat rods in chains 

- AA. Anaerobic vibrios
- BB. Bacteroides
- CC. Cocco-bacillus in chains; usually pleomorphic
- DD. Disk-like cocci in chains
- FF. Fusobacterium
- GG. Neisseria
- MM. Medium gram variable cocci, paired, short chains and clusters
- NN. Neisseria-like cocci in chains
- OO. Lactobacillus
- PP. Pointed rod - very small, in pairs, chains, groups and singly
- RR. Peptococcus
- SS. Streptococci
- TT. Streptobacillus moniliformis
- VV. Veillonella

TABLE 56. DISTRIBUTION OF ORGANISMS ON SLIDES OF ANAEROBIC THROAT, MOUTH, GINGIVAL SERIES

ANAEROBIC THROAT SERIES

Sampling Period	Subject			
	17	18	19	20
1		VV, J, I, P	I	I, VV, G, P, TT
2	slides not available	slides not available	slides not available	slides not available
3	I, TT, G	I, J	G, GG, I, VV, J	I, VV, GG, TT
4	G, TT, VV	G, I, TT, VV	I, TT, VV	I, VV
5	I	GG	GG, I, G, S	O, I, GG, L, G, VV, E
6	I, L	long pleomorphic rods, RR, L, I, G	I, G, TT, VV	G, I, VV
7	VV, I, L, J	I, L, S, VV	I, G, VV	I, L, VV
8	E, I, G, VV	Gram positive slender rod, I, VV, GG	I, G, L, VV	I, P, VV
9	I, L, J, G, VV	I, J, L, GG	VV, I, J, GG, G, L	I, L, G, J, VV
10	GG, I, J, VV, G, L	G, VV, I, GG, TT	G, VV, I, Vincents spirochetes	I, G, TT
11	I, G, L, VV	G, VV, I, GG, TT	G, I, Vincents	I, VV, GG
12	I, G, L, VV	G, I, VV, GG, TT	I, G, VV	I, GG
13	I, VV, TT	I	I, VV, GG	I, VV, GG
14				

	25	26	27	28
5	I, VV, BB and/or FF	I, C, P, VV, FF and/or BB	I, BB, VV, GG, C	I, VV, FF, GG
6	I, VV, BB	I, FF, BB, P, VV, OO	I, BB, P, VV, GG	I, GG, C, VV, BB and/or FF
7	I, VV, FF, P	I, FF, GG, VV, P	I, VV, C, GG, FF	I, VV, fusiform
8	I, FF, GG, VV			

ANAEROBIC MOUTH SERIES

Sampling Period	Subject			
	29	30	31	32
1	AA, BB, L, FF, pale crescents SS, PP, VV	AA, BB, CC, FF, PP, SS, VV, G, L	AA, BB, FF, L, SS, VV, PP	DD, L, MM, PP, SS, VV
2	AA, BB, L, SS, MM, PP, VV	AA, BB, CC, FF, L, PP, SS, VV,	BB, FF, L, SS, VV, pale crescents	BB, DD, FF, L, PP, SS, VV
3	BB, CC, L, PP, SS, VV	AA, BB, FF, L, PP, SS, VV	BB, L, SS, VV, pale crescents	BB, DD, FF, L, SS, VV
4	AA, BB, L, PP, SS, VV	BB, CC, L, PP, SS, VV, Pale crescents	BB, FF, MM, PP, SS, VV	BB, CC, DD, FF, L, MM, PP, SS,
5	CC, SS, unclear smear	AA, BB, FF, L, MM, PP, SS, VV	BB, L, SS, unclear slide	BB, L, SS, VV, unclear slide
6	CC, MM, SS, VV	no slide	VV, L, PP, SS, VV, G	BB, DD, FF, SS, MM, GG, G, RR
7	AA, BB, CC, L, MM, PP, VV,	AA, BB, DD, L, PP, SS, VV, GG	AA, BB, L, PP, SS, VV	BB, DD, L, PP, SS, VV, GG
8	AA, BB, CC, PP, L, SS, VV	AA, BB, SS, VV, L	BB, DD, PP, SS, L, VV	BB, L, PP, SS, VV, bi-polar rods
9	BB, L, PP, SS, VV	AA, BB, DD, FF, L, SS, VV	BB, DD, L, SS, VV	AA, CC, L, PP, SS, VV
10	BB, L, SS, VV	AA, L, MM, PP, SS, VV, GG	AA, BB, L, SS, VV	AA, BB, DD, L, SS, VV
11	L, SS, VV, fungus	VV, RR, branching filaments with spores	L, SS, VV	AA, BB, FF, L, SS, VV
12	SS, VV	AA, L, SS, VV, GG	AA, FF, L, SS, VV, RR	FF, L, SS, VV
13	AA, BB, CC, FF, PP, VV	AA, FF, L, PP, SS, VV, GG, Sarcina	AA, SS, VV, med. bi-polar rods, GG	BB, CC, DD, FF, L, PP, SS, VV
14	GG, AA, BB, L, PP, SS, VV	AA, FF, L, SS, VV	L, SS, VV, unclear slide	CC, DD, FF, L, SS, VV

ANAEROBIC MOUTH SERIES (cont'd)

Sampling Period	Subject			
	29	30	31	32
15	AA, FF, L, MM, NN, PP, SS, VV,	AA, CC, L, PP, SS, VV	AA, FF, L, PP, SS, VV	AA, BB, CC, DD, FF, L, NN, SS, VV
16	BB, FF, L, PP, SS, VV	AA, BB, L, NN, PP, SS, VV, pale crescents	BB, DD, FF, L, NN, PP, SS, VV	AA, BB, DD, FF, L, PP, SS, VV

ANAEROBIC THROAT SERIES

1	BB, DD, L, MM, NN, VV, pale crescents	AA, BB, FF, L, MM, PP, SS, VV, pale crescents	AA, BB, FF, MM, L, PP, SS, VV, med. bi-polar rods	AA, BB, CC, DD, FF, L, MM, PP, SS, VV
2	AA, BB, DD, FF, L, NN, PP, SS, VV	AA, BB, CC, NN, L, PP, SS, VV, yeasts	AA, BB, DD, MM, L, PP, SS, VV, pale crescent	no slide
3	AA, BB, DD, MM, L, PP, SS, VV	AA, DD, SS, VV, L	BB, MM, PP, VV, L, SS	BB, DD, PP, SS, VV, pale crescents
4	BB, CC, SS, VV, L, med. thinrods in chains	AA, BB, MM, SS, L, VV, GG	AA, BB, MM, PP, L, SS, VV, med. bi-polar rods	BB, DD, PP, SS, VV, pale crescent
5	BB, DD, FF, MM, L, PP, SS, VV	DD, PP, SS	AA, DD, MM, PP, SS, VV	BB, PP, SS, VV, med bi-polar rods
6	BB, MM, SS, VV, L	AA, BB, MM, PP, L, SS, VV	BB, L, MM, SS, VV	AA, BB, DD, MM, L, SS, VV
7	AA, BB, MM, L, SS	AA, MM, unclear smear	AA, BB, FF, MM, L, SS, VV	AA, PP, SS, unclear smear
8	BB, L, MM, PP, SS, VV	AA, BB, MM, PP, SS, VV	AA, L, MM, SS, VV	AA, BB, MM, L, PP, SS, VV
9	BB, DD, L, MM, VV	AA, BB, L, MM, PP, SS, VV, pale crescent	BB, L, MM, SS, VV	AA, DD, L, PP, SS, VV
10	BB, L, MM, PP, SS, VV	BB, FF, L, MM, PP, SS, VV	BB, L, MM, SS, med bi-polar rods	BB, LL, SS, VV

TABLE 56 --- Continued

ANAEROBIC THROAT SERIES (cont'd)

Sampling Period	Subject			
	29	30	31	32
11	BB, FF, PP, L, SS, VV, GG, Sarcina	BB, L, SS, VV, RR,	AA, FF, L, SS, VV, RR, branching filaments	AA, FF, L, SS, VV, RR, GG
12	L, SS, VV	AA, FF, MM, SS, VV	AA, FF, L, MM, SS, VV	BB, FF, PP, SS, VV
13	AA, CC, PP, SS, VV, bi-polar rods	DD, SS, FF	AA, CC, L, MM, PP, SS, VV	AA, BB, CC, FF, L, VV, SS
14	BB, L, MM, SS, VV	AA, BB, CC, L, MM, SS, VV	BB, L, SS, VV	BB, L, MM, PP, SS, VV
15	BB, DD, FF, L, NN, SS, VV	AA, BB, L, SS, VV	AA, BB, CC, DD, L, MM, PP, SS, VV, GG	AA, BB, CC, DD, L, FF, MM, SS, NN, VV
16	AA, BB, L, PP, SS, VV	AA, BB, CC, L, NN, PP, SS, VV	AA, BB, DD, FF, L, MM, PP, SS, VV	AA, BB, L, NN, PP, SS, VV

	33	34	35	36
1	GG, VV, P, C, I, E, BB, FF, B, A, sm curved gm neg rod	L, GG, I, FF, B, K, E, pneumococci, curved bac, med sl gm pos & gm neg, tiny gm neg curved rod, BB, VV	VV, I, S, E, BB, FF, G, A	VV, FA1, B, S, L, FF, E, I, V, A, BB, GG, med gm neg & gm pos sl bac sl curved gm pos sl branching filaments
2	VV, A, C, I, L, E, gm neg variable tiny curved bac, BB, K, GG, long chains ovoid cocci or sh bac	VV, GG, L, BB, E, M, B, S, very tiny gm neg bac Haemophilus	VV, I, P, L, B, GG, OO, BB gm neg sl curved rods, vibrio, A, G	VV, I, C, L, B, E, sm gm pos bac sl curved FF, A
3	VV, P, K, C, I, GG yeasts, FF, BB, L, V, E, sm vibrio	very tiny gm neg bac, BB or FA8, VV, I, C, L, B, A, OO, P, GG, V	I, C, P,	gm pos sh bac ch, E, E, I, K, P, FA1, GG, BB, VV, L, OO
4			C, I, A, VV, FF, BB	

TABLE 56 --- Concluded

ANAEROBIC THROAT SERIES (cont'd)

Sampling Period				
	33	34	35	36
8	VV, P, K, GG, L, A, G, B, gm neg branching filament	BB, VV, O, P, I, E, U, L	GG, I, C	I, VV, FF, GG
9	VV, C, I, GG, yeasts	VV, I, V, K, L, GG, BB	I, K,	GG, VV, I, C,
10	GG, VV, I, C, P, L			I, C, A, GG, G, M,

ANAEROBIC GINGIVAL SERIES

1		I, L, B, VV, BB, round cocci in med ch, FF, GG, E	VV, L, C, I, K, FA8, BB, A, FF OO vibrio forms	VV, I, C, GG, L, FF, pneumococci prs, spirillum
2	VV, I, C, P, FF long chain strep	C, I, P	I, C, VV, P, E, U, round cocci in med ch, V, L, OO corynebacteria pneumococci gm pos sl pleo branching bac	V, C, I
3	VV, C, GG, strep round med ch, I	M, VV, I, L, FA1, round cocci ch B, O, BB, prs pneumococci gm neg bac= Haemophilus	VV, C, I, FF, BB, GG	VV, GG, C, I, L, FF, OO, gram negative variable tiny bac sl curved, K
8	I, VV, BB	VV, FF, I, C, A, BB, GG, L, E, K, A, lg ch strep	VV, C, I, A, P,	I, C, P, A
9	GG, VV, I, V, C	VV, I, GG, D, A, BB	unclear slide	C, A, I, BB, VV
10	GG, C, I	GG, BB, FF		

TABLE 57. MICROORGANISMS COMMONLY FOUND ON HEALTHY HUMAN BODY SURFACES* (8)

Species or group	Skin		Conjunctiva	Upper respiratory tract	Mouth		Lower Intestine		Genitourinary tract
	General	External auditory canal			Saliva-tooth surfaces	Gingival crevice	Feces	Adult	
A. Gram-positive cocci: Coagulase-negative staphylococci	88-100 2-6/cm ²	27-100	37-94	90	75-100 1-4/ml		+ 2-4/Gm		
Coagulase-positive staphylococci	5-24 ‡	12-20	0-30	22-85 9-100 ^a	+ (16-35)		++		
Anaerobic micrococci	±				+				
Str. mitis and undifferentiated α and γ streptococci									
Str. pyogenes (usually group A unless noted)	0-4		0.3-2.5	0.1-5	12-68 ^f 3-6/ml ^f		100 3-8/Gm 16 ^h		+
Anaerobic streptococci					++ 6/mg		+		+
D. pneumoniae		+	0-5	0-17 ^j	26				
B. Gram-negative cocci: N. catarrhalis and other spp.			2.3	12	95-100 5-7/ml				
V. alcalescens					100				

‡ Associated with nasal carriage
 § Per cent of strains isolated
 * Boldface values (e.g., 31-59) = range of incidence in per cent, rounded, in different surveys. Values given with units (e.g., 3-6/ml) = range of concentrations expressed as log 10:6 = 5 x 10⁵ 5 x 10⁶.
 † In infants and children; highest in hospital nursery infants
 ‡ Associated with presence in throat
 § More common below age 20
 ¶ Groups B, C, F, and G; no A
 †† More common in children

TABLE 57 --- Continued

Species or Group	Skin		Conjunctiva	Upper respiratory tract	Mouth		Lower intestine		Genitourinary tract
	General	External auditory canal			Saliva-tooth surfaces	Gingival crevice	Feces	Adult	
C. Gram-positive bacilli: Lactobacilli	53 5/cm ²	86	3-83	+	95 ^k 0-6/ml	59	60 ^k -7/Gm	6	External genitalia
Aerobic corynebacteria	45-100 6/cm ²	+	+	+	±	±	+	25-35 1-35	+
C. acnes	+	+	±	±	+	+	+	+	+
Mycobacteria Cl. perfringens, other spp. Cl. tetani	+	+	±	±	+	+	+	+	+
Actinomyces bifidus A. israelii Leptotrichia buccalis	+	+	±	±	+	+	+	+	+
L. dentium					0-3/ml	+			
D. Aerobic Gram-negative bacilli: Undifferentiated "coliforms"		4-8	2.1		65 0-3/ml		100 5-8/Gm		+
k Especially in dental caries									

Contrails

TABLE 57 --- Continued

Species or group	Skin		Conjunctiva	Upper respiratory tract	Mouth		Lower intestine	Genitourinary tract	
	General	External auditory canal			Nasal passages	Saliva-tooth surfaces			Gingival crevice
<p>D. Aerobic Gram-negative bacilli (cont.)</p> <p>Escherichia coli "Intermediates" Klebsiella aerogenes Proteus mirabilis, other spp.</p> <p>Pseudomonas aeruginosa Alcaligenes faecalis Vibrio alcaligenes Moraxella lacunata Mima polymorpha M. vaginalis Haemophilus influenzae H. parainfluenzae Hemolytic hemophili H. aegyptius H. vaginalis</p>	General	External auditory canal	Conjunctiva	Upper respiratory tract	Saliva-tooth surfaces	Gingival crevice	Feces	External genitalia	
		0.1-0.4 +	0.1-0.4 +	0.1 0.4		4.2 31 52		100 +	
		0.2-1	0.2-1					33-68 5-53 -6/Gm	
		0-1.3 1.1-1.6	0-1.3 1.1-1.6	±				3-11 +	
				±	+	±		±	±
				±				±	±
				0.4-25	12	25-100 25 +			
				+					

Contrails

TABLE 57 --- Concluded

	Skin			Upper respiratory tract	Mouth		Lower intestine		Genitourinary tract
	General	Feet	External auditory canal		Conjunctiva	Saliva-tooth surfaces	Gingival crevice	Feces	
E. Anaerobic Gram-negative bacilli, vibrios, spirilla, and spirochetes; PPLO, etc.: Bacteroides fragilis, other spp. B. nigrescens Fusobacterium fusiforme F. girans Spirillum sputigenum Vibrio sputorum Treponema dentium and Borrelia reirgens PPLO, etc.									
F. Fungi: Candida albicans Other candidas Torulopsis glabrata Ptyrosporium ovale P. orbiculare Dermatophytes									

q Especially scalp and nasal folds; also other skin areas.

TABLE 58. DISTRIBUTION OF MICRO-ORGANISMS IN VARIOUS CUTANEOUS HABITATS⁽⁸⁾

Habitat	Residents	Frequent visitors	Rare visitors
Surface of skin	Pediculus humanus Pityrosporum ovale Non-pigmented yeasts Staph. epidermidis Micrococcus spp. Corynebacterium spp. Mycobacterium smegmatis Treponema spp.	Pulex irritans Staph. aureus Gram negative bacilli Aerobic spore-formers	Aspergillus spp. Candida albicans Streptococcus spp. Neisseria spp.
Layers of stratum corneum	Staph. epidermidis Micrococcus spp. Corynebacterium spp.	Sarcoptes scabiei Dermatophytes Staph. aureus Strep. pyogenes	various mites Entamoeba histolytica Cladosporium wernecki Pityrosporum orbiculare Candida albicans Mycobacterium balnei B. Anthracis C. diphtheriae Pasteurella spp.
Malpighian layers of the epidermis	Herpesvirus hominis	Treponema pertense papova virus VZ. virus	Larval helminths Mycobacterium spp. Treponema carateum Poxvirus variolae and other spp.
Pilosebaceous unit	Demodex folliculorum Pityrosporum ovale Corynebacterium acnes Aerobic corynebacteria	Trichophyton spp. Microsporum spp. Staph. aureus	Microsporum gypseum Piedra spp. Corynebacterium tenuis
Eccrine sweat gland	-	Staph. epidermidis Staph. aureus	Pasteurella pestis Chromogenic bacteria
Dermis	-	Leishmania spp. Mycobacterium leprae	Dracunculus medinensis Larval helminths Cladosporium spp. Nocardia spp. Mycobacterium spp.

TABLE 59. DISTRIBUTION OF INDIGENOUS MICROORGANISMS IN MAN⁽⁷⁾

Organism	Mouth	Oro-pharynx	Naso-pharynx	Intestine	Skin	Eye	External Genitalia
α -streptococcus	1	1	tr	2	0	0	0
β -streptococcus	2	3	tr	2*	0	0	0
γ -streptococcus	2	2	tr	2	0	0	2
Anaerobic streptococcus	2	2	0	2	0	0	2
Pneumococcus	tr	3	tr	0	0	0	0
Staphylococcus epidermidis	tr	tr	3	2	1	2	2
Staphylococcus aureus	tr	tr	3	2	0	0	0
Other staphylococci	2	2	2	2	2	2	2
Corynebacterium †	1	1	1	0	1	1	2
Lactobacillus	2	0	0	2	0	0	0
Leptotrichia	1	0	0	0	0	0	0
Actinomyces	2	2	0	0	0	0	0
Bacteroides	2	0	0	1	0	0	0
Fusobacterium	1	0	0	2	0	0	2
Spirochetes	1	0	0	2	0	0	2
Anaerobic vibrios	1	0	0	0	0	0	0
Neisseria meningitidis	tr	3	3	0	0	0	0
Other neisseriae	tr	1	1	0	0	0	0
Veillonella ‡	1	2	0	0	0	0	0
Haemophilus	tr	3	3	0	0	0	0
Pleuropneumonia group §	2	2	0	0	0	0	2
Coliform bacteria	tr	0	0	1	tr	0	2
Proteus	0	0	0	2	0	0	2
Pseudomonas	0	0	0	2	0	0	2
Clostridium	0	0	0	2	0	0	0
Bacillus	tr	tr	tr	tr	tr	0	0
Mycobacterium	0	0	0	0	0	0	3
Yeasts	2	2	0	2	0	0	2
Protozoa	3	0	0	3	0	0	3

TABLE 59 --- Concluded

- 1 = Generally present and constitute a prominent fraction of the regional microbial flora.
- 2 = Generally present but constitute a minor fraction of the regional microbial flora.
- 3 = Carriers found frequently, in whom the organisms may constitute a prominent fraction of the regional microbial flora.
- tr = Often found, usually in small numbers, probably as a transient.
- 0 = If found, may be assumed to be a transient.
- * = Group D hemolytic enterococci.
- † = A very small proportion of the populace acts as the reservoir of diphtheria, owing to the persistence of *C diphtheriae* in the nasopharynx.
- ‡ = Incompletely studied.

REFERENCES

1. Schaedler, M.D., Russell W., Rene Dubos, Ph.D., and Richard Costello, Ph.D.: "Association of Germfree Mice with Bacteria Isolated from Normal Mice," J. of Exp. Med., 122, 77-87, 1965.
2. Bergeim, O., A.H. Hanszen, L. Pincussen, and E. Weiss: "Relation of Volatile Fatty Acids and Hydrogen Sulphide to Intestinal Flora," J. Infect. Dis., 69, 155-166, 1941.
3. Dubos, R. and R.W. Schaedler: "The Effect of the Intestinal Flora on the Growth Rate of Mice and on their Susceptibility to Experimental Infections," J. Exp. Med., 111, 407, 1960.
4. Dubos, R., R.W. Schaedler, Richard Costello and Philippe Hoet, M.D.: "Indigenous, Normal, and Autochthonous Flora of the Gastrointestinal Tract," J. of Exp. Med., 122, 67-76, 1965.
5. Atkinson, M. and J.C. Goligher: "Recurrent Hepatic Coma Treated by Colectomy and Ileorectal Anastomosis," Lancet, 1, 461-464, 1960.
6. Watson, E.D., N.J. Hoffman, R.W. Simmers, and T. Rosebury: "Aerobic and Anaerobic Bacterial Counts of Nasal Washings: Presence of Organisms resembling Corynebacterium acnes," J. Bact., 83, 144, 1962.
7. Rosebury, Theodor: Microorganisms Indigenous To Man, published by The Blakiston Division, McGraw-Hill Book Company, Inc., New York, 435 pp., 1962.
8. Marples, Mary J.: The Ecology of the Human Skin, published by Charles C. Thomas, Springfield, Illinois, 970 pp., 1965.
9. Huhtanen, C.N., M.R. Rogers, and L.S. Gall: "Improved Techniques for Isolating and Purifying Rumen Organisms," J. Bact., 64, 17-23, 1952.
10. Gall, L.S., and W.M. Helvey: "Culture of Anaerobic Fecal Flora in Men Under Simulated Space Conditions," Bacteriological Proceedings, 1963, Abstracts of the 63rd Annual Meeting, American Society for Microbiology, Cleveland, Ohio, May 5-9, 1963.
11. Breed, Robert S., E.G.D. Murray, and Nathan R. Smith (Editors): Bergey's Manual of Determinative Bacteriology, 7th Edition, Baltimore, The Williams & Wilkins Company, 1957.
12. NASA Defense Purchase Request R-85: "Aerospace Nutrition," Task No. 716405, Houston, Texas.

13. Shehadeh, N.H., and A.M. Kligman: "The Effect of Topical Anti-Bacterial Agents on the Bacterial Flora of the Axilla," J. Invest. Derm., 40, 61-71, 1963.
14. AF33(657)-11716, Miami Valley Hospital Research Department.
15. Pollack, M.R., S.D. Wainwright, and E.E.D. Manson: "The Presence of Oleic Acid Requiring Diphtheroids on the Human Skin," J. of Path. Bact., 61, 274-276, 1949.
16. Pillsbury, D.M. and A.M. Kligman: "Some Current Problems in Cutaneous Bacteriology," (Chapter 11) in Modern Trends in Dermatology, 2nd series, Butterworth, pp. 187-213, 1954.
17. Marples, M.J., and M.J. Bailey: "A Search for the Presence of Pathogenic Bacteria and Fungi in the Interdigital Spaces of the Foot," Brit. J. Derm., 69, 379-388, 1957.
18. Krassilnikov, N.A.: "Guide to the Identification of Bacteria and Actinomyces," Academy of Science, USSR, 1949.
19. NASw-738, "Study of Normal Fecal Bacterial Flora of Man," Office of Space Sciences, National Aeronautics and Space Administration, Washington, D.C., July 26, 1965.
20. Gall, L.S., P.E. Riely, and G. Albright: "Determination of Aerobic and Anaerobic Microflora of Human Feces," AMRL-TR-64-107 (AD 609 325), Aerospace Medical Research Laboratories, Wright-Patterson AFB, Ohio, October 1964.
21. NAS9-4172, "Effect of Diet and Atmosphere on Intestinal and Skin Flora," L. S. Gall, 1963.
22. AF33(615)-3255, "Research on Microbiological Flora of Human Subjects Undergoing Conditions of Simulated Environment," (in progress).
23. Burnett, George W. and Henry W. Scherp: Oral Microbiology and Infectious Disease, The Williams and Wilkins Company, Baltimore, Maryland, 1003 pp., 1962 (page 277).
24. Bell, George H., J. Norman Davidson, and Harold Scarborough: Textbook of Physiology and Biochemistry, The Williams and Wilkins Company, Baltimore, Maryland, 1117 pp., 1961 (page 280).
25. Morris, J.G.: "The Synthesis of Vitamins and Coenzymes," (Chapter 5, (pp. 253-294) in The Bacteria, edited by I.C. Gunsalus and Roger Y. Stanier, Volume III: Biosynthesis, published by Academic Press, New York and London, 1962.
26. Phear, E.A. and B. Ruebner: "In vitro Production of Ammonium and Amines by Intestinal Bacteria in Relation to Nitrogen Toxicity as Factor in Hepatic Coma," Brit. J. Exper. Path., 37, 253-262, 1956.

Contrails

27. Levenson, S.M., L.V. Crowley, R.E. Horowitz, and O.J. Malm: "Metabolism of Carbon-Labeled Urea in Germfree Rat," J. Biol. Chem., 234, 2061, 1959.
28. Silen, W., H.A. Harper, D.L. Mausley, and W.L. Weirich, "Effect of Antibacterial Agents on Ammonia Production Within the Intestine," Proc. Soc. Exp. Bio. and Med., 88, 138, 1955.

Contrails

Security Classification

DOCUMENT CONTROL DATA - R&D		
(Security classification of title, body of abstract and indexing annotation must be entered when the overall report is classified)		
1. ORIGINATING ACTIVITY (Corporate author) Republic Aviation Division, Fairchild Hiller Corp, Farmingdale, Long Island, N. Y. 11735	2a. REPORT SECURITY CLASSIFICATION <p style="text-align: center; font-size: large;">UNCLASSIFIED</p>	
	2b. GROUP <p style="text-align: center; font-size: large;">N/A</p>	
3. REPORT TITLE <p style="font-size: large;">DETERMINATION OF THE INDIGENOUS MICROFLORA OF MEN IN CONTROLLED ENVIRONMENTS</p>		
4. DESCRIPTIVE NOTES (Type of report and inclusive dates) <p style="font-size: large;">Final report, July 1964 - November 1965</p>		
5. AUTHOR(S) (Last name, first name, initial) Riely, Phyllis E. Gelb, Donna Shorestein, Diane		
6. REPORT DATE <p style="text-align: center; font-size: large;">April 1966</p>	7a. TOTAL NO. OF PAGES <p style="text-align: center; font-size: large;">385</p>	7b. NO. OF REFS. <p style="text-align: center; font-size: large;">28</p>
8a. CONTRACT OR GRANT NO. AF 33(615)-1814 b. PROJECT NO. 7164 c. Task No. 716405 d.	9a. ORIGINATOR'S REPORT NUMBER(S) 9b. OTHER REPORT NO(S) (Any other numbers that may be assigned this report) <p style="text-align: center; font-size: large;">AMRL-TR-66-33</p>	
10. AVAILABILITY/LIMITATION NOTICES <p style="font-size: large;">Distribution of this document is unlimited.</p>		
11. SUPPLEMENTARY NOTES	12. SPONSORING MILITARY ACTIVITY Aerospace Medical Research Laboratories, Aerospace Medical Div., Air Force Systems Command, Wright-Patterson AFB, Ohio	
13. ABSTRACT <p>The objective of this study was to collect, under controlled conditions simulating space travel, microbiological data from 13 body areas of 20 subjects and their specialized environment. These data were evaluated to establish biomedical criteria for personal hygiene and sanitation for aerospace missions, and to suggest possible indices of the deterioration of environmental conditions. Data derived in the study provided information on microbial dynamics, the effects of confinement stress on the microbiological populations of individuals, and information on bacterial levels in the closed environment. The study strengthened the evidence that, in general, man can go without bathing for 6 weeks without significant deterioration of the dermis. It pointed out the importance of sampling the groin and glans penis as "indicator" areas which quickly signal deterioration in hygienic standards. The specific buildup of both corynebacteria and micrococaceae species in almost all sampled body sites was significant. Another objective of this program was to study the effects of the various space-type diets on the fecal flora of the subjects. The data revealed that although the obligately anaerobic character of the feces remained unchanged, the types of anaerobes recovered differed markedly from those found to be predominant in the "normal" population. The shift in the types of anaerobic bacteria is discussed from the viewpoints of vitamin produc-</p>		

DD FORM 1 JAN 64 1473 tion, lactic acid production, and deaminating and decarboxylating activities.

Security Classification

Security Classification

14.	KEY WORDS	LINK A		LINK B		LINK C	
		ROLE	WT	ROLE	WT	ROLE	WT
	Microbiological flora Dermic deterioration Bacterial levels Microbial dynamics Personal hygiene Sanitation Aerospace missions						

INSTRUCTIONS

1. **ORIGINATING ACTIVITY:** Enter the name and address of the contractor, subcontractor, grantee, Department of Defense activity or other organization (*corporate author*) issuing the report.
- 2a. **REPORT SECURITY CLASSIFICATION:** Enter the overall security classification of the report. Indicate whether "Restricted Data" is included. Marking is to be in accordance with appropriate security regulations.
- 2b. **GROUP:** Automatic downgrading is specified in DoD Directive 5200.10 and Armed Forces Industrial Manual. Enter the group number. Also, when applicable, show that optional markings have been used for Group 3 and Group 4 as authorized.
3. **REPORT TITLE:** Enter the complete report title in all capital letters. Titles in all cases should be unclassified. If a meaningful title cannot be selected without classification, show title classification in all capitals in parenthesis immediately following the title.
4. **DESCRIPTIVE NOTES:** If appropriate, enter the type of report, e.g., interim, progress, summary, annual, or final. Give the inclusive dates when a specific reporting period is covered.
5. **AUTHOR(S):** Enter the name(s) of author(s) as shown on or in the report. Enter last name, first name, middle initial. If military, show rank and branch of service. The name of the principal author is an absolute minimum requirement.
6. **REPORT DATE:** Enter the date of the report as day, month, year, or month, year. If more than one date appears on the report, use date of publication.
- 7a. **TOTAL NUMBER OF PAGES:** The total page count should follow normal pagination procedures, i.e., enter the number of pages containing information.
- 7b. **NUMBER OF REFERENCES:** Enter the total number of references cited in the report.
- 8a. **CONTRACT OR GRANT NUMBER:** If appropriate, enter the applicable number of the contract or grant under which the report was written.
- 8b, 8c, & 8d. **PROJECT NUMBER:** Enter the appropriate military department identification, such as project number, subproject number, system numbers, task number, etc.
- 9a. **ORIGINATOR'S REPORT NUMBER(S):** Enter the official report number by which the document will be identified and controlled by the originating activity. This number must be unique to this report.
- 9b. **OTHER REPORT NUMBER(S):** If the report has been assigned any other report numbers (*either by the originator or by the sponsor*), also enter this number(s).
10. **AVAILABILITY/LIMITATION NOTICES:** Enter any limitations on further dissemination of the report, other than those

imposed by security classification, using standard statements such as:

- (1) "Qualified requesters may obtain copies of this report from DDC."
- (2) "Foreign announcement and dissemination of this report by DDC is not authorized."
- (3) "U. S. Government agencies may obtain copies of this report directly from DDC. Other qualified DDC users shall request through _____."
- (4) "U. S. military agencies may obtain copies of this report directly from DDC. Other qualified users shall request through _____."
- (5) "All distribution of this report is controlled. Qualified DDC users shall request through _____."

If the report has been furnished to the Office of Technical Services, Department of Commerce, for sale to the public, indicate this fact and enter the price, if known.

11. **SUPPLEMENTARY NOTES:** Use for additional explanatory notes.

12. **SPONSORING MILITARY ACTIVITY:** Enter the name of the departmental project office or laboratory sponsoring (*paying for*) the research and development. Include address.

13. **ABSTRACT:** Enter an abstract giving a brief and factual summary of the document indicative of the report, even though it may also appear elsewhere in the body of the technical report. If additional space is required, a continuation sheet shall be attached.

It is highly desirable that the abstract of classified reports be unclassified. Each paragraph of the abstract shall end with an indication of the military security classification of the information in the paragraph, represented as (TS), (S), (C), or (U).

There is no limitation on the length of the abstract. However, the suggested length is from 150 to 225 words.

14. **KEY WORDS:** Key words are technically meaningful terms or short phrases that characterize a report and may be used as index entries for cataloging the report. Key words must be selected so that no security classification is required. Identifiers, such as equipment model designation, trade name, military project code name, geographic location, may be used as key words but will be followed by an indication of technical context. The assignment of links, rules, and weights is optional.